

COMUNE DI MASSA
Provincia di Massa Carrara



STUDIO DELLA PERICOLOSITÀ IDRAULICA
NEL COMUNE DI MASSA

ELABORATO:

A.03

OGGETTO:

SEZIONI FLUVIALI E
LIVELLI IDROMETRICI

SCALA

-



Via Bonifacio Lupi, 1
50129 - FIRENZE
Tel. 055 484206 / 055 491896
Fax. 055 4626342
Email. segreteria.firenze@physis.net
Pec. segreteria.physis@pec.it

PROGETTISTA:

Dott. Ing. David Settesoldi

COLLABORATORI TECNICI:

Ing. Michele Catella
Ing. Martina Alderighi
Geol. Silvia Angelini
Geom. Daniele Natali

COMMITTENTE:

COMUNE DI MASSA
Via Cavour, 23
54100 - Massa (MS)

REV.	DESCRIZIONE	DATA	REDATTO	VERIFICATO	APPROVATO
02					
01	SECONDA EMISSIONE	21/11/2014	Ing. Martina Alderighi	Ing. Michele Catella	Ing. David Settesoldi
00	PRIMA EMISSIONE	30/04/2014	Ing. Martina Alderighi	Ing. Michele Catella	Ing. David Settesoldi

REVISIONE	DATA
01	21/11/2014

UNI EN ISO 9001:2008
Sistema di Gestione per la Qualità
Certificato N. SQ 12739



INDICE

Sezioni fluviali fosso Lavello	3
Sezioni fluviali torrente Ricortola – RI_01.....	25
Sezioni fluviali torrente Ricortola – RI_02.....	62
Sezioni fluviali torrente Ricortola – RI_03.....	80
Sezioni fluviali fosso Pernice – Pernice_01	149
Sezioni fluviali fosso Pernice – Pernice_02	155
Sezioni fluviali fosso San Lorenzo	174
Sezioni fluviali fosso Castagnara.....	190
Sezioni fluviali fosso Brugiano – BR_a_P	233
Sezioni fluviali fosso Brugiano – BR_b_P	244
Sezioni fluviali fosso Brugiano – BR_c_P	248
Sezioni fluviali fosso Brugiano – BR_d_P	253
Sezioni fluviali fosso Becaro	263
Sezioni fluviali fosso Connettore – C1_P	274
Sezioni fluviali fosso Connettore – C2_P	279
Sezioni fluviali fosso Dalmine	285
Sezioni fluviali fosso Nuovo – FN_1_a	311
Sezioni fluviali fosso Nuovo – FN_1_b	316
Sezioni fluviali fosso Nuovo – FN_1_c.....	320
Sezioni fluviali fosso Nuovo – FN_2	327
Sezioni fluviali fosso Nuovo – FN_3	331
Sezioni fluviali Fosso Lodolina.....	336
Sezioni fluviali fosso di Mezzo – ME_a_P.....	345
Sezioni fluviali fosso di Mezzo – ME_b_P	352
Sezioni fluviali fosso di Mezzo – ME_c_P.....	371
Sezioni fluviali fosso Silcia – SI_a_P.....	378
Sezioni fluviali fosso Silcia – SI_b_P.....	401
Sezioni fluviali fosso Silcia – SI_c_P.....	405
Sezioni fluviali fosso Tornabuoni	414
Sezioni fluviali fiume Frigido – FR_01	422
Sezioni fluviali fiume Frigido – FR_02.....	425
Sezioni fluviali fiume Frigido – FR_03.....	432
Sezioni fluviali fiume Frigido – FR_04.....	440
Sezioni fluviali fiume Frigido – FR_05.....	457
Sezioni fluviali Fossa Grande	501
Sezioni fluviali fosso Bocchetta – Bocchetta_a.....	557
Sezioni fluviali fosso Bocchetta – Bocchetta_b.....	564
Sezioni fluviali fosso Bocchetta – Bocchetta_c.....	568
Sezioni fluviali fosso Castellazzo.....	624
Sezioni fluviali fosso Ruotino	682
Sezioni fluviali fosso Magliano – MG_2.....	713
Sezioni fluviali fosso Magliano – MG_3.....	725
Sezioni fluviali fosso Magliano – MG_4.....	735
Sezioni fluviali fosso Magliano – MG_5.....	744
Sezioni fluviali canale delle Grondini – Grondini_01	751
Sezioni fluviali canale delle Grondini – Grondini_02	765

Sezioni fluviali canale delle Grondini – Grondini_03	795
Sezioni fluviali fosso Colletto	845
Sezioni fluviali fosso Ronco	880
Sezioni fluviali fosso Loghi.....	909
Sezioni fluviali fosso Riva dei Ronchi	926
Sezioni fluviali fosso San Remigio.....	941
Sezioni fluviali fosso Poveromo	966
Sezioni fluviali torrente Canalmagro – Canalmagro_01	1001
Sezioni fluviali torrente Canalmagro – Canalmagro_02	1027
Sezioni fluviali canale degli Sforza	1117
Sezioni fluviali fosso del Sale.....	1126

STATO ATTUALE
Sezioni fluviali fosso Lavello

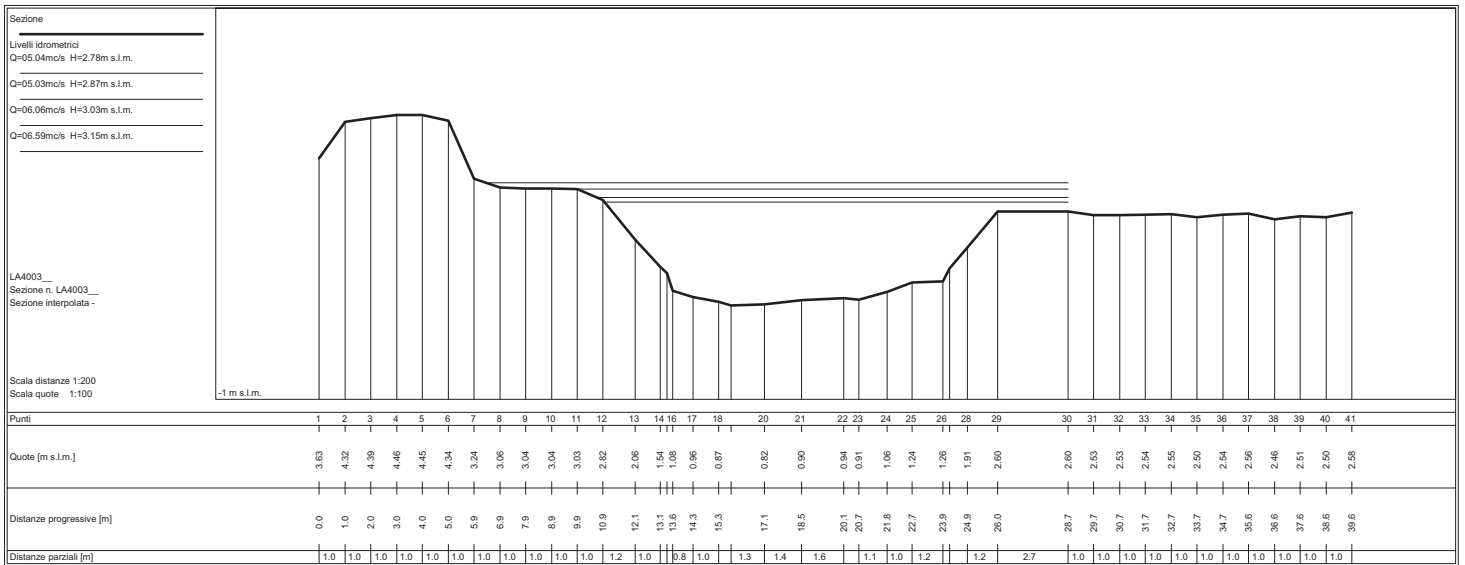
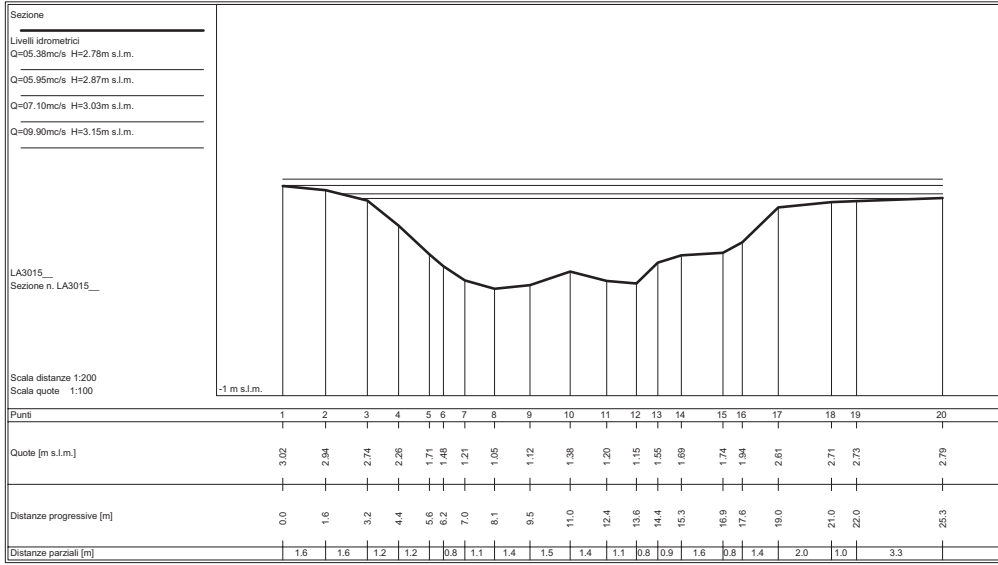

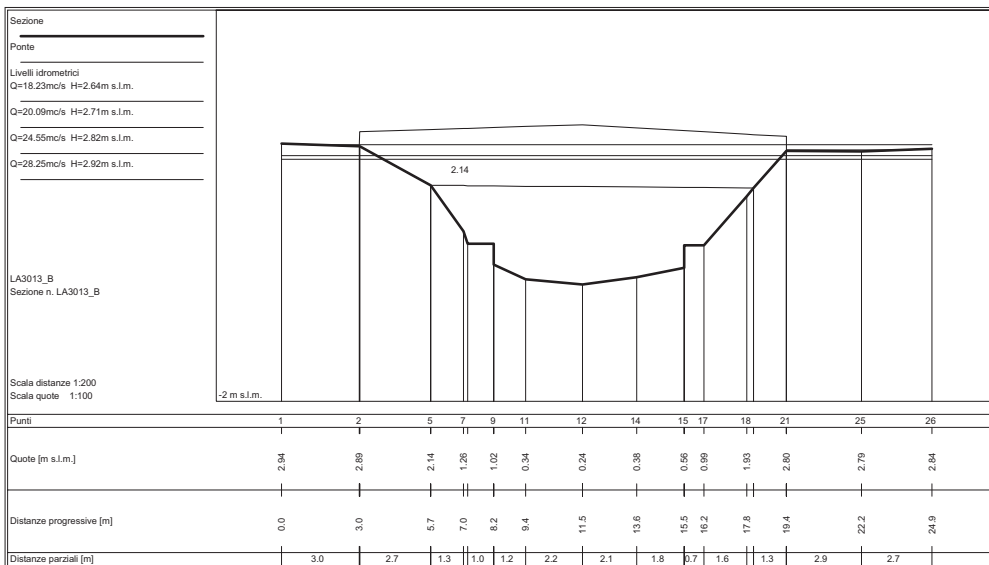
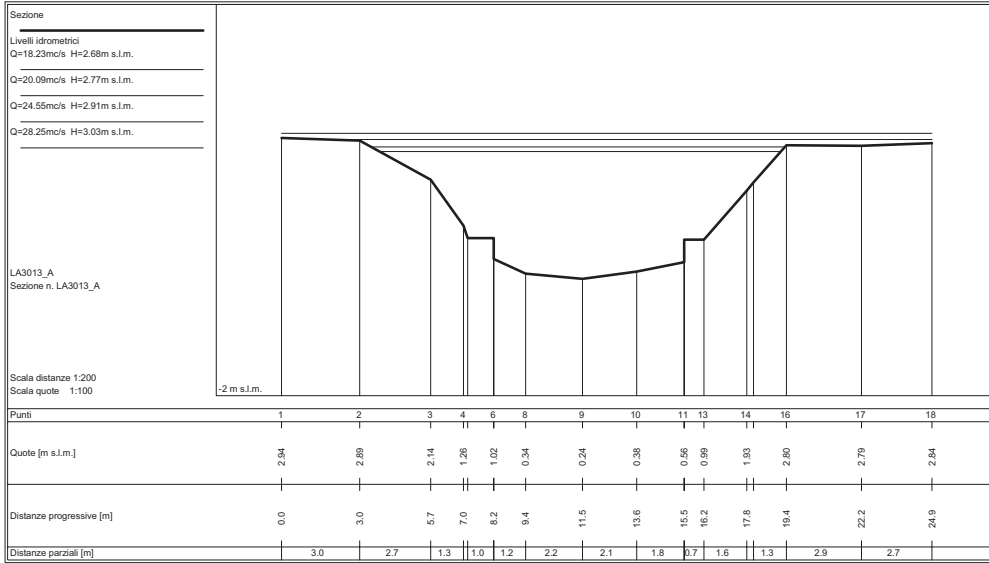

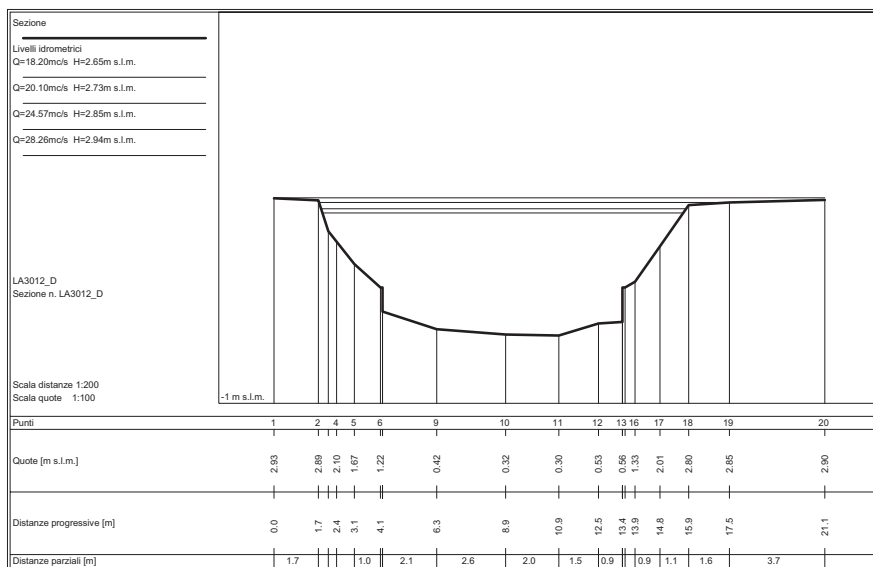
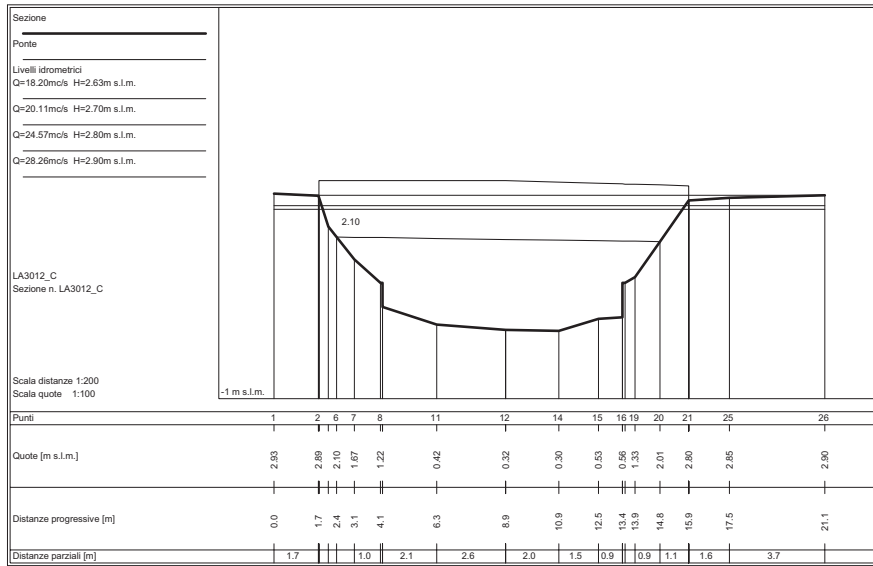

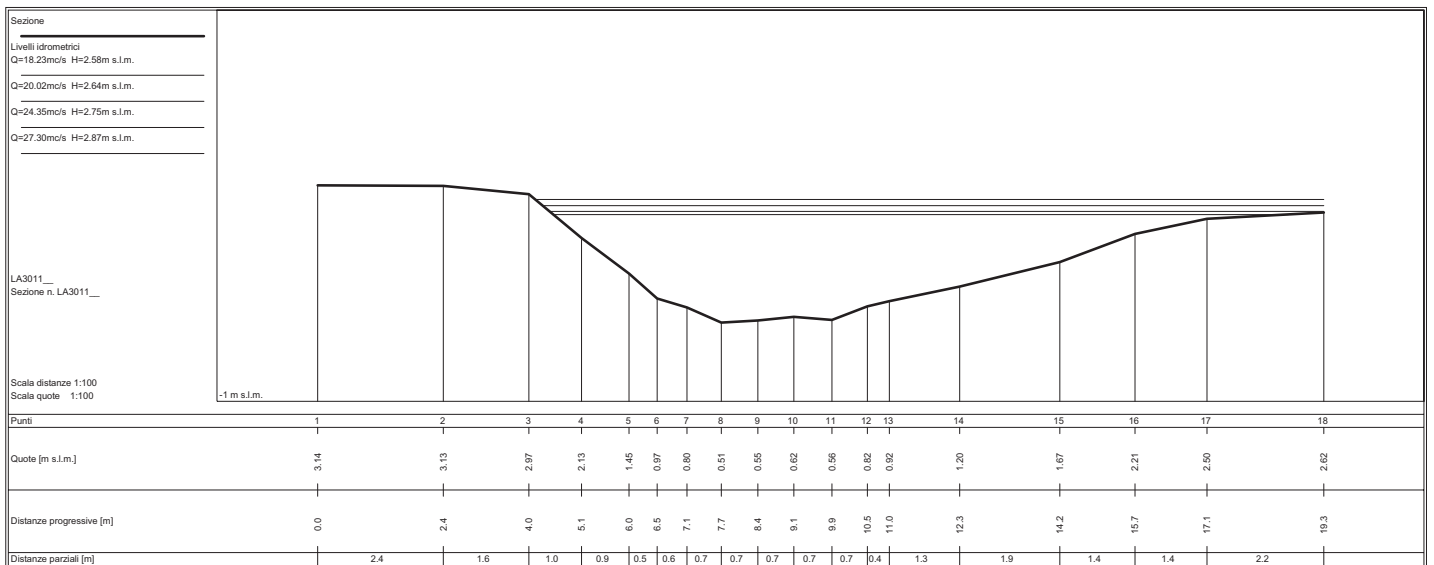
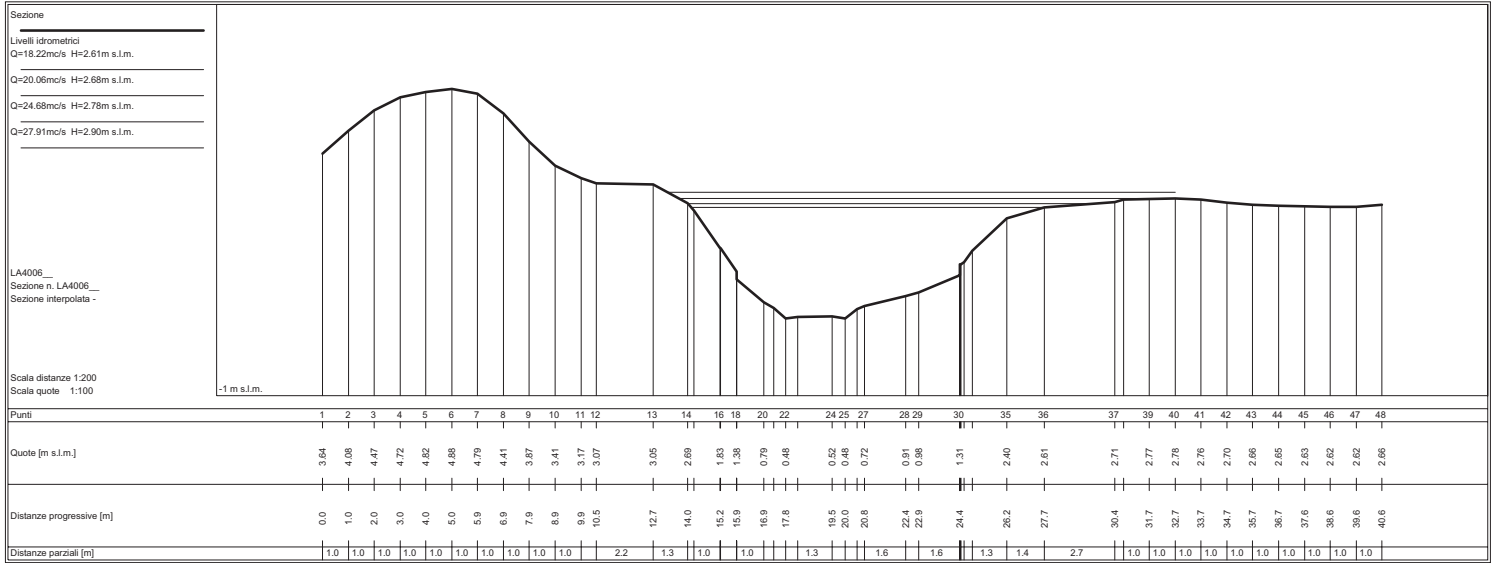

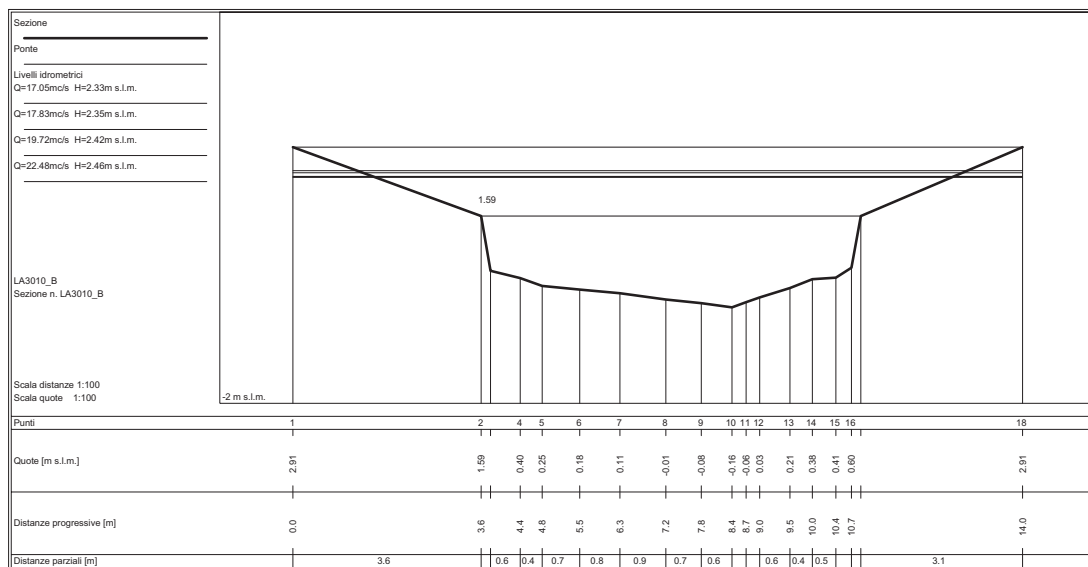
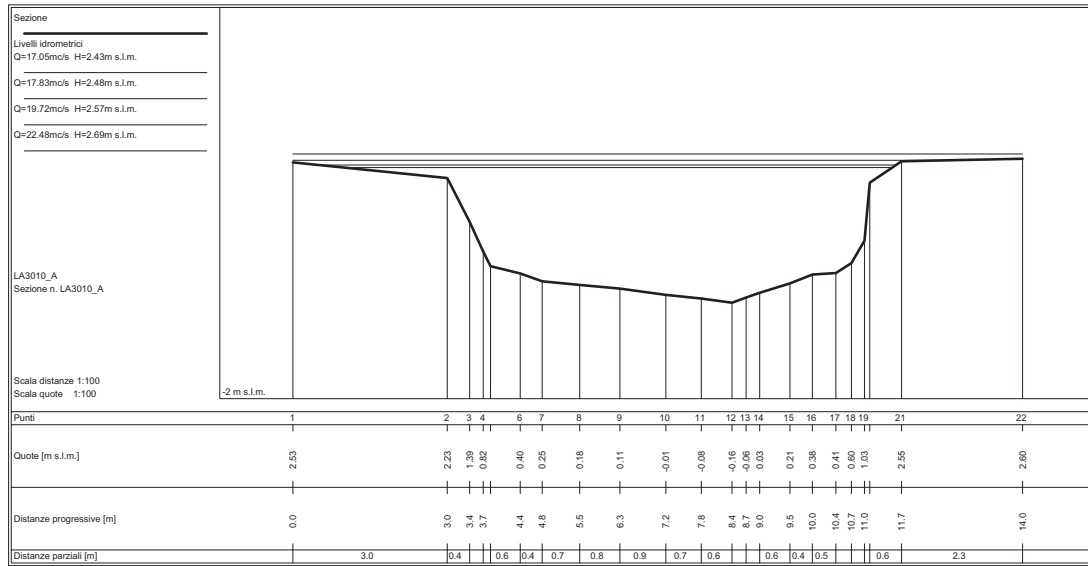

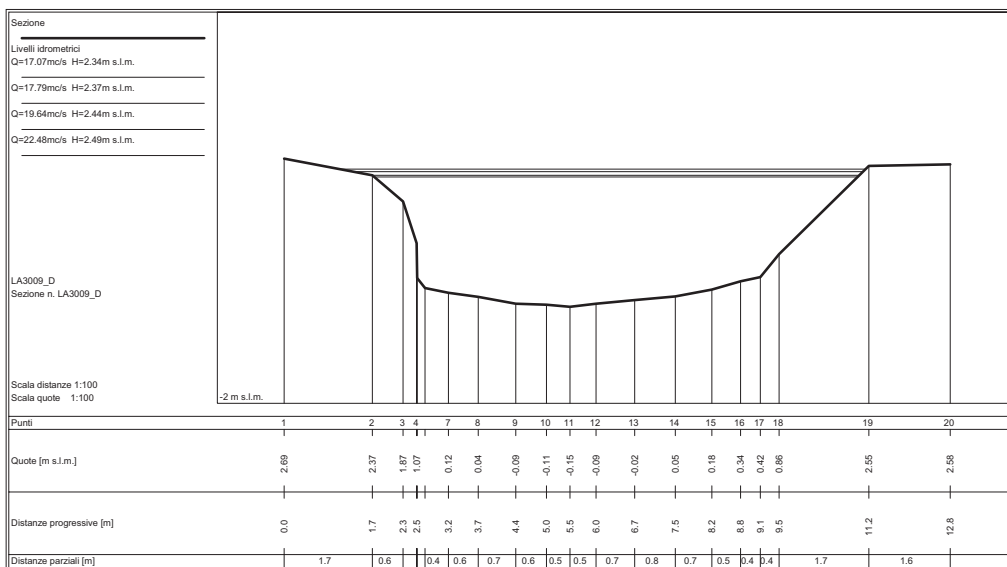
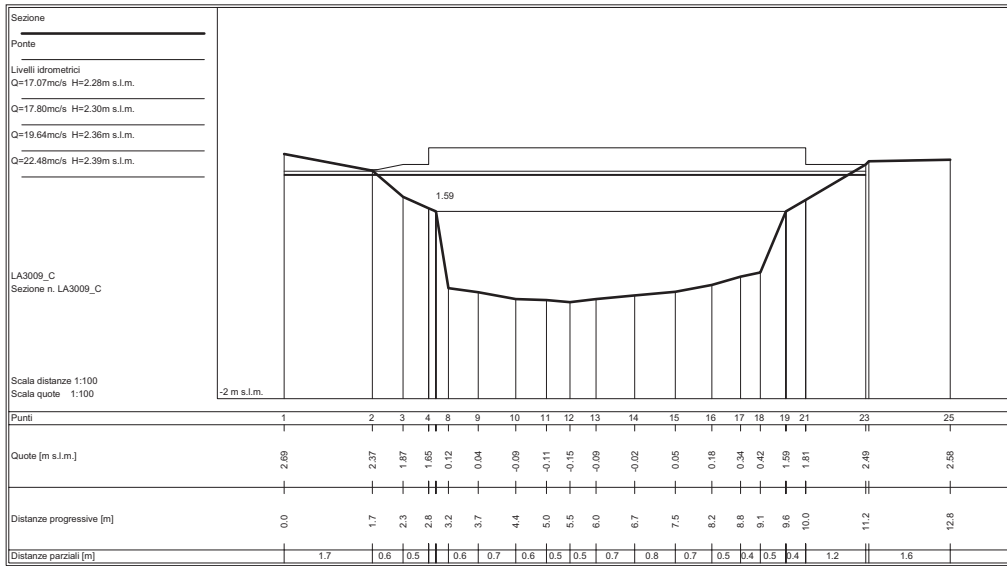

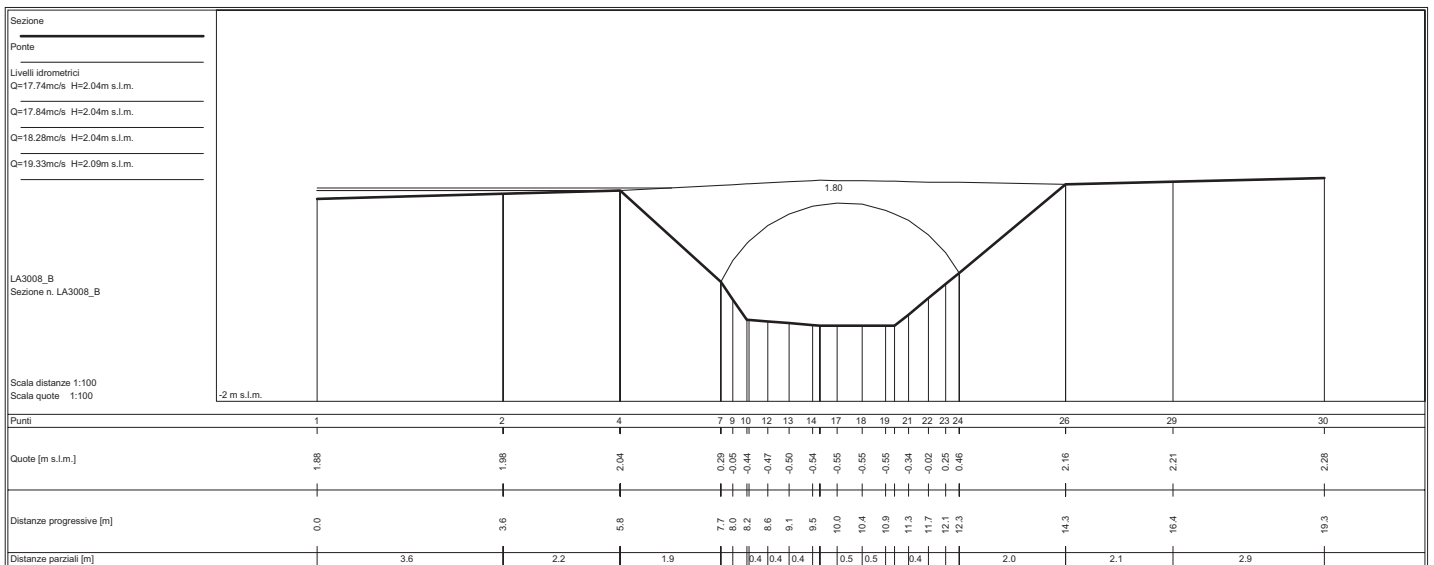
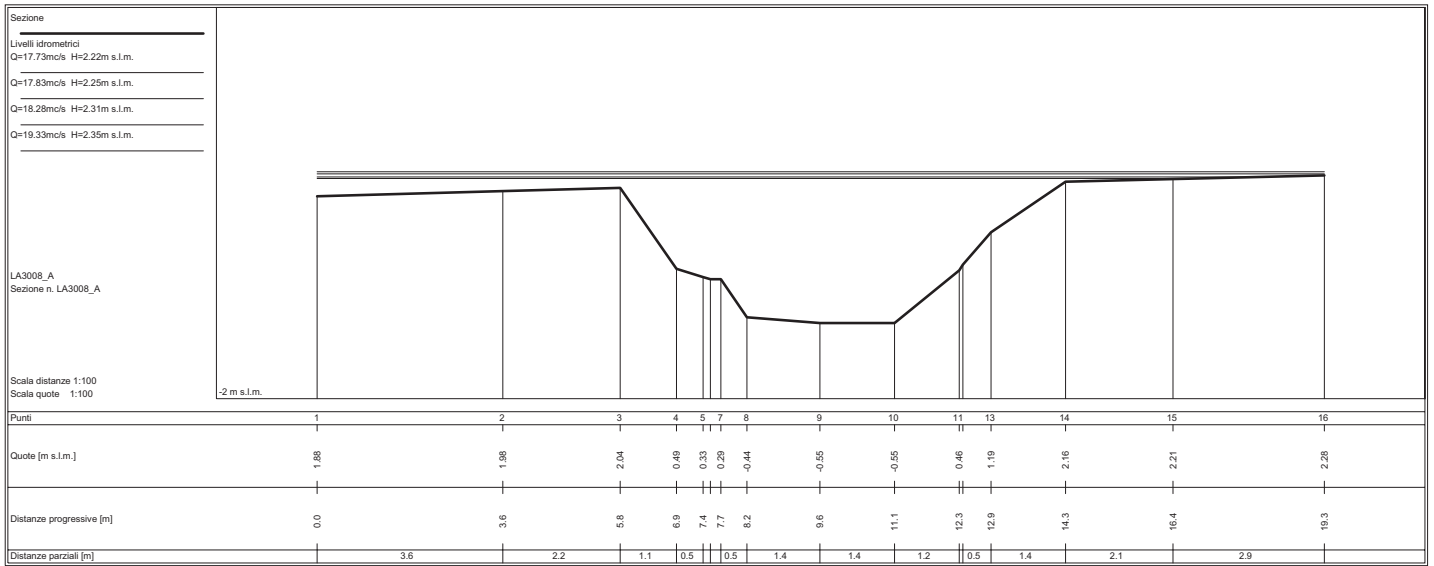

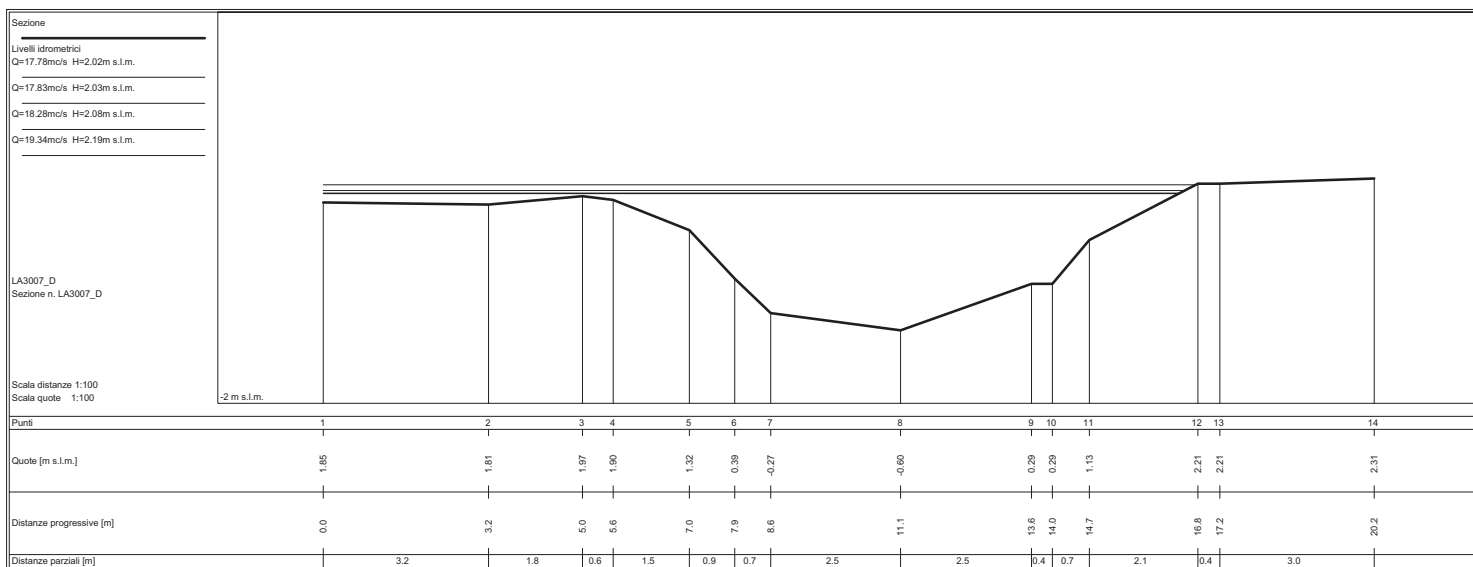
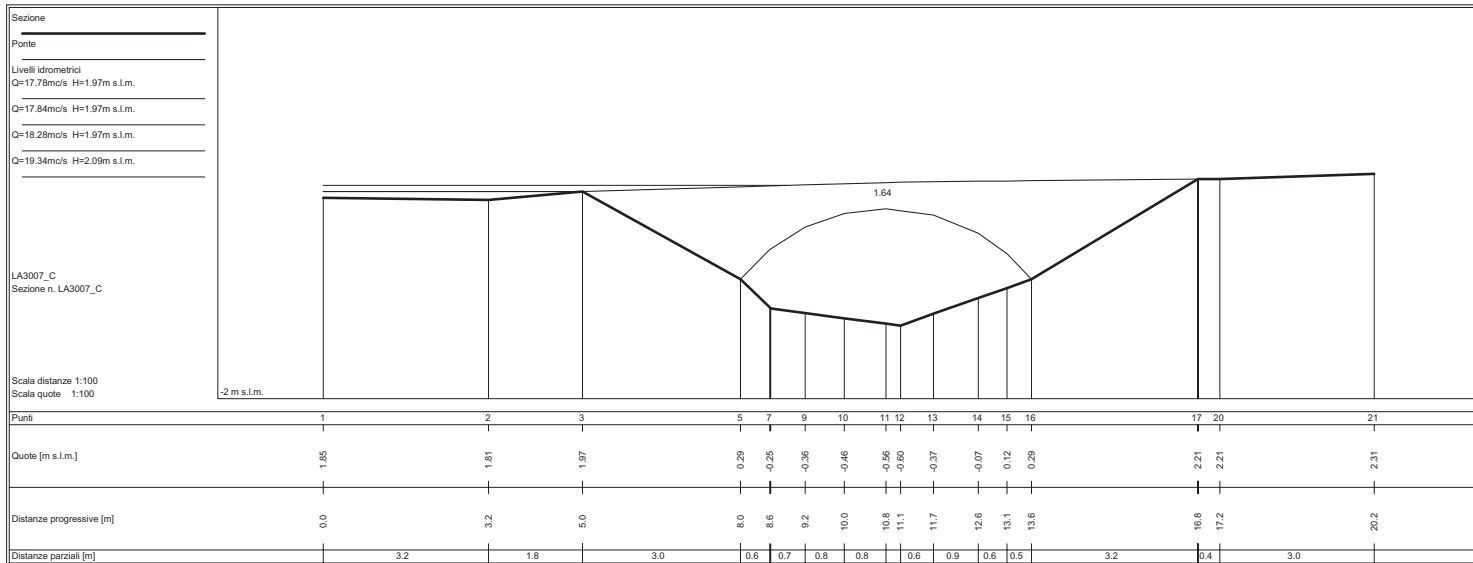

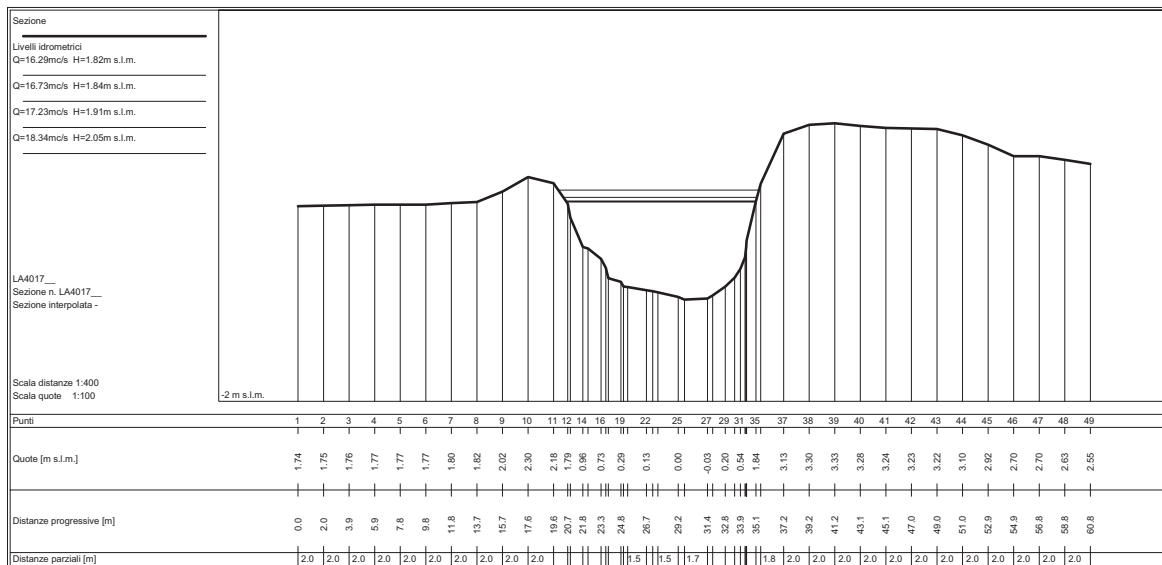
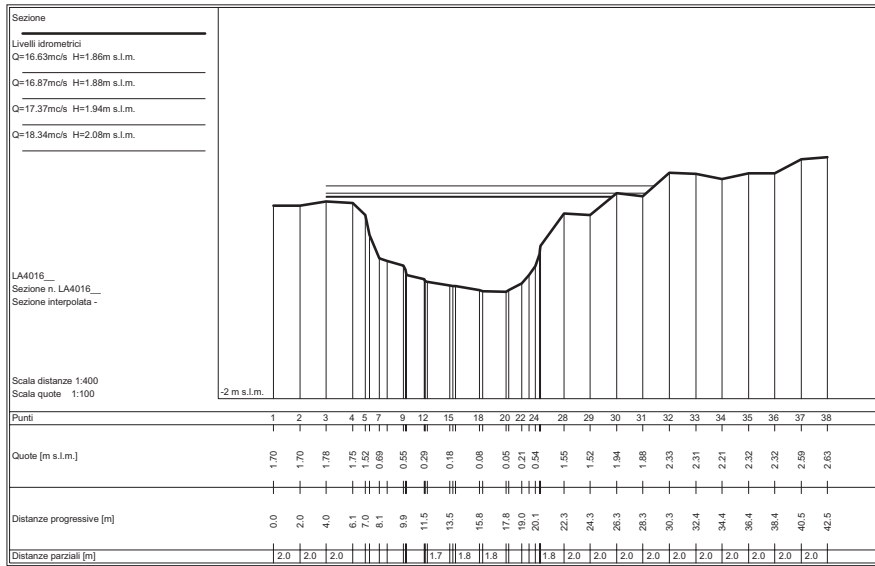

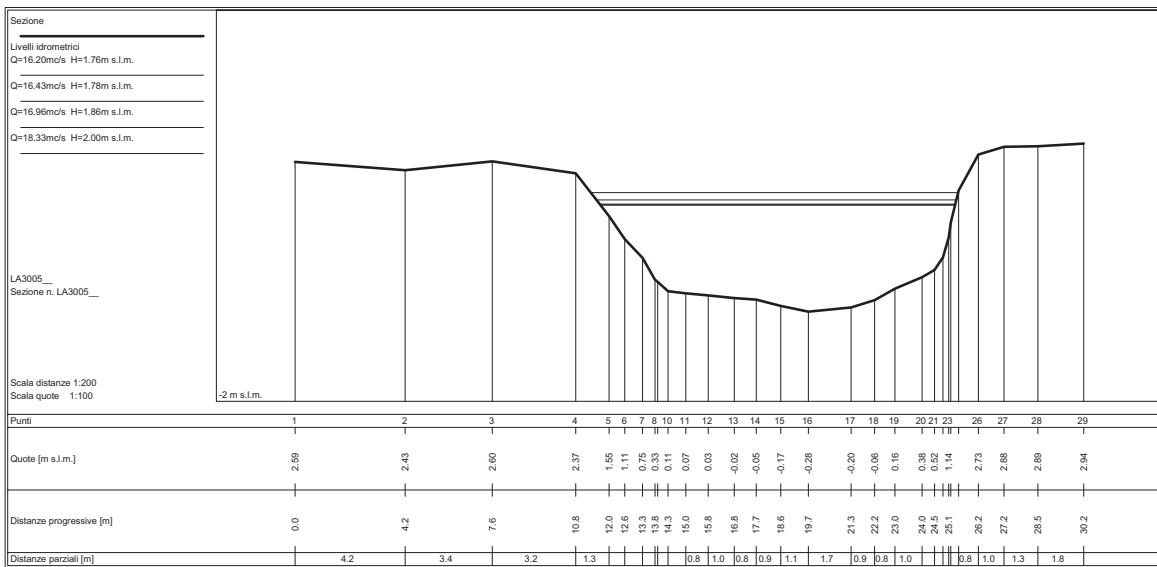
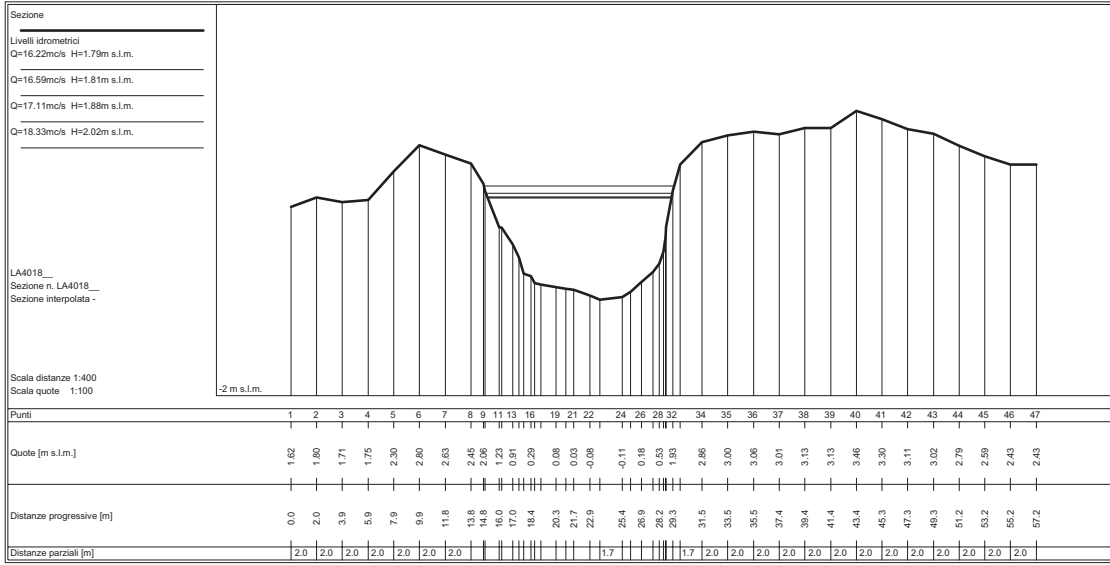

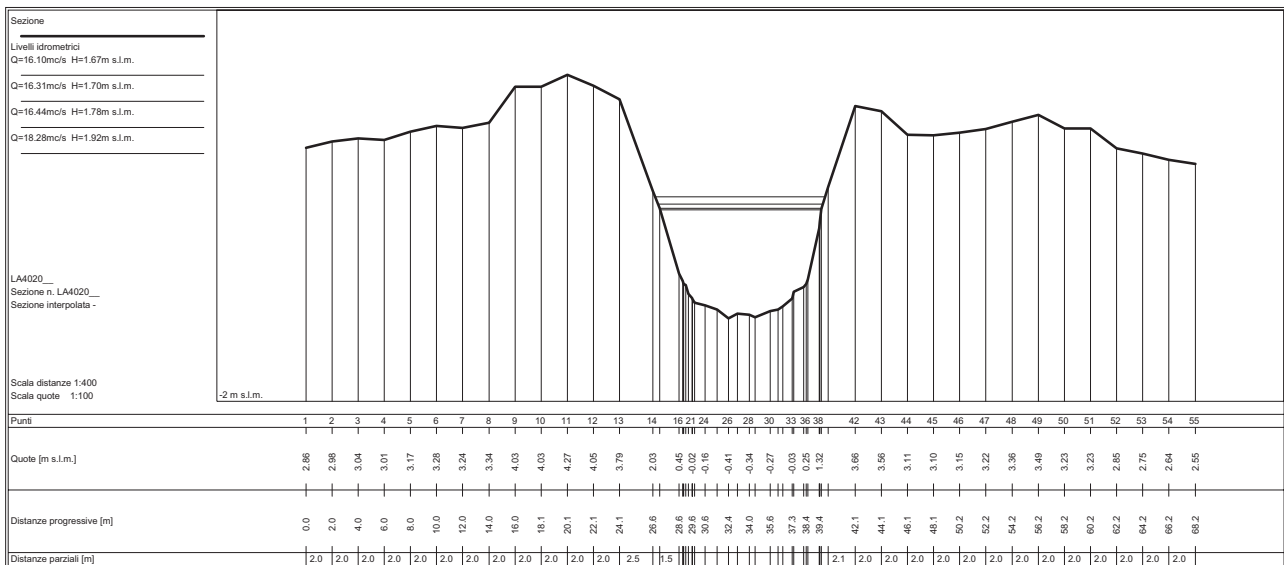
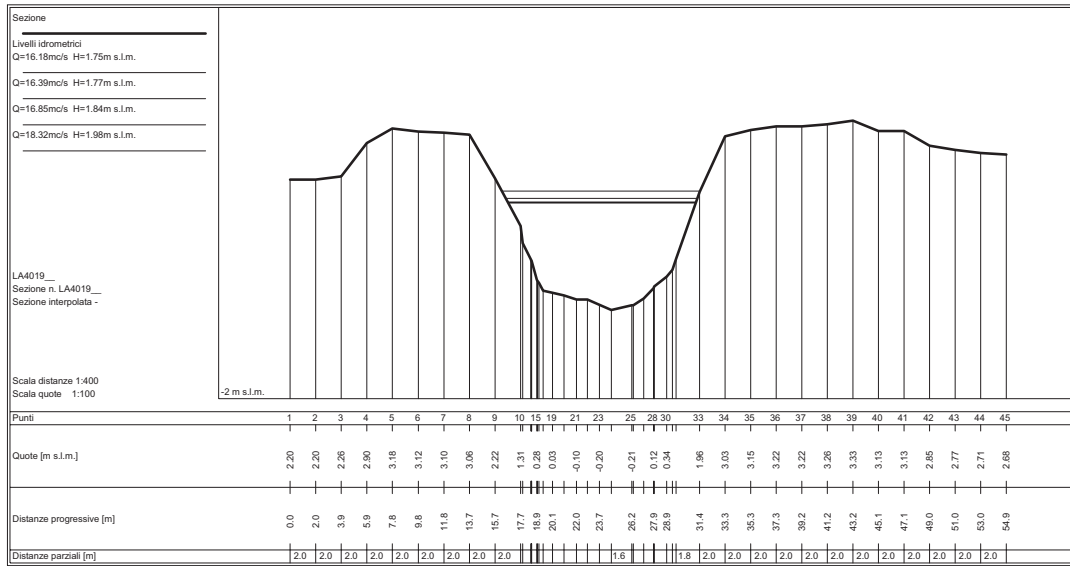

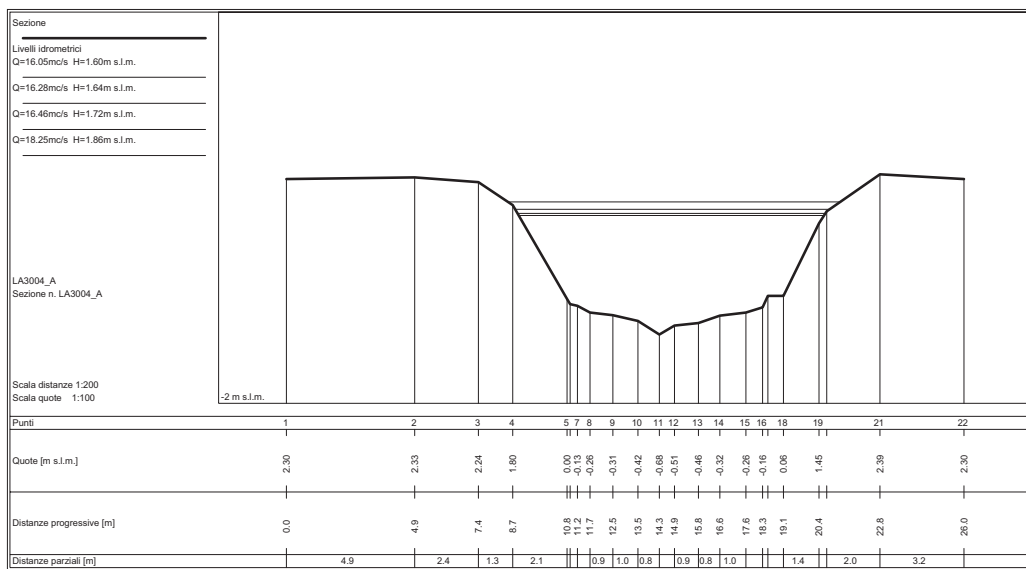
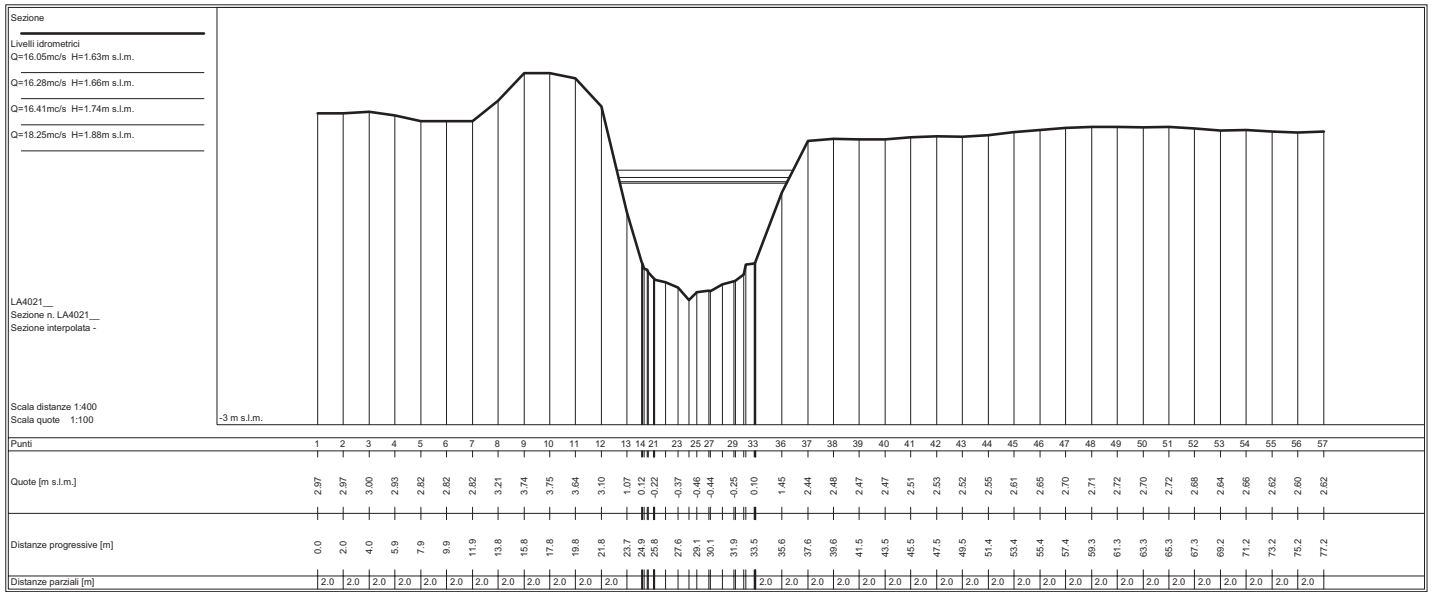

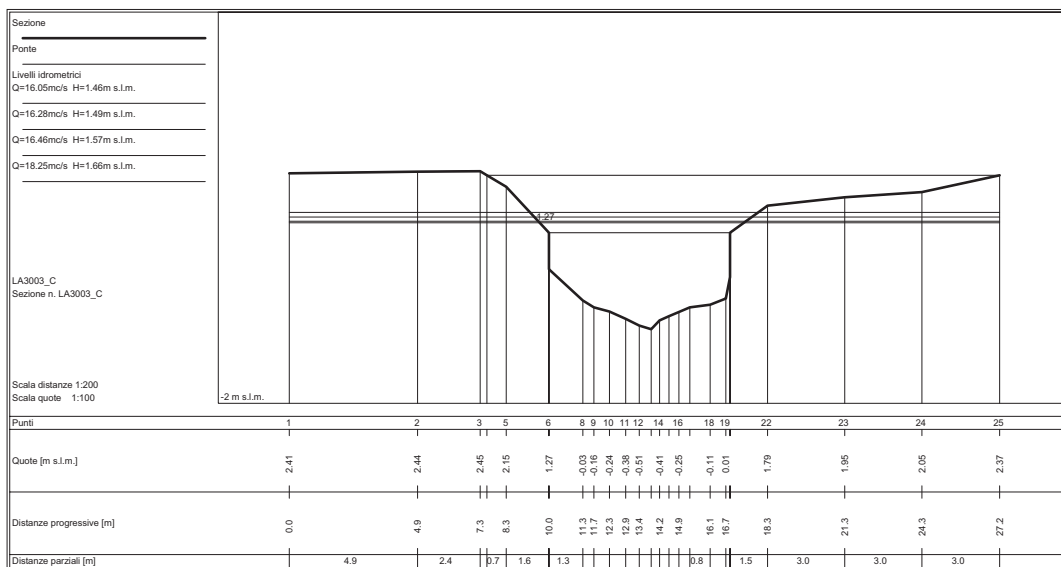
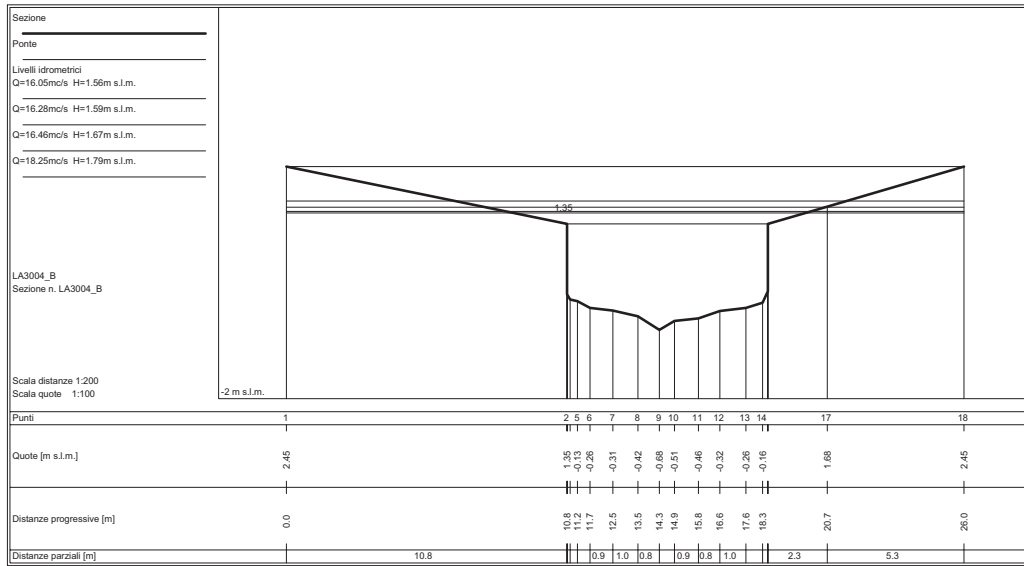

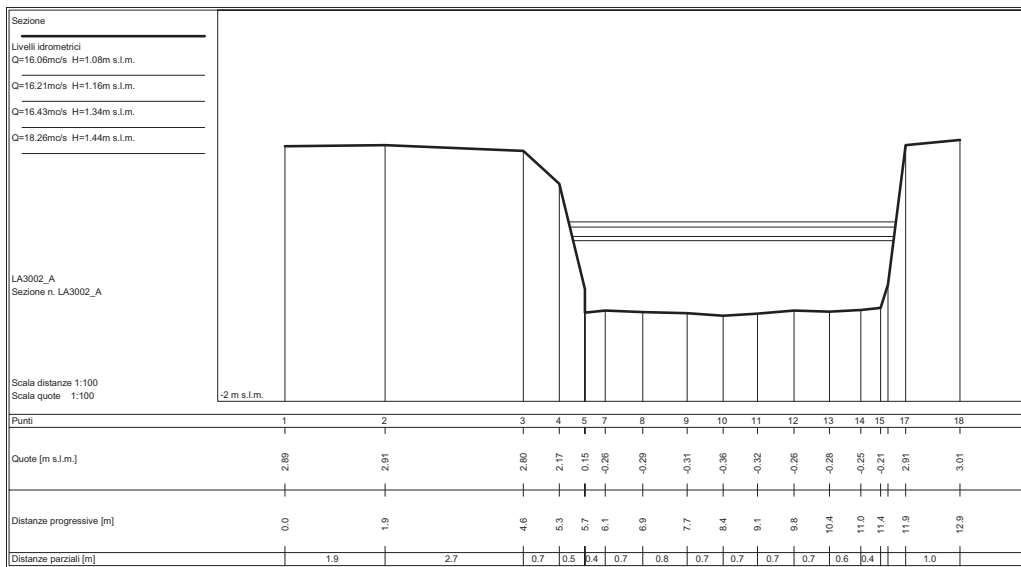
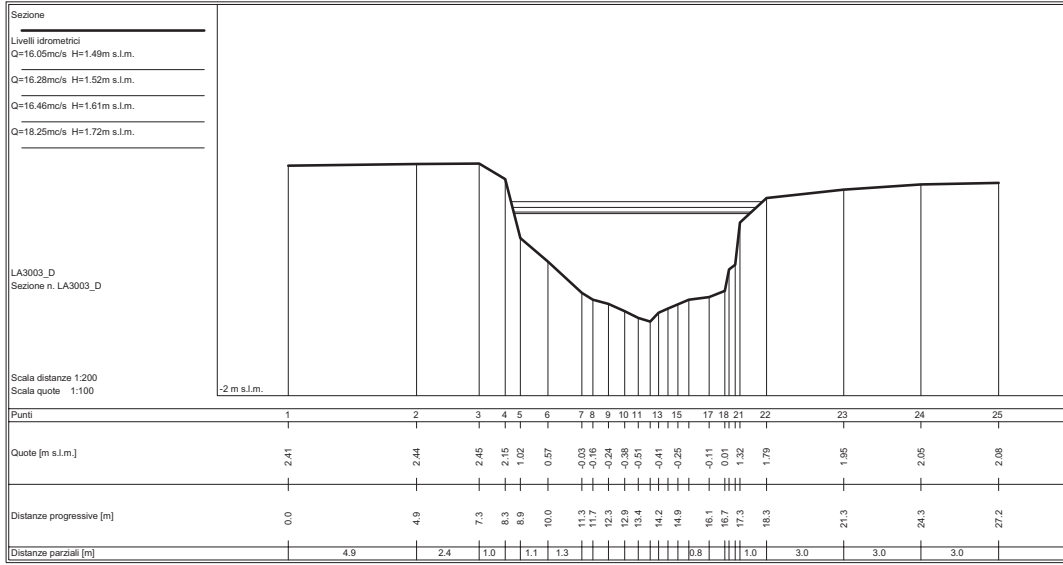

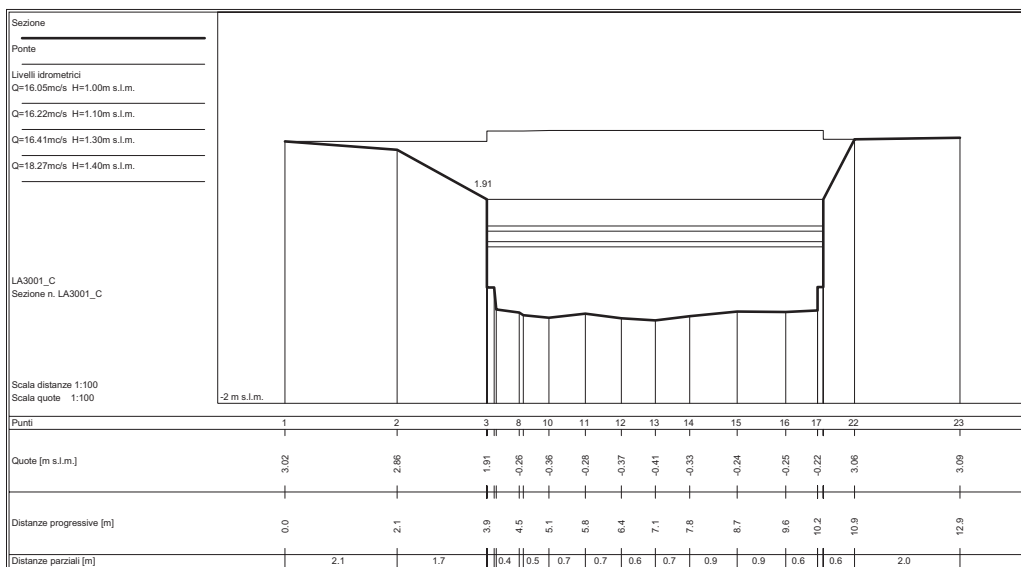
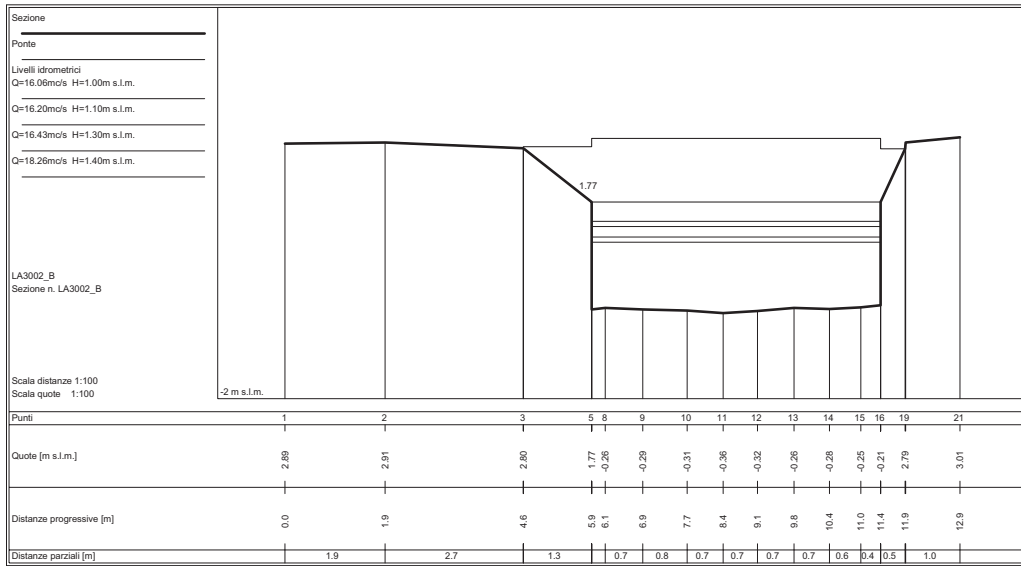

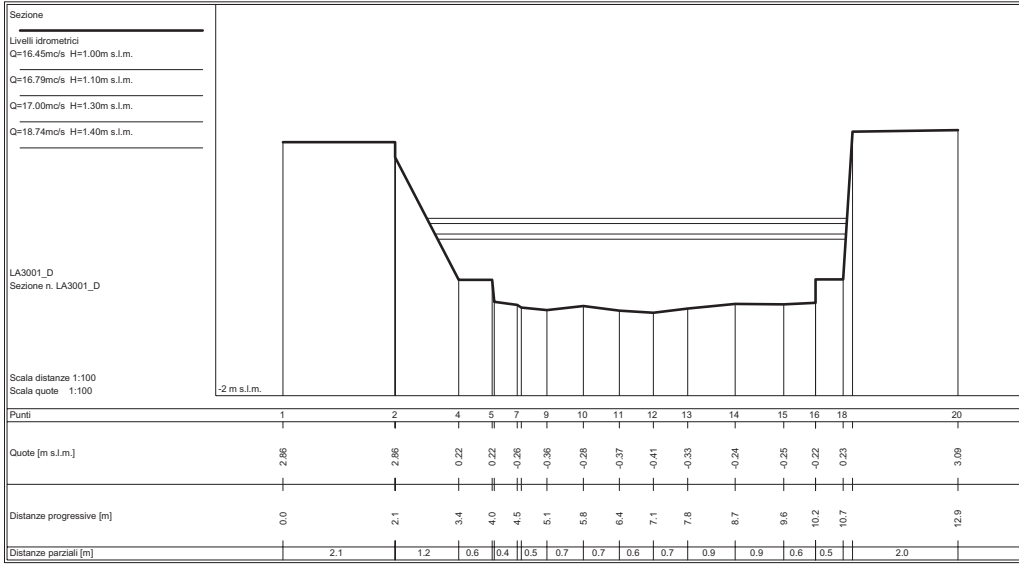

STATO ATTUALE

Sezioni fluviali torrente Ricortola – RI_01

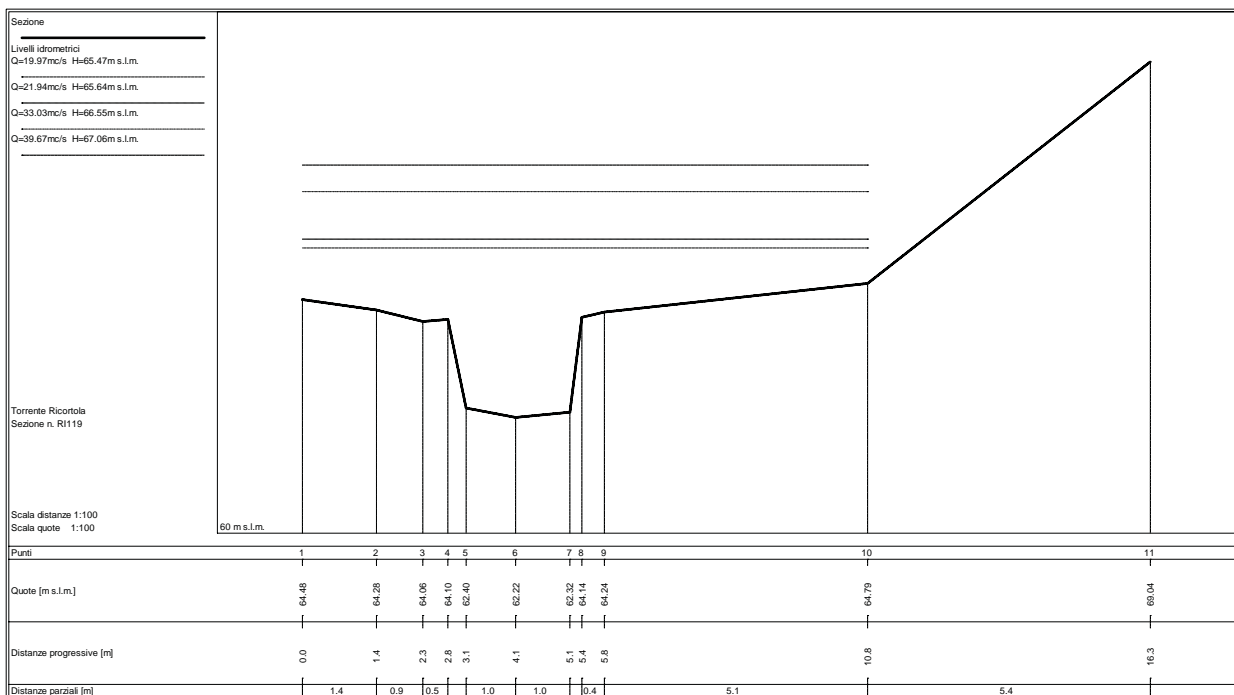
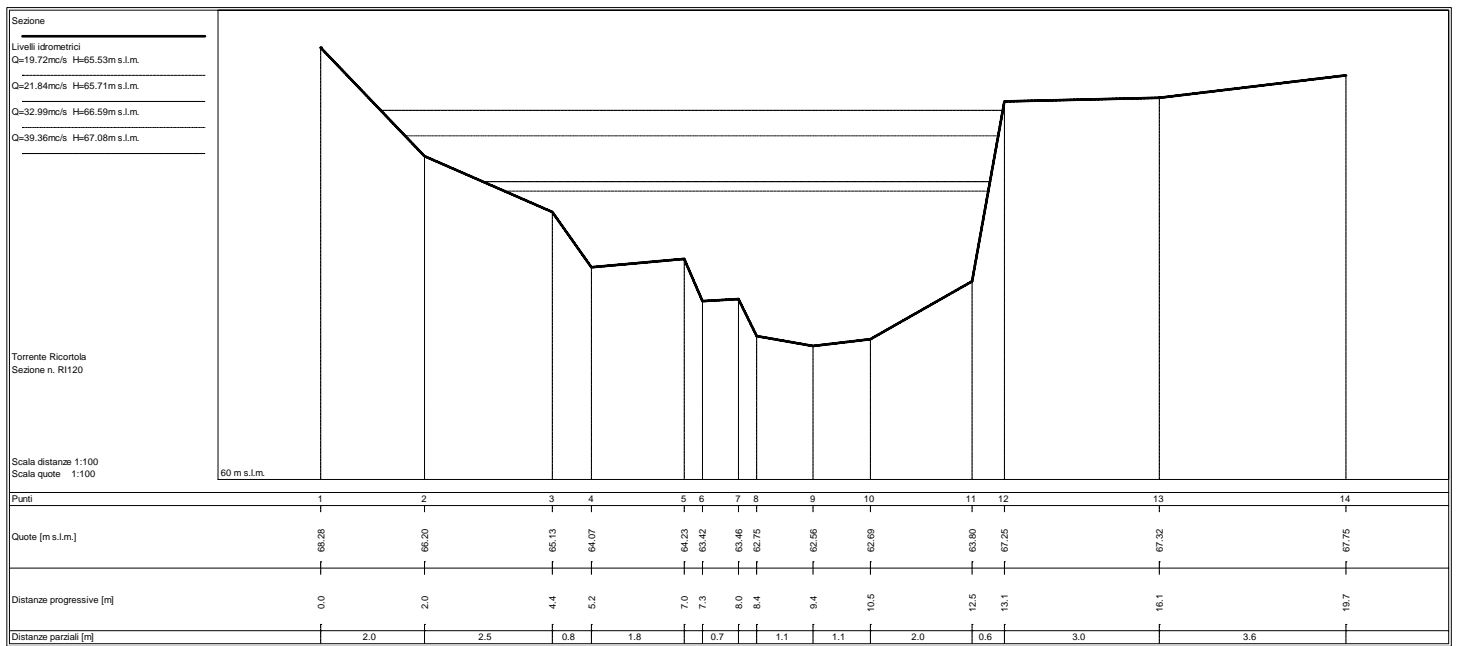

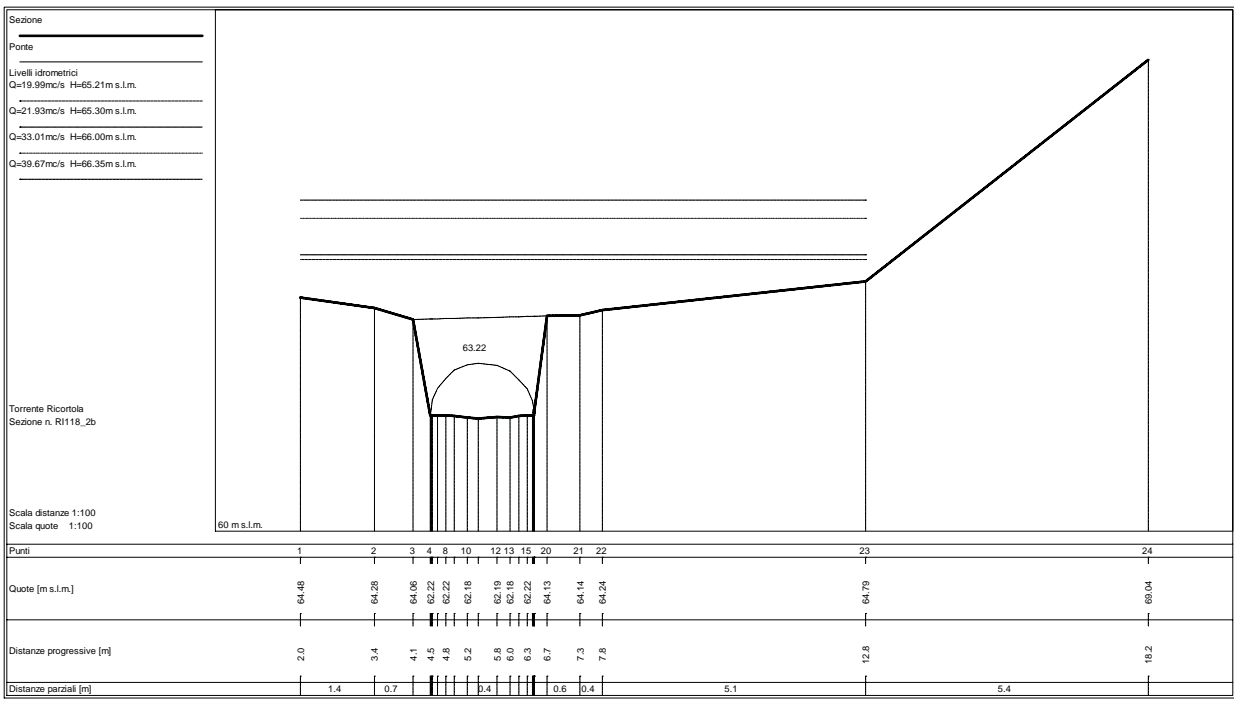
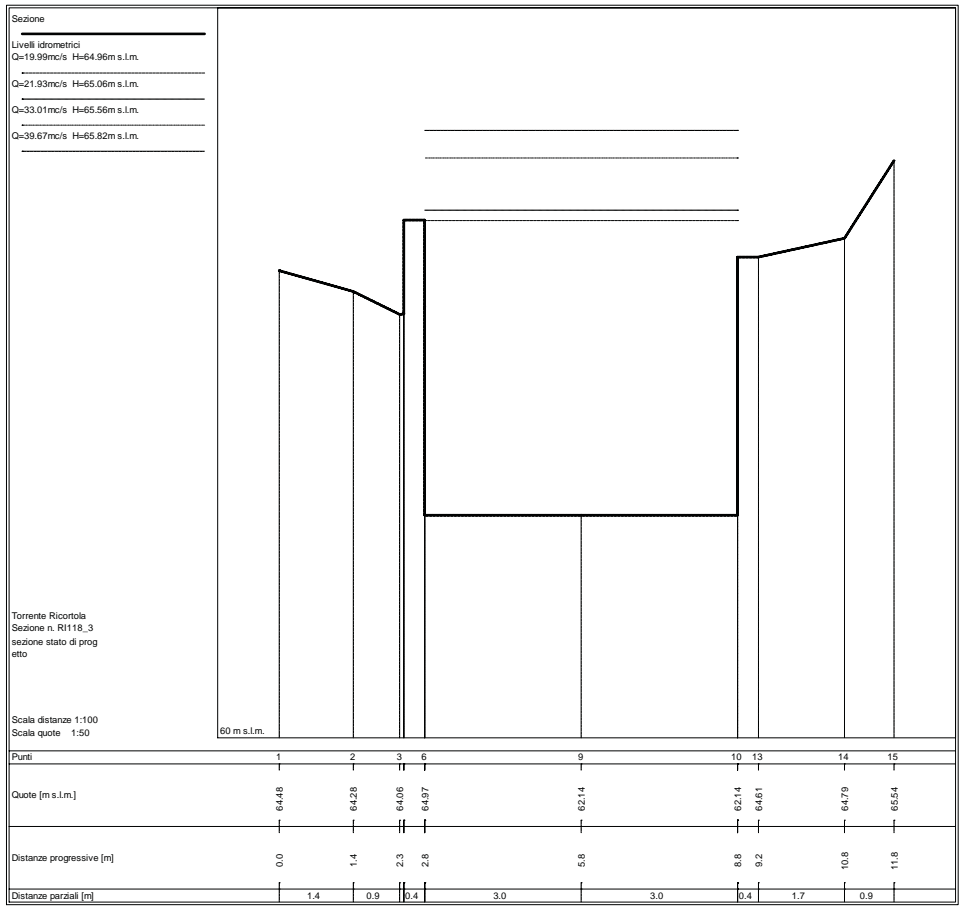

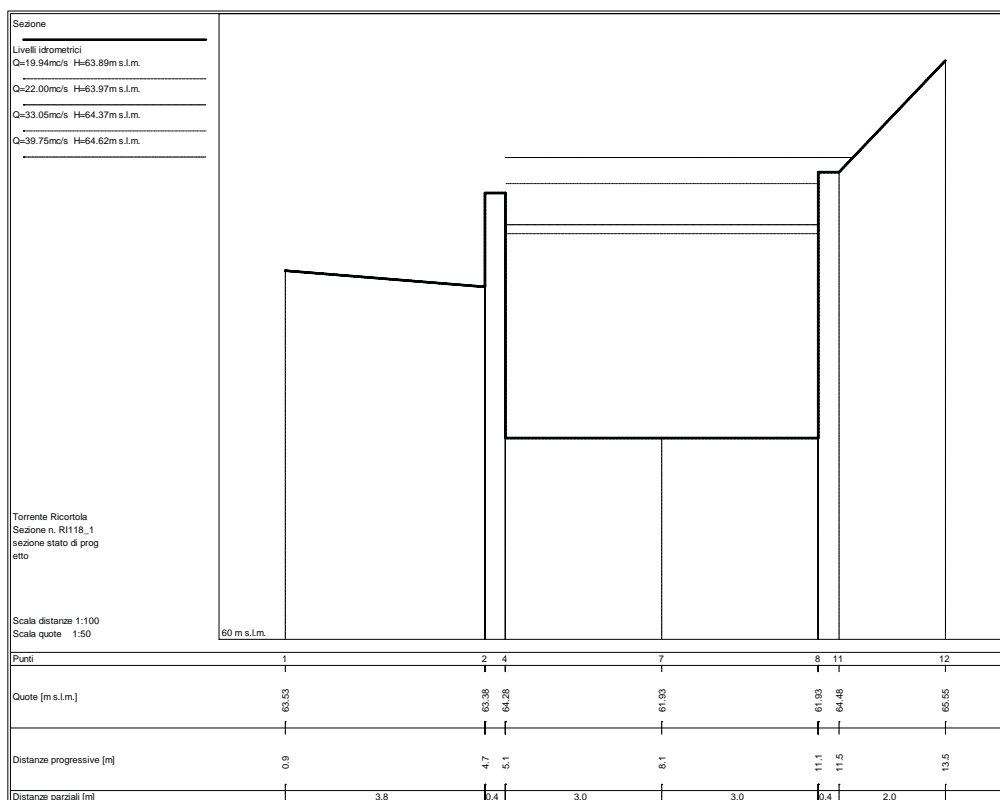
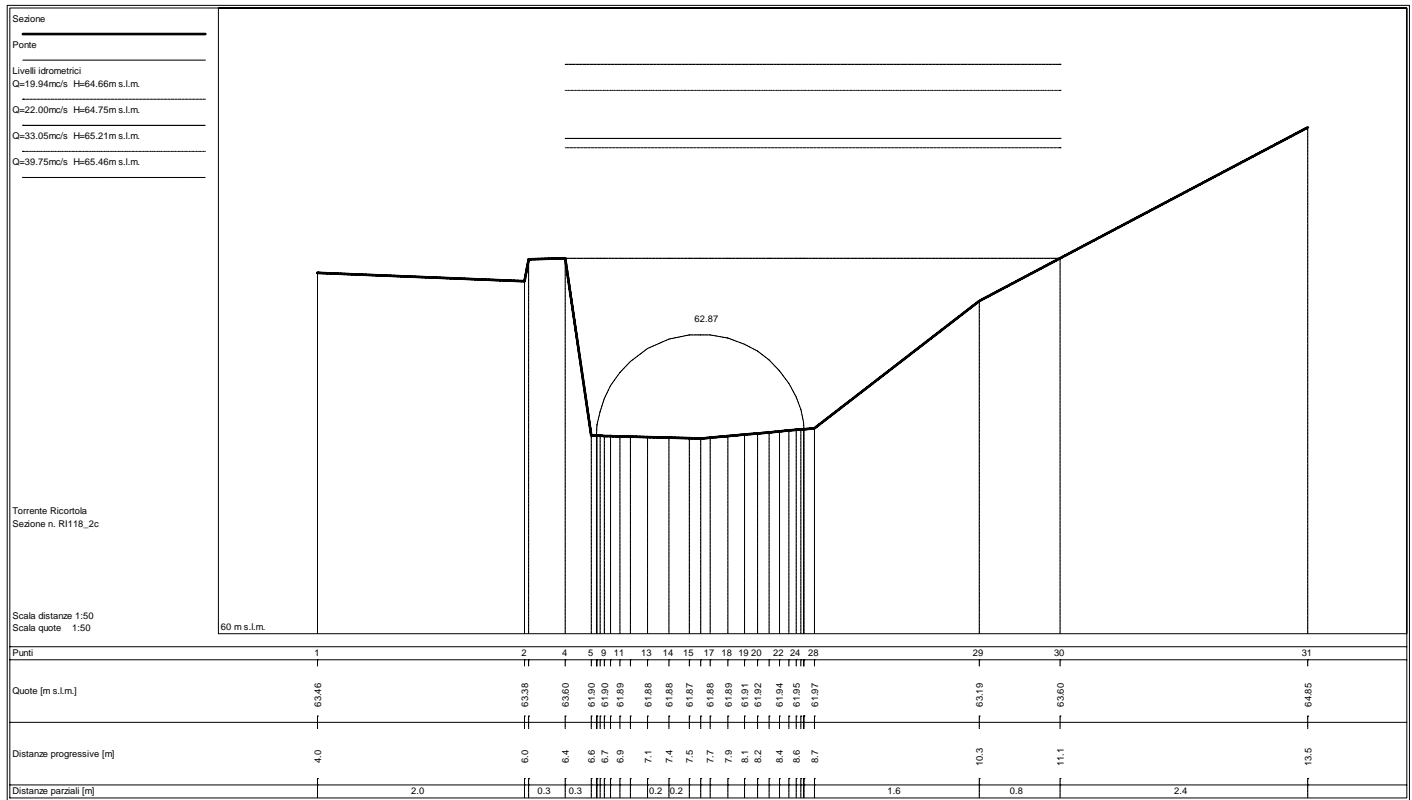

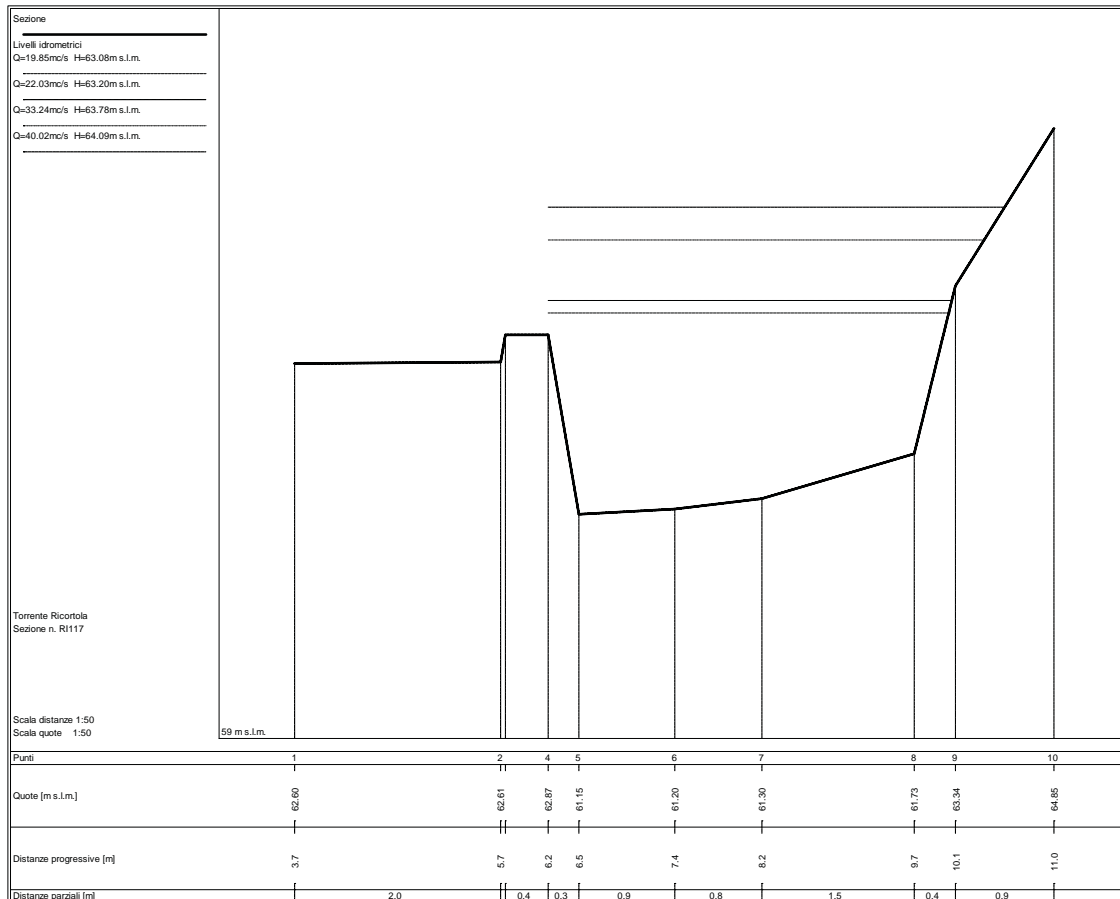
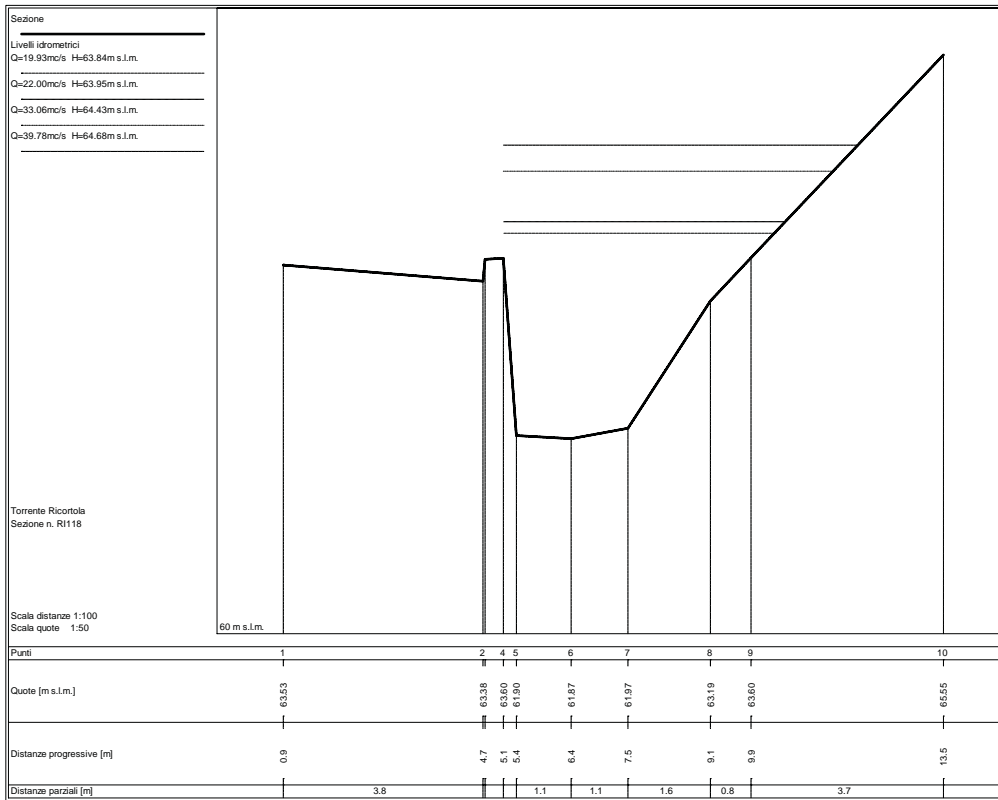

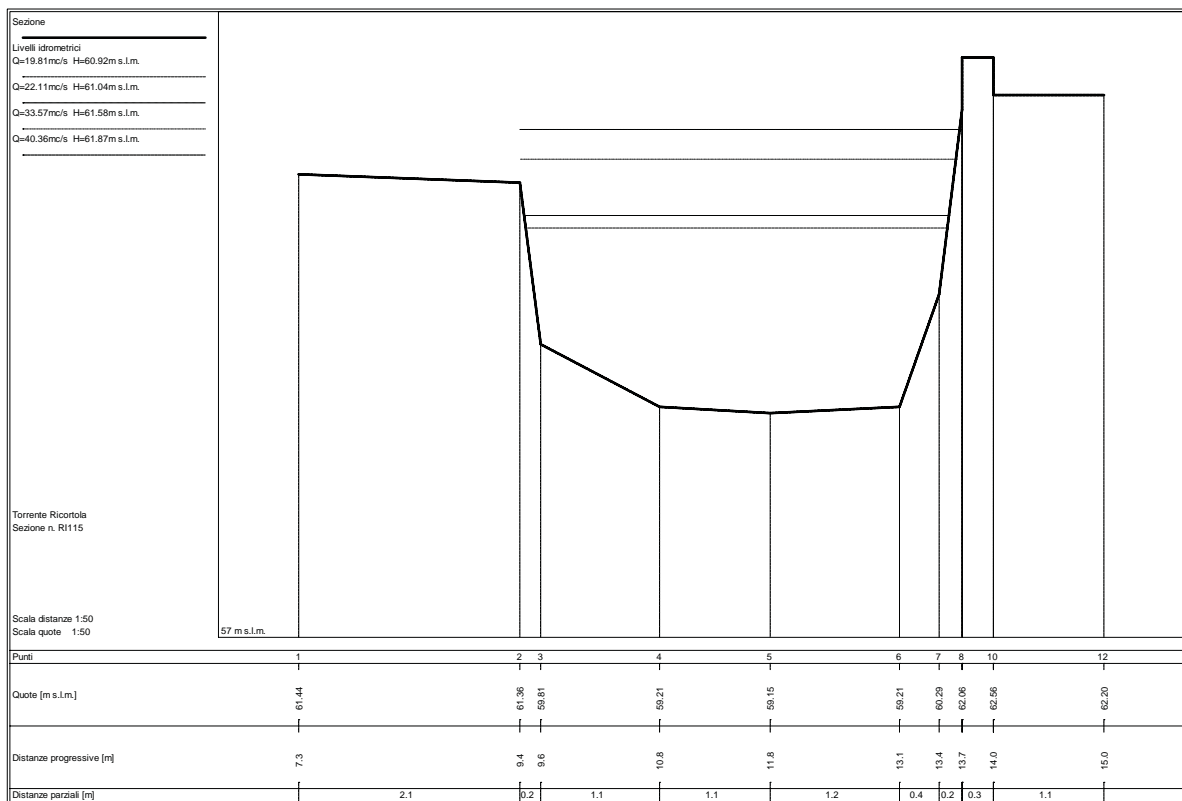
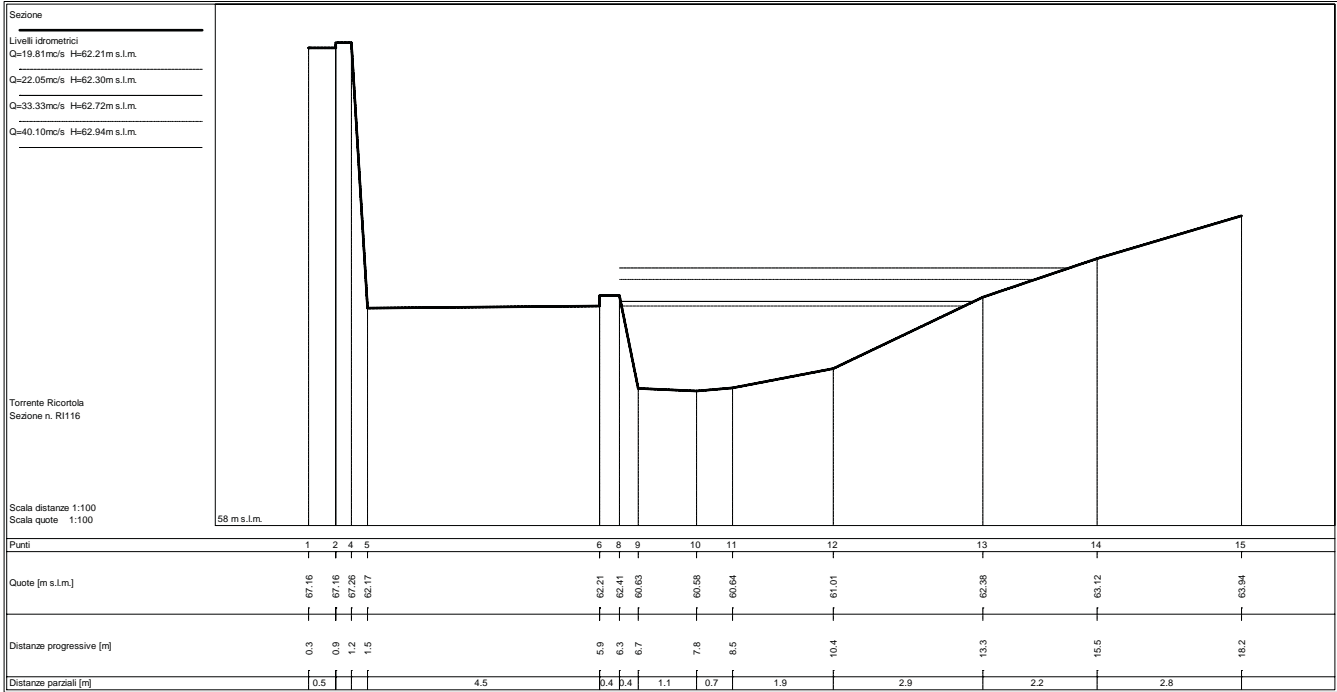

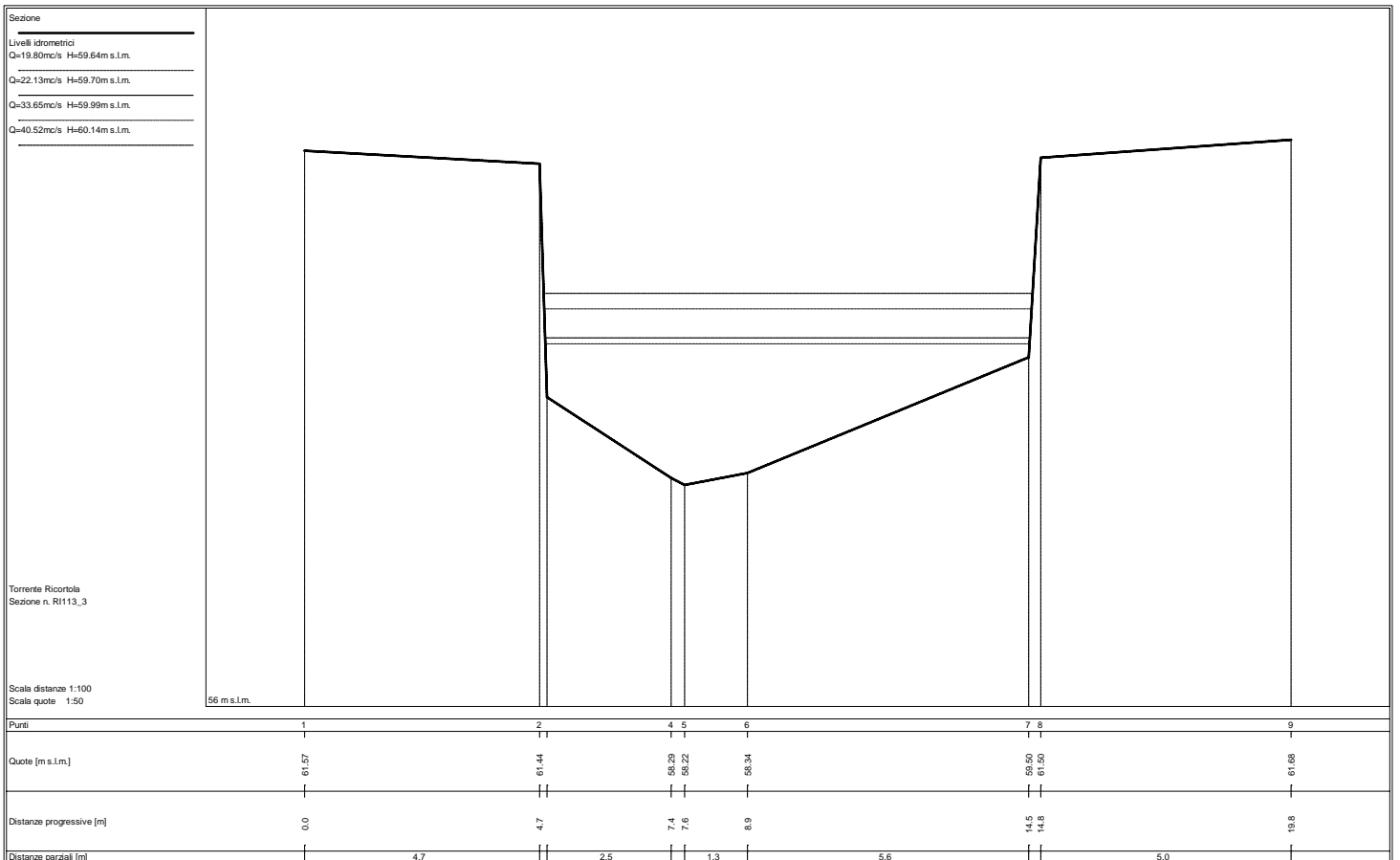
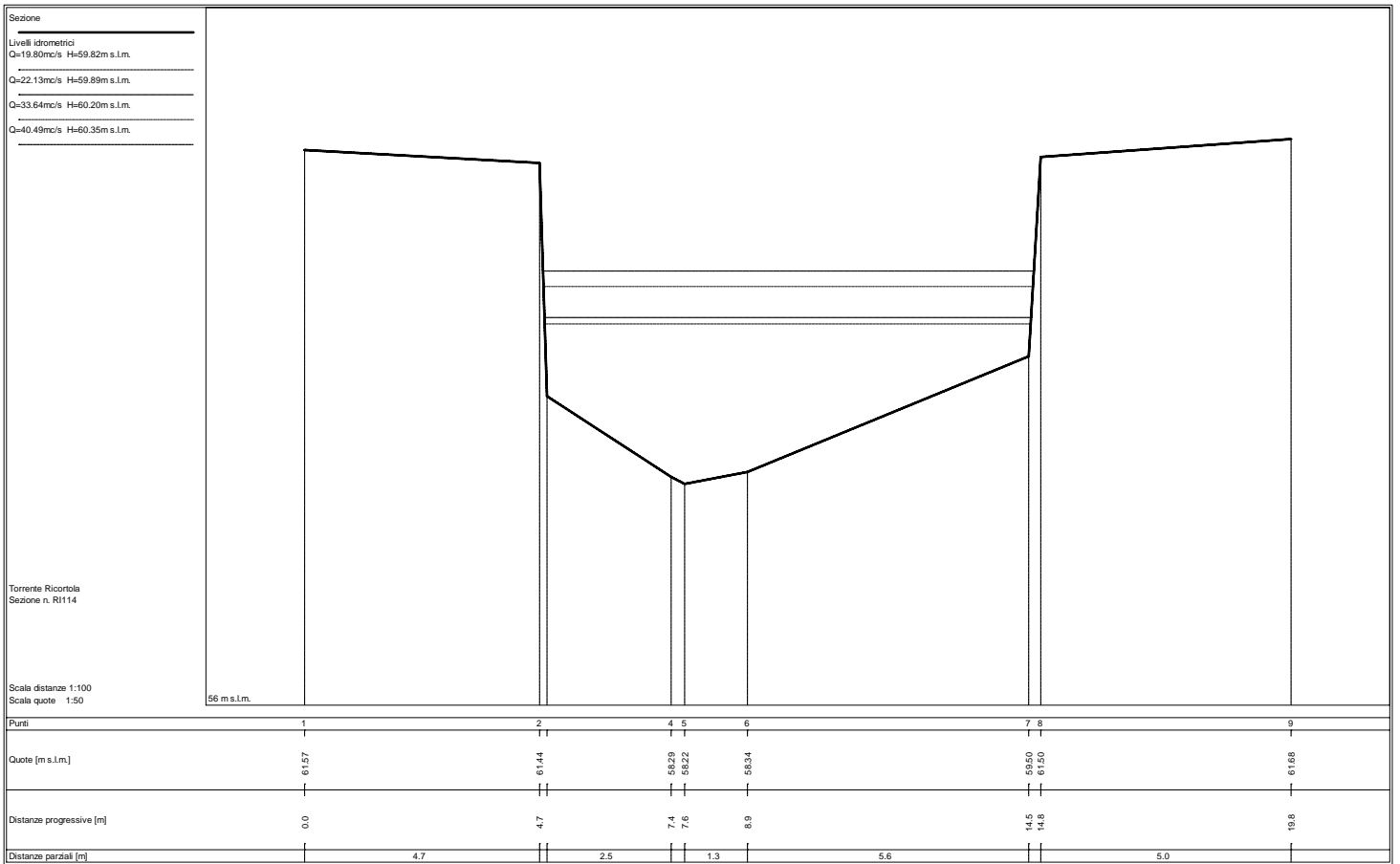

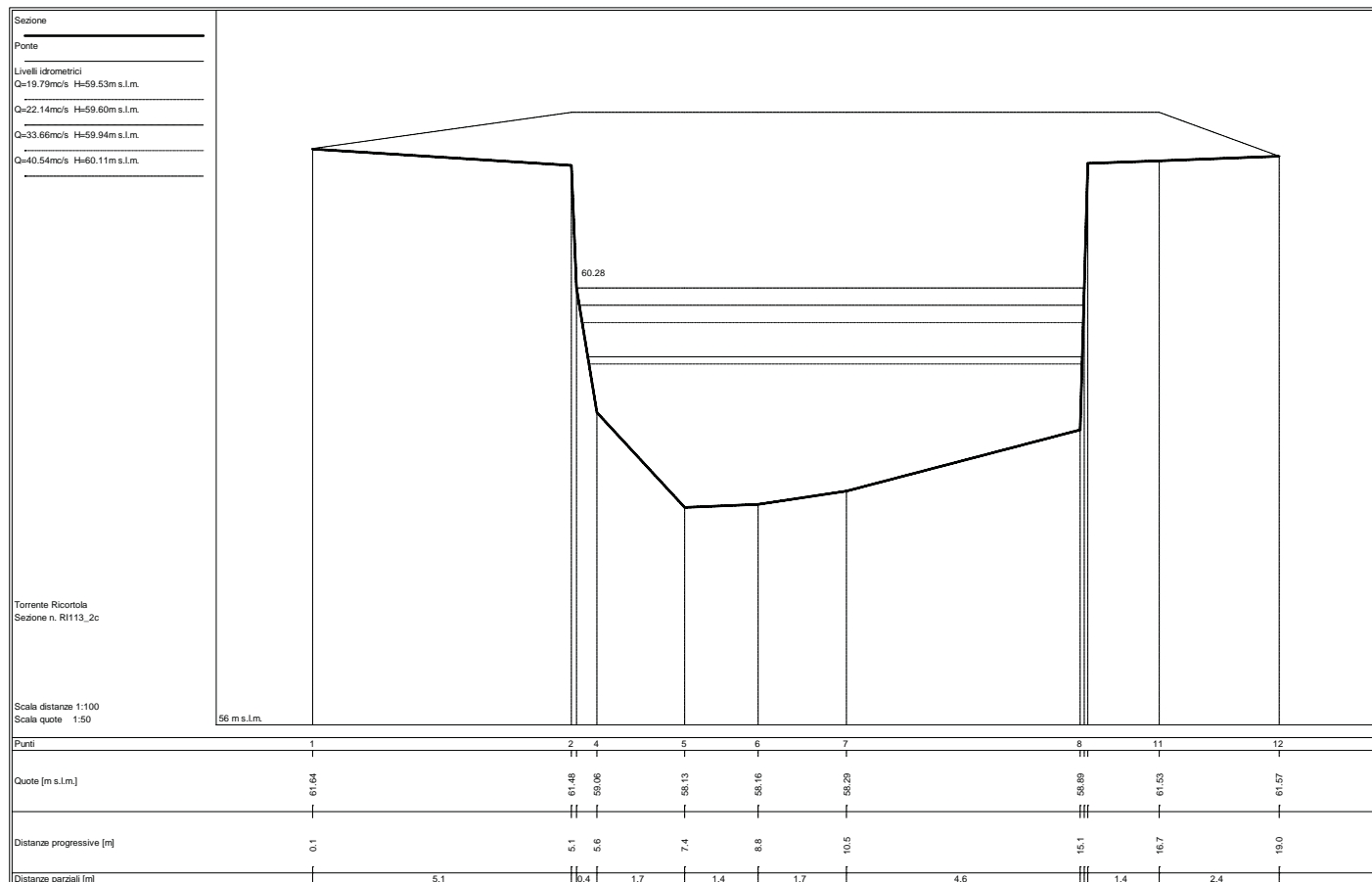
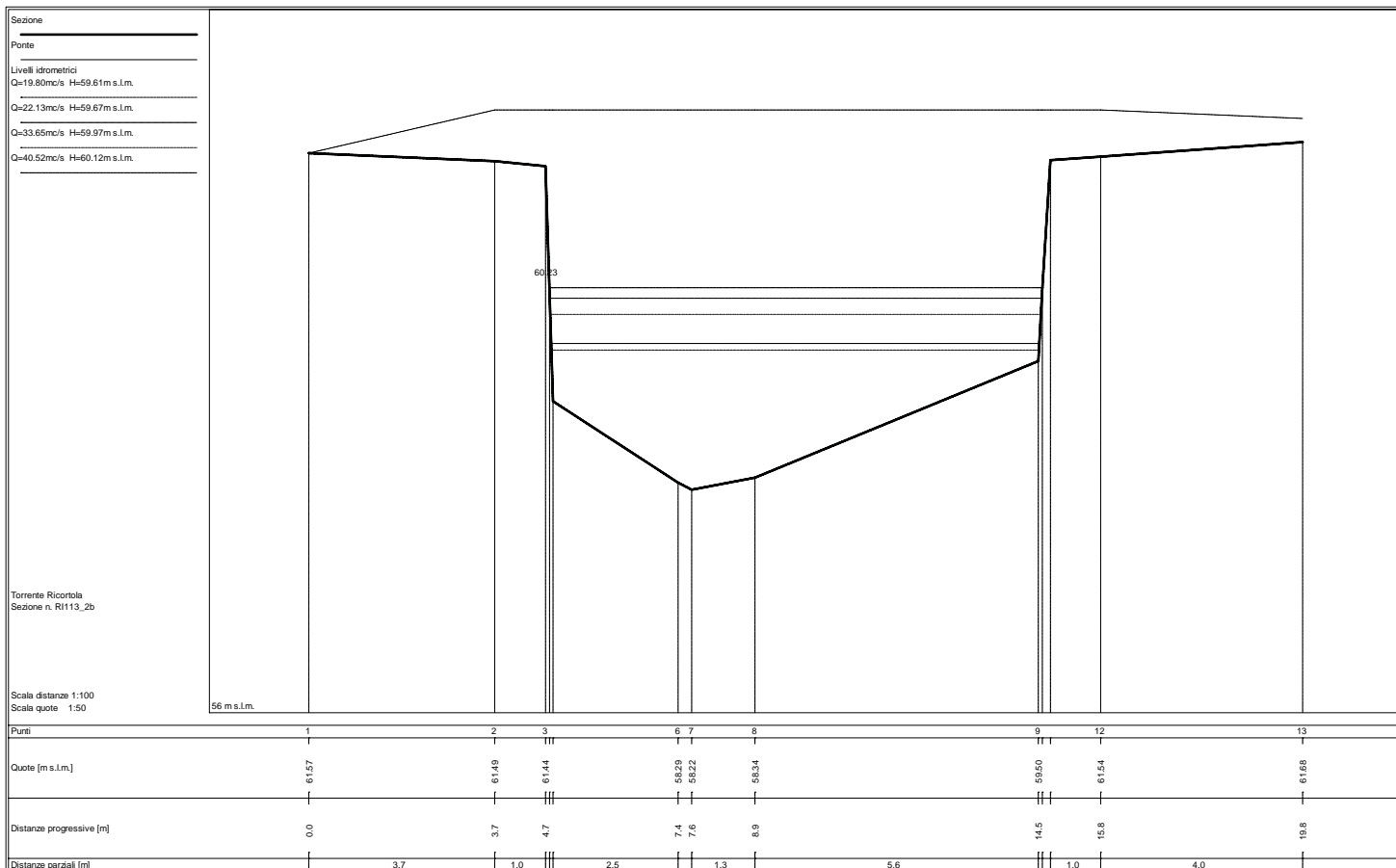

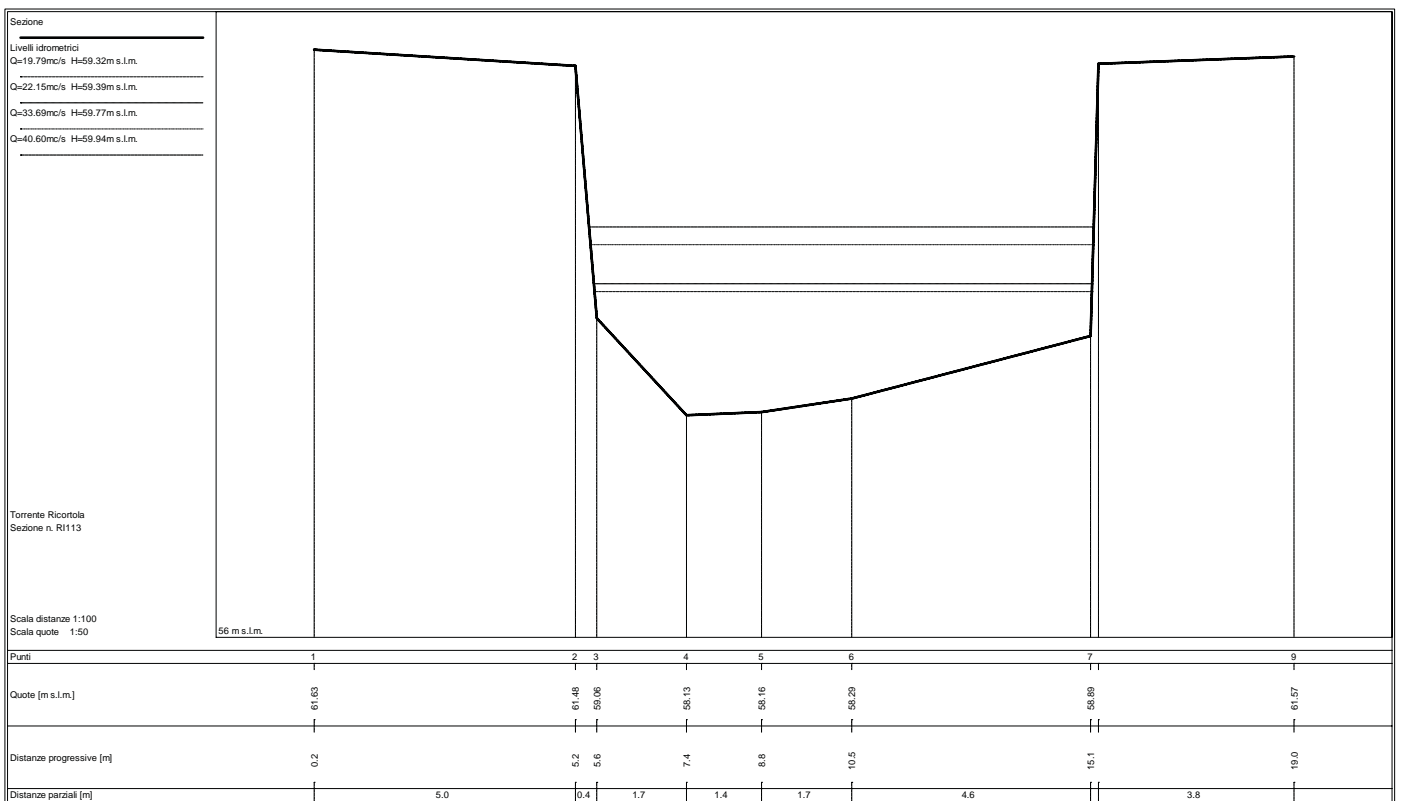
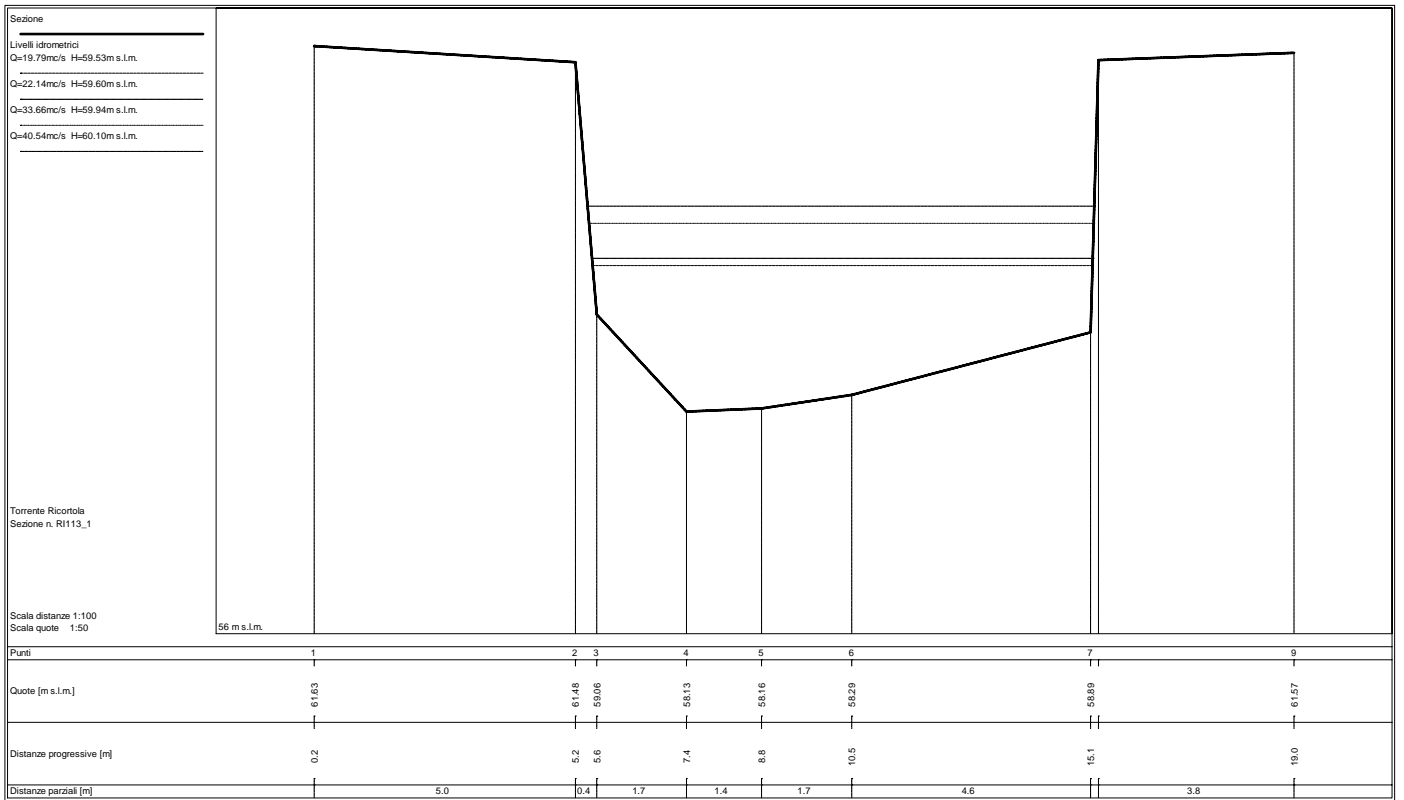

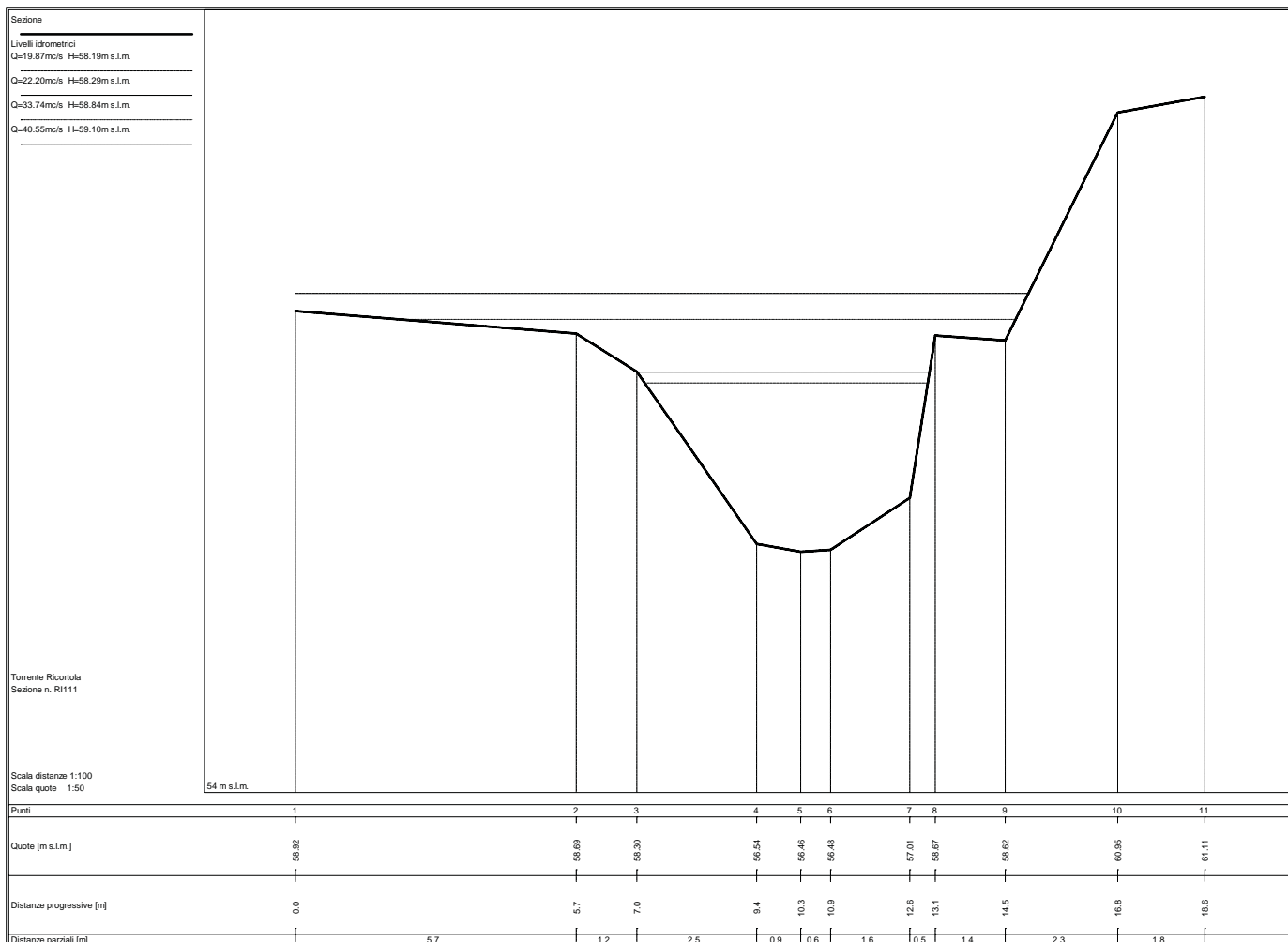
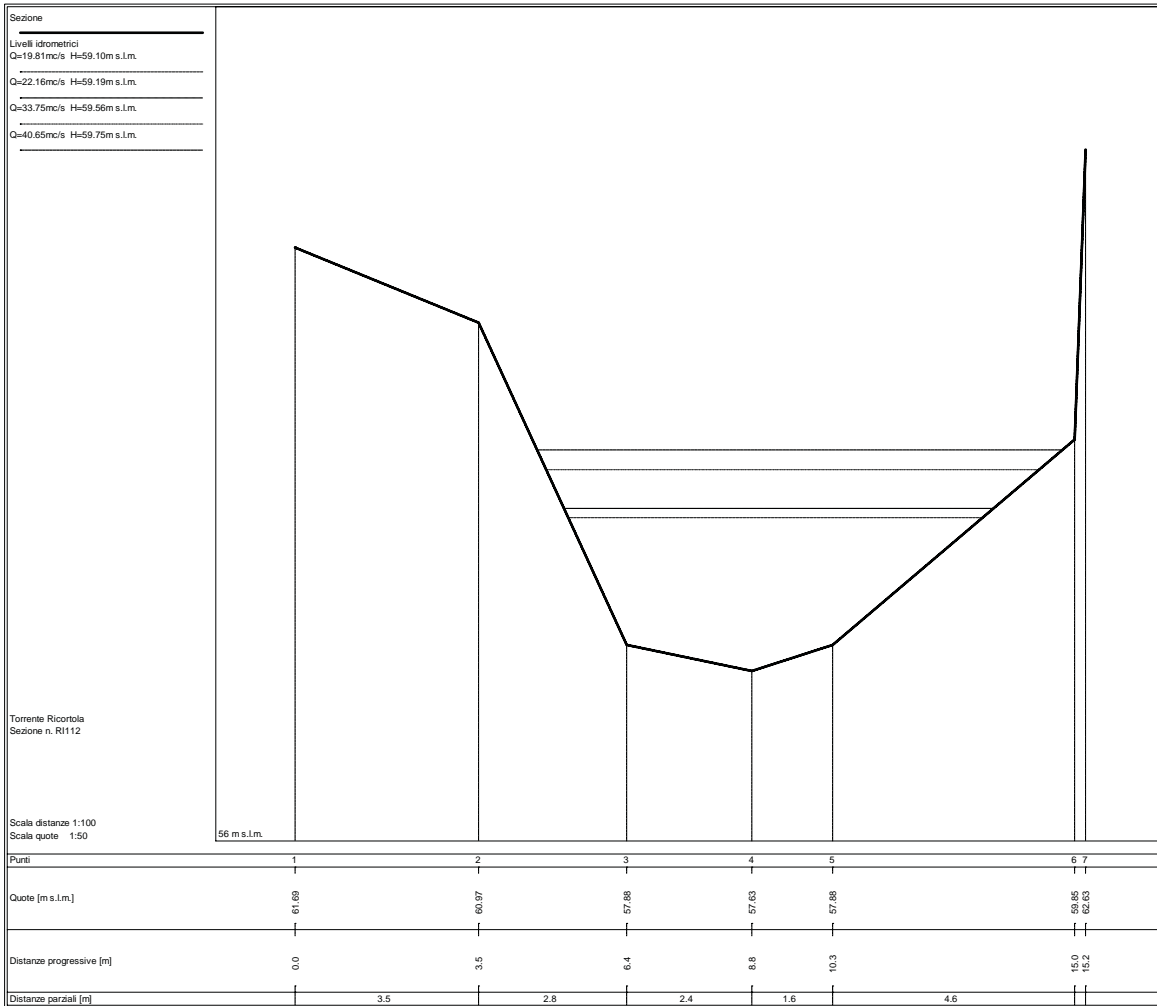

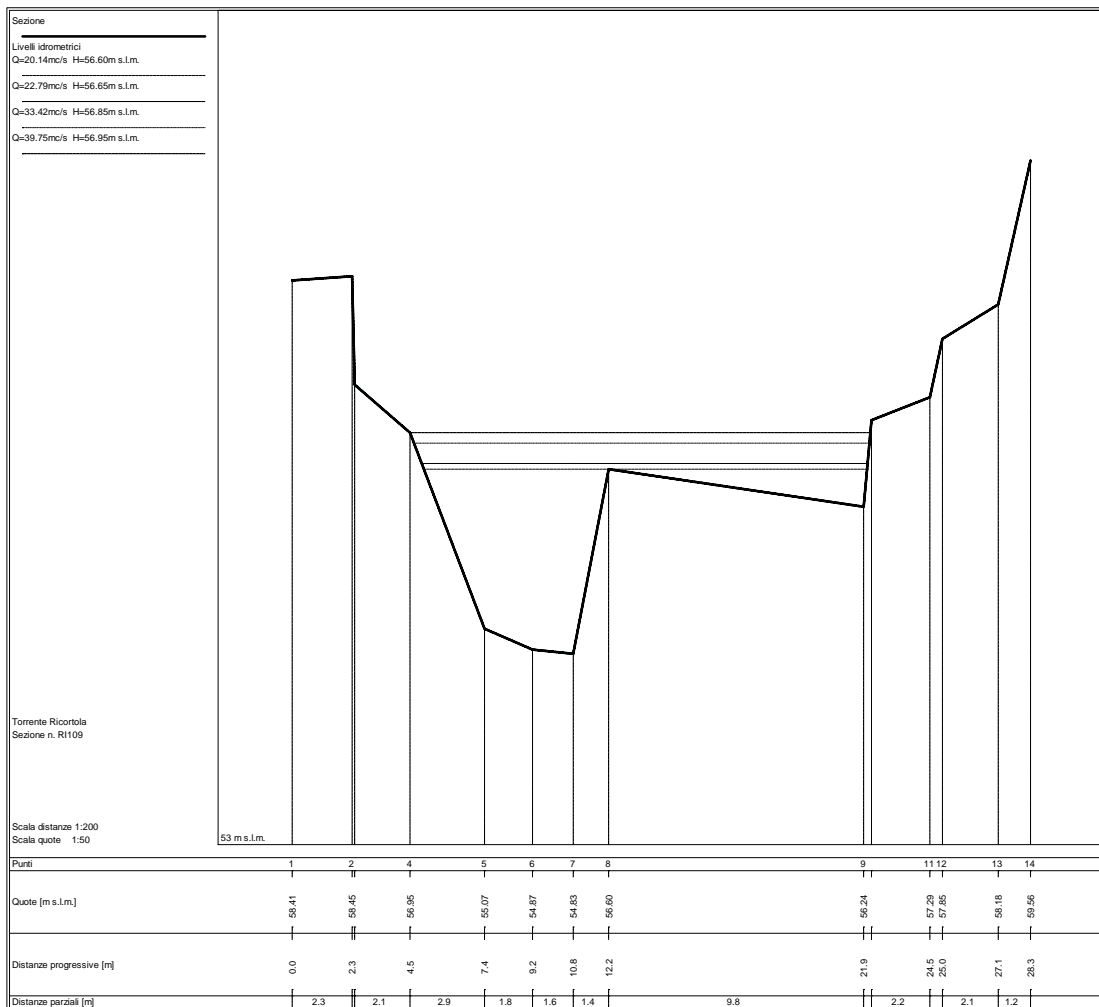
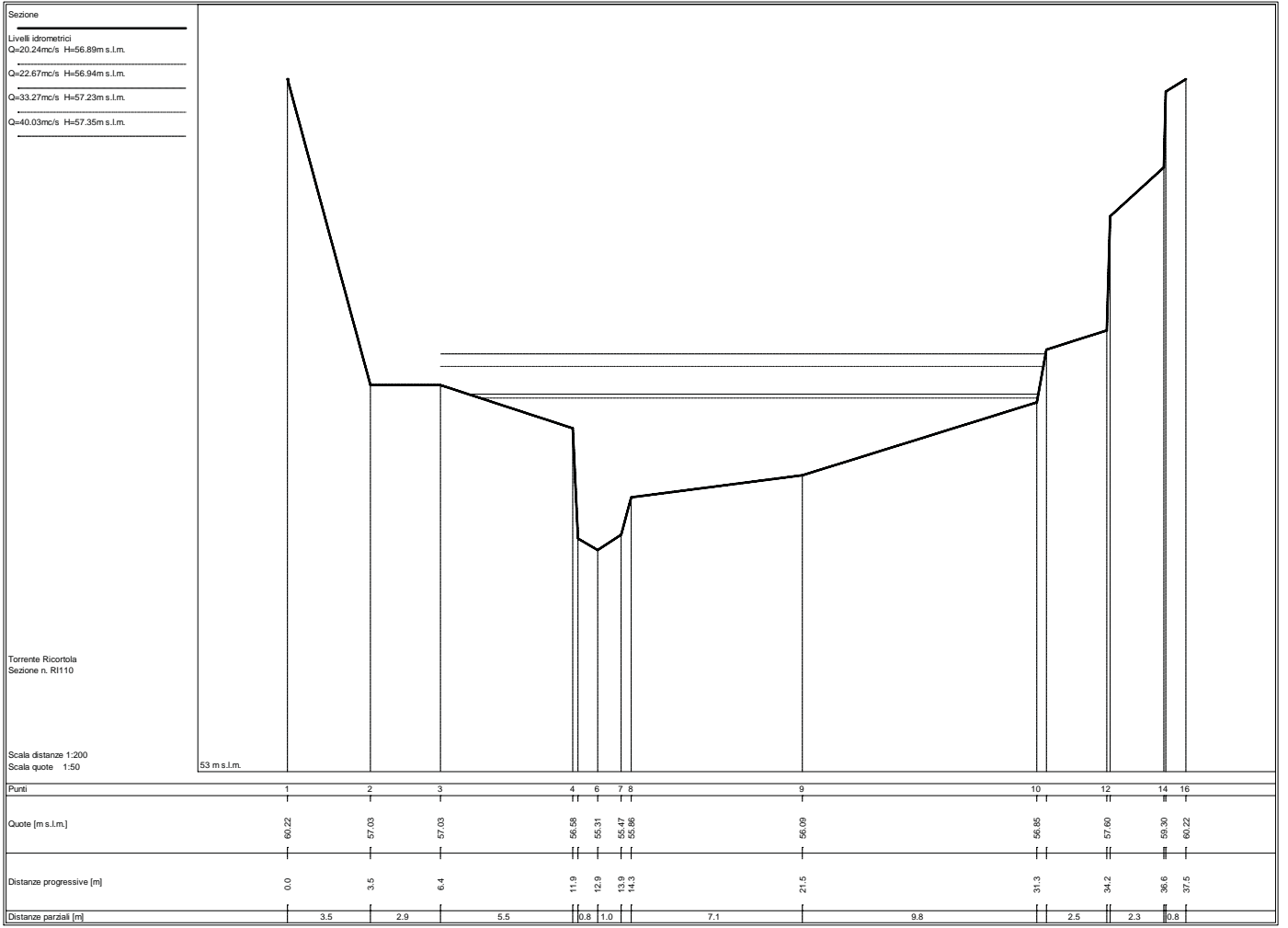

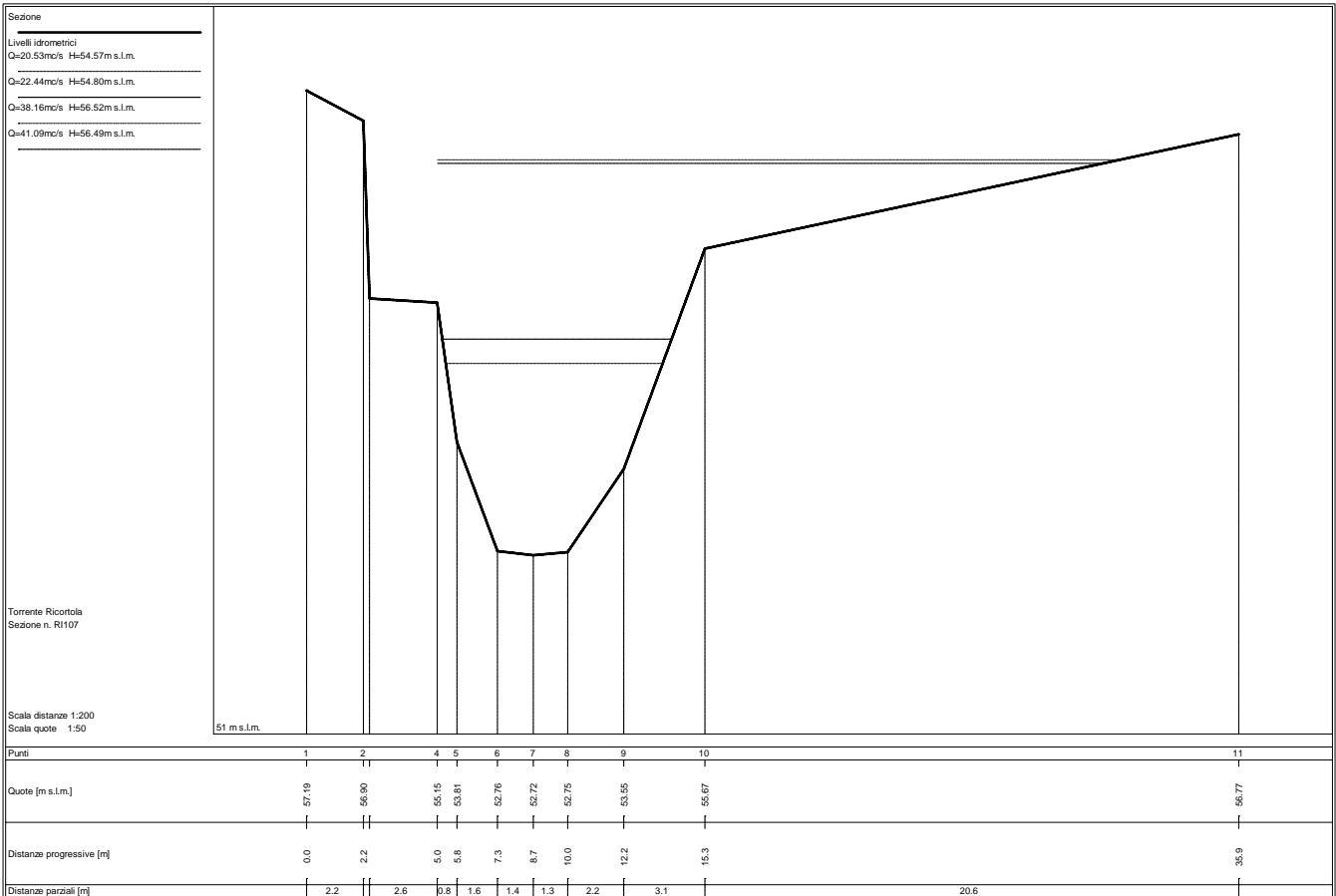
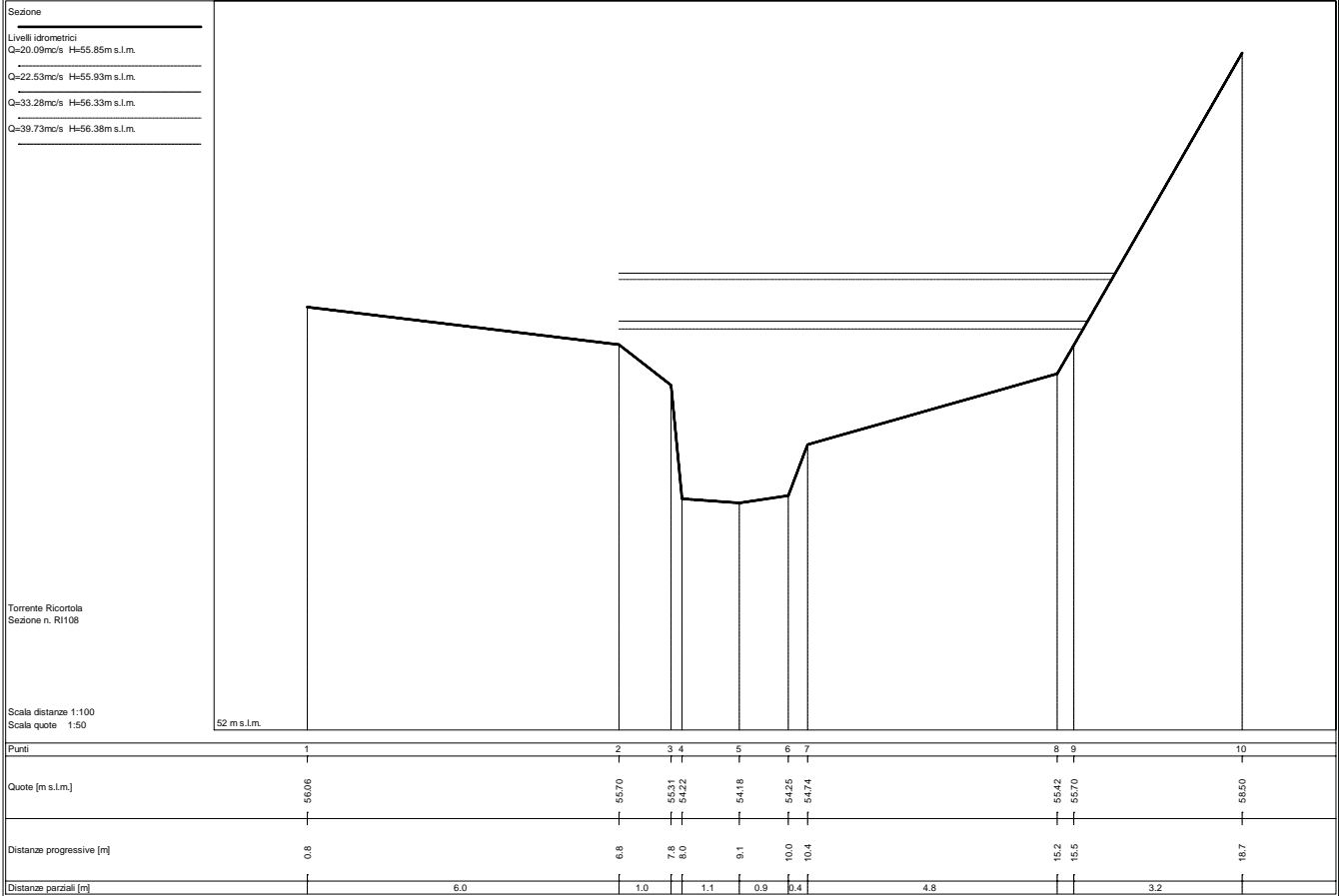

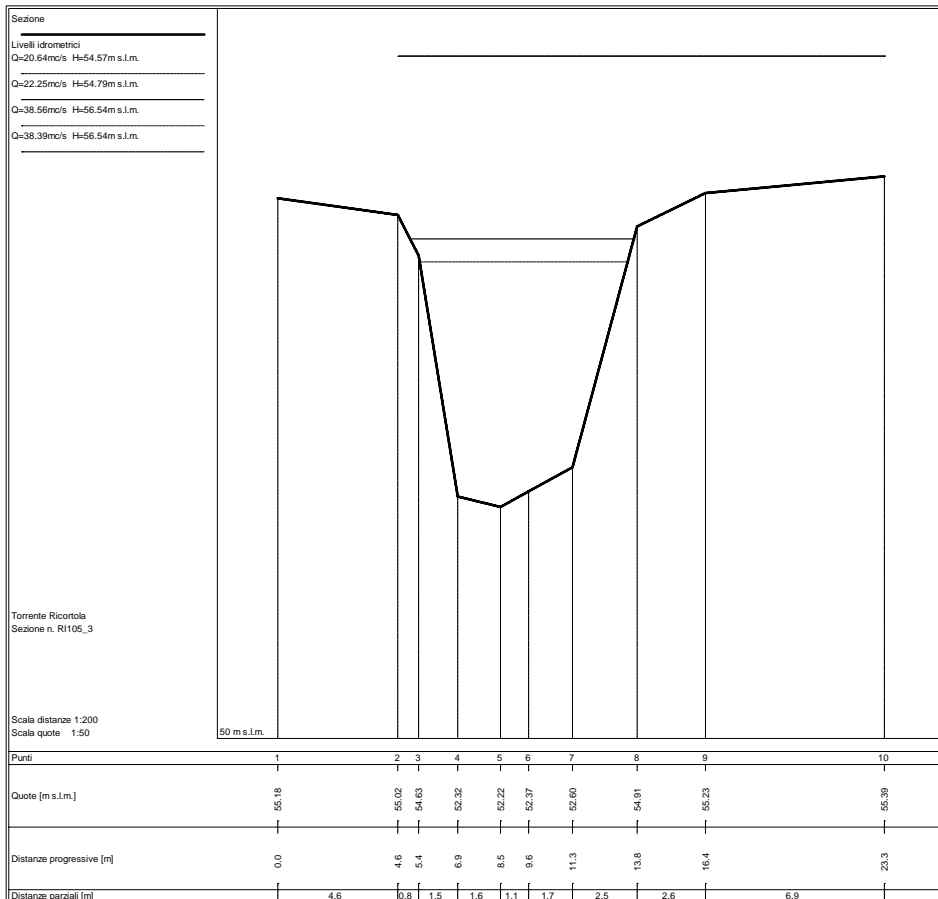
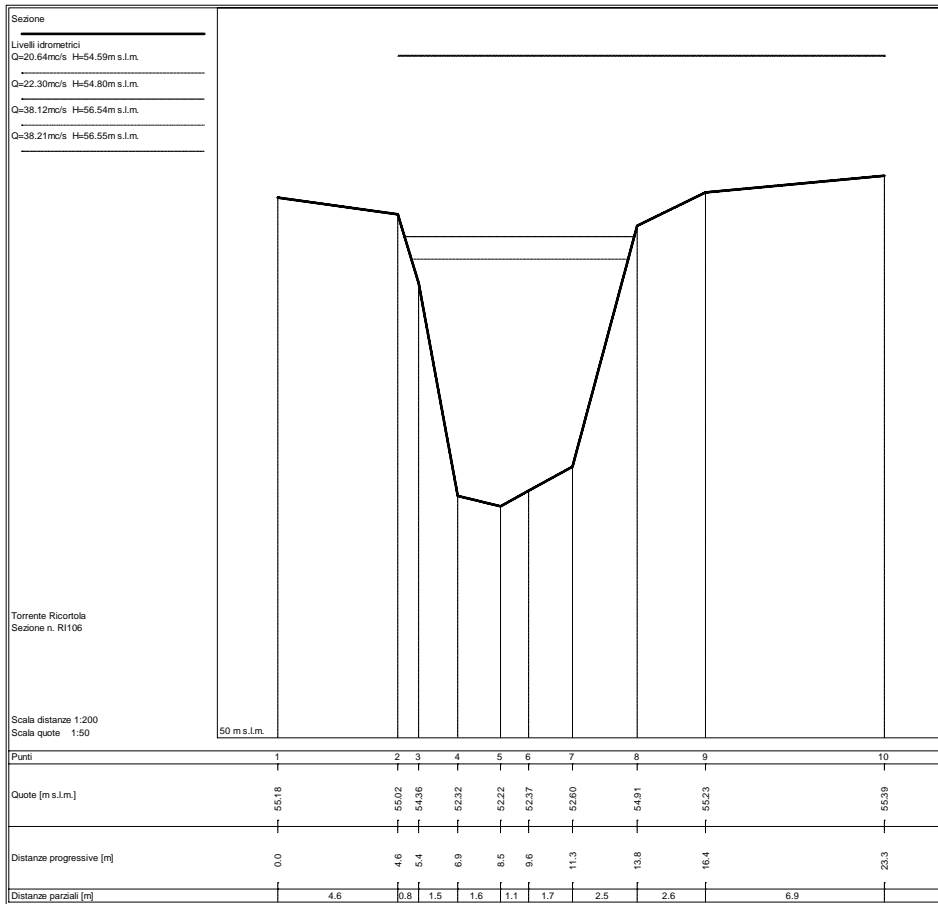

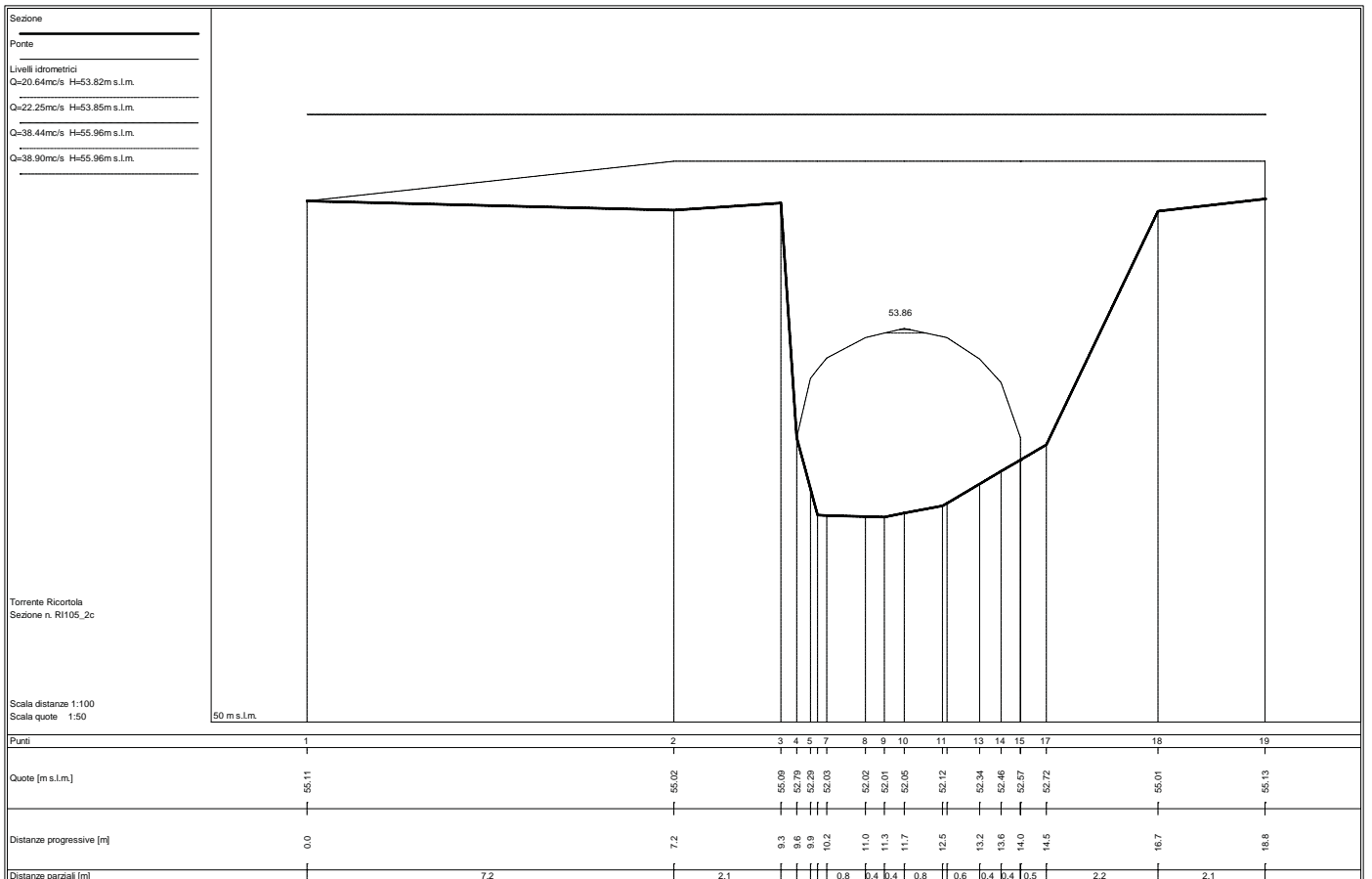
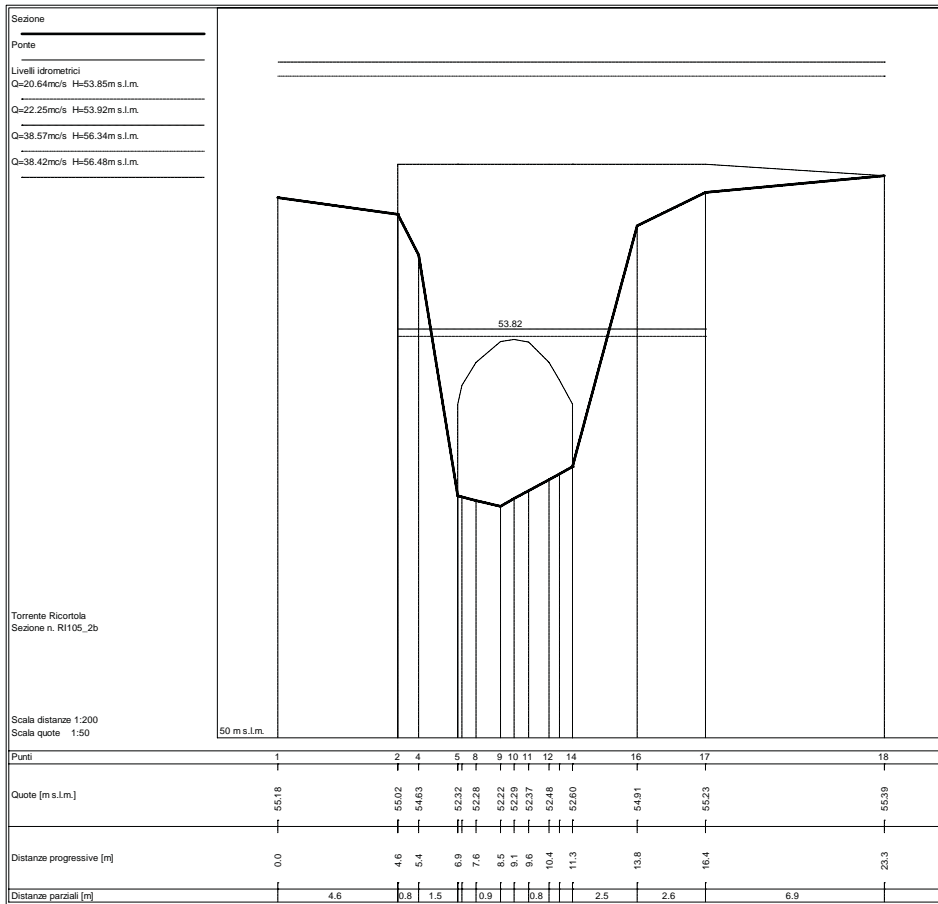

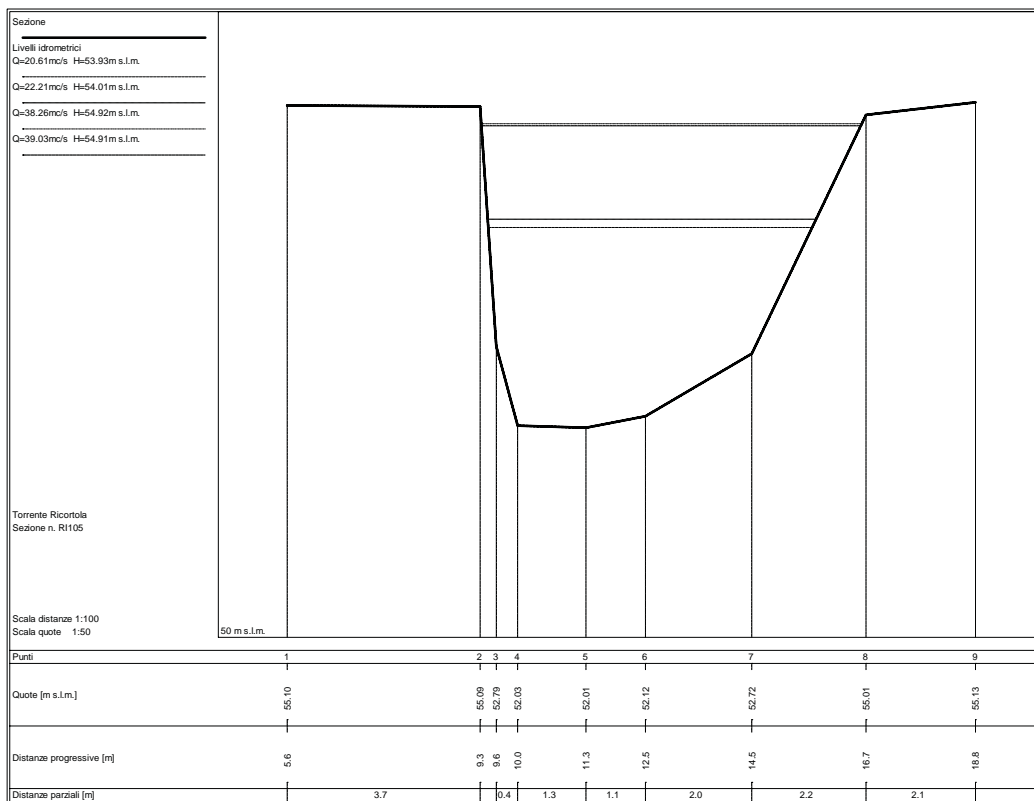
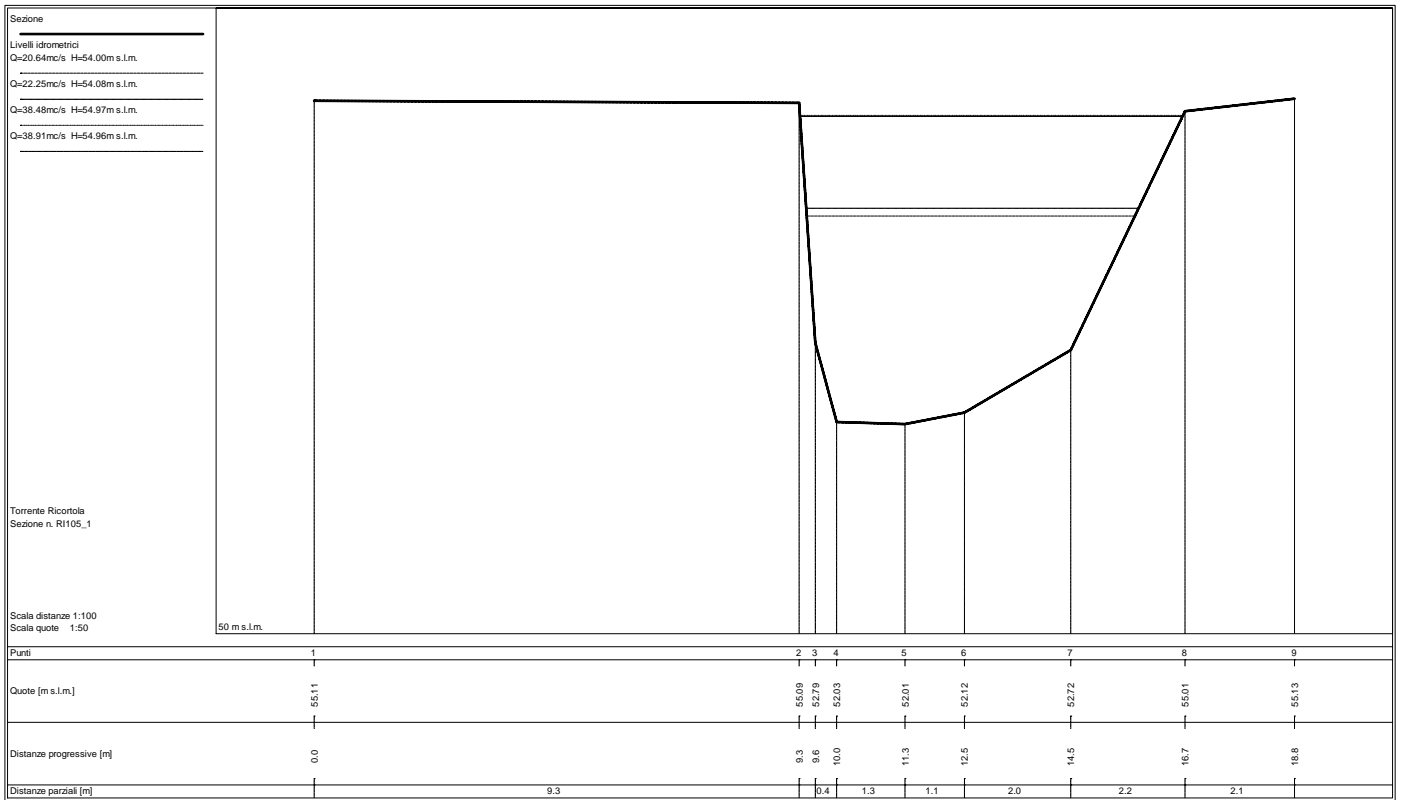

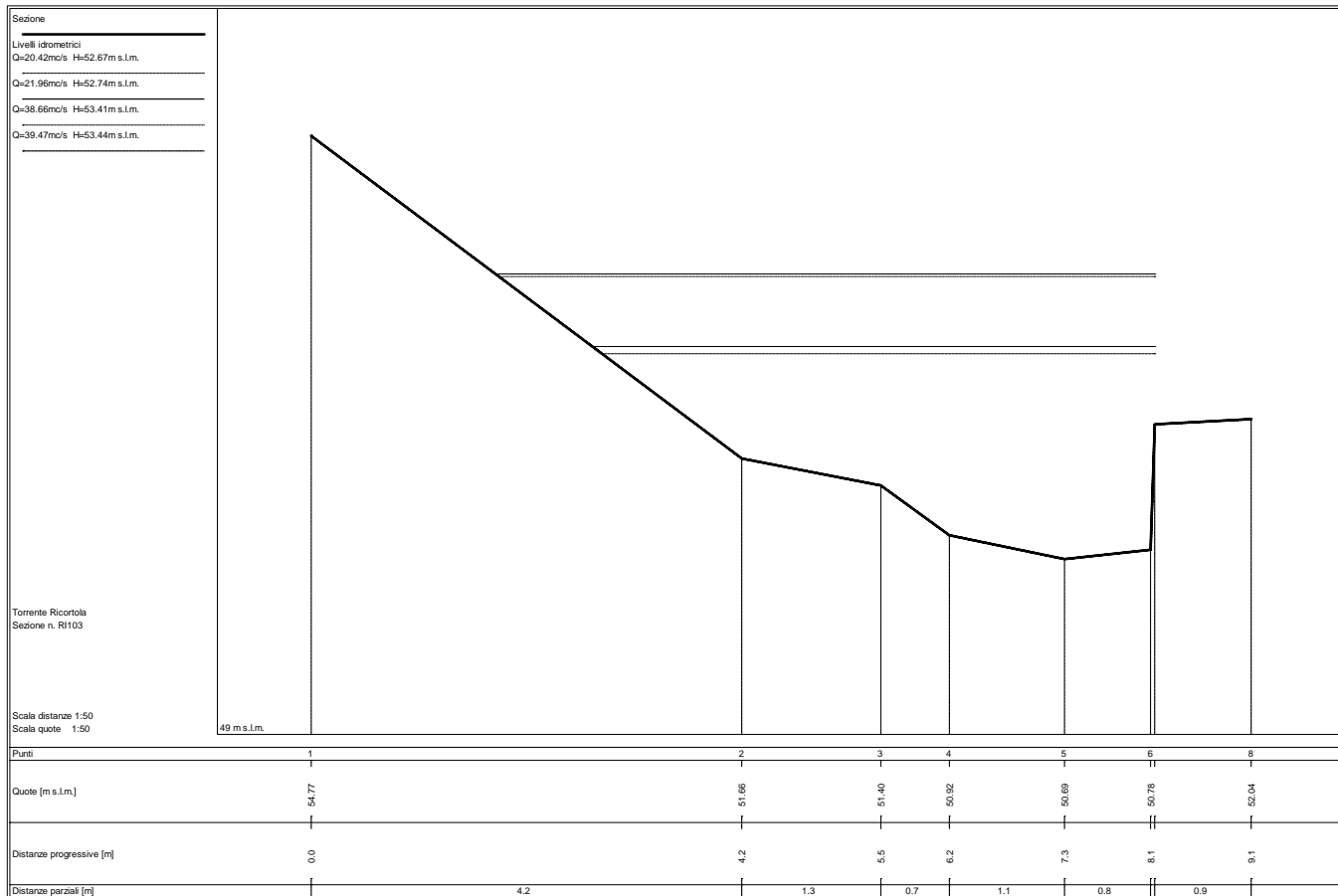
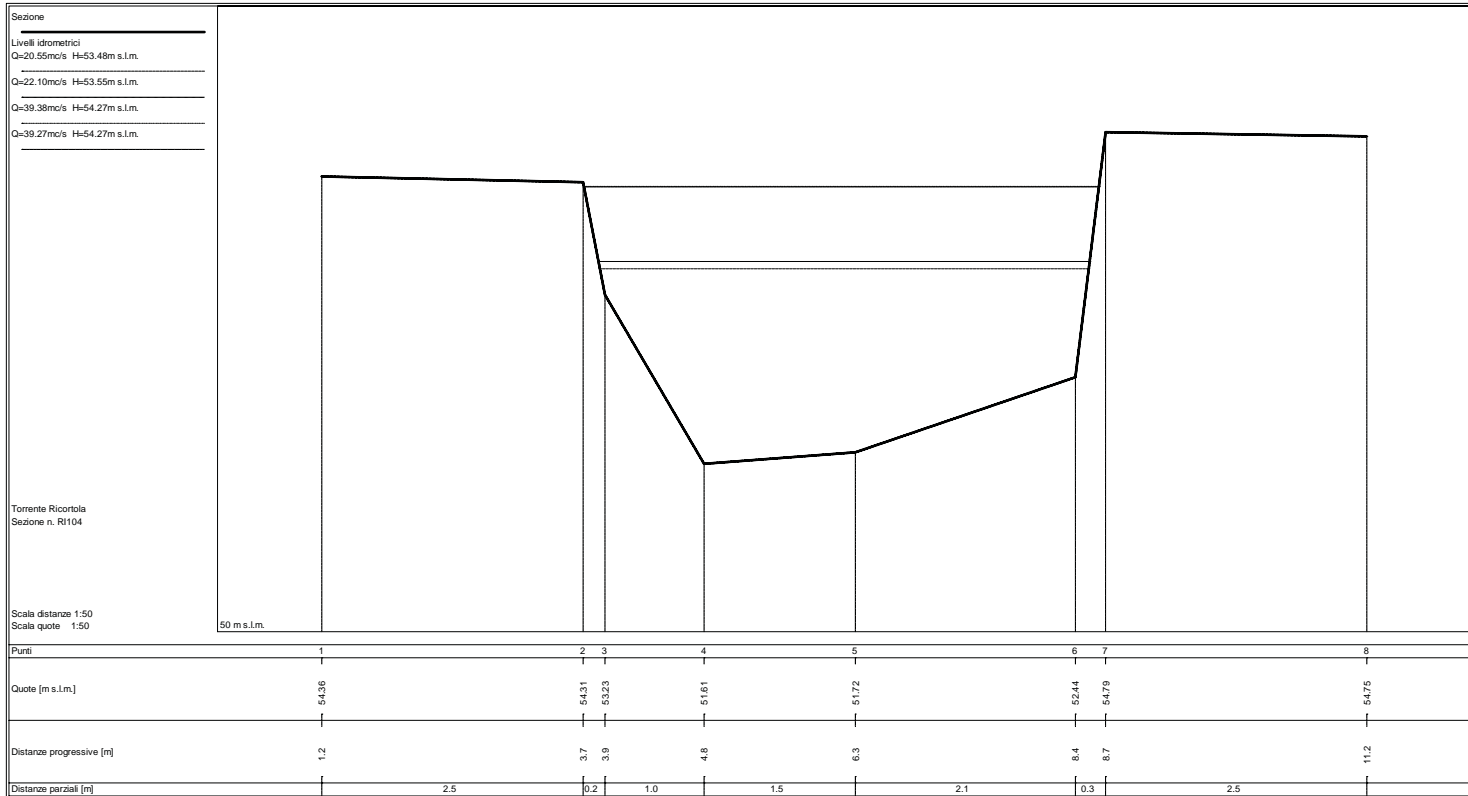

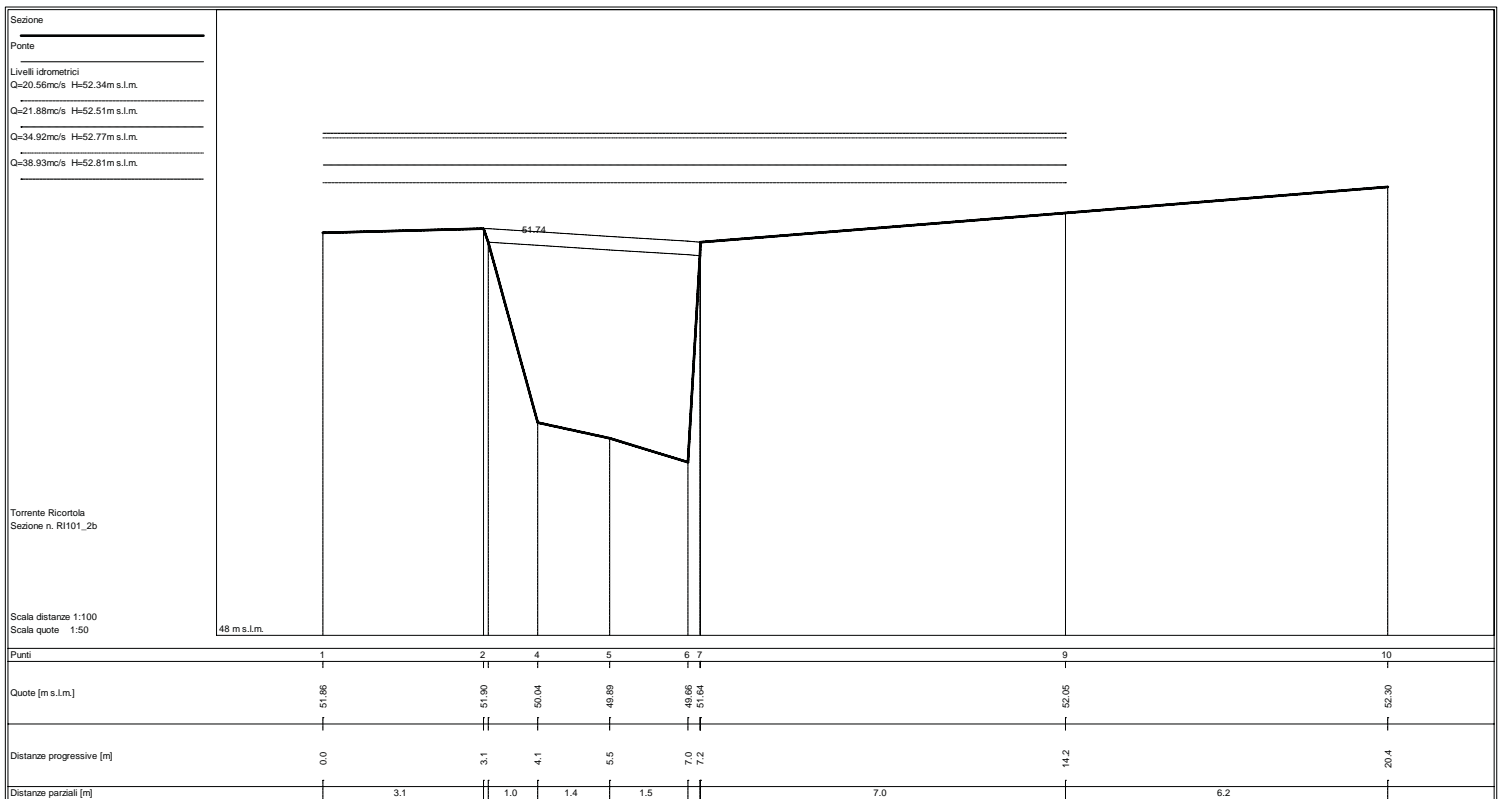
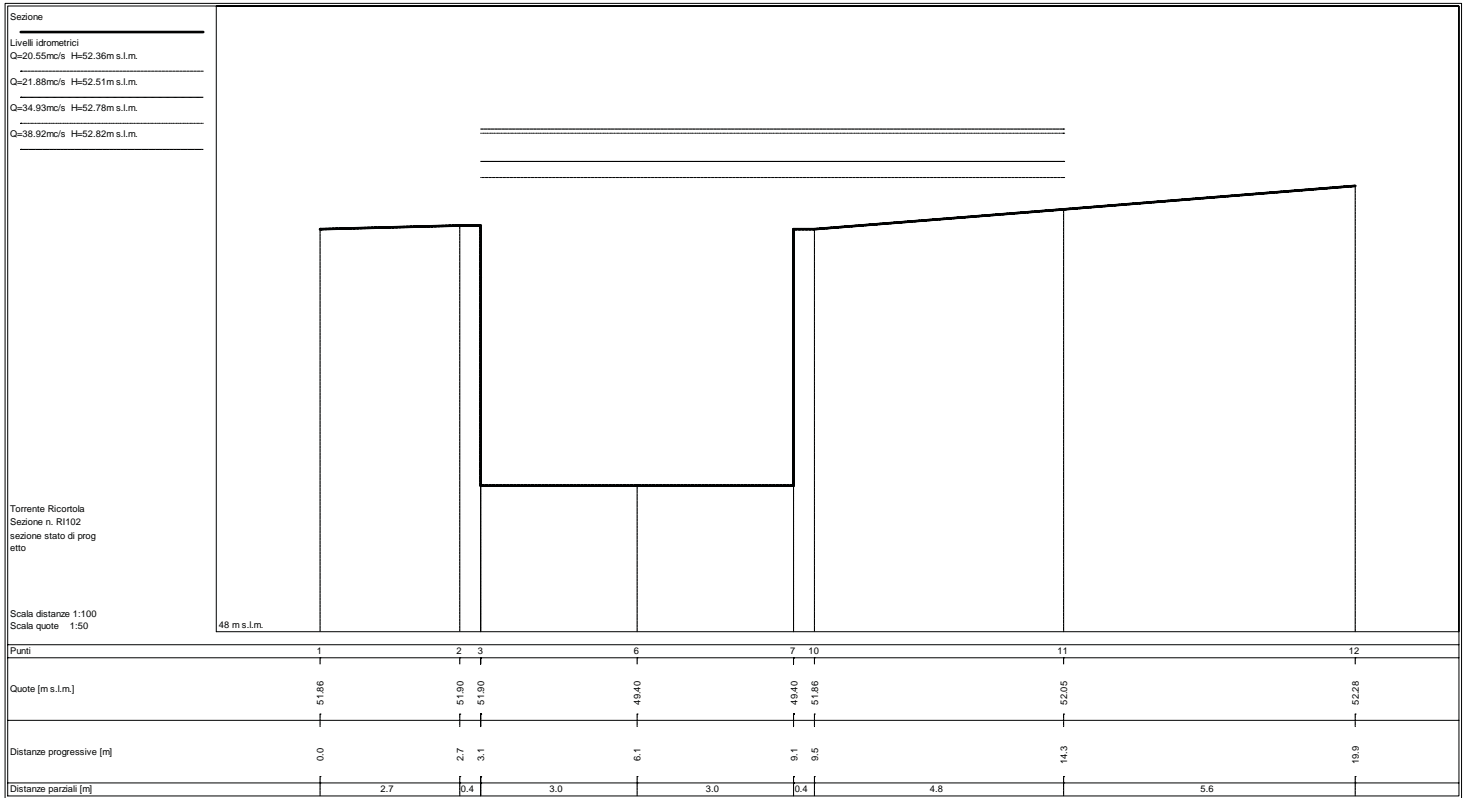

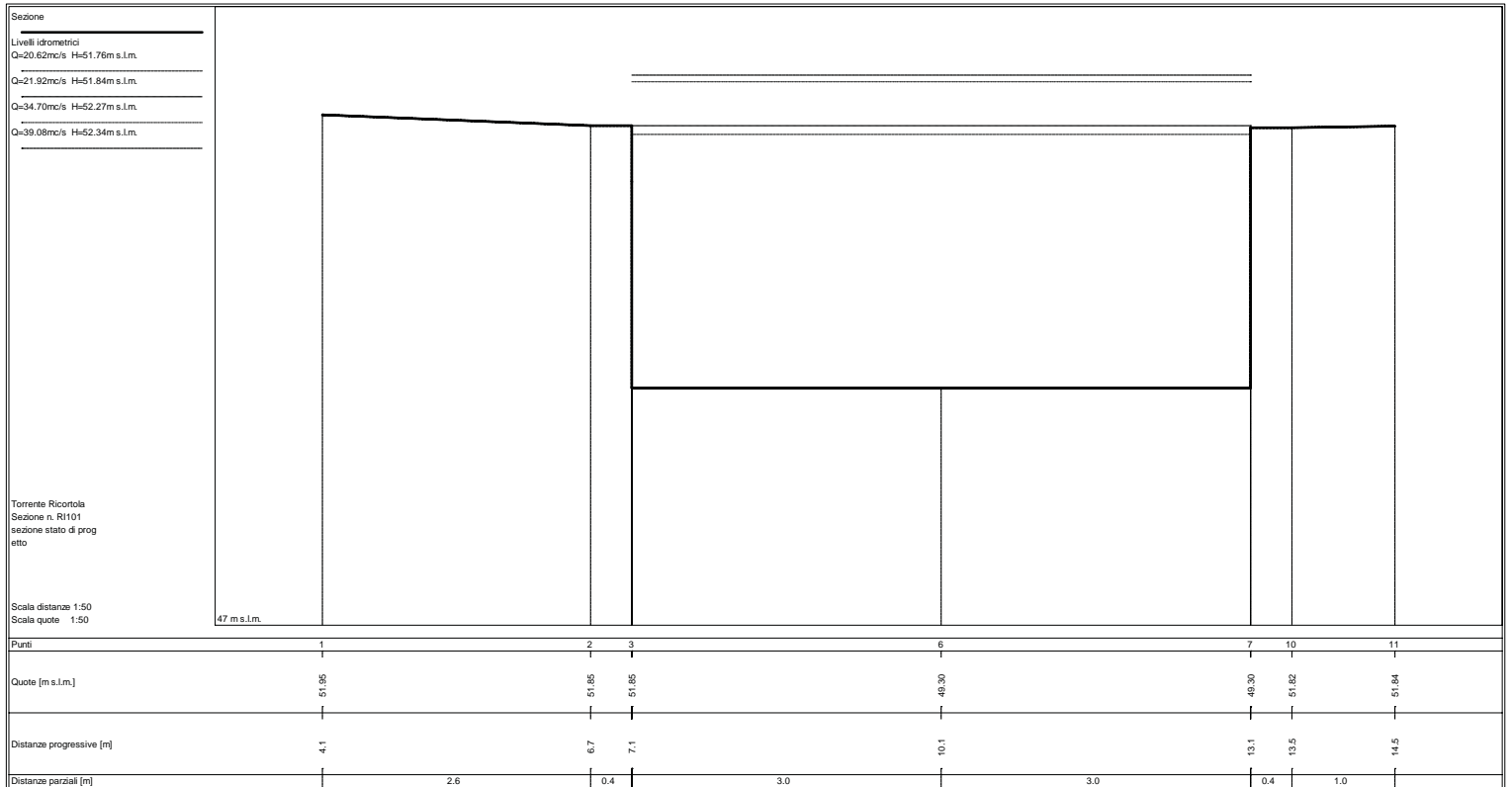
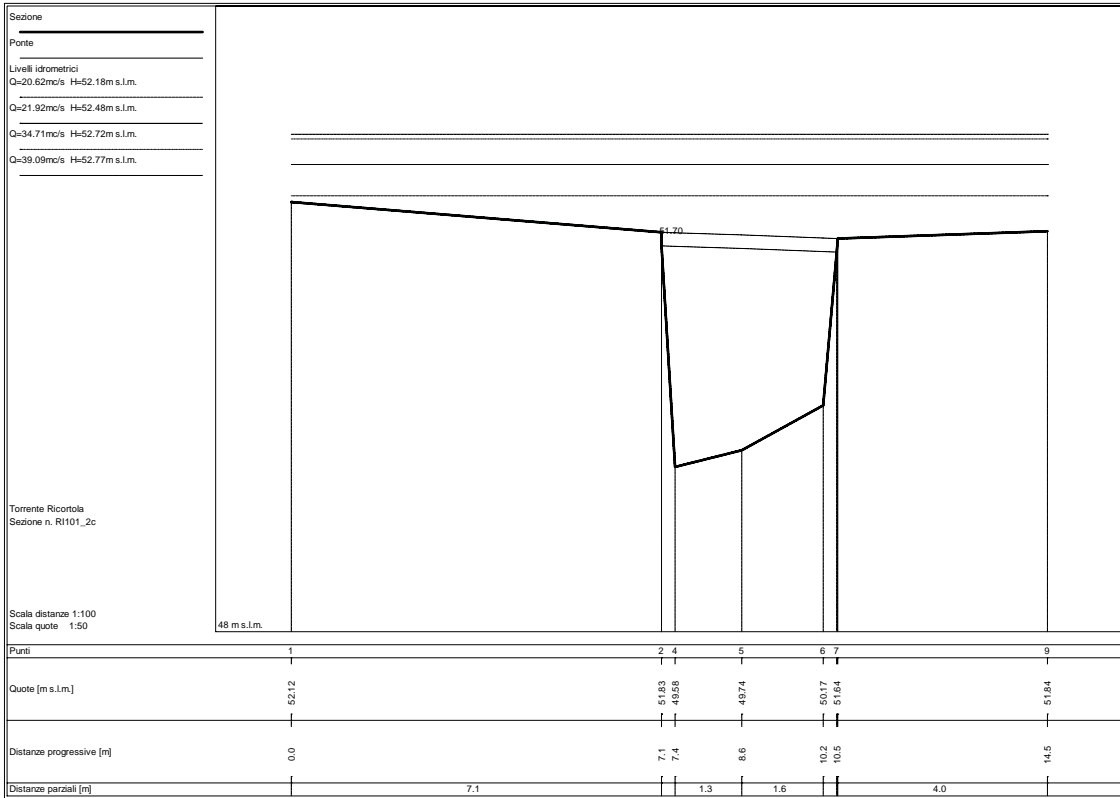

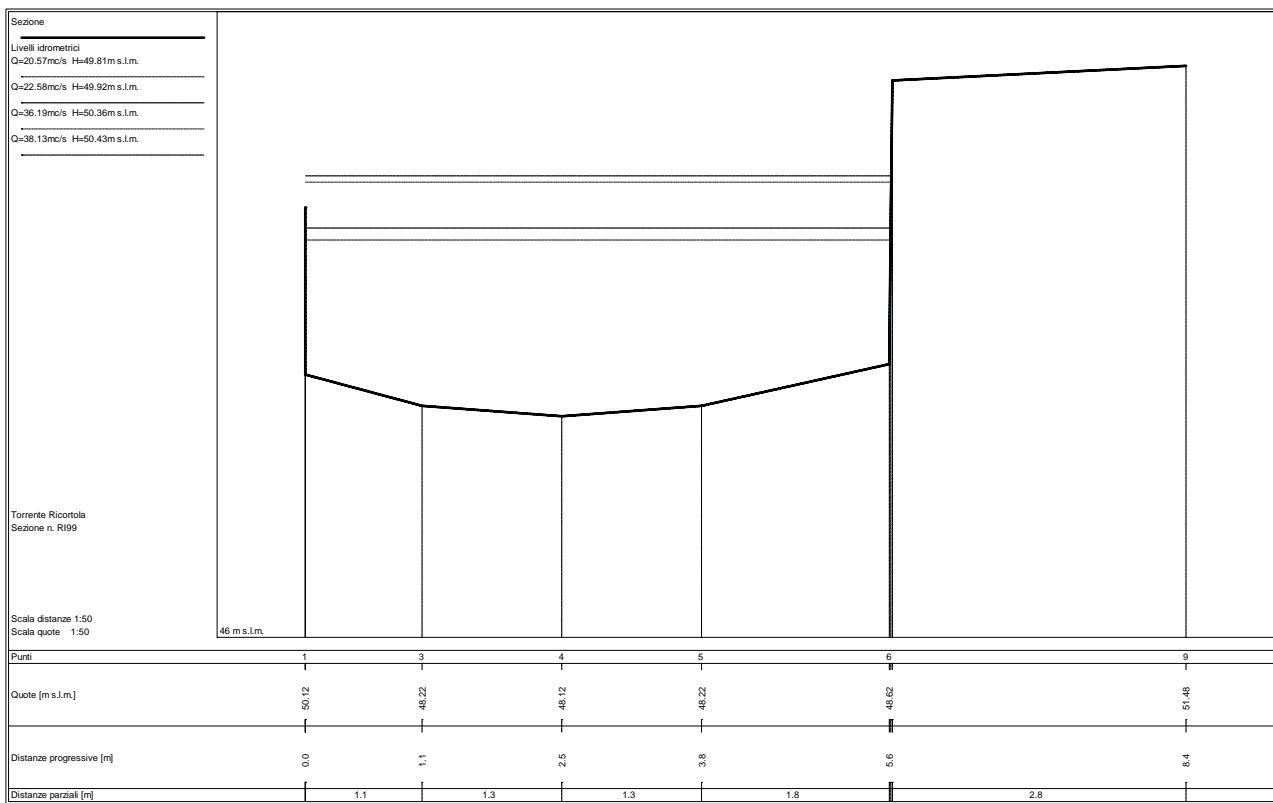
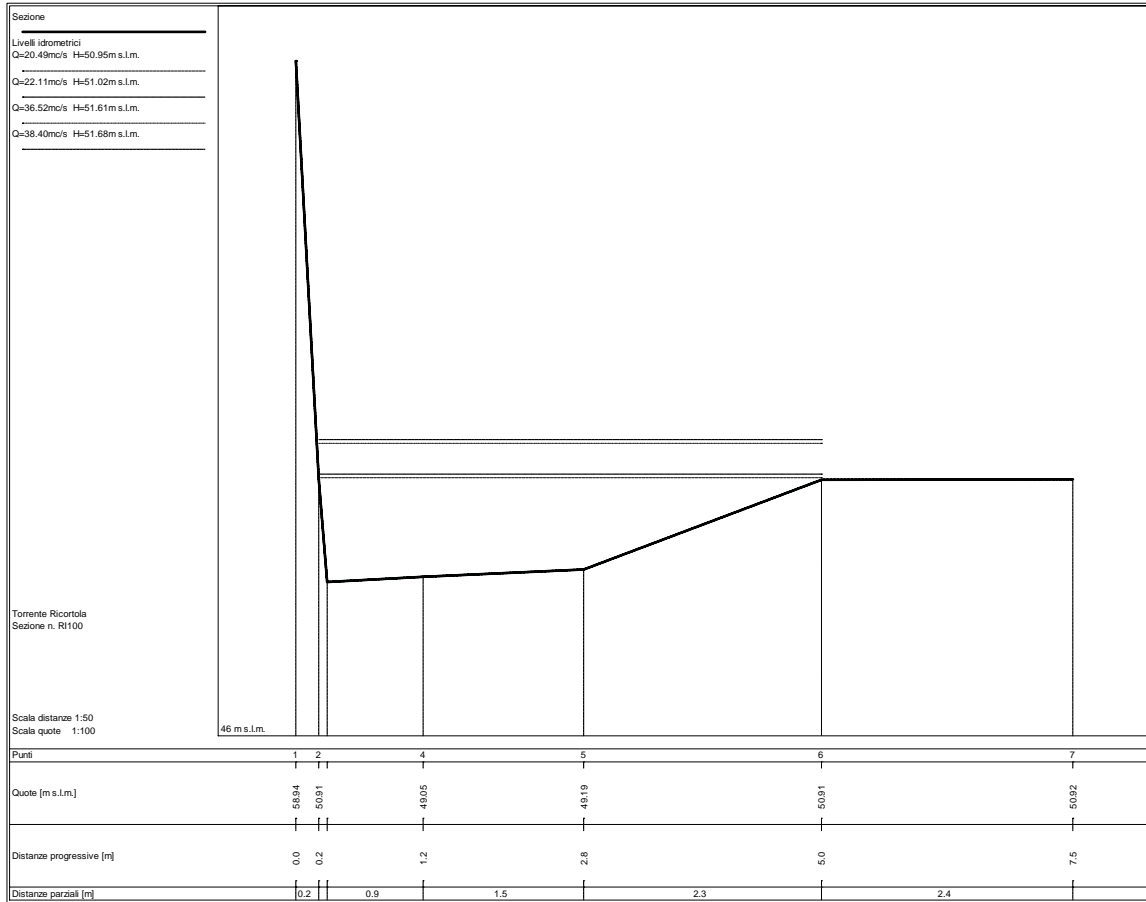

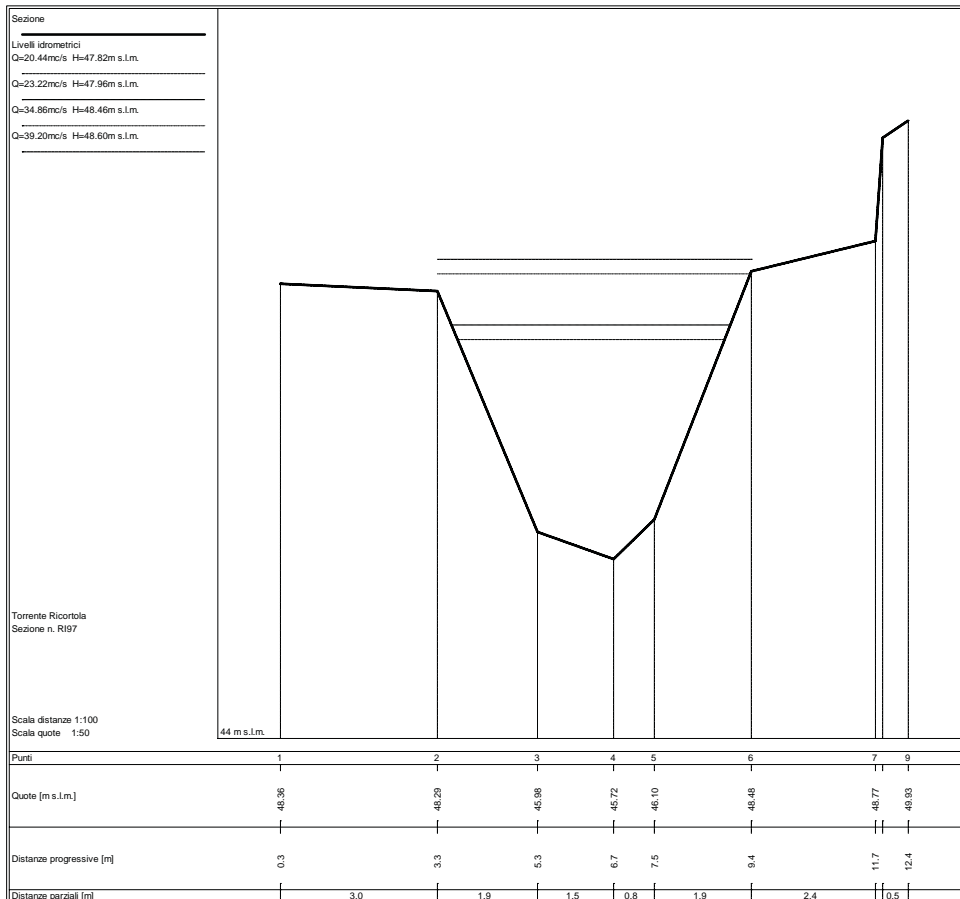
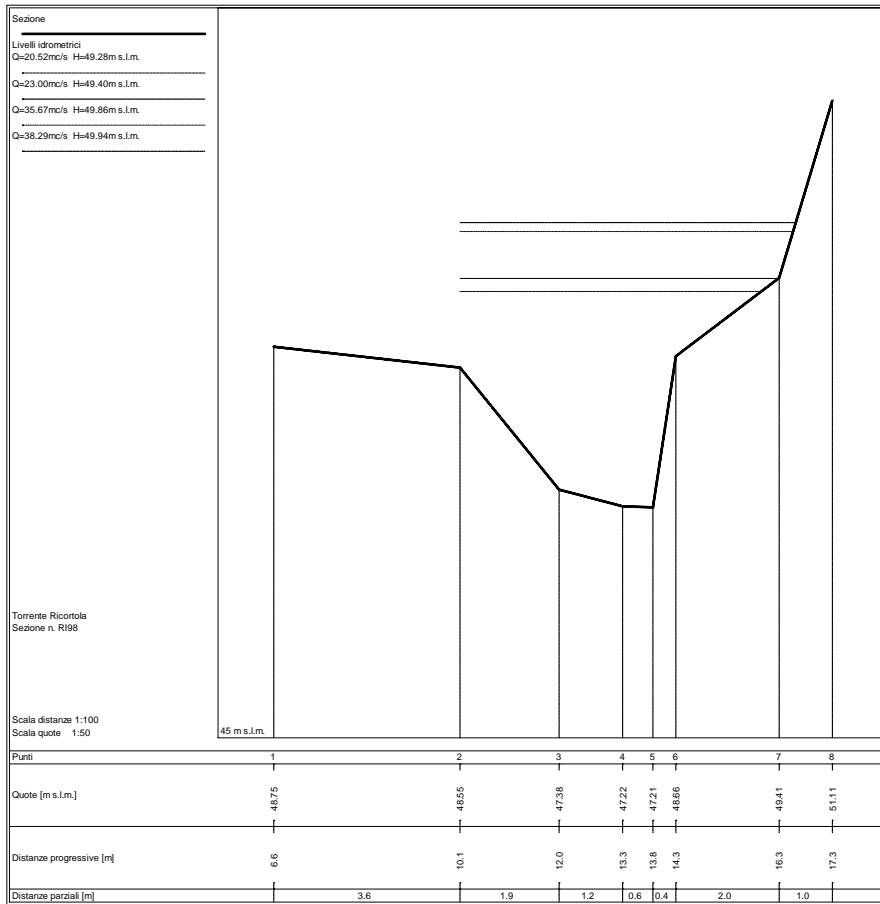

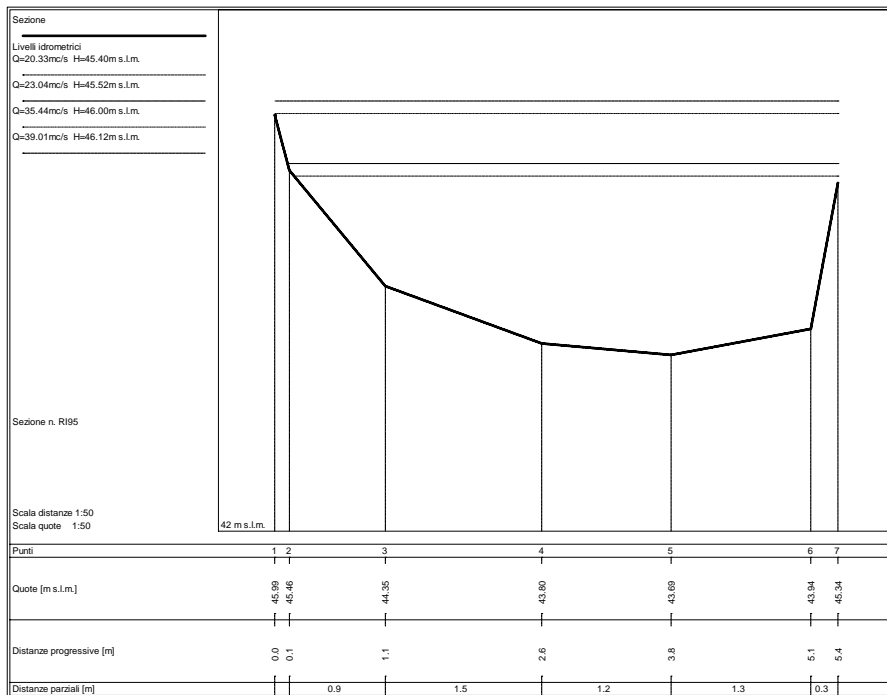
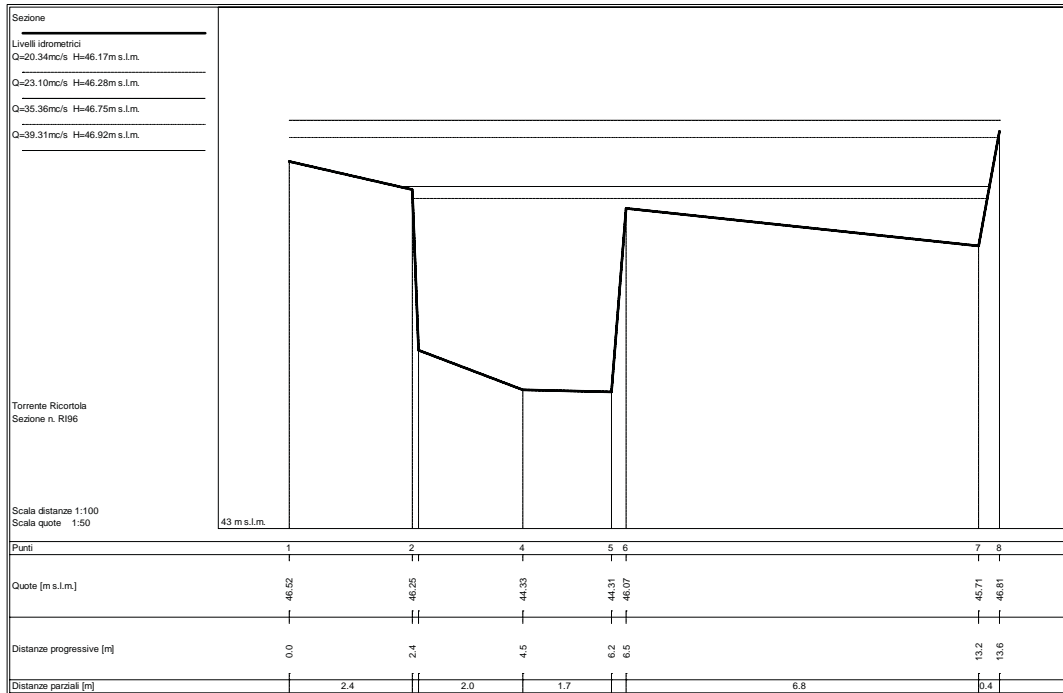

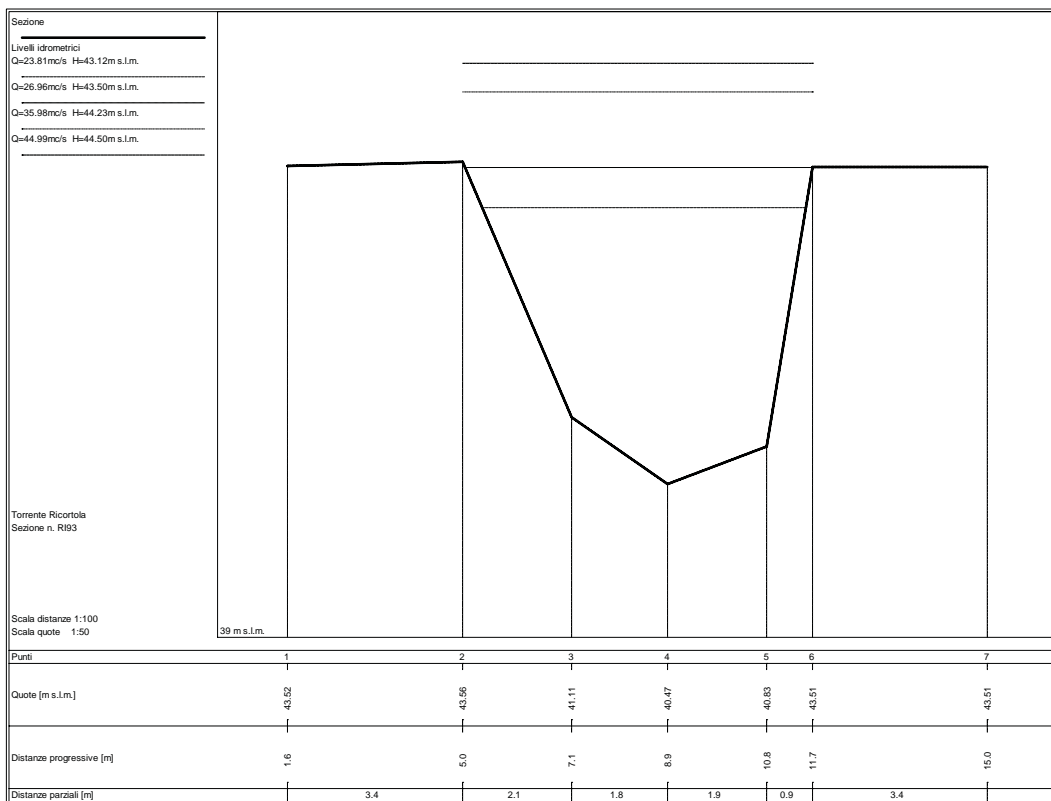
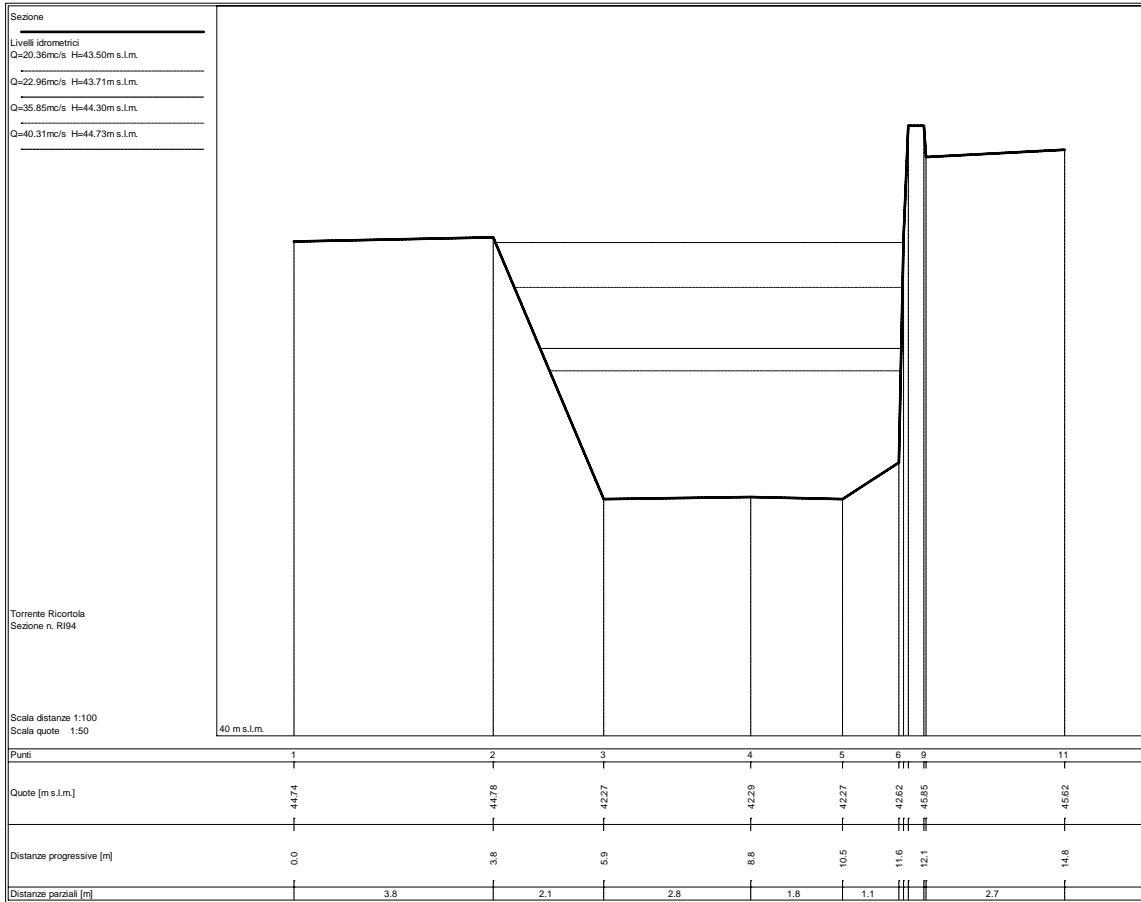

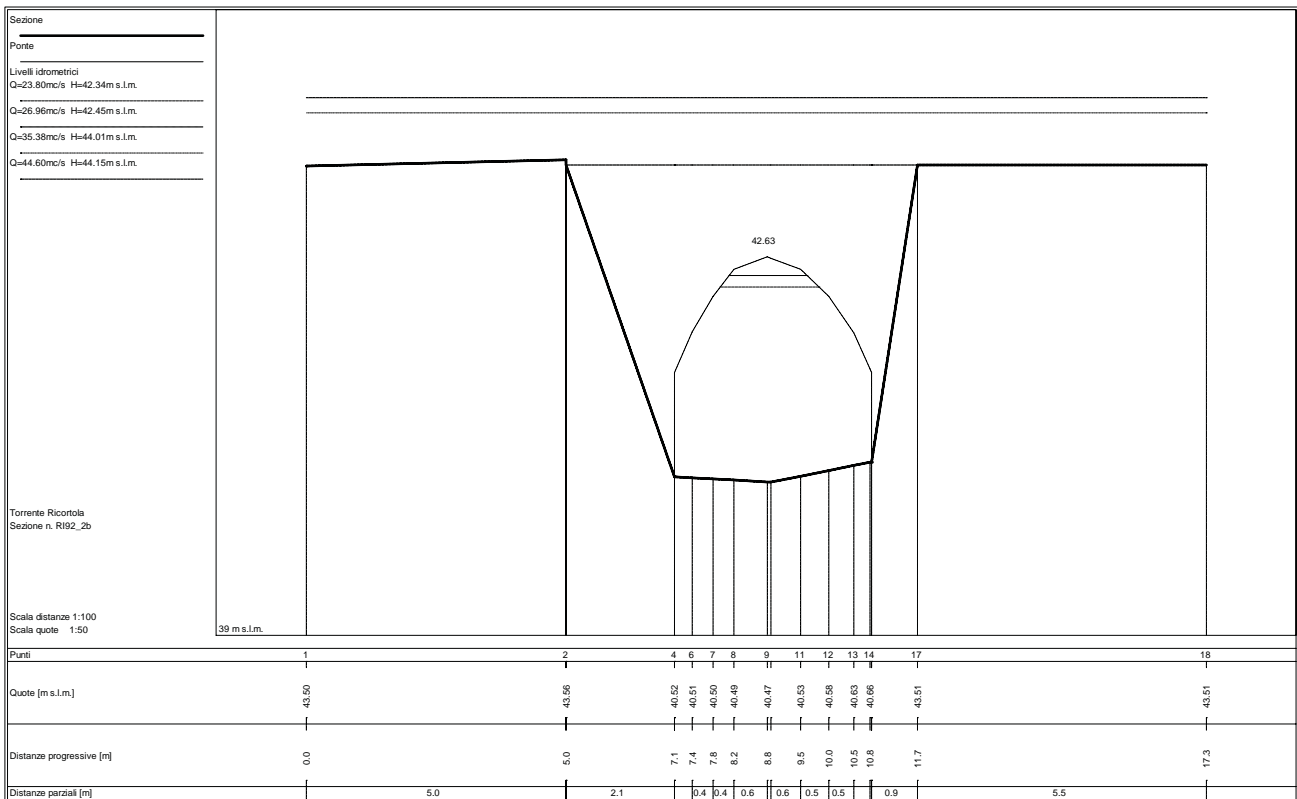
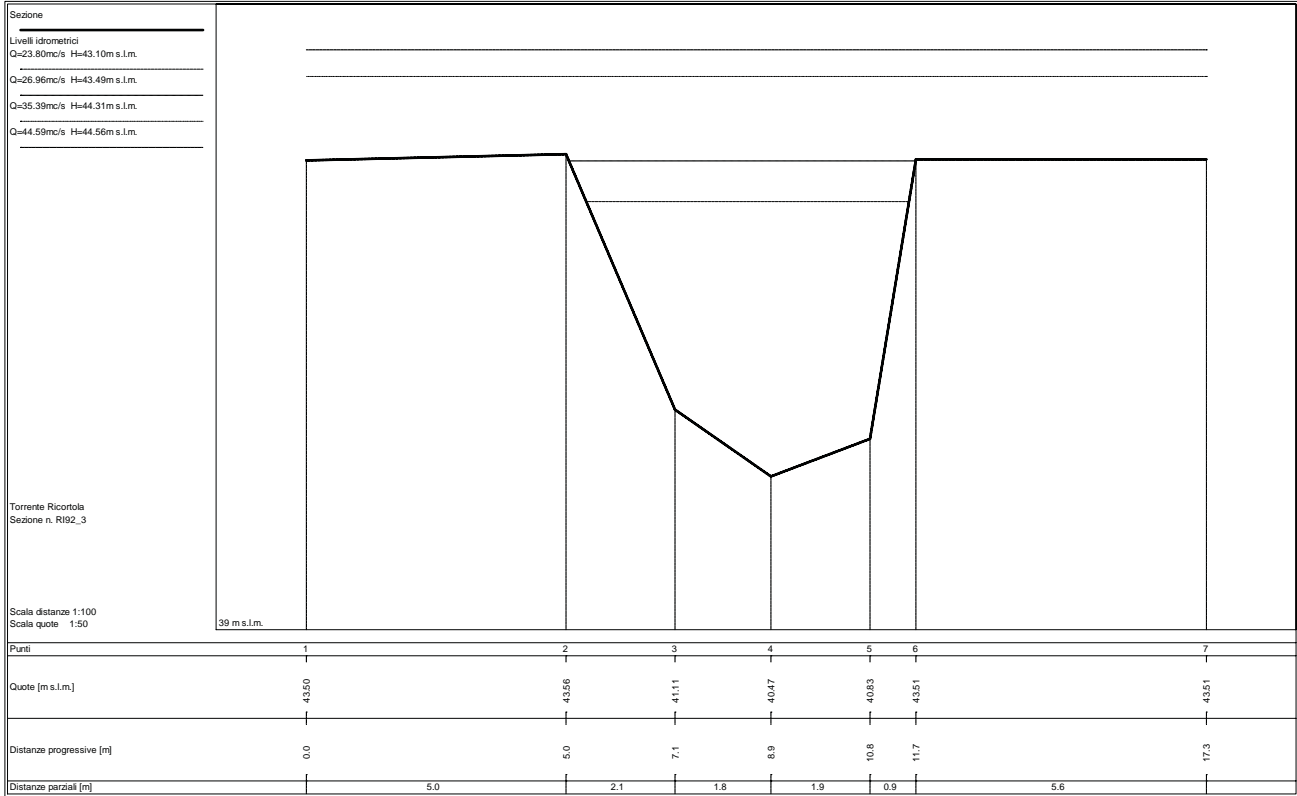

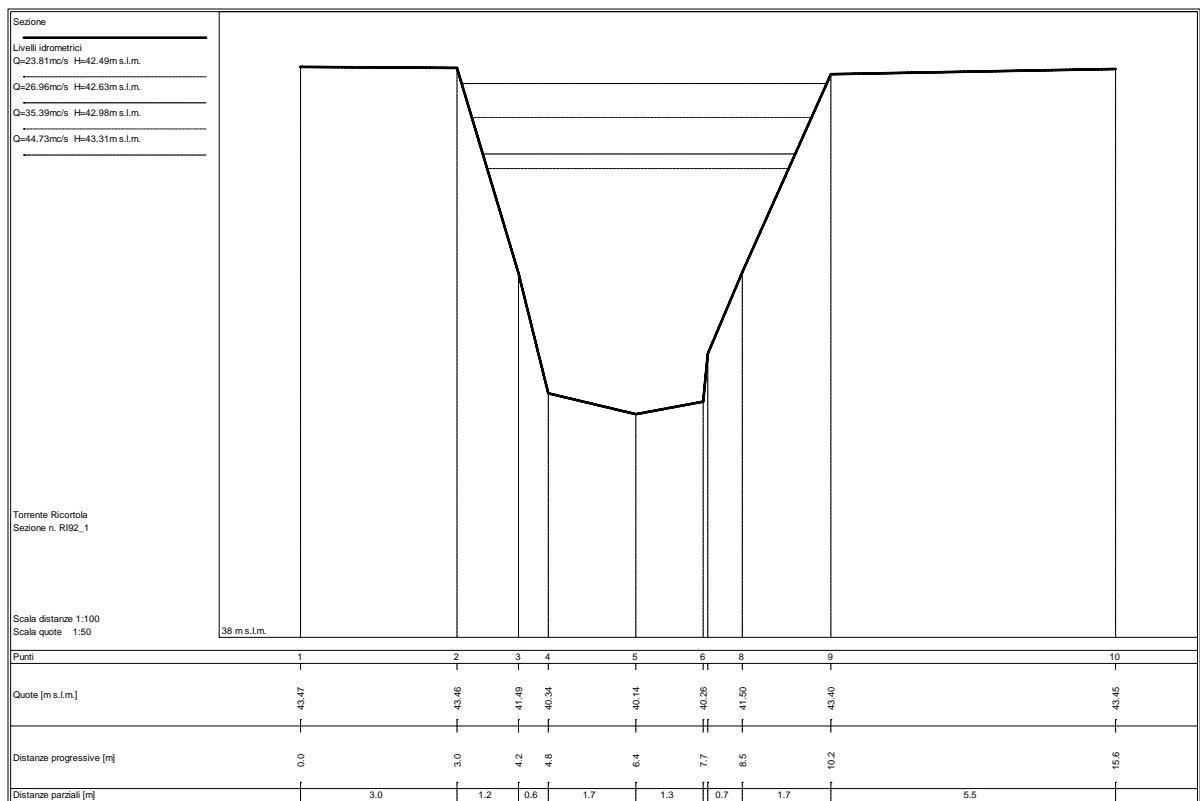
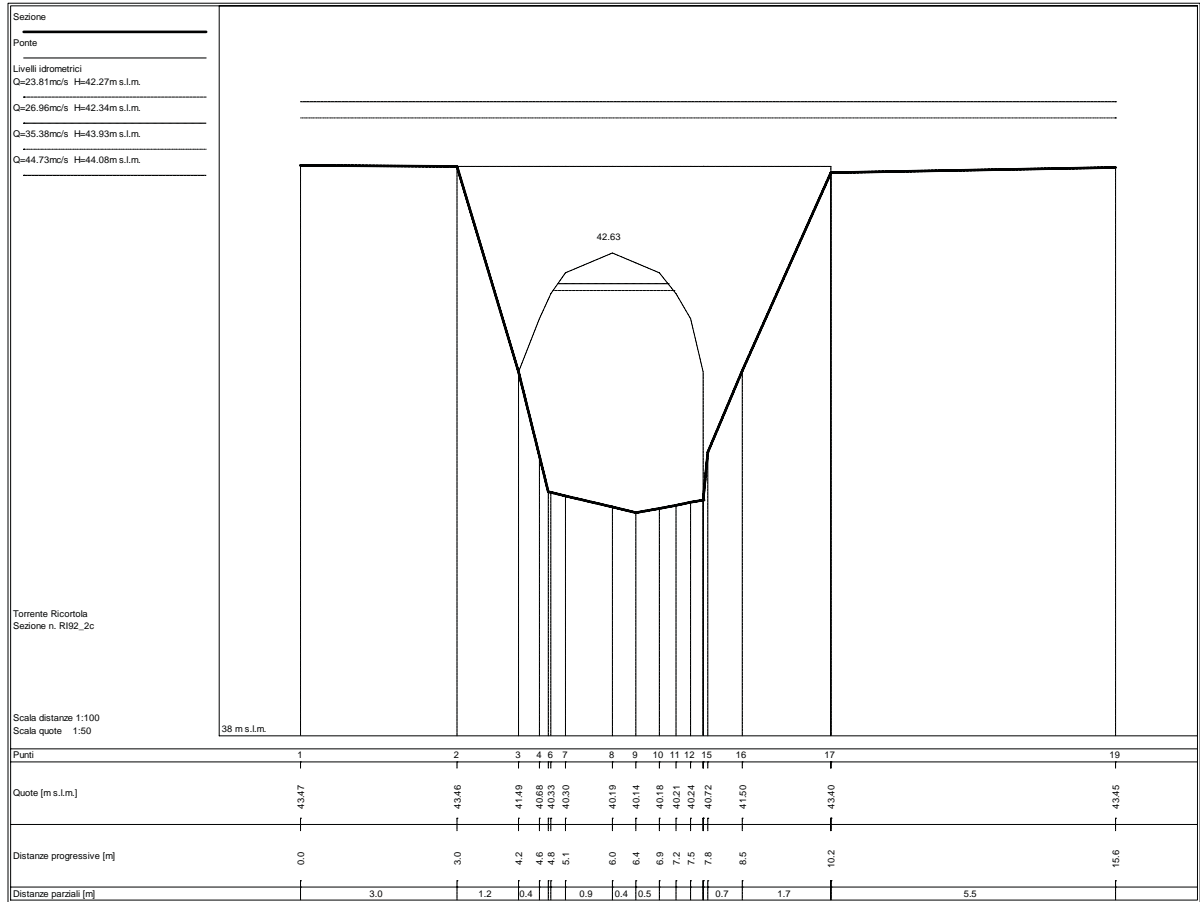

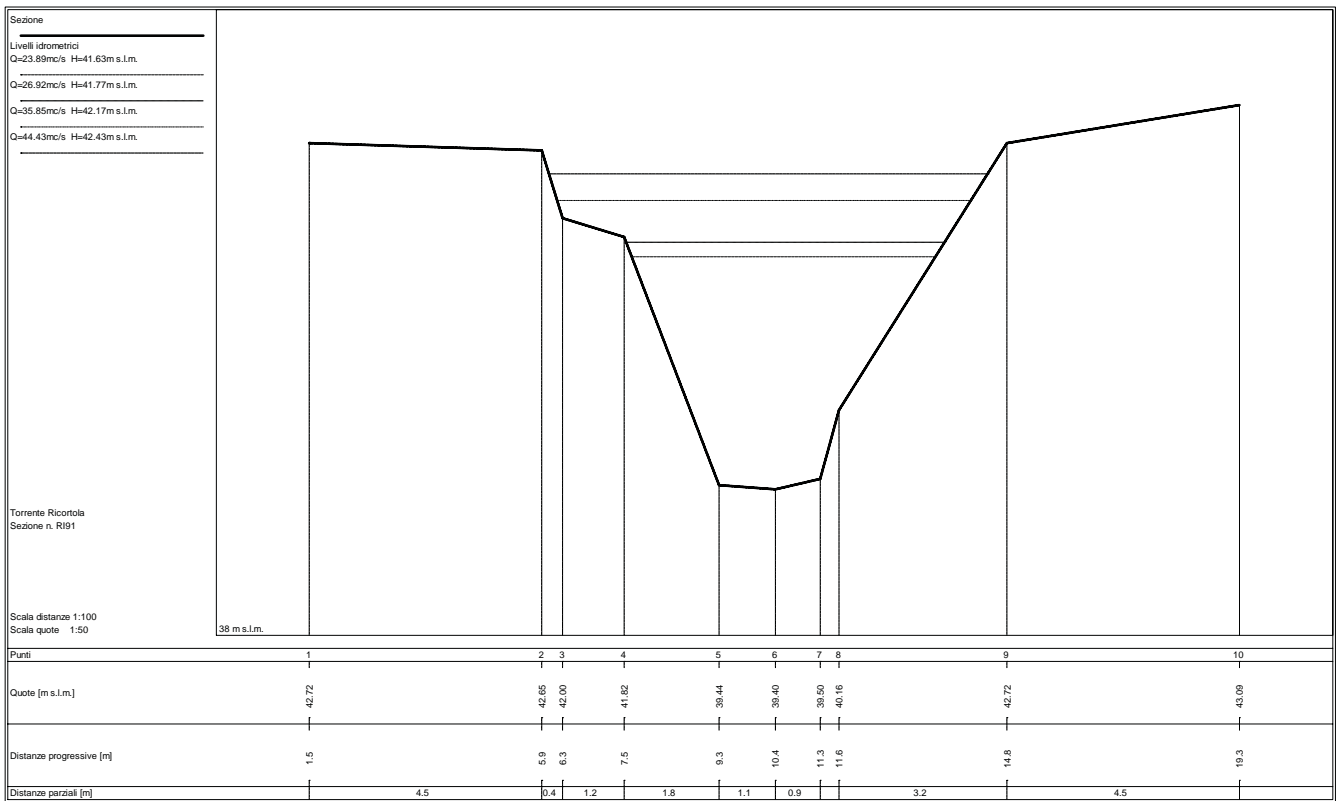
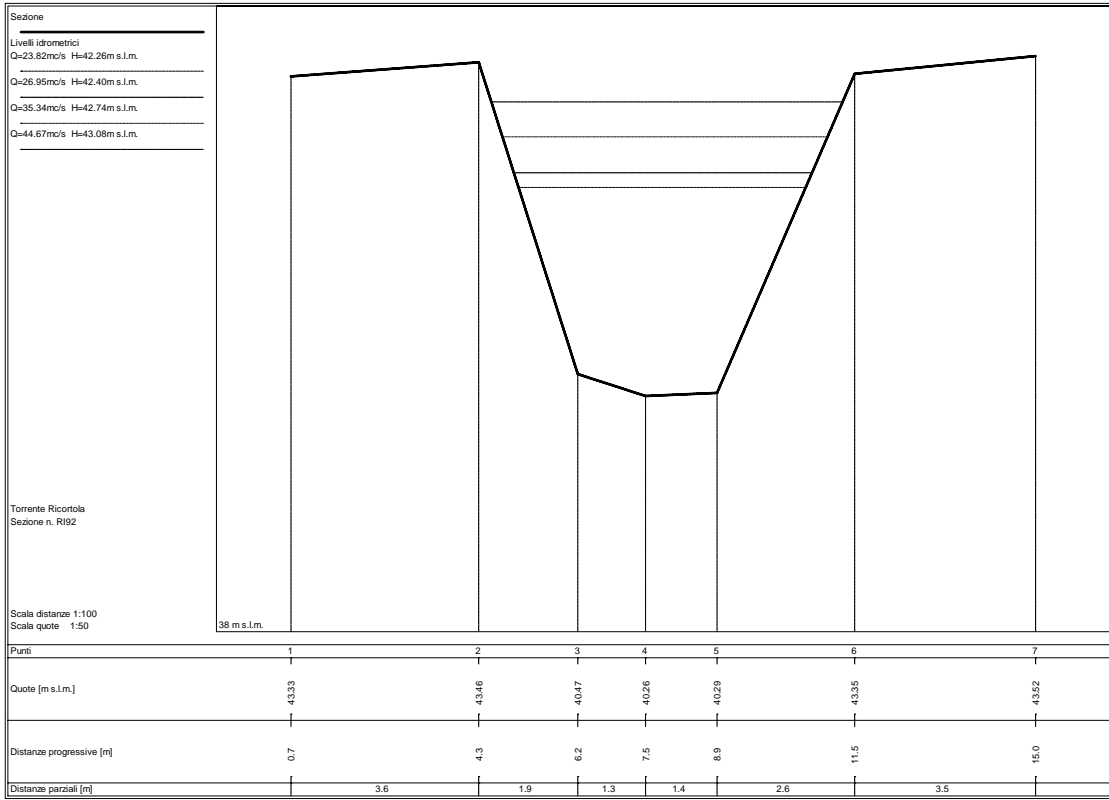

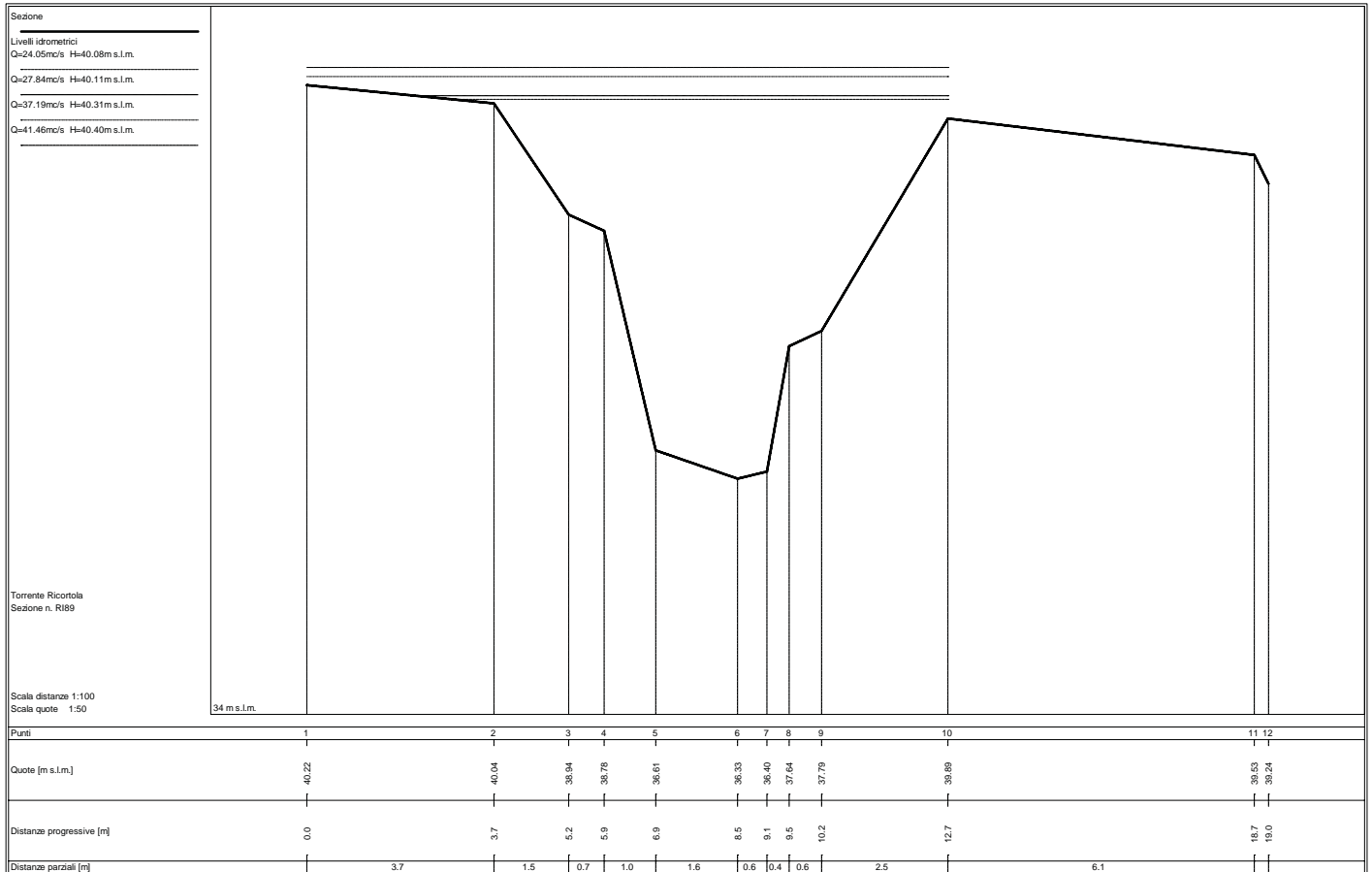
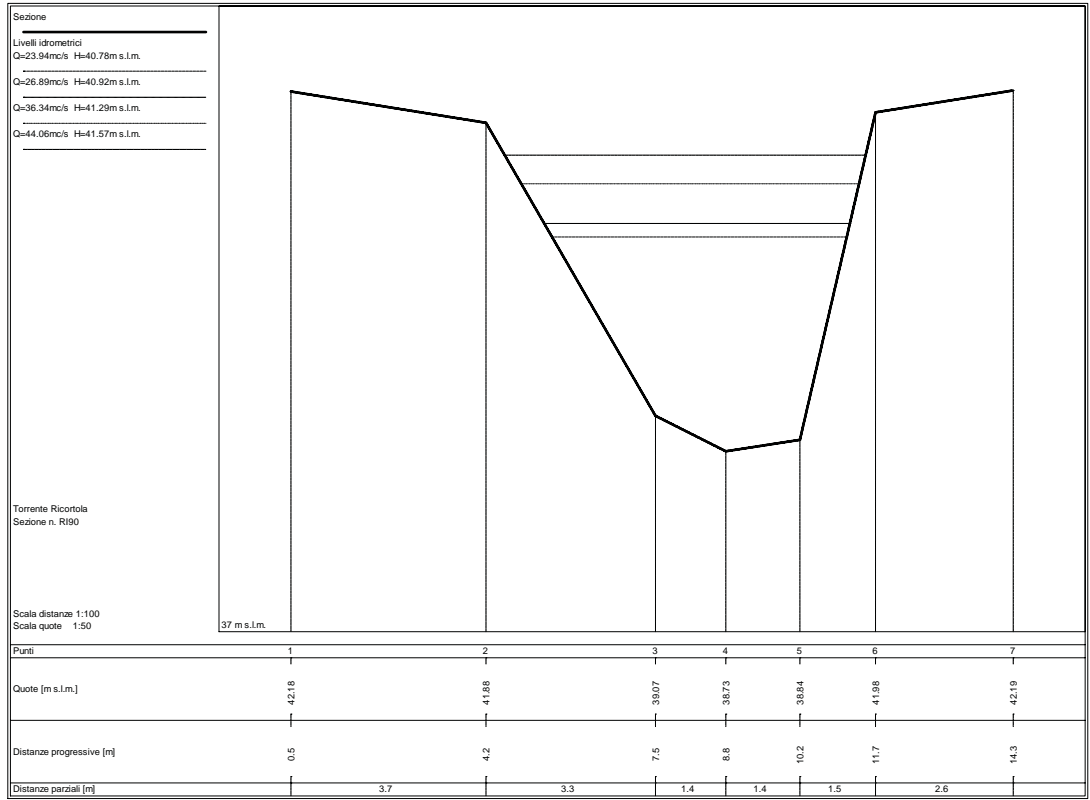

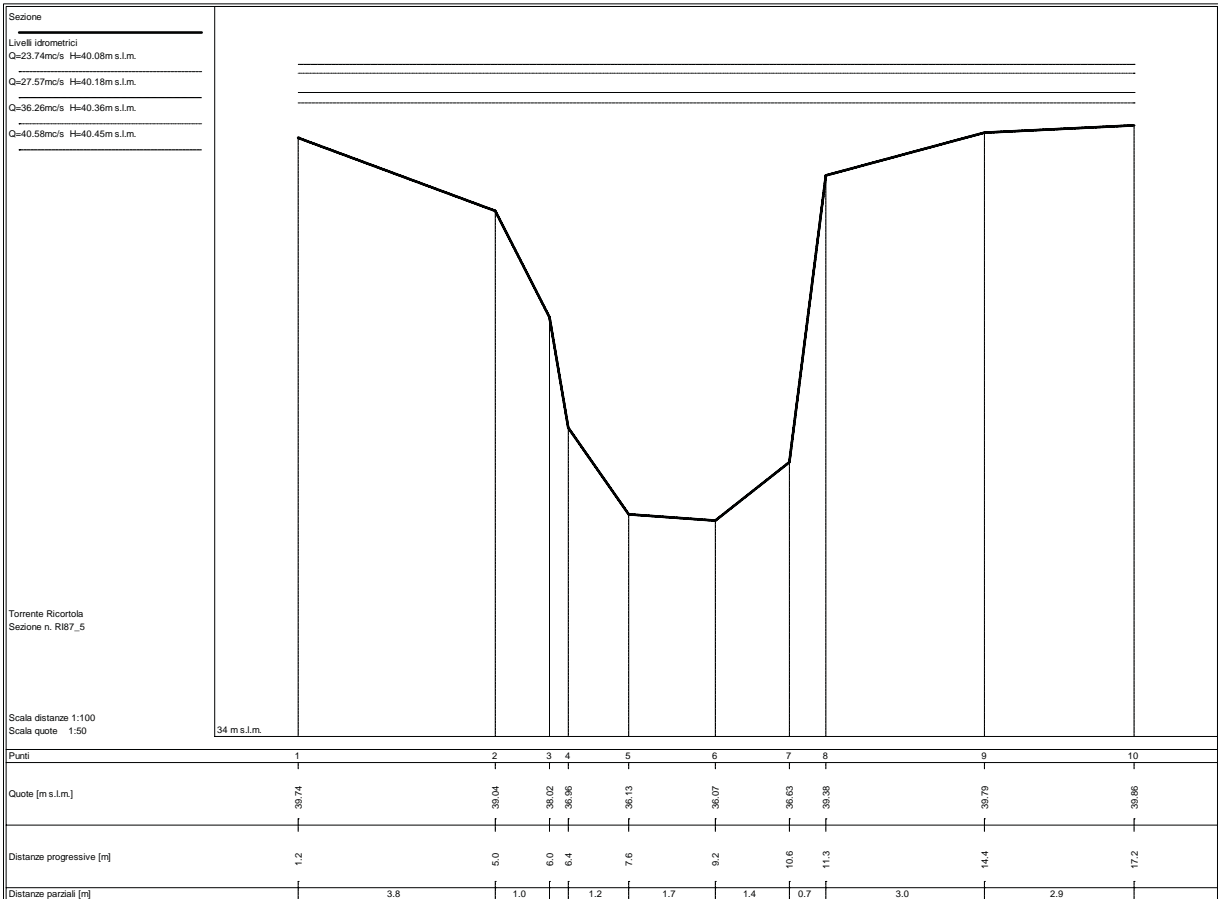
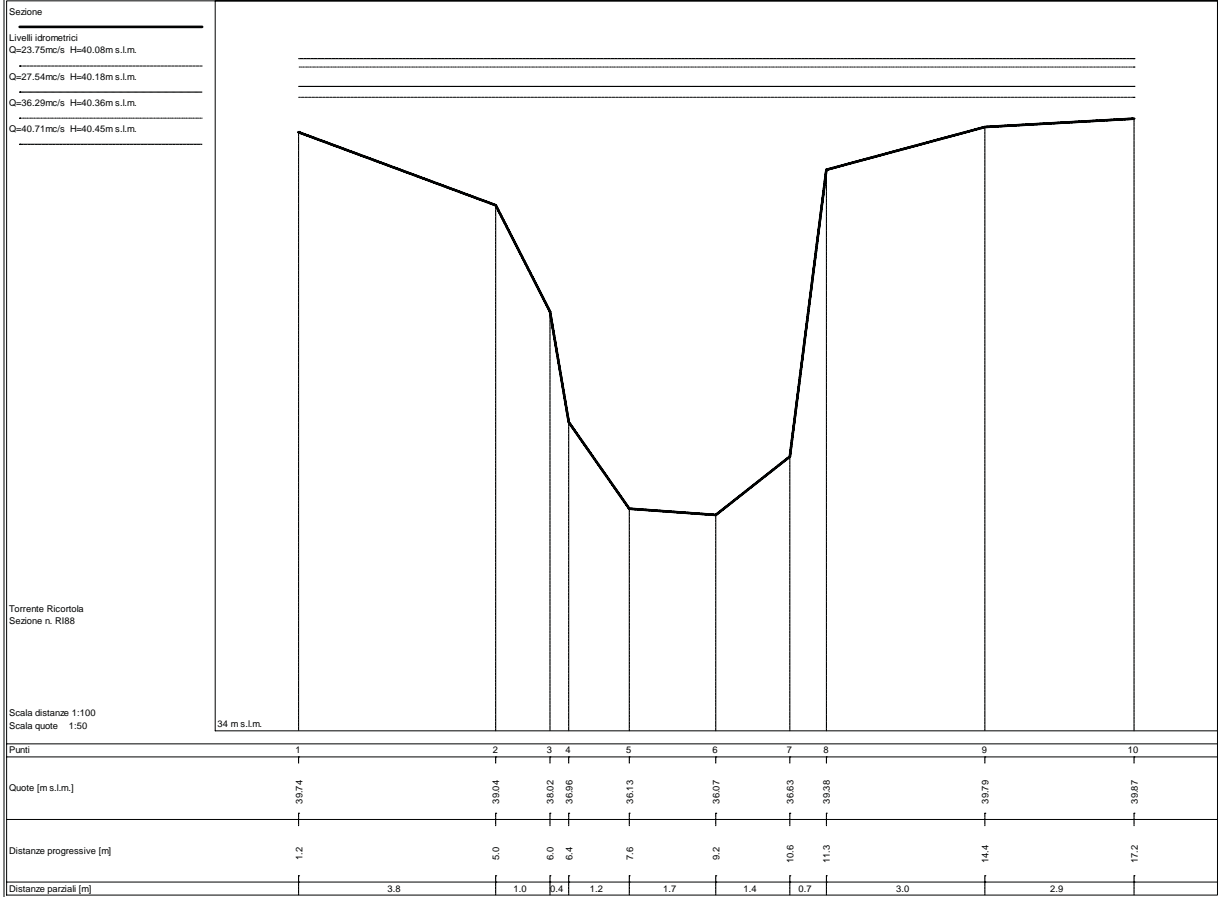

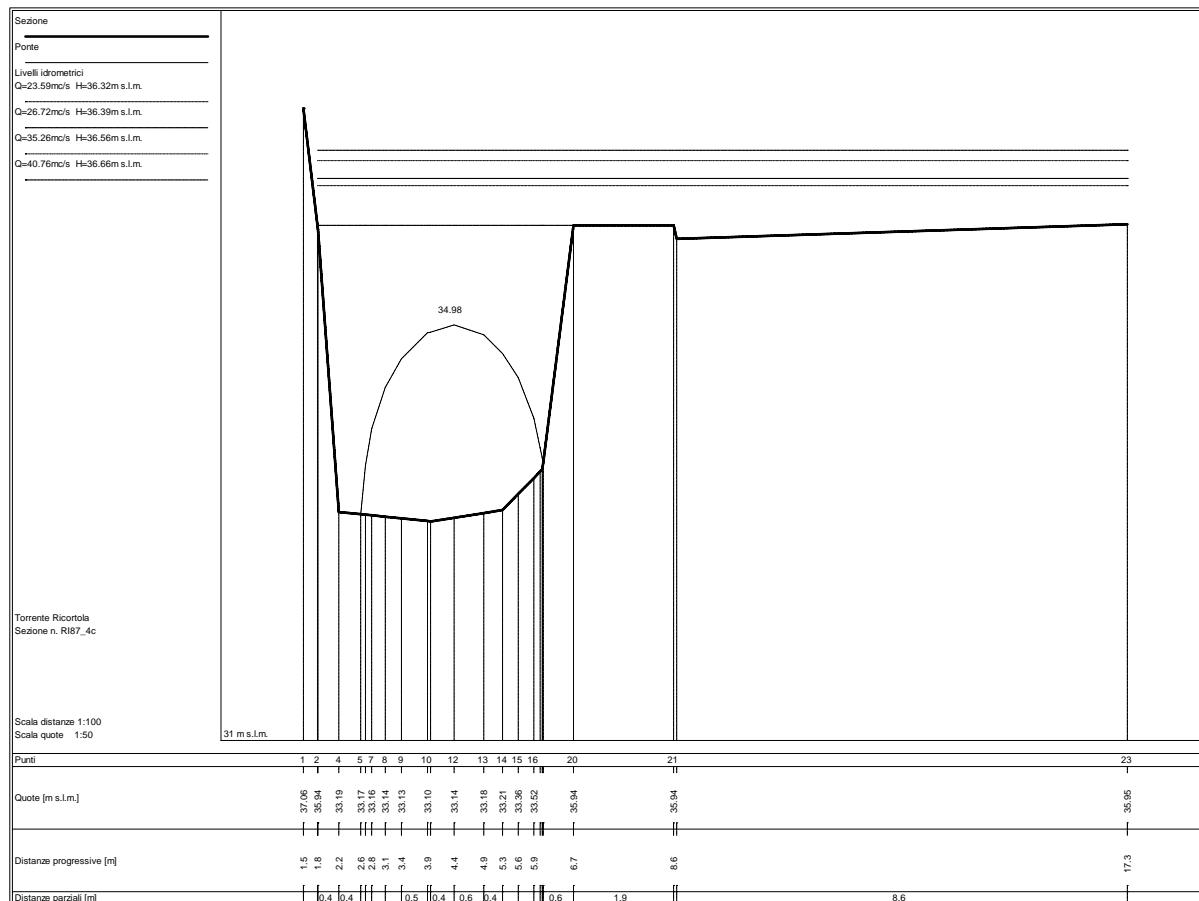
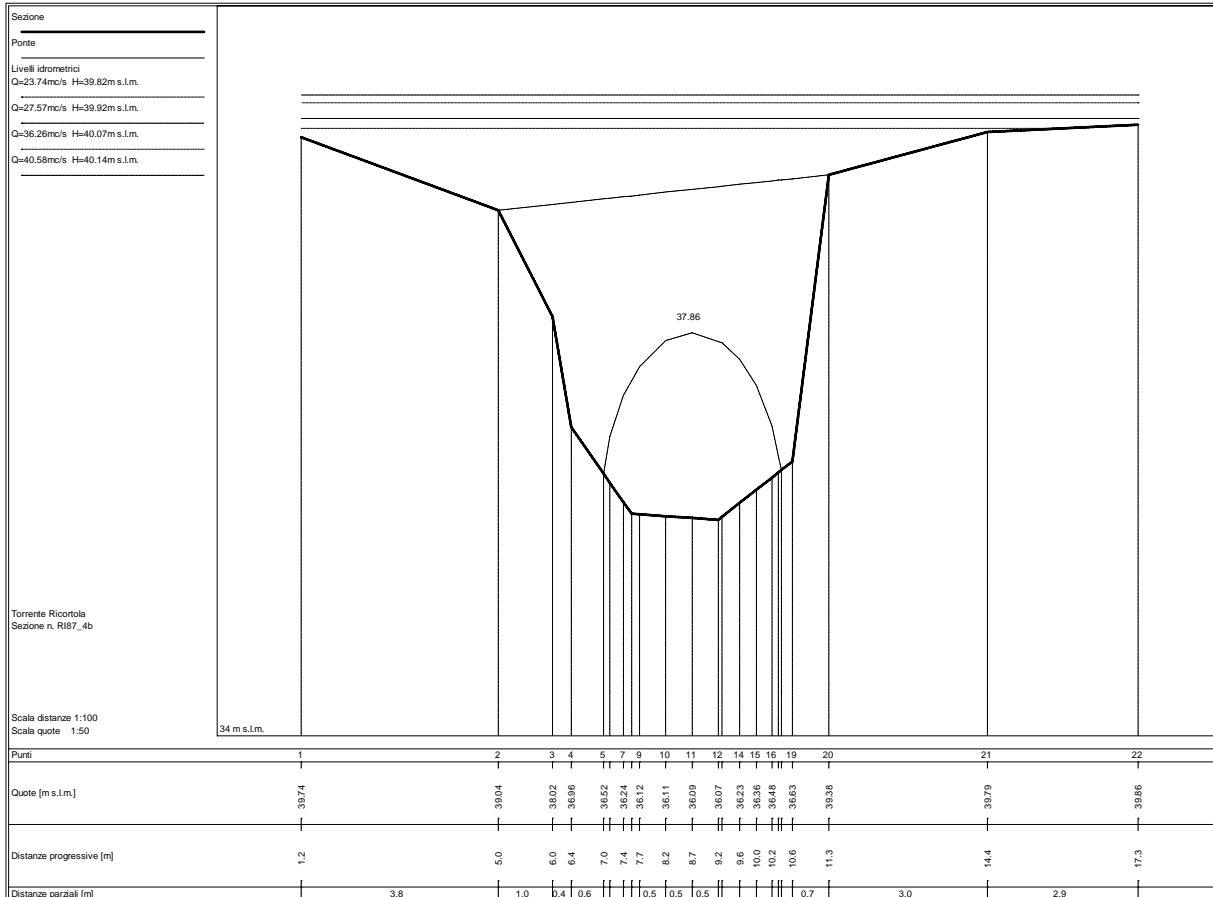

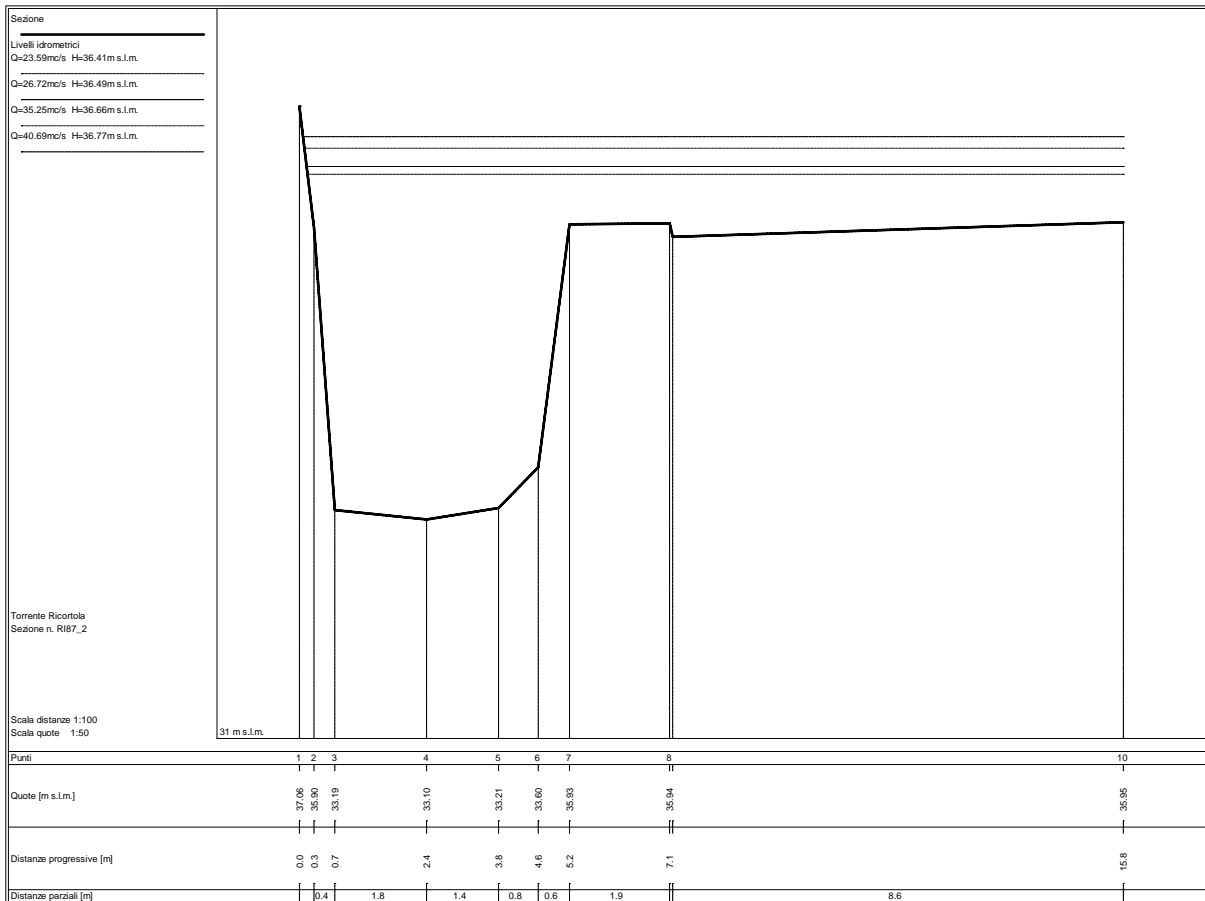
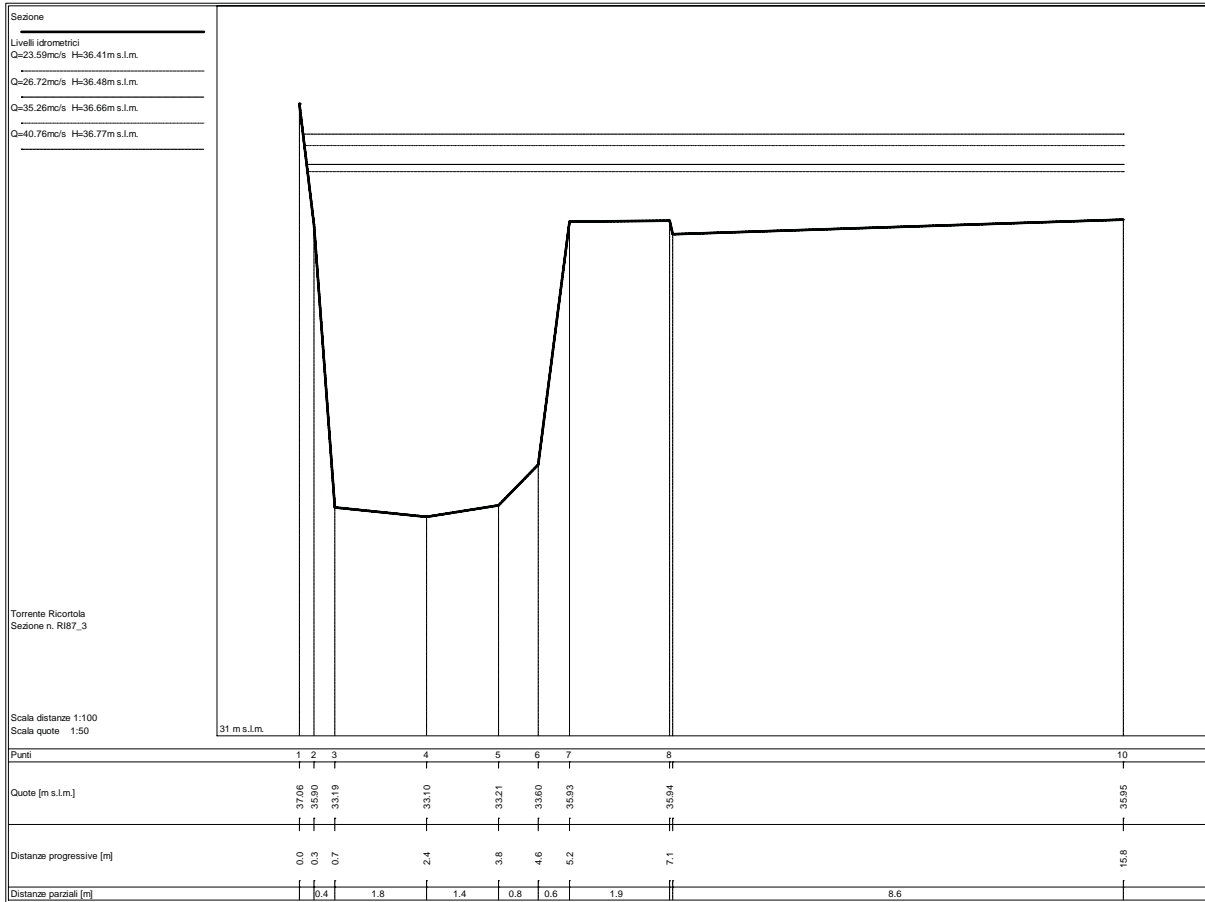

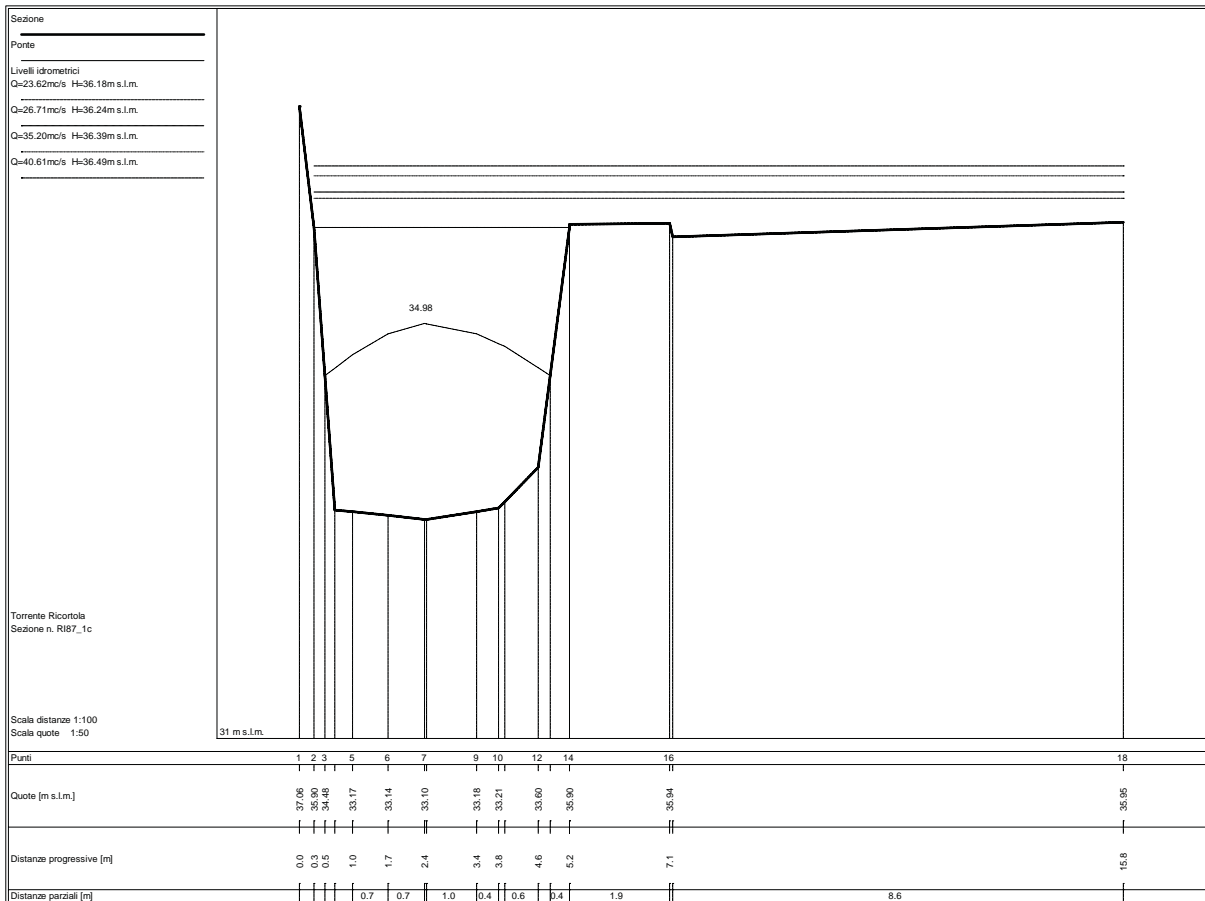
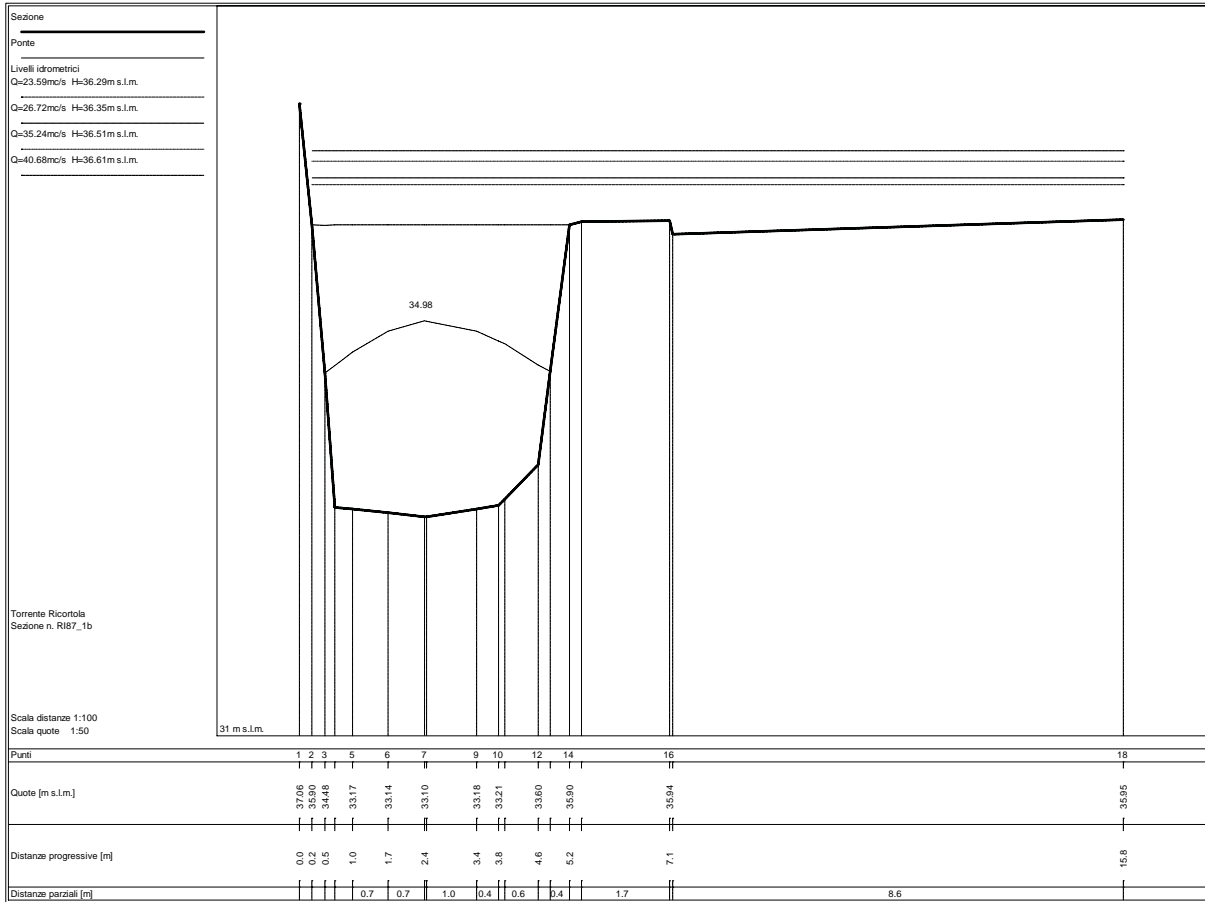

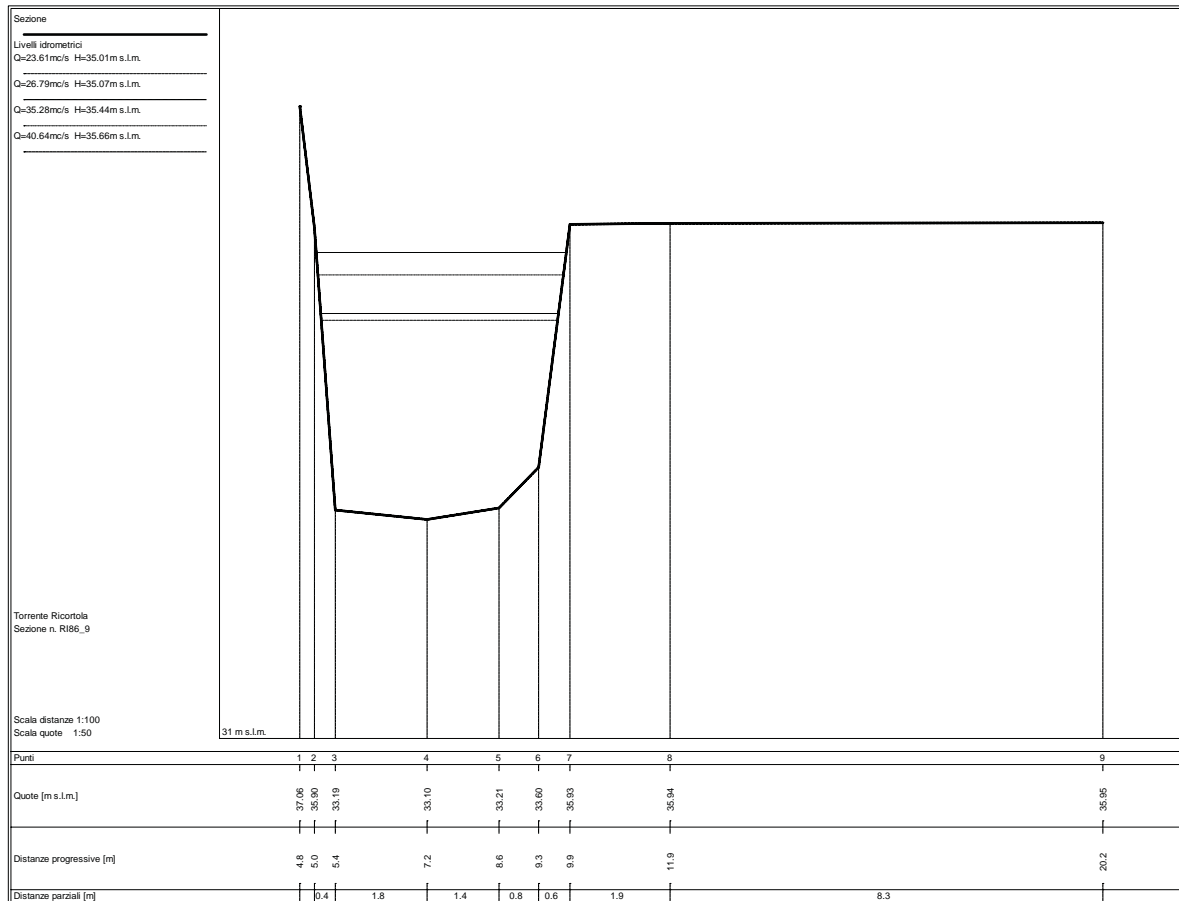
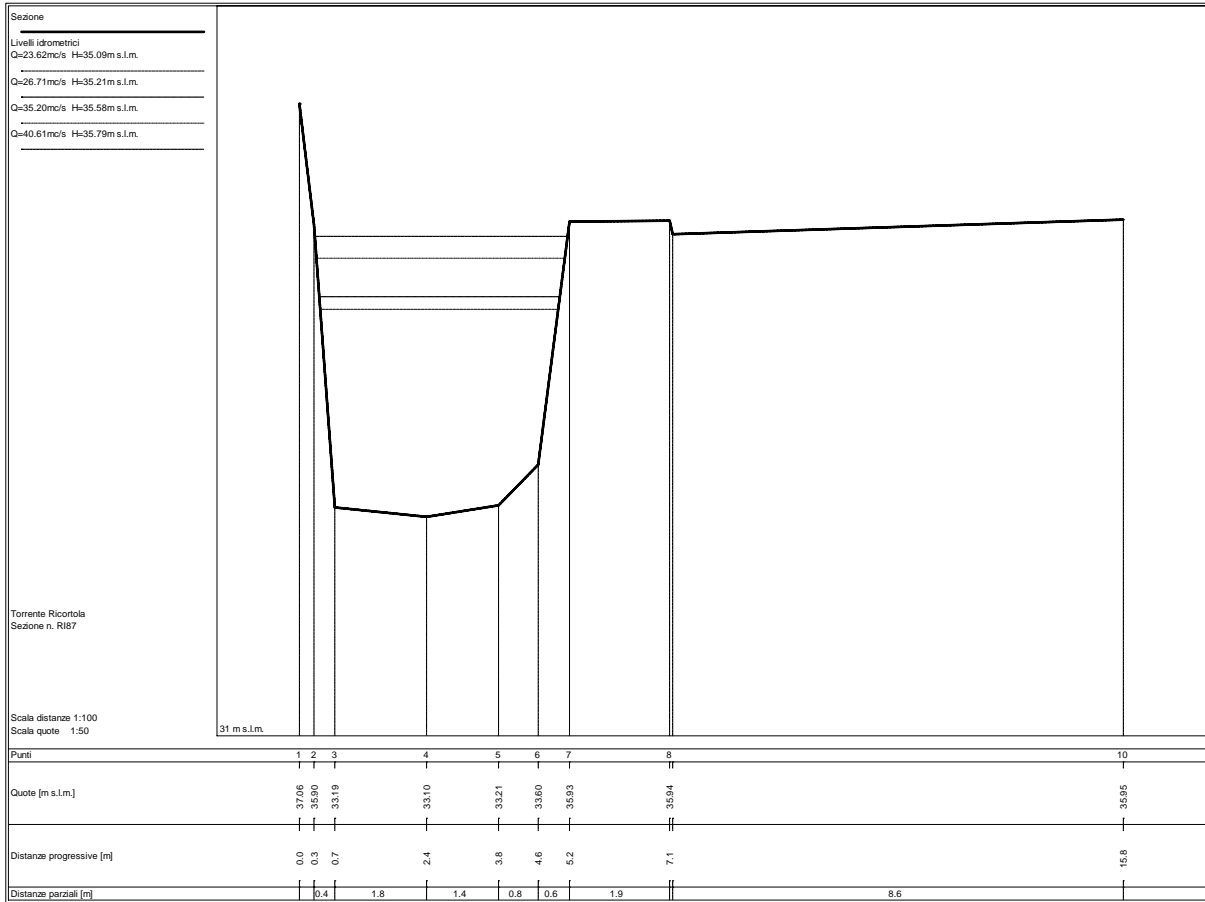

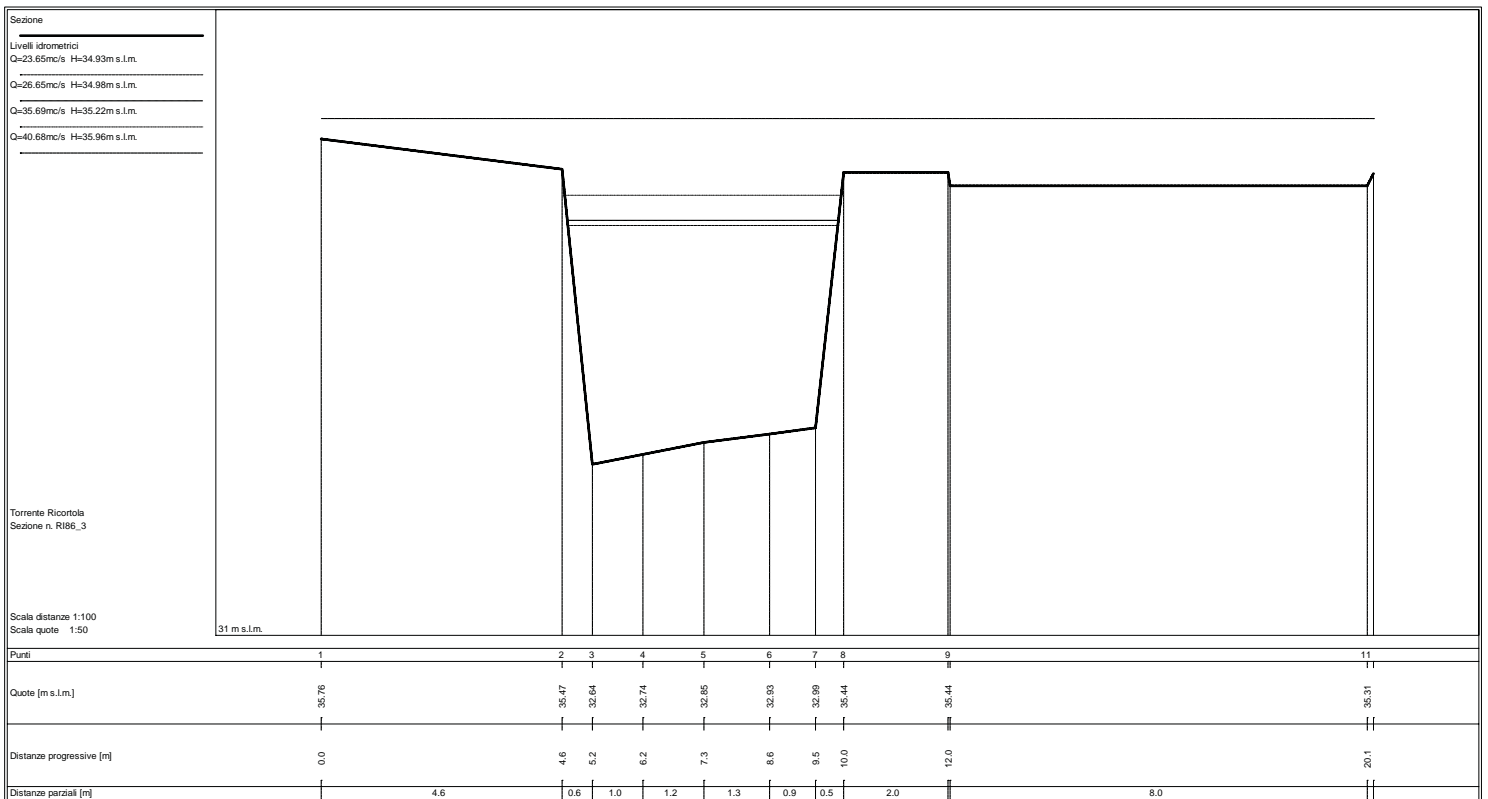
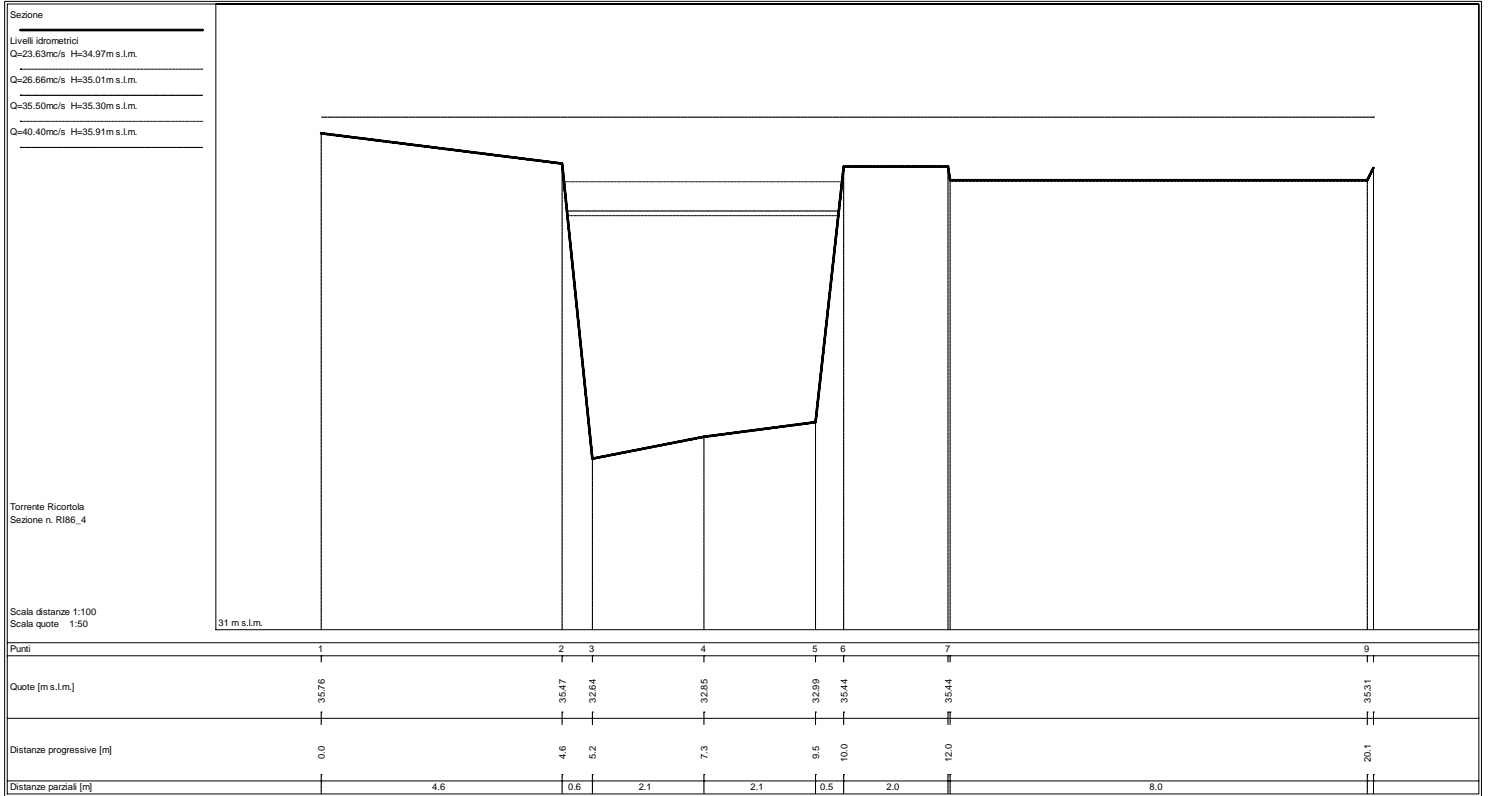

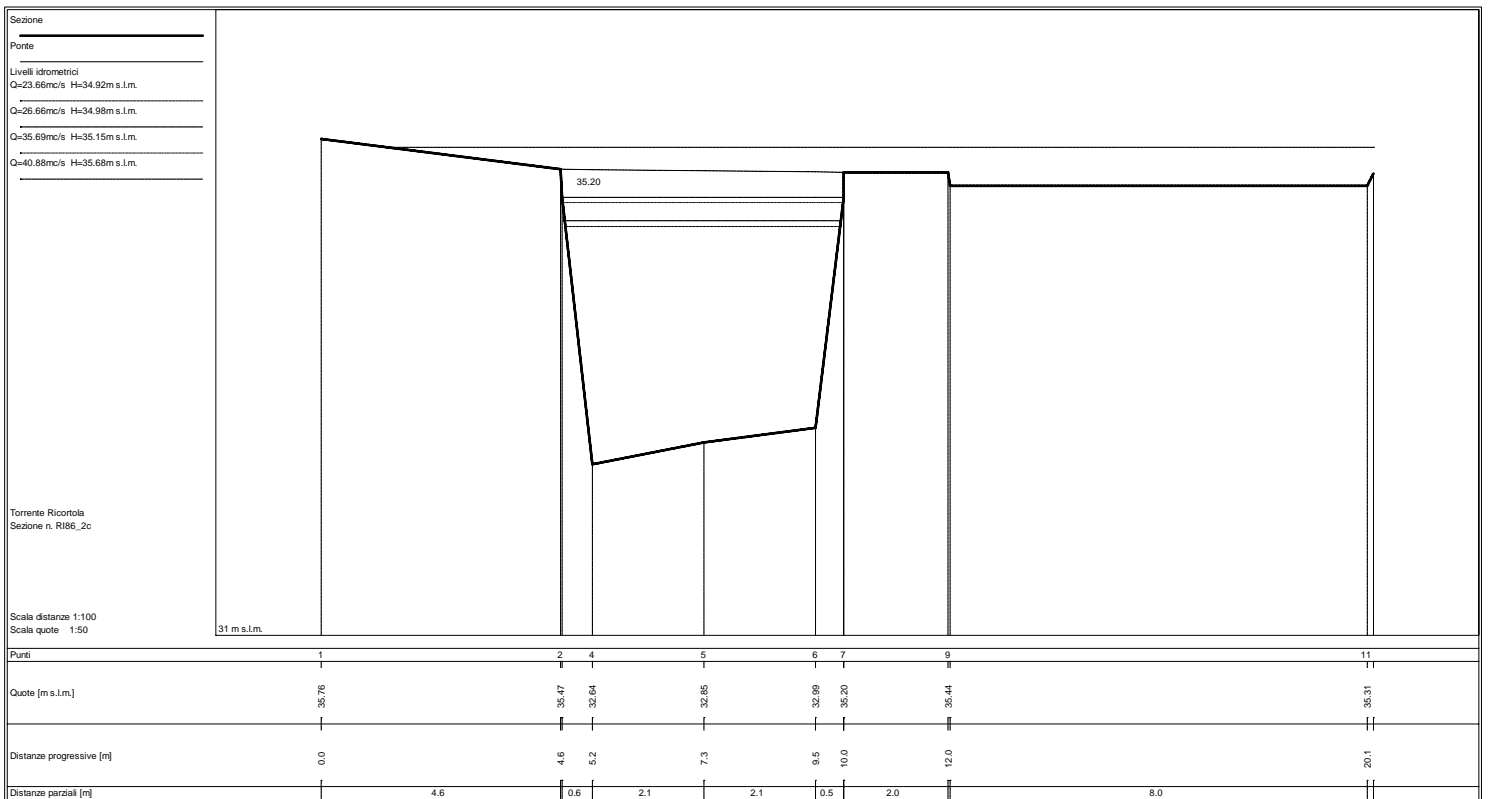
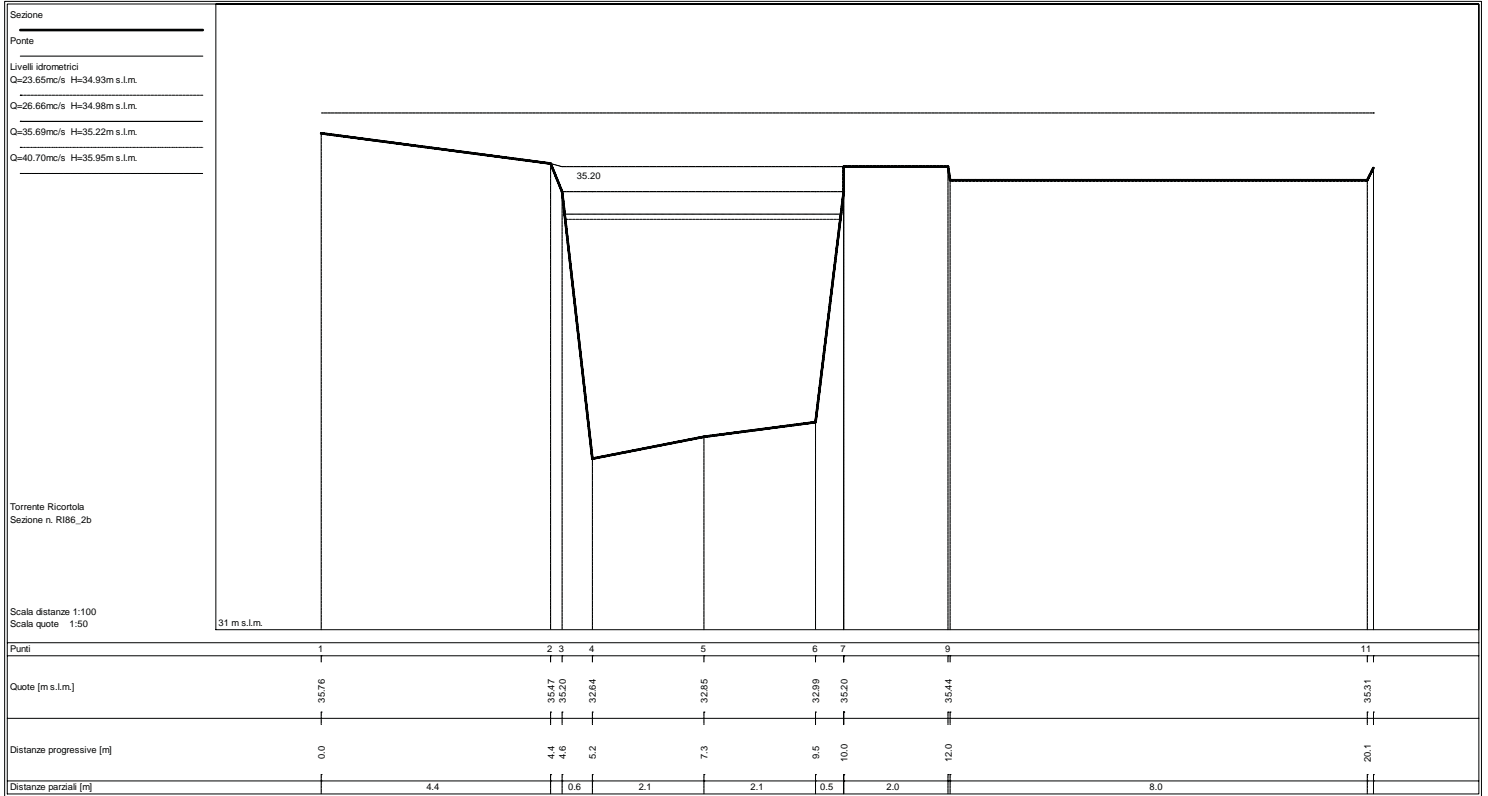

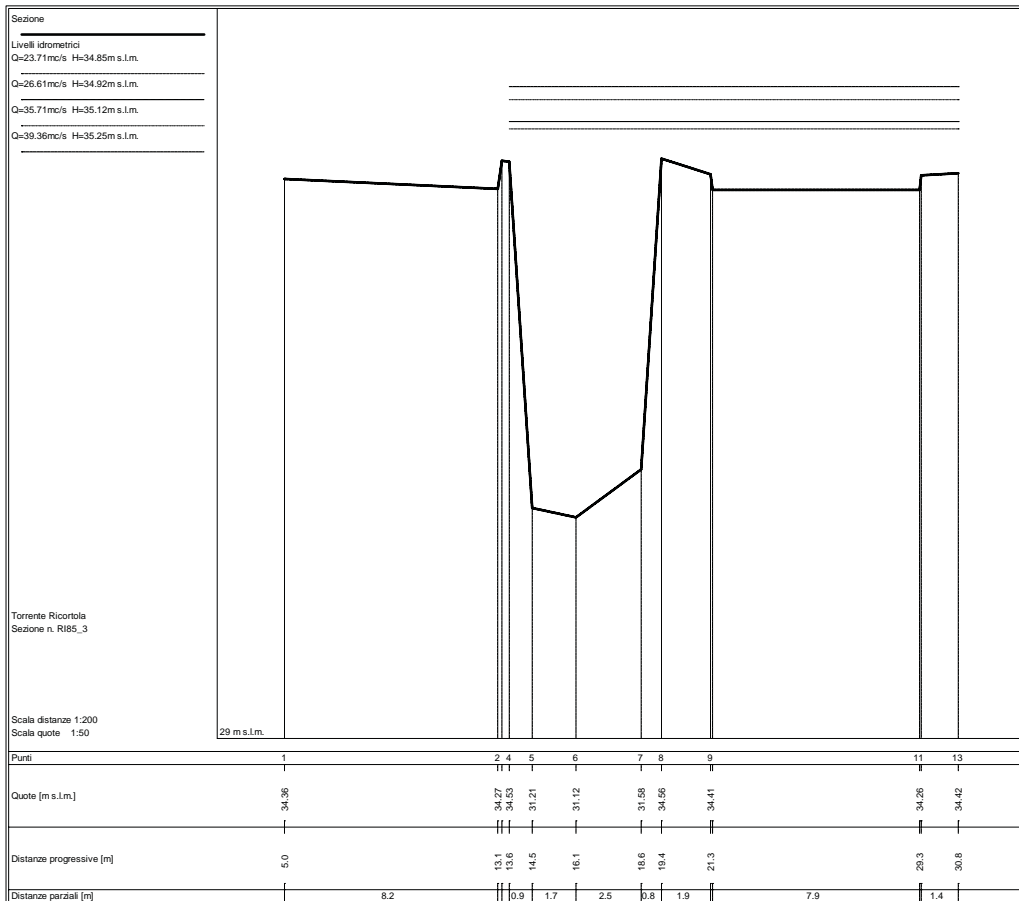
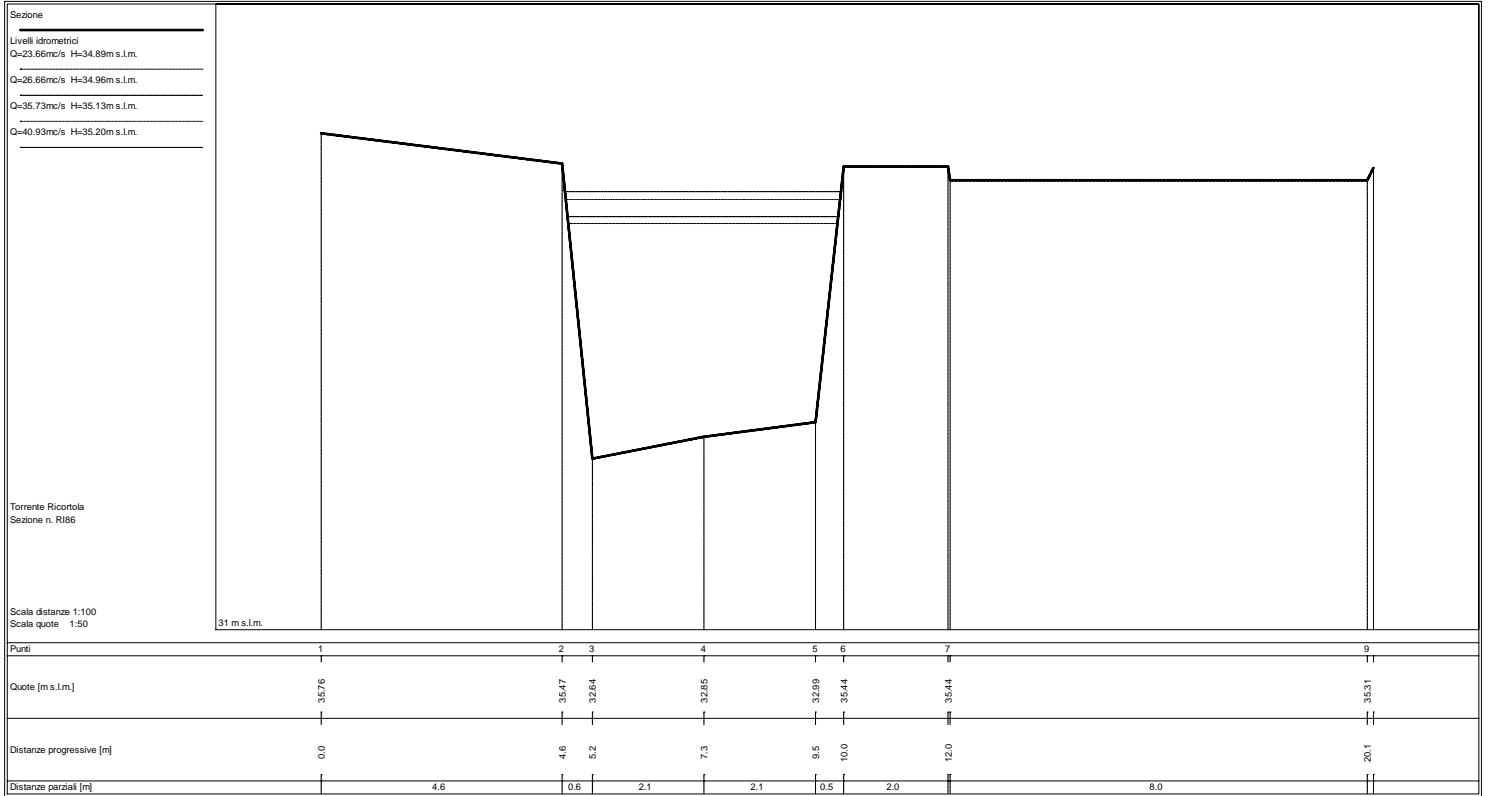

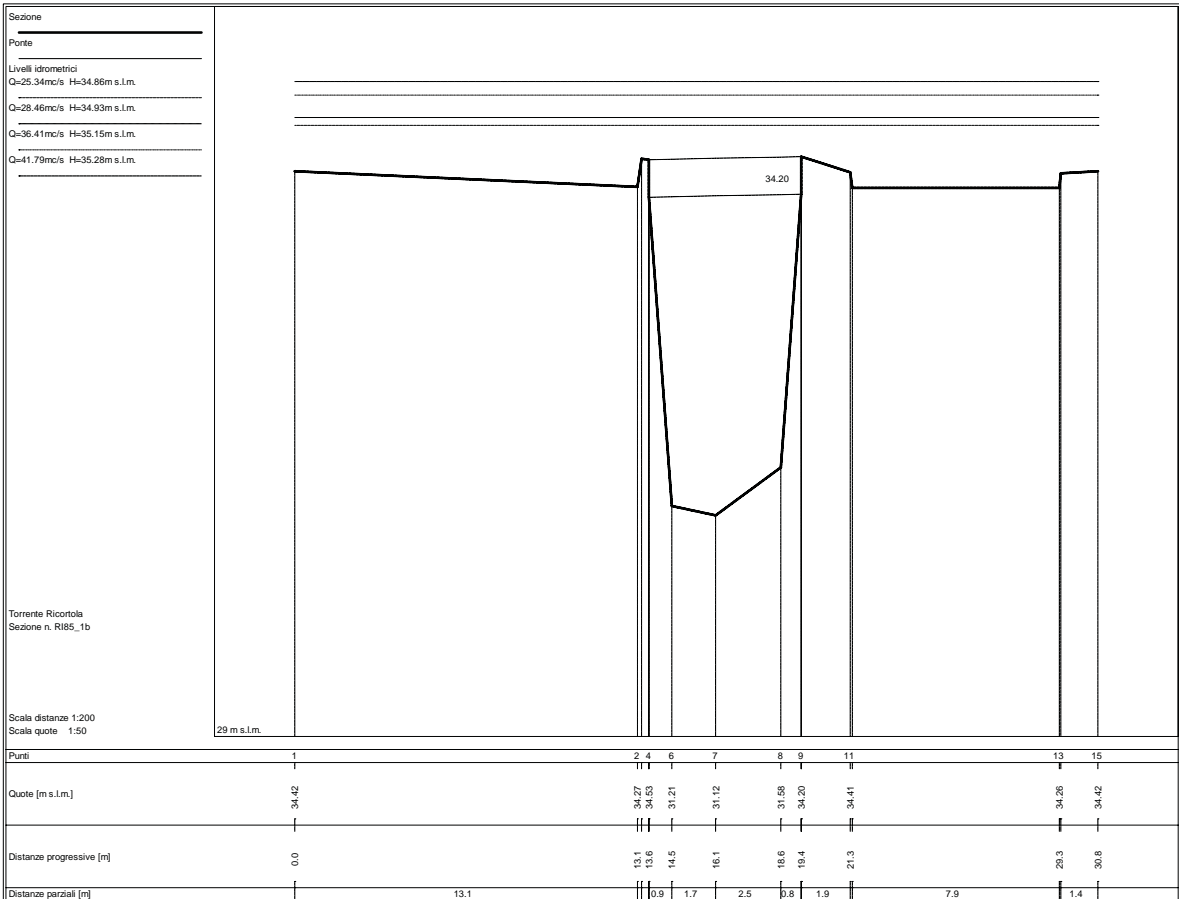
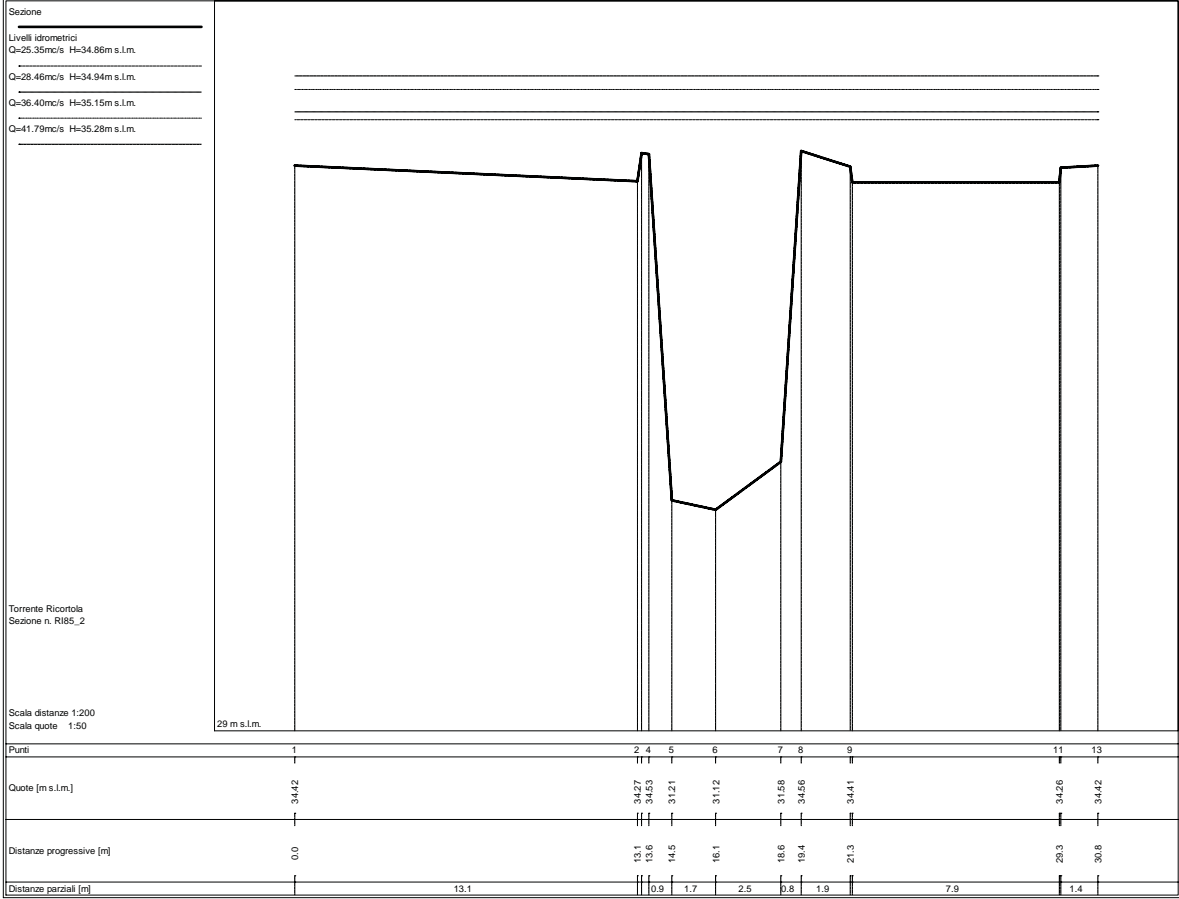

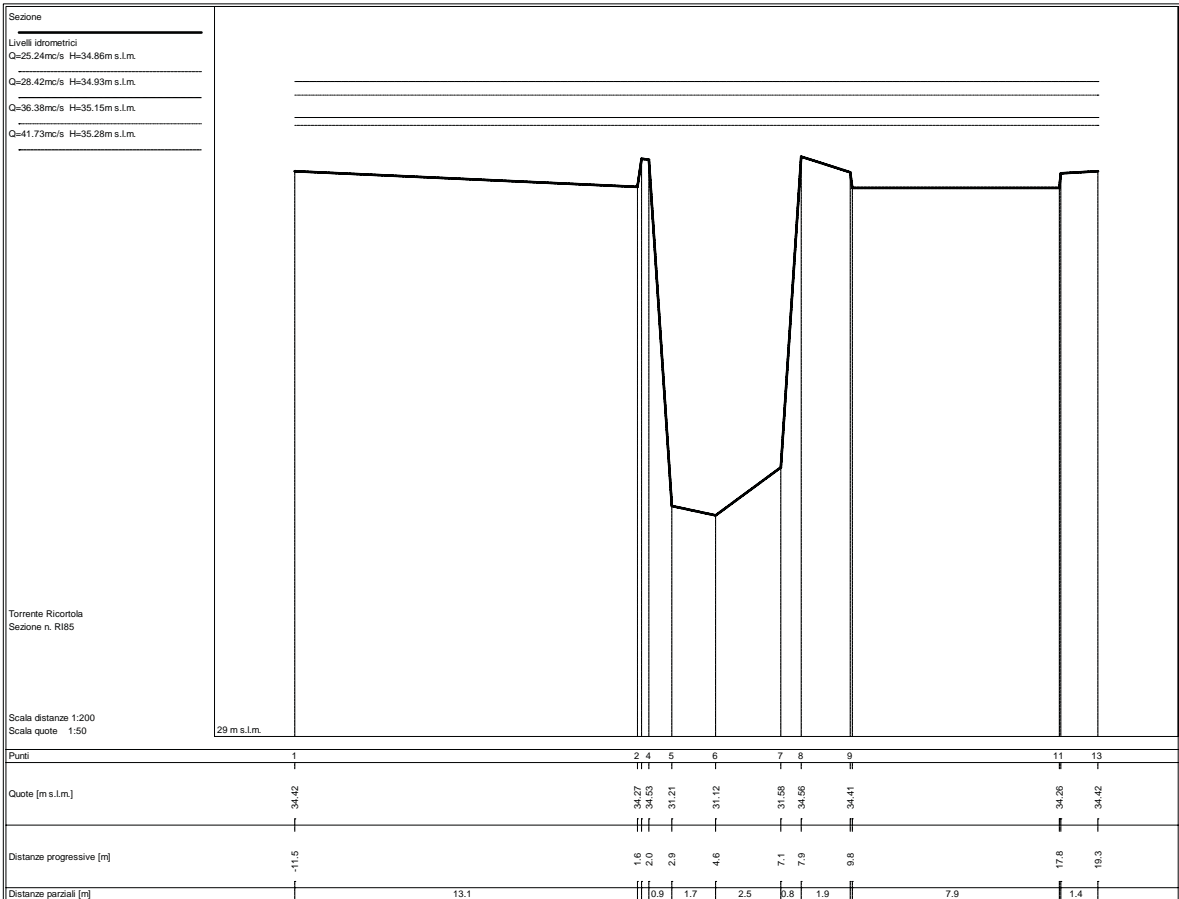
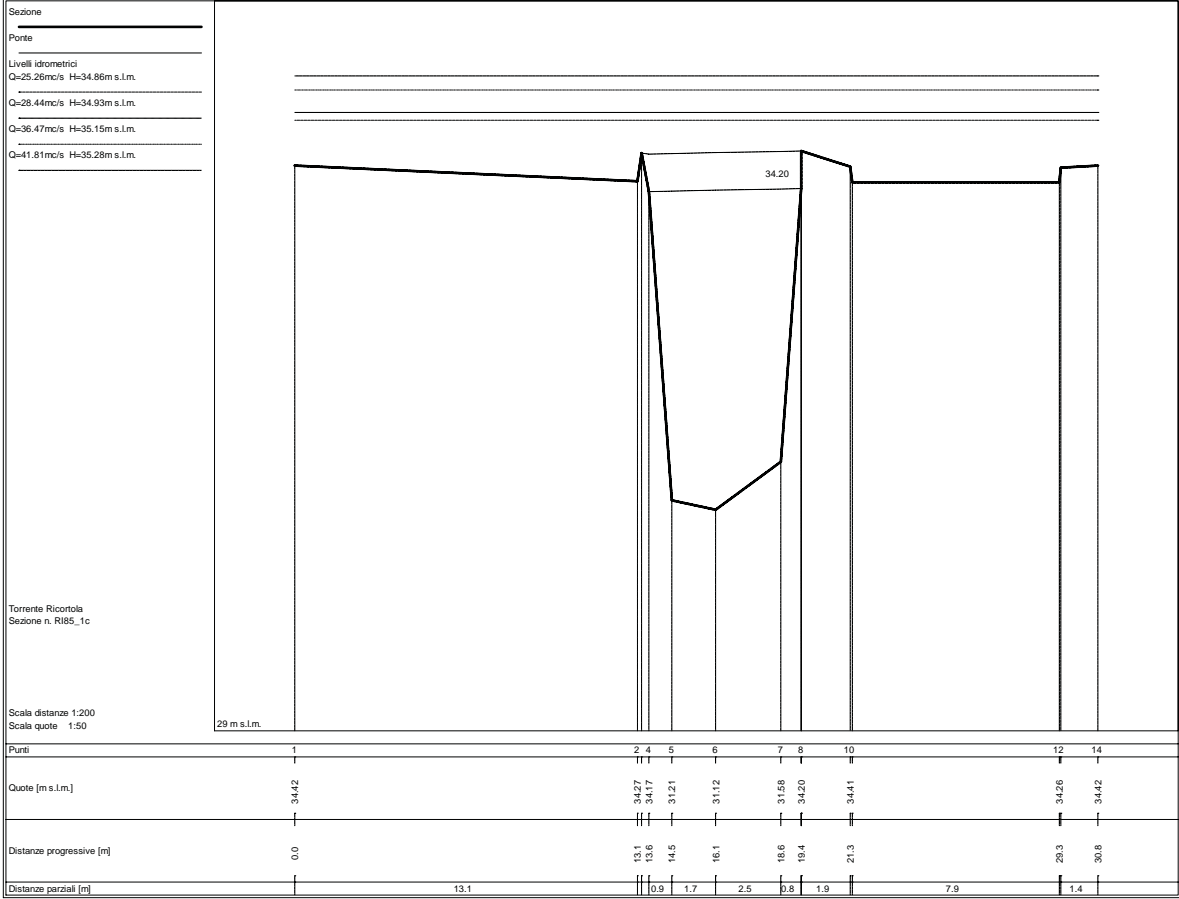

Sezione

Livelli idrometrici
 Q=25.24mc/s H=34.85m s.l.m.
 Q=28.43mc/s H=34.92m s.l.m.
 Q=36.39mc/s H=35.12m s.l.m.
 Q=41.73mc/s H=35.24m s.l.m.

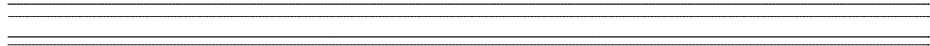

Torrente Ricortola
 Sezione n. R164

Scala distanze 1:100
 Scala quote 1:50

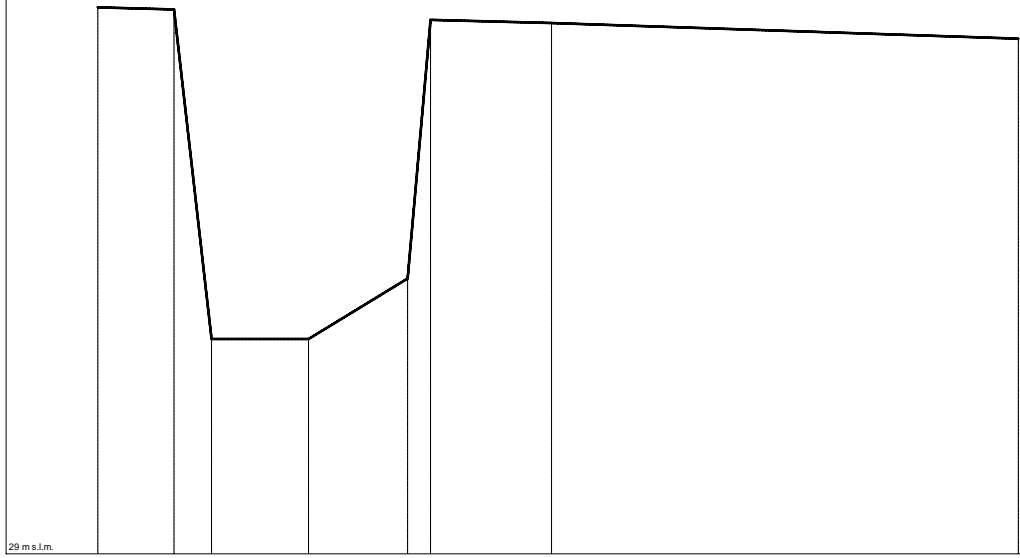

Punti	1	2	3	4	5	6	7	8
Quote [m s.l.m.]	34.24	34.22	31.06	31.06	31.64	34.12	34.09	33.94
Distanze progressive [m]	0.6	2.2	3.0	4.8	6.7	7.2	9.5	18.4
Distanze parziali [m]		1.5	0.7	1.9	1.9	0.4	2.3	8.9

STATO ATTUALE

Sezioni fluviali torrente Ricortola – RI_02

Sezione

Livelli idrometrici
 Q=30.10mc/s H=34.85m s.l.m.
 Q=34.23mc/s H=34.92m s.l.m.
 Q=44.81mc/s H=35.12m s.l.m.
 Q=51.85mc/s H=35.24m s.l.m.

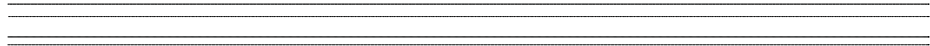

Torrente Ricortola
 Sezione n. RI64

Scala distanze 1:100
 Scala quote 1:50

29 m s.l.m.

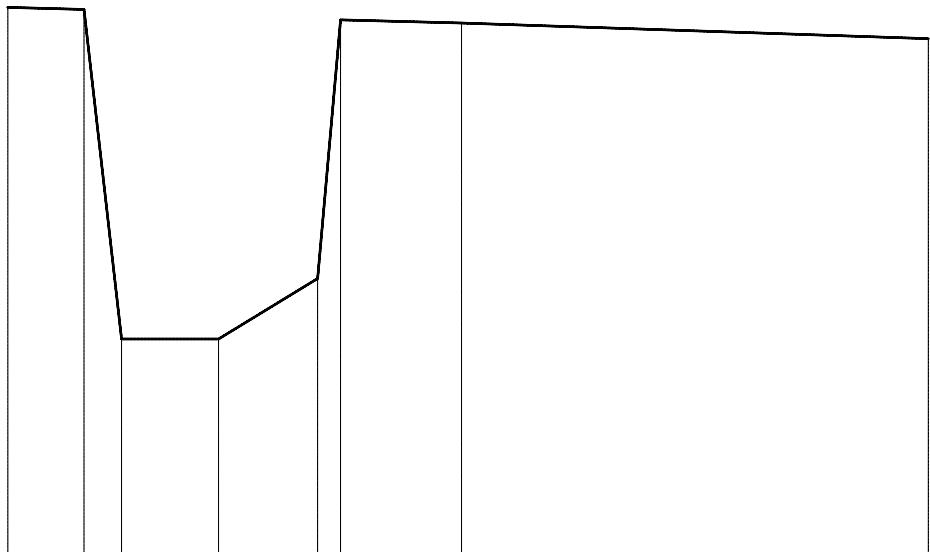

Punti	1	2	3	4	5	6	7	8
Quote [m s.l.m.]	34.24	34.22	31.06	31.06	31.64	34.12	34.09	33.94
Distanze progressive [m]	0.8	2.2	3.0	4.8	6.7	7.2	9.5	18.4
Distanze parziali [m]	1.5	0.7	1.9	1.9	0.4	2.3	8.9	

Sezione

Porte
 Livelli idrometrici
 Q=30.10mc/s H=34.63m s.l.m.
 Q=34.23mc/s H=34.70m s.l.m.
 Q=44.81mc/s H=34.88m s.l.m.
 Q=51.85mc/s H=34.98m s.l.m.

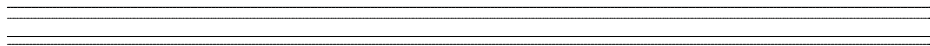

Torrente Ricortola
 Sezione n. RI63_2b

Scala distanze 1:100
 Scala quote 1:50

29 m s.l.m.

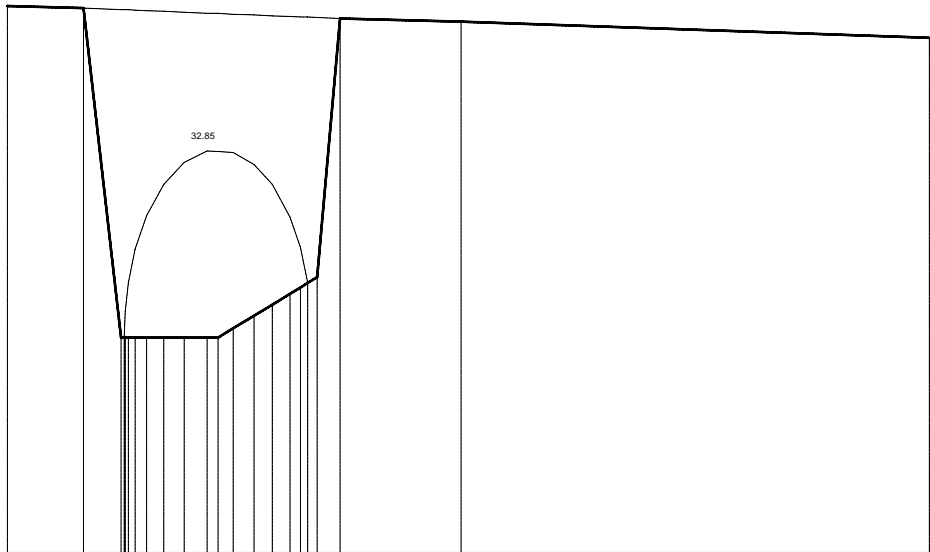

Punti	1	2	3	7	8	9	10	11	13	14	15	16	18	20	21	22
Quote [m s.l.m.]	34.24	34.22	31.06	31.06	31.06	31.06	31.06	31.06	31.15	31.27	31.38	31.48	31.59	34.12	34.09	33.94
Distanze progressive [m]	0.8	2.2	3.0	3.2	3.4	3.8	4.2	4.6	5.1	5.5	5.8	6.2	6.5	7.2	9.5	18.5
Distanze parziali [m]	1.5	0.7	0.4	0.4	0.4	0.4	0.4	0.4	0.4	0.4	0.4	0.4	0.4	0.4	2.3	9.0

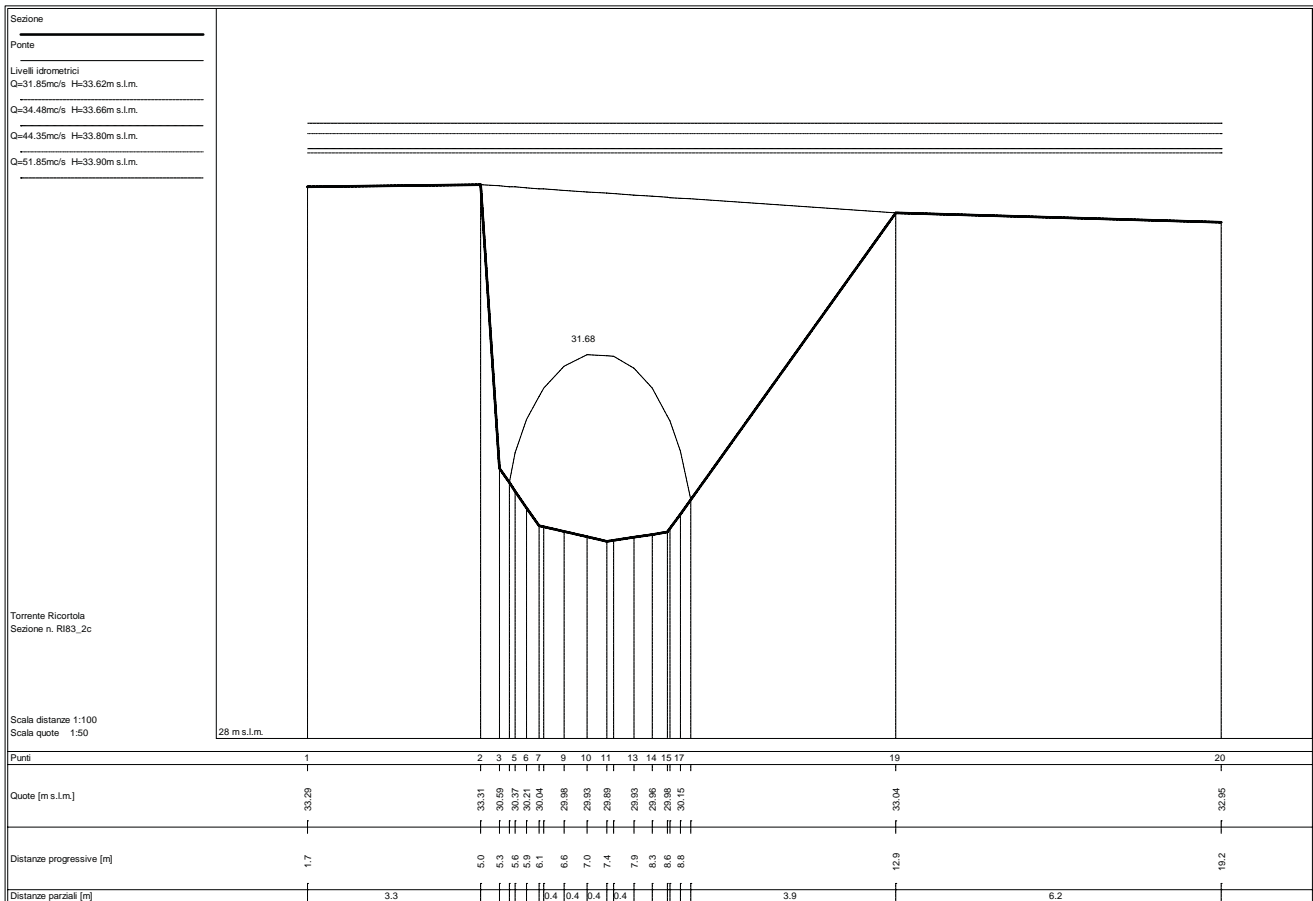
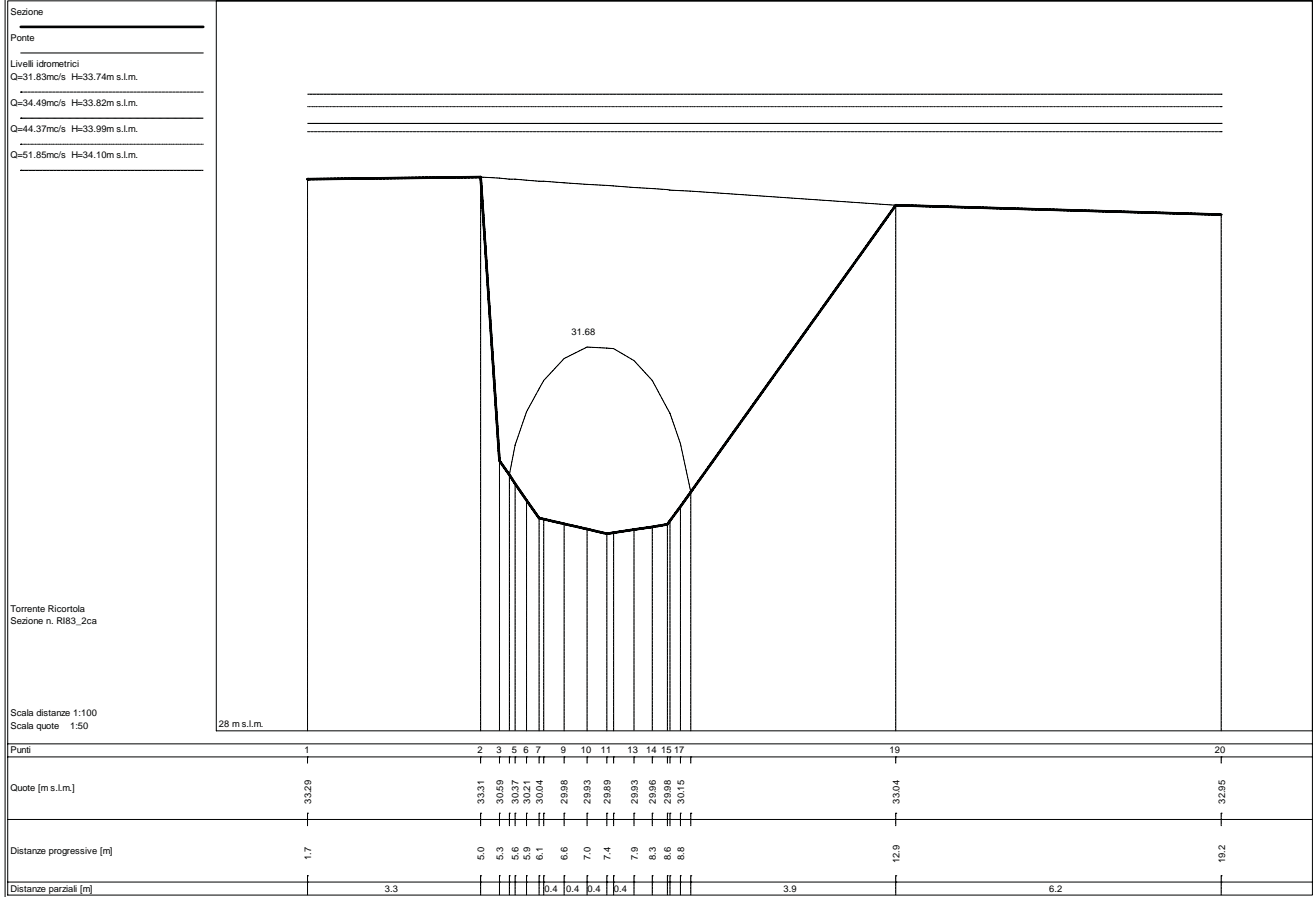

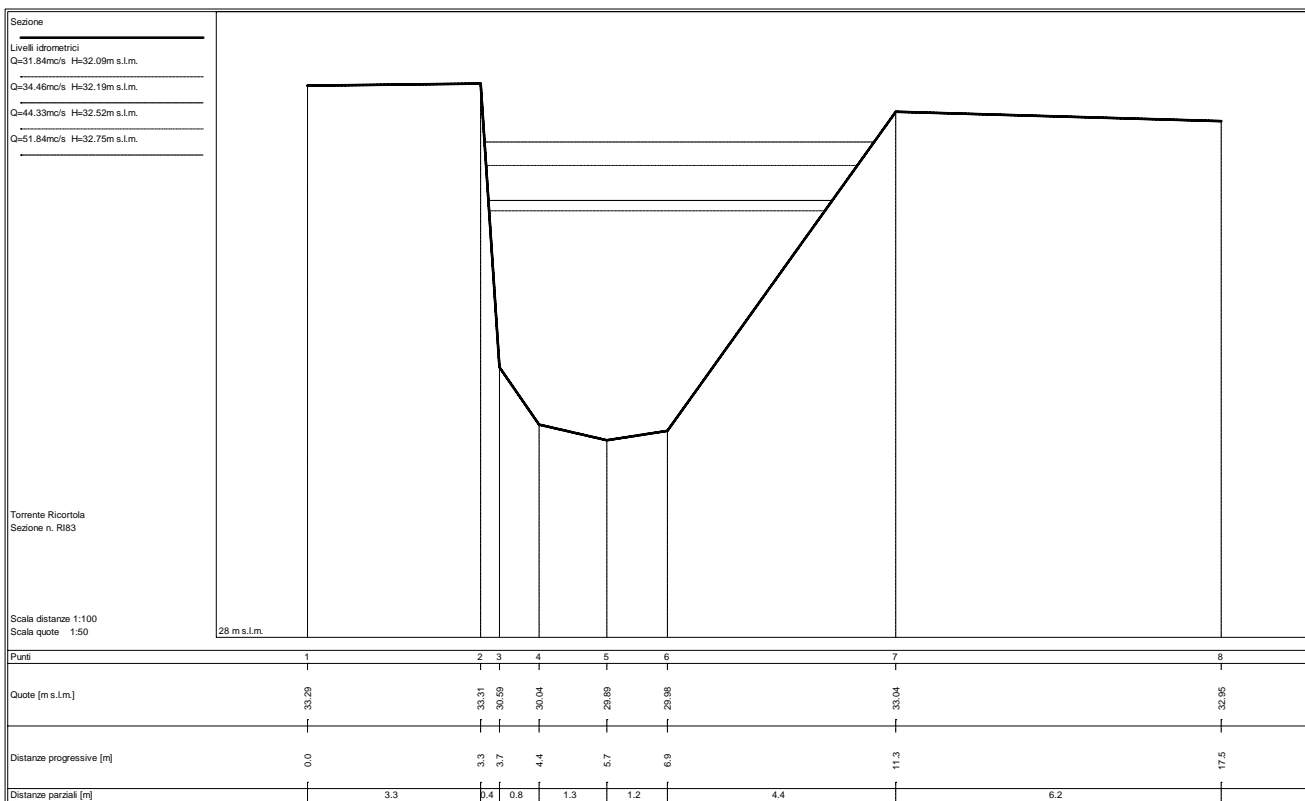
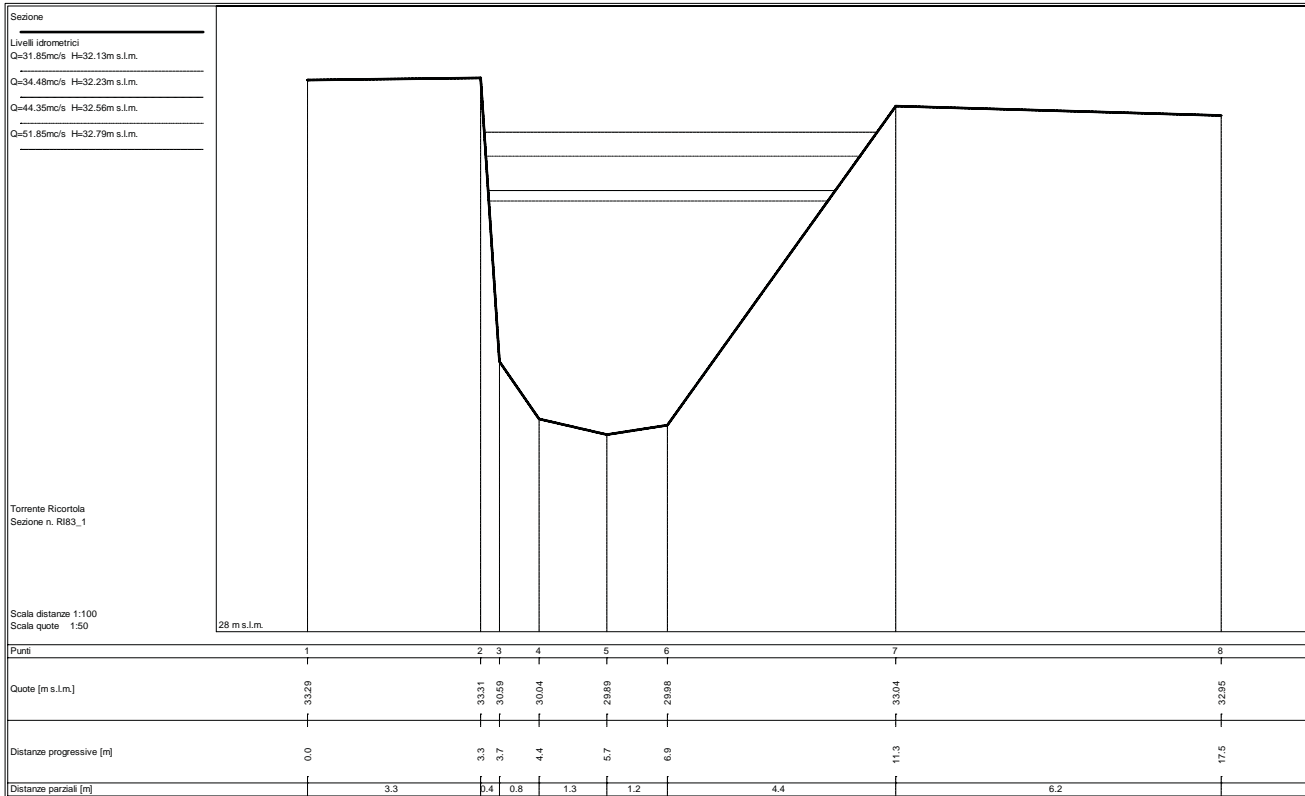

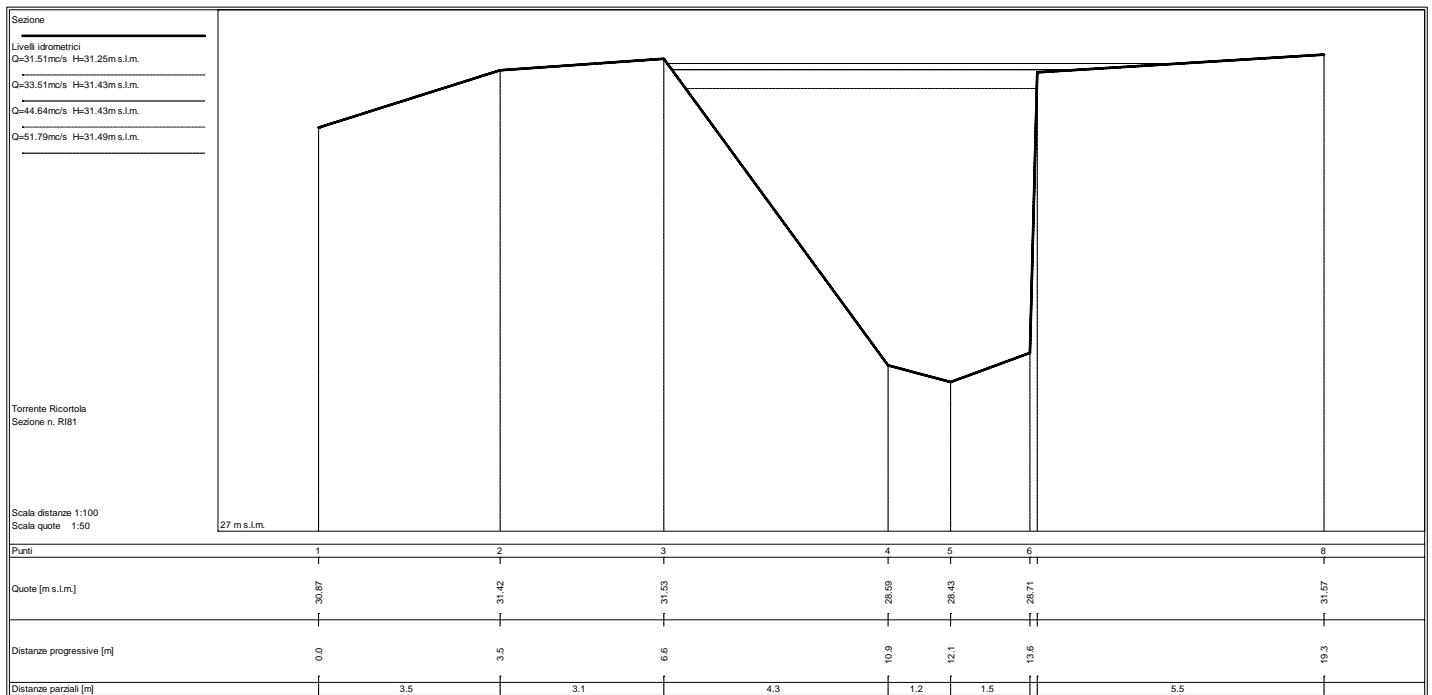
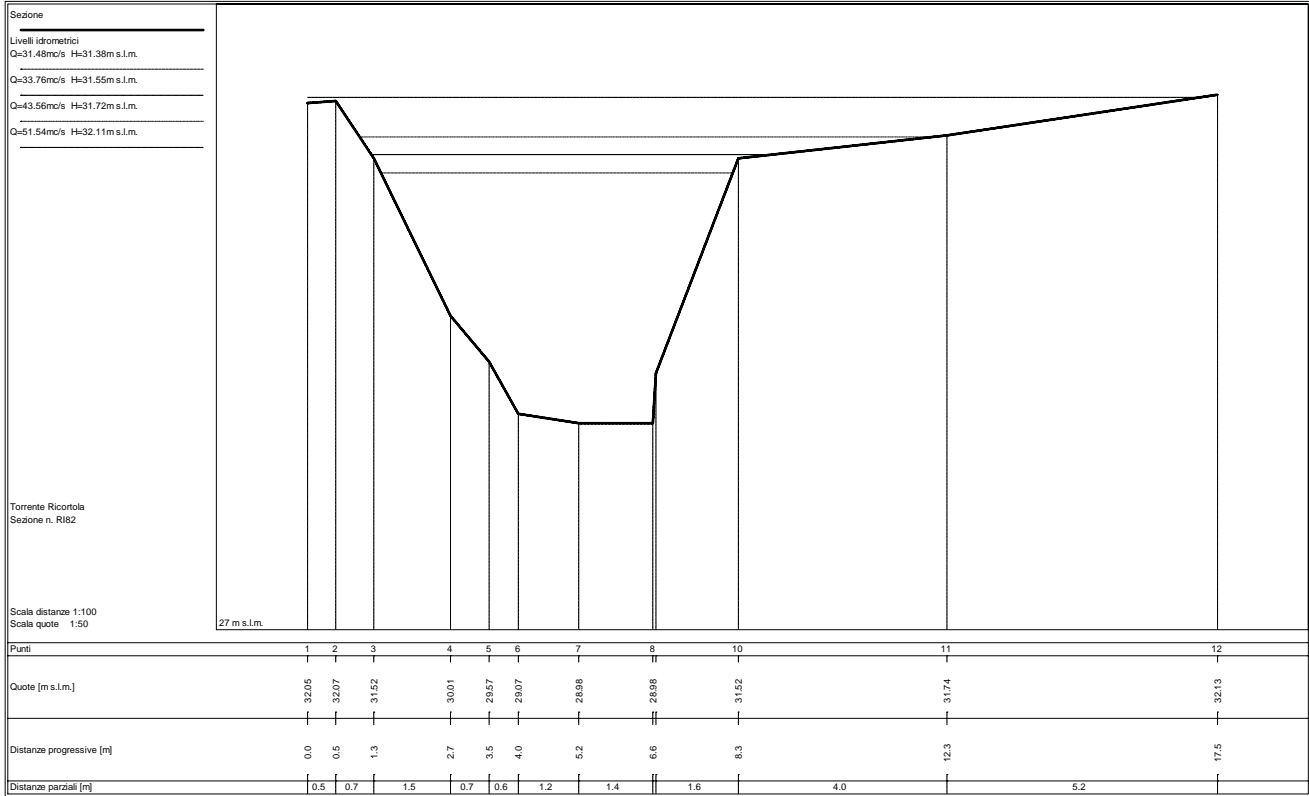

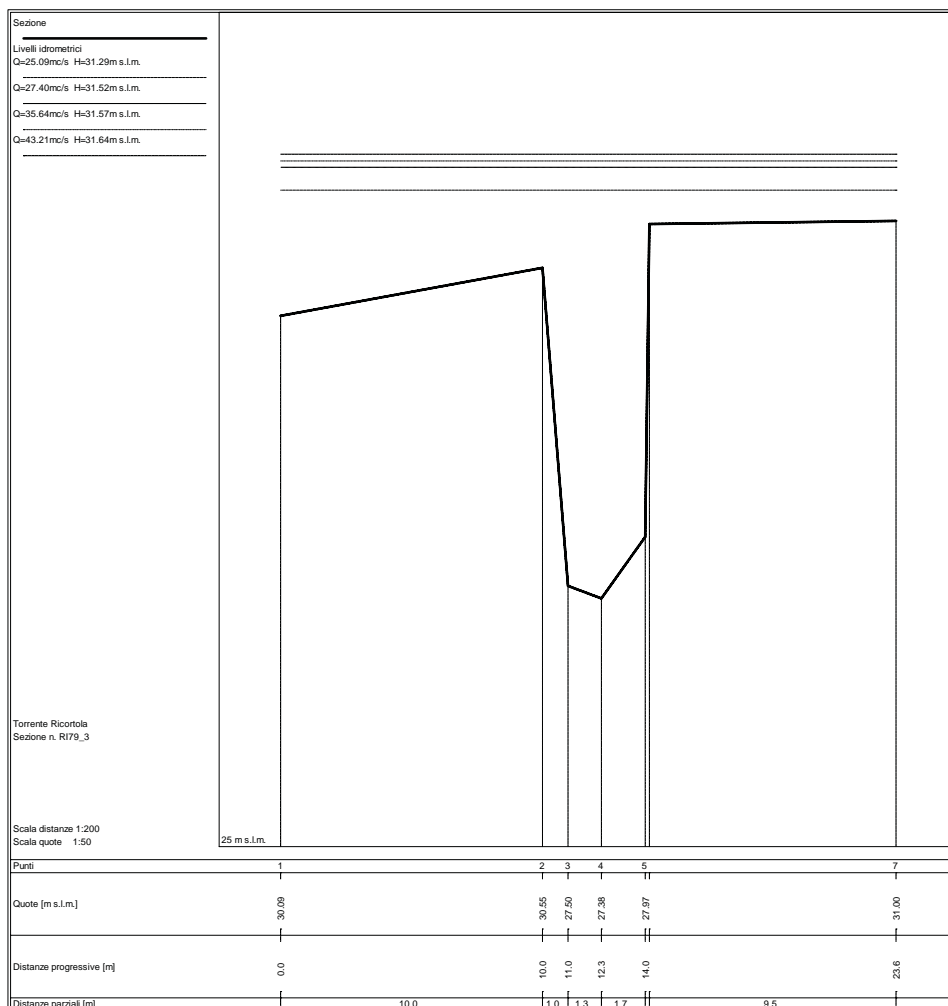
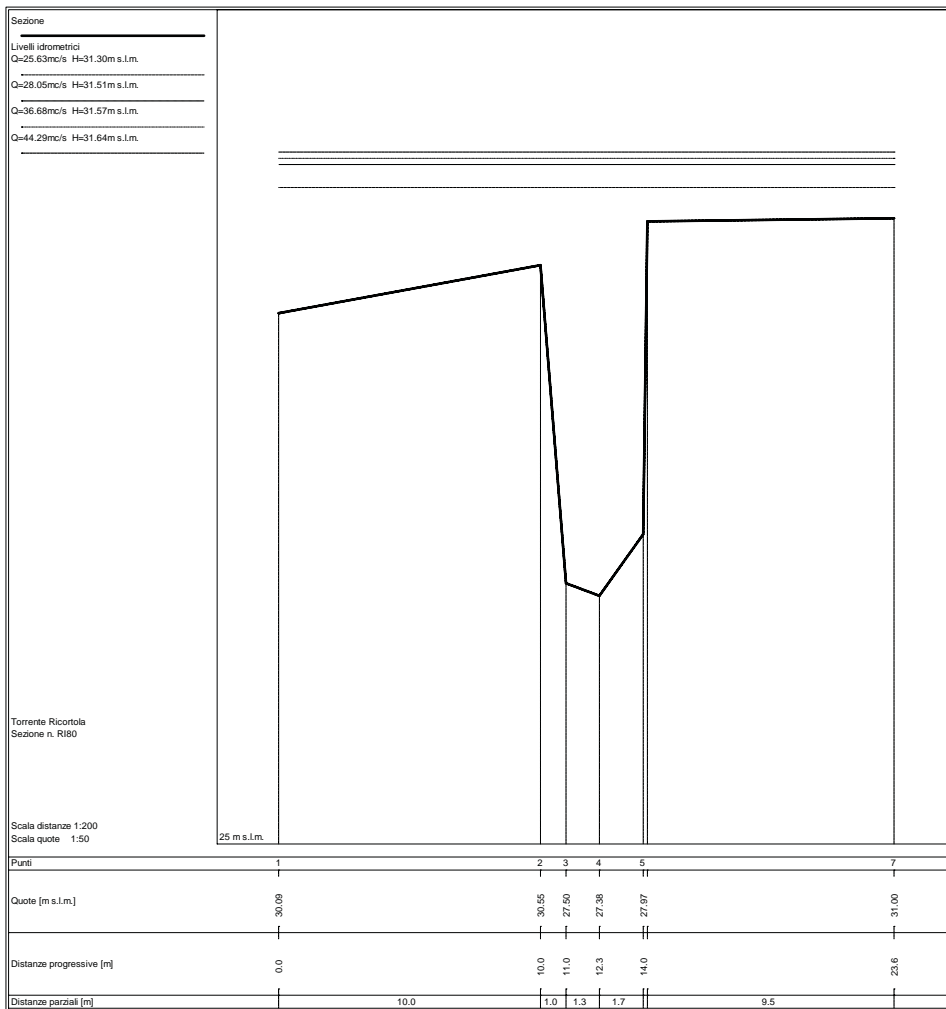

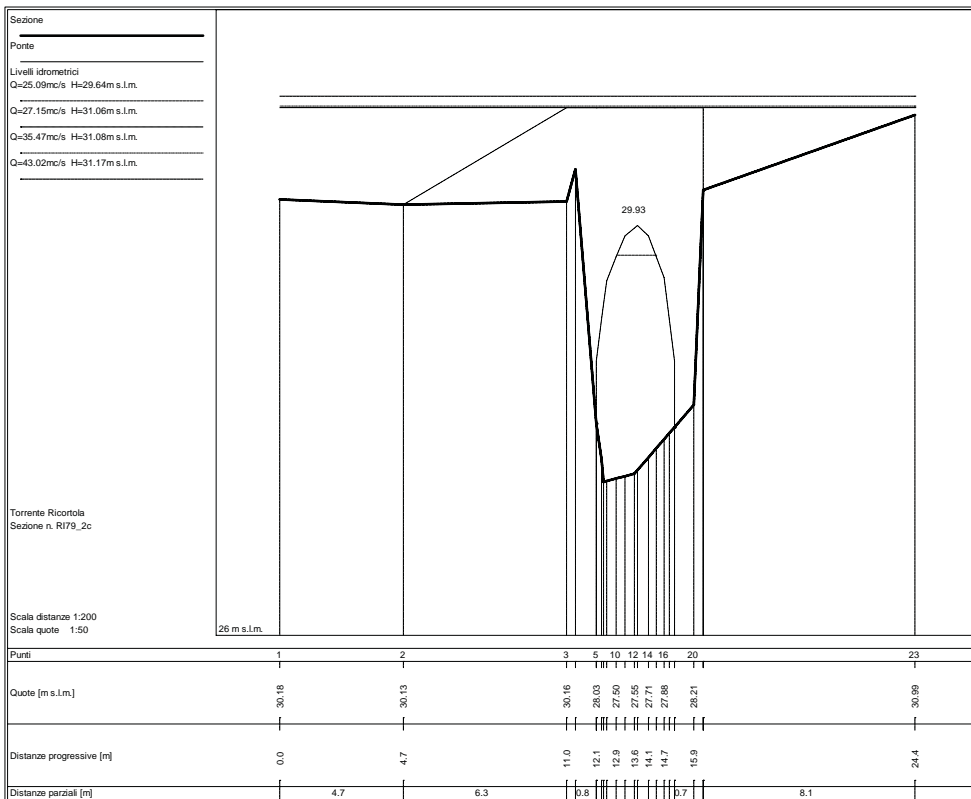
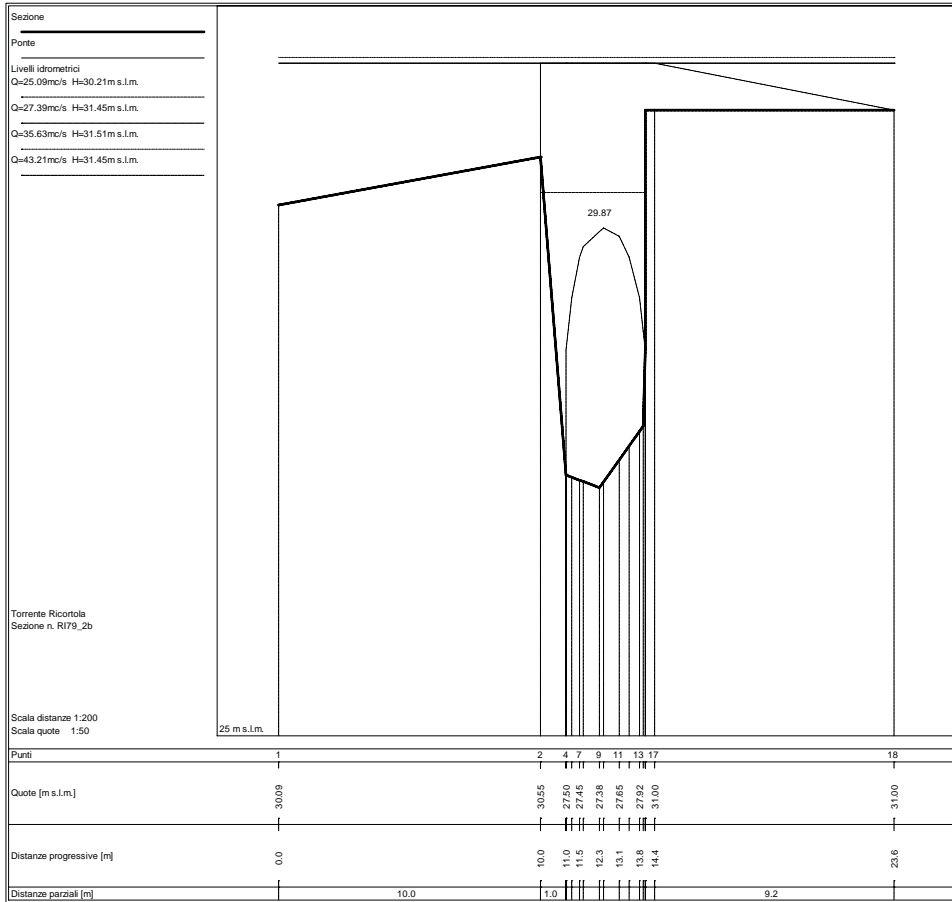

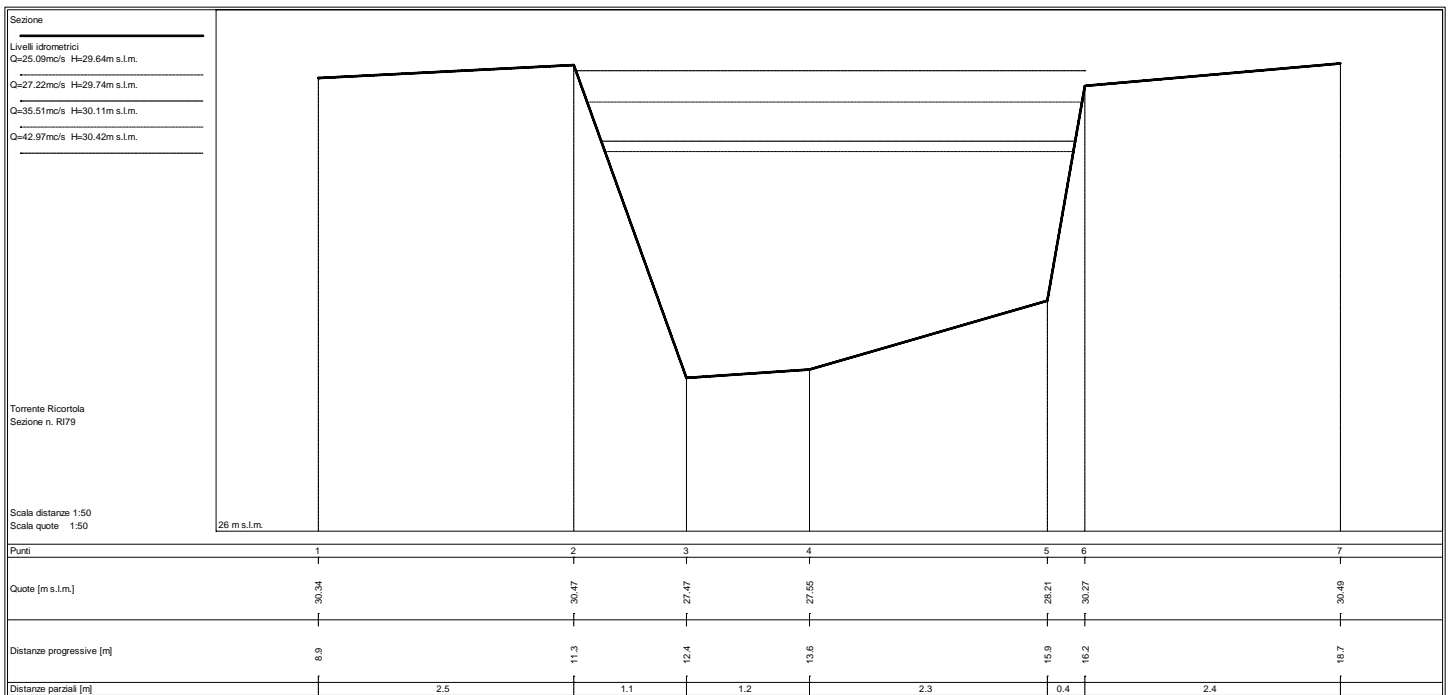
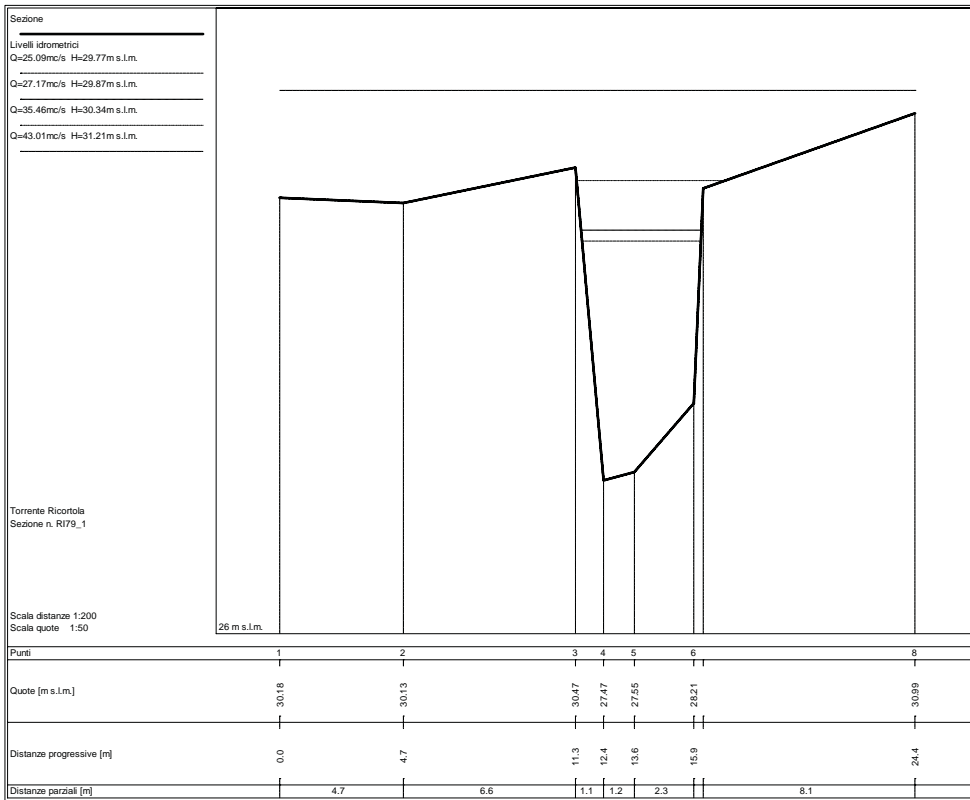

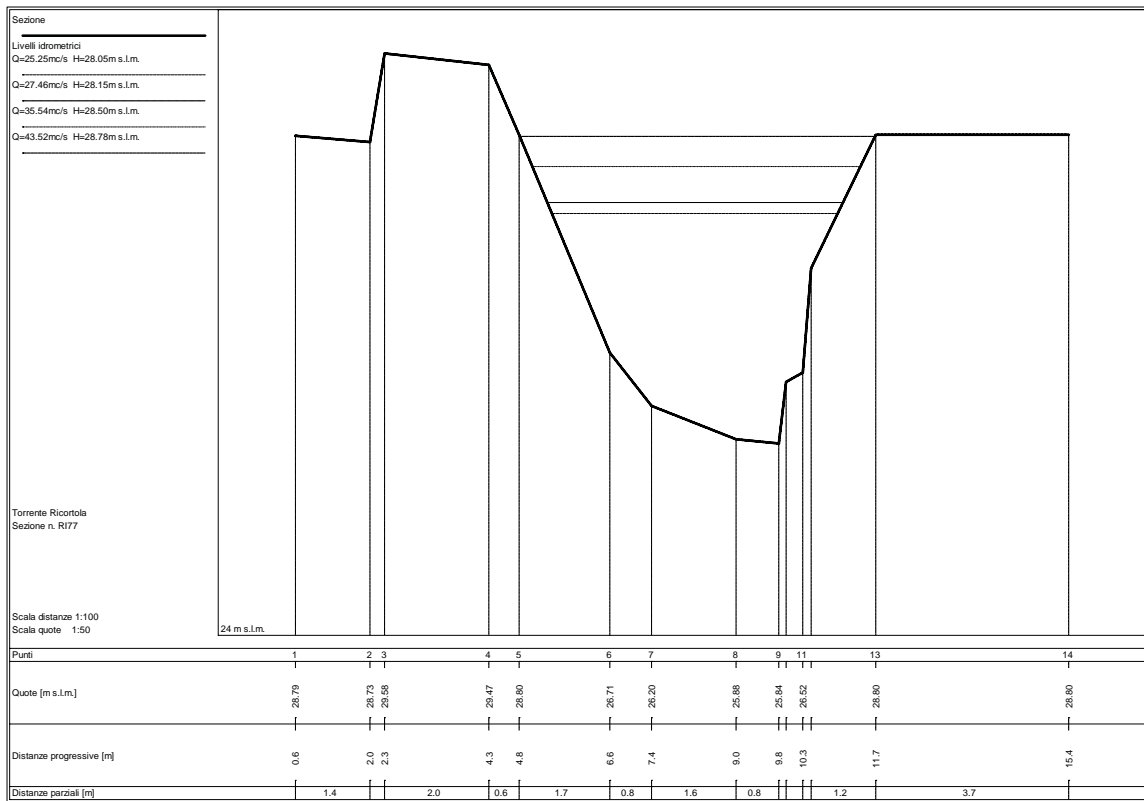
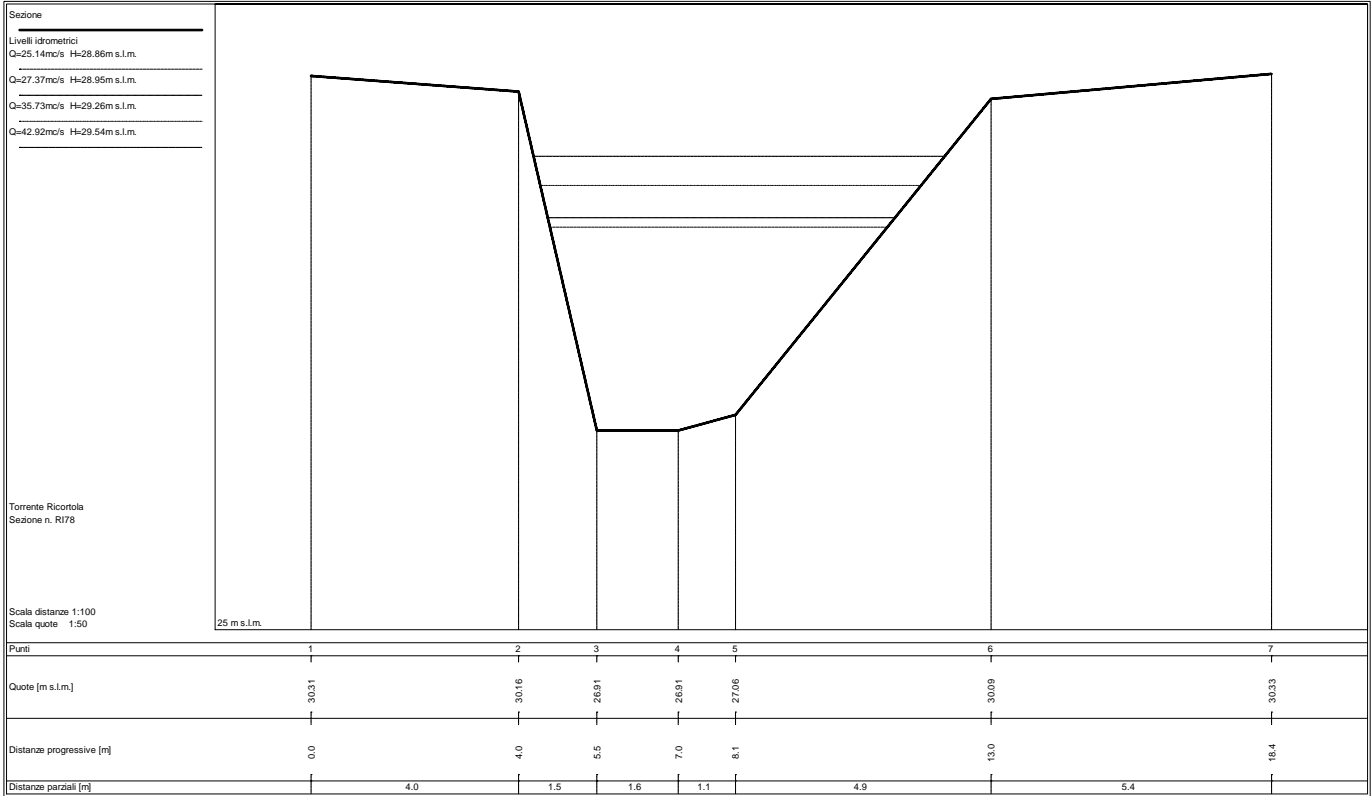

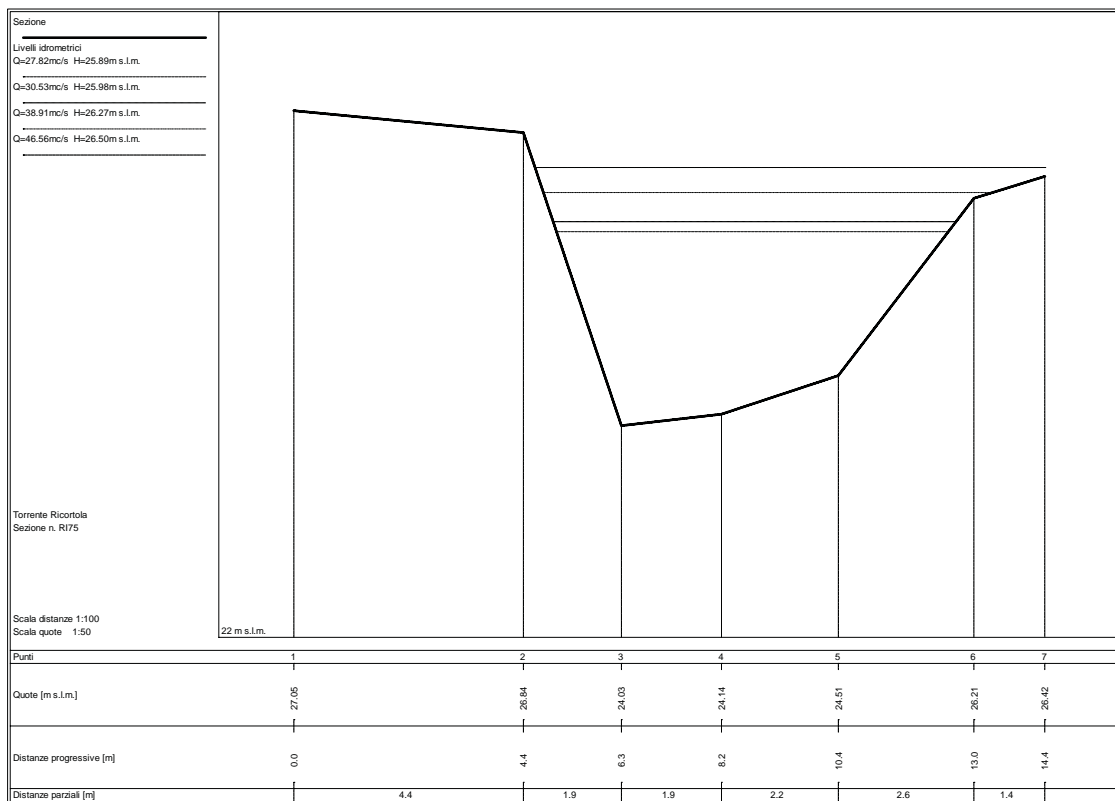
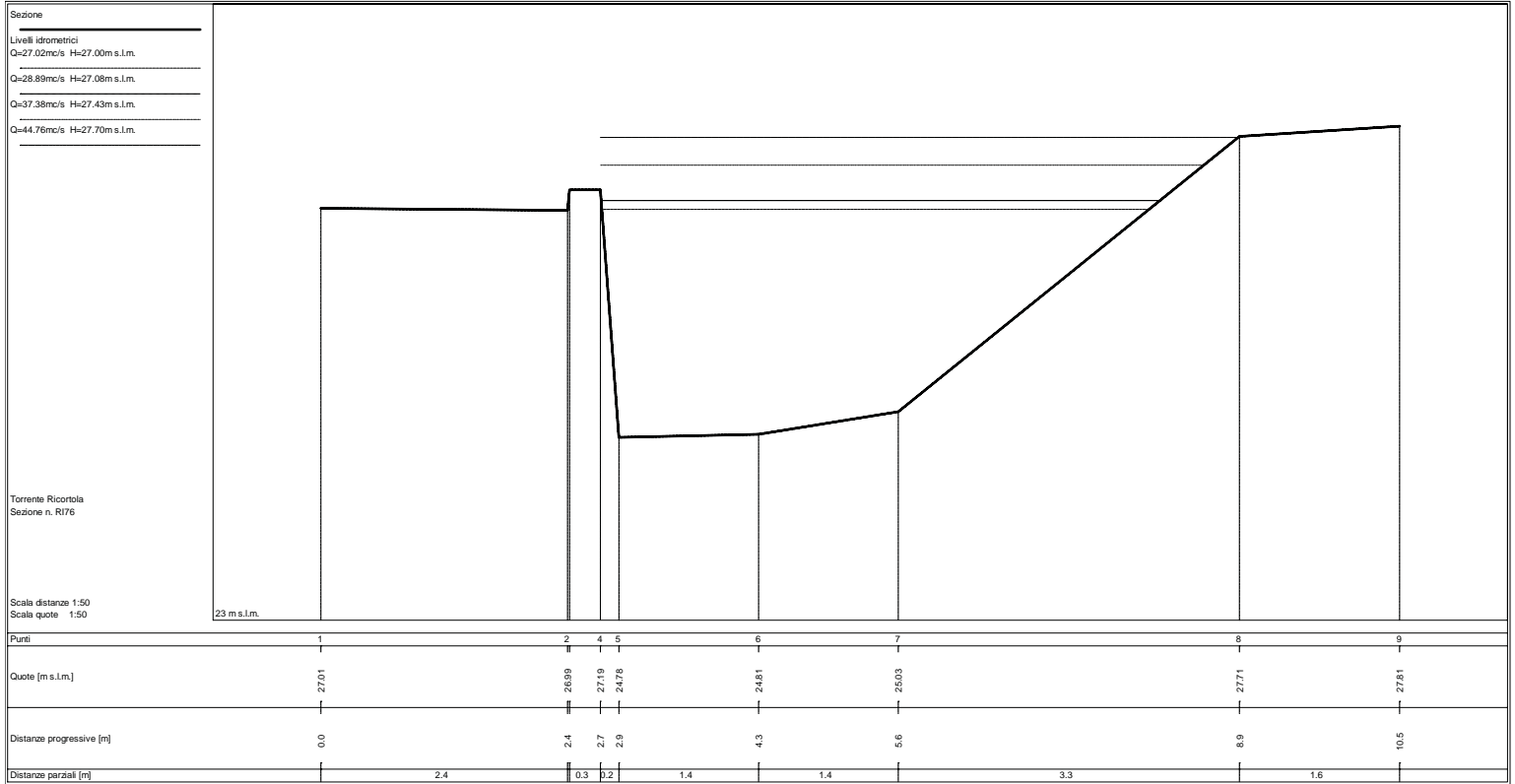

Sezione
 Livelli idrometrici
 Q=28.11mc/s H=25.32m s.l.m.
 Q=31.18mc/s H=25.42m s.l.m.
 Q=39.58mc/s H=25.68m s.l.m.
 Q=47.40mc/s H=25.89m s.l.m.

Torrente Ricortola
 Sezione n. R174

Scala distanze 1:100
 Scala quote 1:50

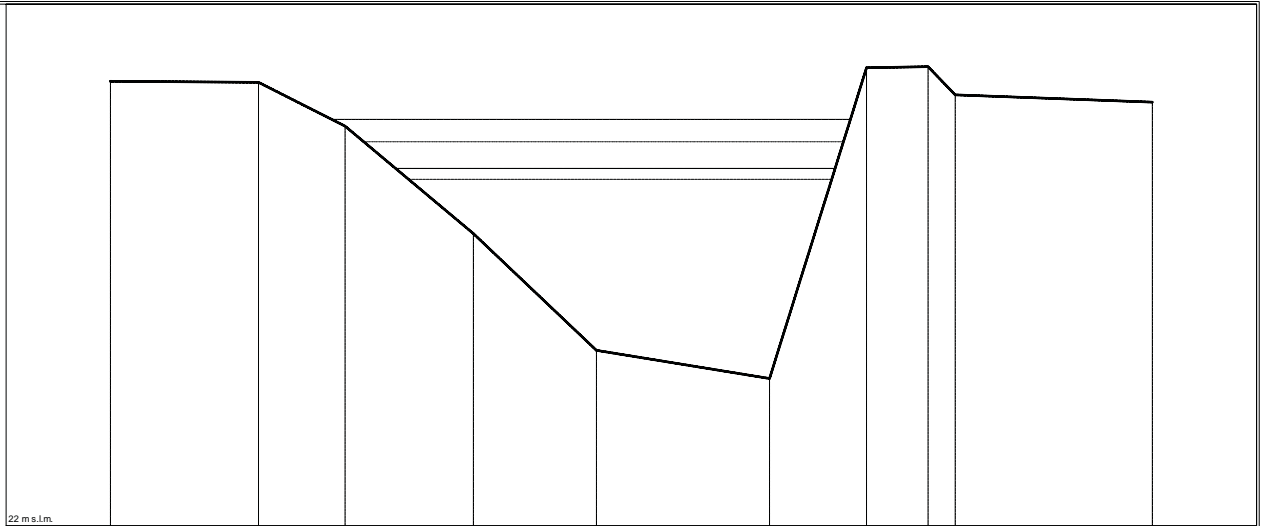

Punti	1	2	3	4	5	6	7	8	9	10
Quote [m s.l.m.]	26.26	26.25	25.83	24.80	23.68	23.41	26.39	26.40	26.13	26.06
Distanze progressive [m]	0.0	2.8	4.5	7.0	9.3	12.6	14.5	15.7	16.2	20.0
Distanze parziali [m]		2.8	1.7	2.5	2.4	3.3	1.9	1.2	0.5	3.8

Sezione
 Livelli idrometrici
 Q=28.12mc/s H=24.98m s.l.m.
 Q=31.06mc/s H=25.11m s.l.m.
 Q=40.20mc/s H=25.48m s.l.m.
 Q=47.46mc/s H=25.66m s.l.m.

Torrente Ricortola
 Sezione n. R173

Scala distanze 1:100
 Scala quote 1:50

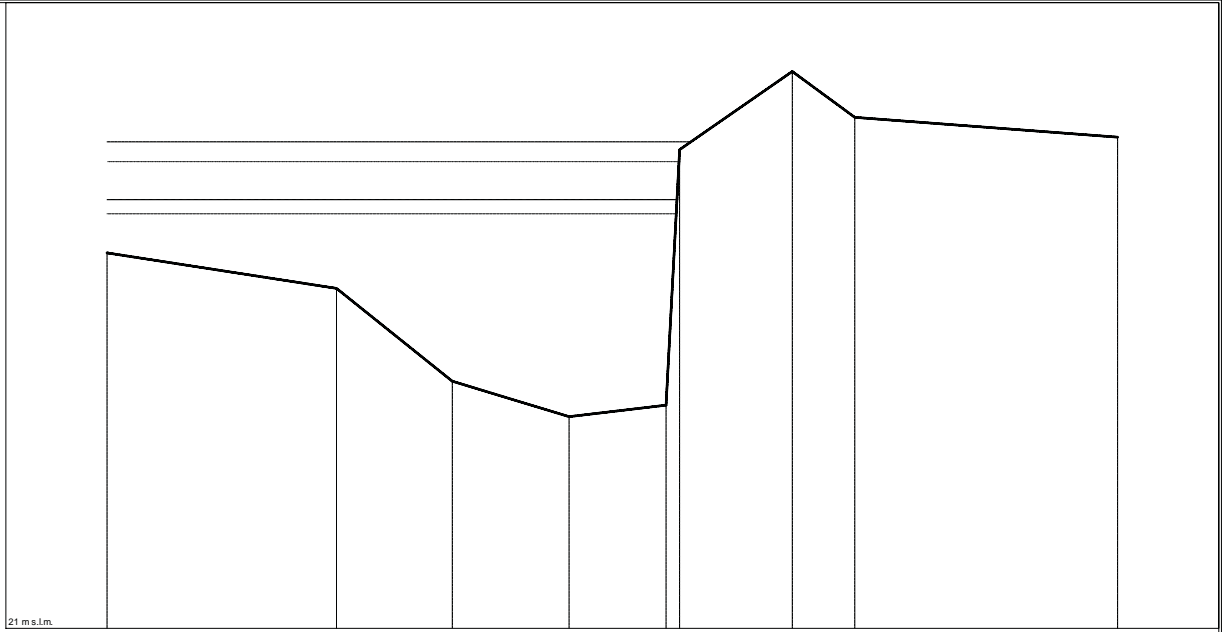

Punti	1	2	3	4	5	6	7	8	9
Quote [m s.l.m.]	24.60	24.26	23.37	23.03	23.14	25.89	26.34	25.90	25.71
Distanze progressive [m]	0.0	4.4	6.6	8.9	10.7	11.0	13.1	14.3	19.4
Distanze parziali [m]		4.4	2.2	2.2	1.9	2.2	1.2	5.0	

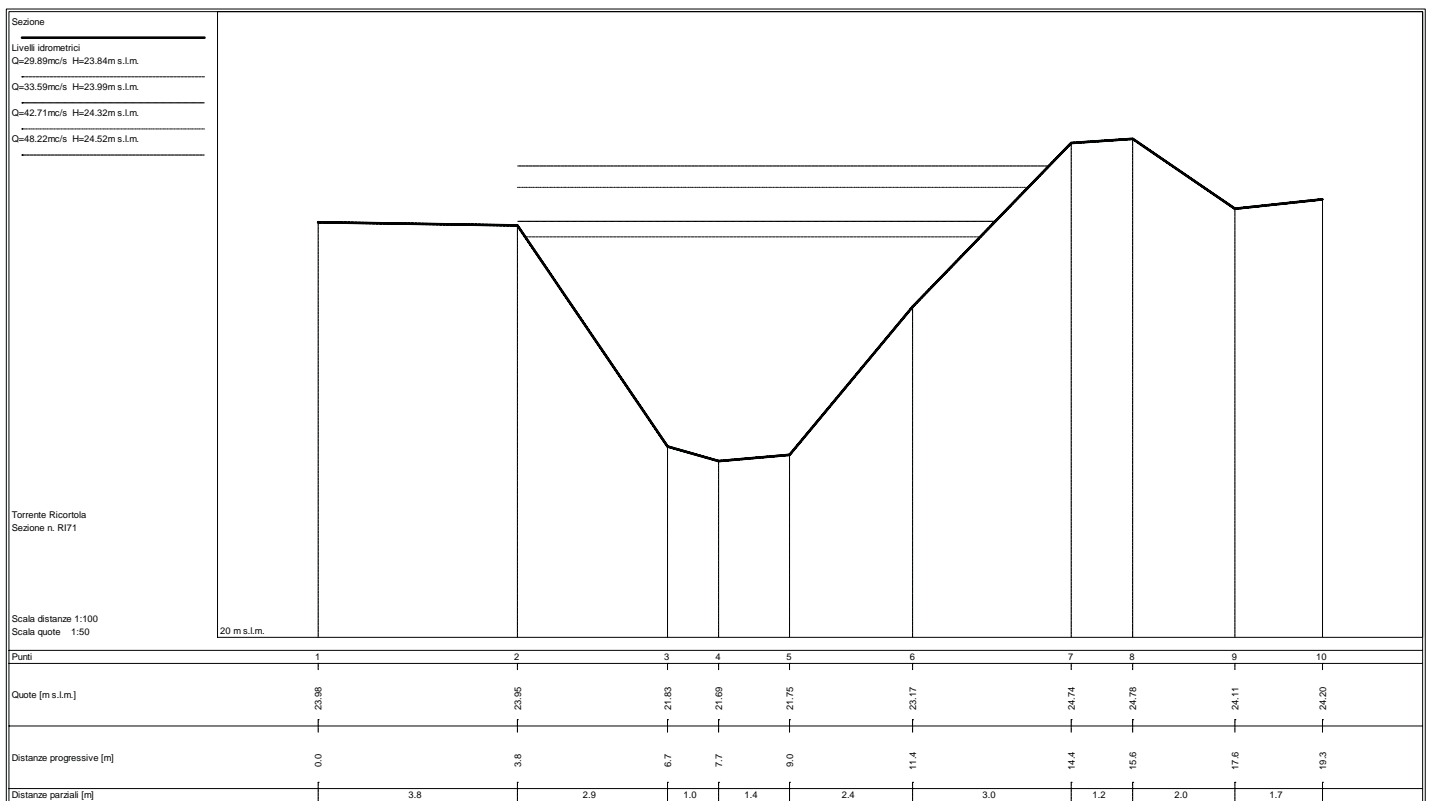
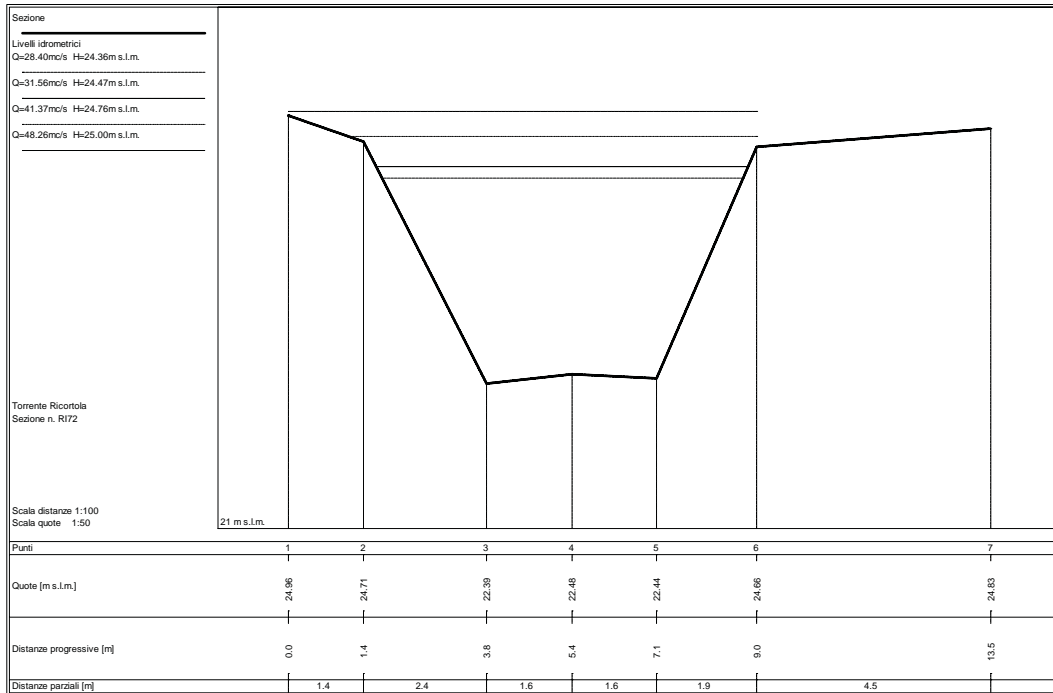

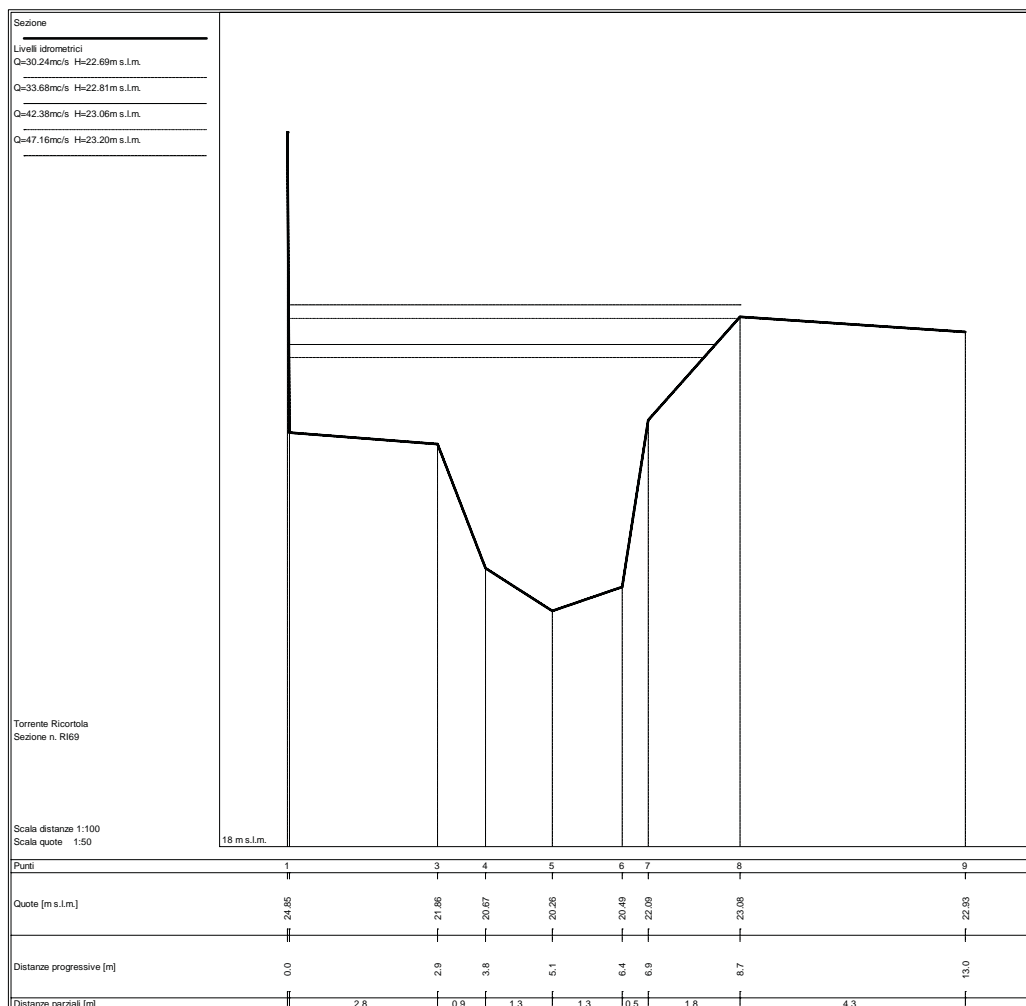
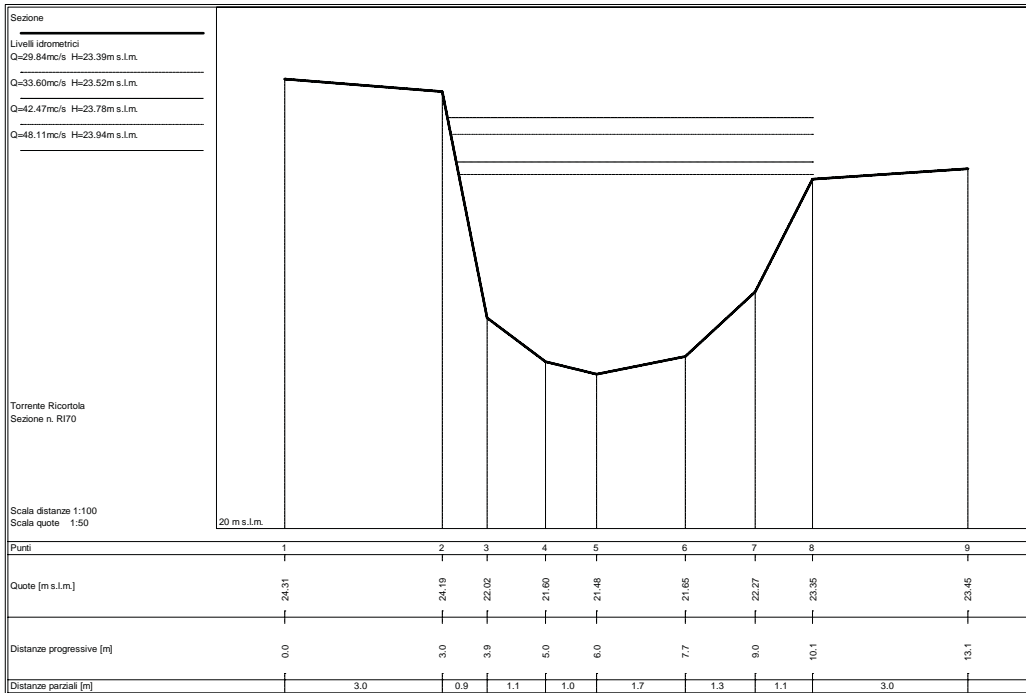

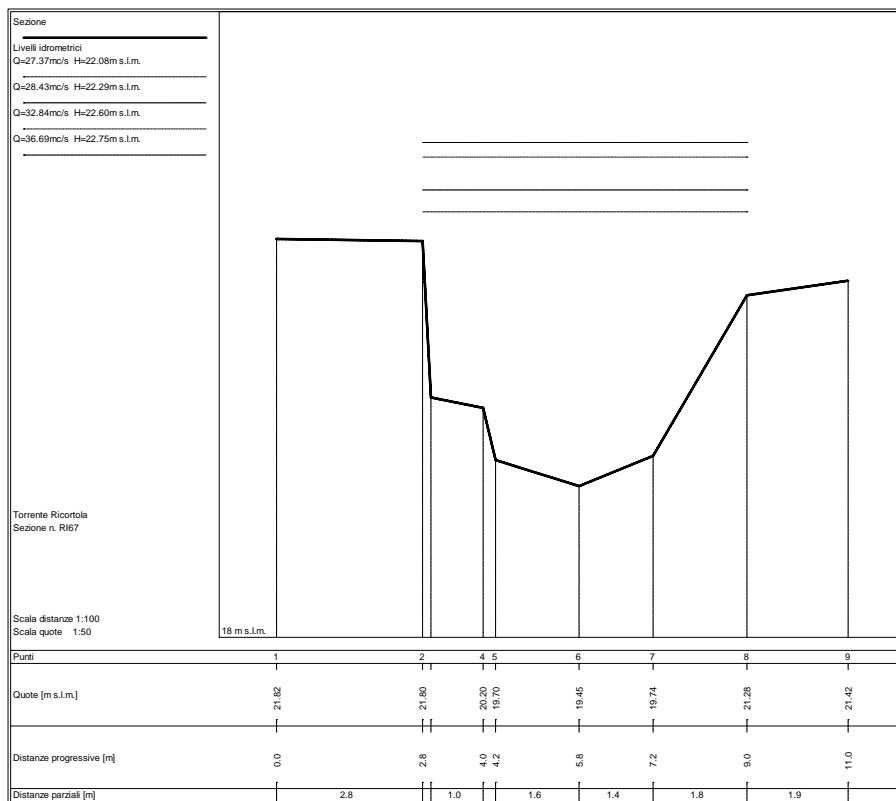
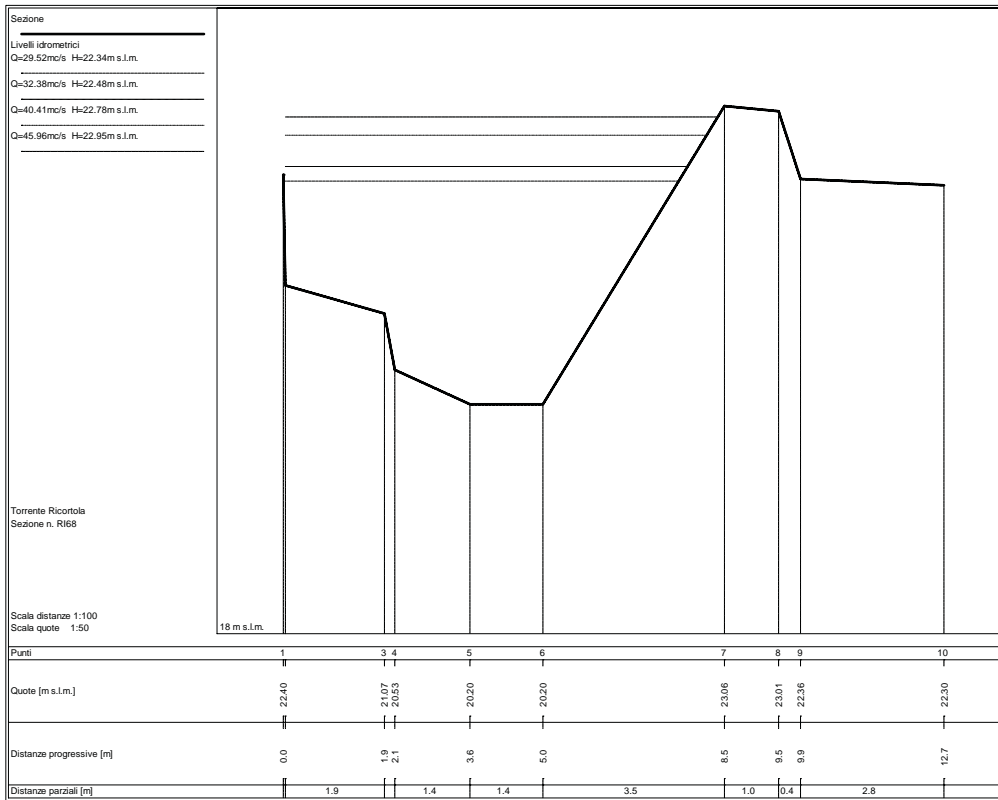

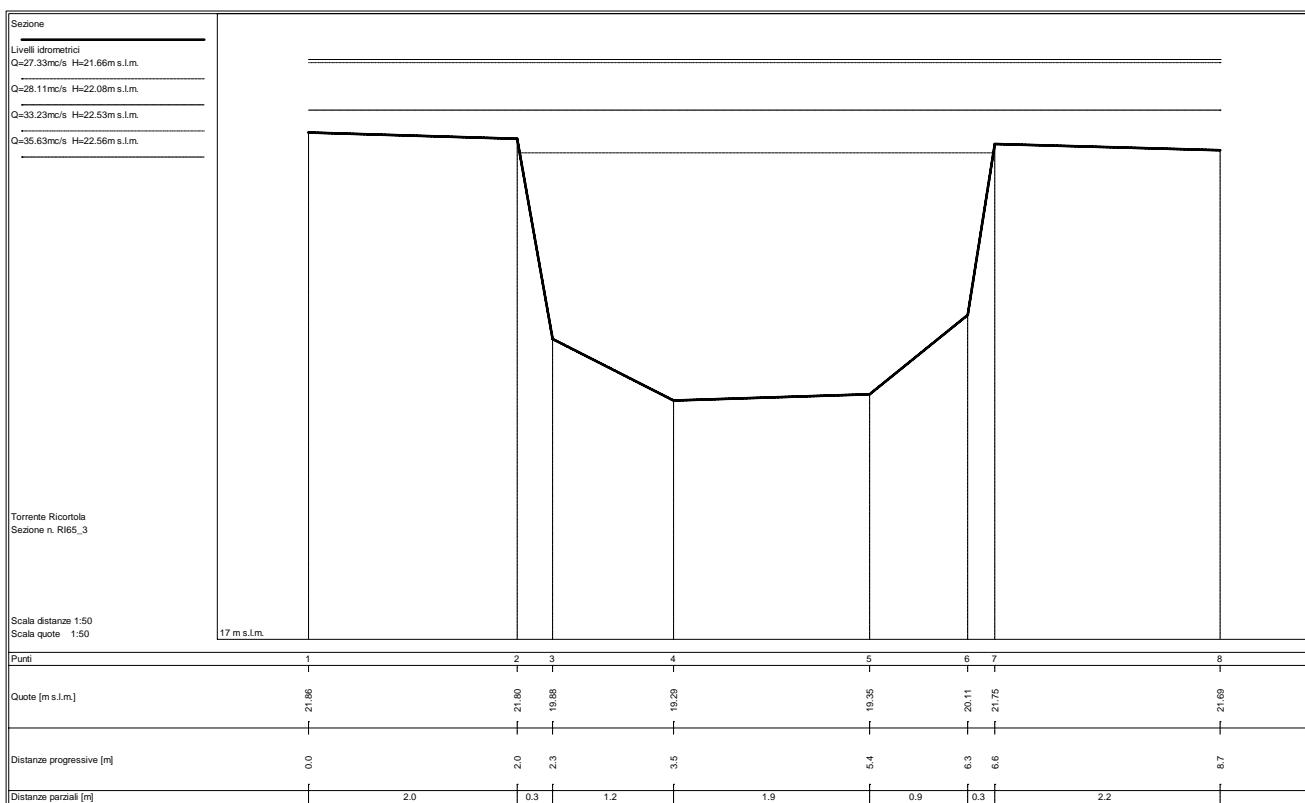
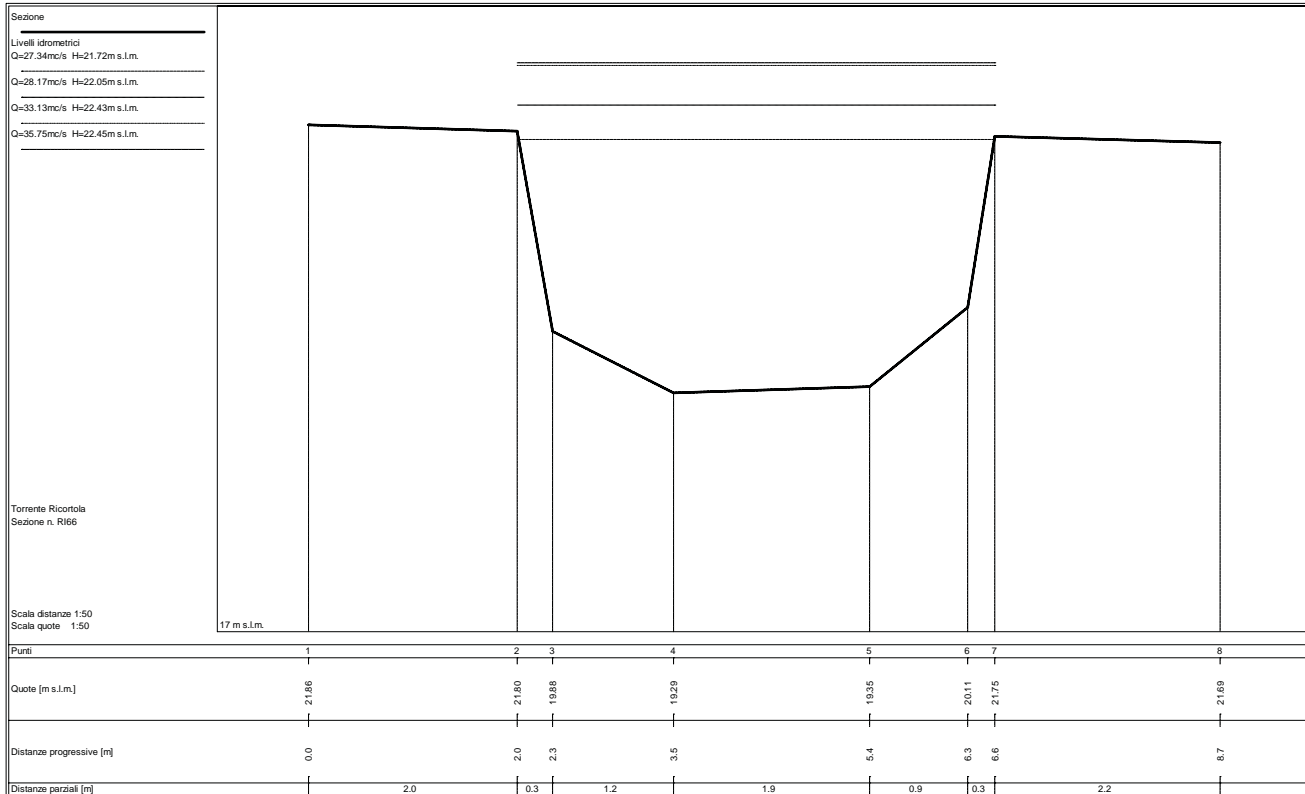

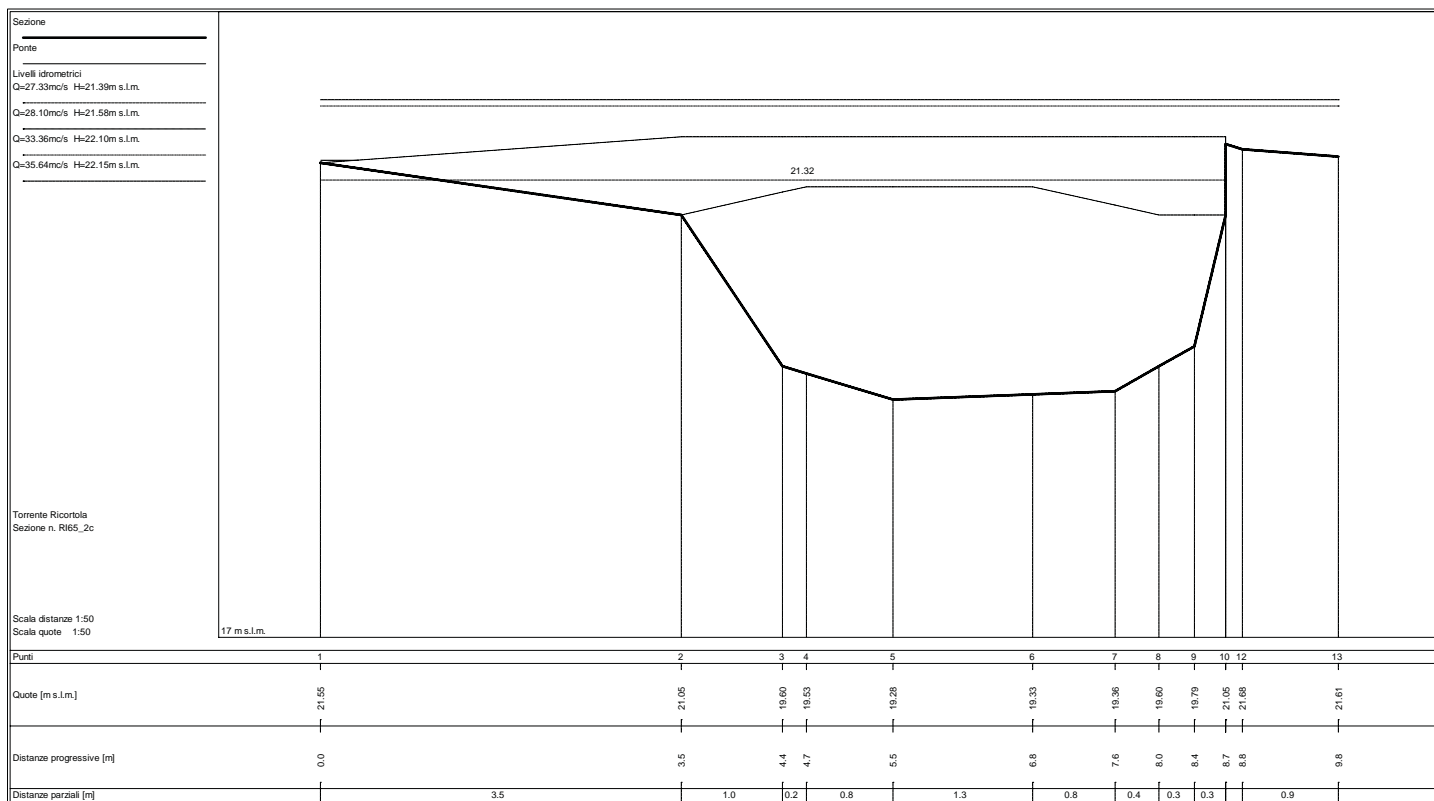
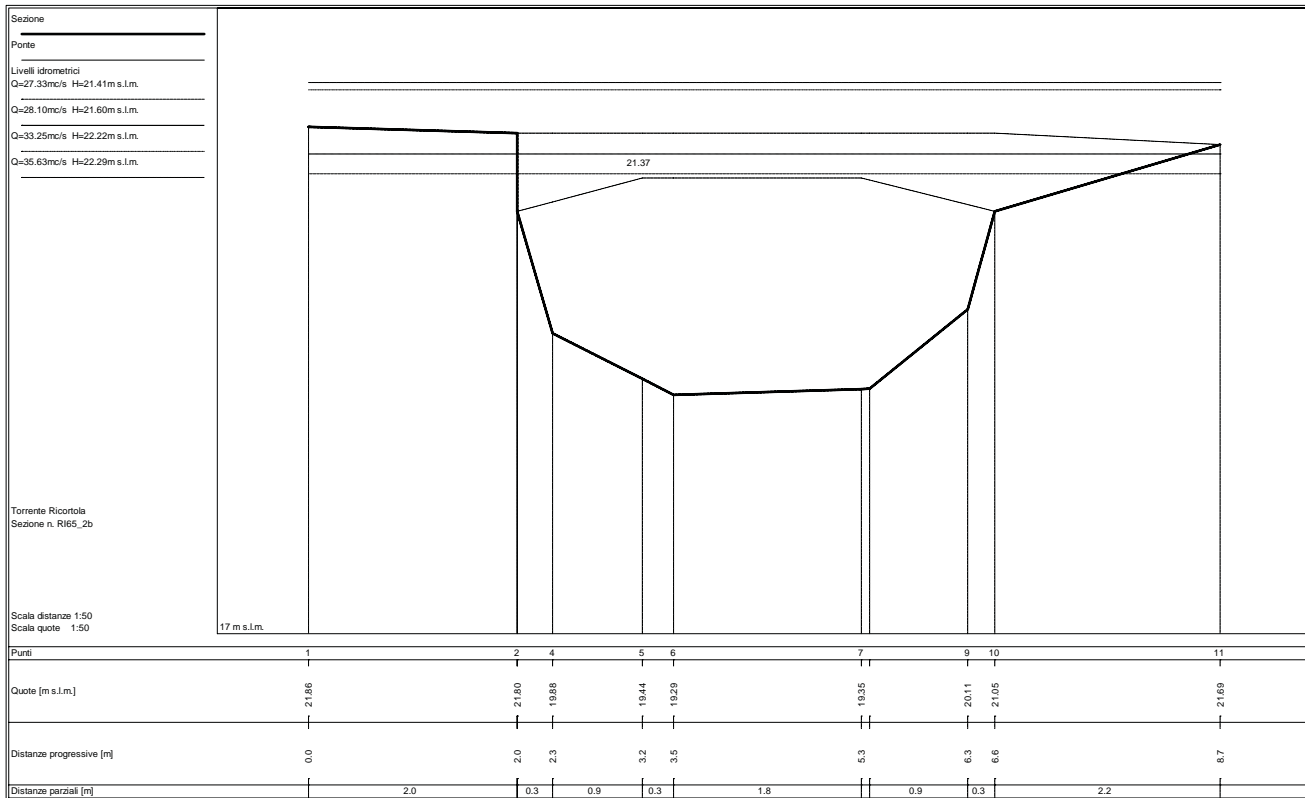

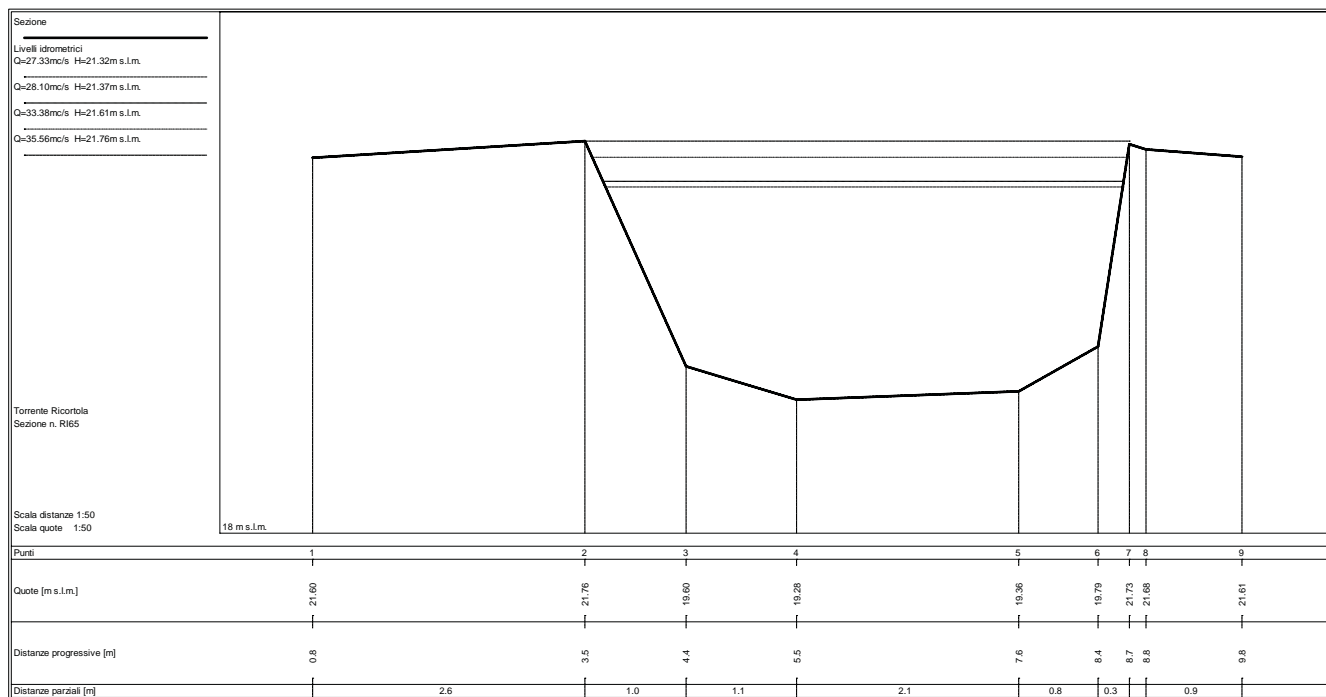
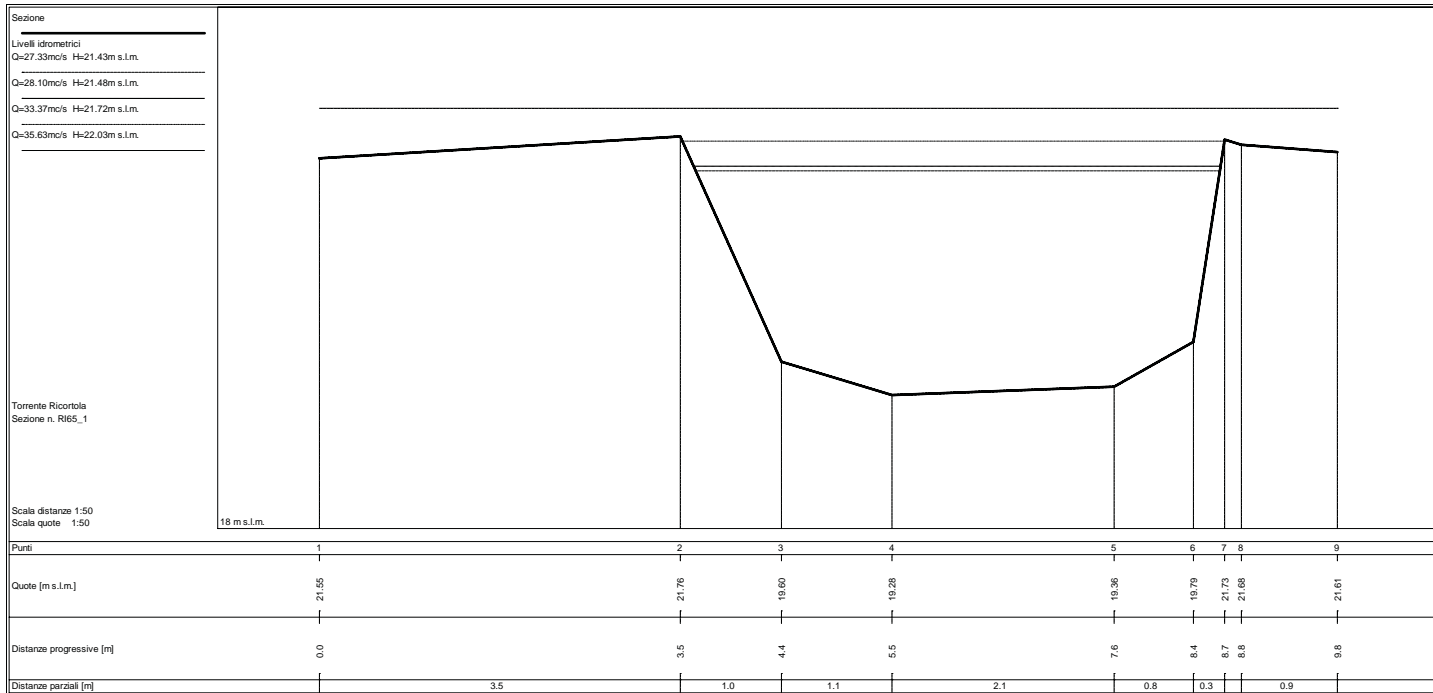

Sezione
 Livelli idrometrici
 Q=27.31mc/s H=21.19m s.l.m.
 Q=28.09mc/s H=21.27m s.l.m.
 Q=33.12mc/s H=21.54m s.l.m.
 Q=35.42mc/s H=21.71m s.l.m.

Torrente Ricortola
 Sezione n. R164

Scala distanze 1:50
 Scale quote 1:50

17 m.s.l.m.

Punti	1	2	4	6	7	8	9	10	11
Quote [m s.l.m.]	21.29	21.24	22.24	21.21	19.00	18.81	19.10	20.88	20.97
Distanze progressive [m]	0.5	3.0	3.4	3.6	3.7	5.3	6.5	9.0	10.8
Distanze parziali [m]		2.5	0.3	0.2		1.5	1.3	2.5	1.8

STATO ATTUALE

Sezioni fluviali torrente Ricortola – RI_03

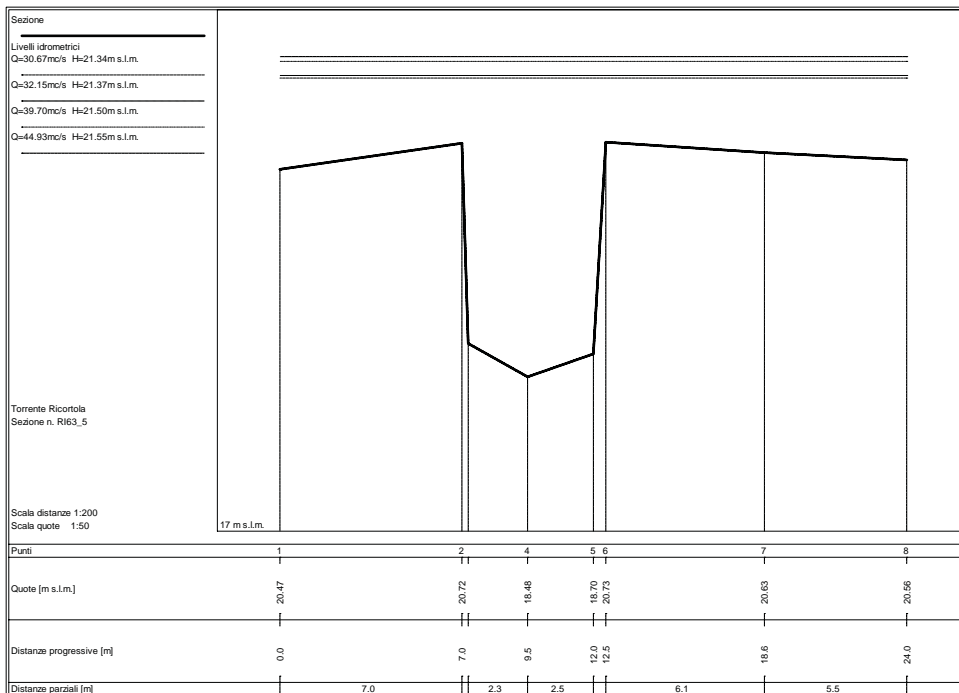
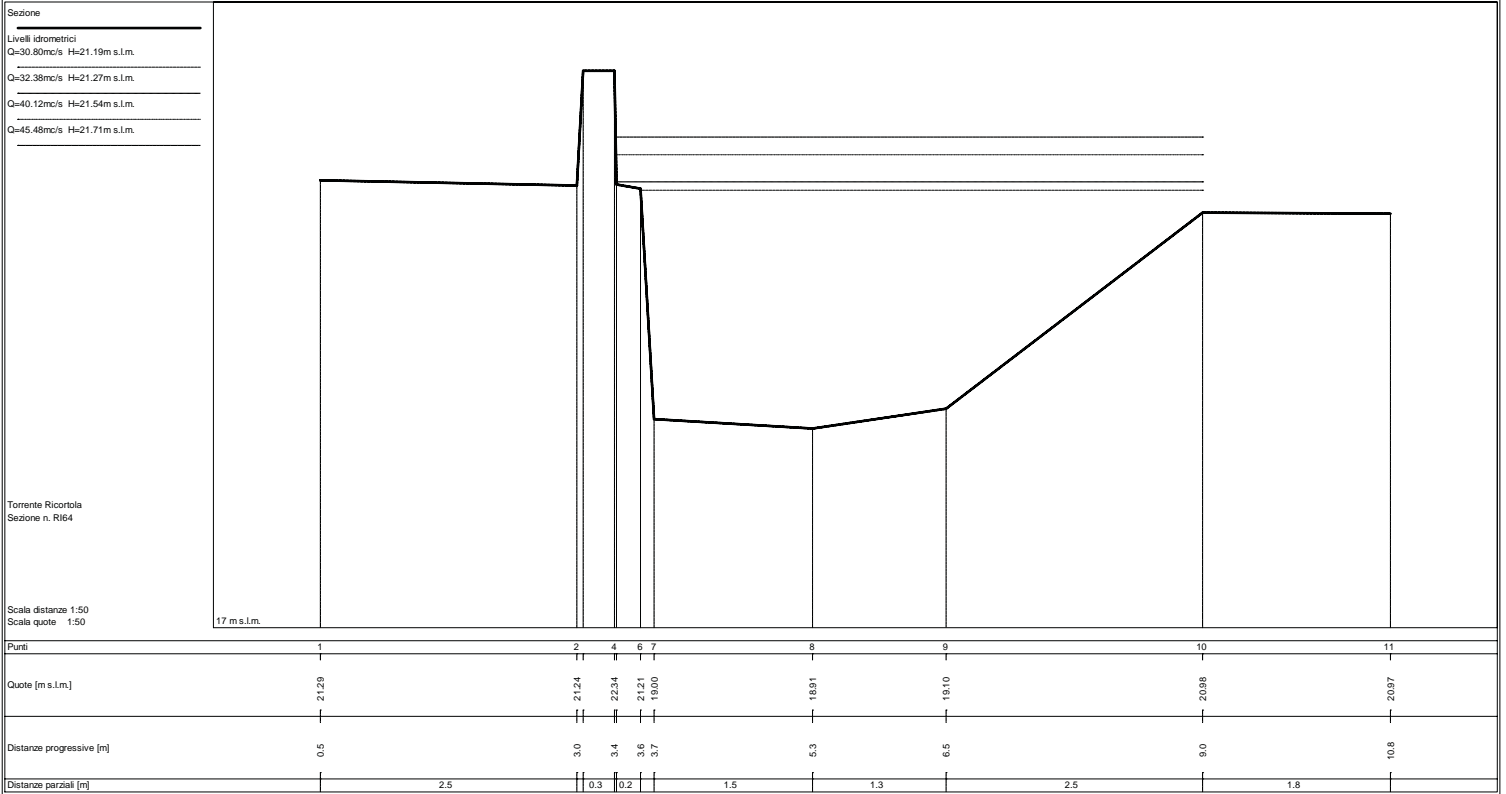

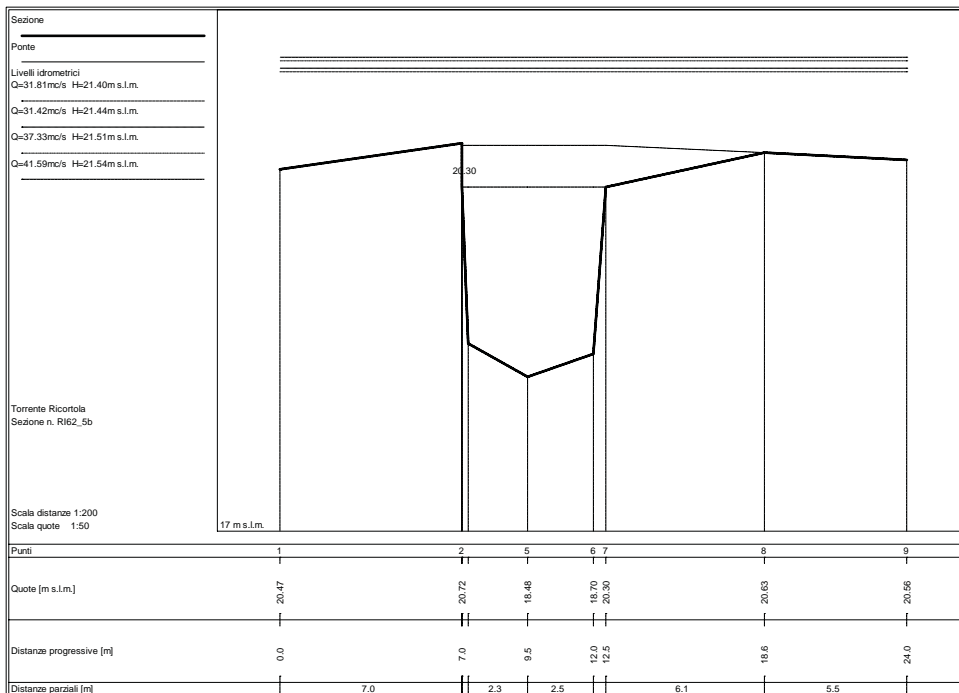
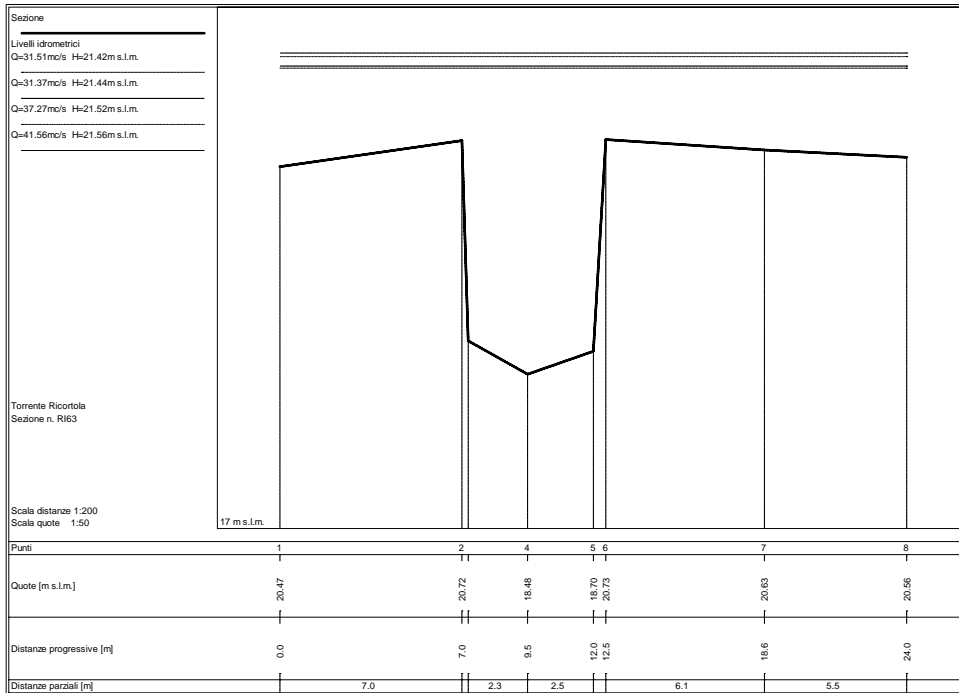

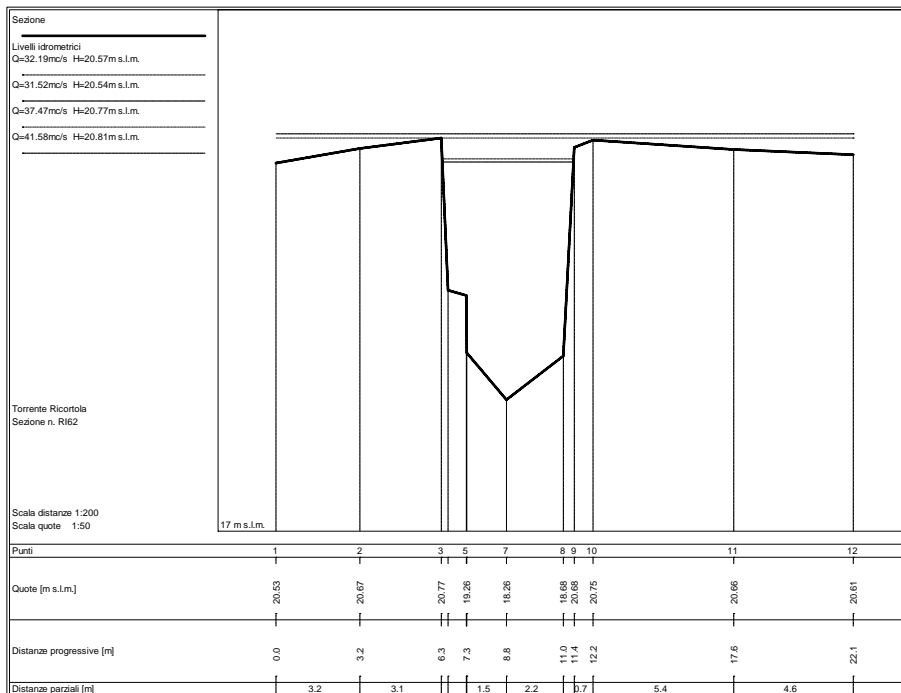
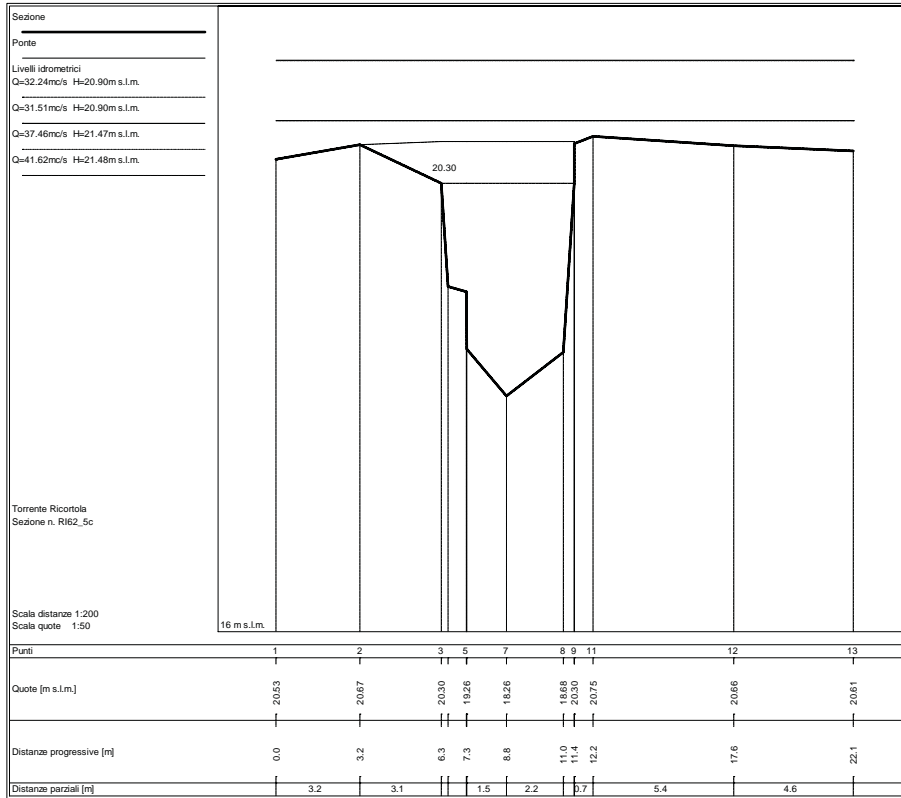

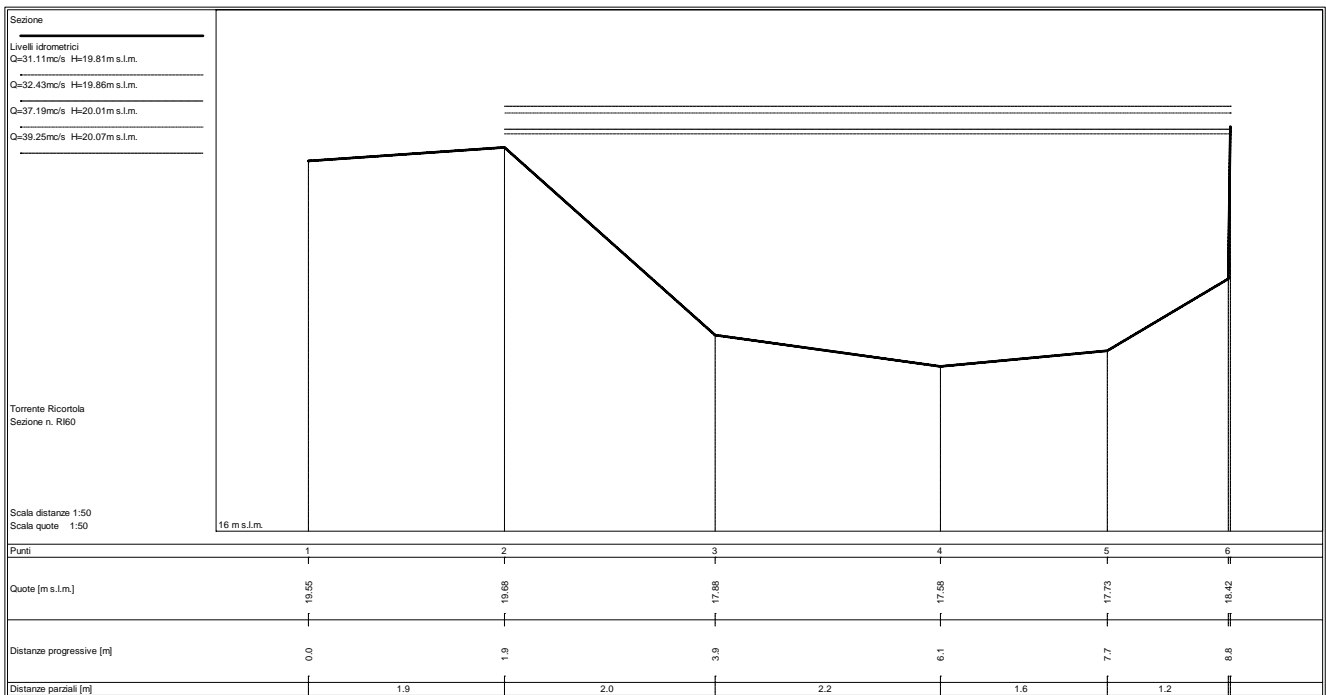
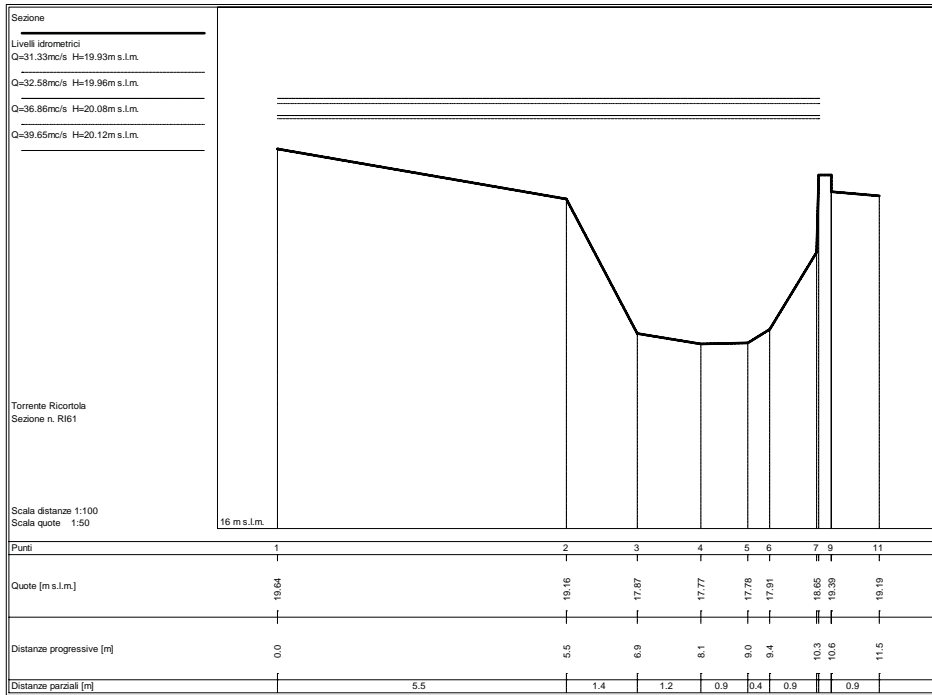

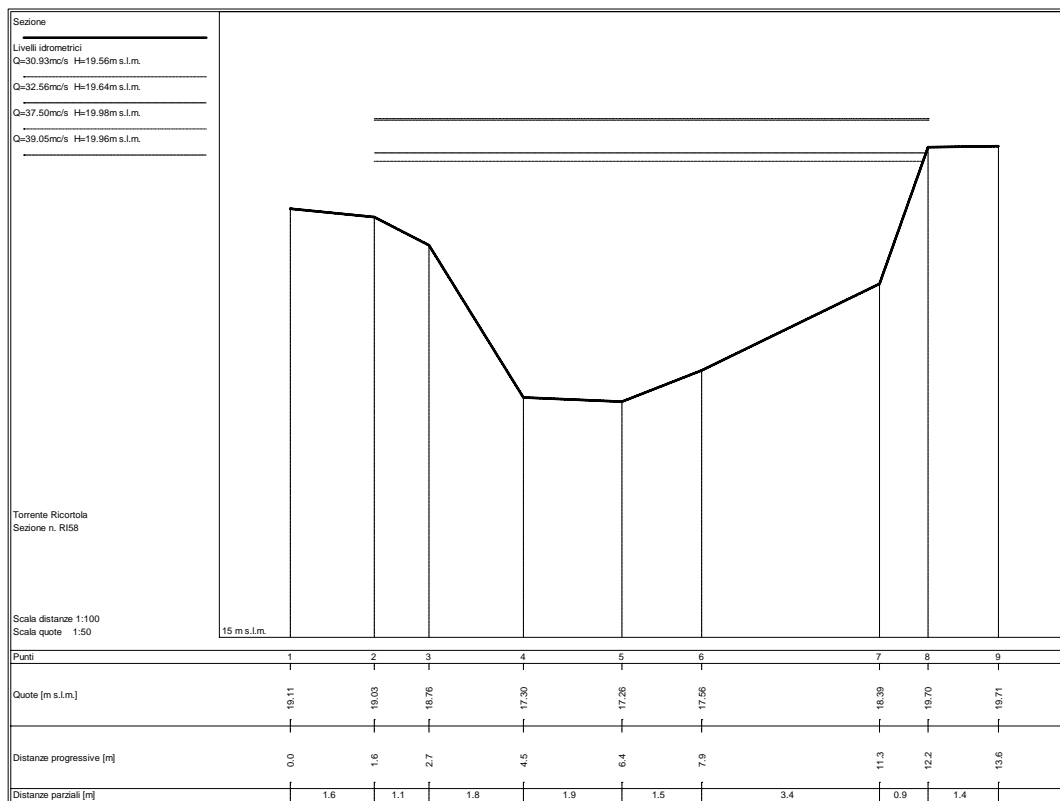
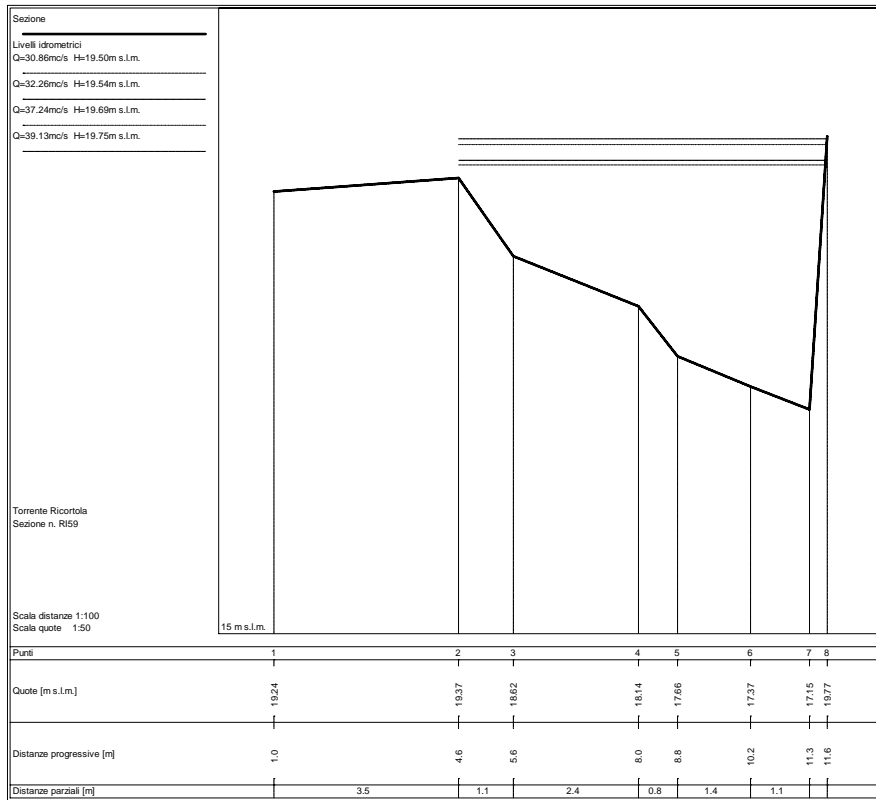

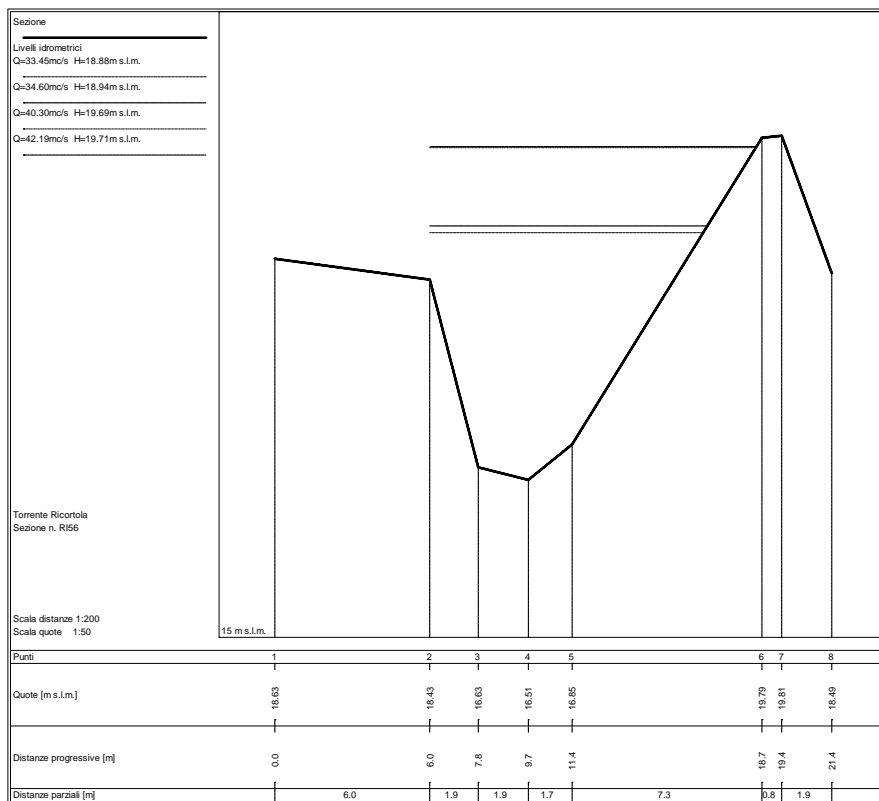
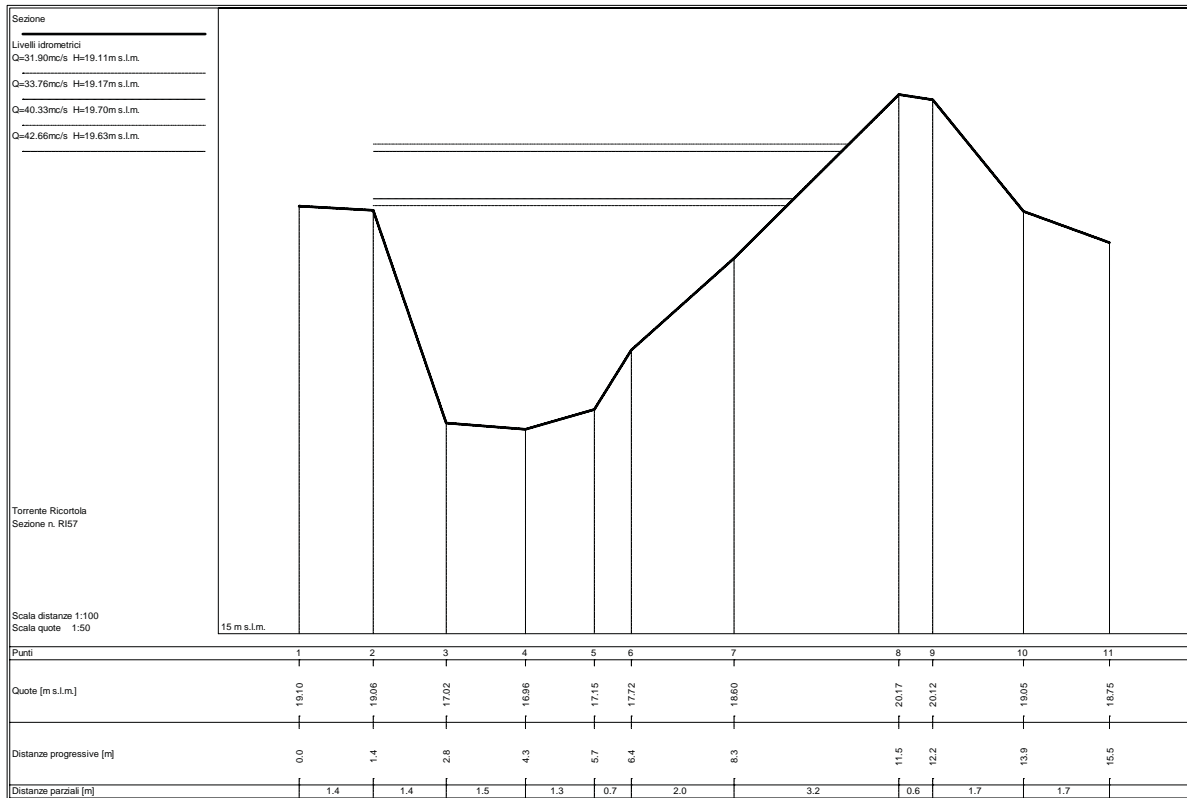

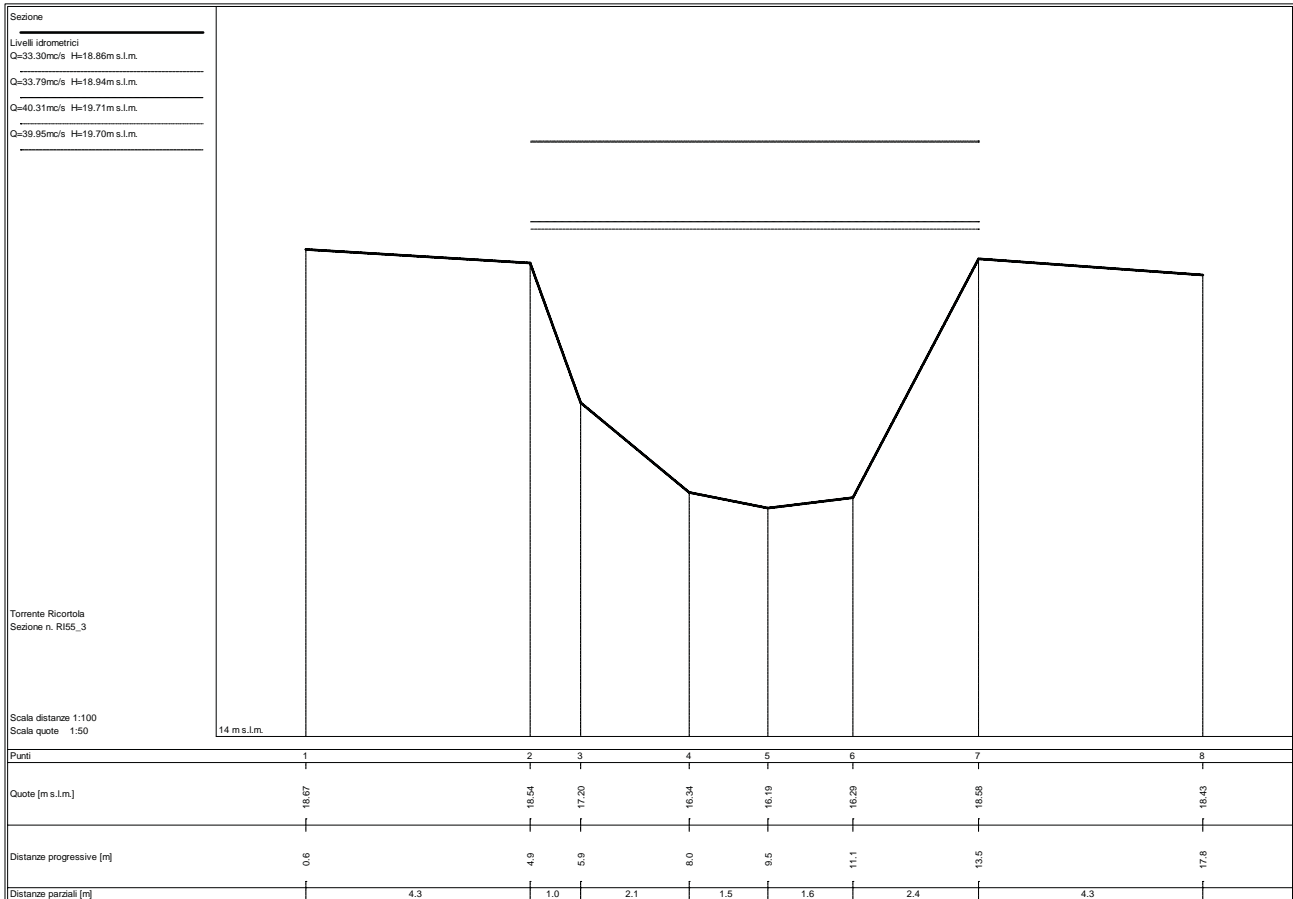
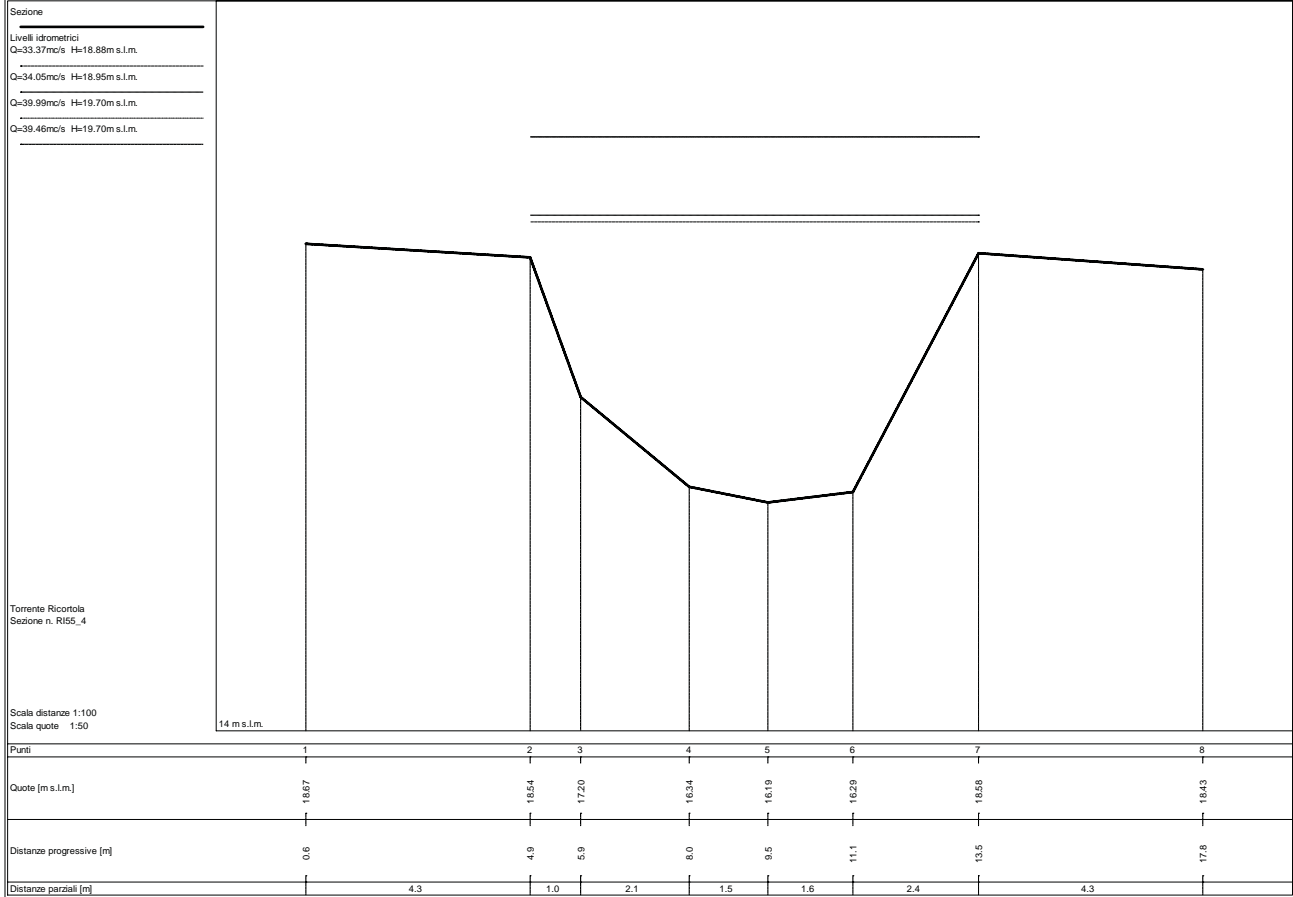

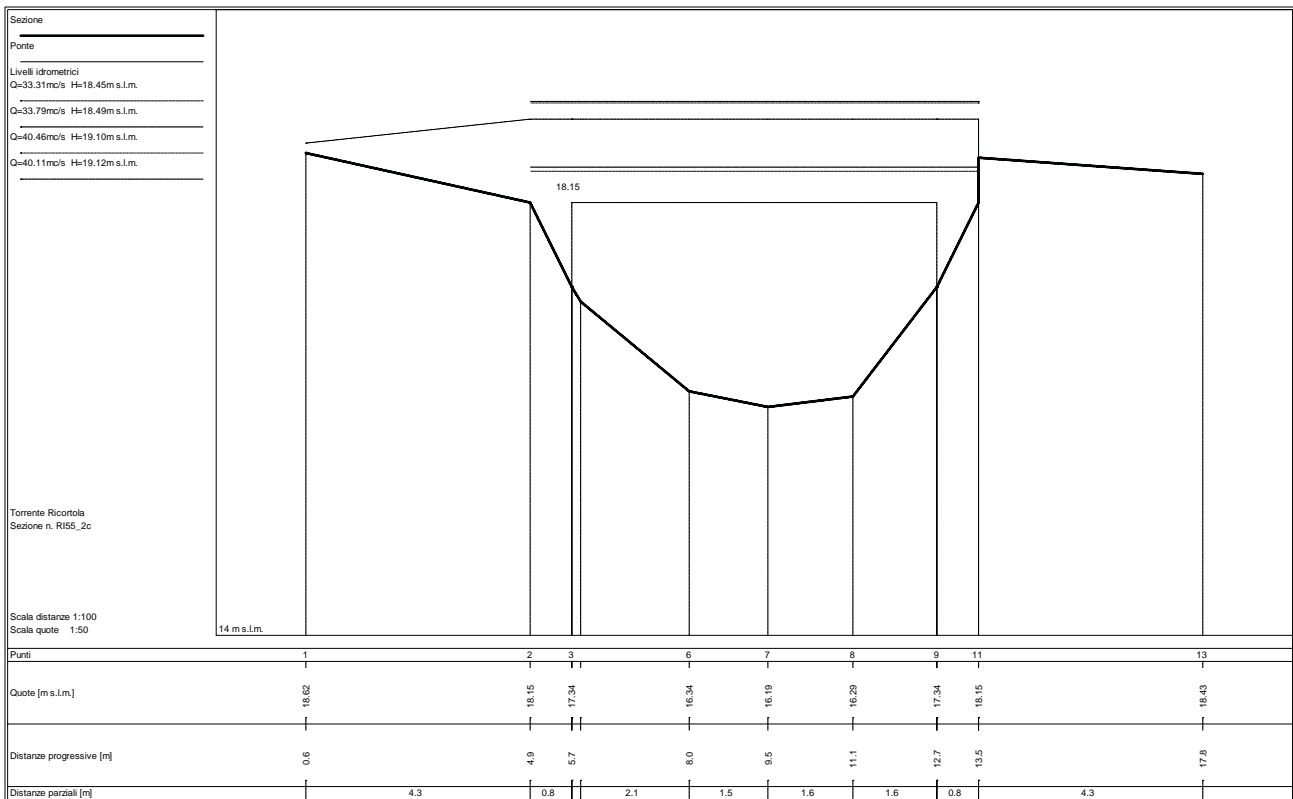
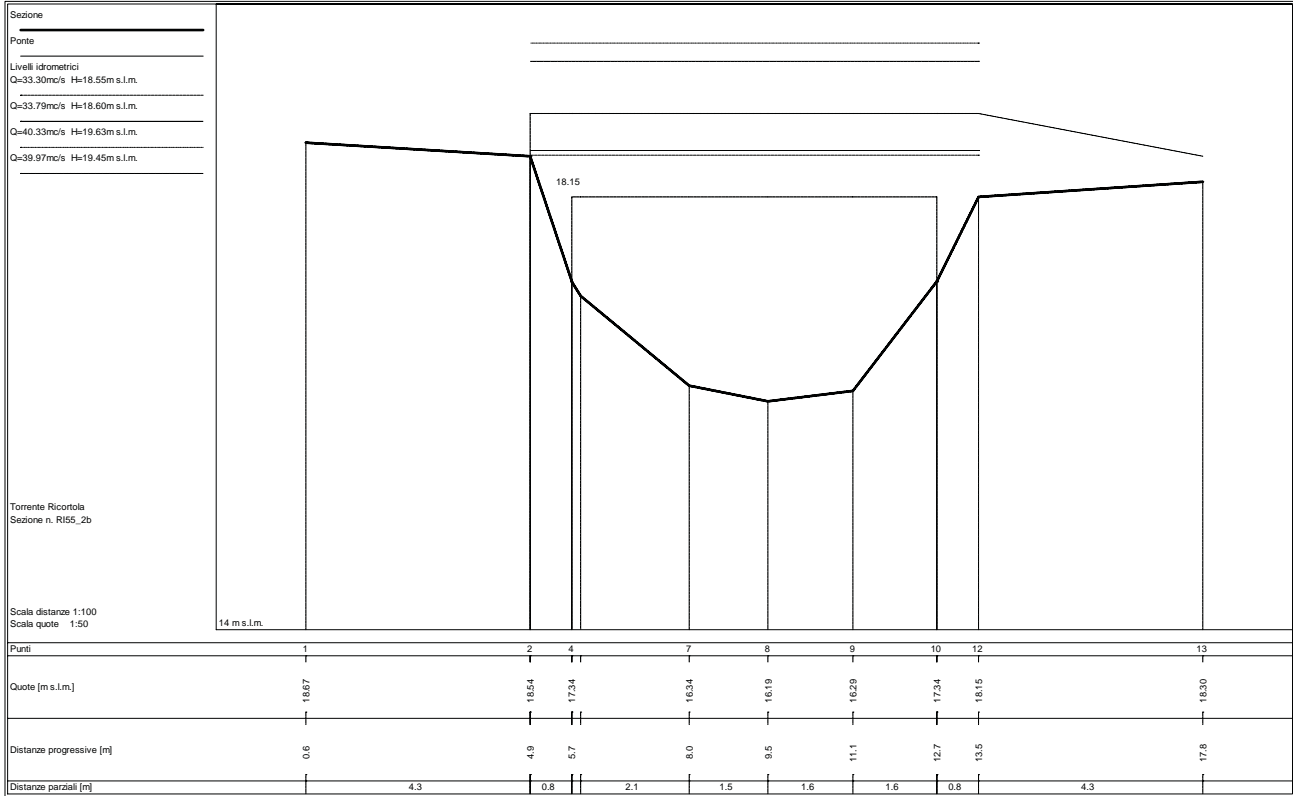

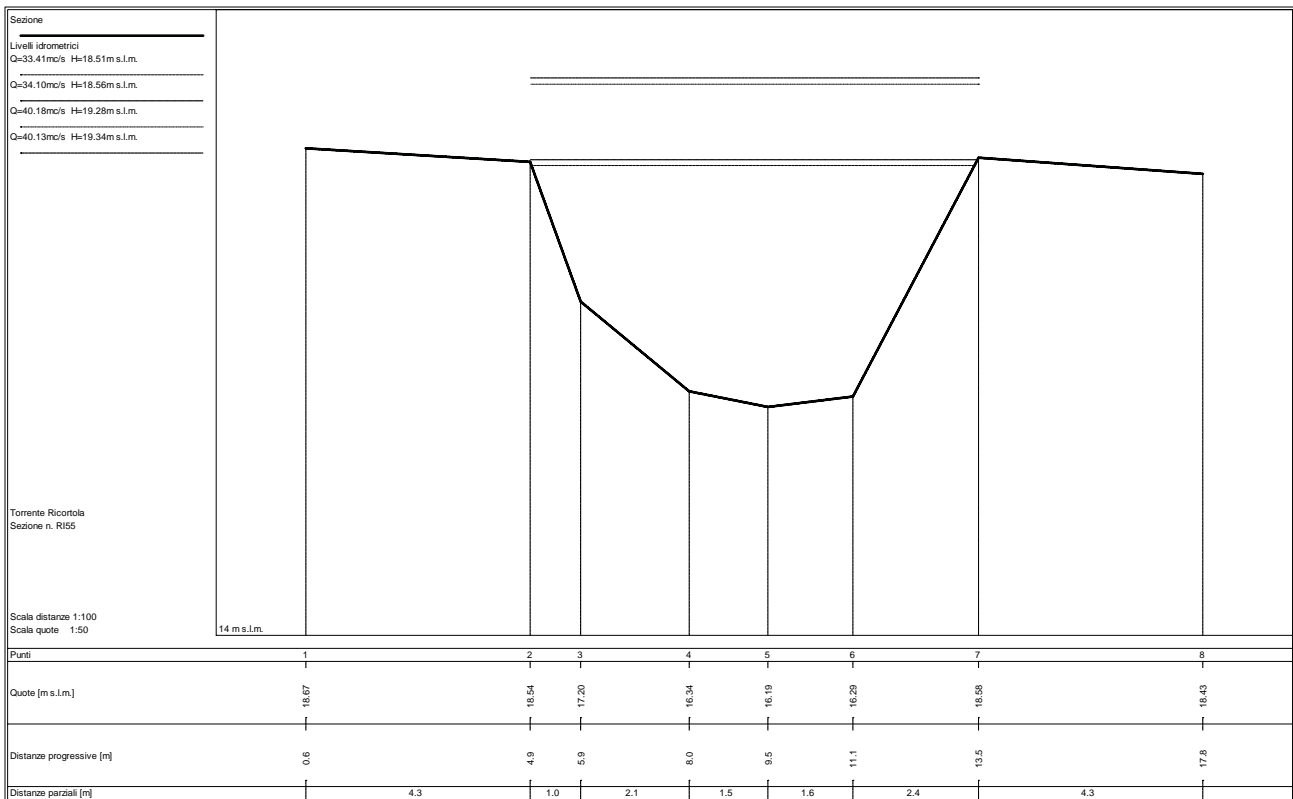
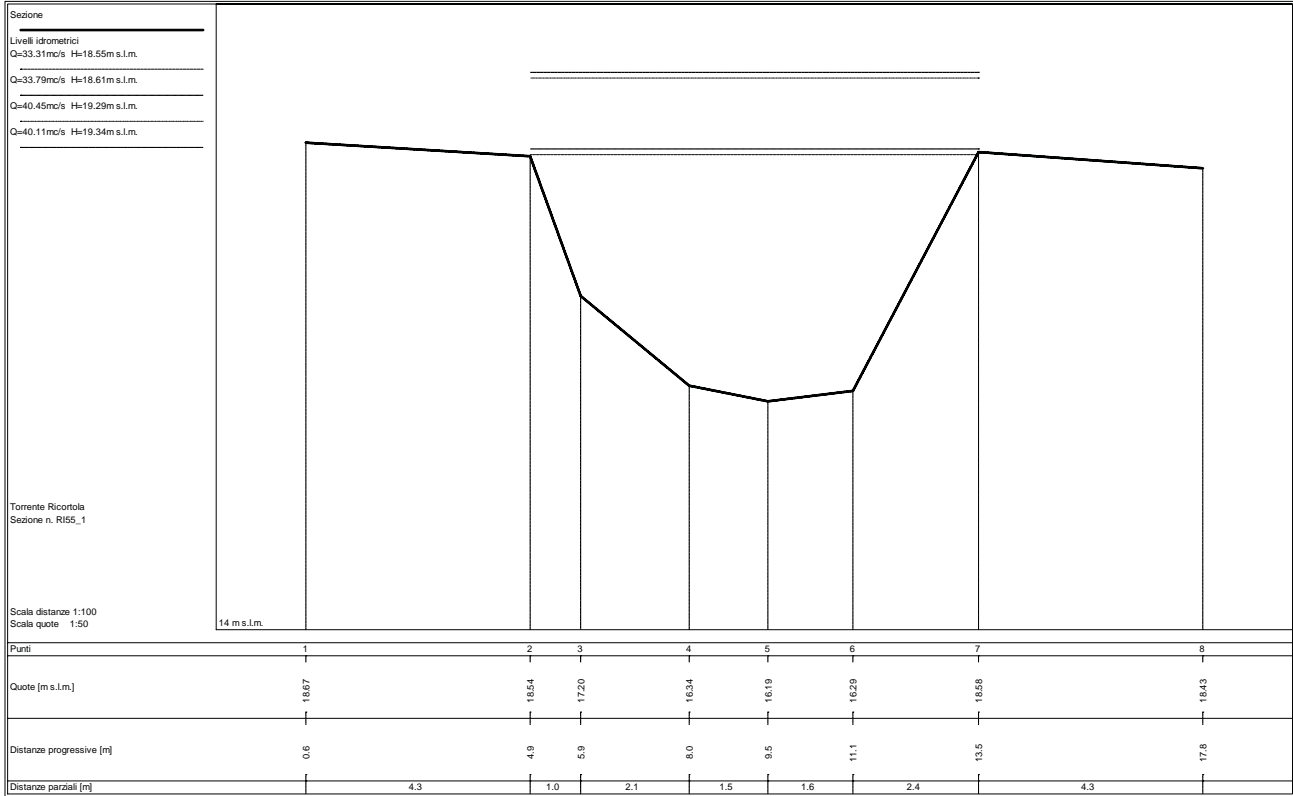

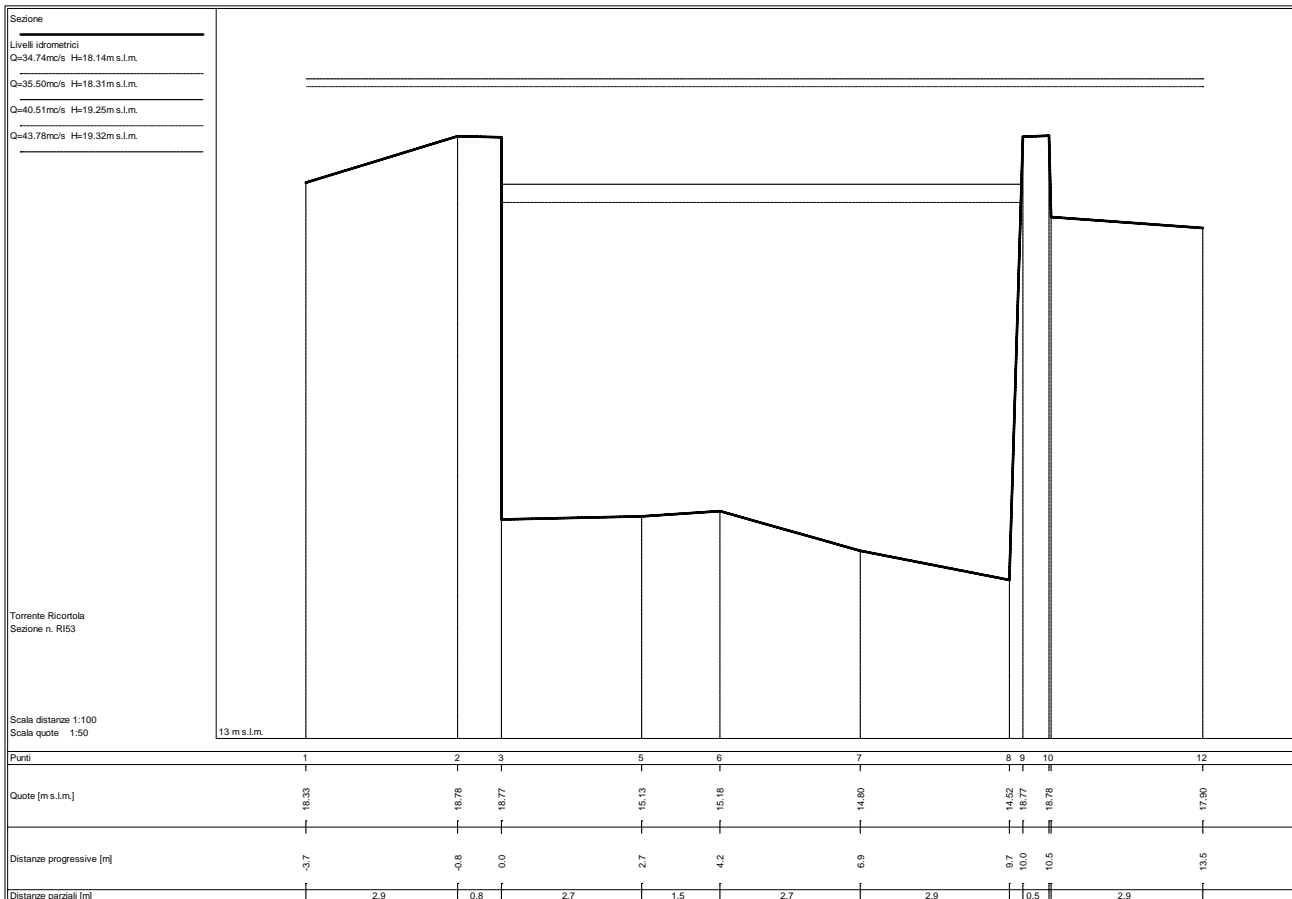
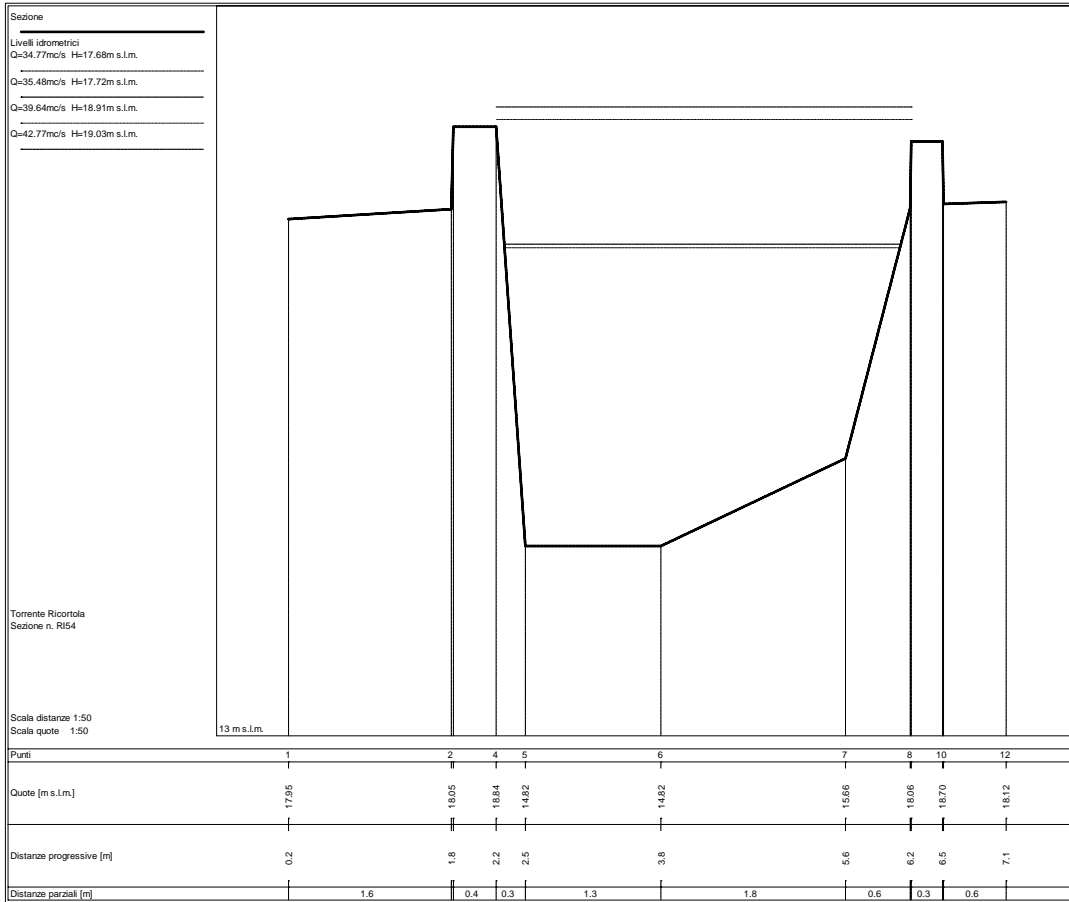

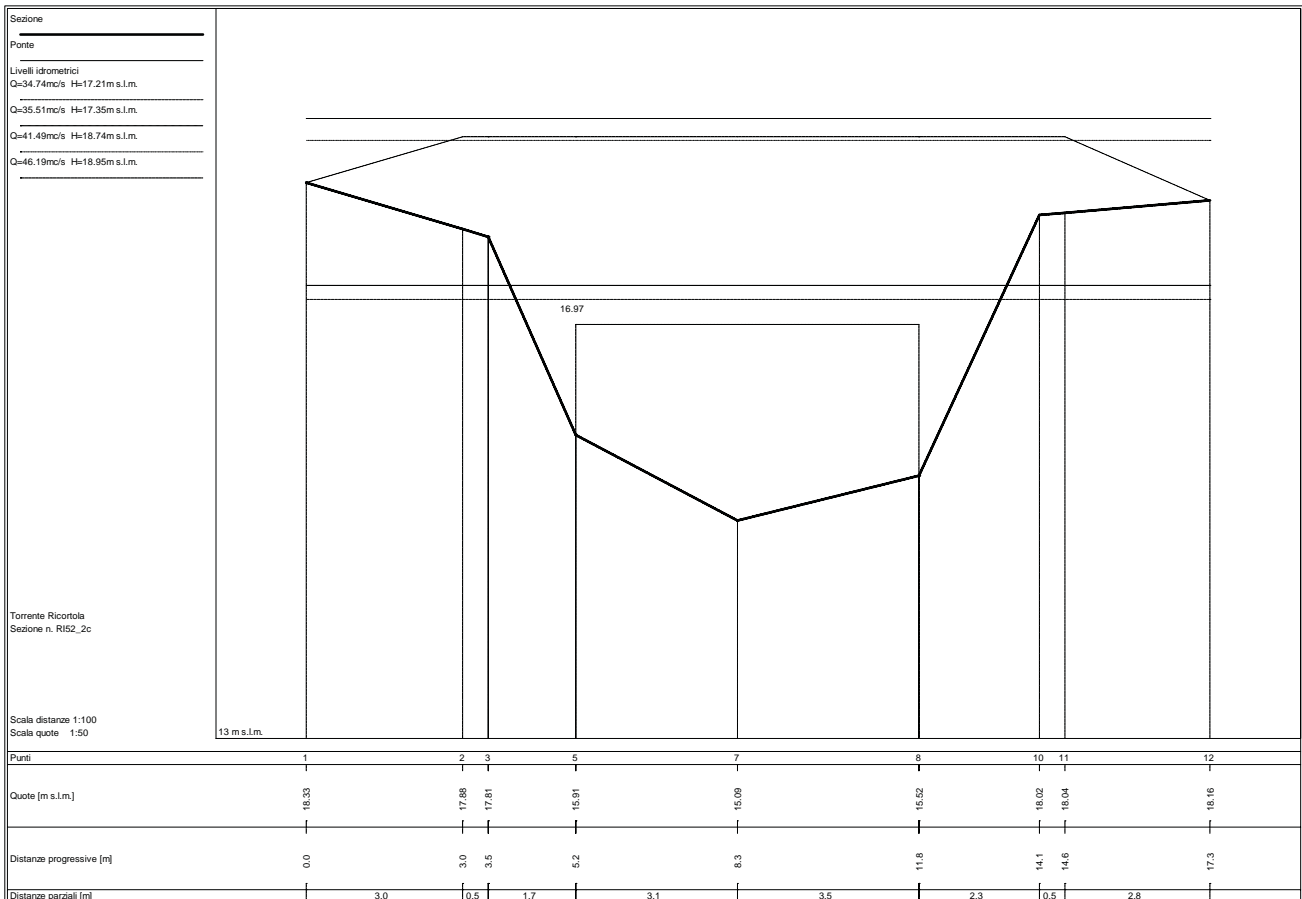
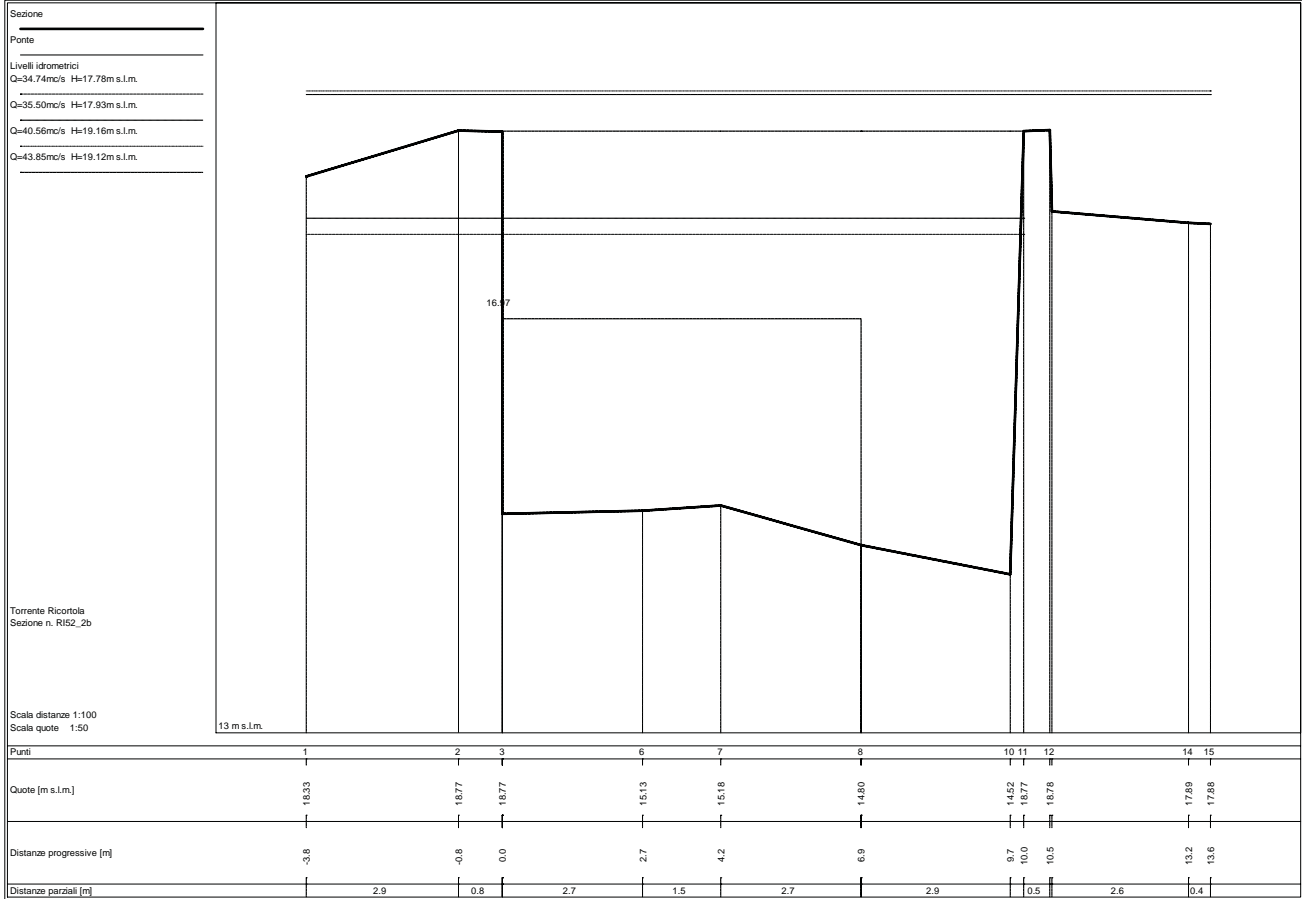

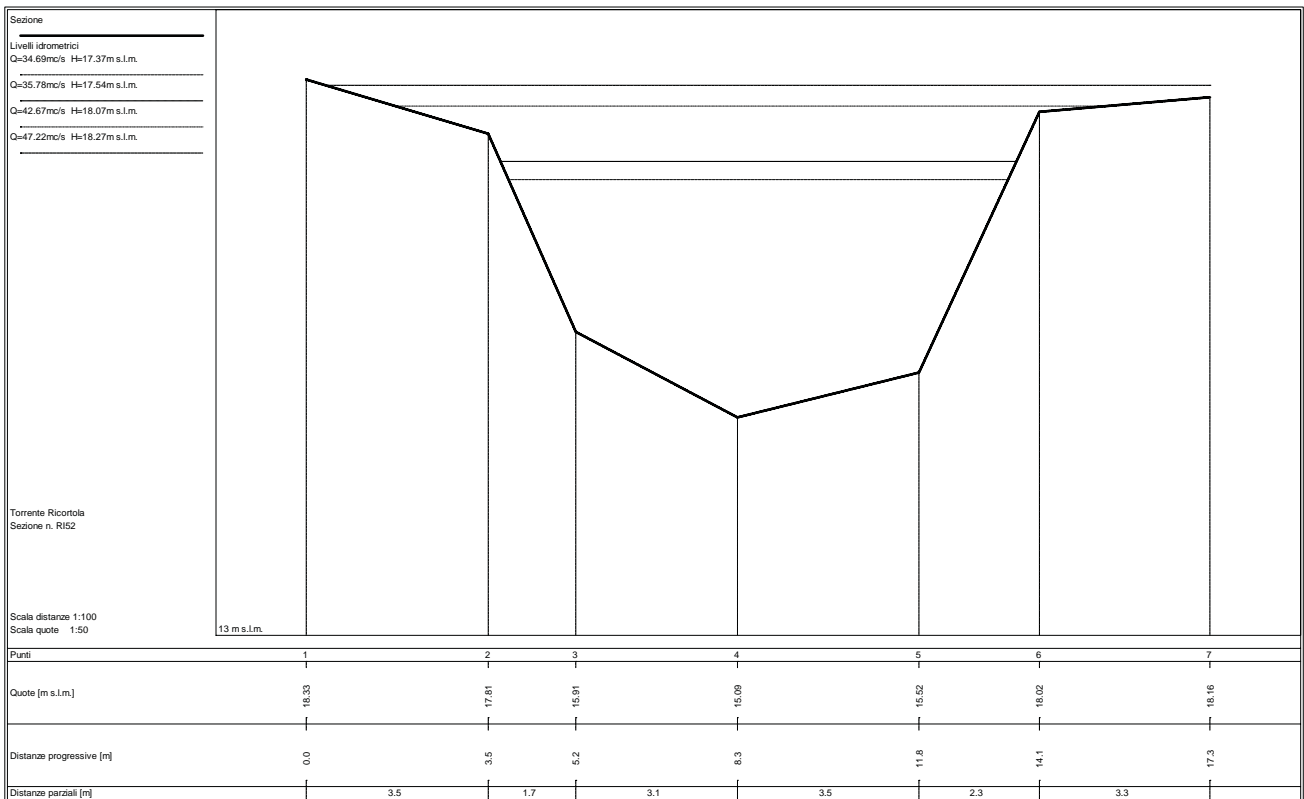
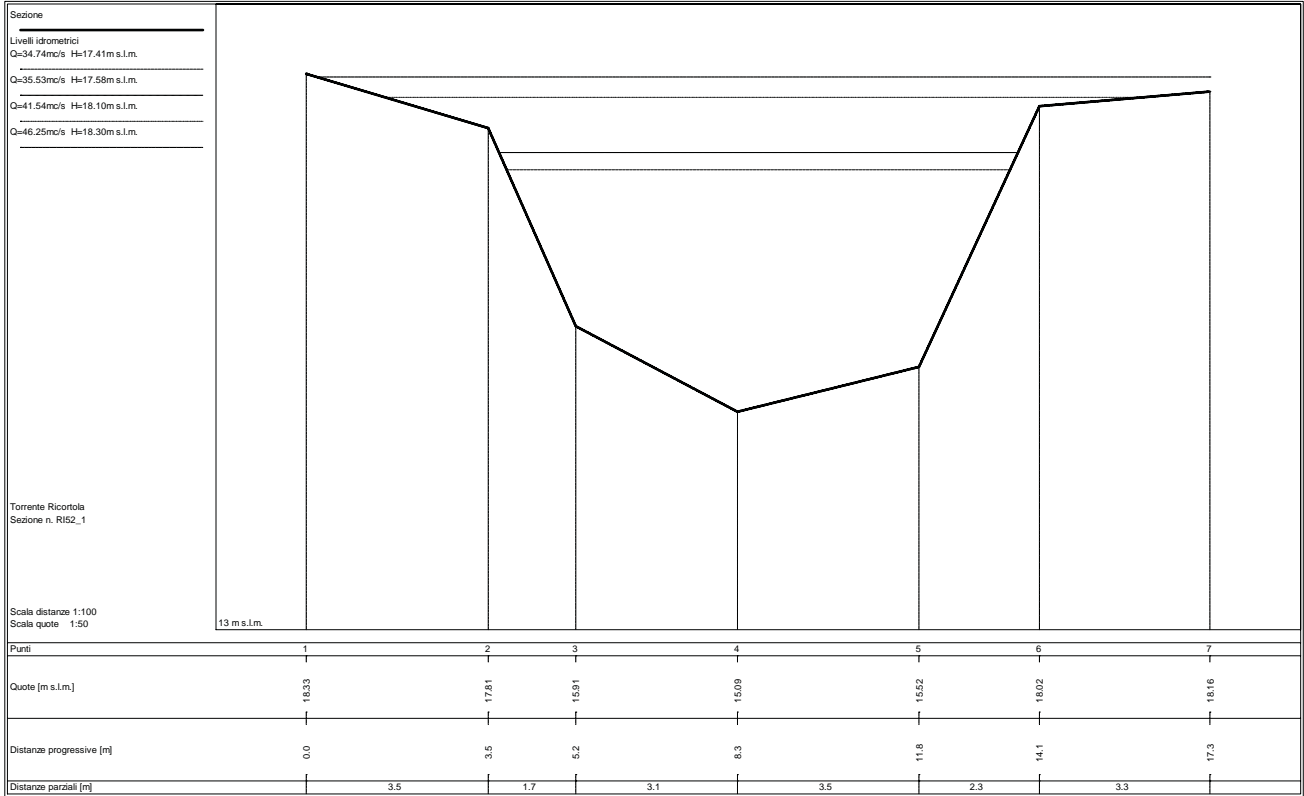

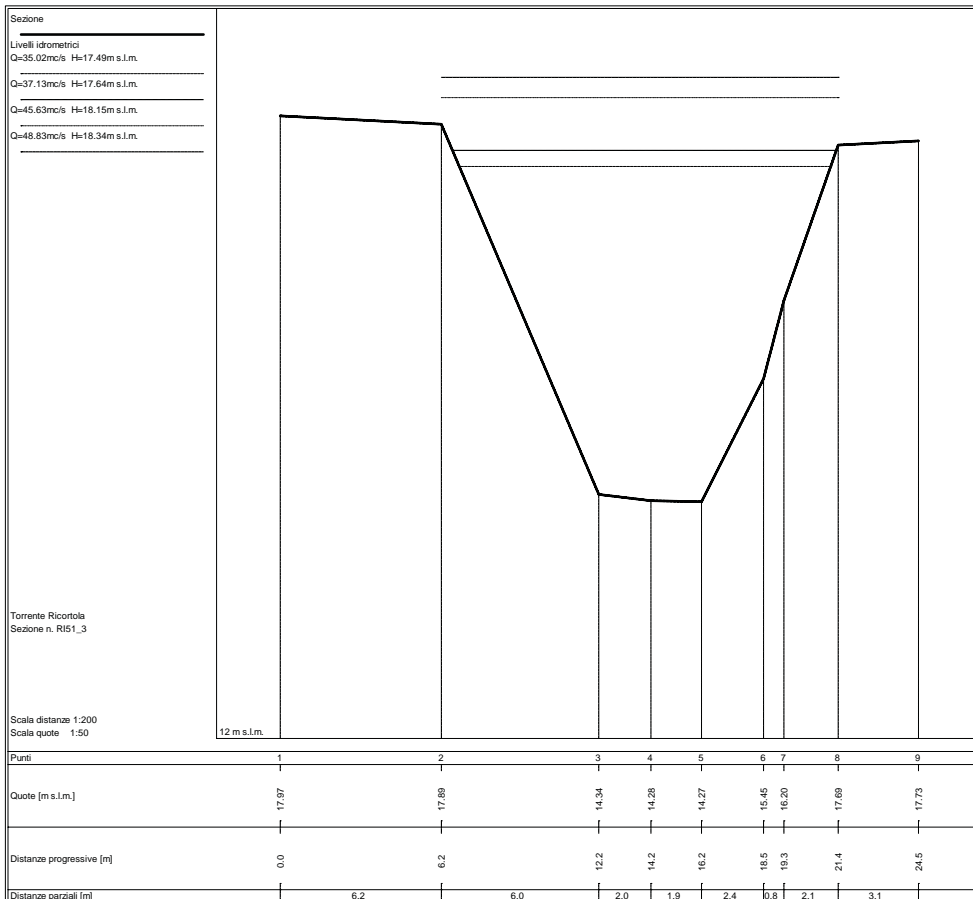
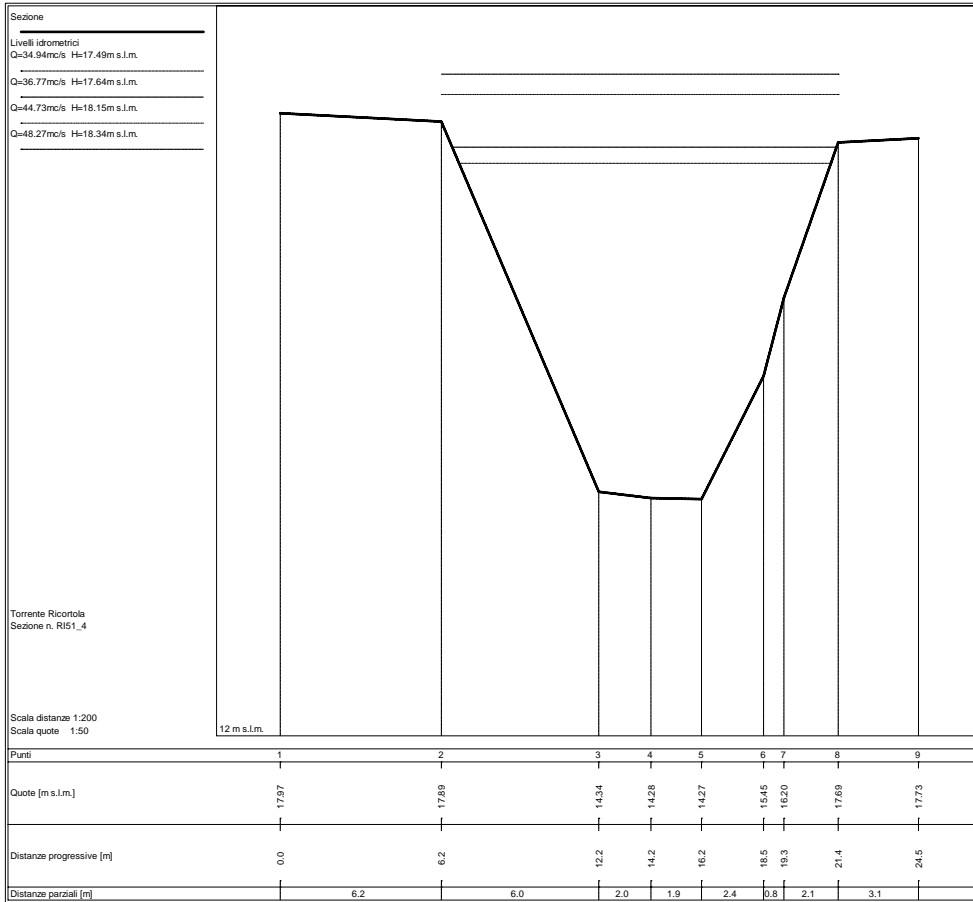

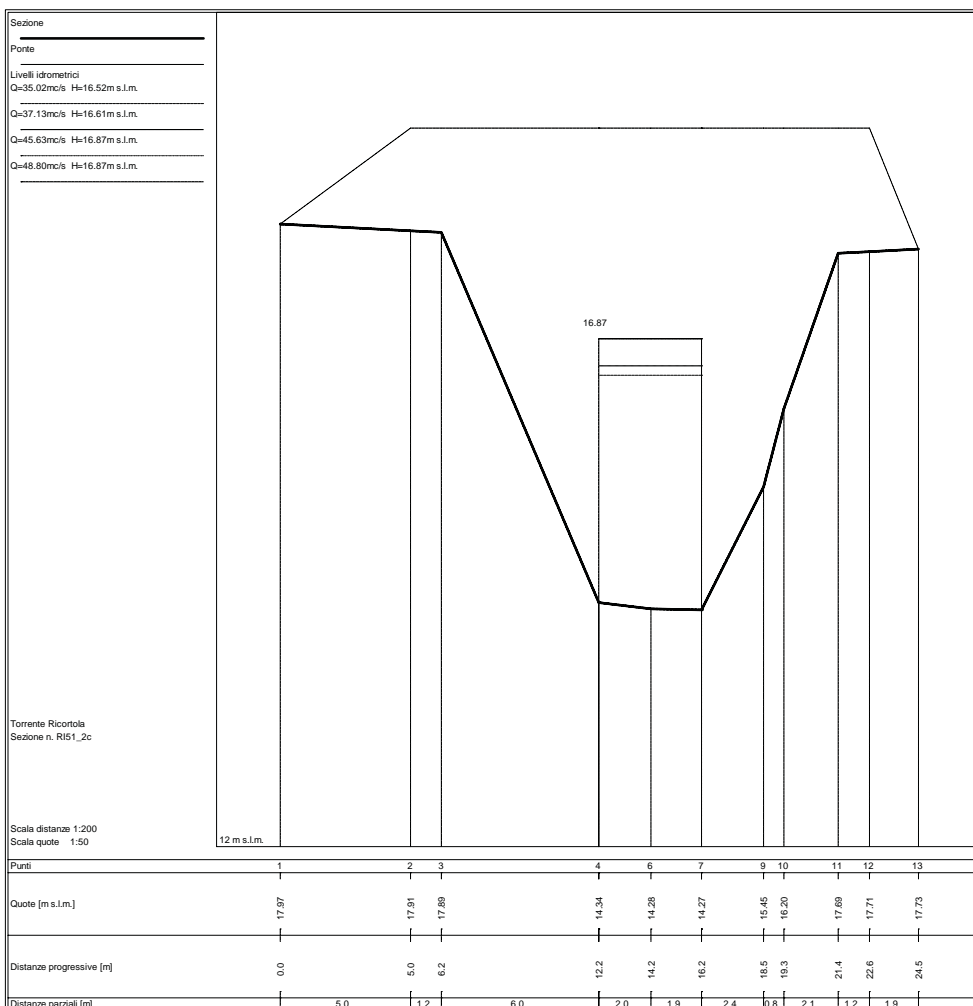
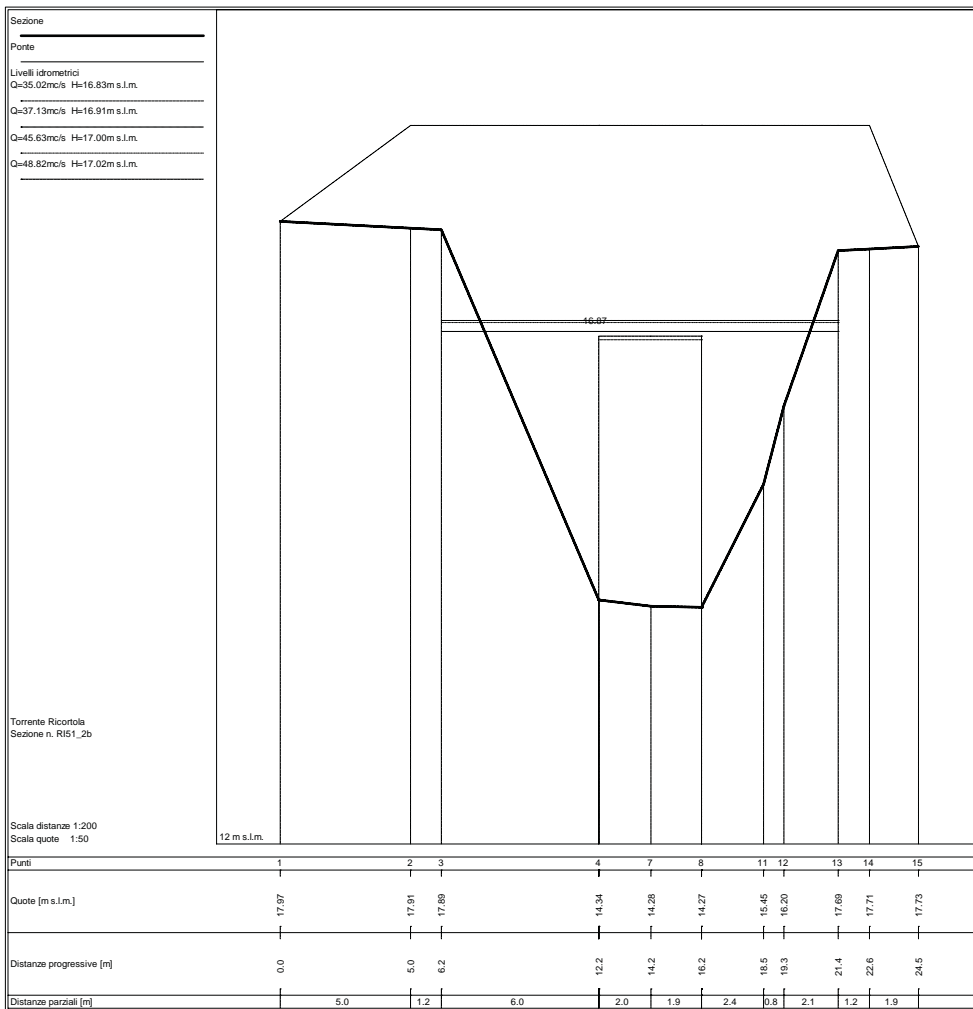

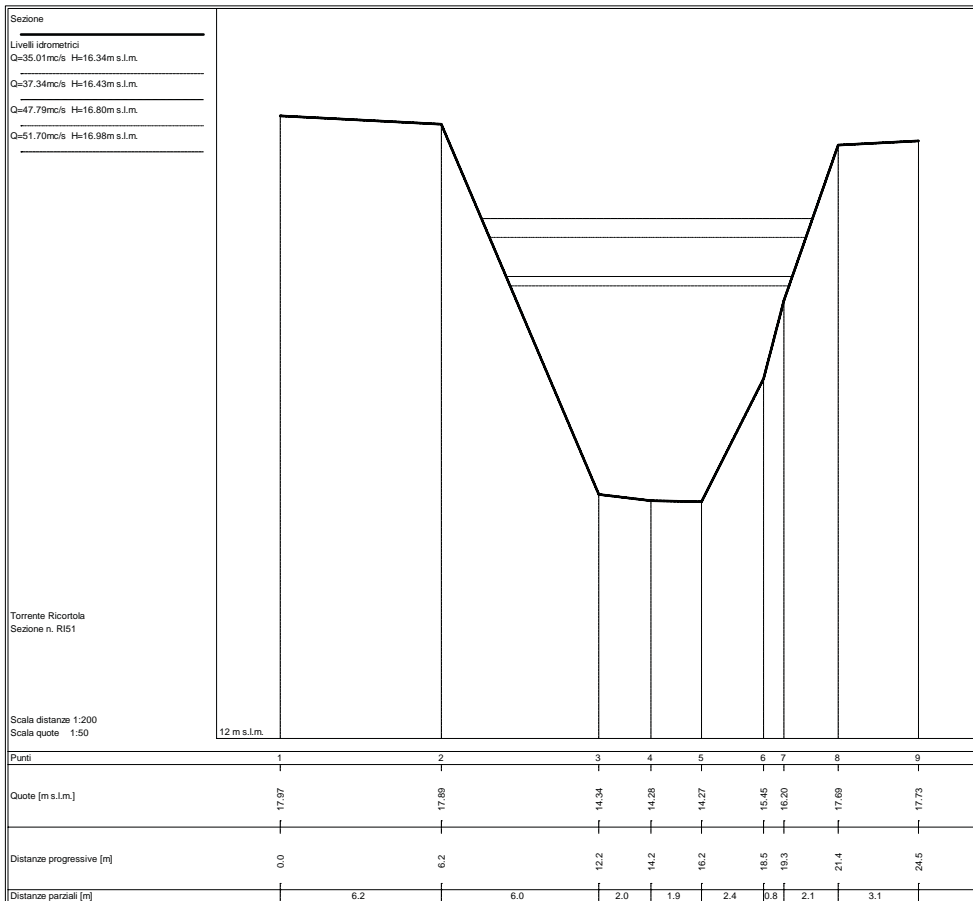
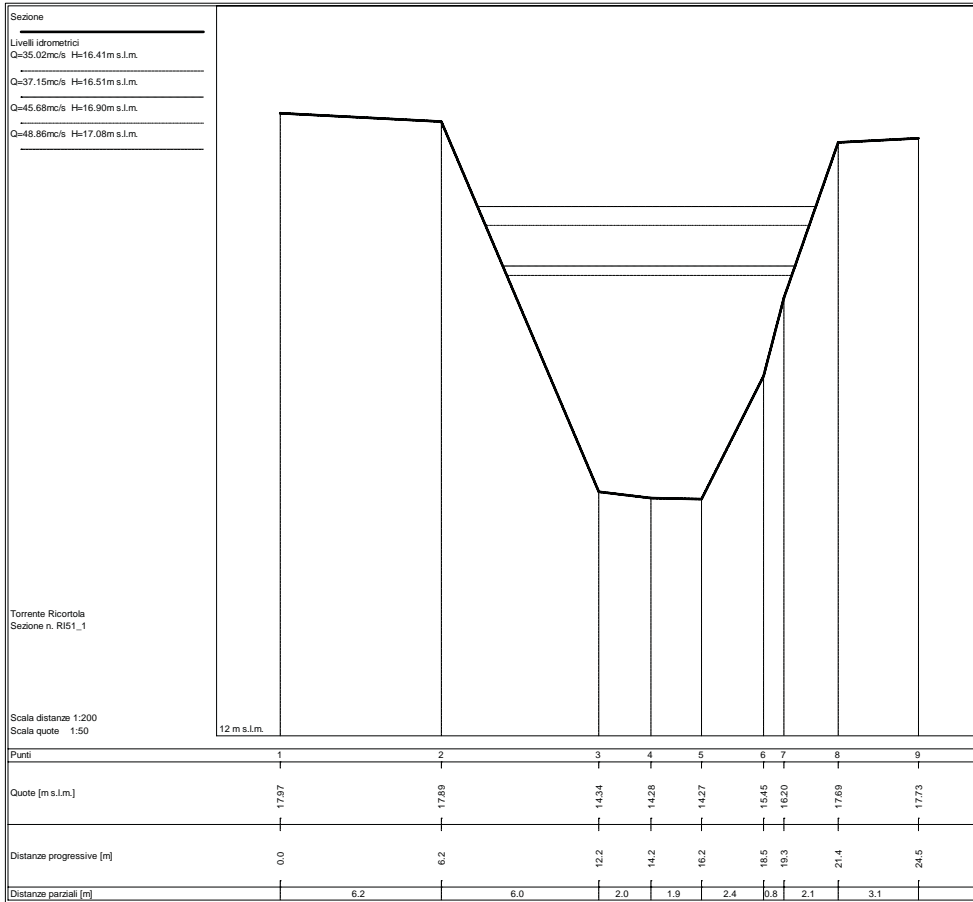

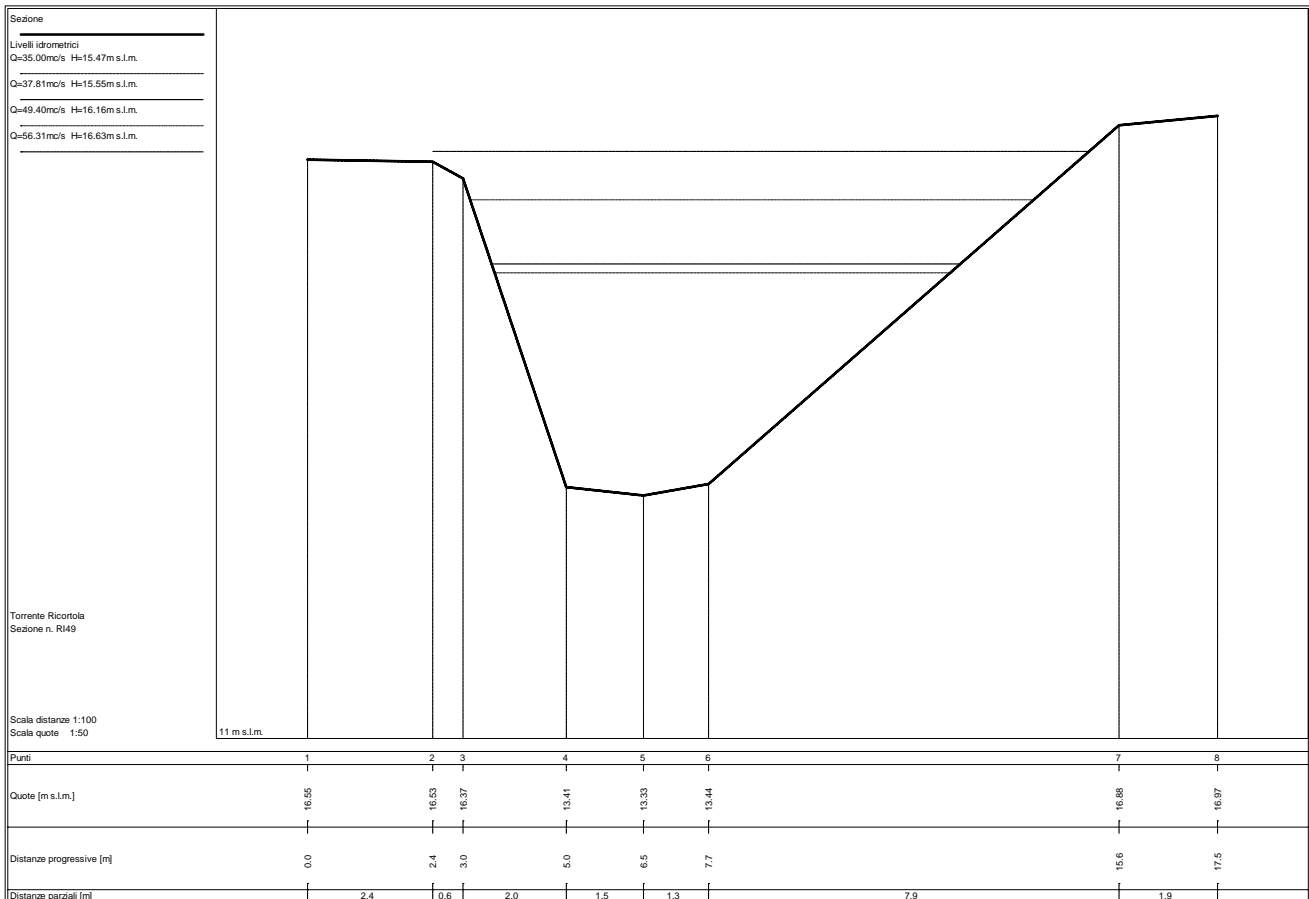
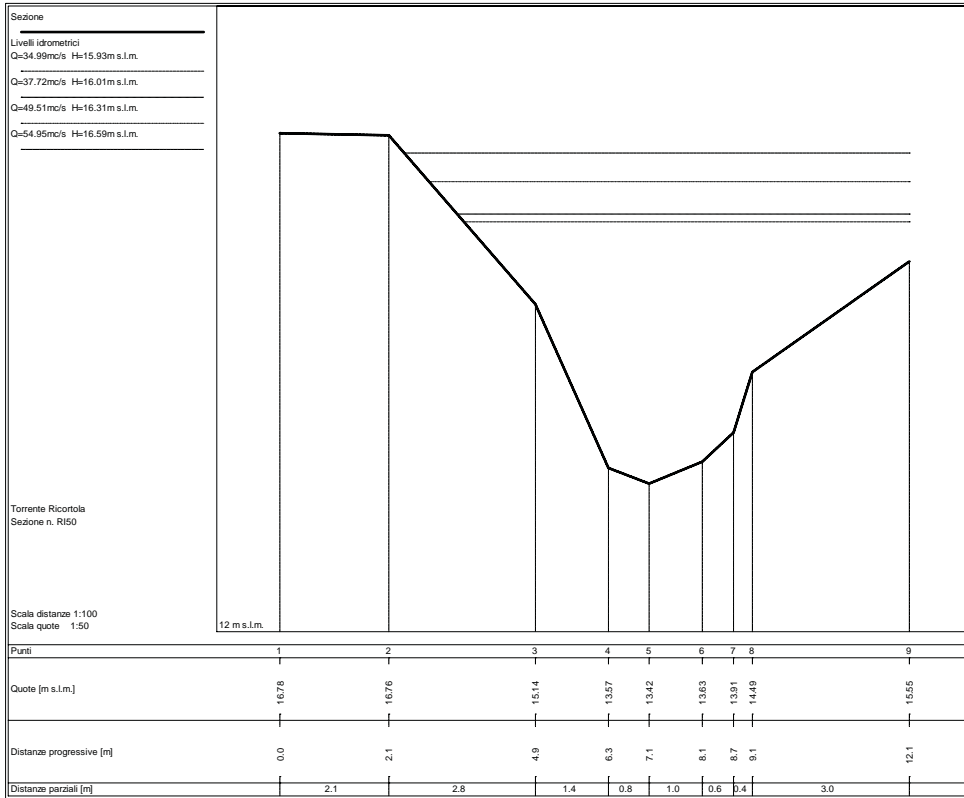

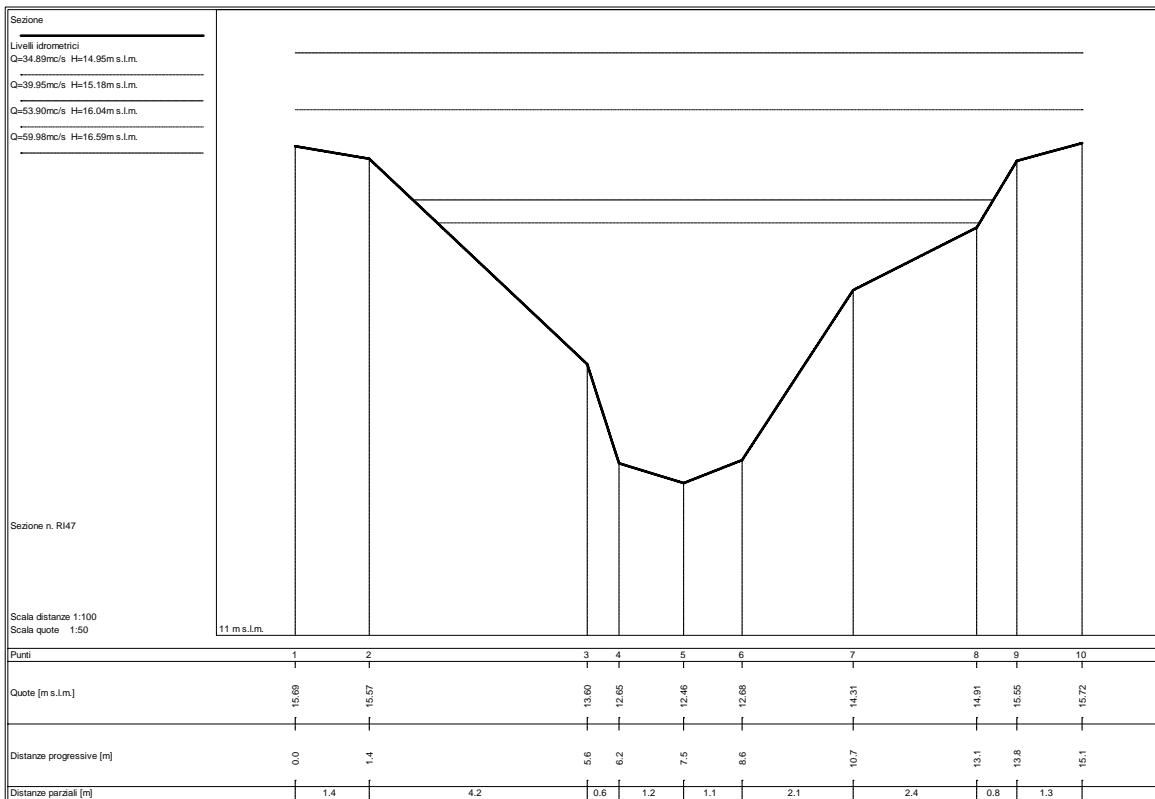
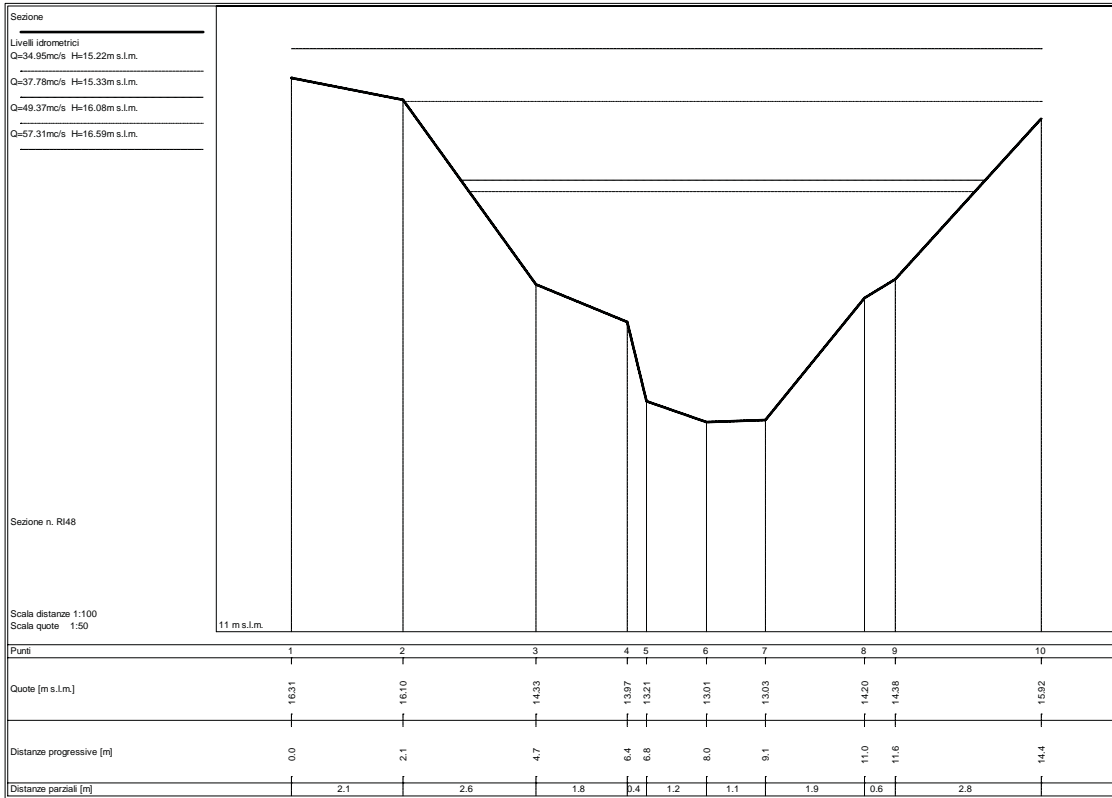

Sezione
 Livelli idrometrici
 Q=34.79mc/s H=14.91m s.l.m.
 Q=39.78mc/s H=15.24m s.l.m.
 Q=56.88mc/s H=16.08m s.l.m.
 Q=65.60mc/s H=16.61m s.l.m.

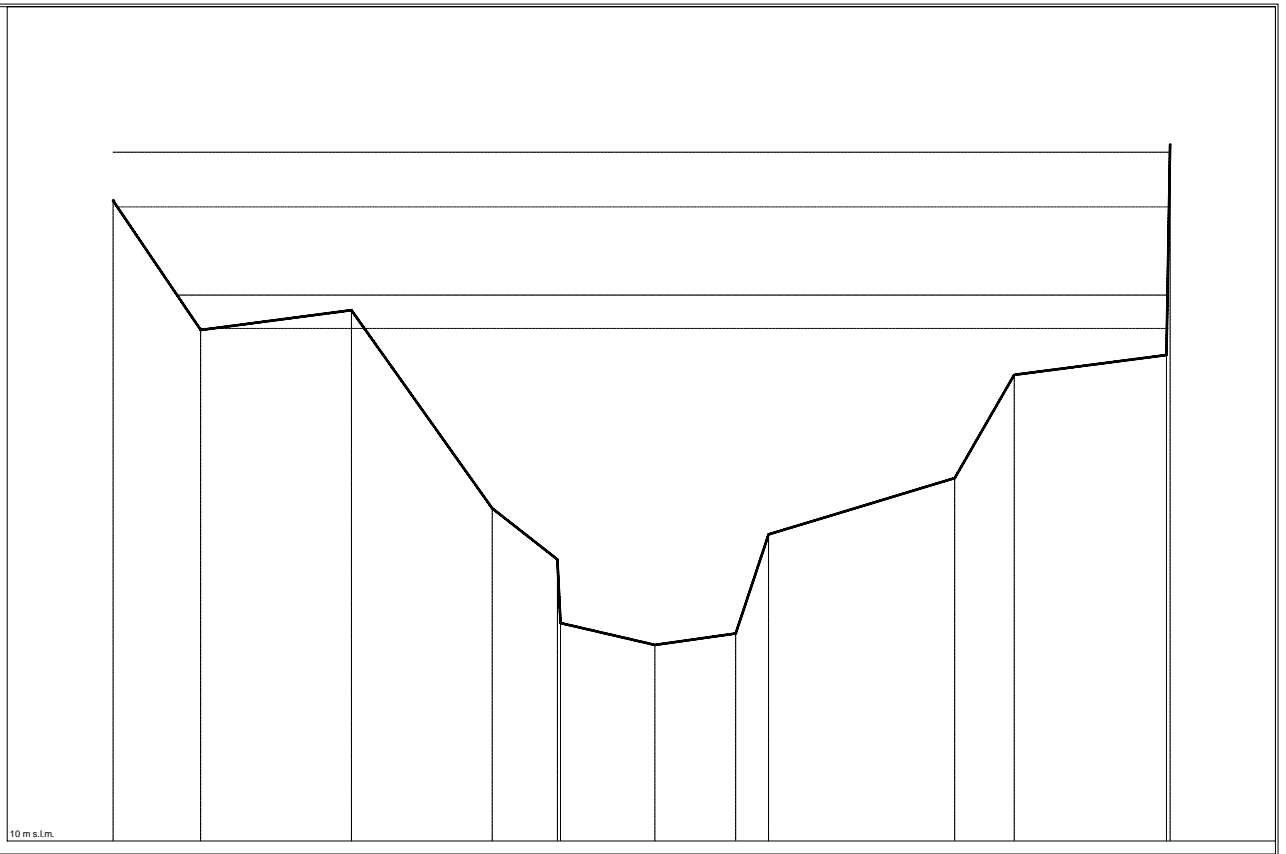

Sezione n. RI46
 Scala distanze 1:100
 Scala quote 1:50

Punti	1	2	3	4	5	7	8	9	10	11	12
Quote [m s.l.m.]	16.14	14.90	15.09	13.19	12.70	11.88	11.99	12.94	13.48	14.47	14.66
Distanze progressive [m]	0.0	1.7	4.6	7.3	8.5	10.4	11.9	12.6	16.1	17.3	20.2
Distanze parziali [m]		1.7	2.9	2.7	1.3	1.8	1.5	0.6	3.6	1.1	2.9

Sezione
 Livelli idrometrici
 Q=40.06mc/s H=14.79m s.l.m.
 Q=45.93mc/s H=15.11m s.l.m.
 Q=62.72mc/s H=15.98m s.l.m.
 Q=70.87mc/s H=16.53m s.l.m.

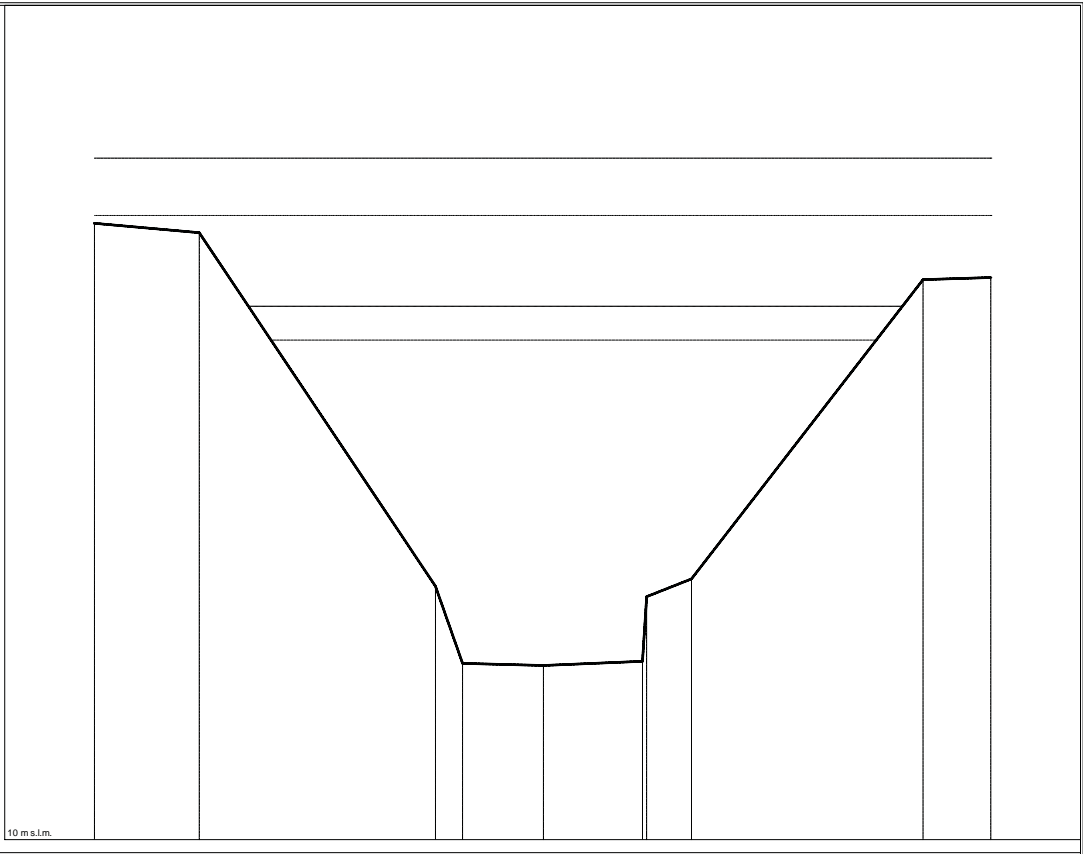

Sezione n. RI45
 Scala distanze 1:100
 Scala quote 1:50

Punti	1	2	3	4	5	6	7	8	9	10
Quote [m s.l.m.]	15.91	15.82	12.43	11.69	11.67	11.71	12.50	15.37	15.39	
Distanze progressive [m]	0.0	2.0	6.5	7.1	8.6	10.5	11.5	15.9	17.2	
Distanze parziali [m]		2.0	4.5	0.5	1.6	1.9	0.9	4.4	1.3	

Sezione

Livelli idrometrici

Q=40.06m³/s H=14.78m s.l.m.

Q=45.93m³/s H=15.11m s.l.m.

Q=62.56m³/s H=15.98m s.l.m.

Q=70.13m³/s H=16.53m s.l.m.

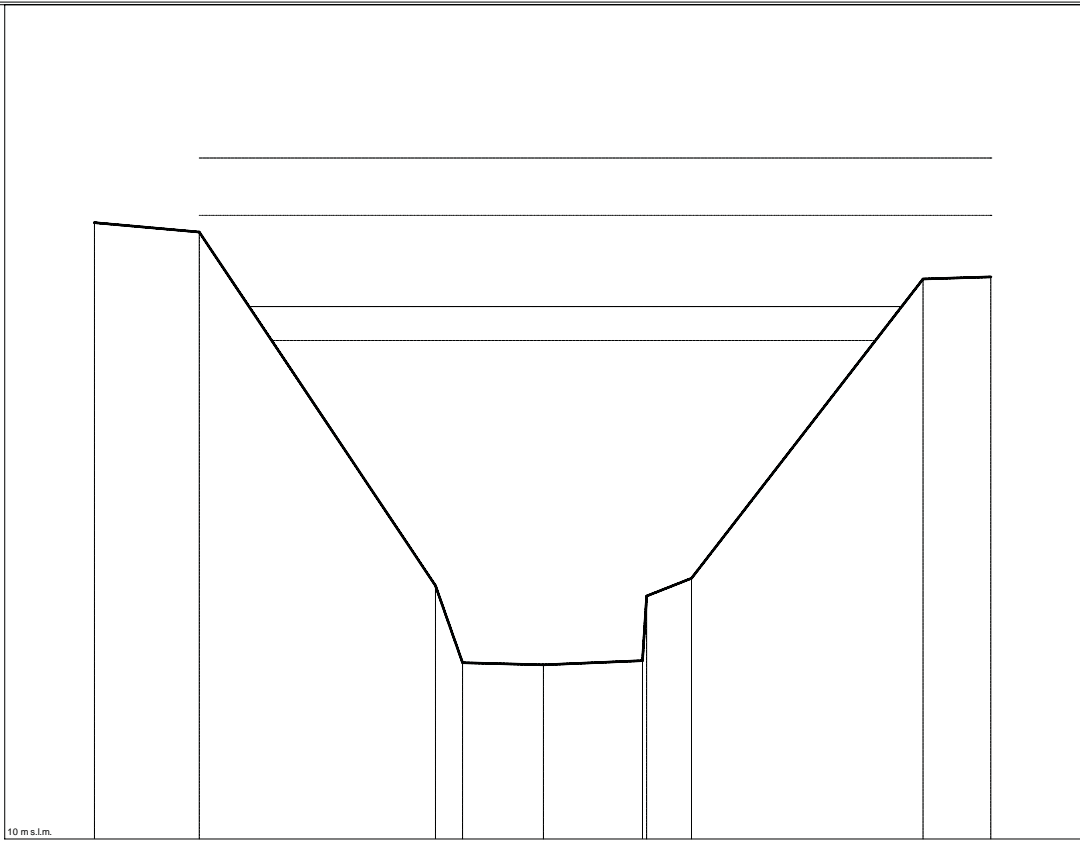

Torrente Ricortola
Sezione n. R144_3

Scala distanze 1:100
Scala quote 1:50

Punti	1	2	3	4	5	6	8	9	10
Quote [m s.l.m.]	15.91	15.82	12.43	11.69	11.67	11.71	12.50	15.37	15.39
Distanze progressive [m]	0.0	2.0	6.5	7.1	8.6	10.5	11.5	16.9	17.2
Distanze parziali [m]		2.0	4.5	0.5	1.6	1.9	0.9	4.4	1.3

Sezione

Porte

Livelli idrometrici

Q=40.06m³/s H=14.04m s.l.m.

Q=45.93m³/s H=14.26m s.l.m.

Q=62.56m³/s H=14.82m s.l.m.

Q=70.13m³/s H=15.01m s.l.m.

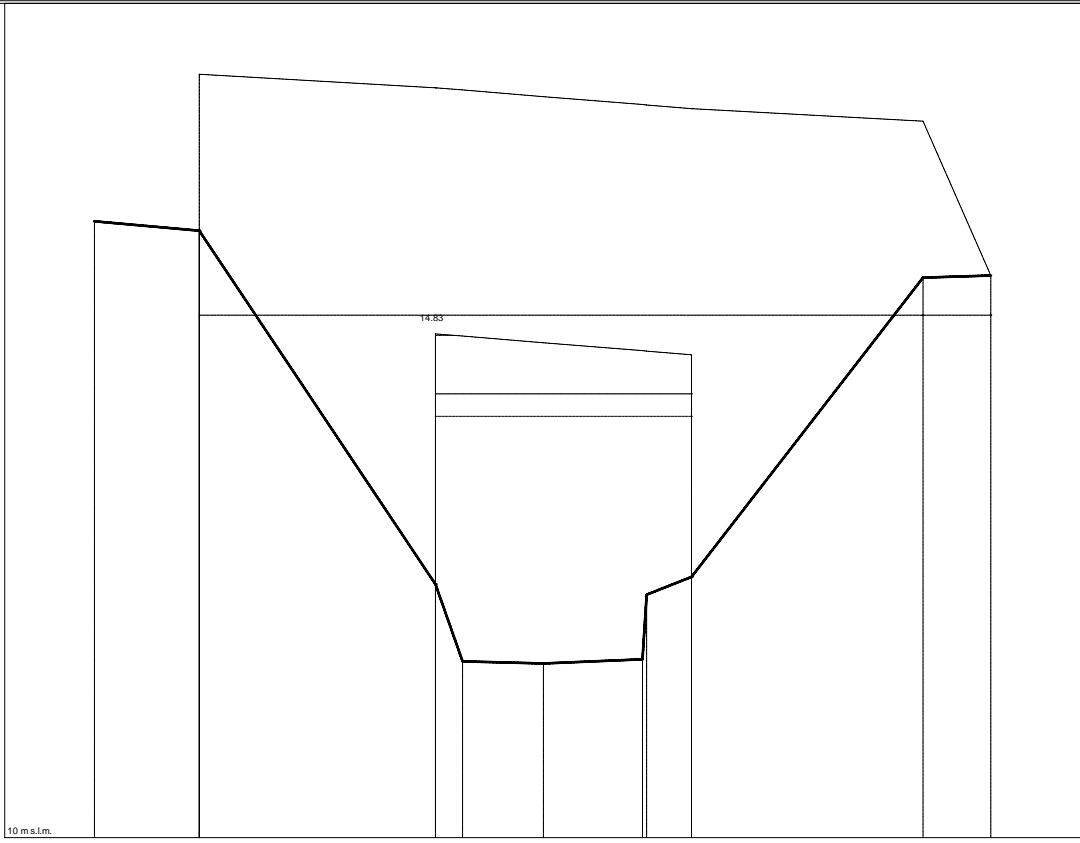

Torrente Ricortola
Sezione n. R144_2b

Scala distanze 1:100
Scala quote 1:50

Punti	1	2	4	6	7	8	10	12	13
Quote [m s.l.m.]	15.91	15.82	12.43	11.69	11.67	11.71	12.50	15.37	15.39
Distanze progressive [m]	0.0	2.0	6.5	7.1	8.6	10.5	11.5	16.9	17.2
Distanze parziali [m]		2.0	4.5	0.5	1.6	1.9	0.9	4.4	1.3

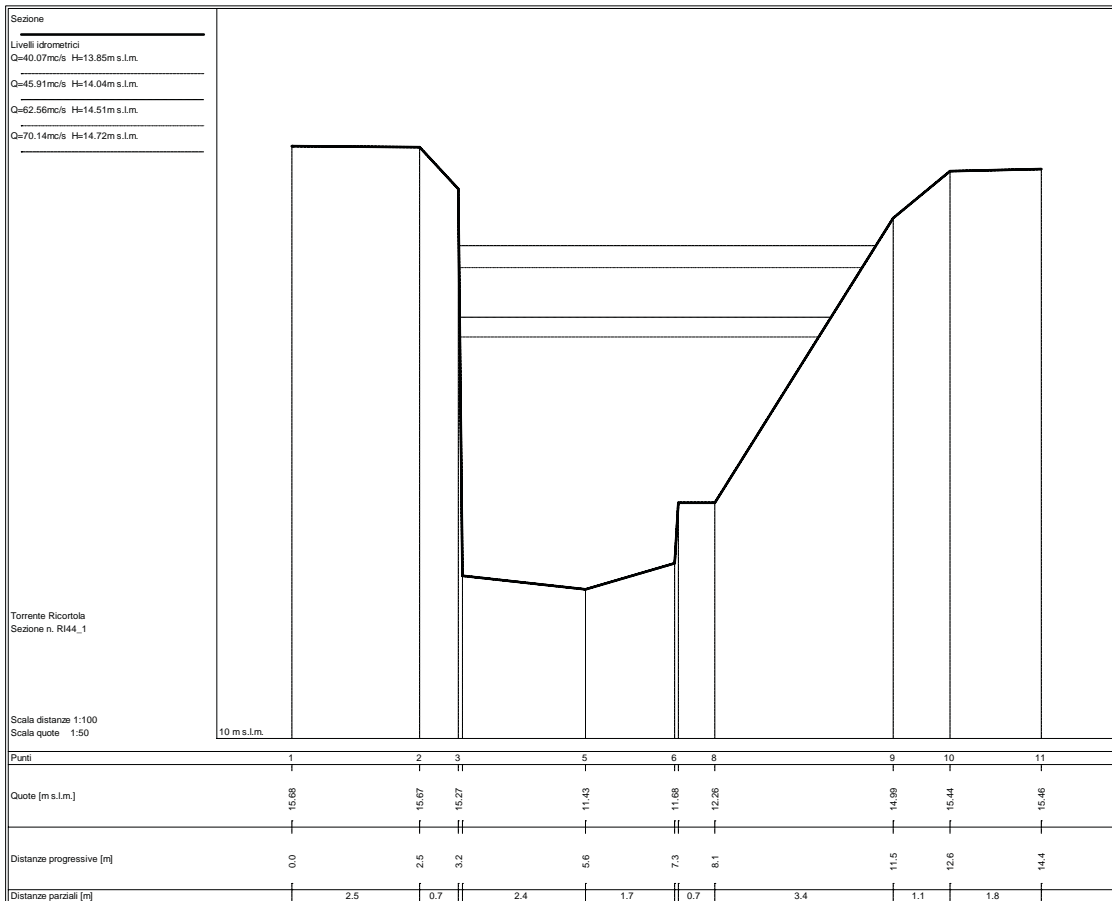
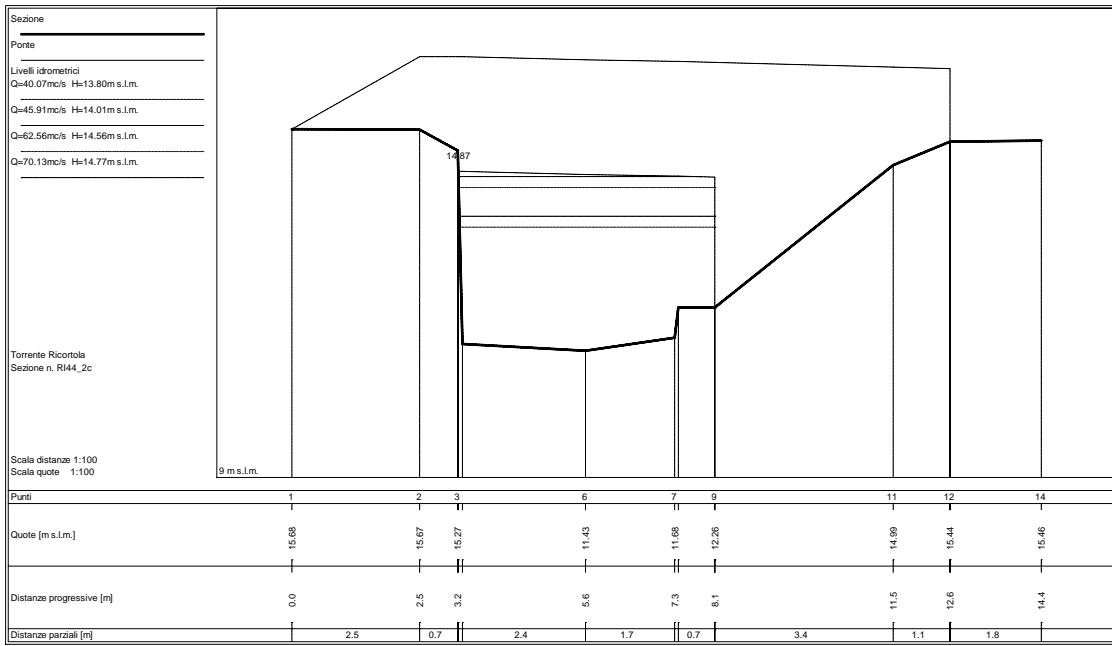

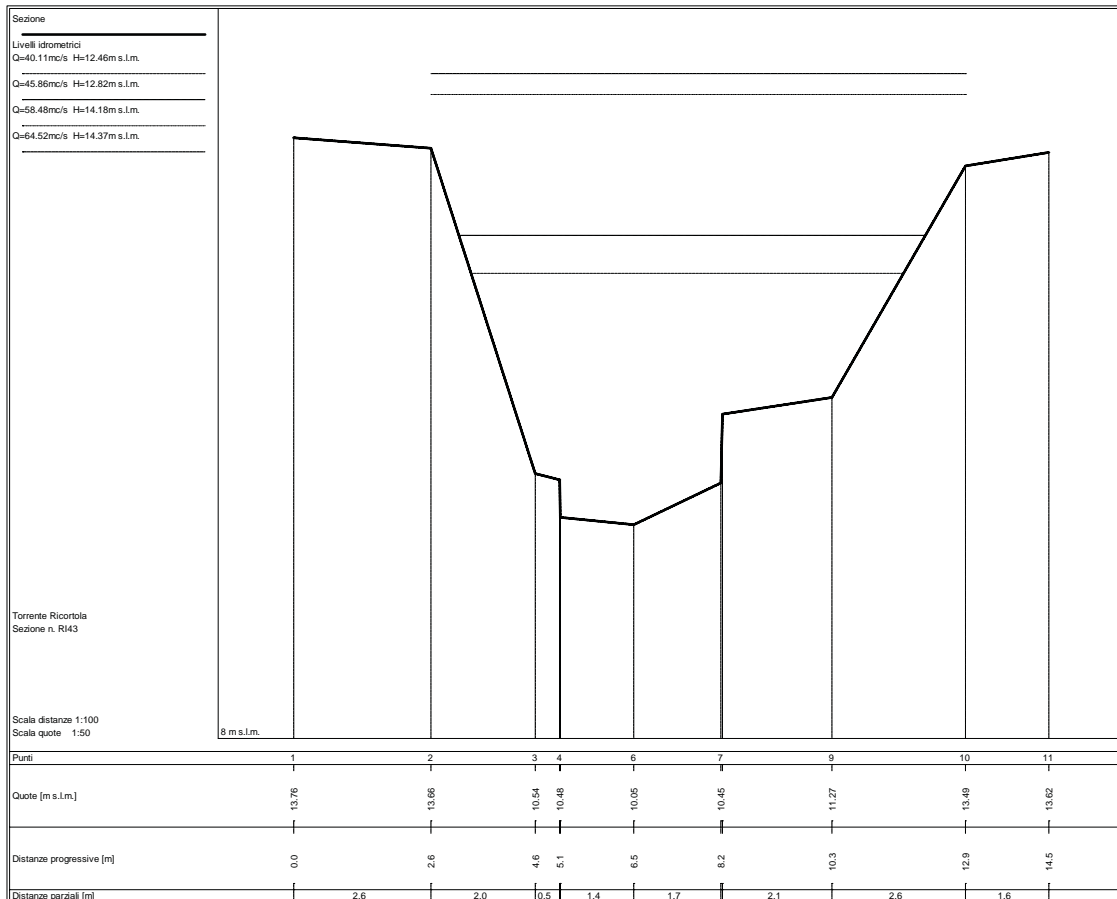
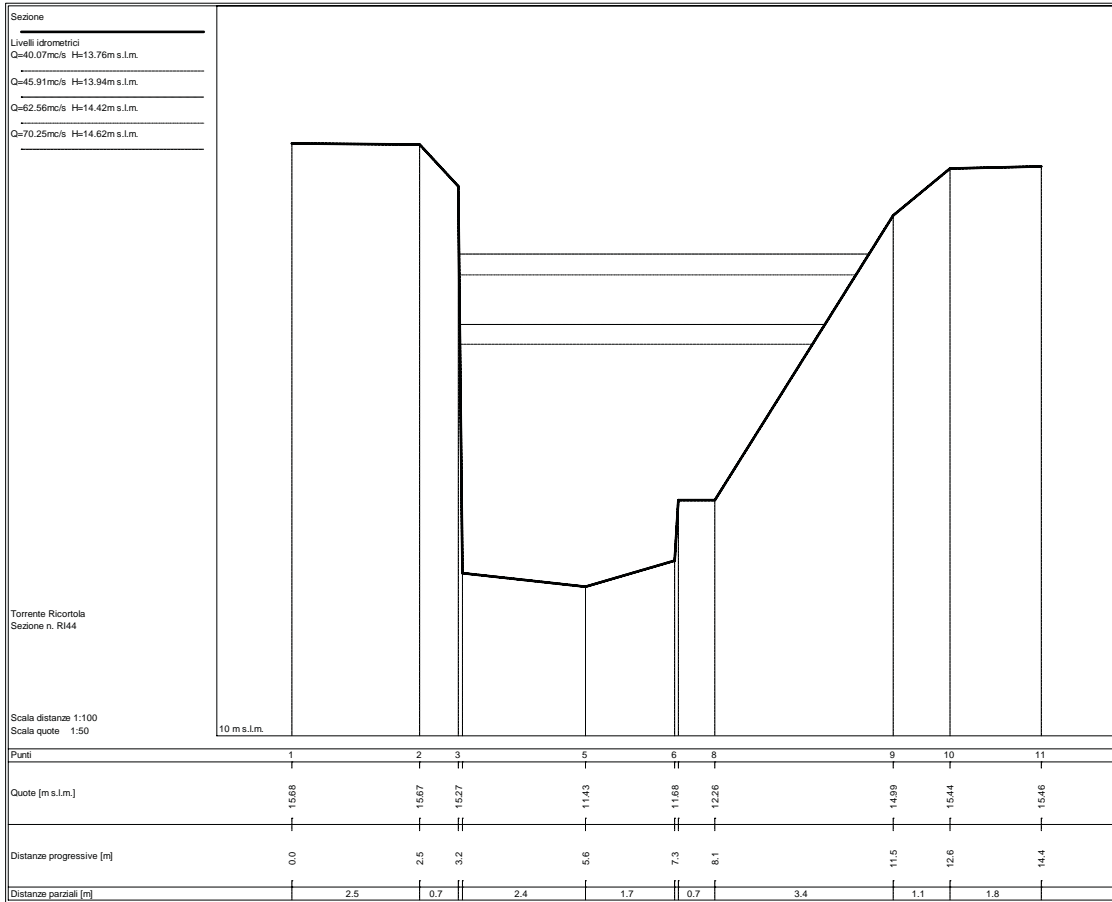

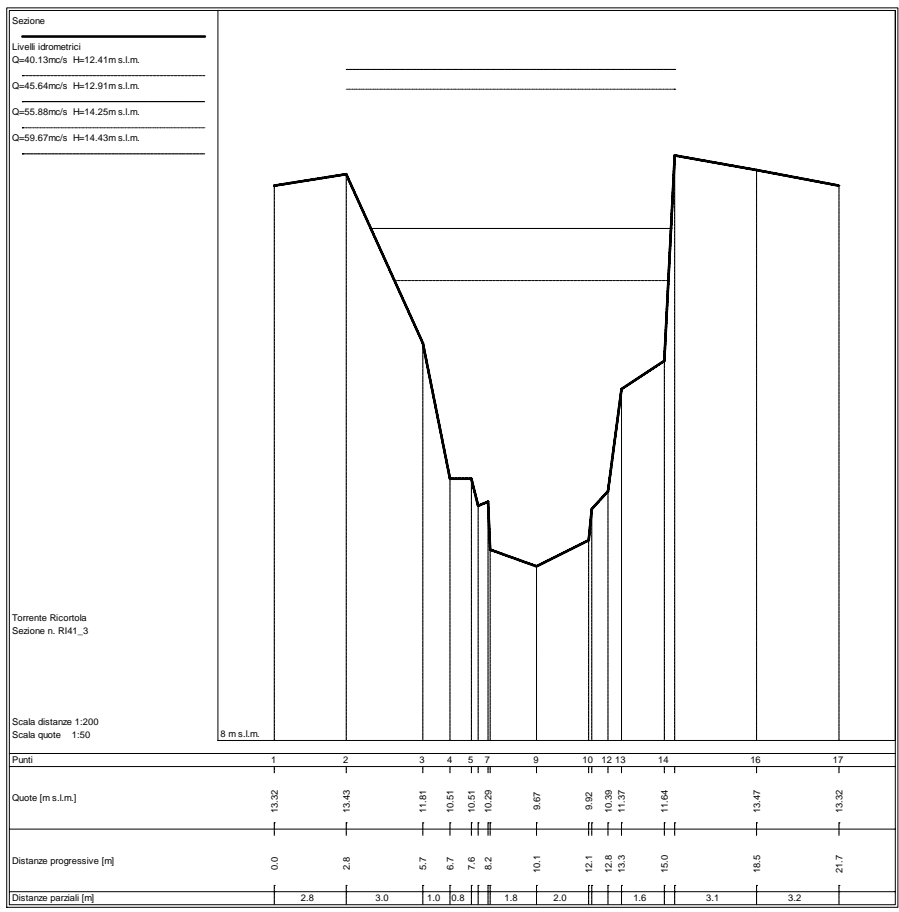
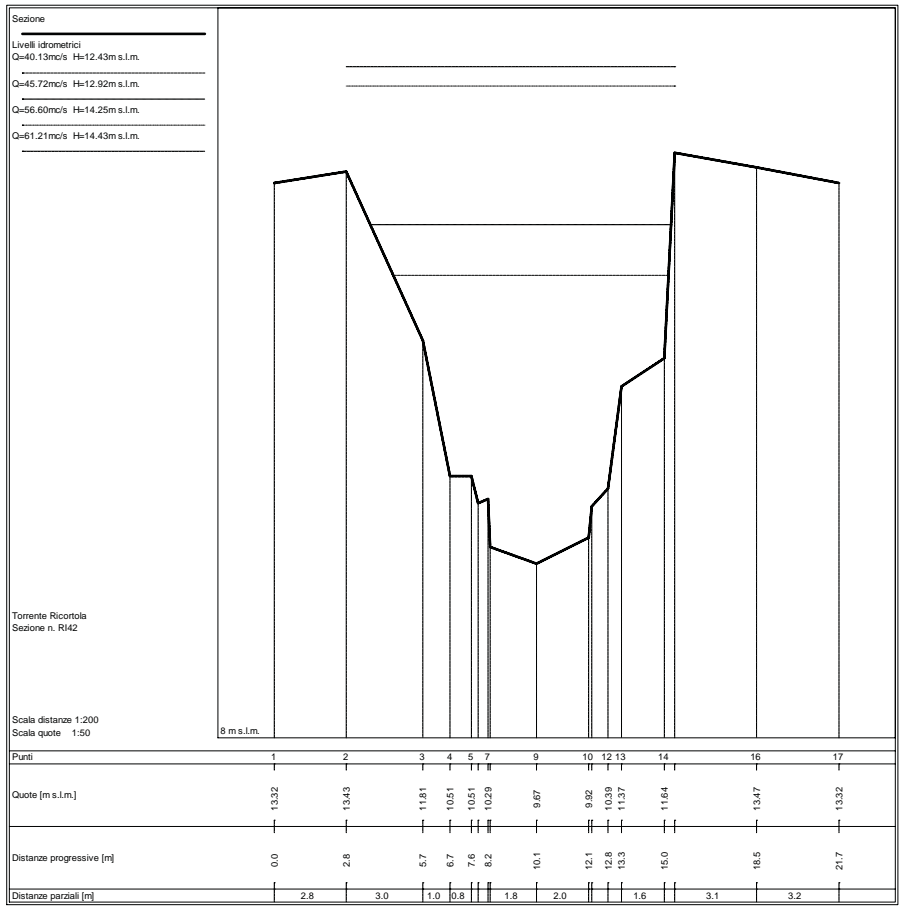

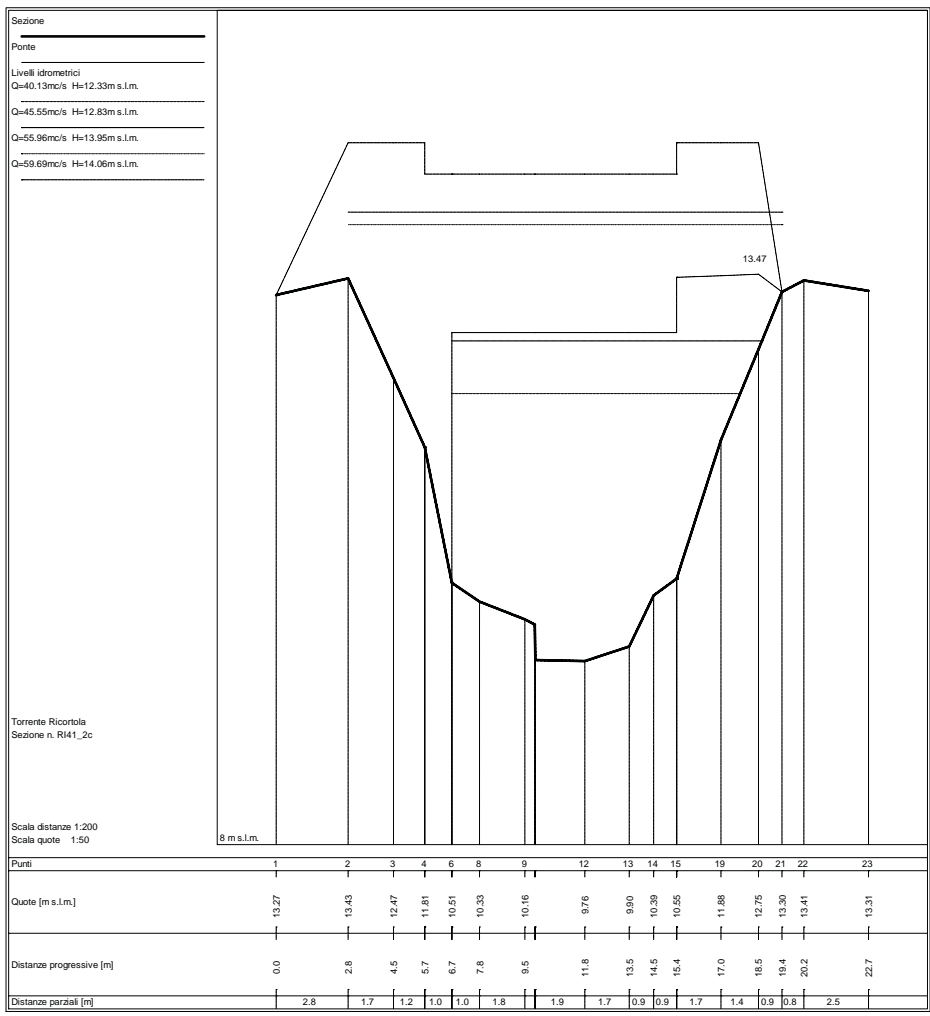
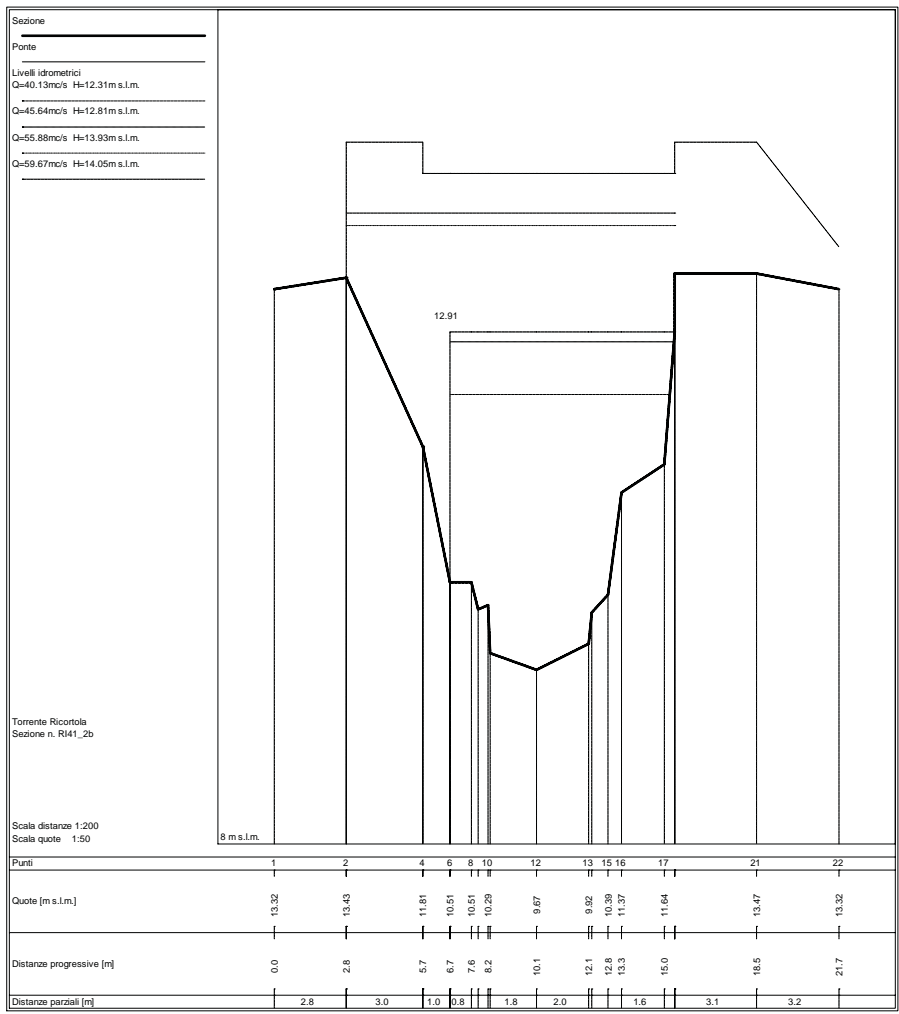

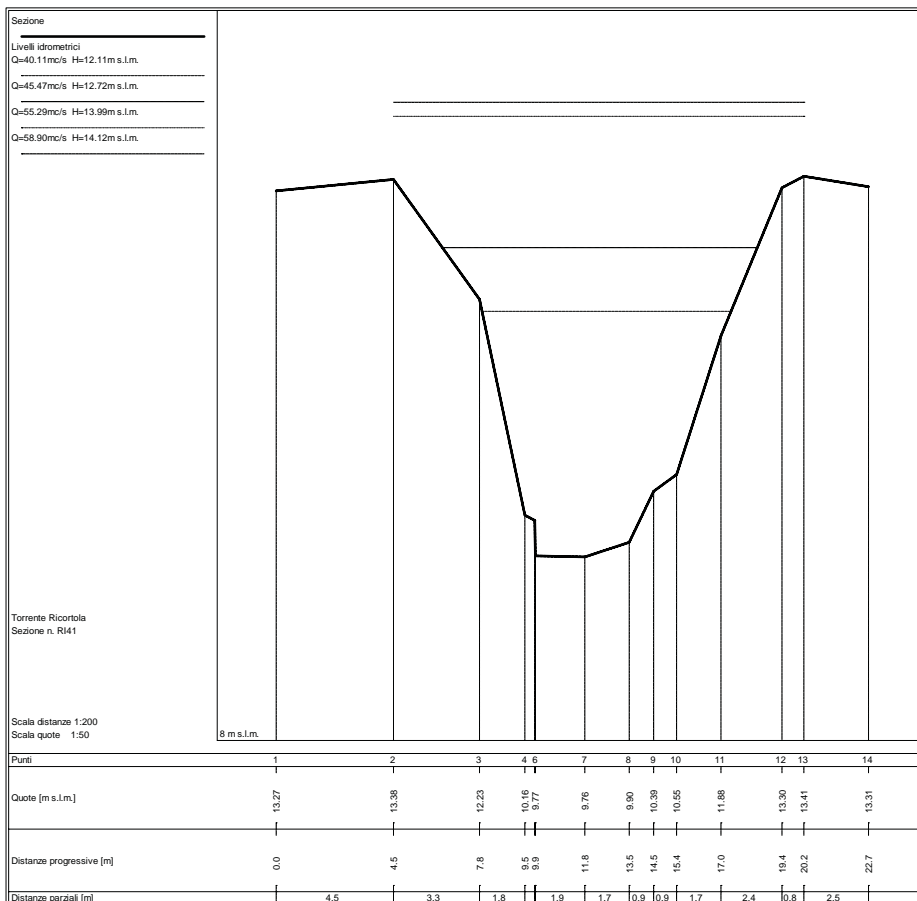
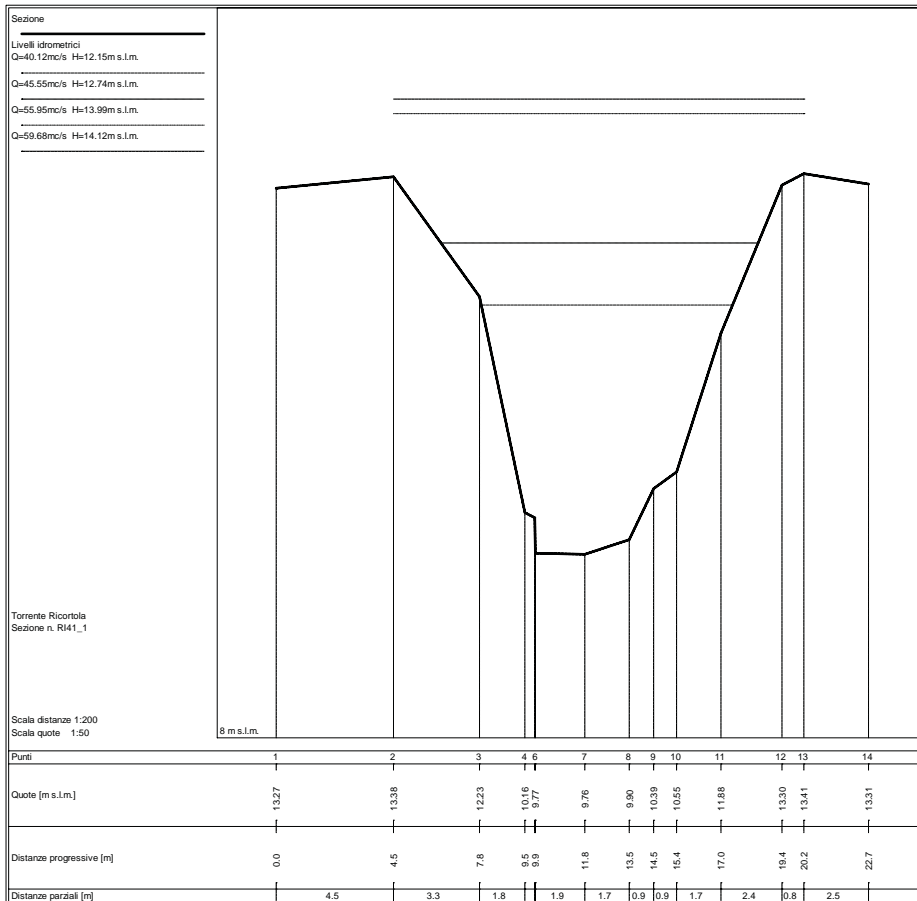

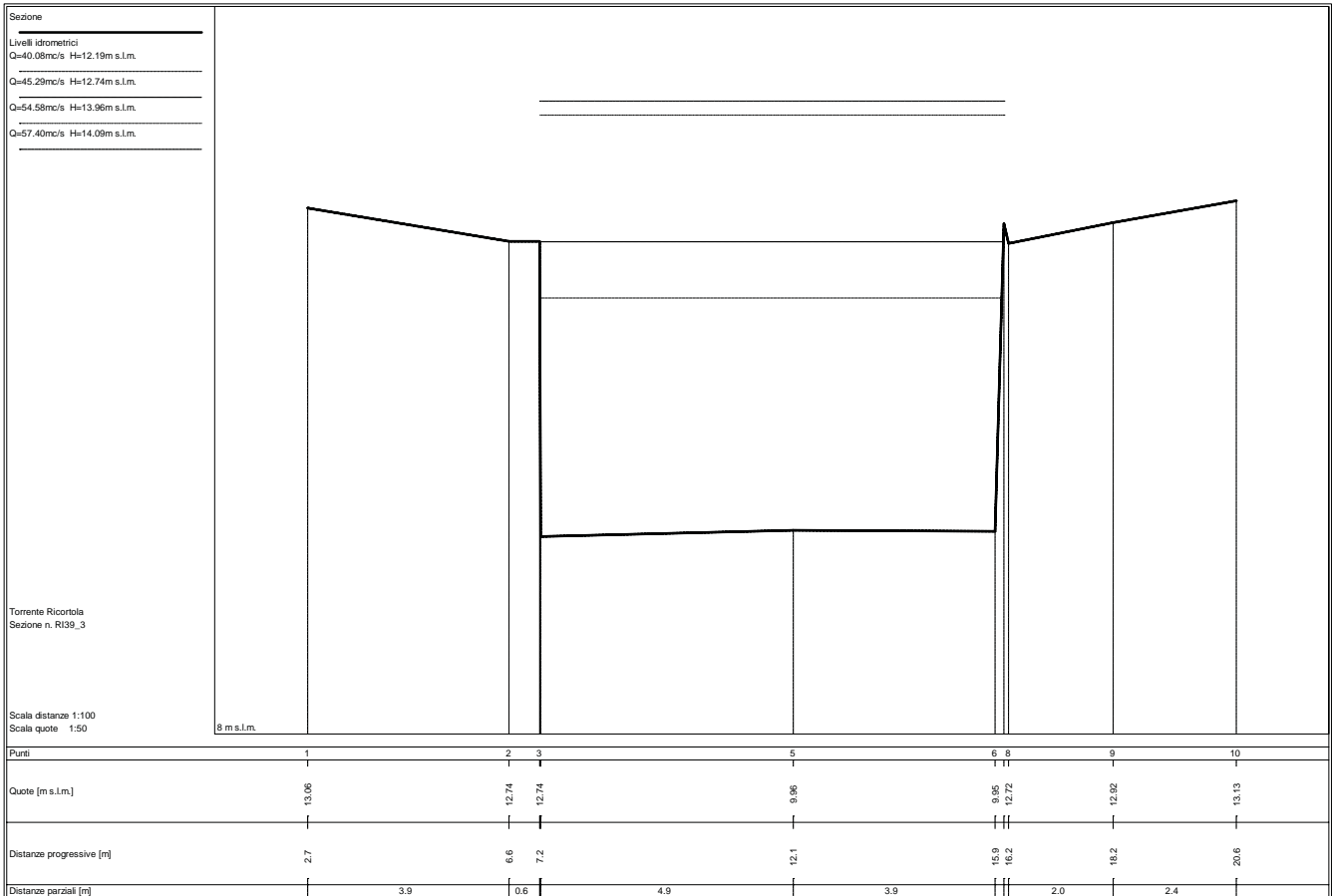
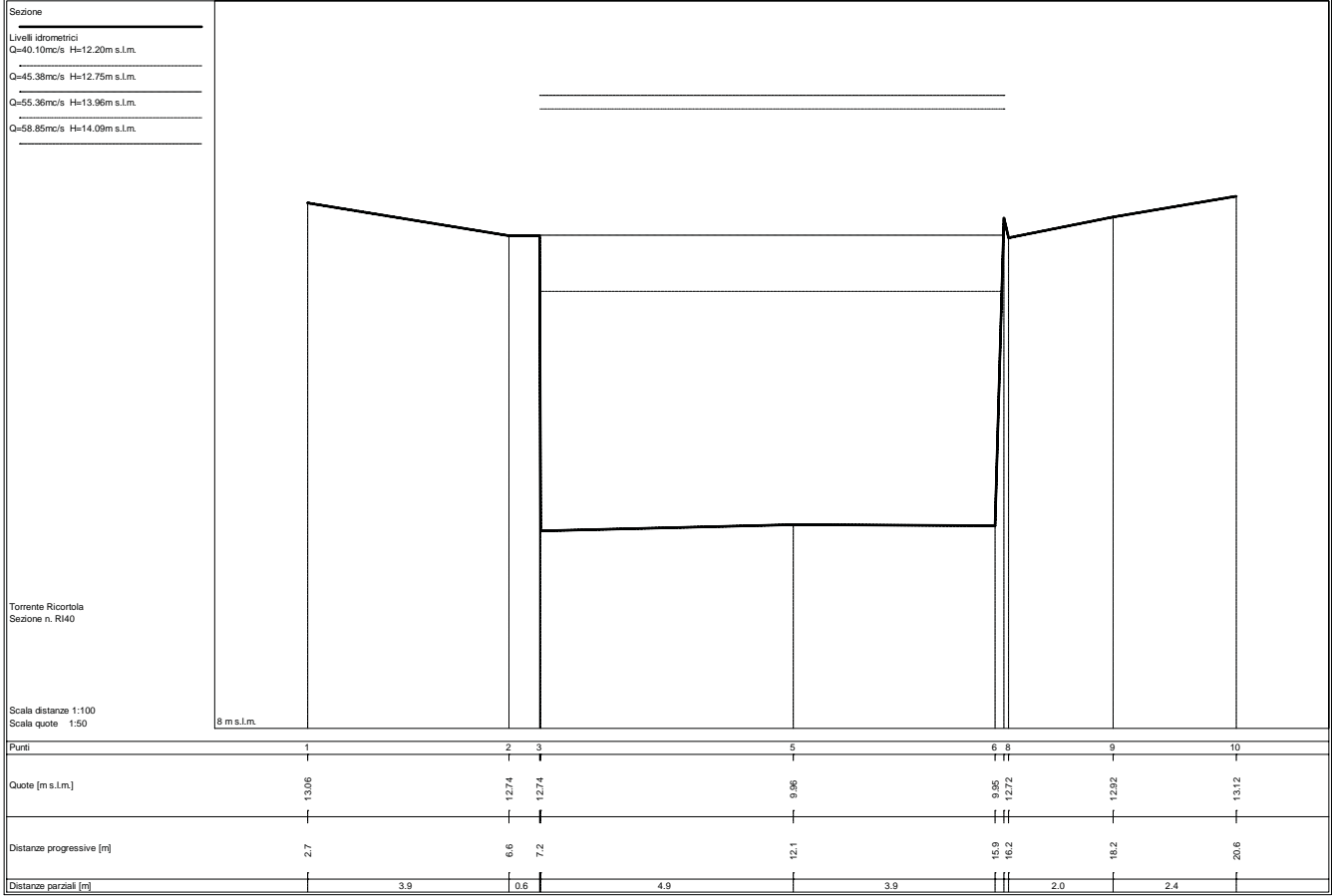

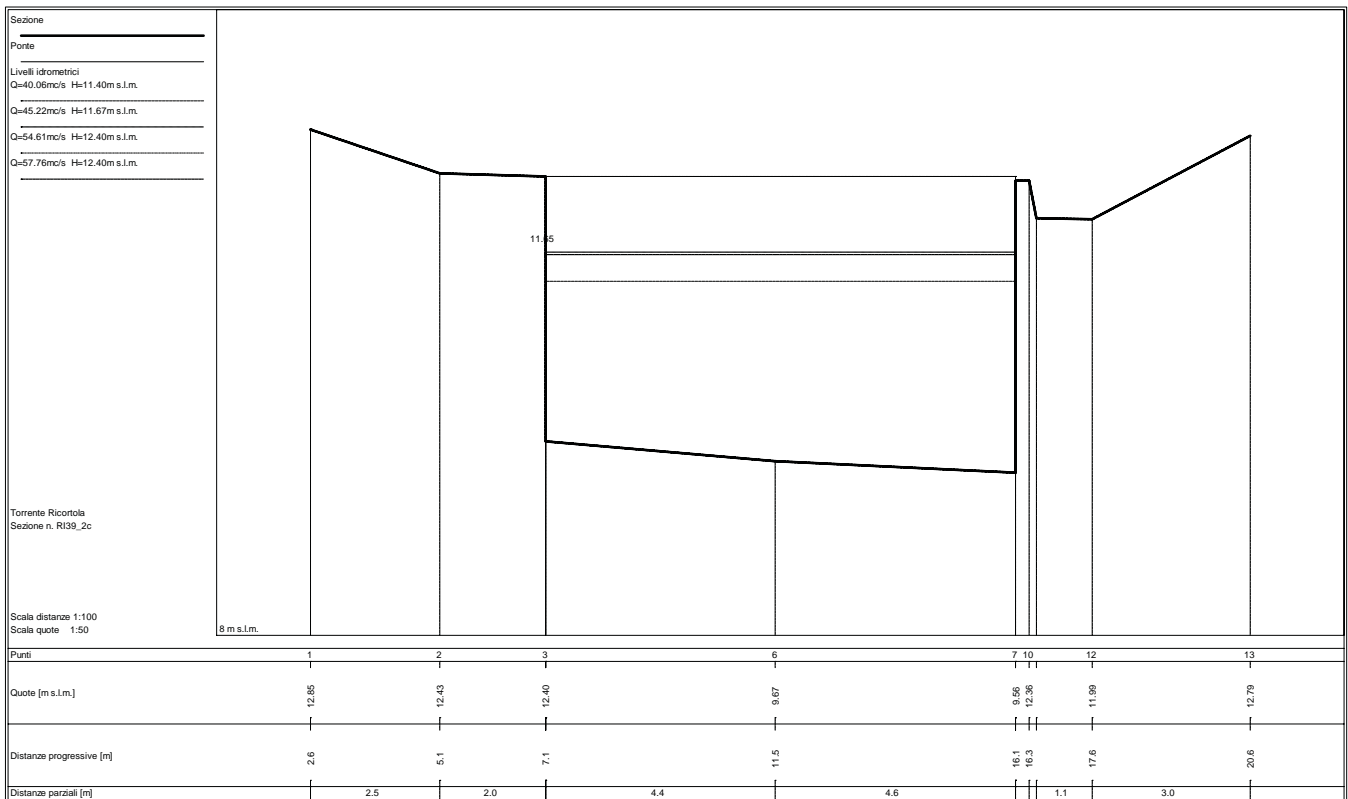
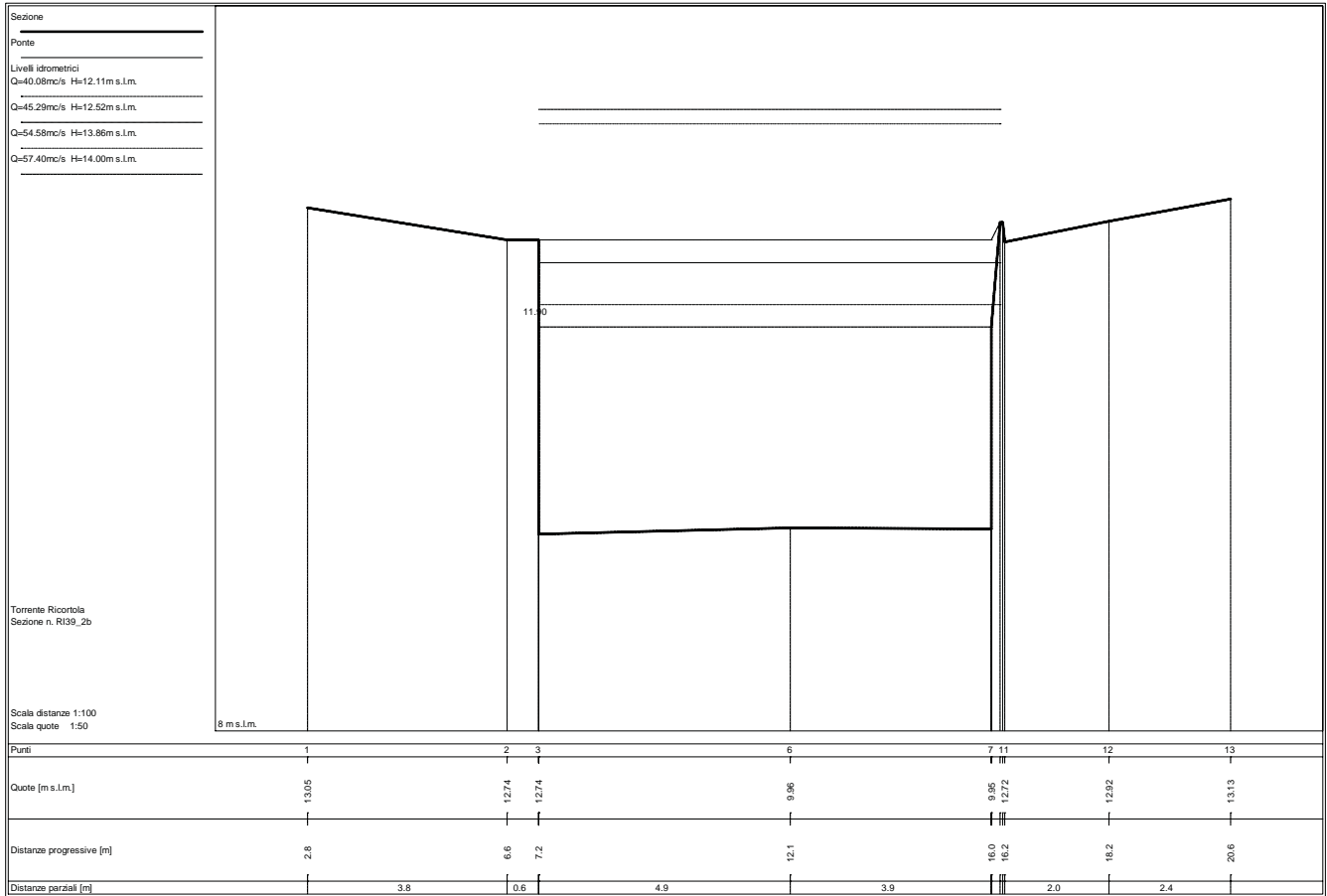

Sezione
 Livelli idrometrici
 Q=40.06mc/s H=11.39m s.l.m.
 Q=45.22mc/s H=11.67m s.l.m.
 Q=54.61mc/s H=12.22m s.l.m.
 Q=57.78mc/s H=12.28m s.l.m.

Torrente Ricortola
 Sezione n. RI39_1

Scala distanze 1:100
 Scala quote 1:50

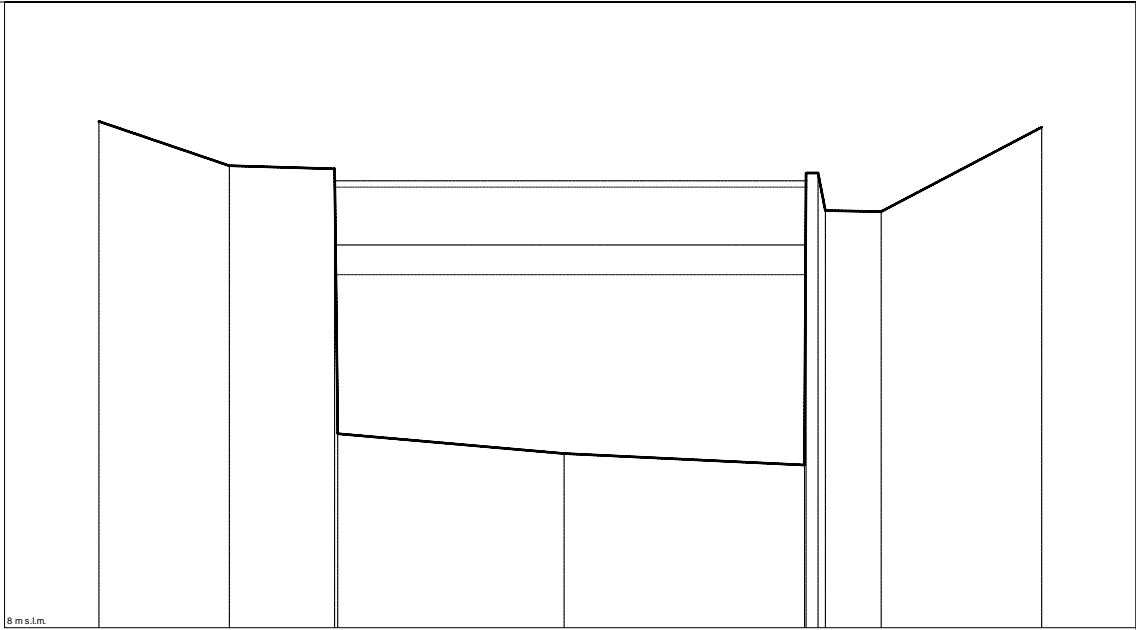

Punti	1	2	3	5	6	8	10	11
Quote [m s.l.m.]	12.86	12.43	12.40	9.67	9.56	12.36	11.99	12.80
Distanze progressive [m]	2.5	5.0	7.0	11.4	16.0	16.3	17.5	20.6
Distanze parziali [m]		2.5	2.0	4.3	4.6	1.1	3.1	

Sezione
 Livelli idrometrici
 Q=40.07mc/s H=11.31m s.l.m.
 Q=45.19mc/s H=11.63m s.l.m.
 Q=54.62mc/s H=12.20m s.l.m.
 Q=57.58mc/s H=12.26m s.l.m.

Torrente Ricortola
 Sezione n. RI39

Scala distanze 1:100
 Scala quote 1:50

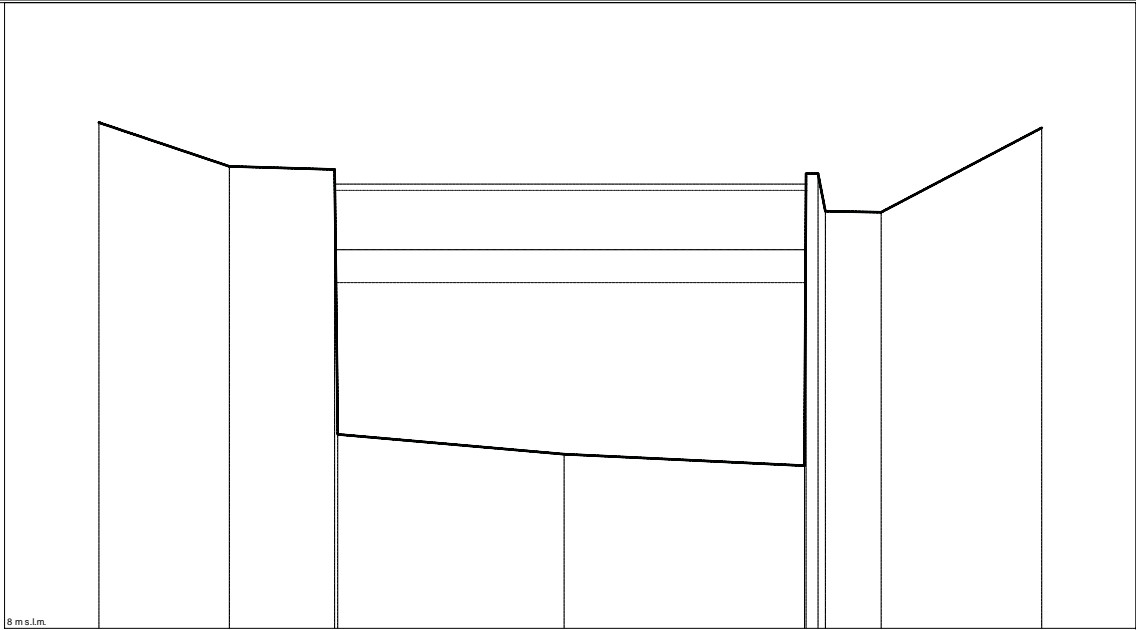

Punti	1	2	3	5	6	8	10	11
Quote [m s.l.m.]	12.85	12.43	12.40	9.67	9.56	12.36	11.99	12.80
Distanze progressive [m]	2.5	5.0	7.0	11.4	16.0	16.3	17.5	20.6
Distanze parziali [m]		2.5	2.0	4.3	4.6	1.1	3.1	

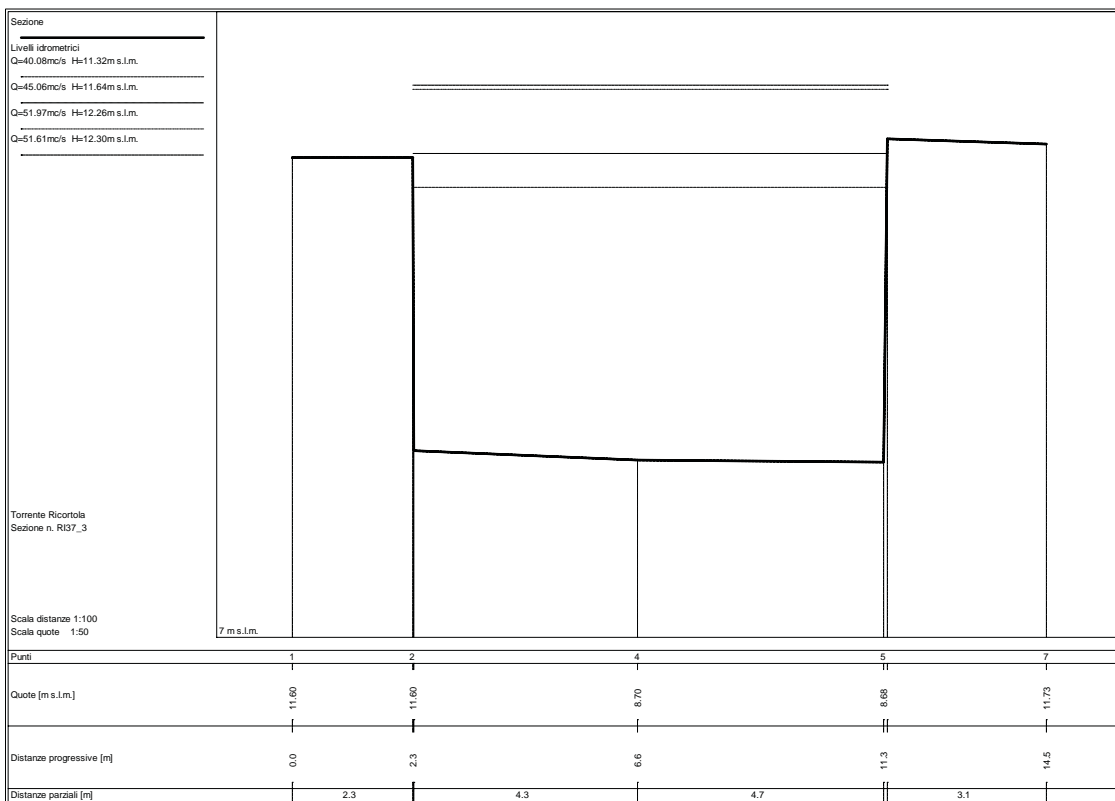
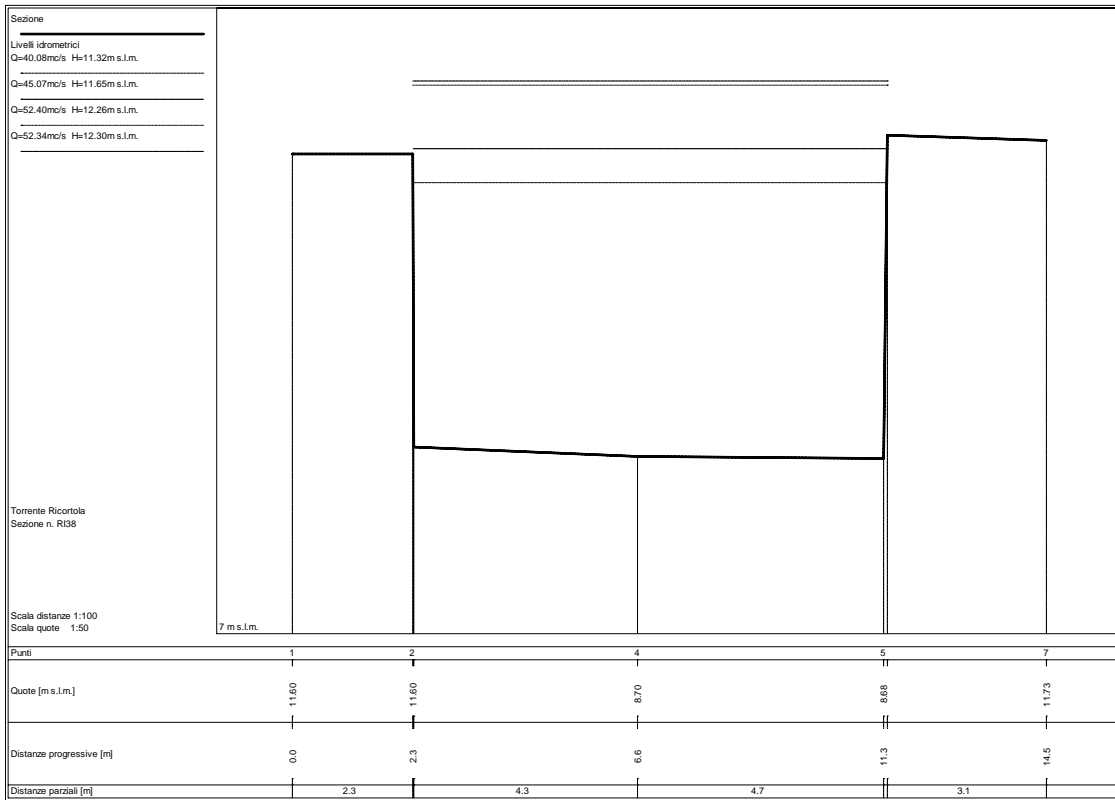

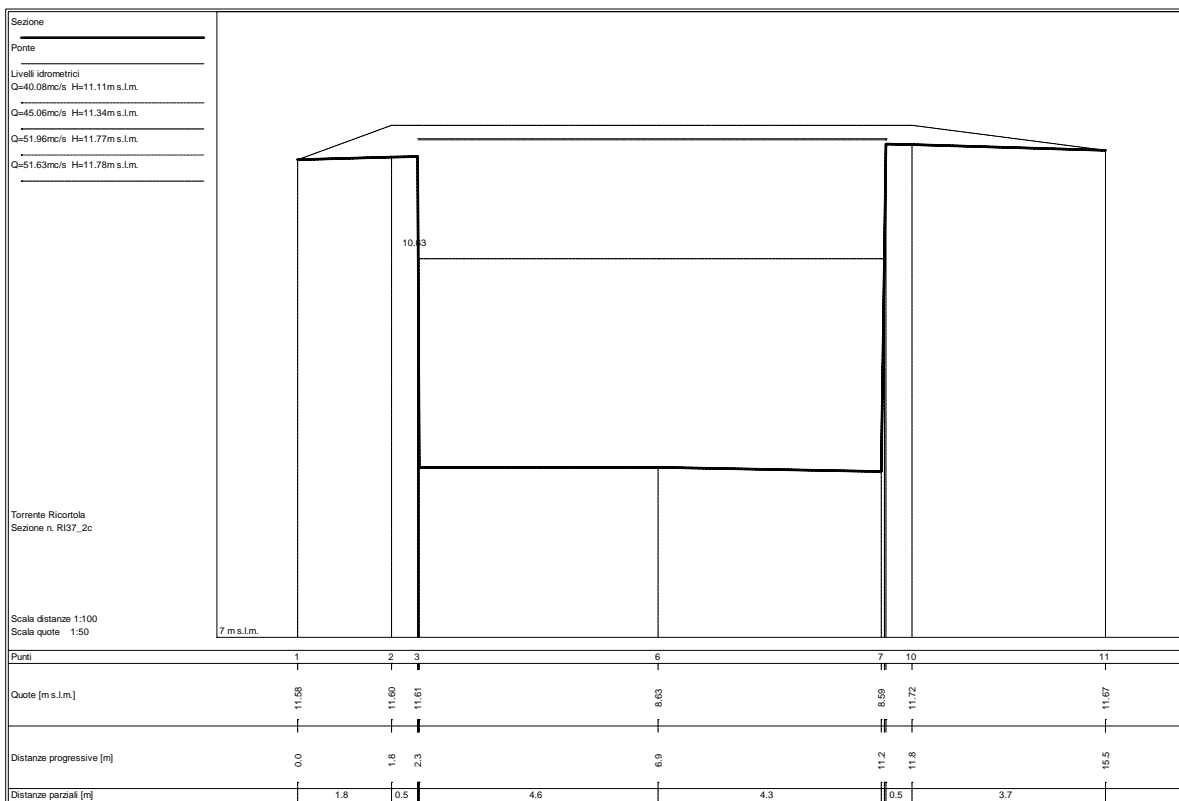
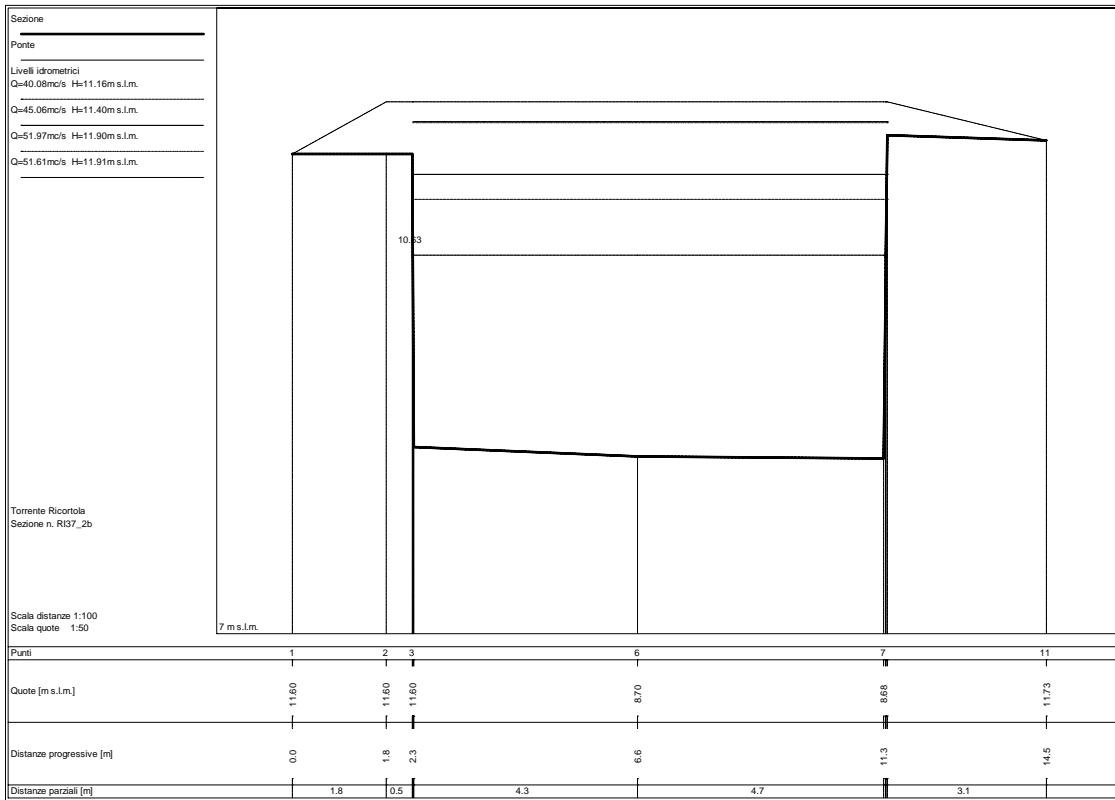

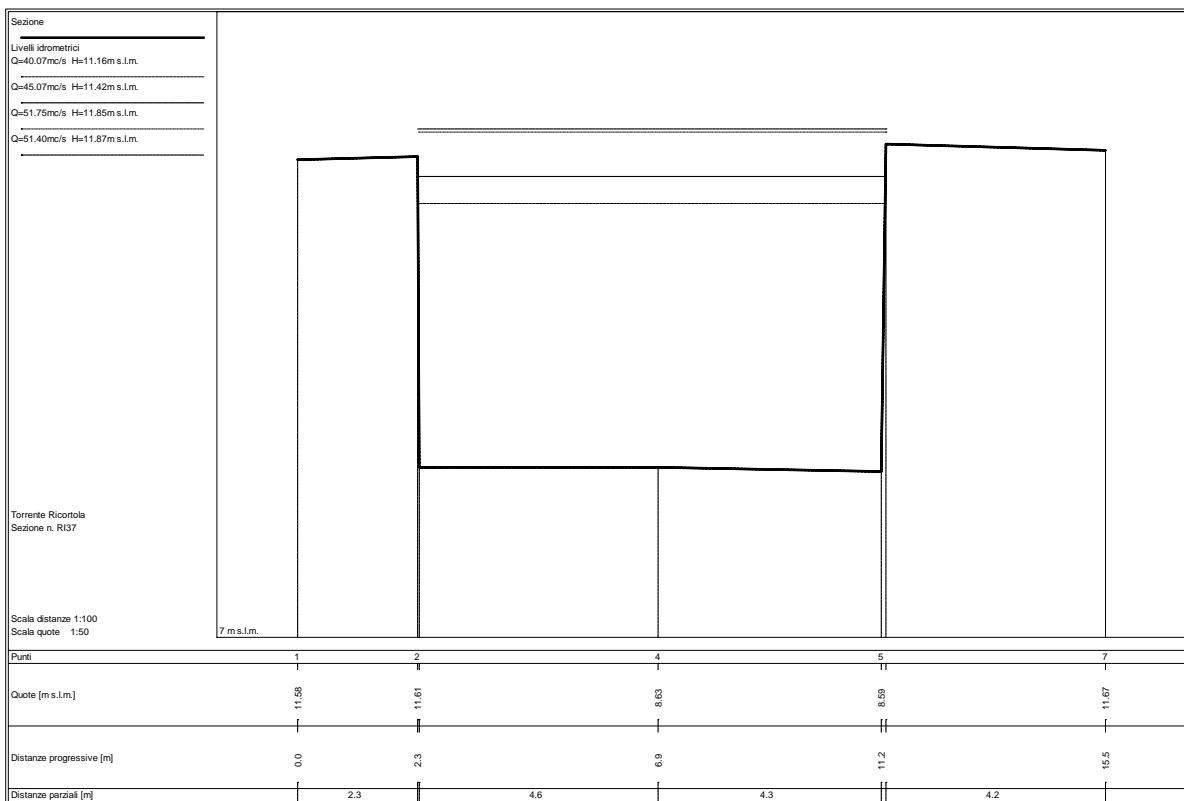
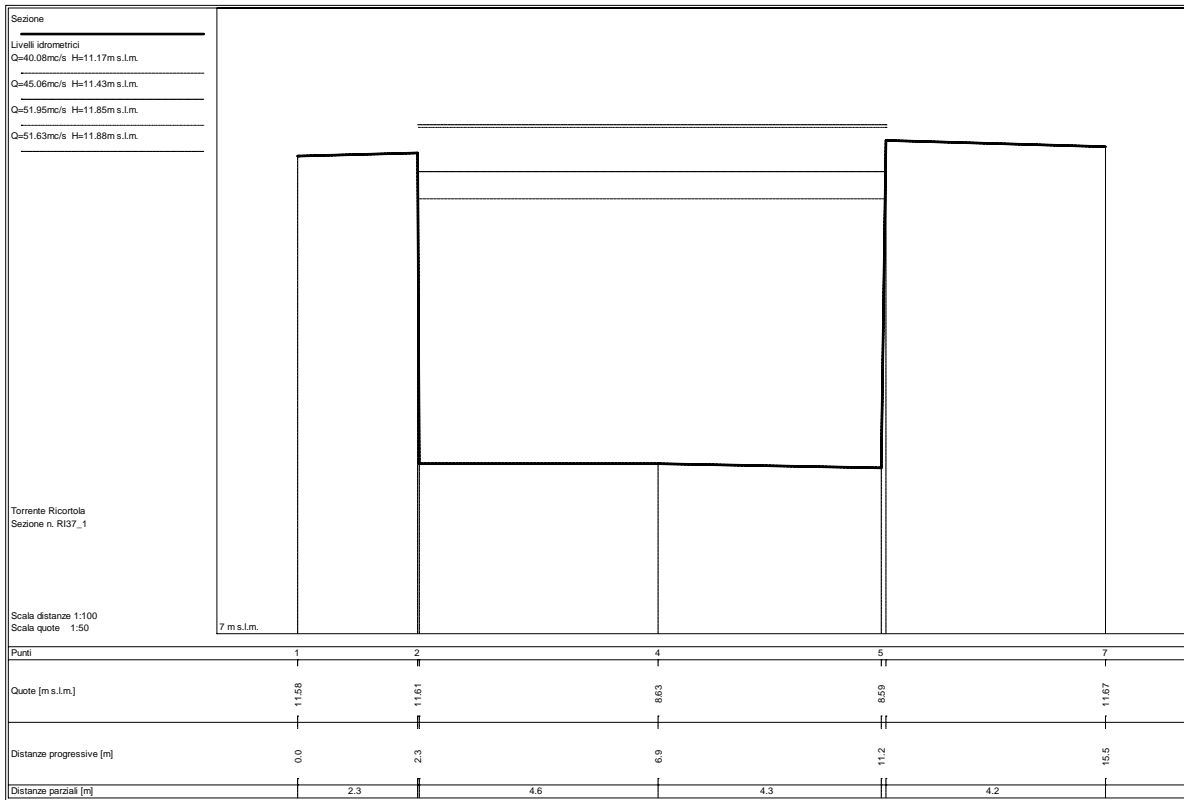

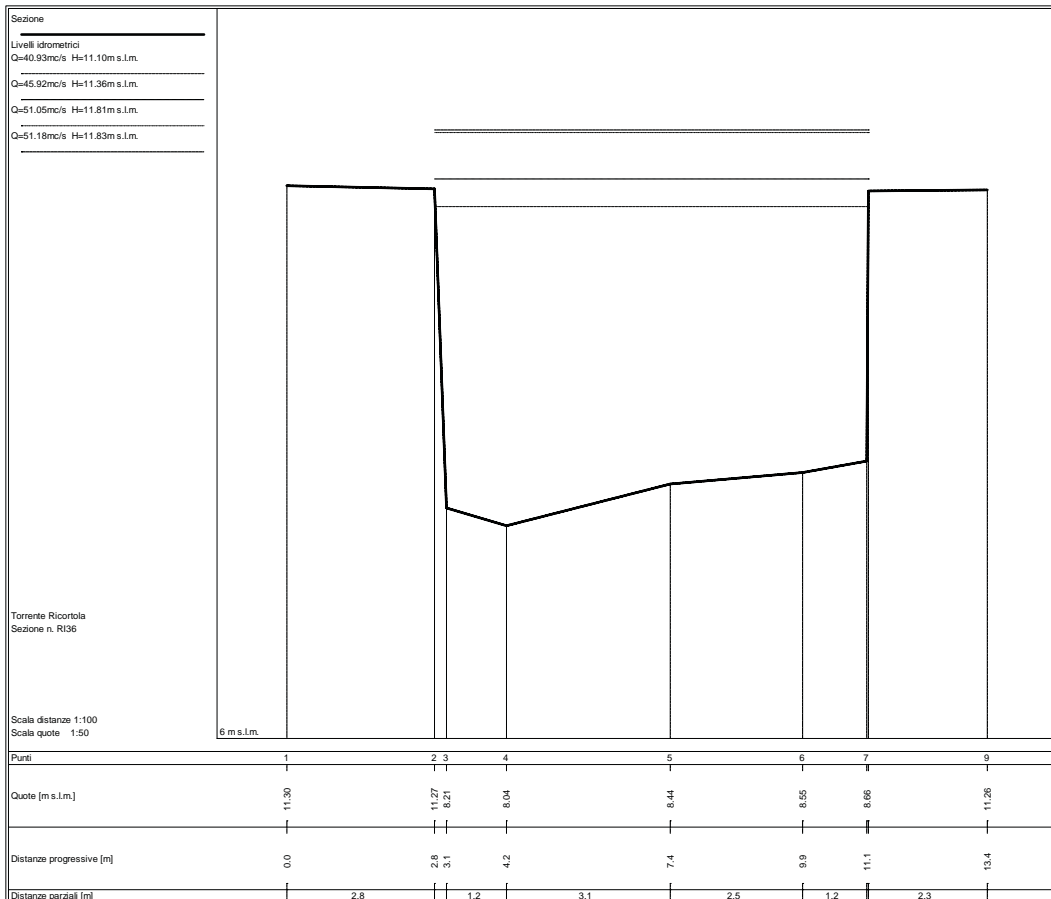
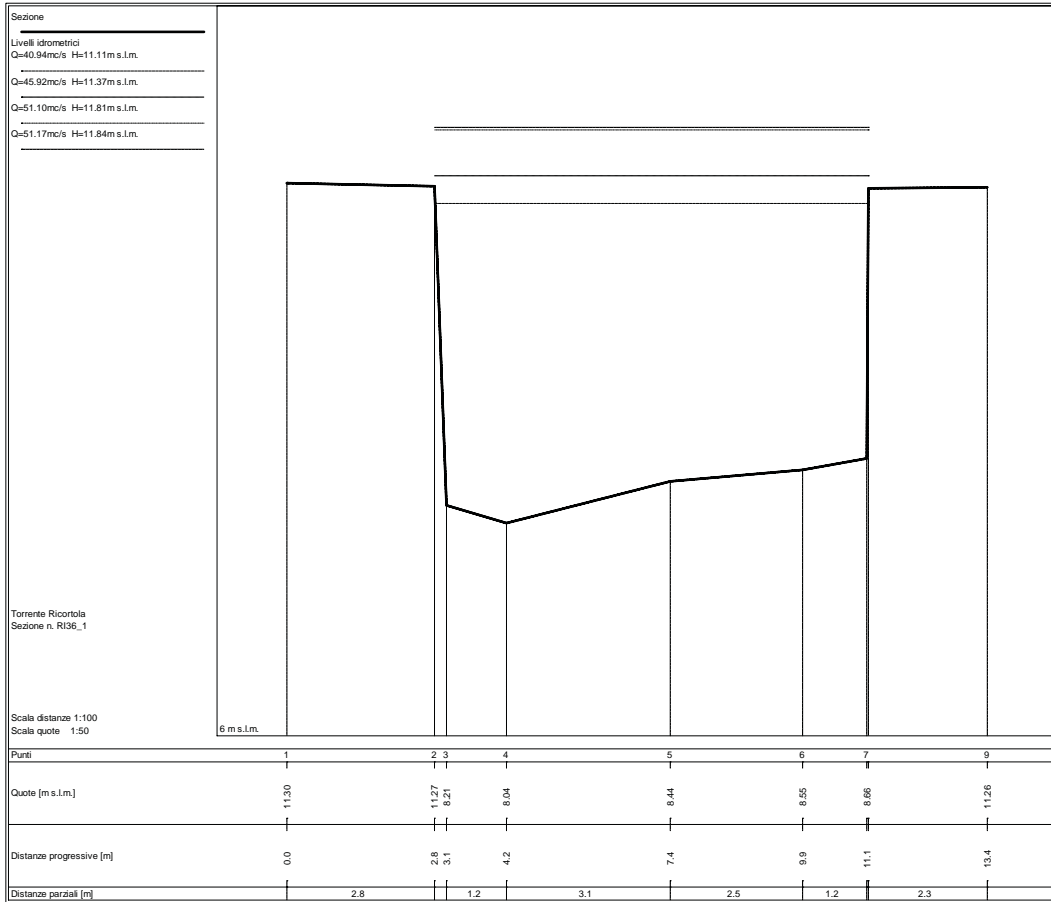

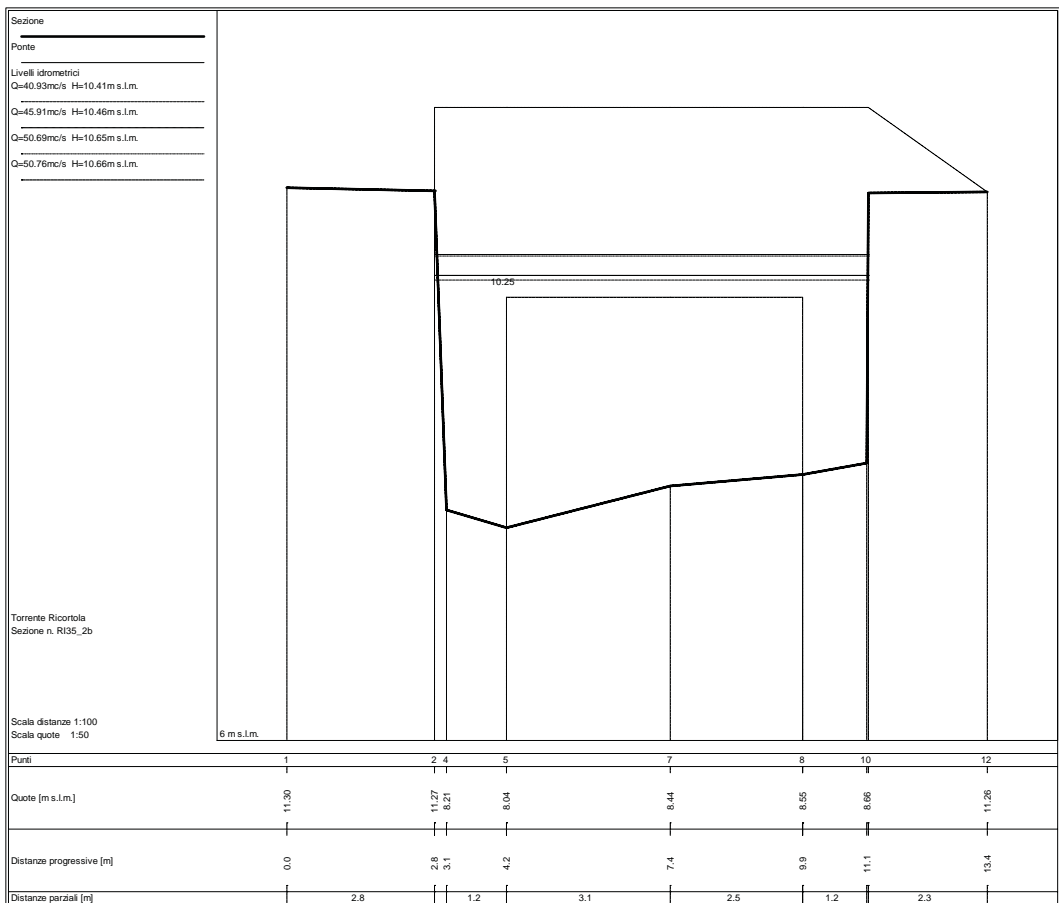
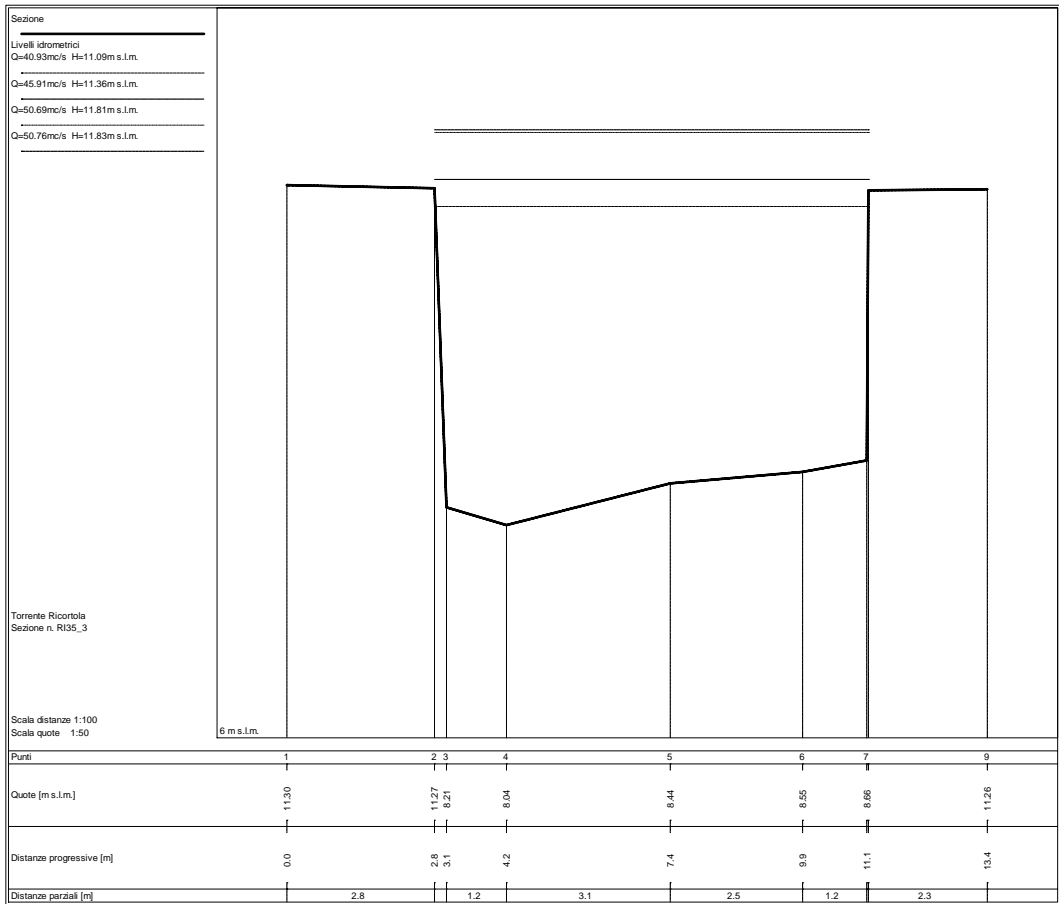

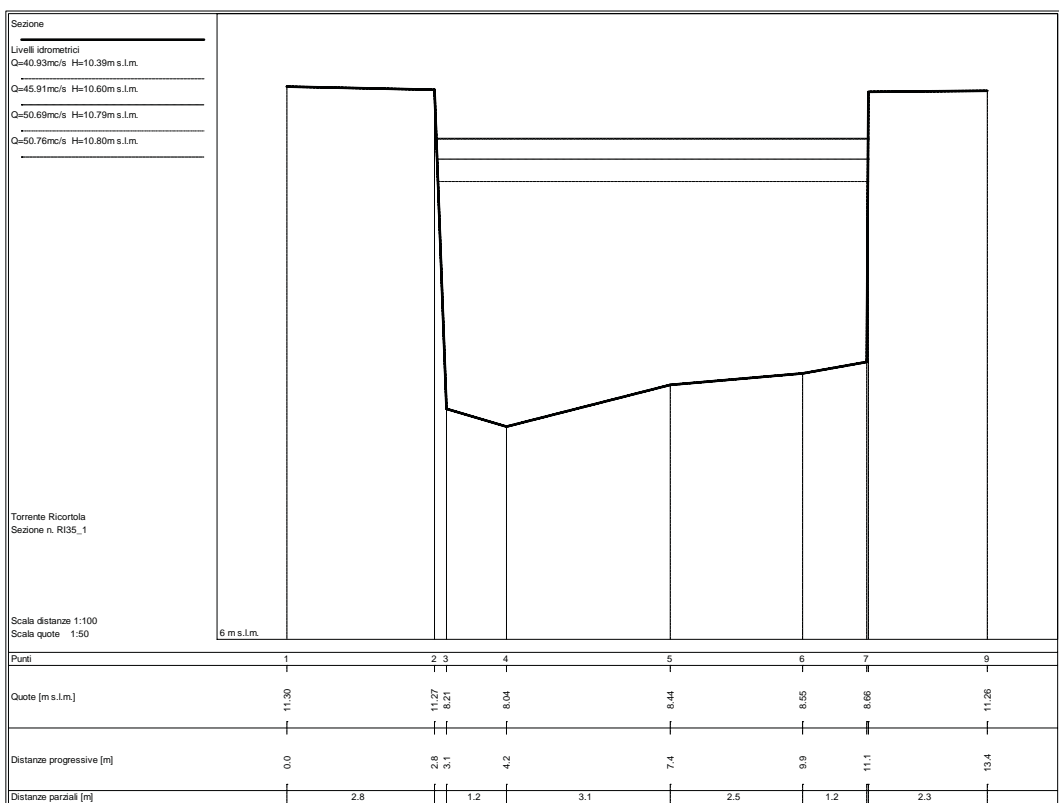
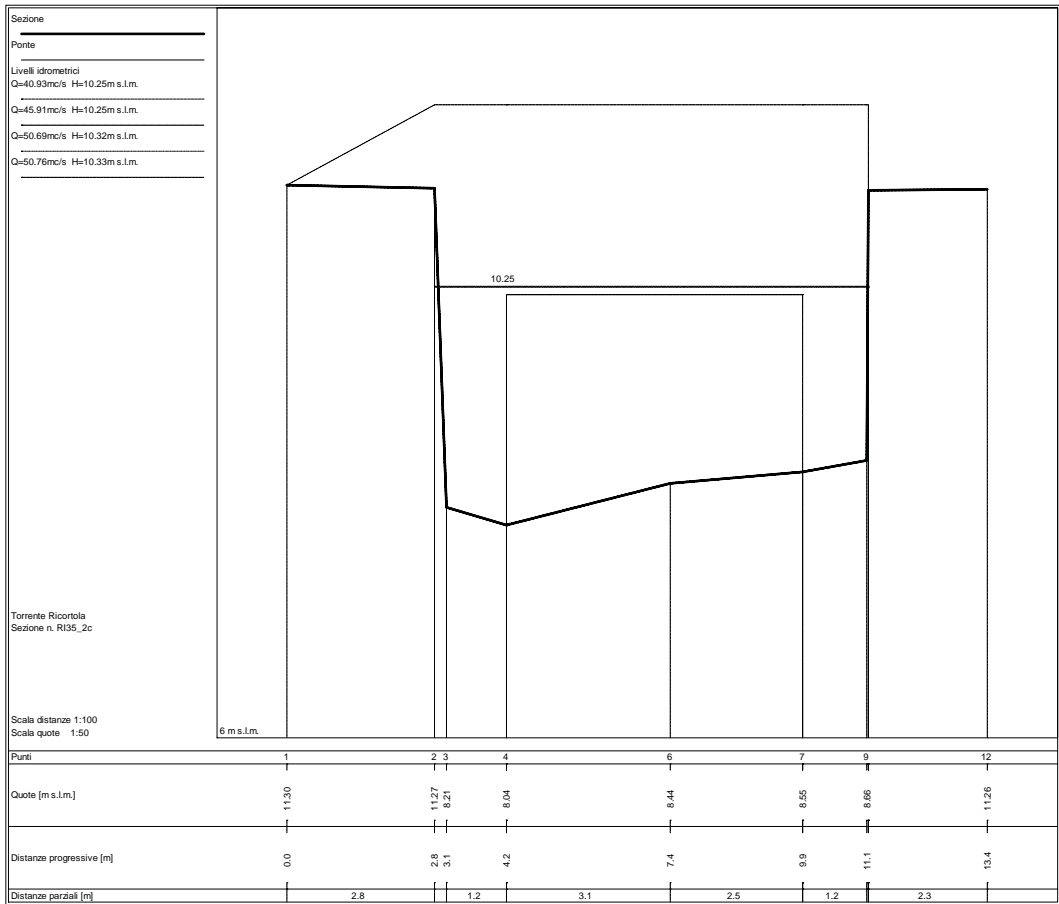

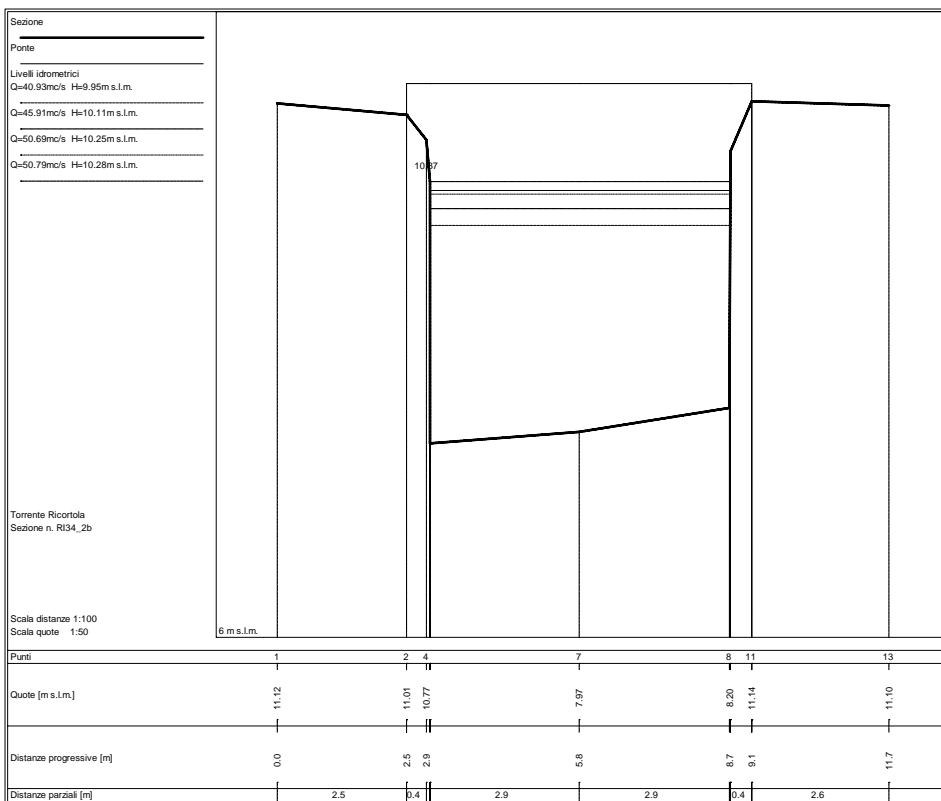
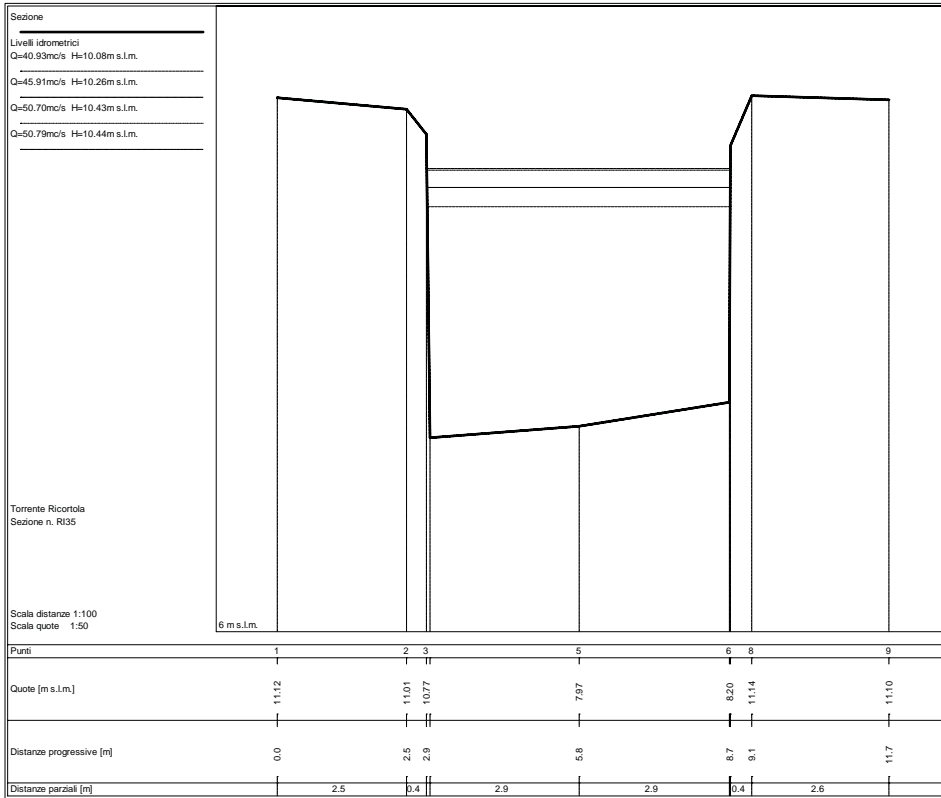

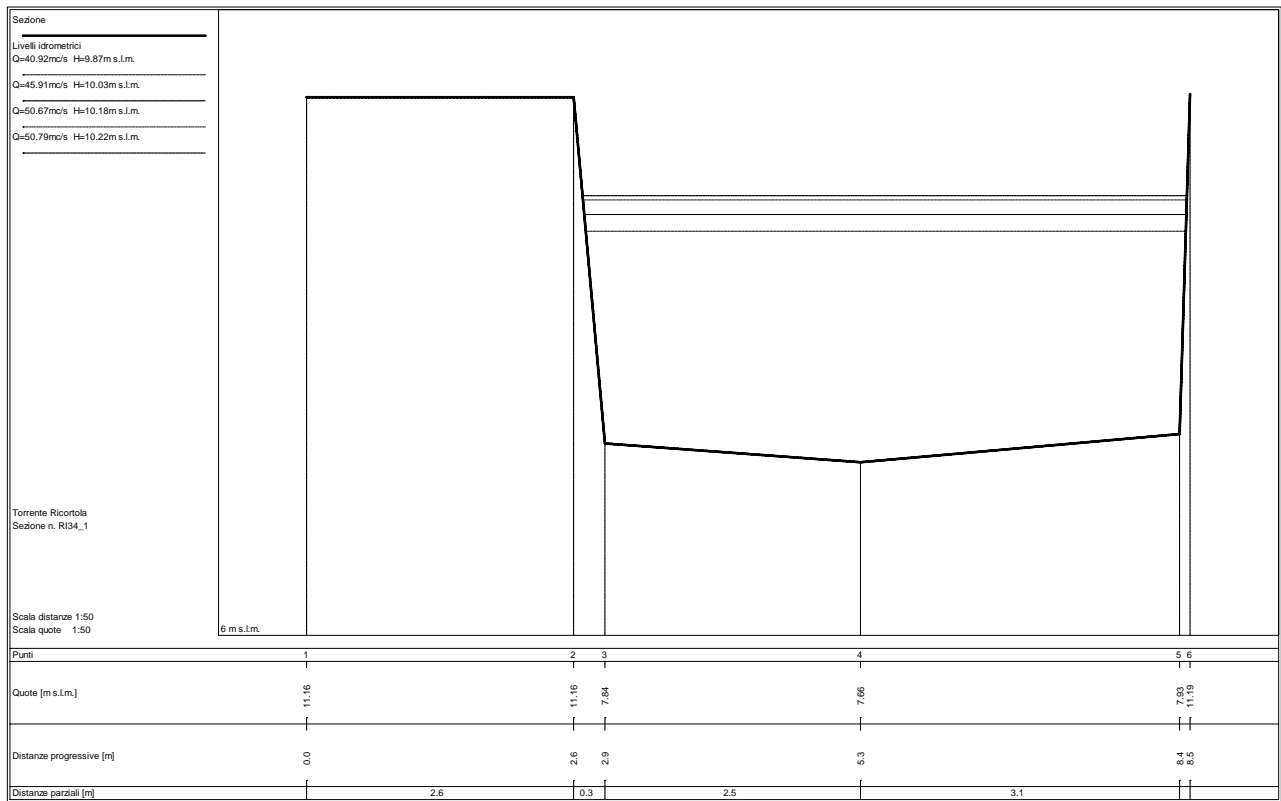
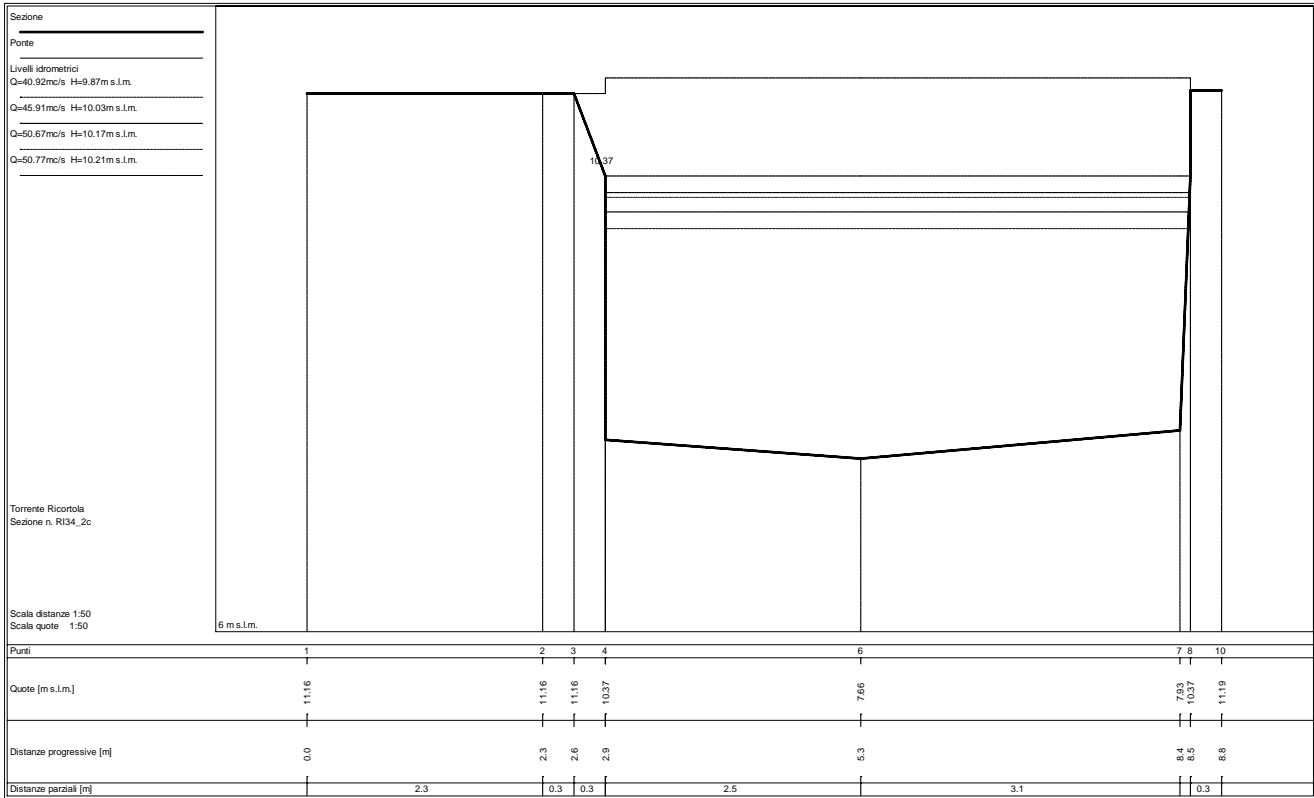

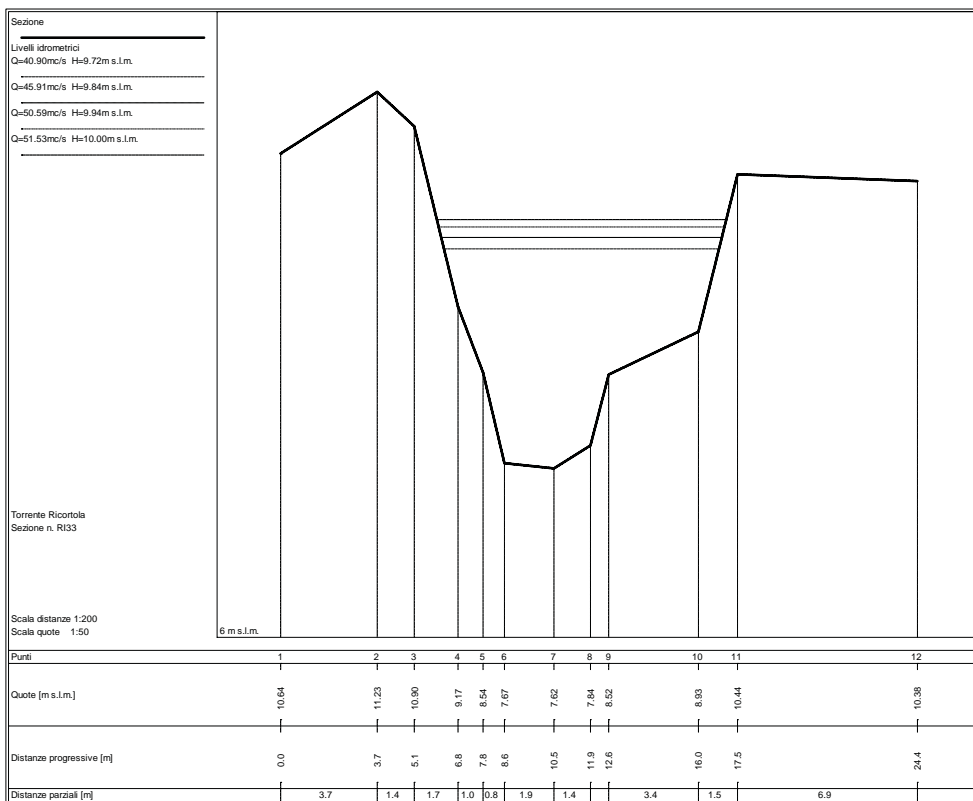
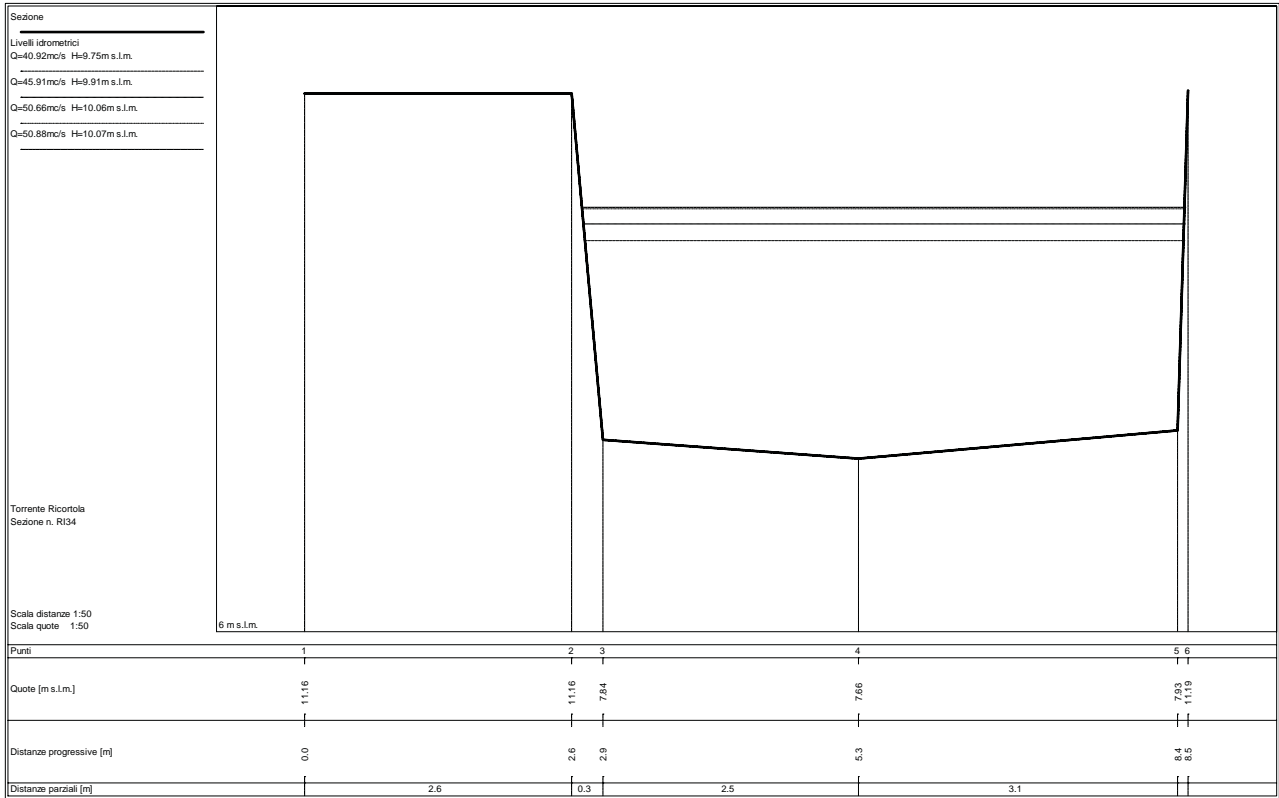

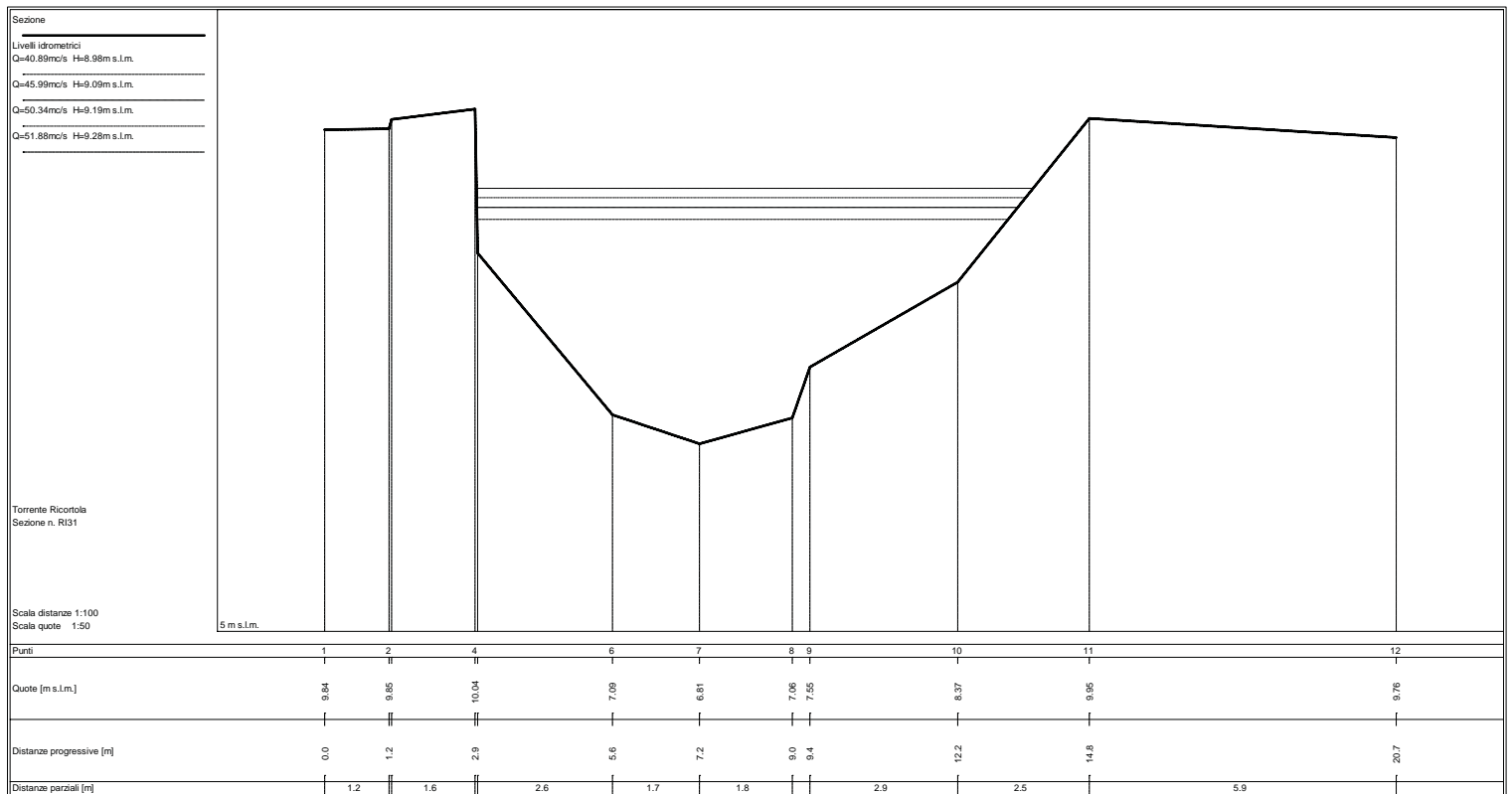
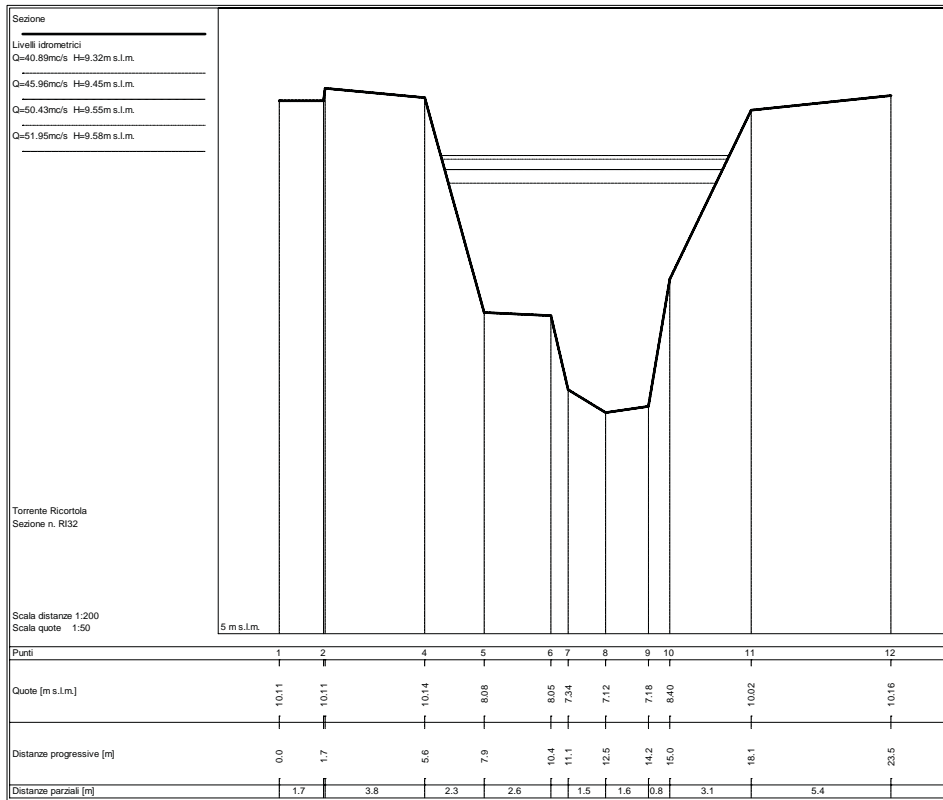

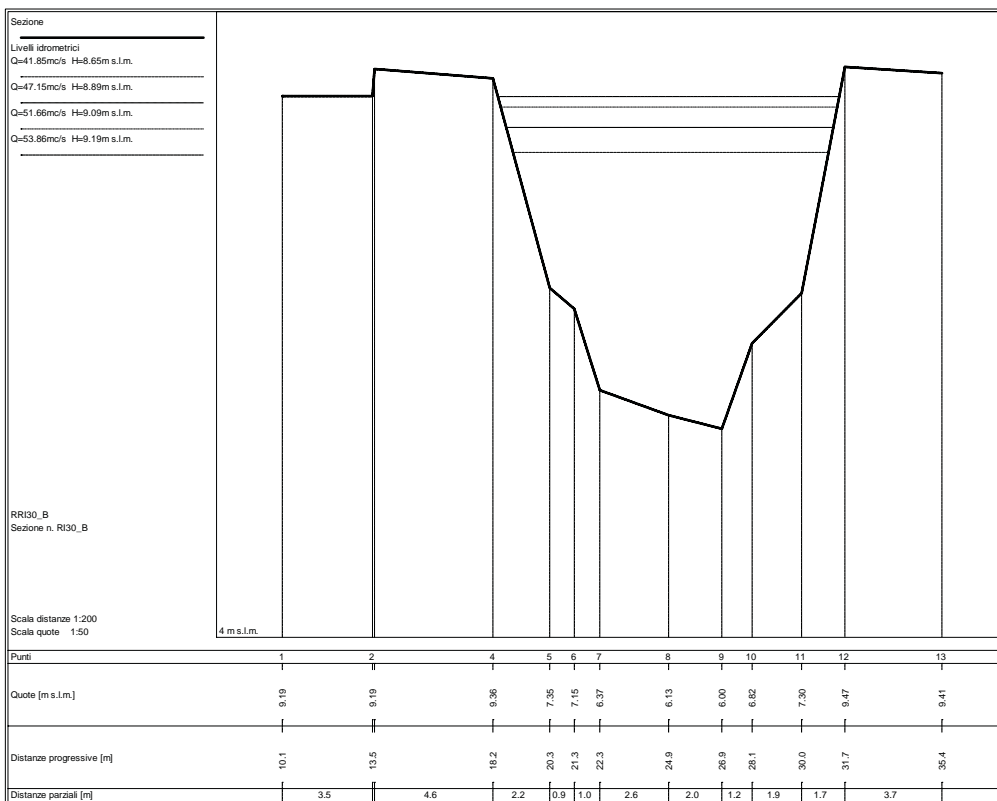
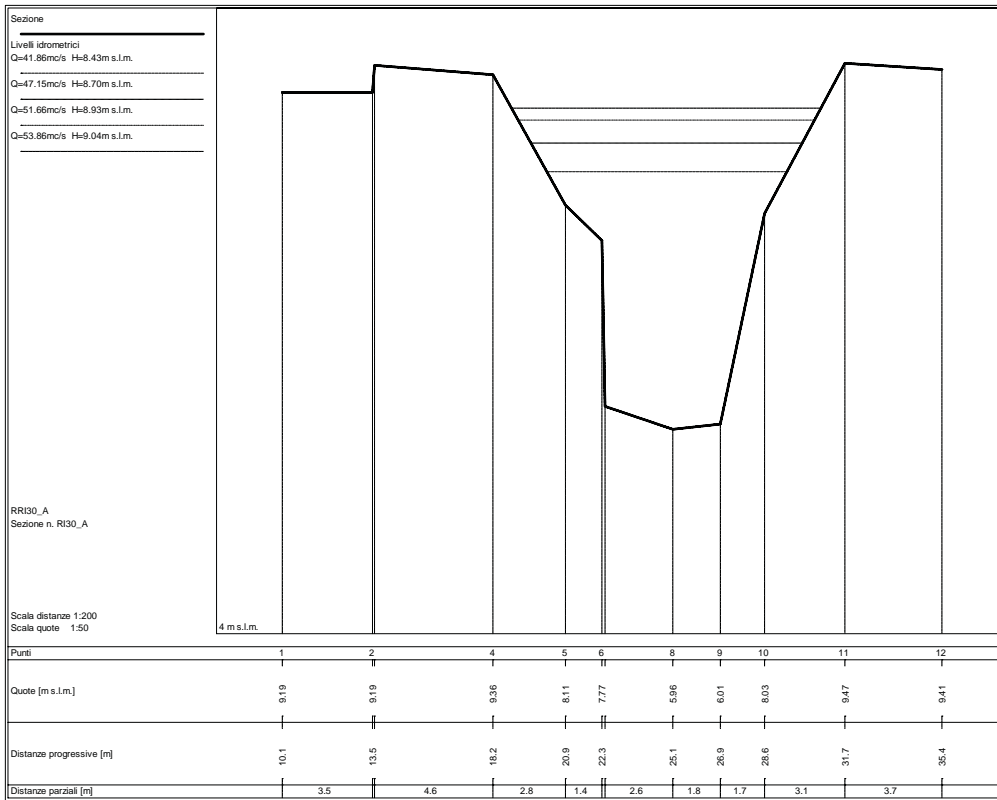

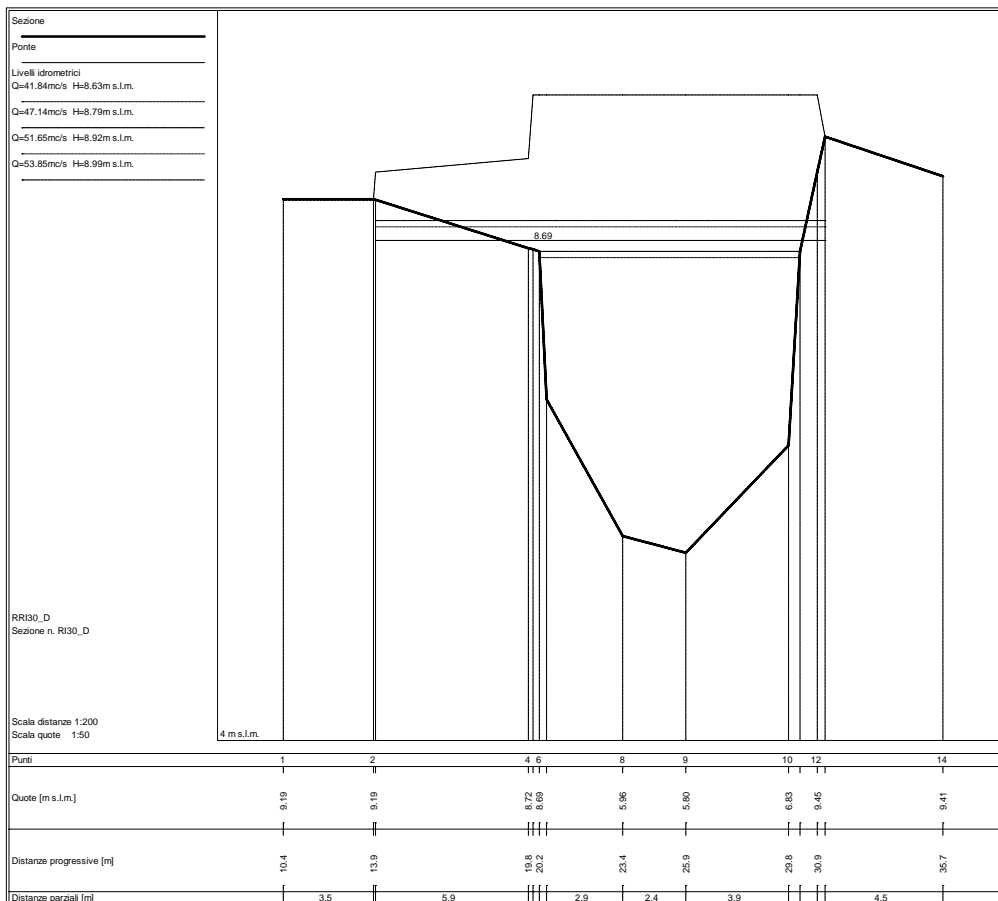
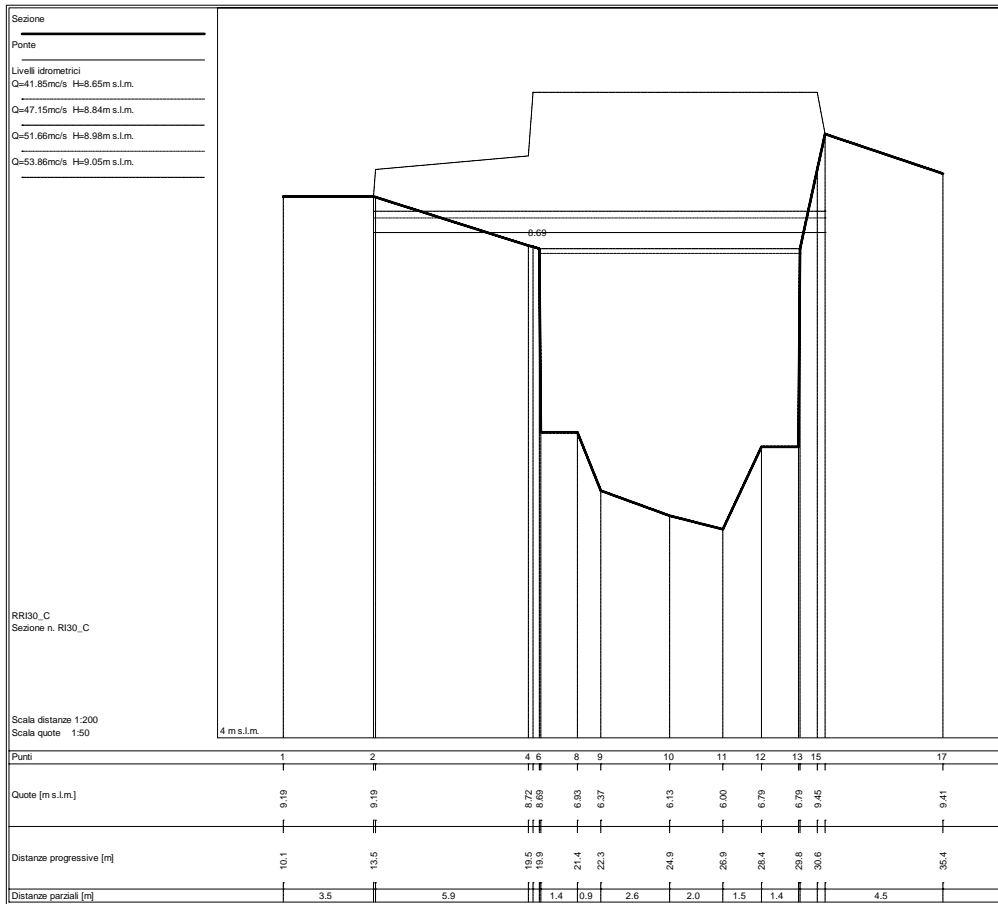

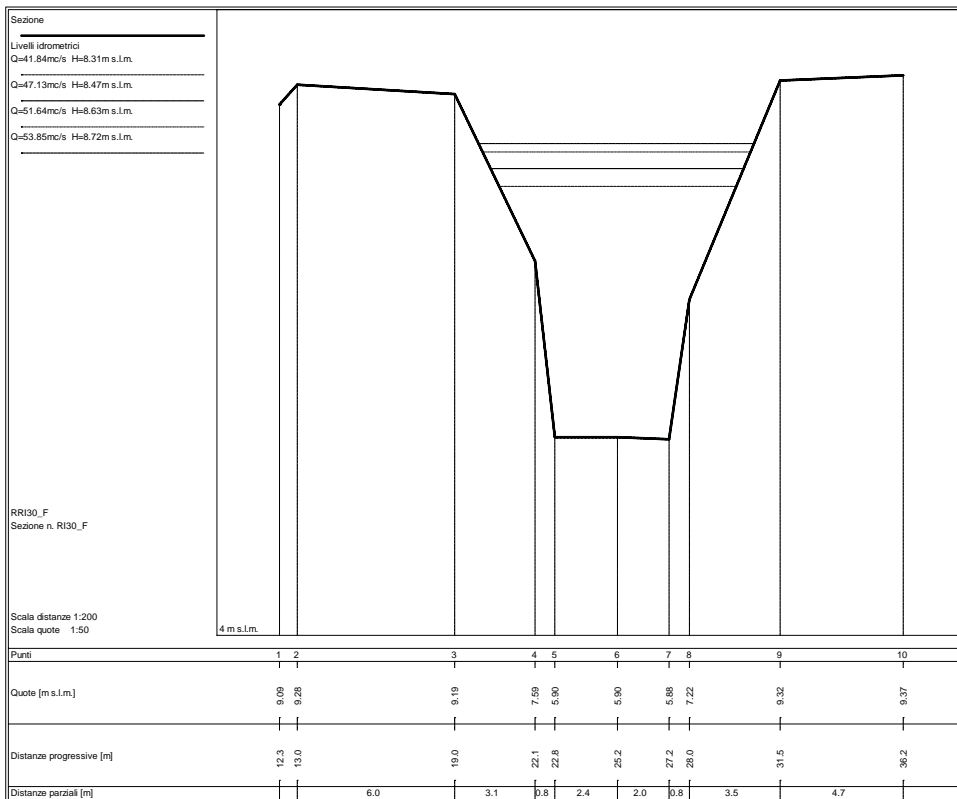
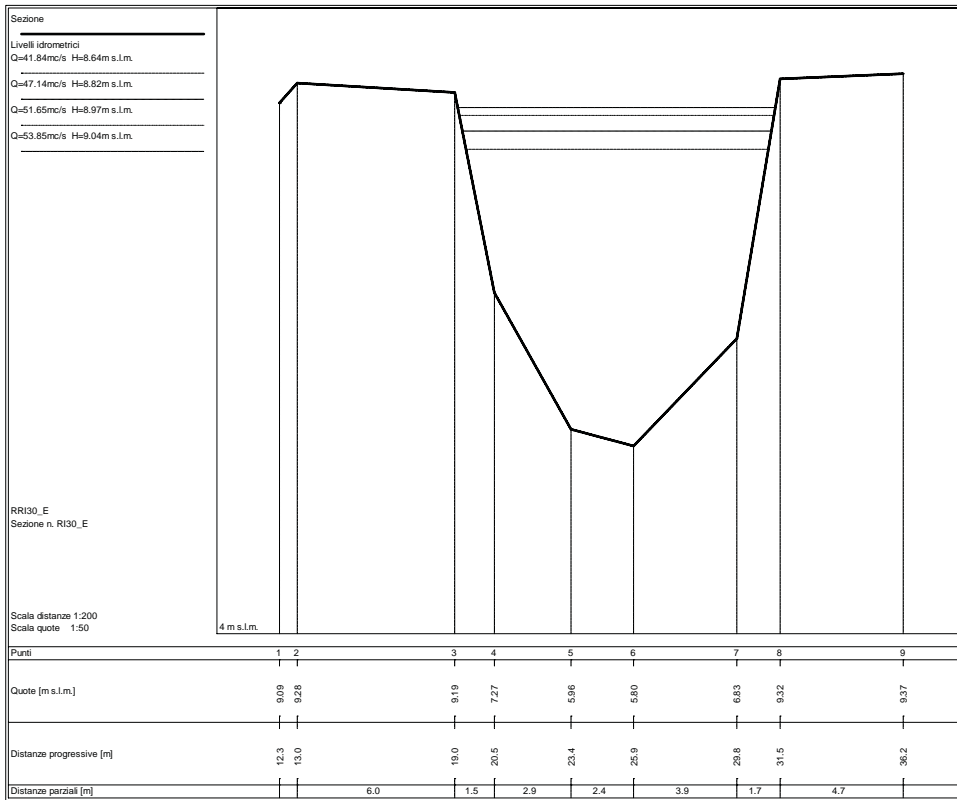

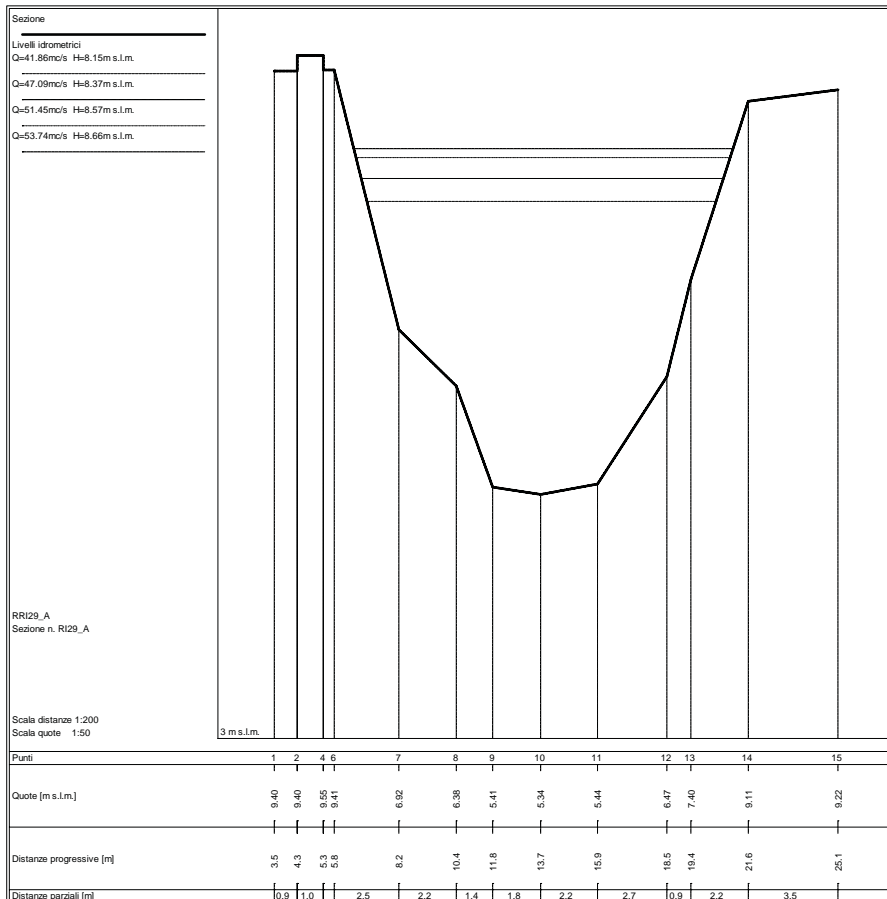
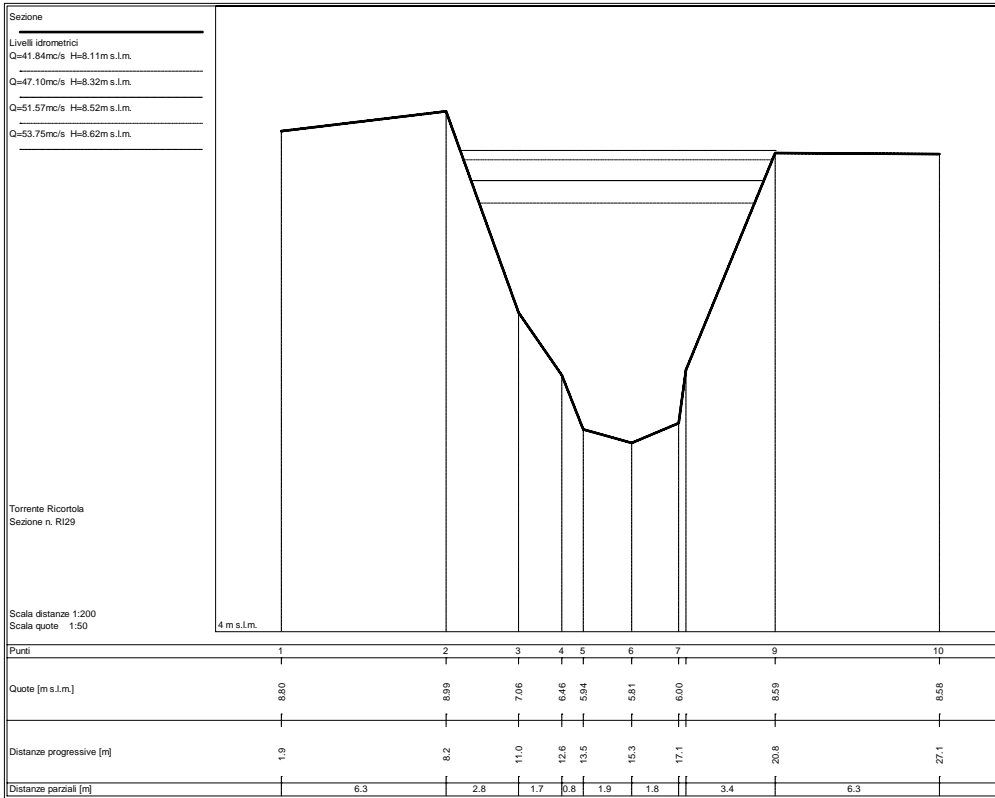

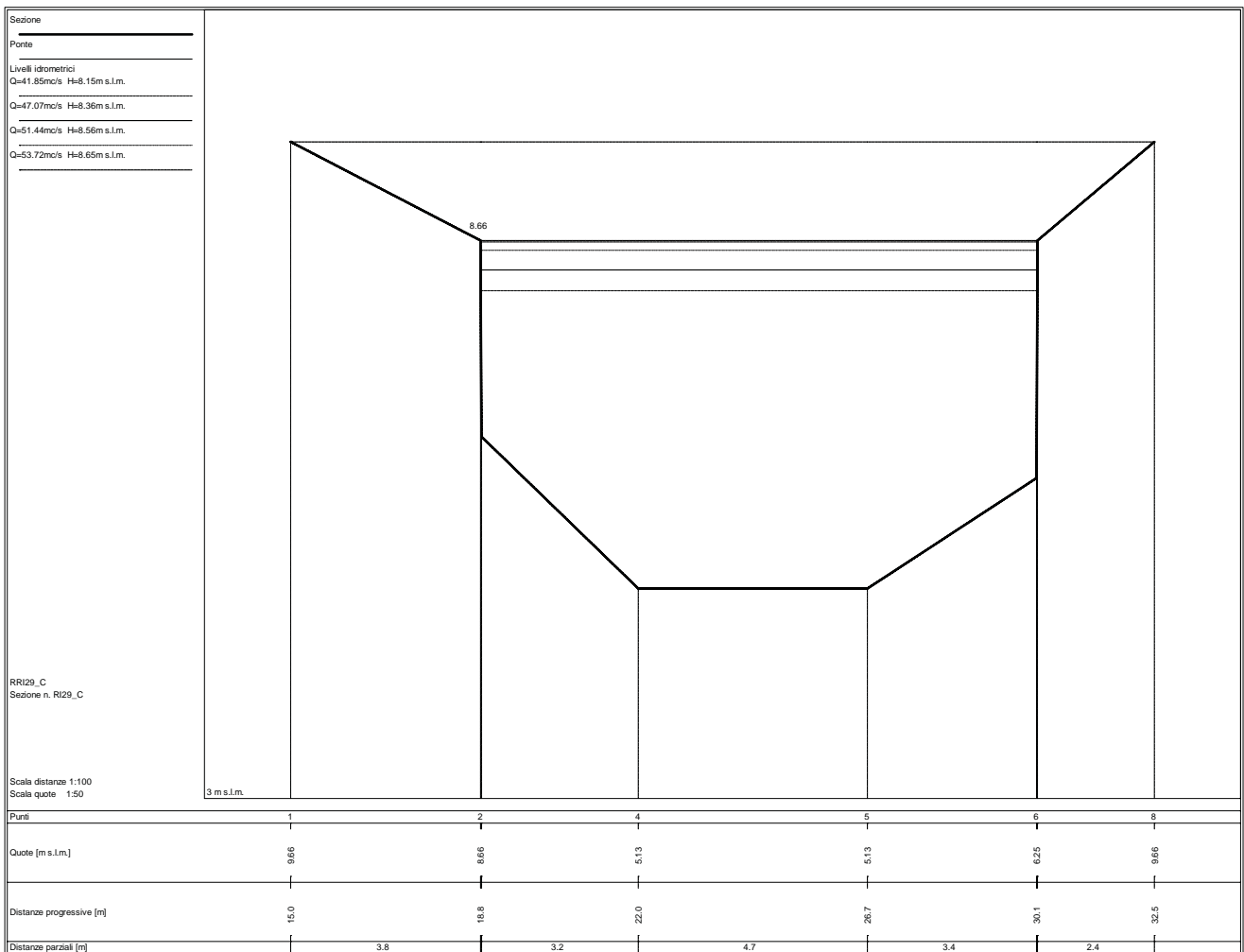
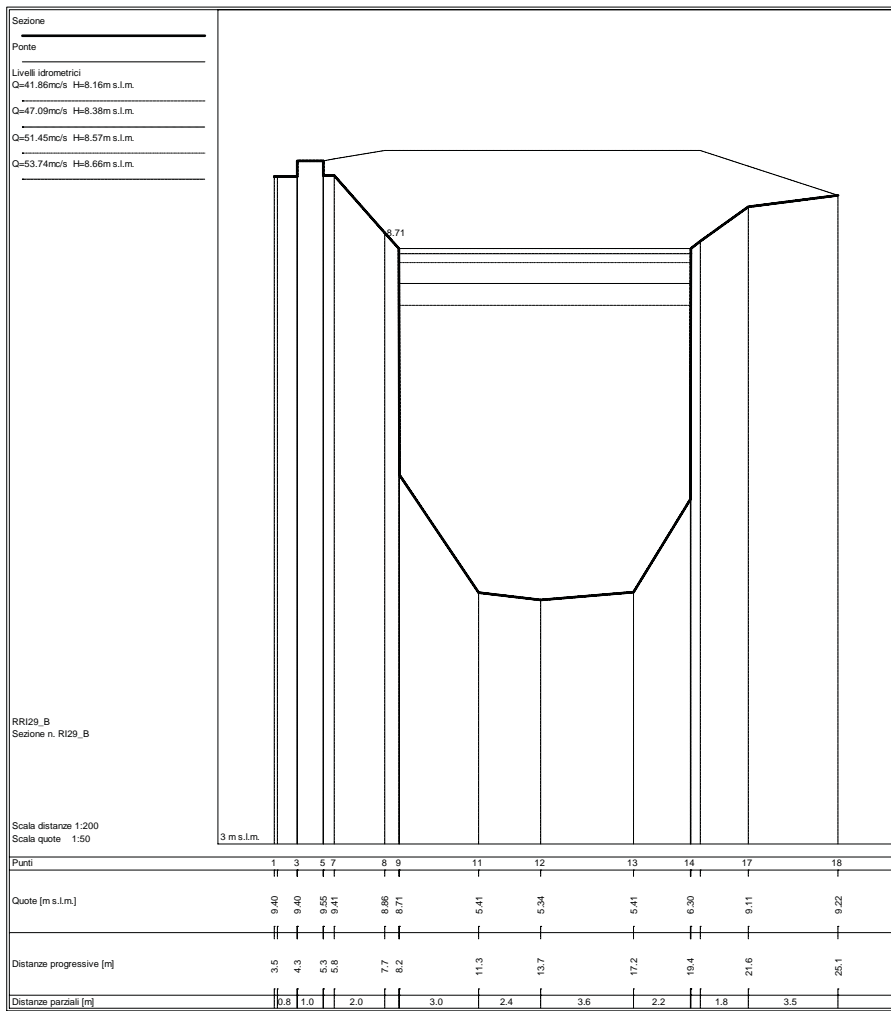

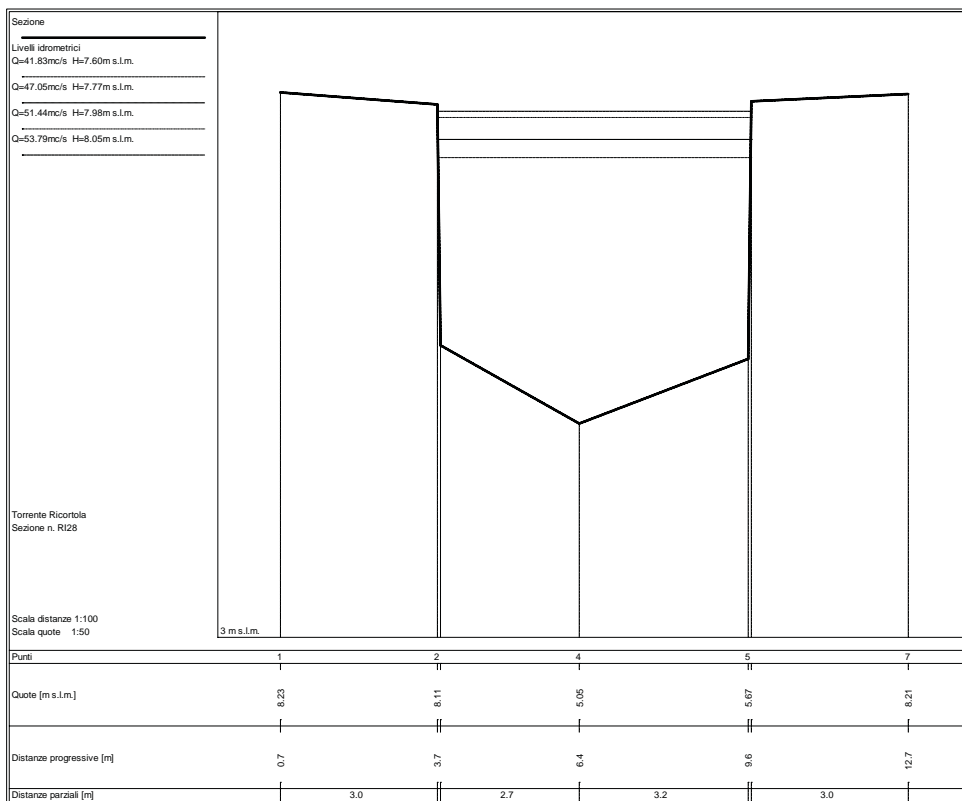
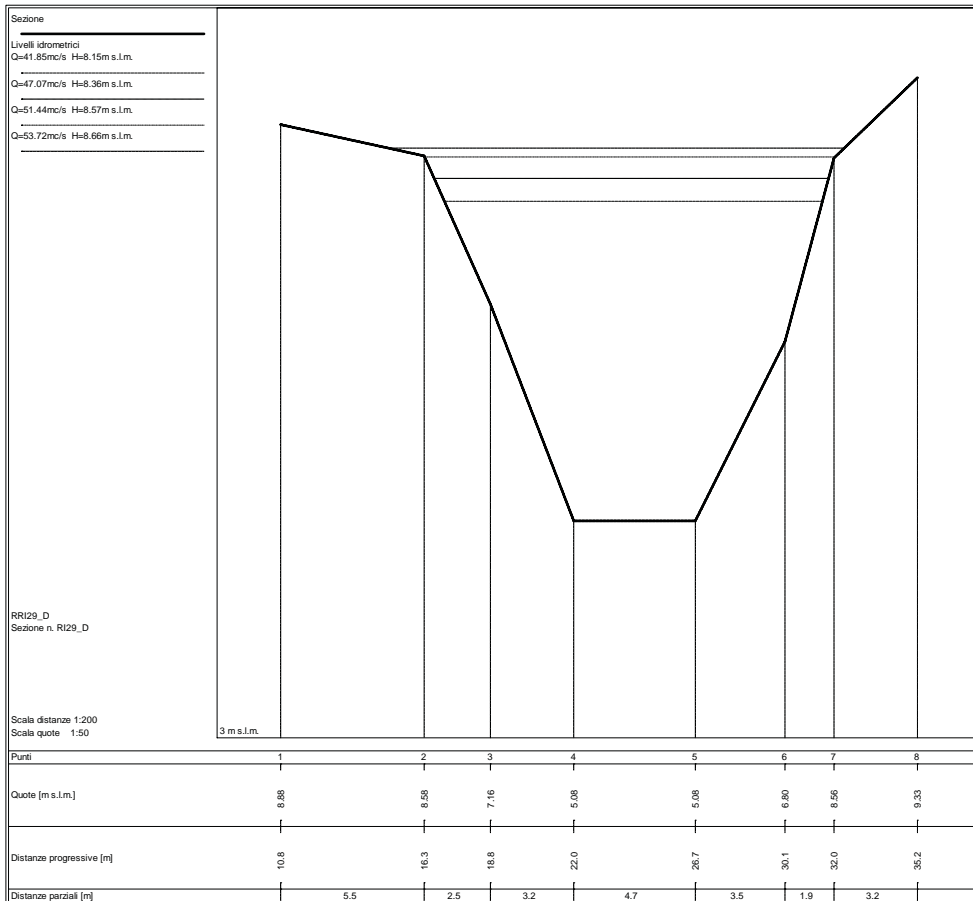

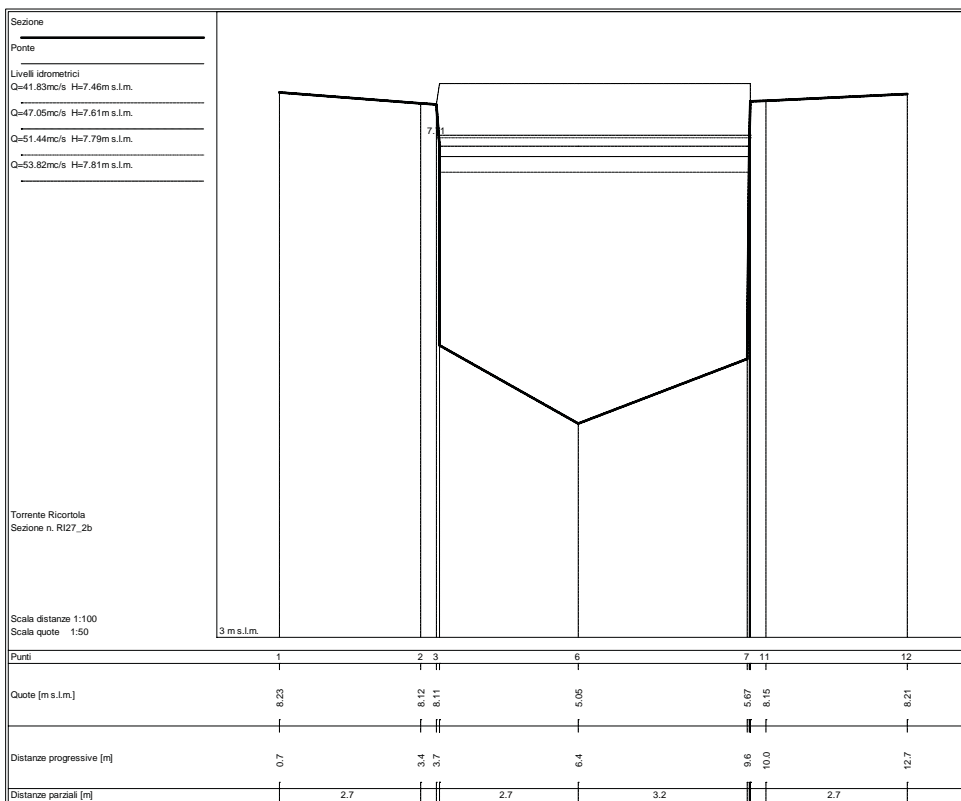
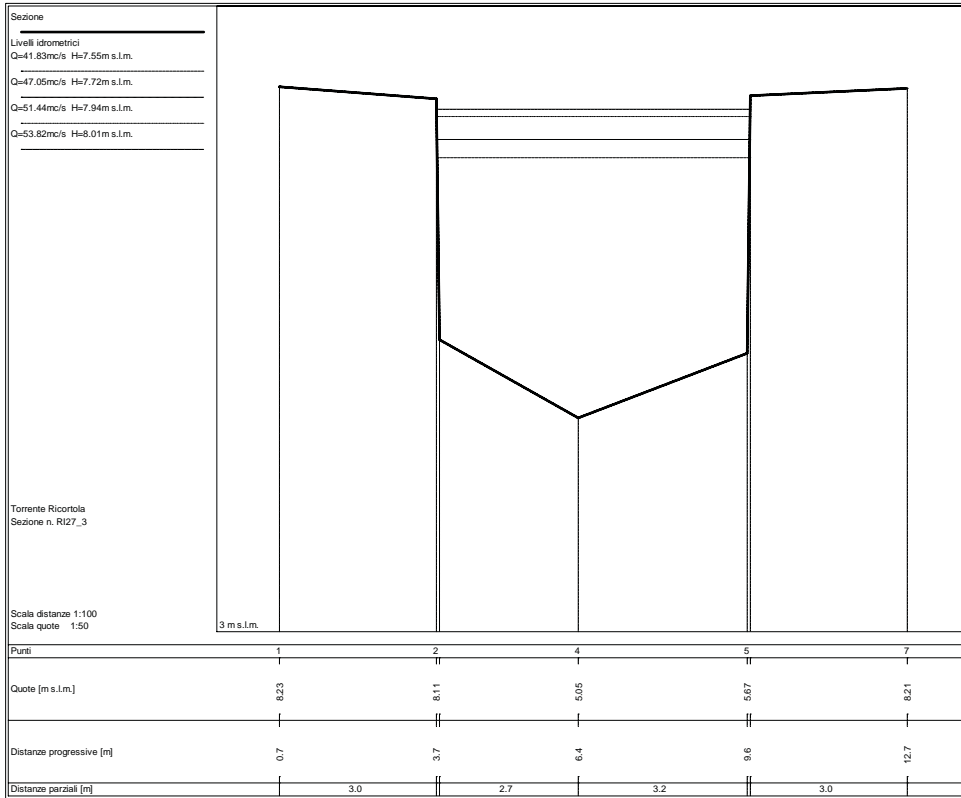

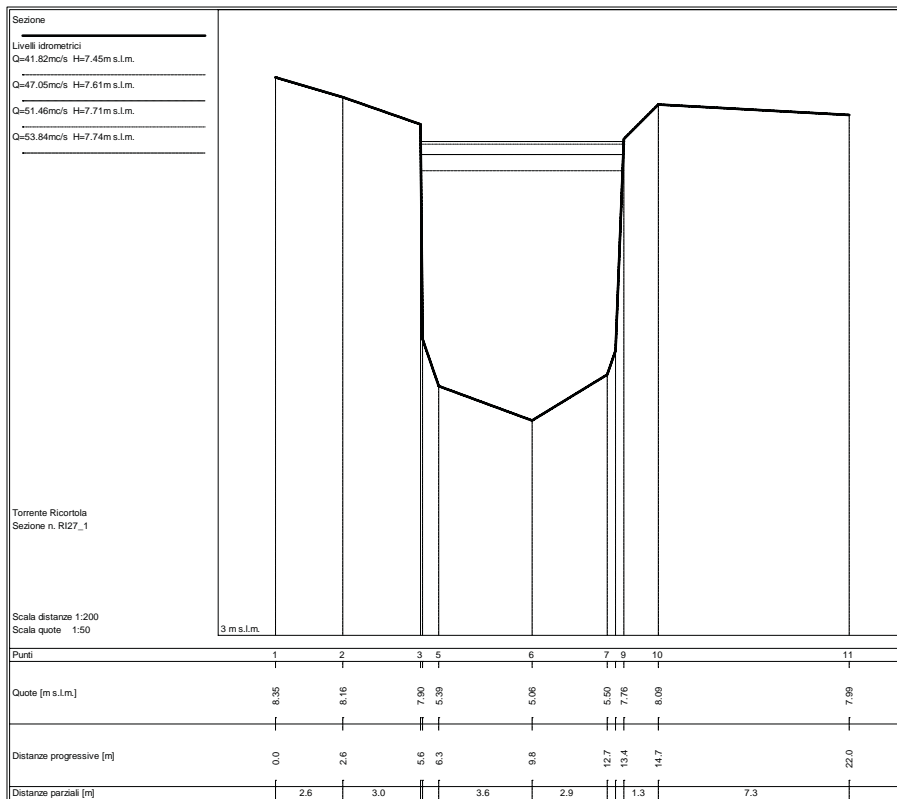
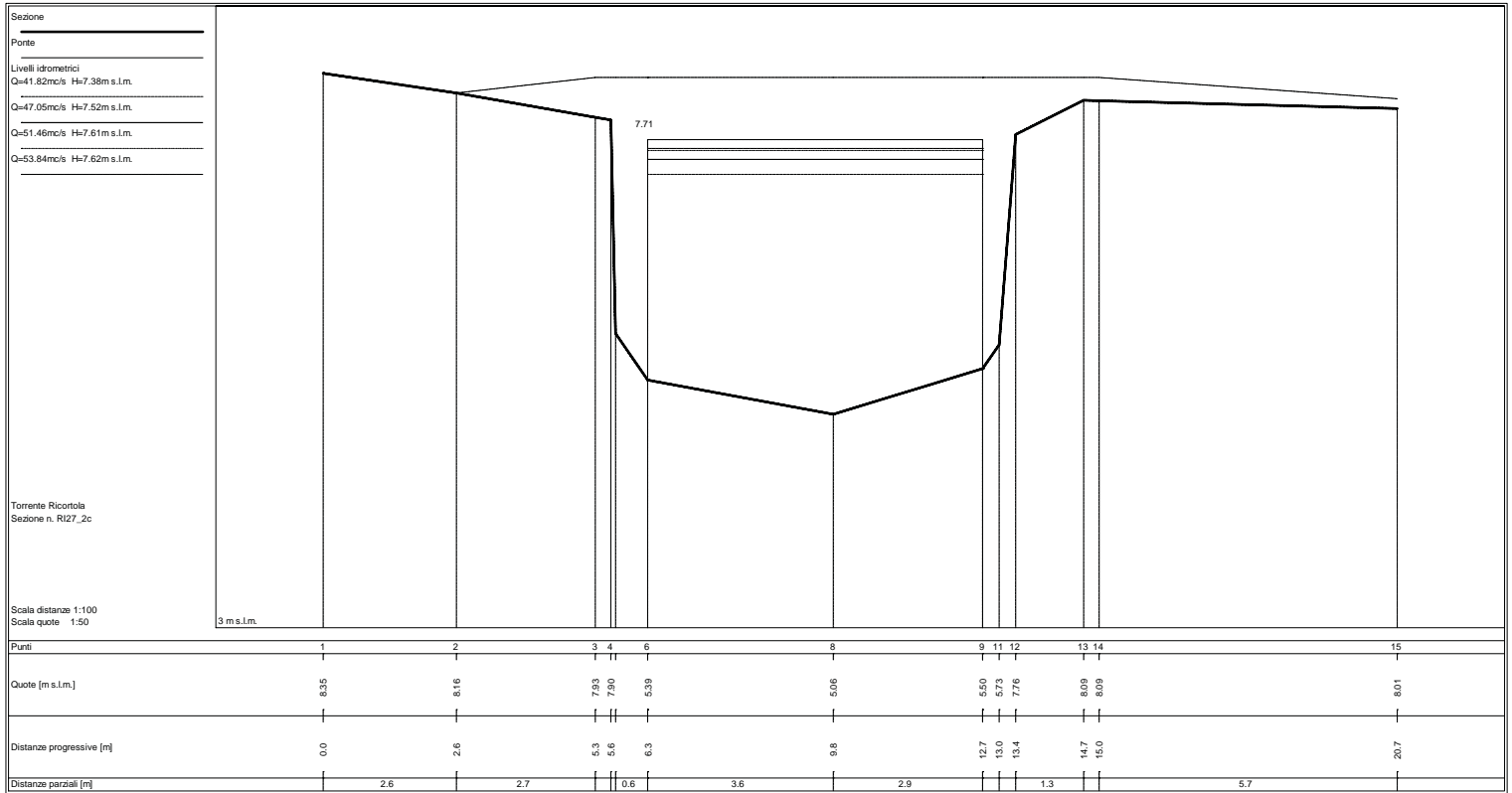

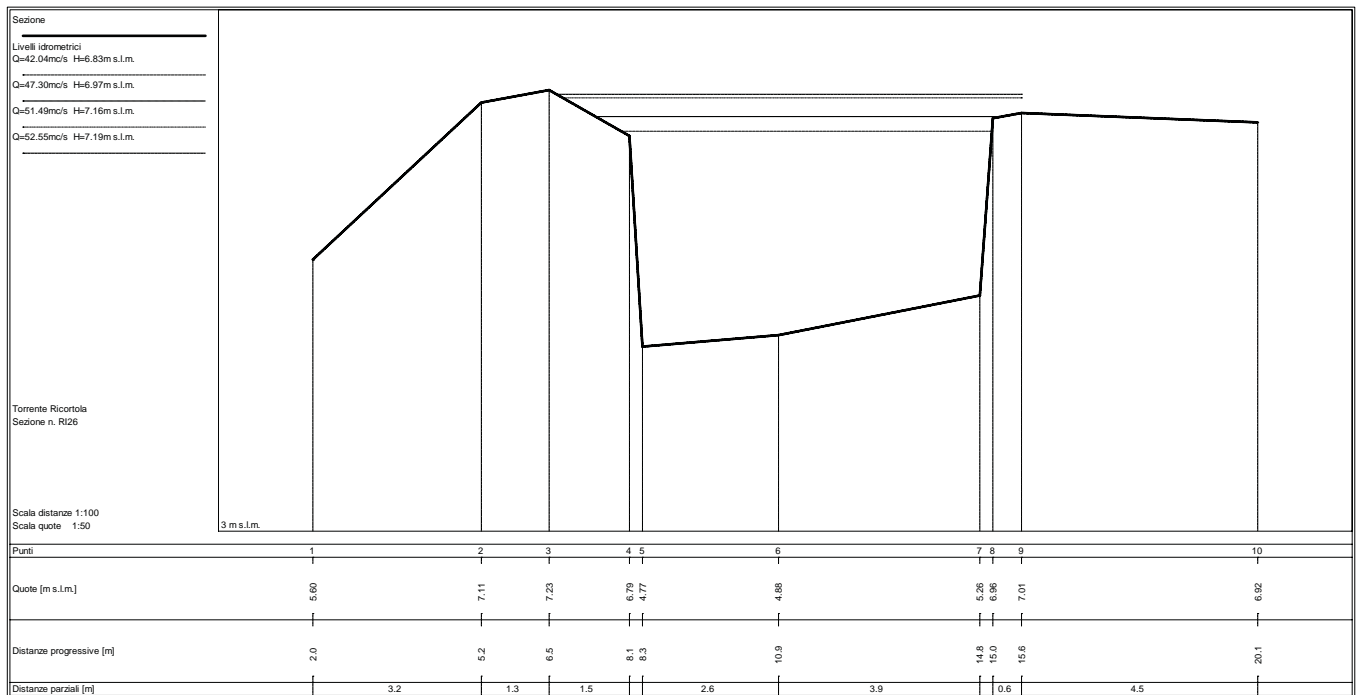
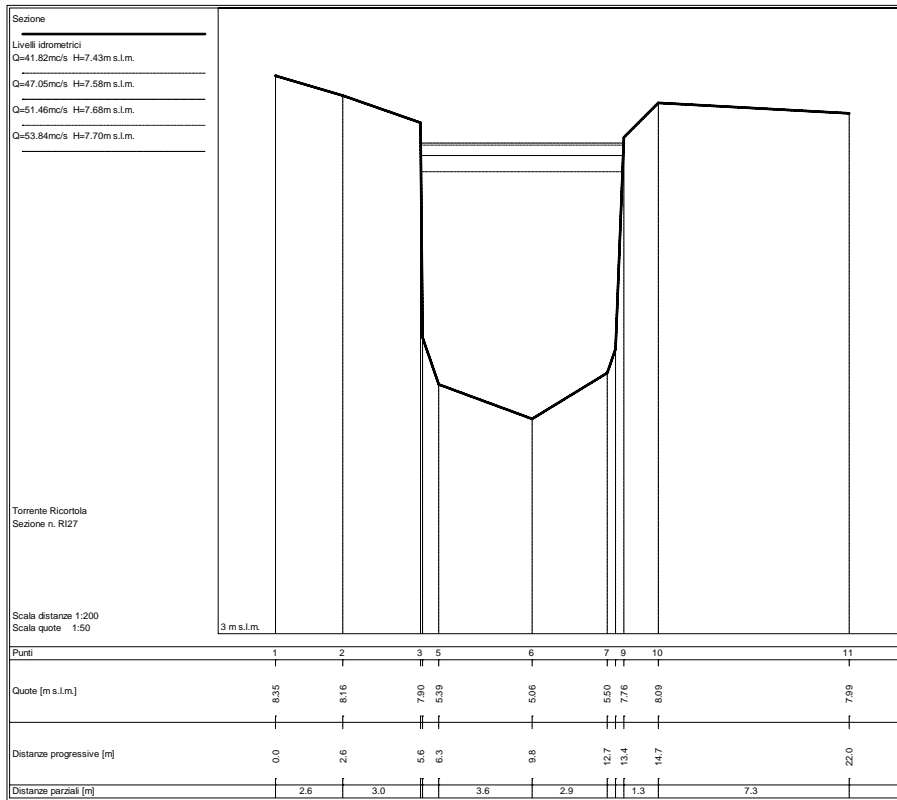

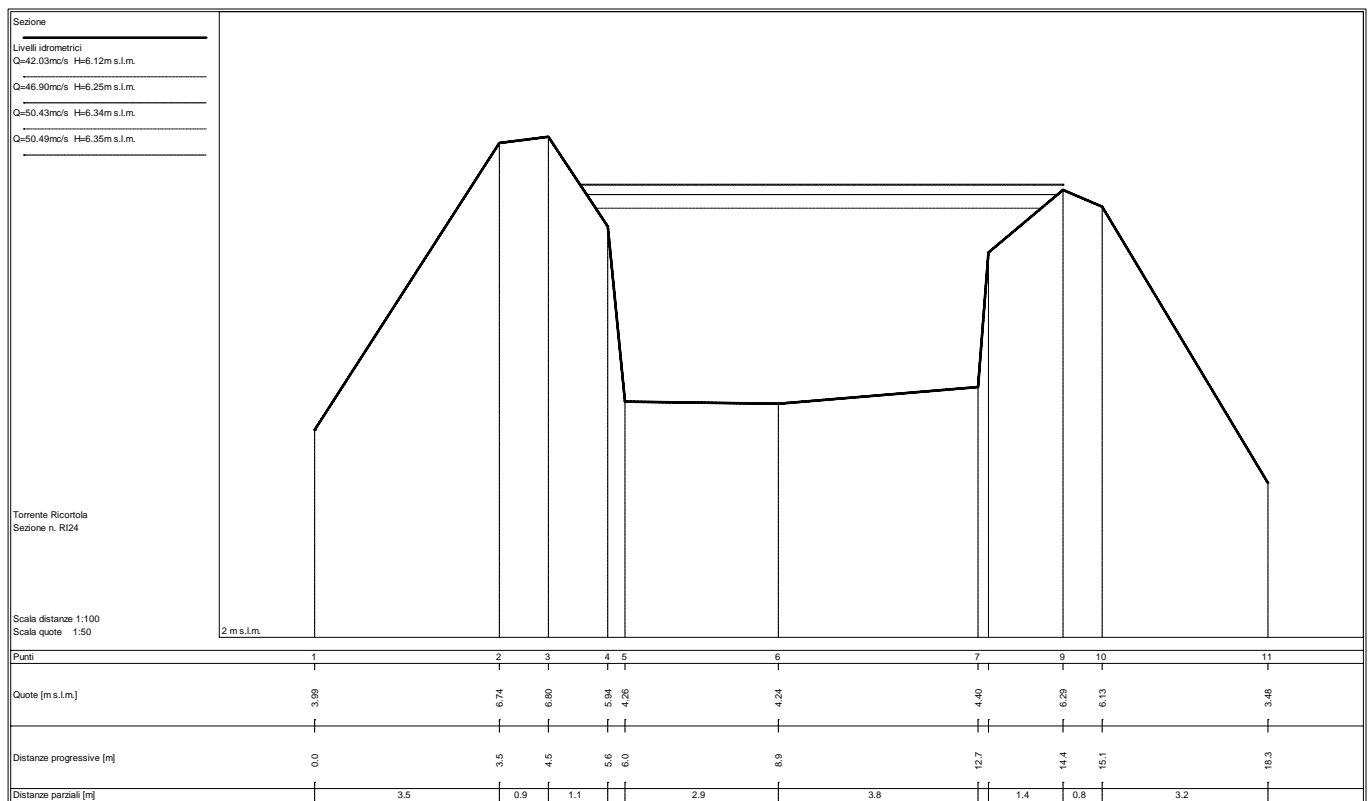
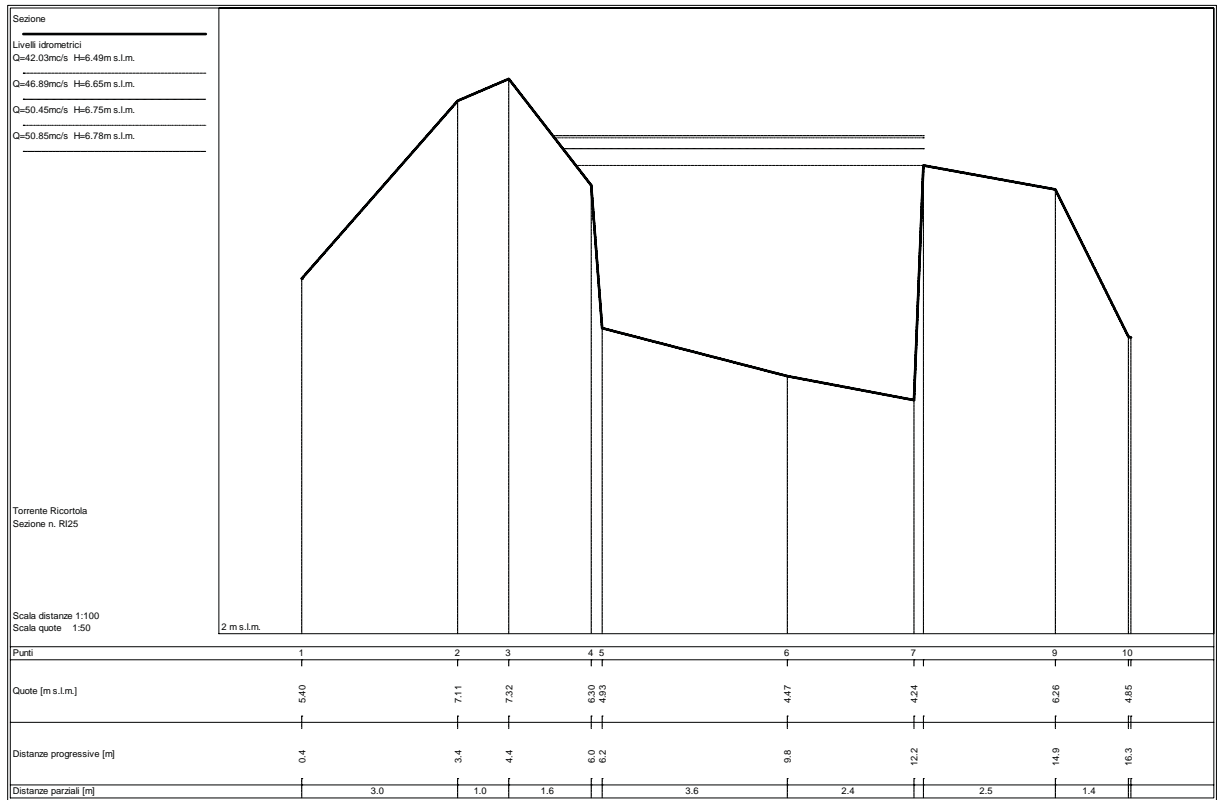

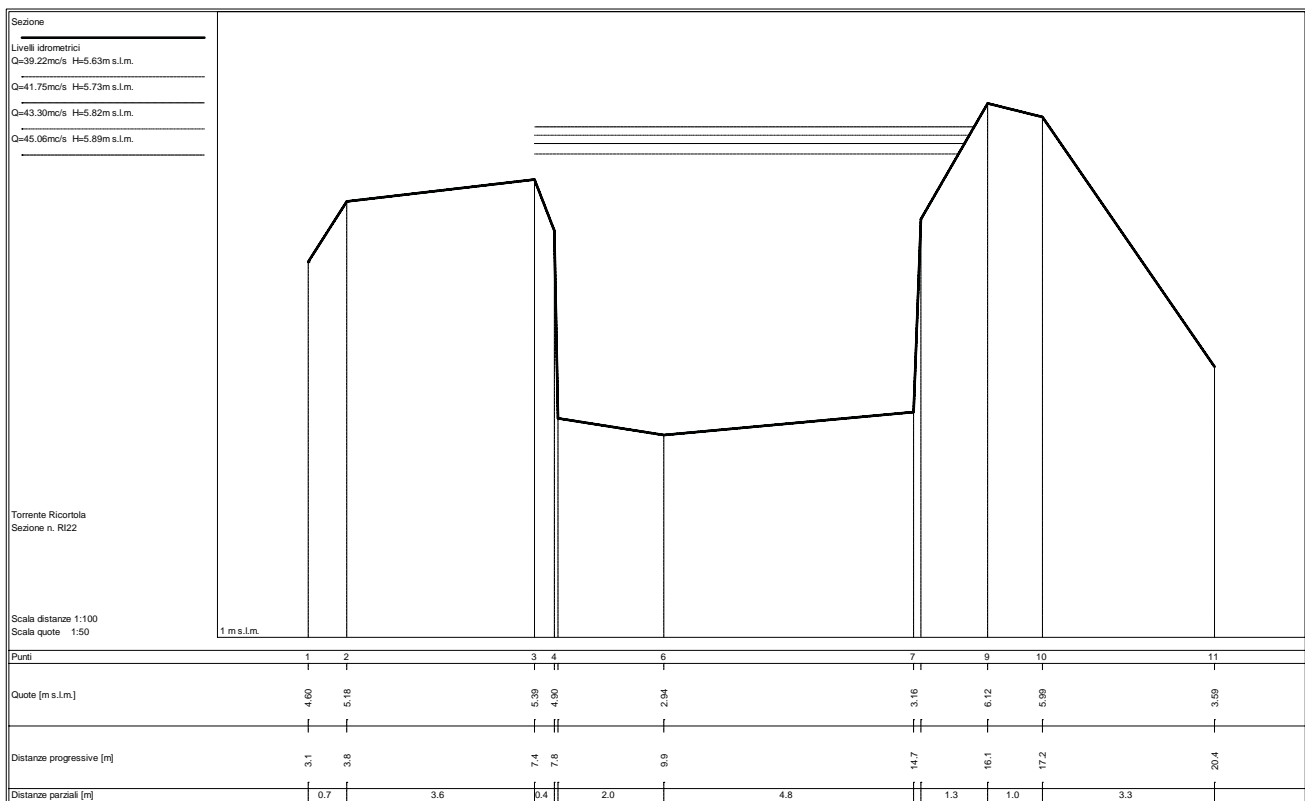
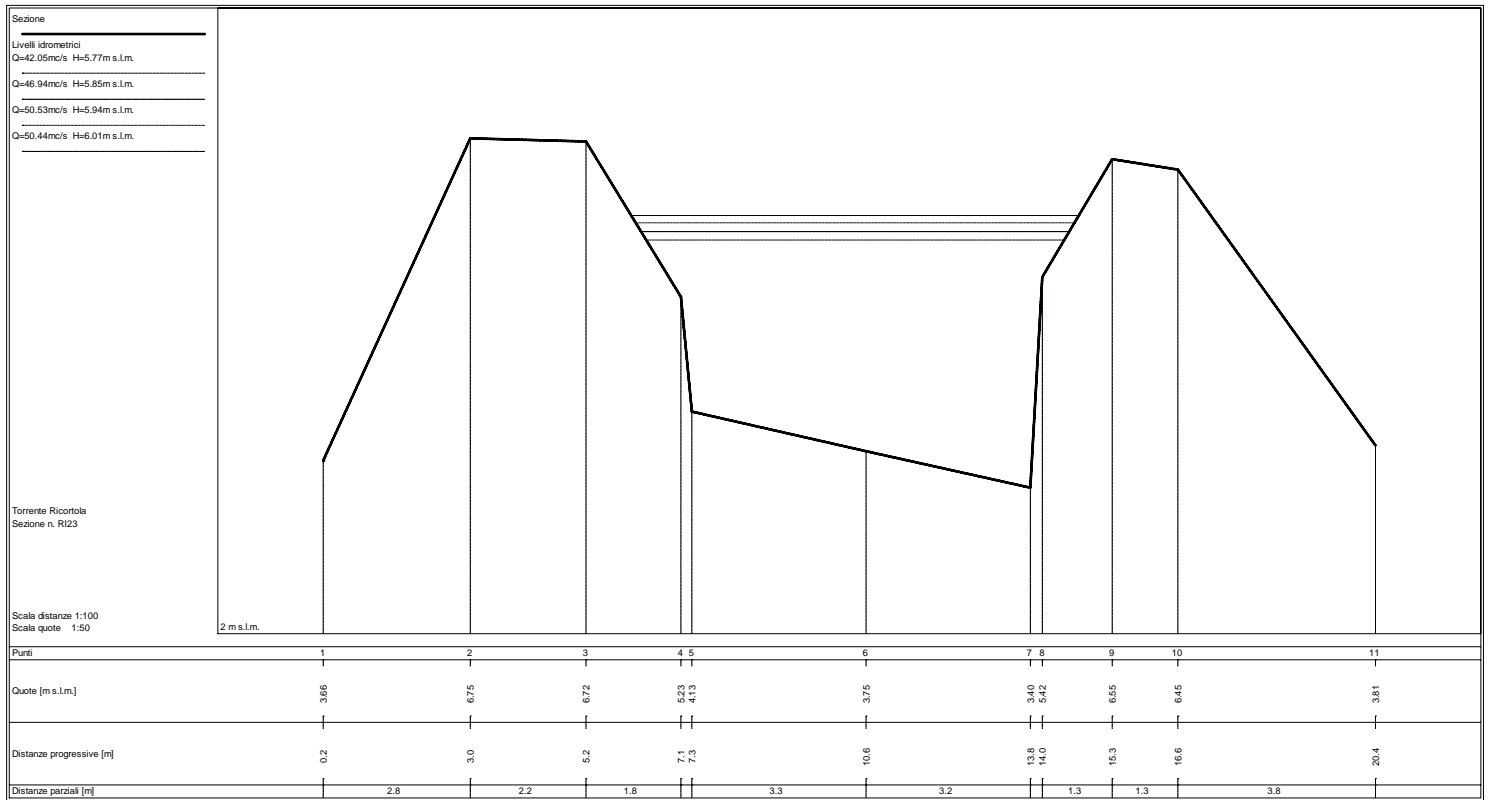

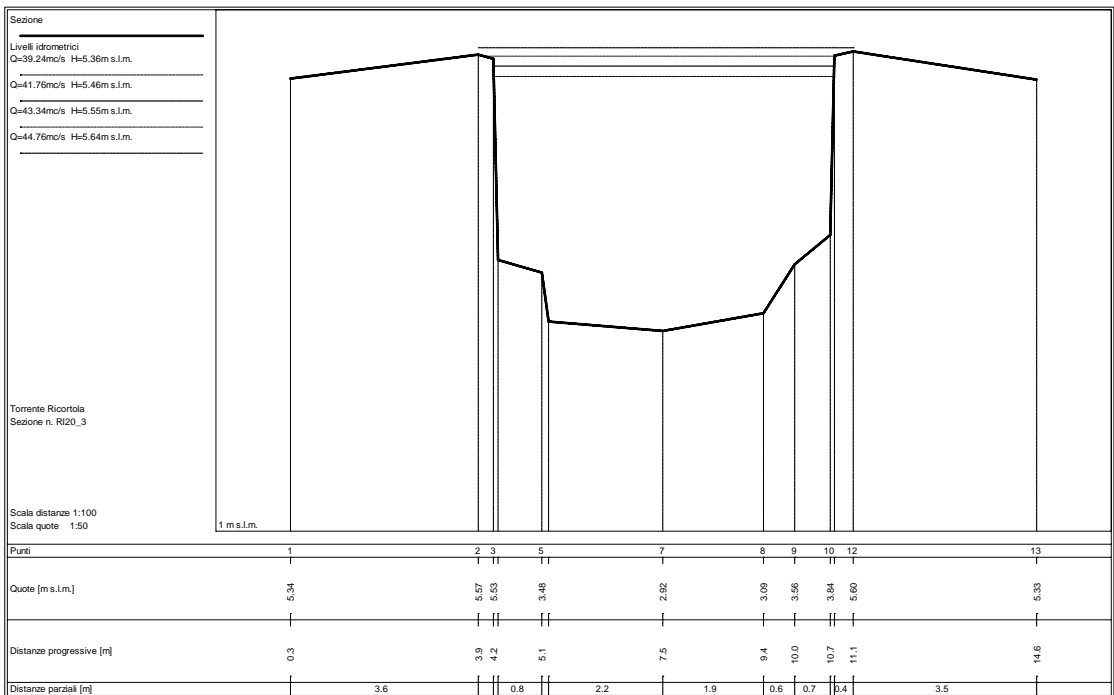
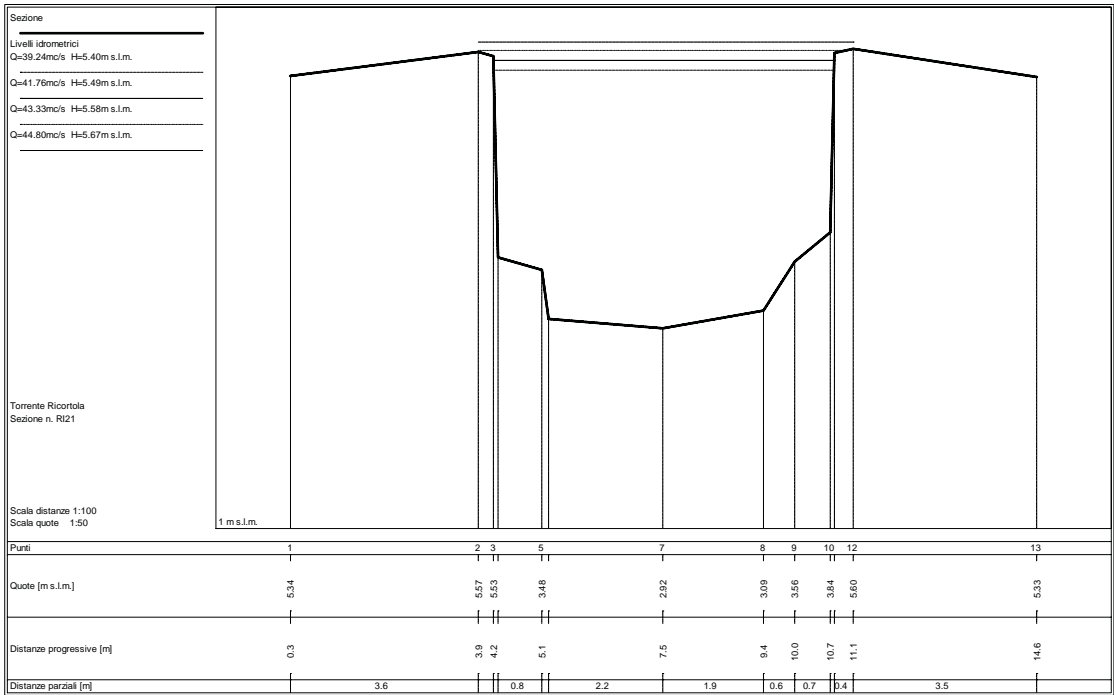

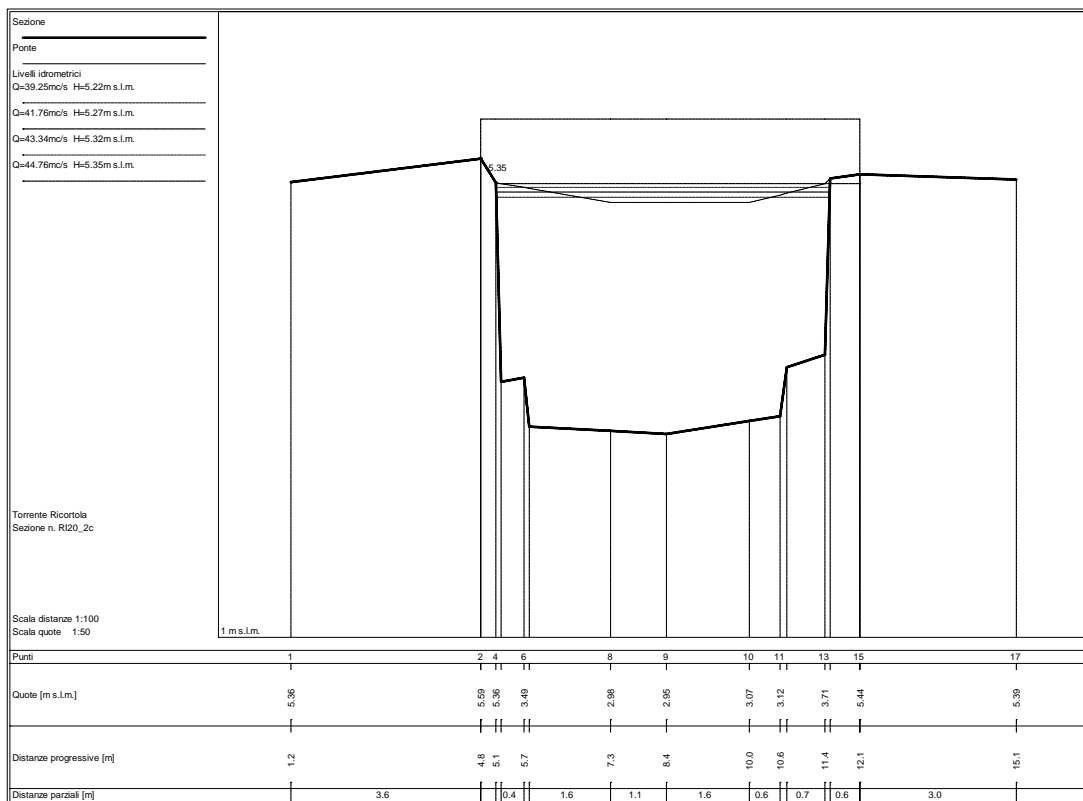
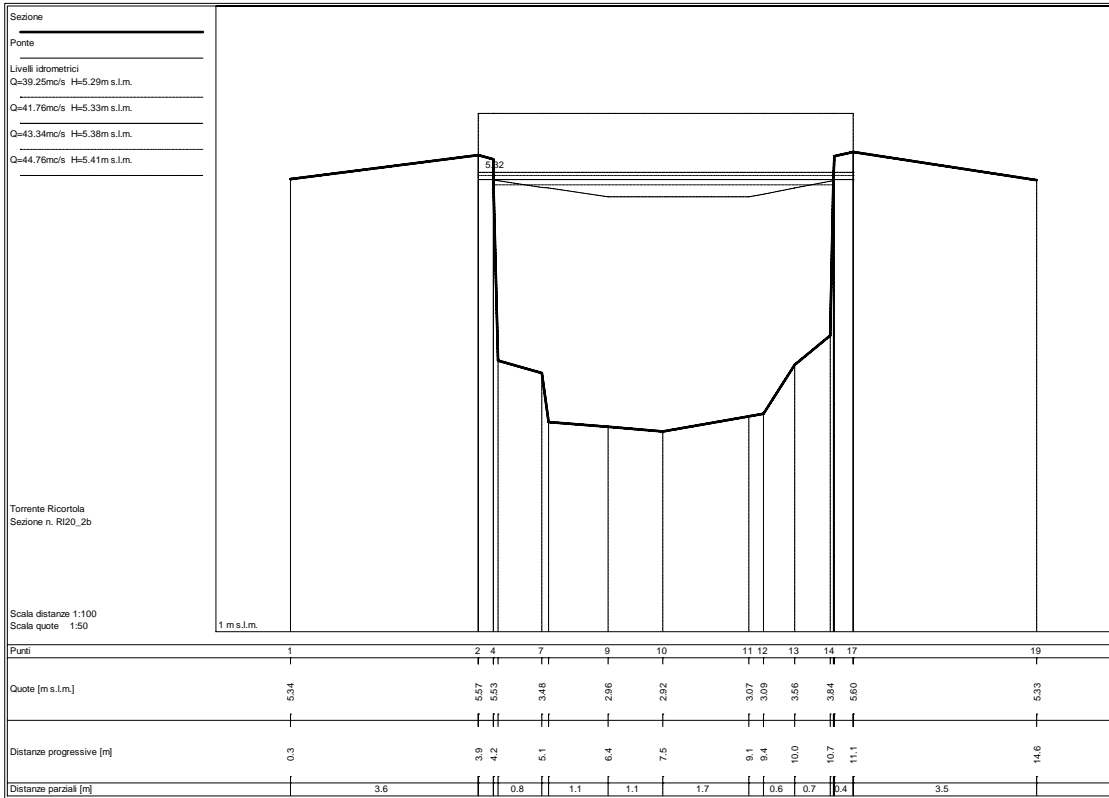

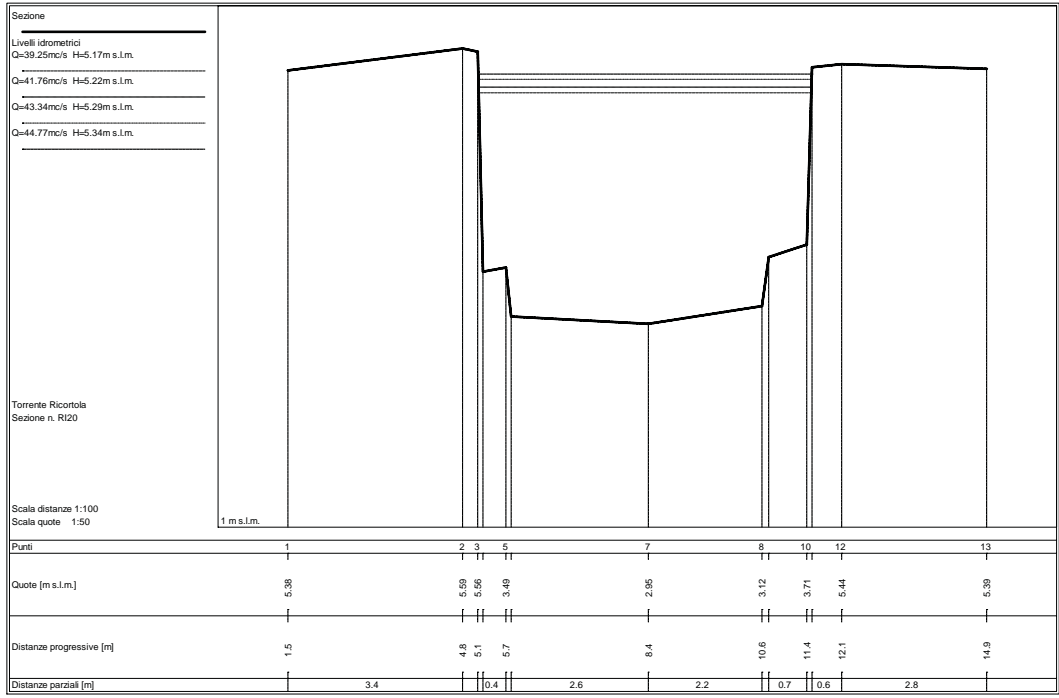
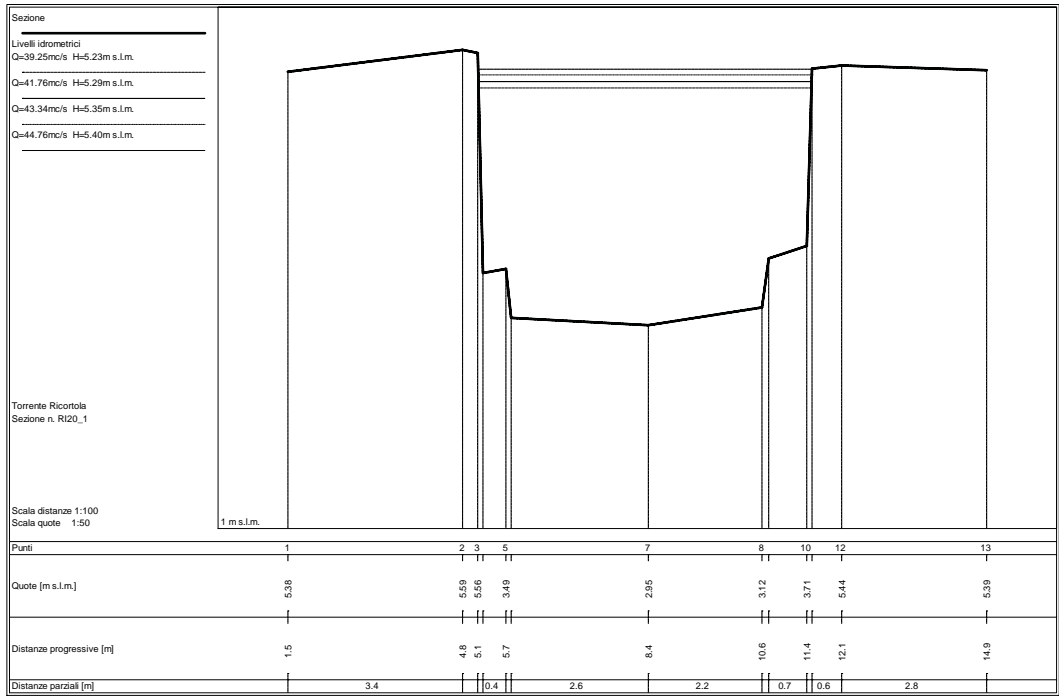

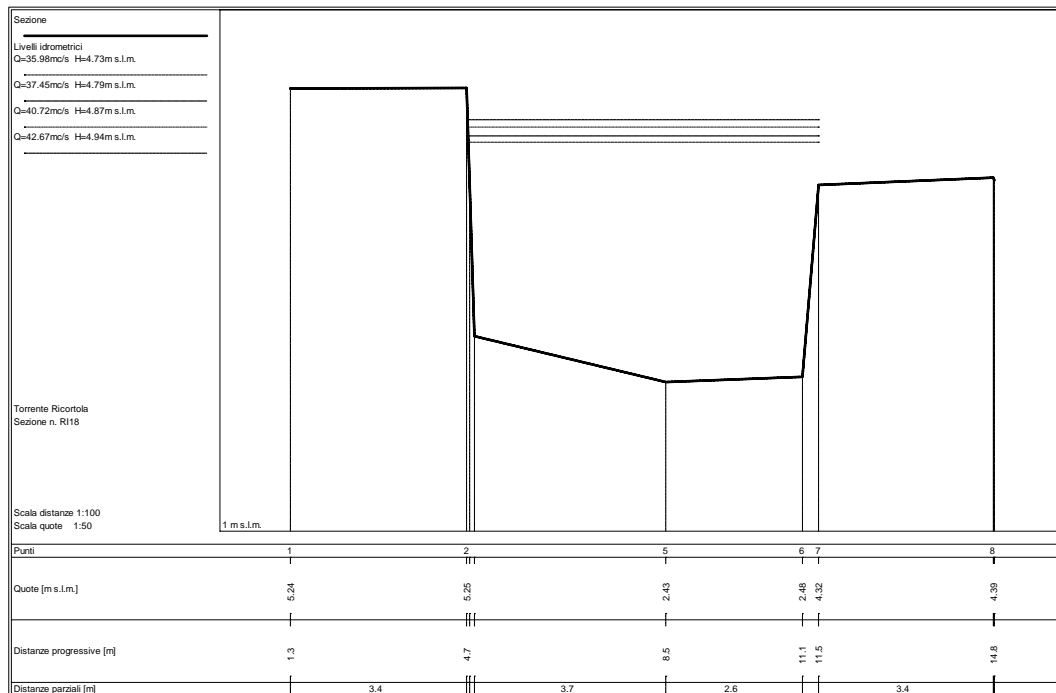
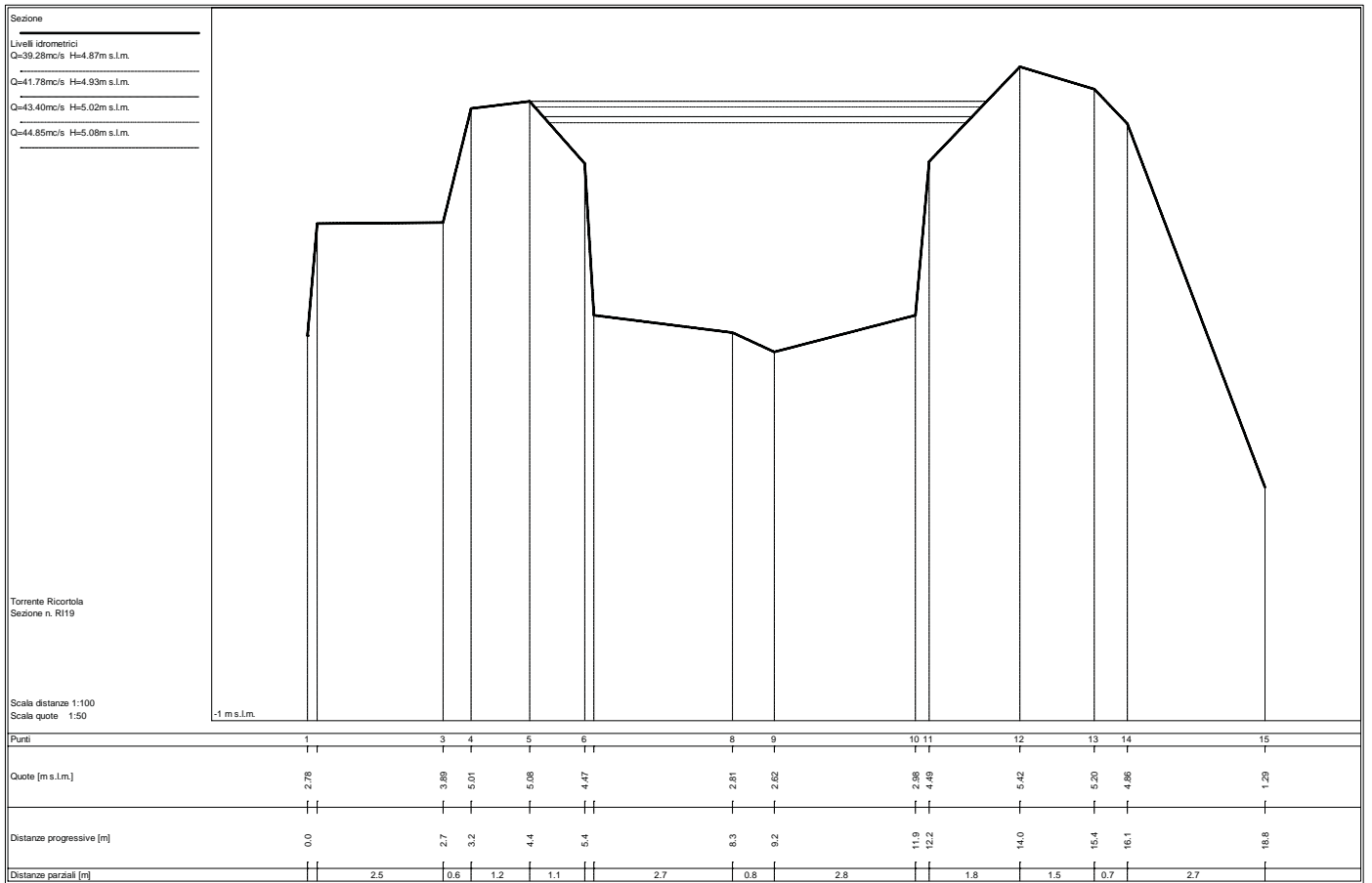

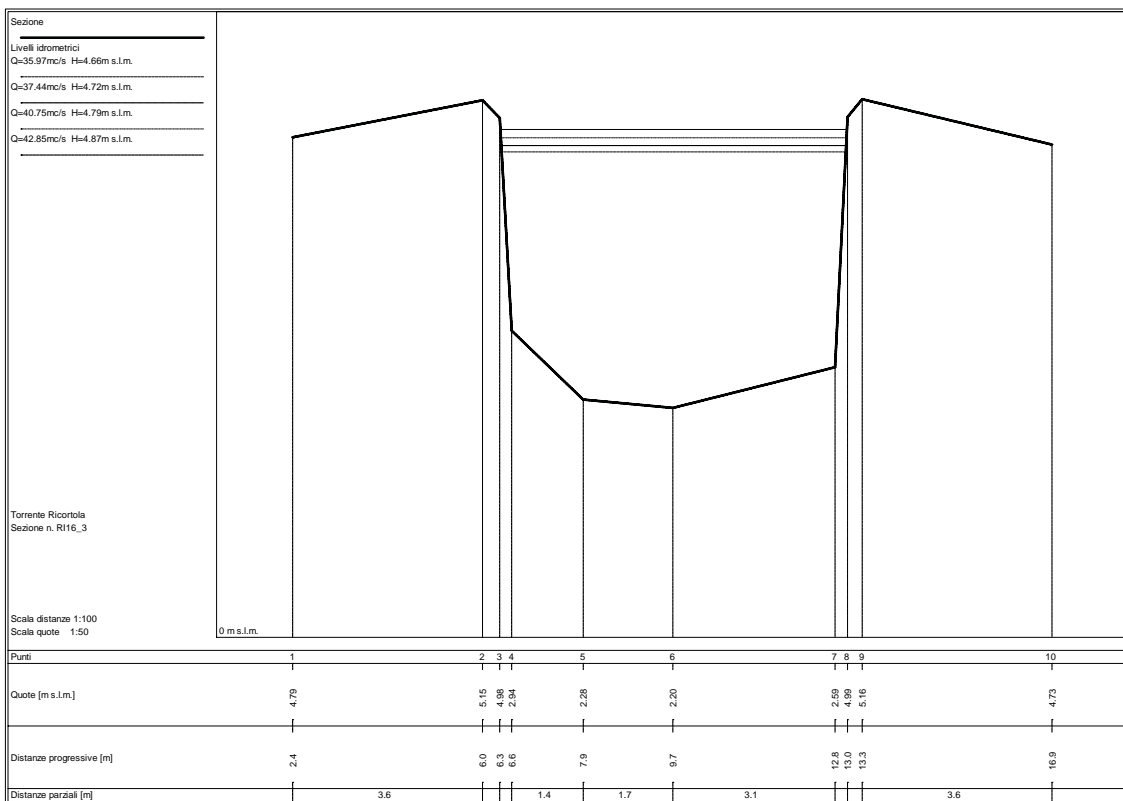
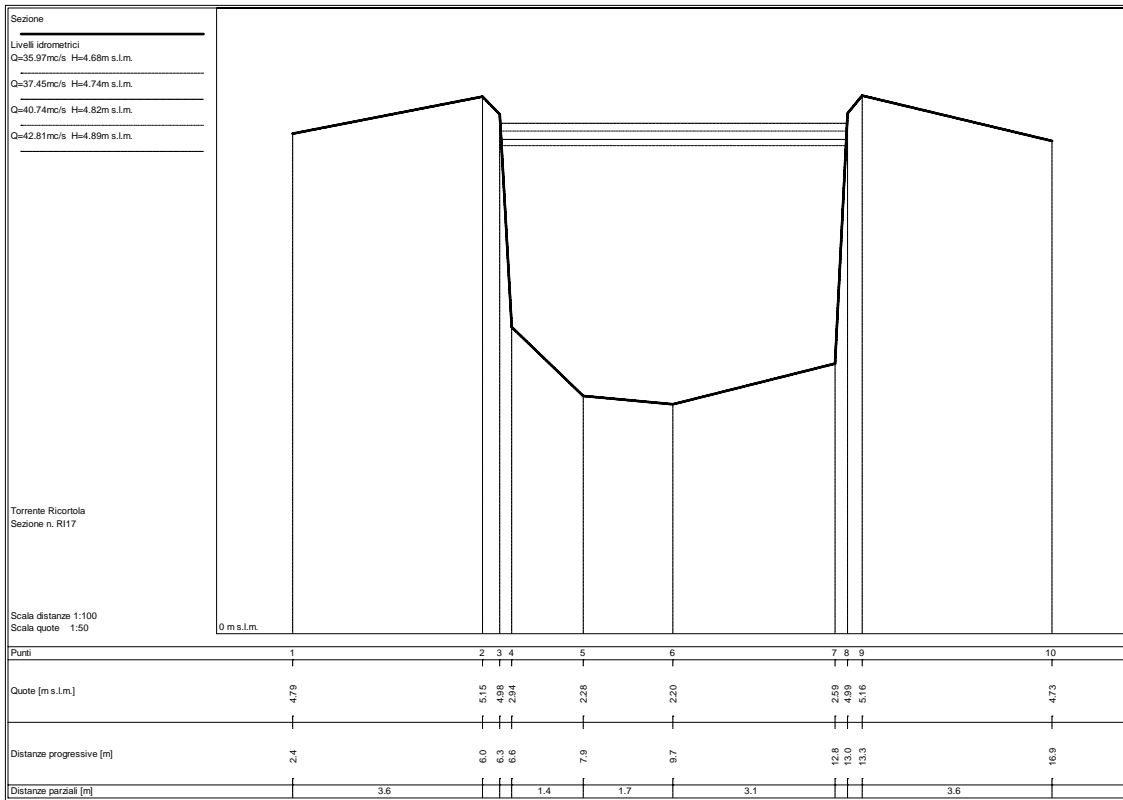

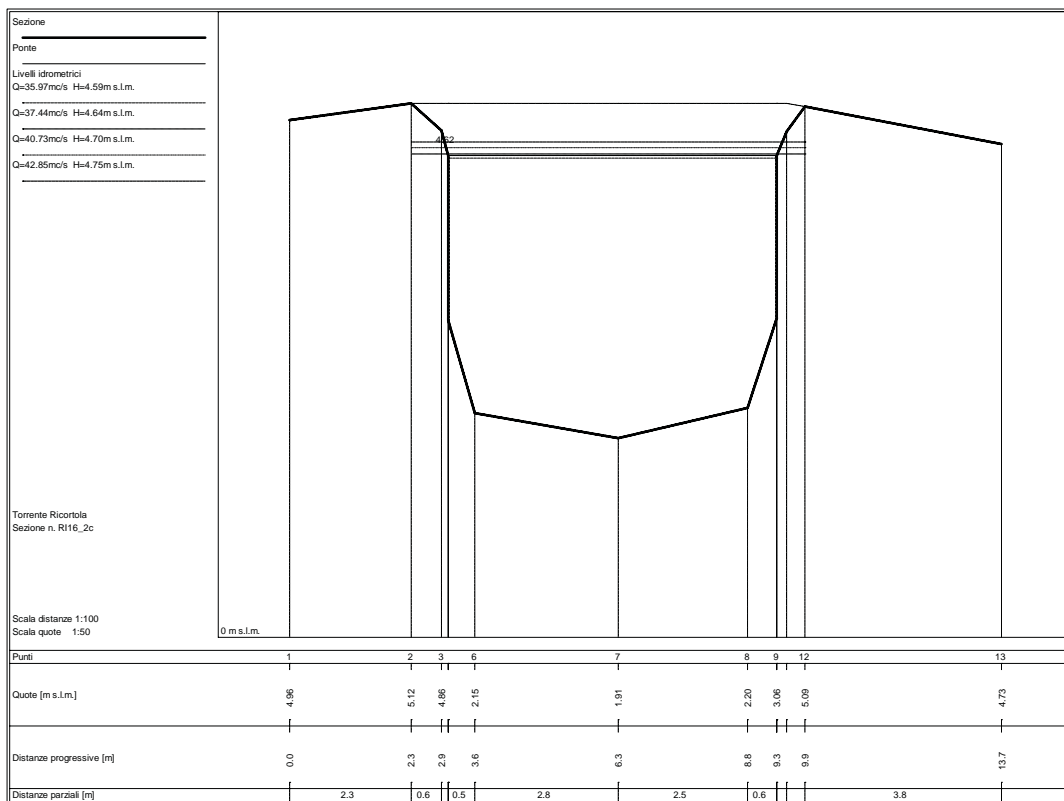
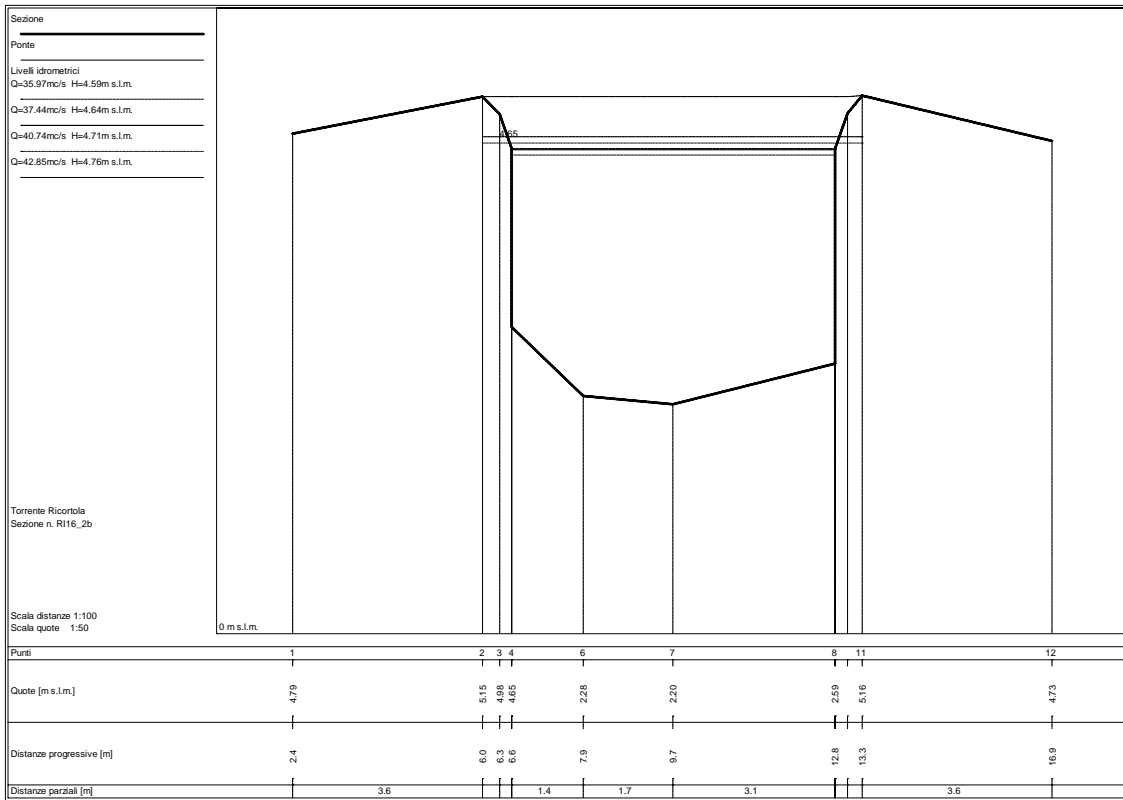

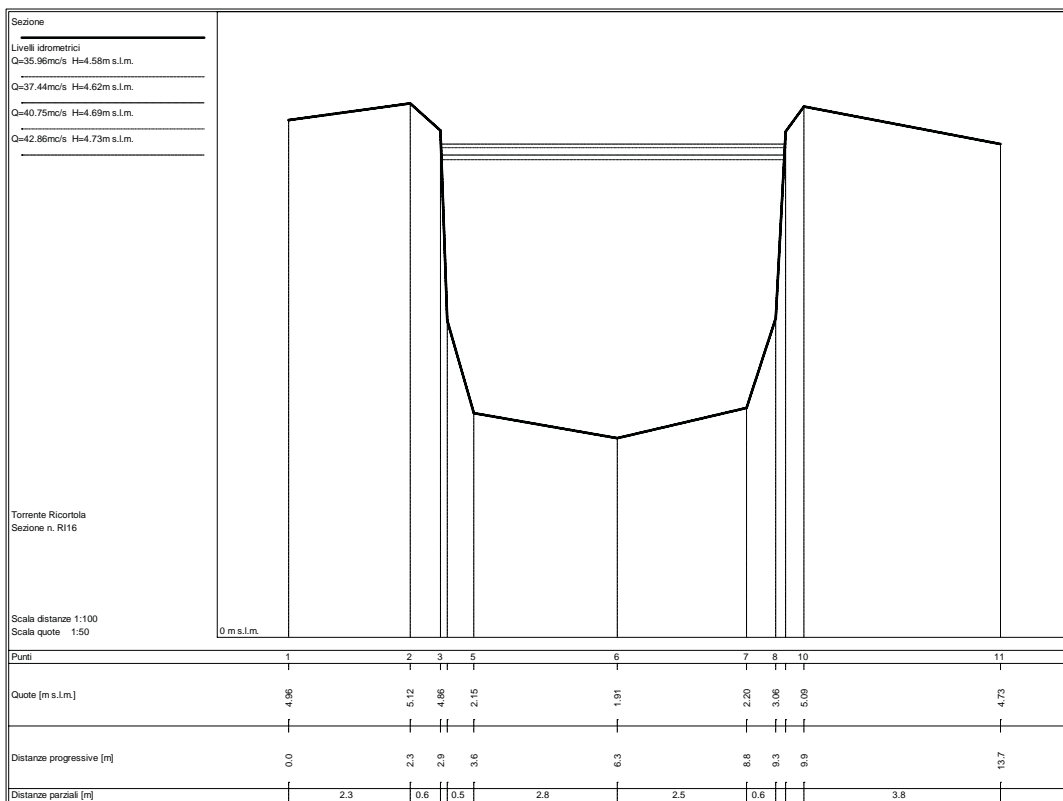
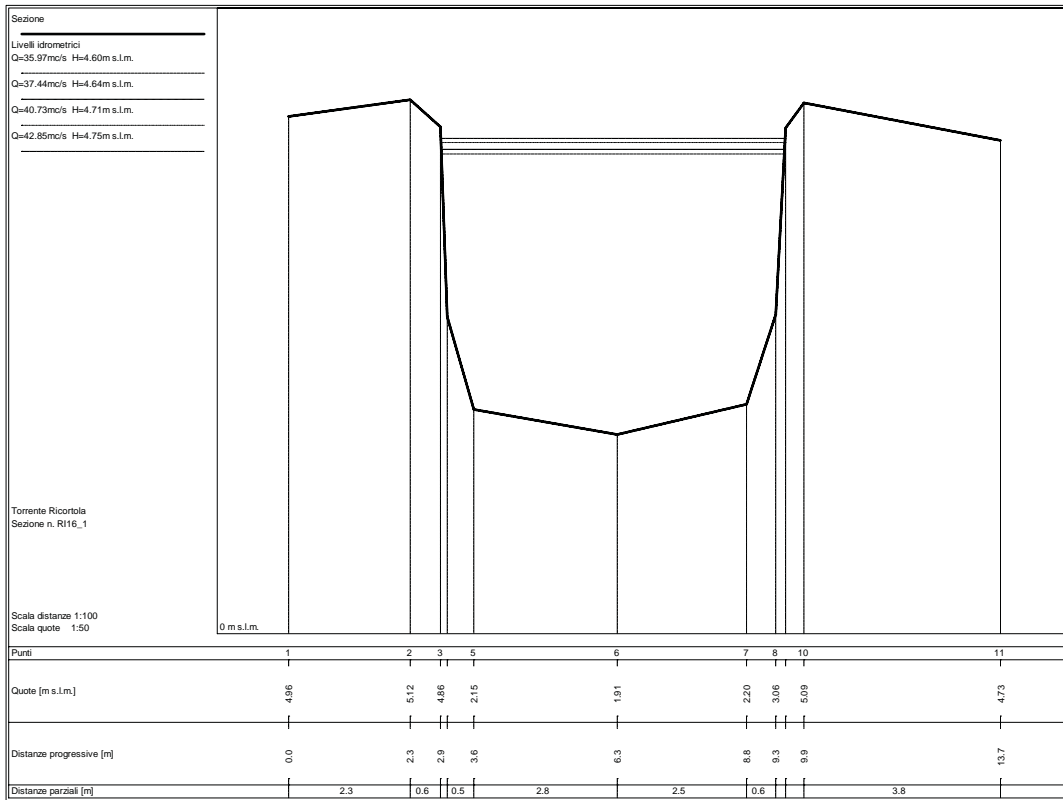

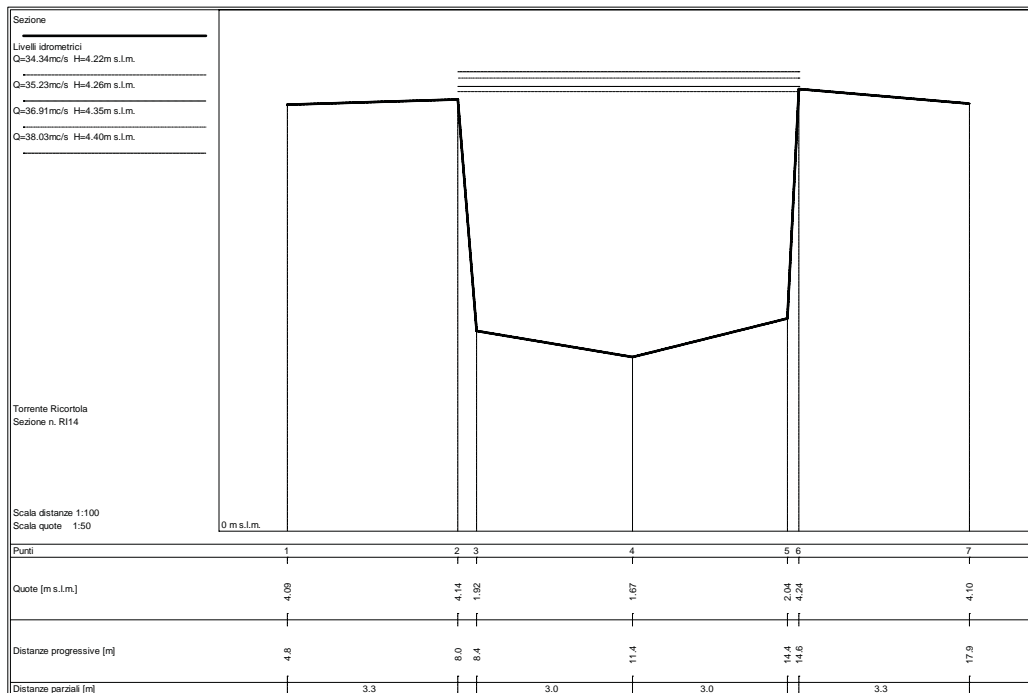
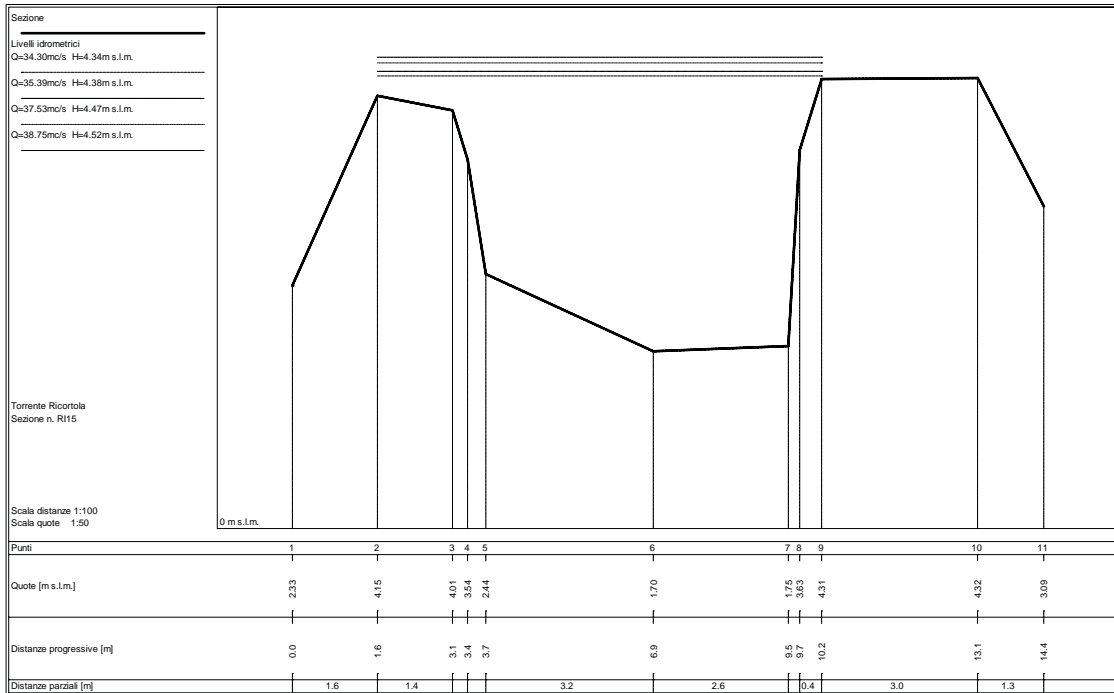

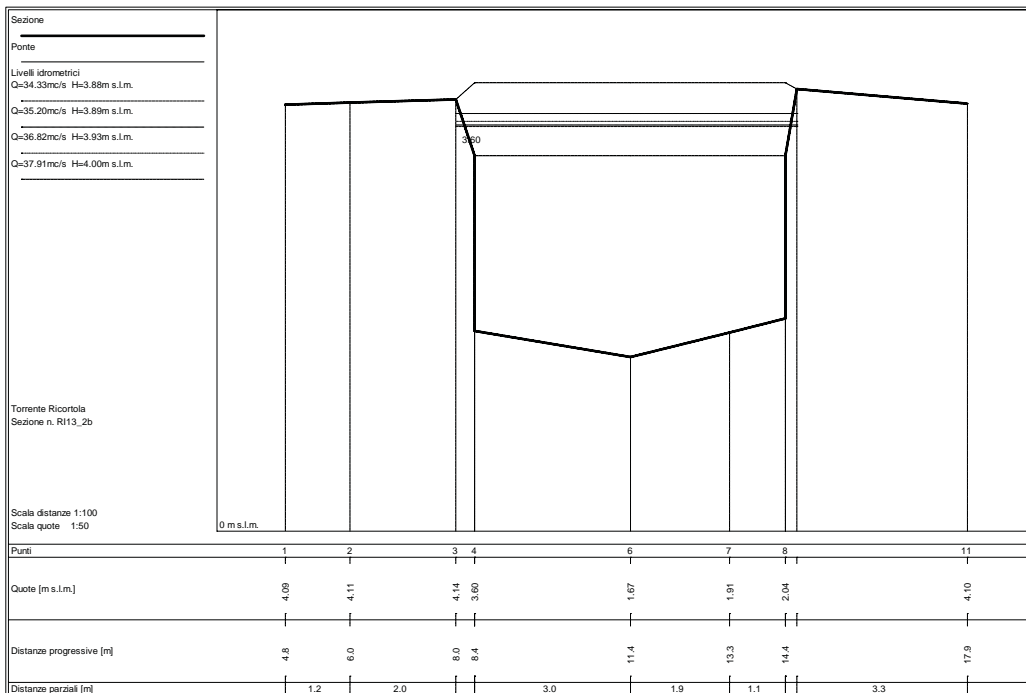
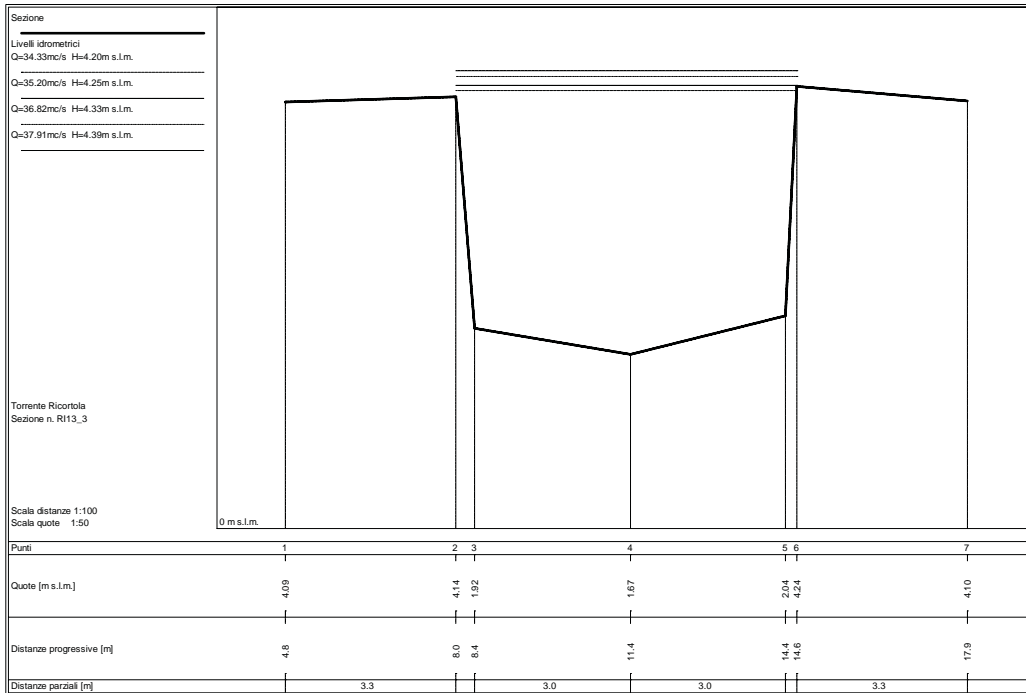

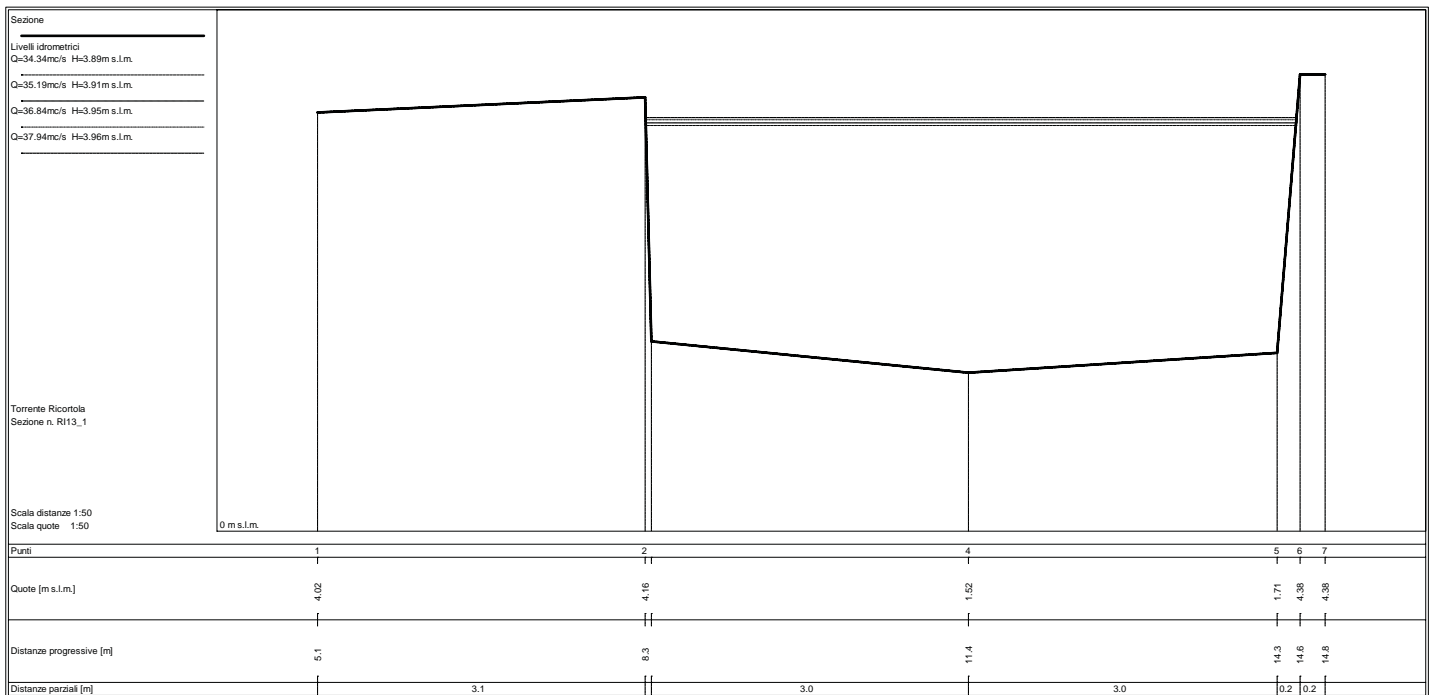
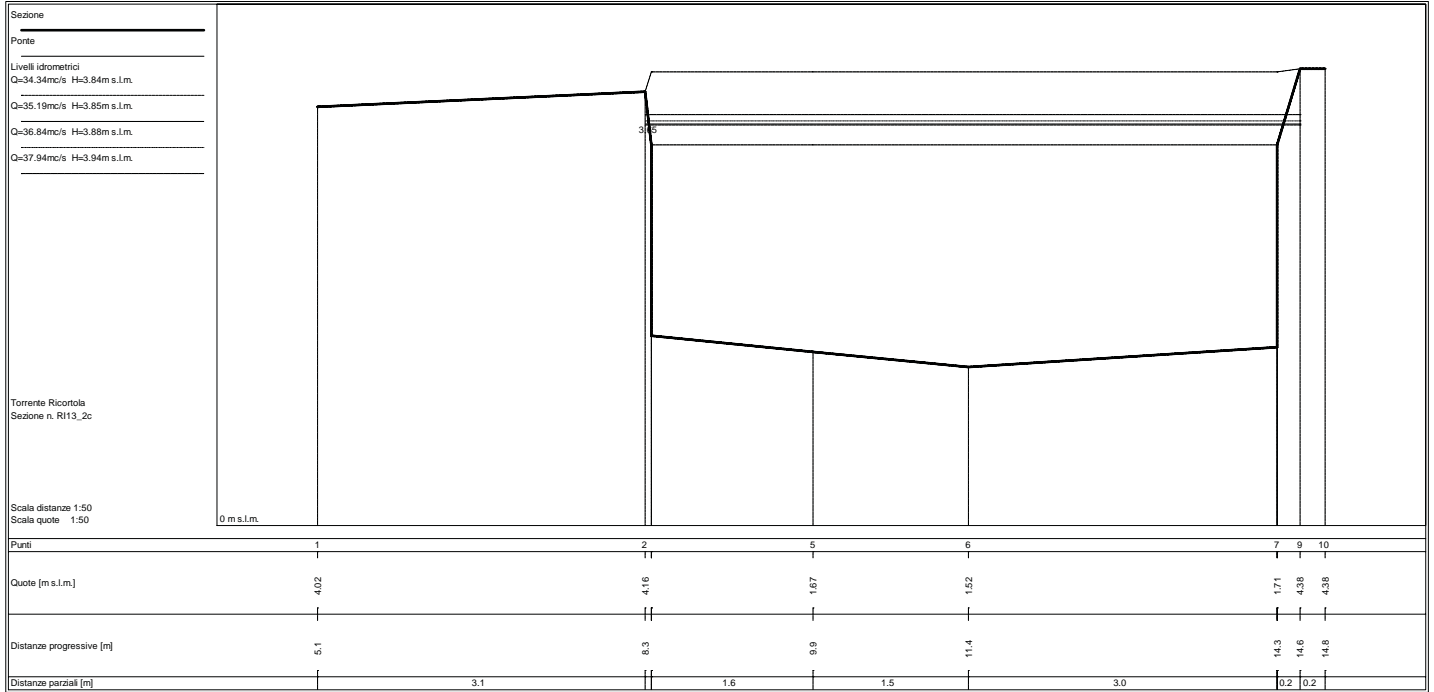

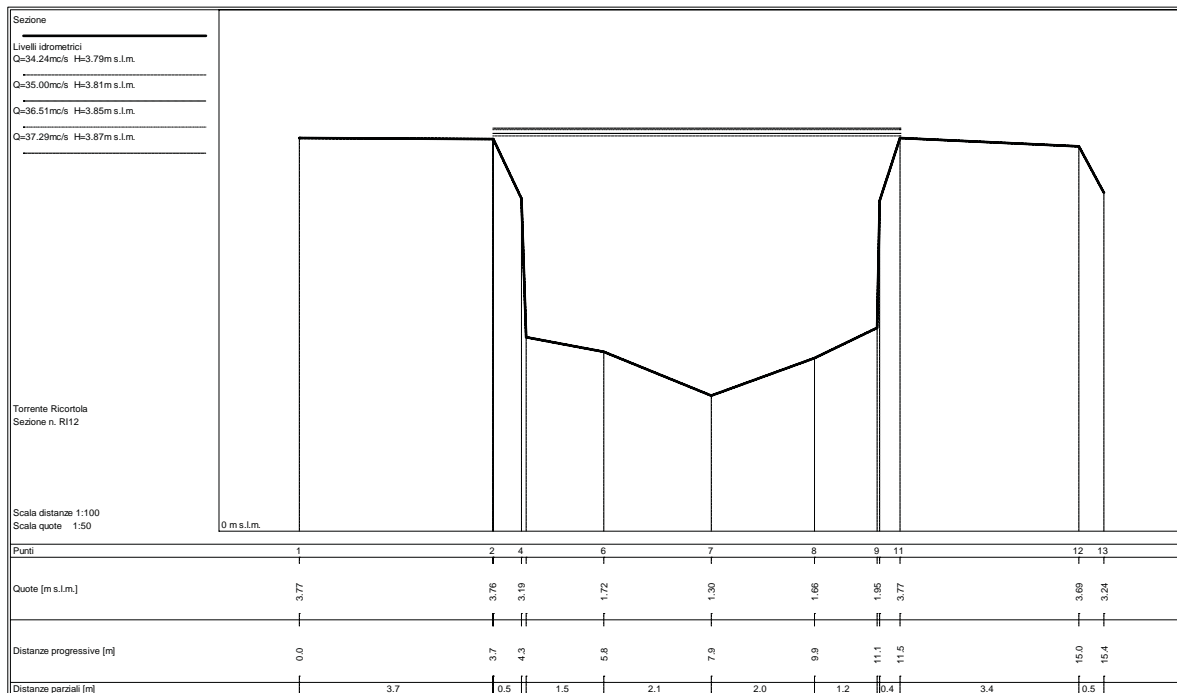
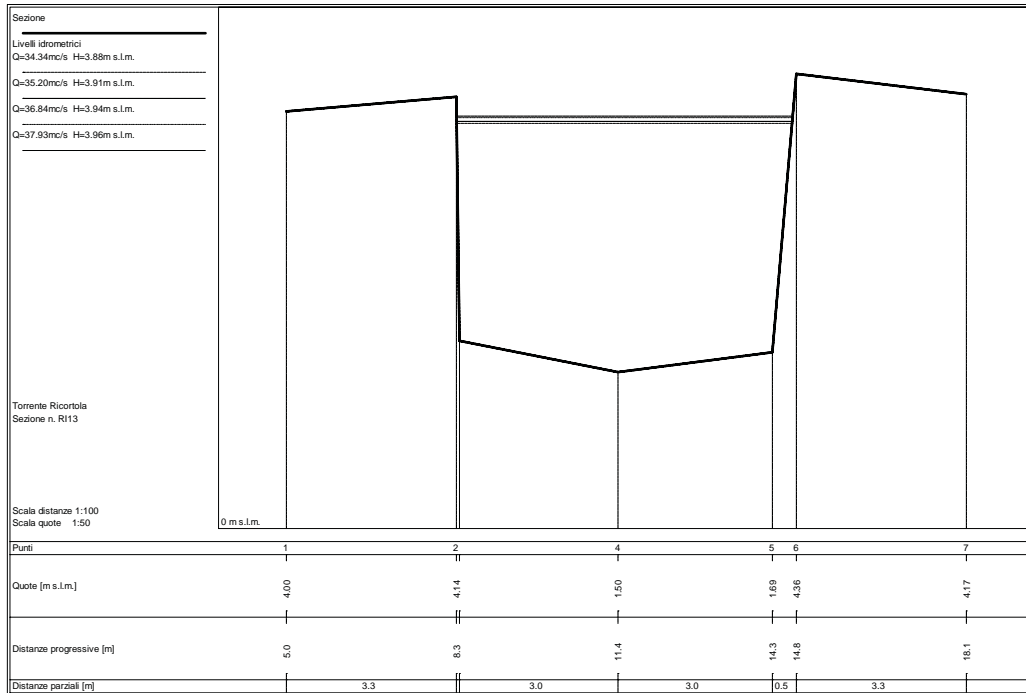

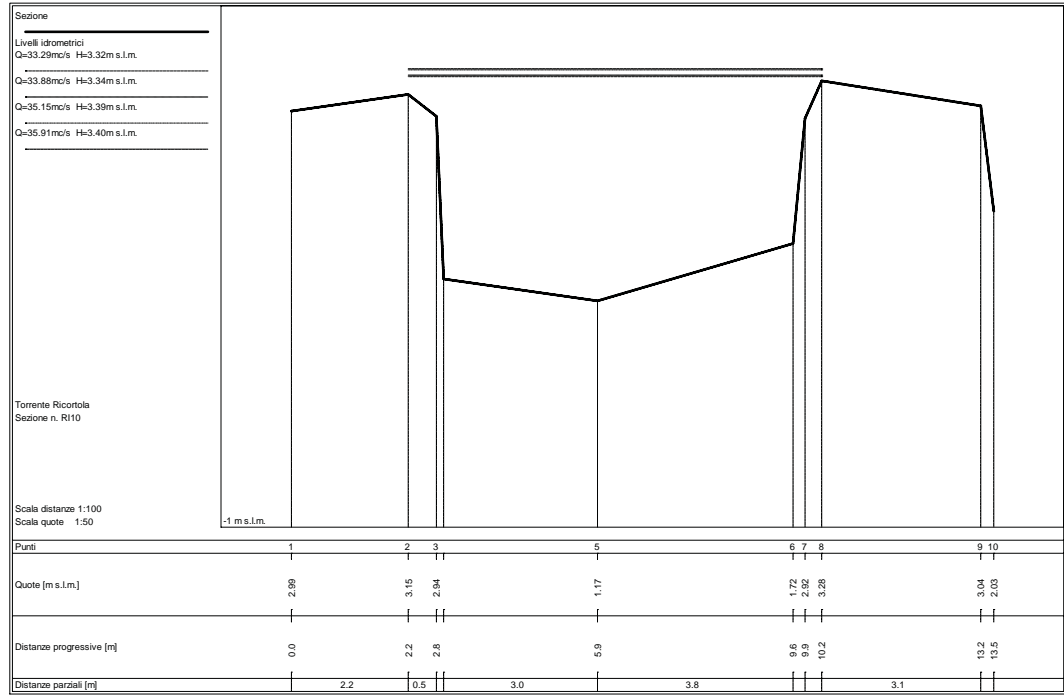
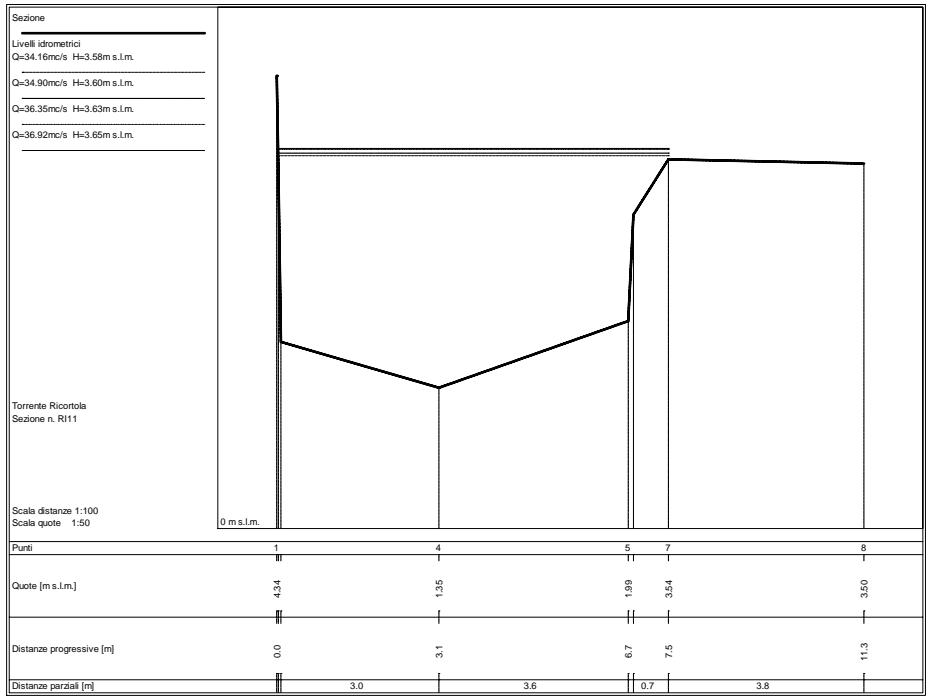

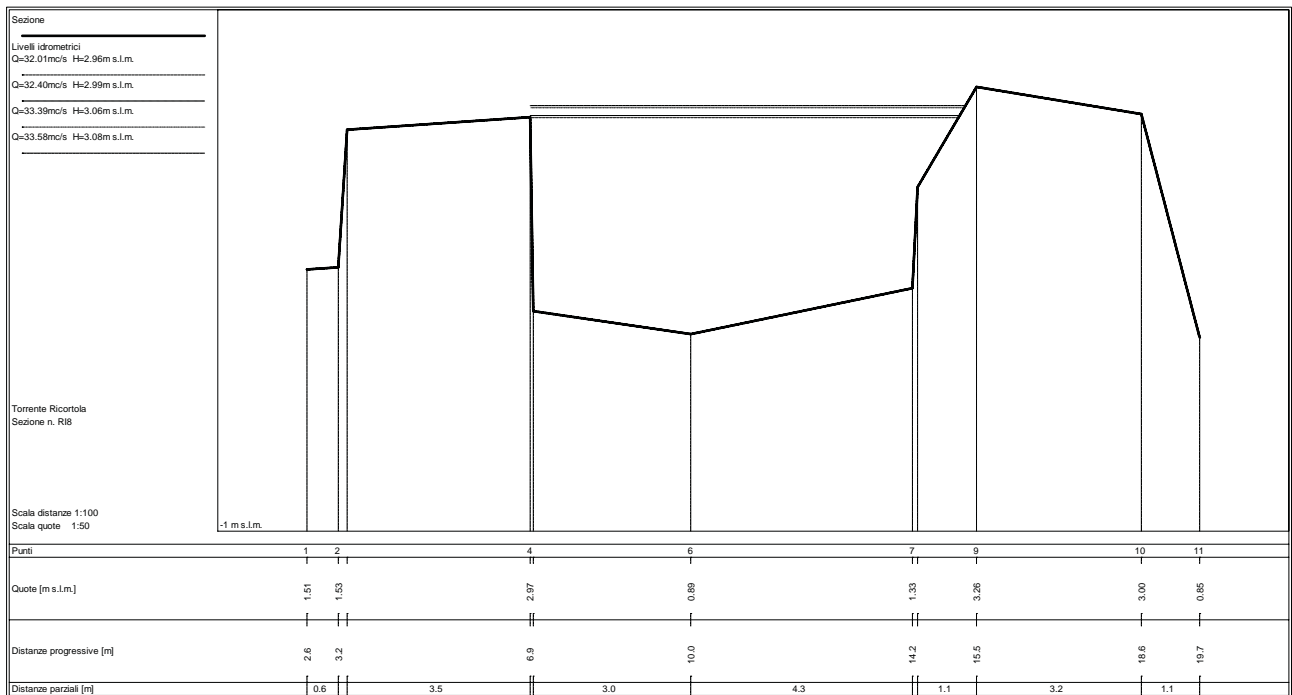
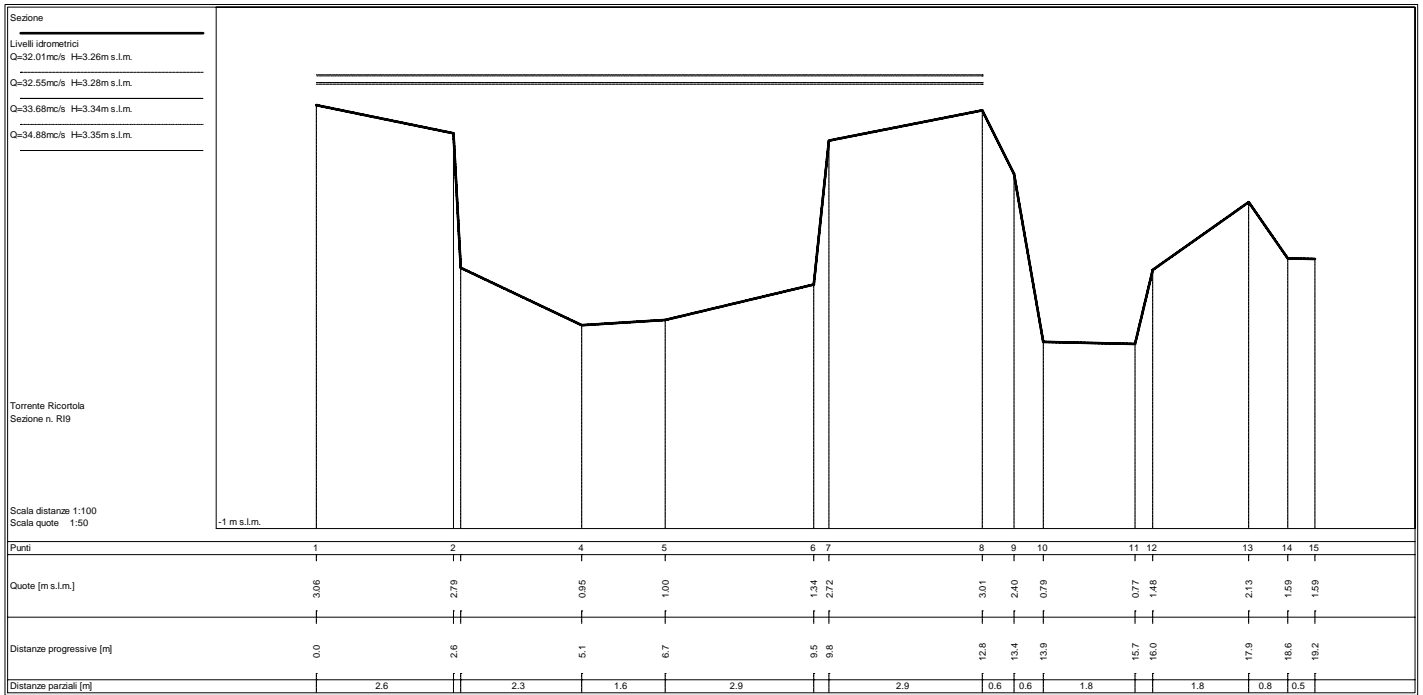

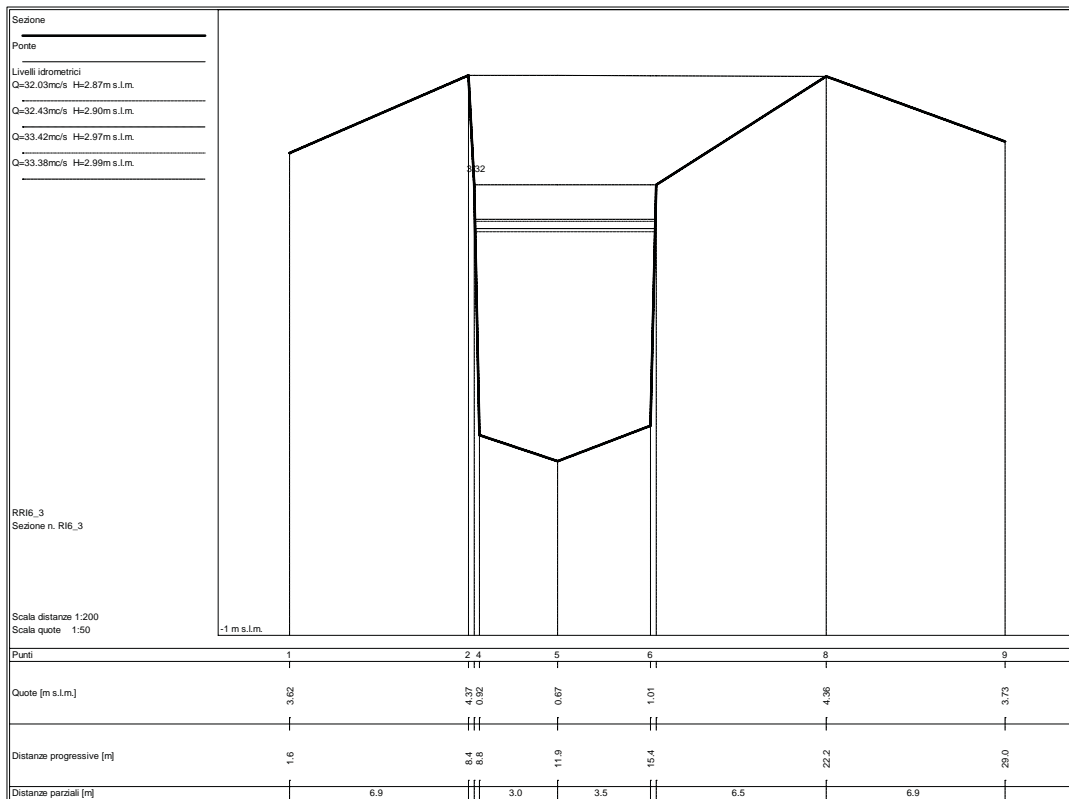
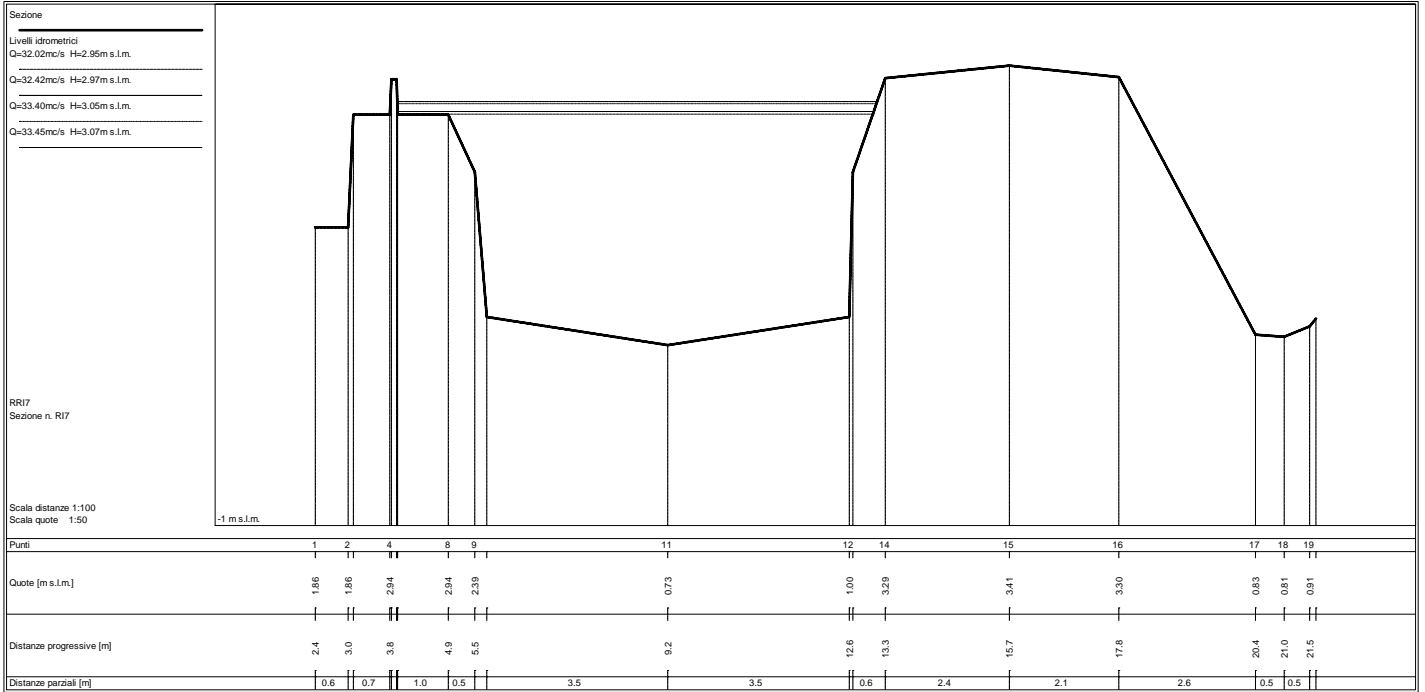

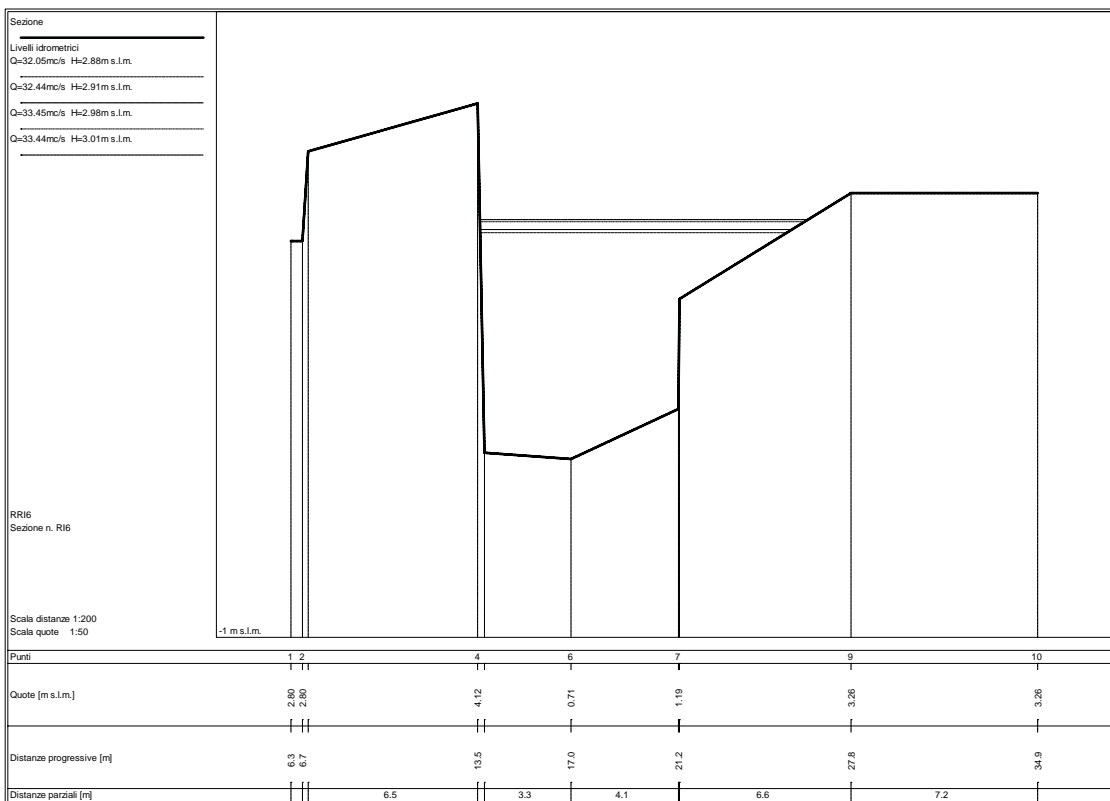
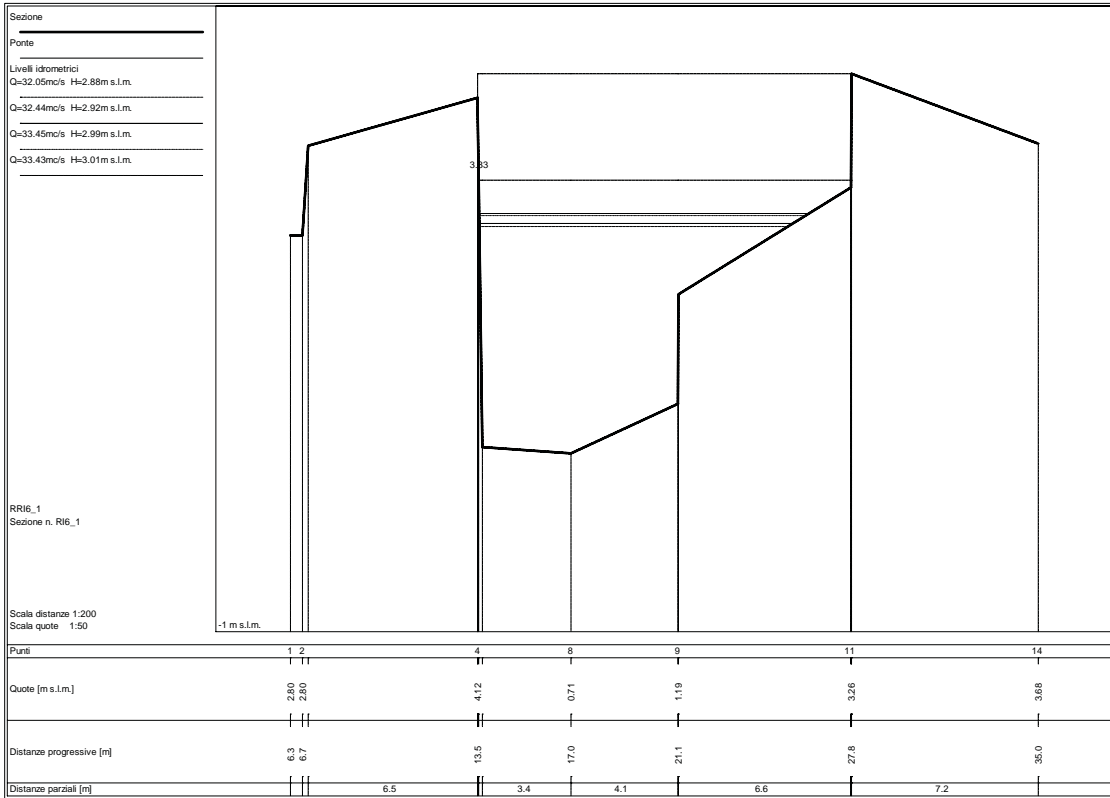

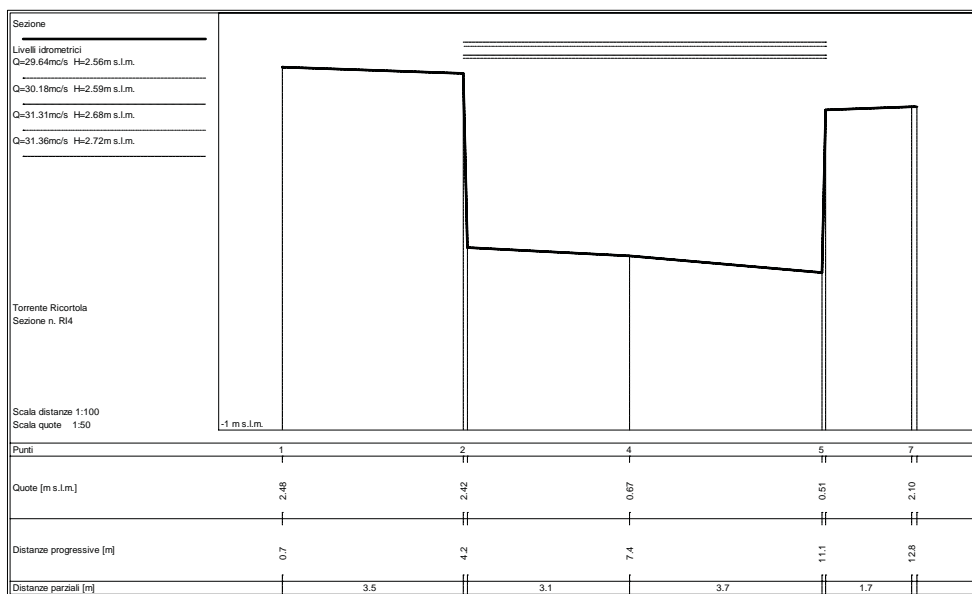
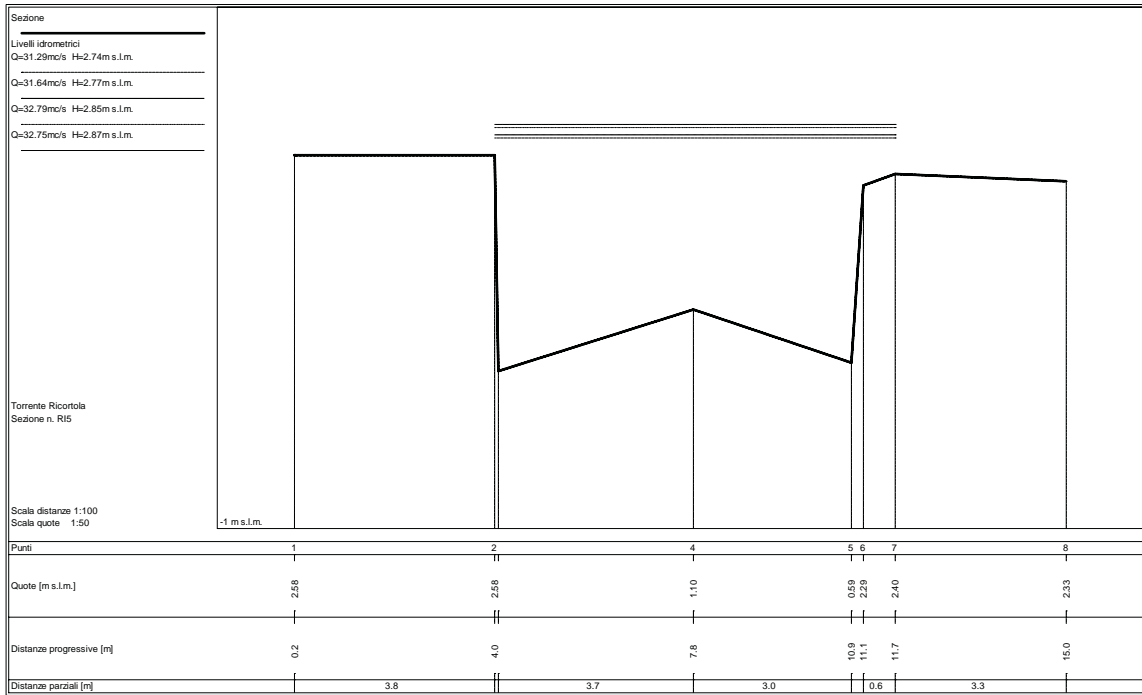

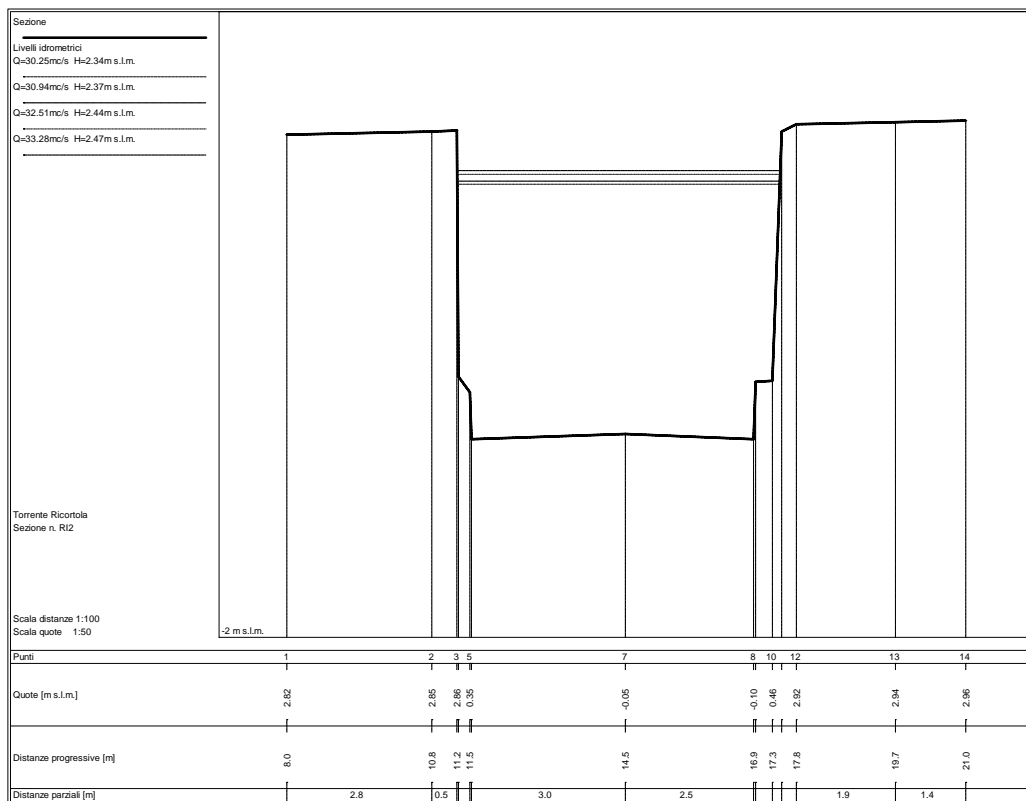
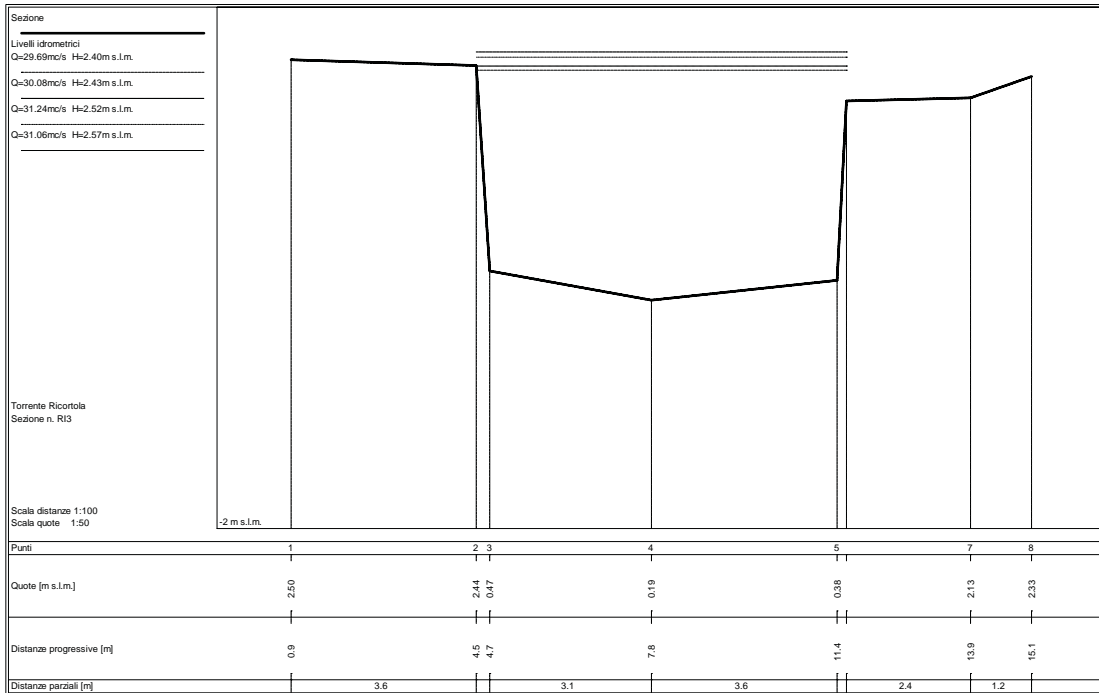

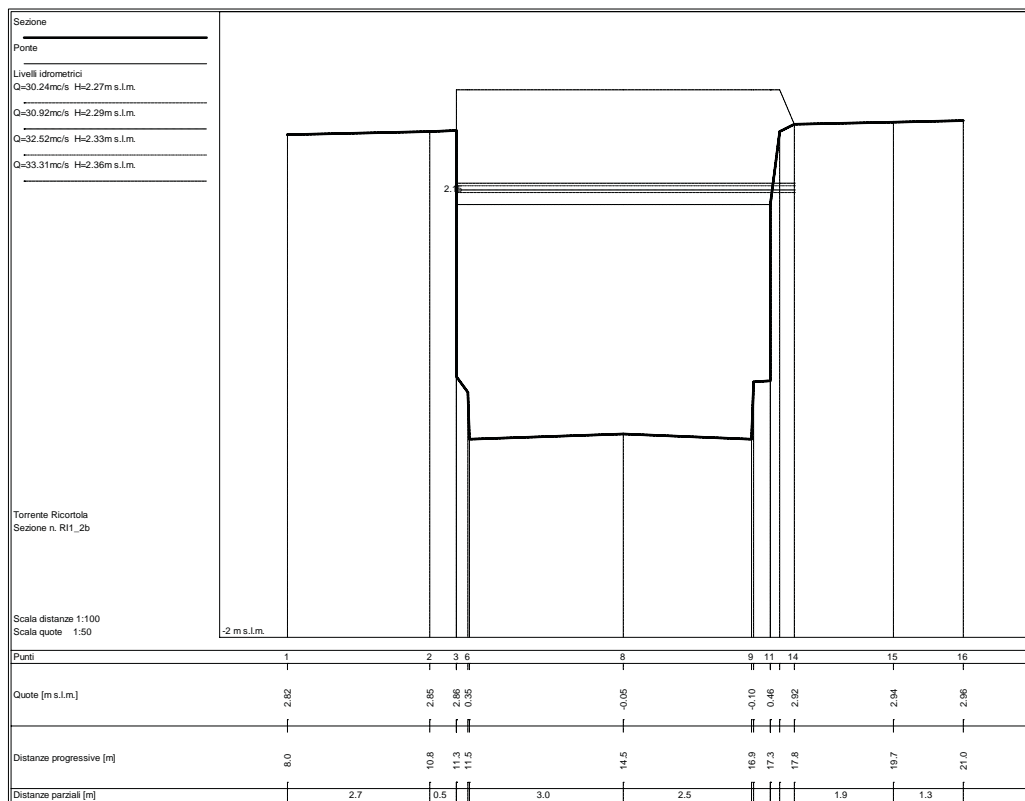
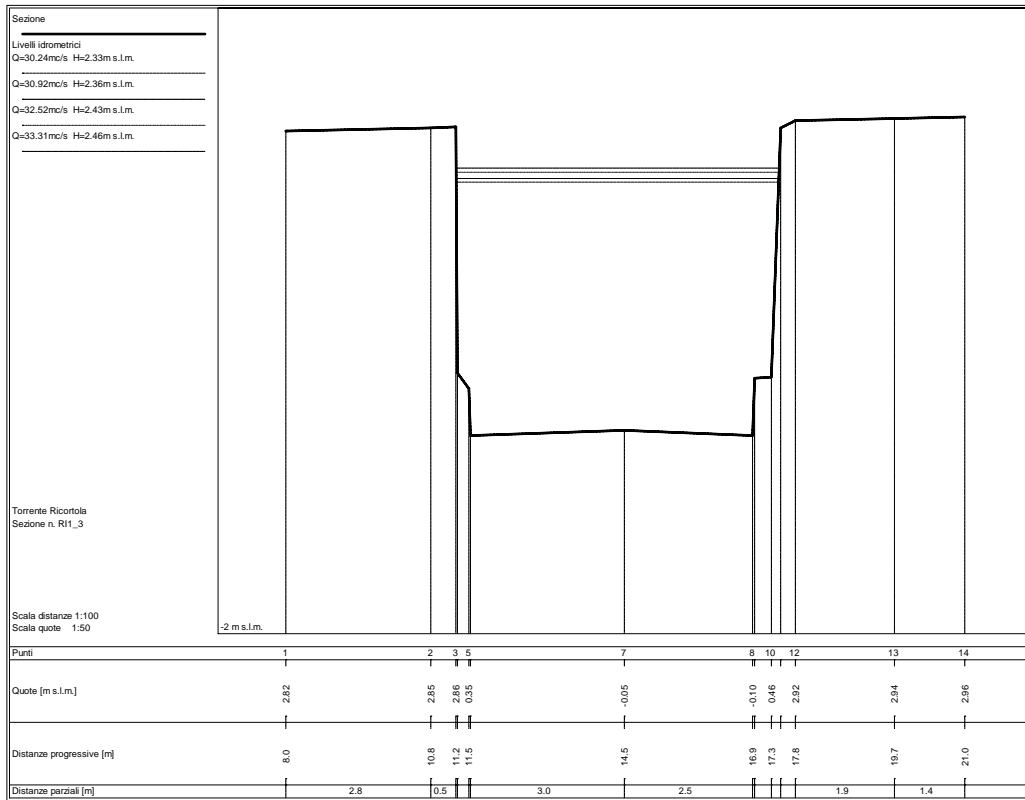

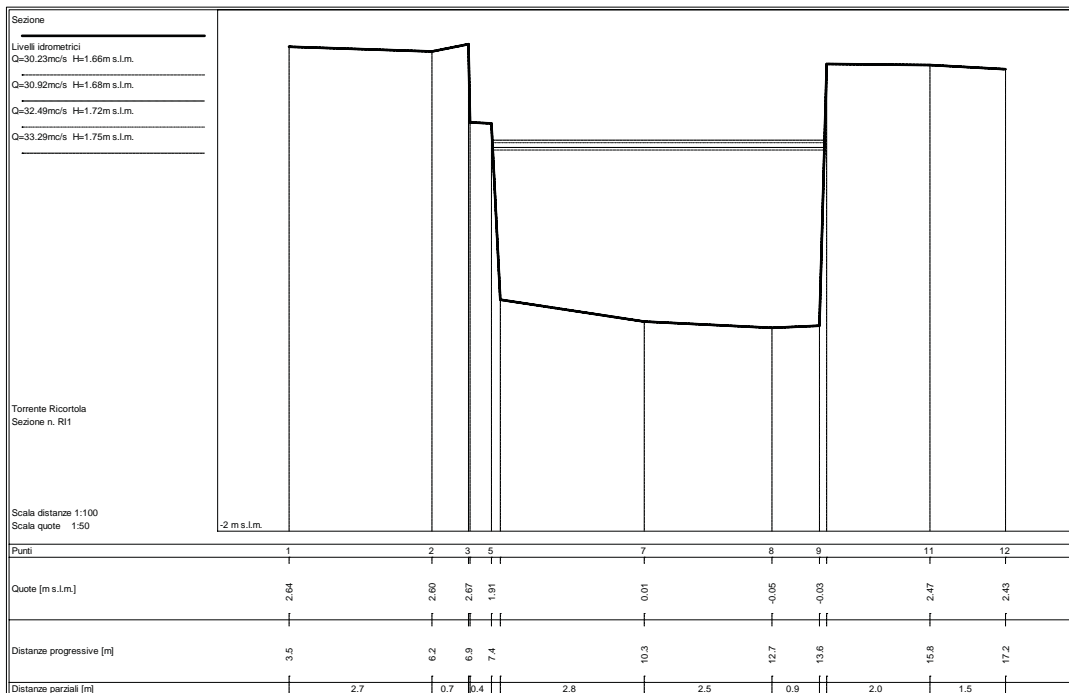
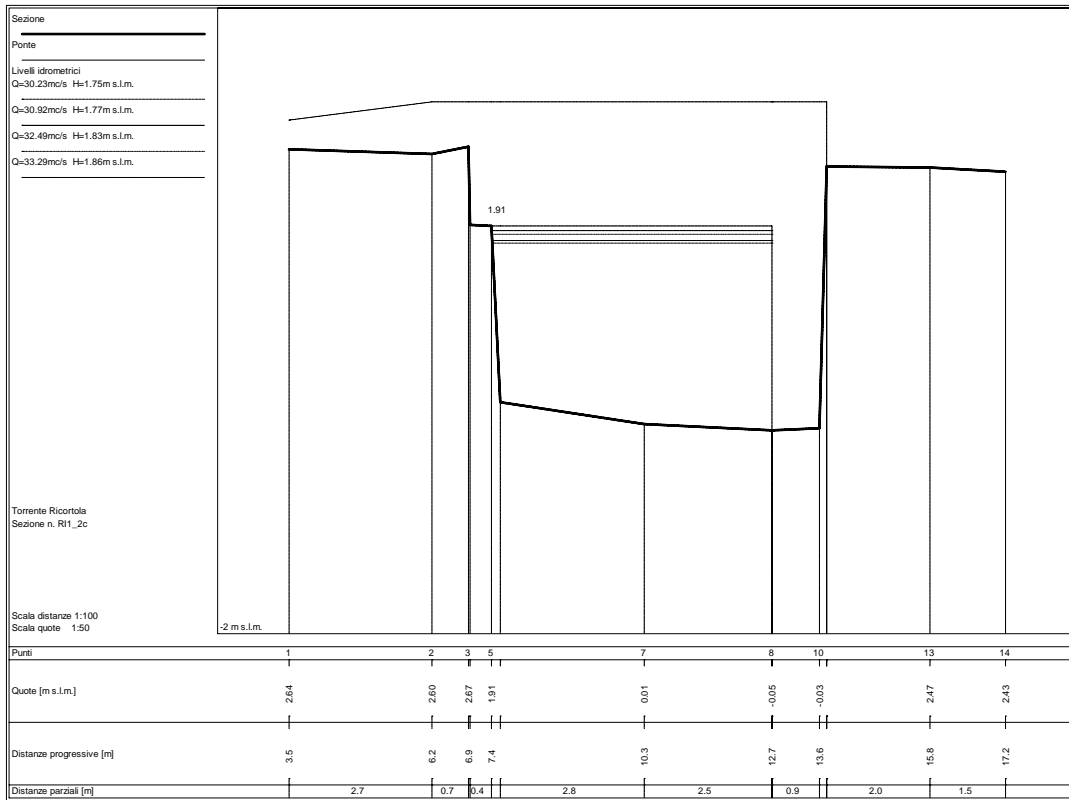

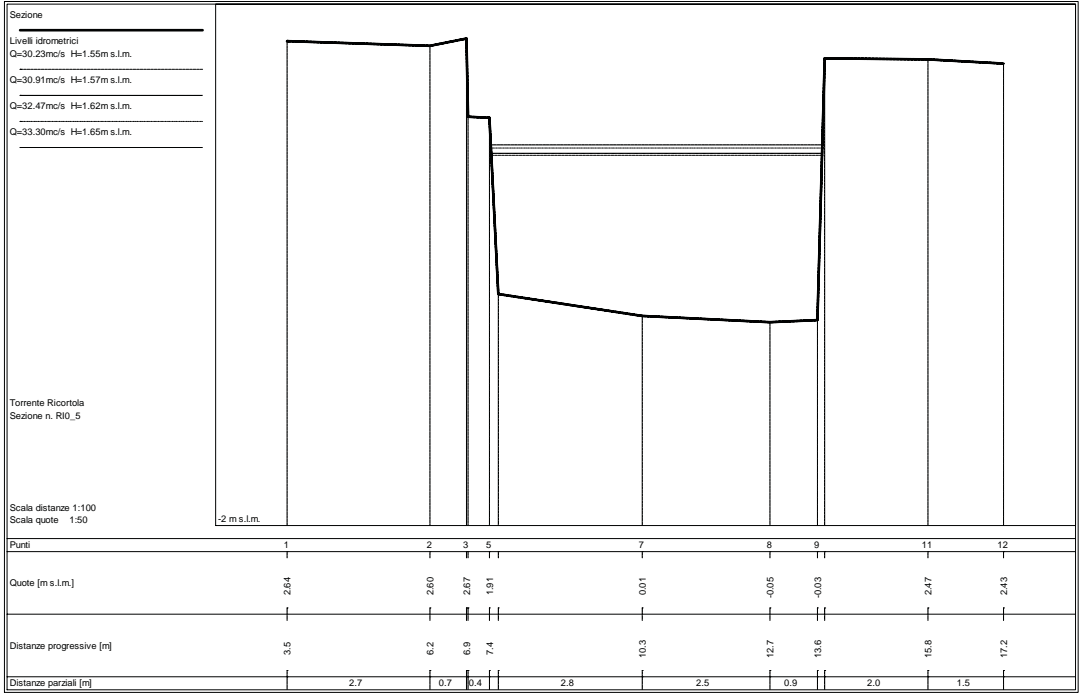

STATO ATTUALE

Sezioni fluviali fosso Pernice – Pernice_01

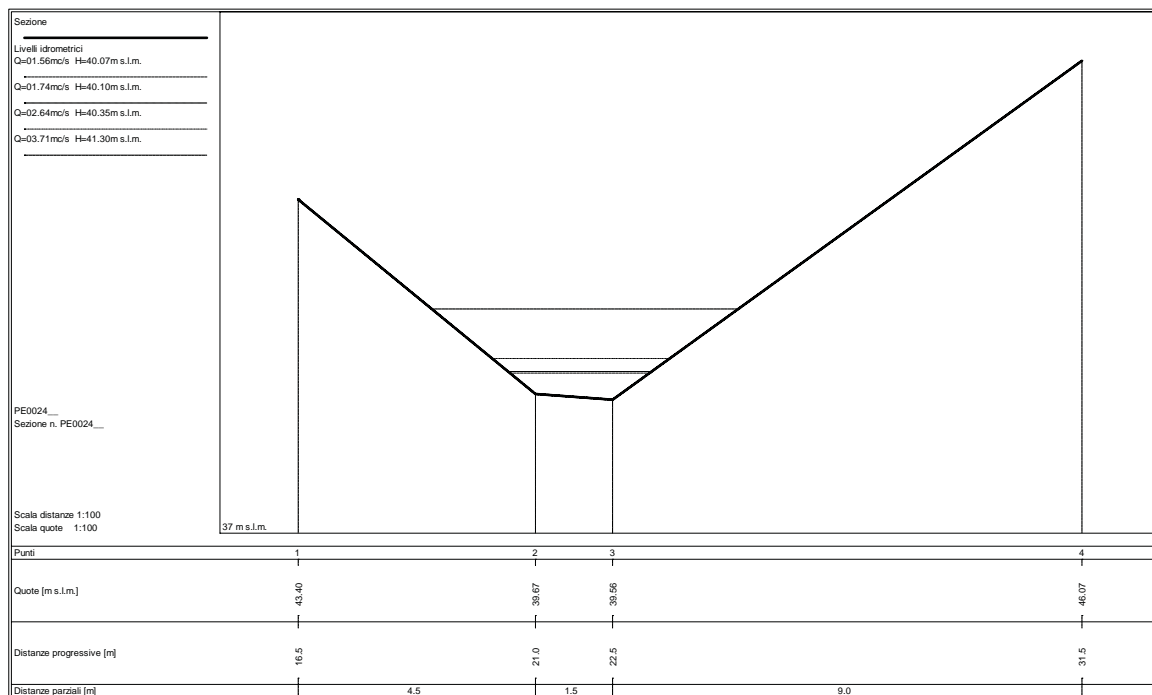
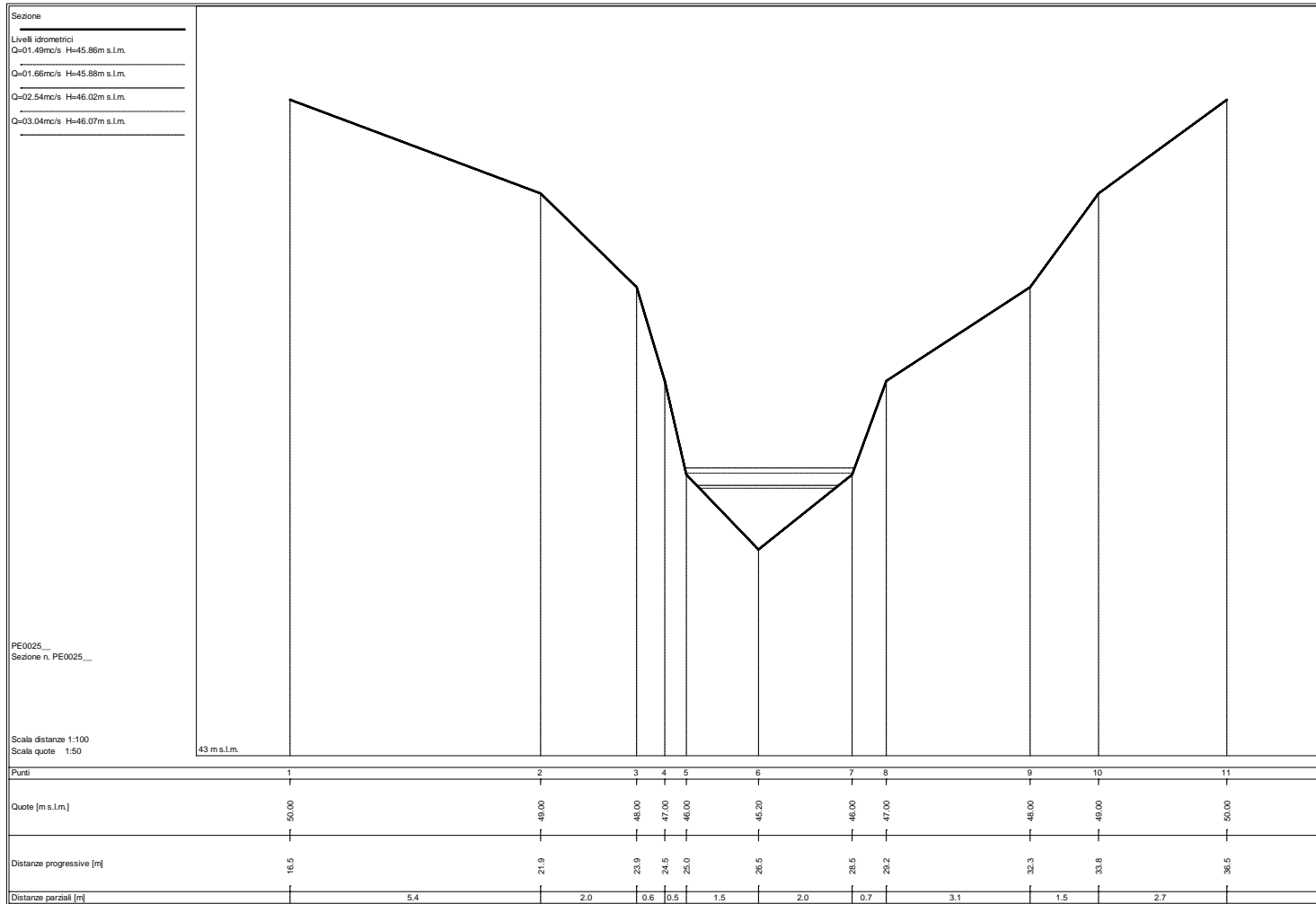

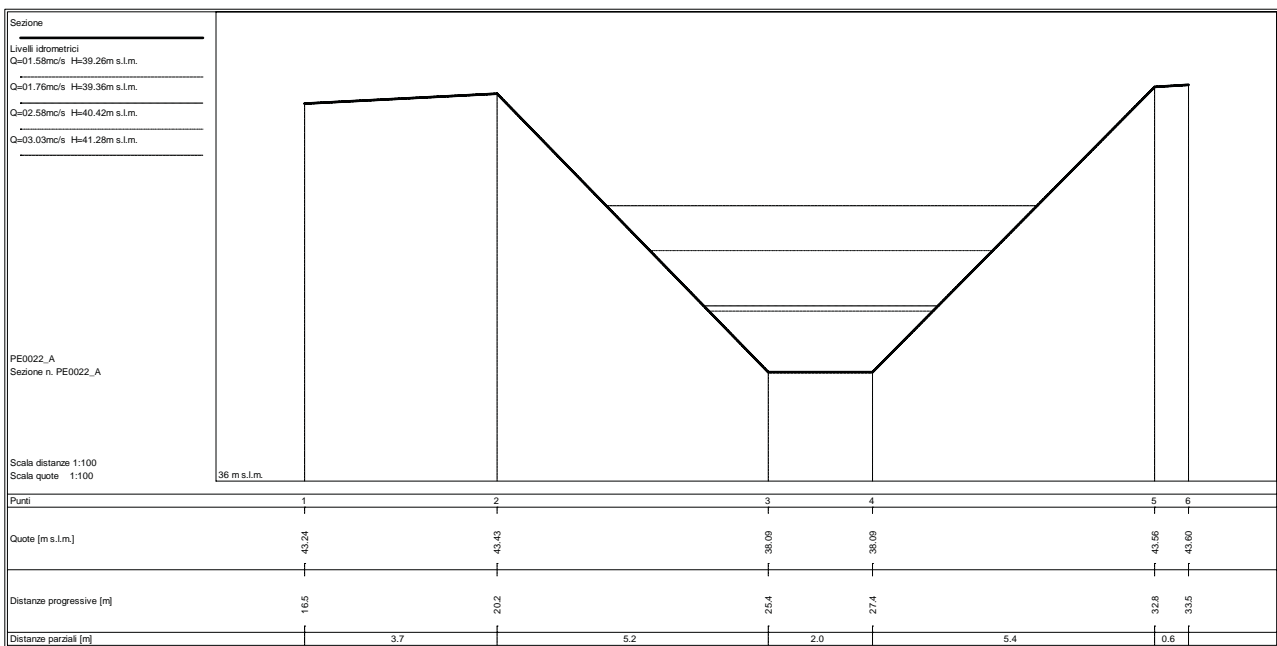
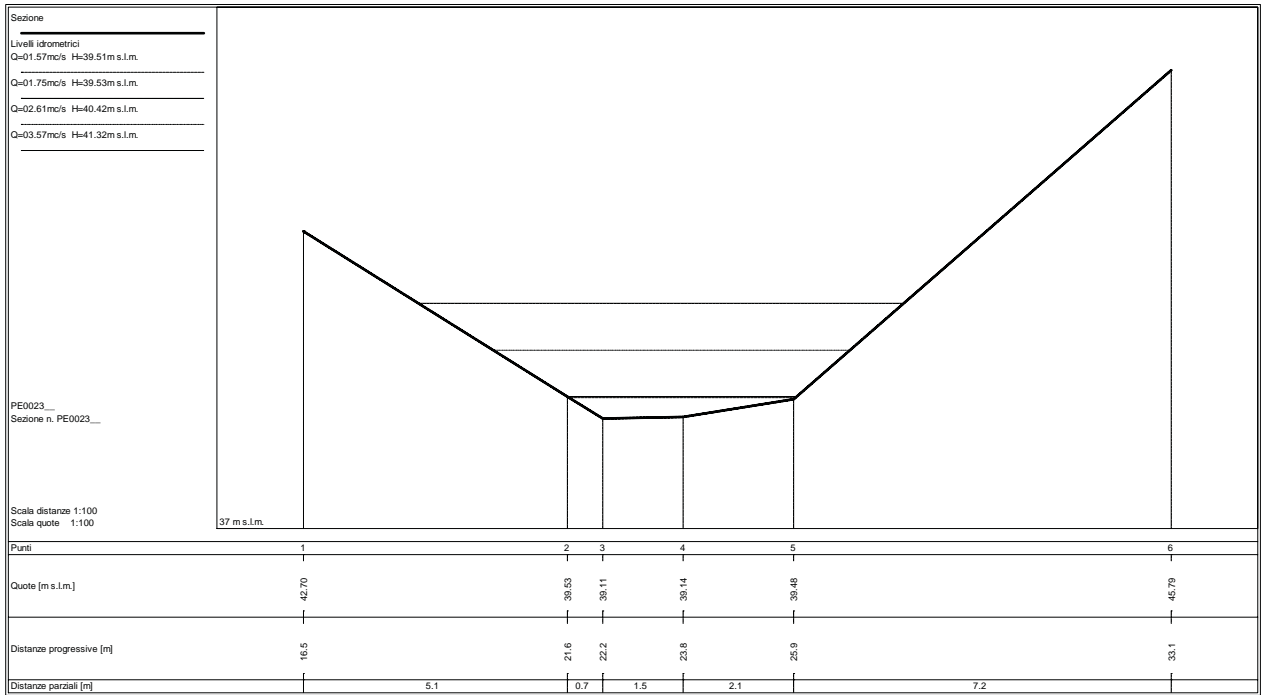

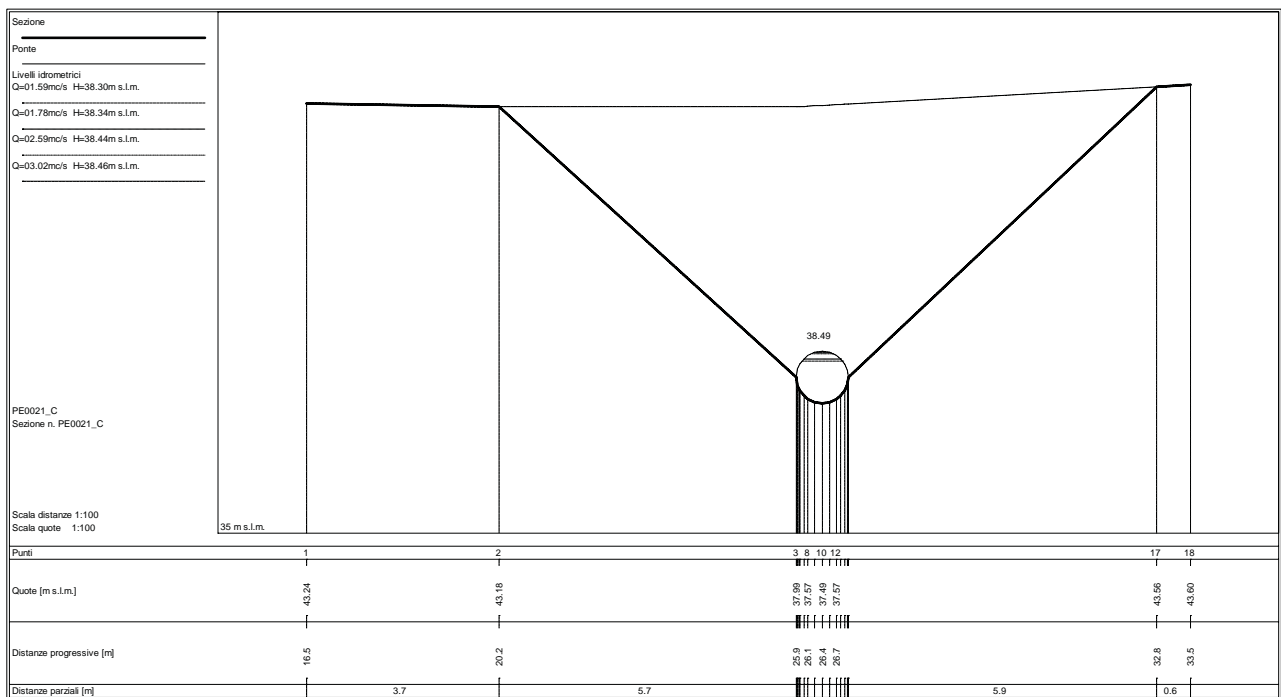
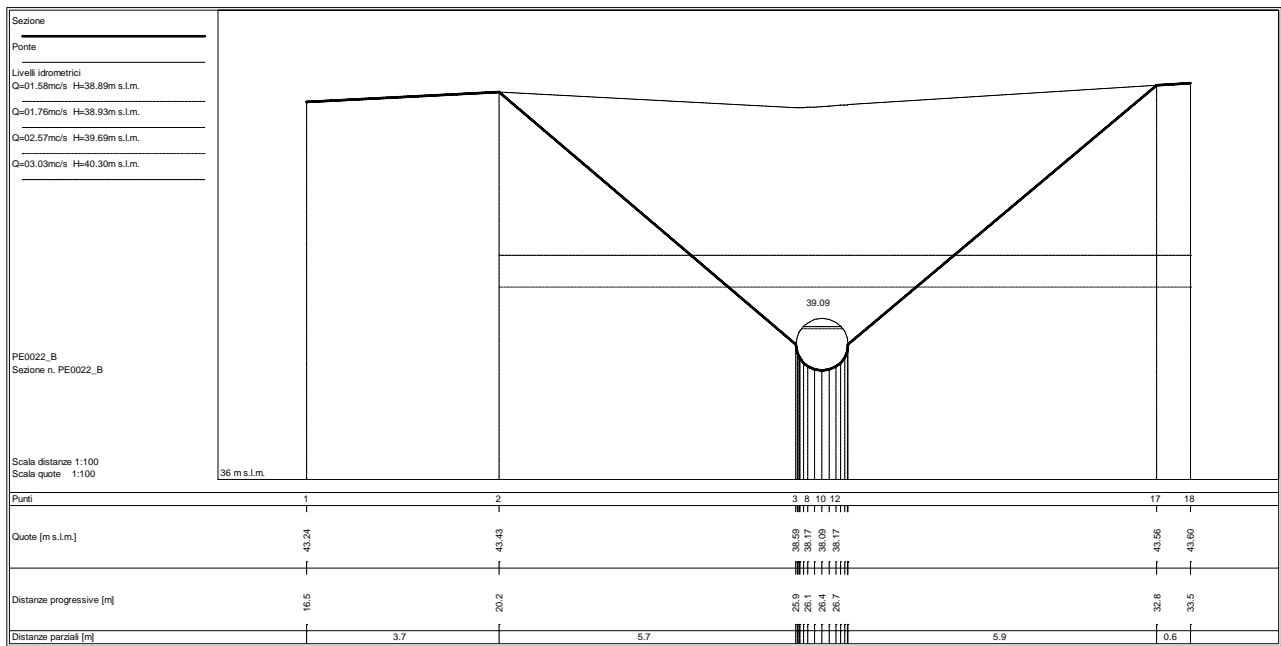

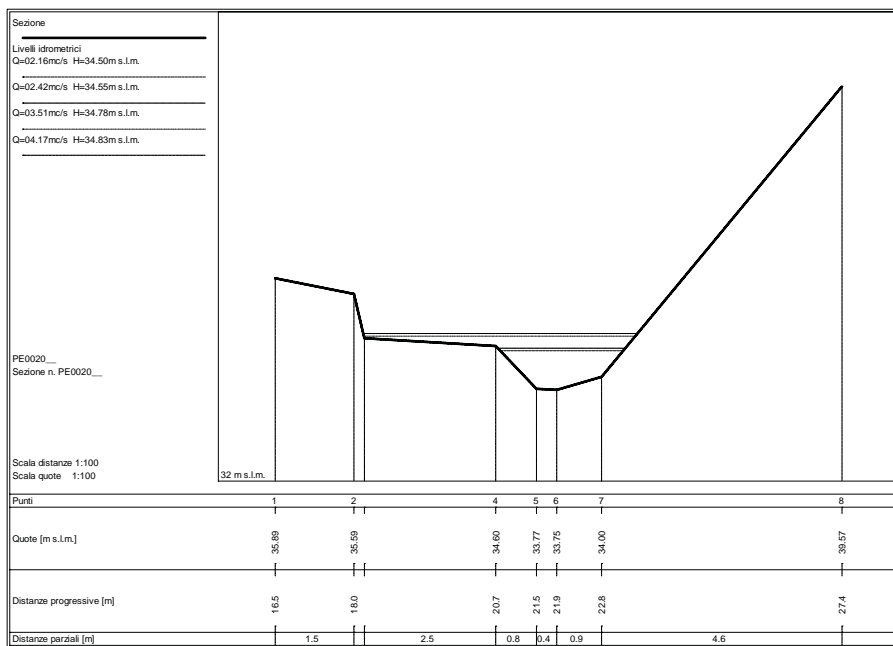
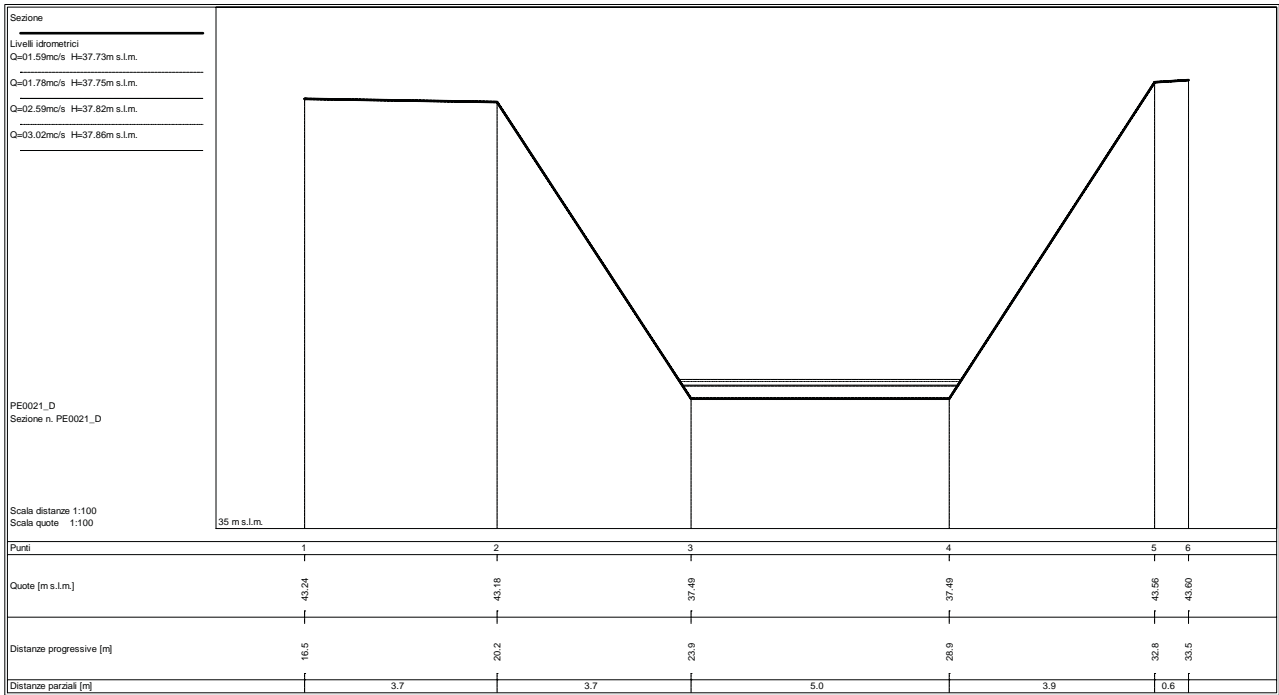

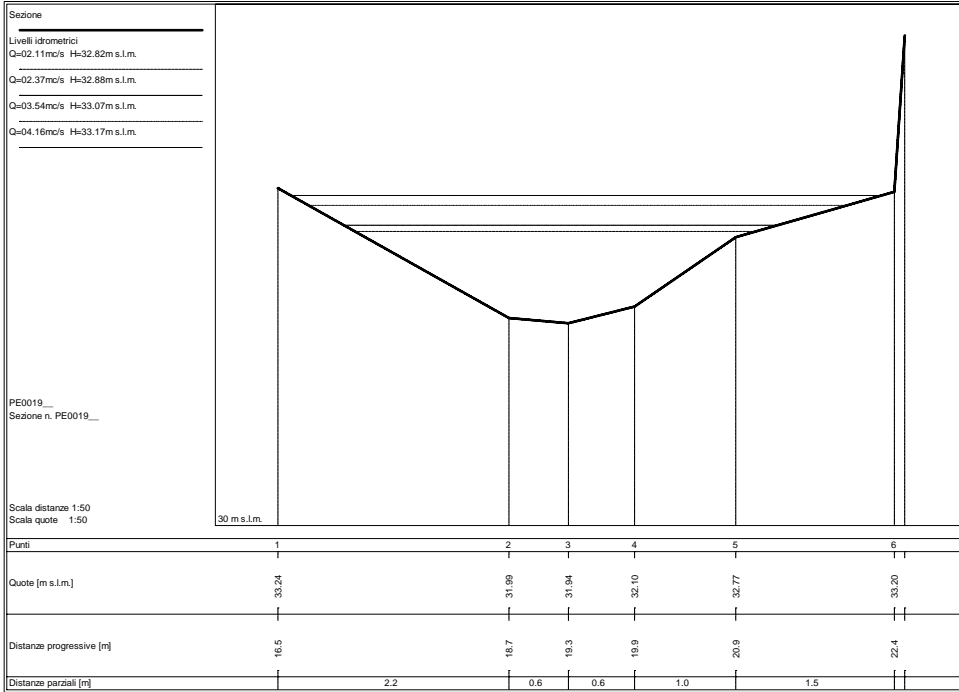

STATO ATTUALE

Sezioni fluviali fosso Pernice – Pernice_02

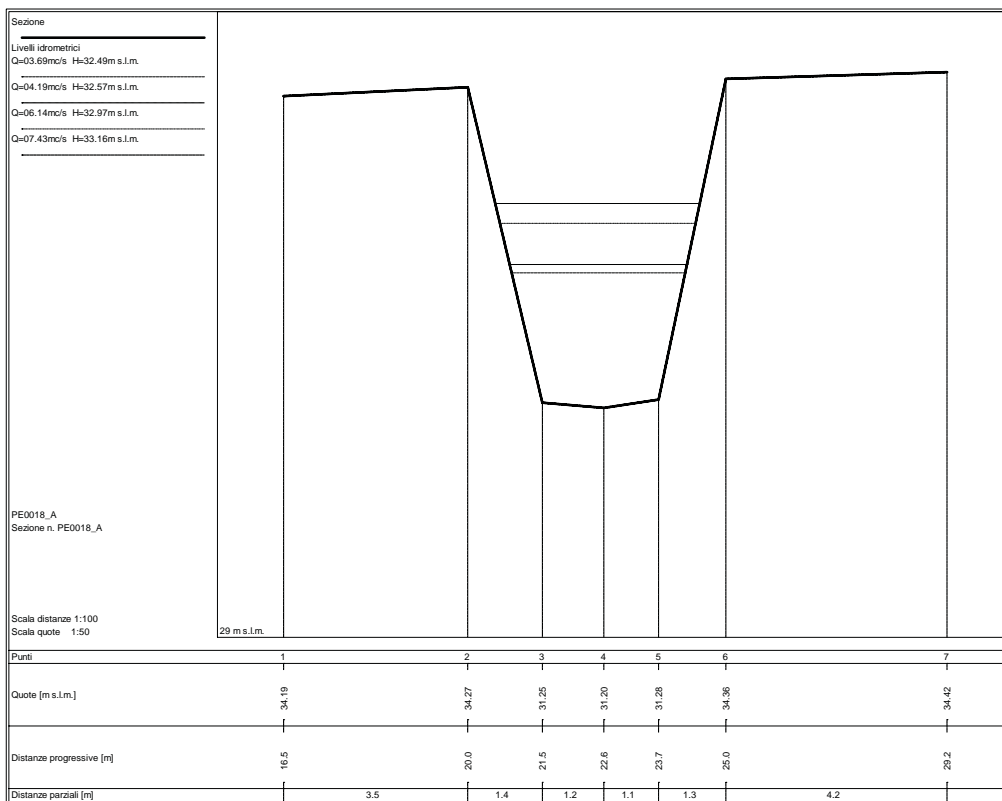
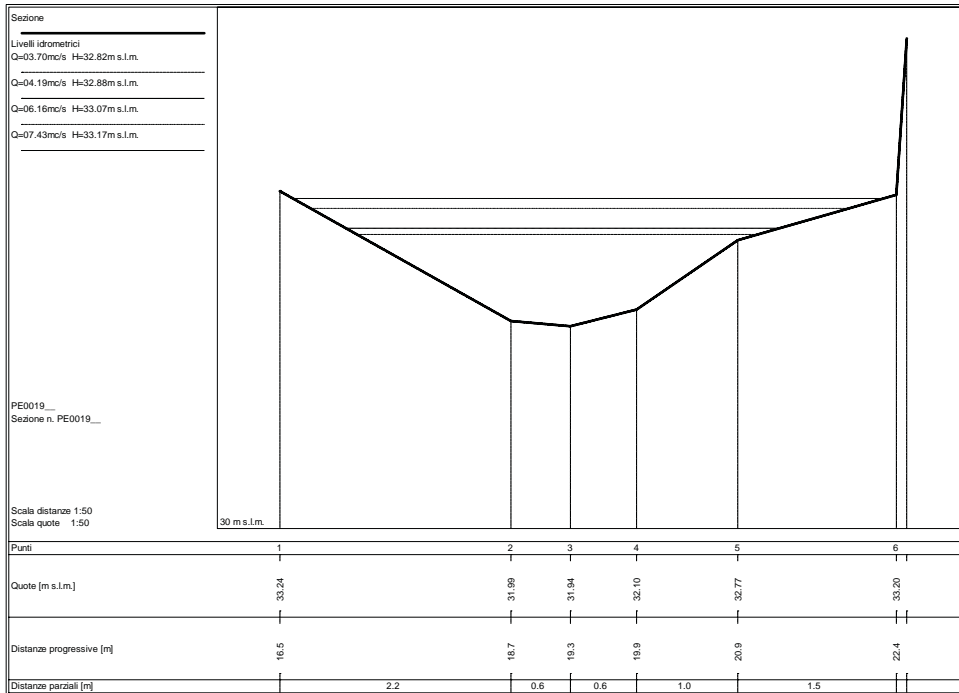

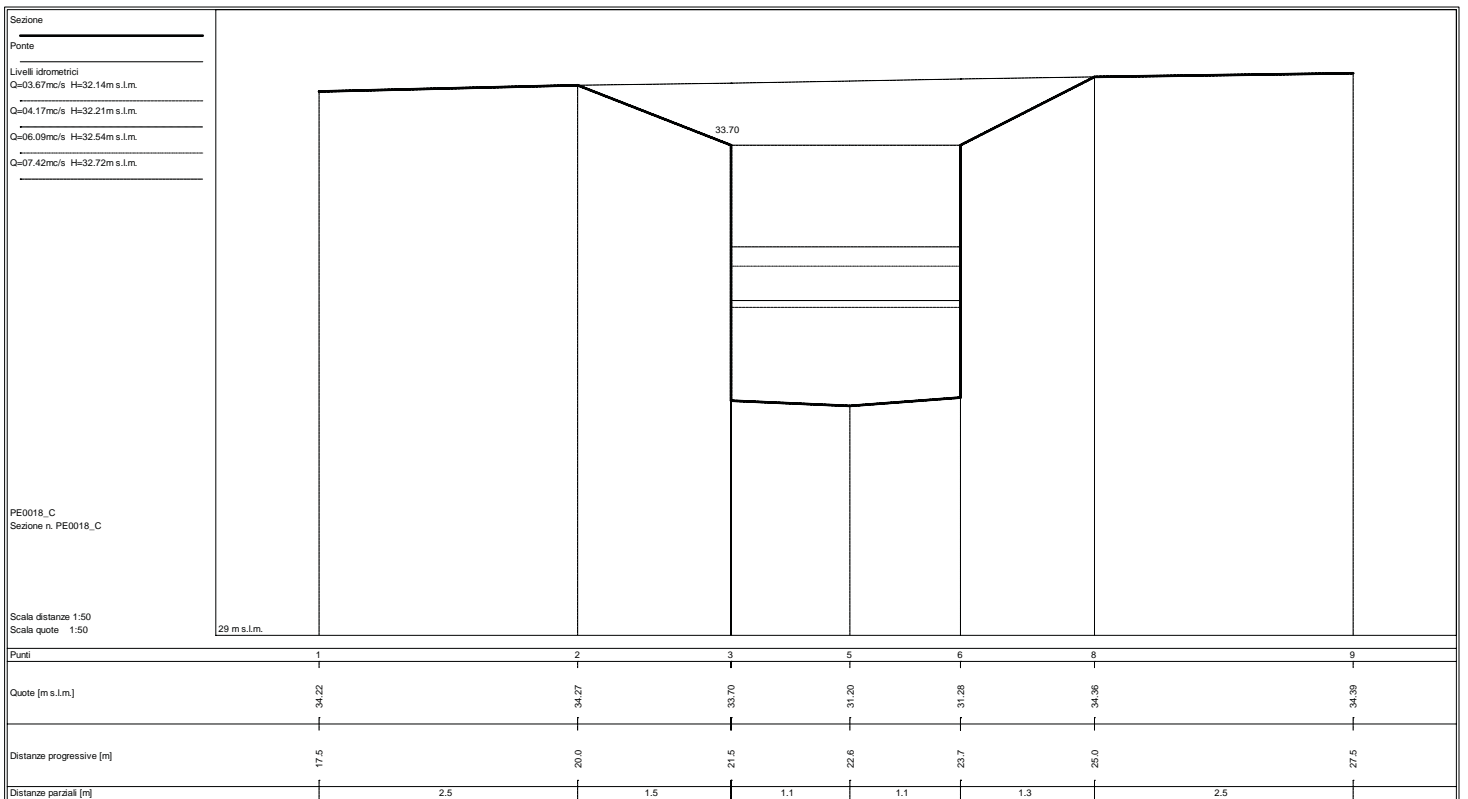
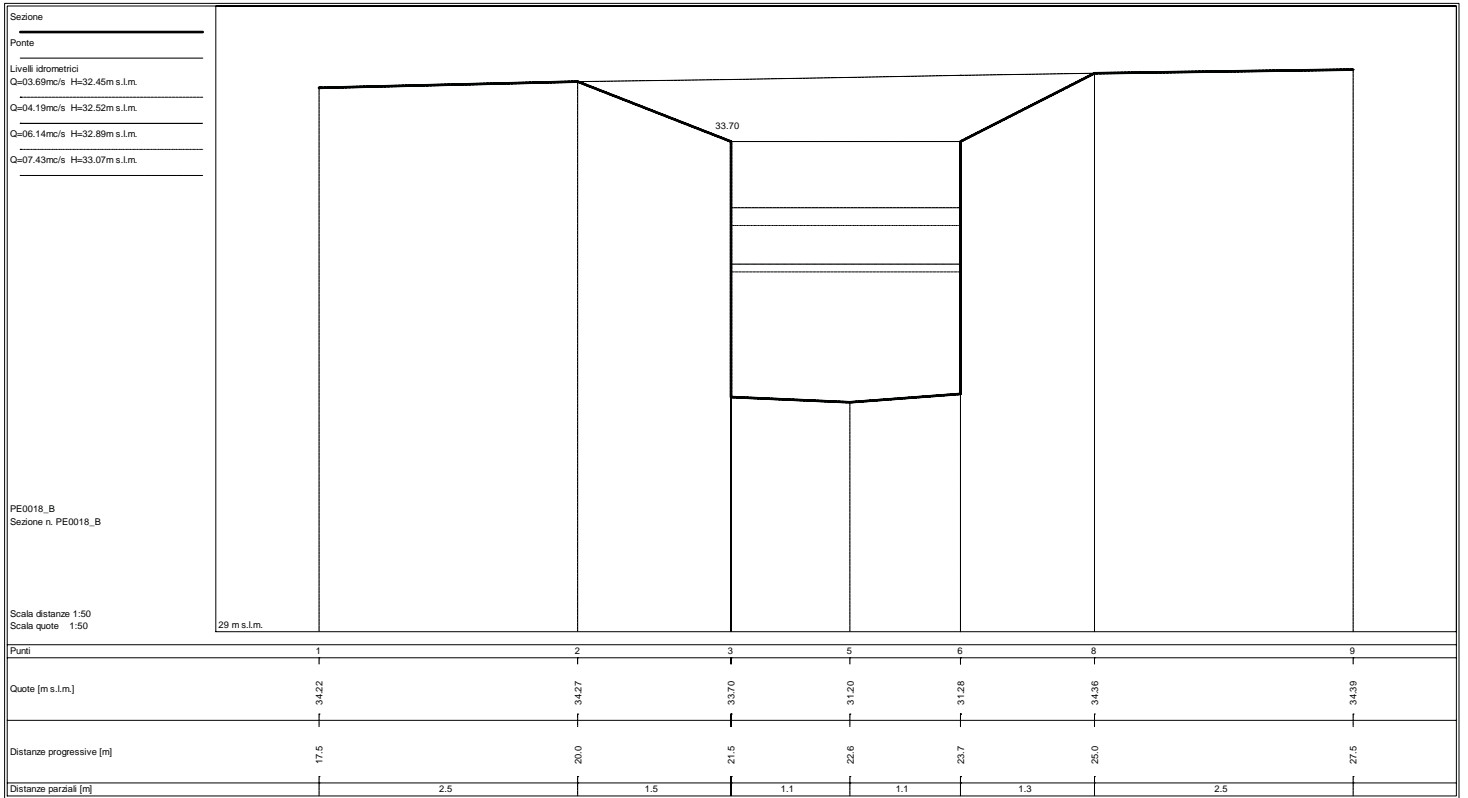

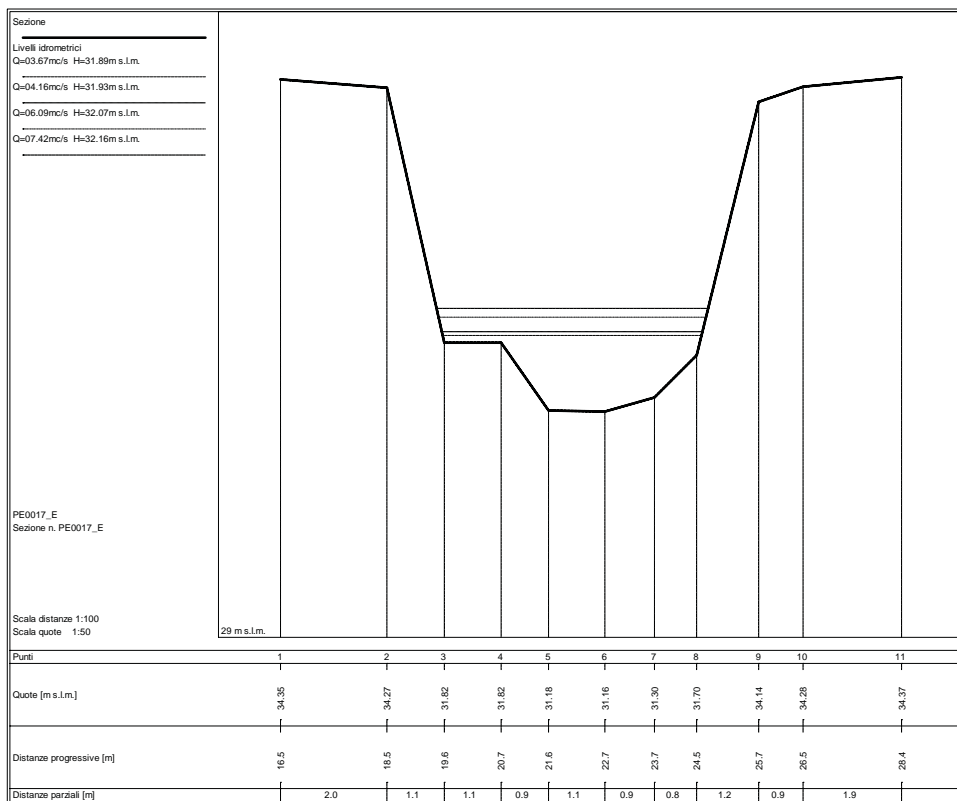
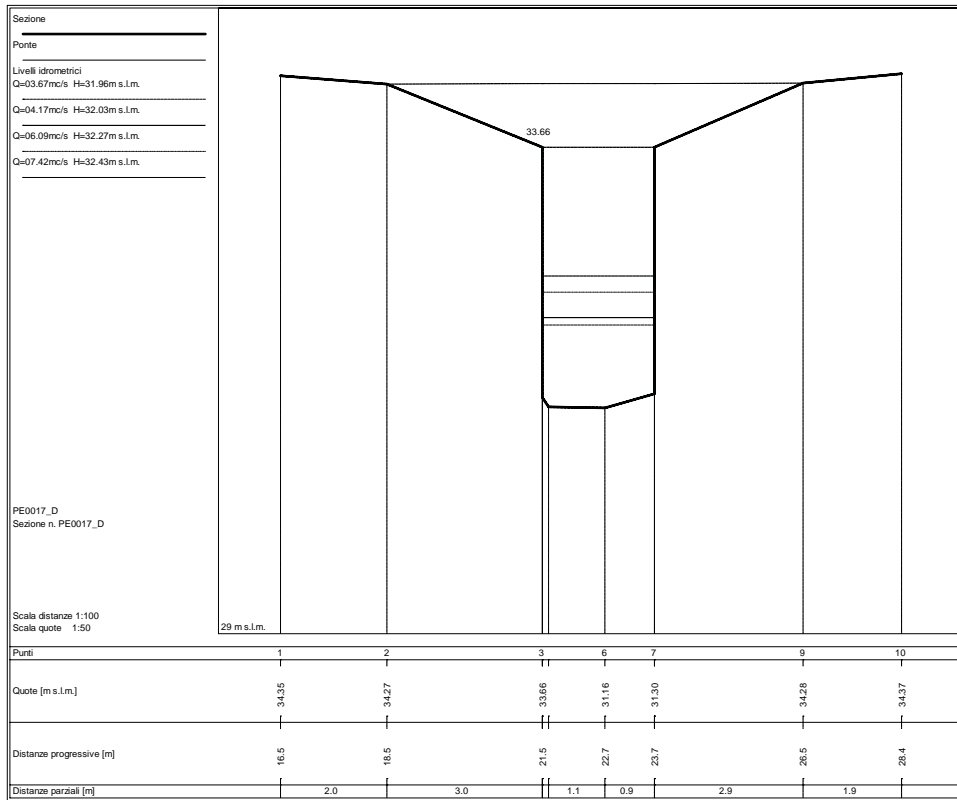

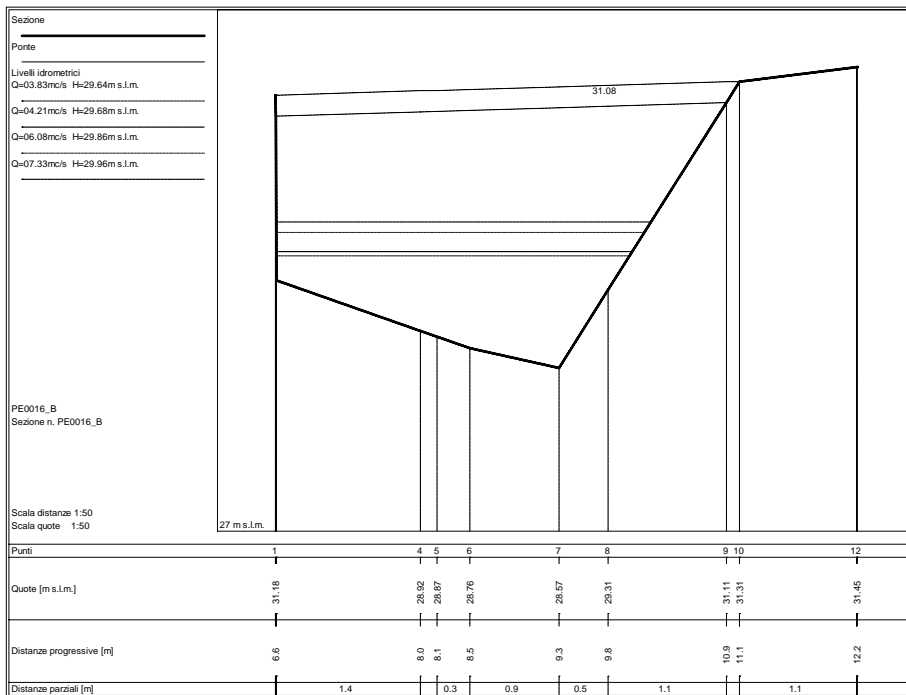
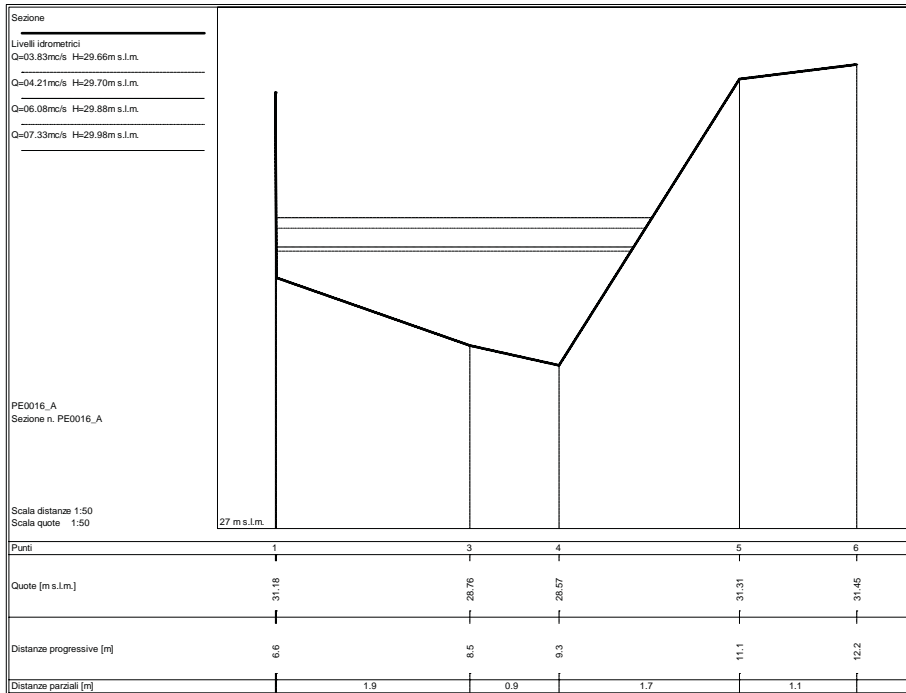

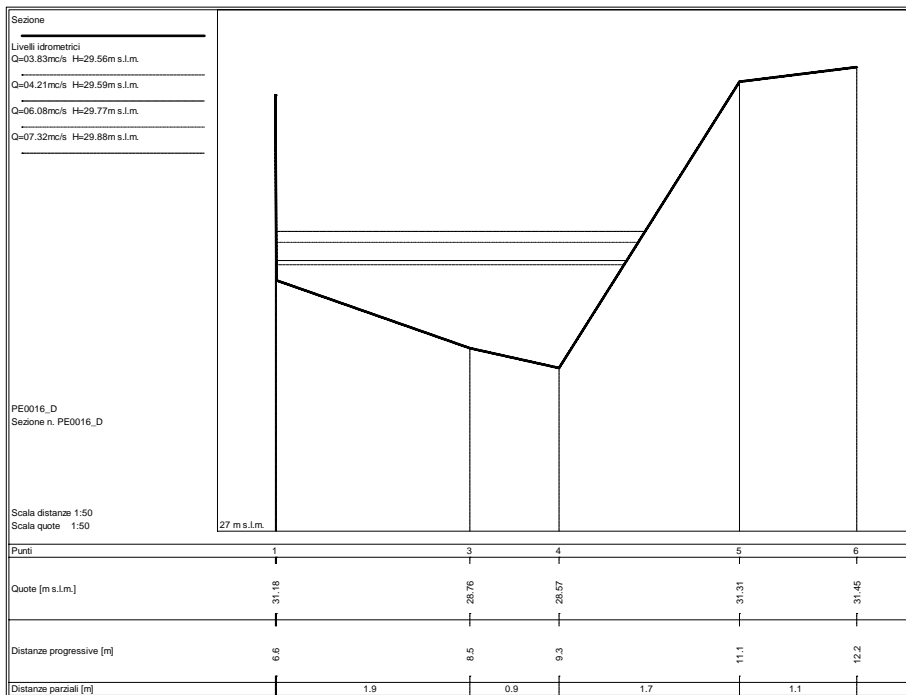
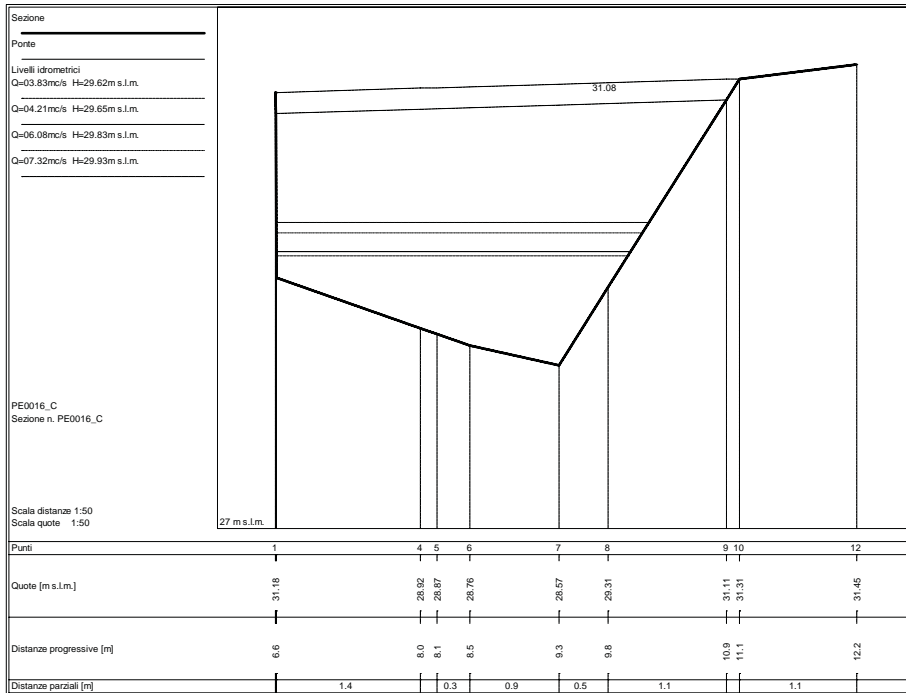

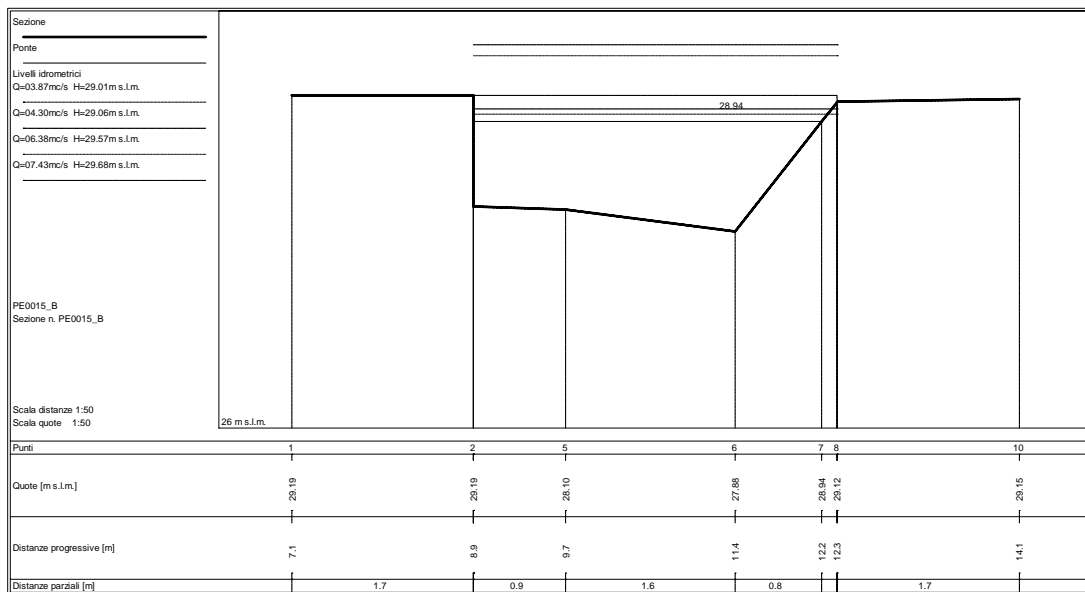
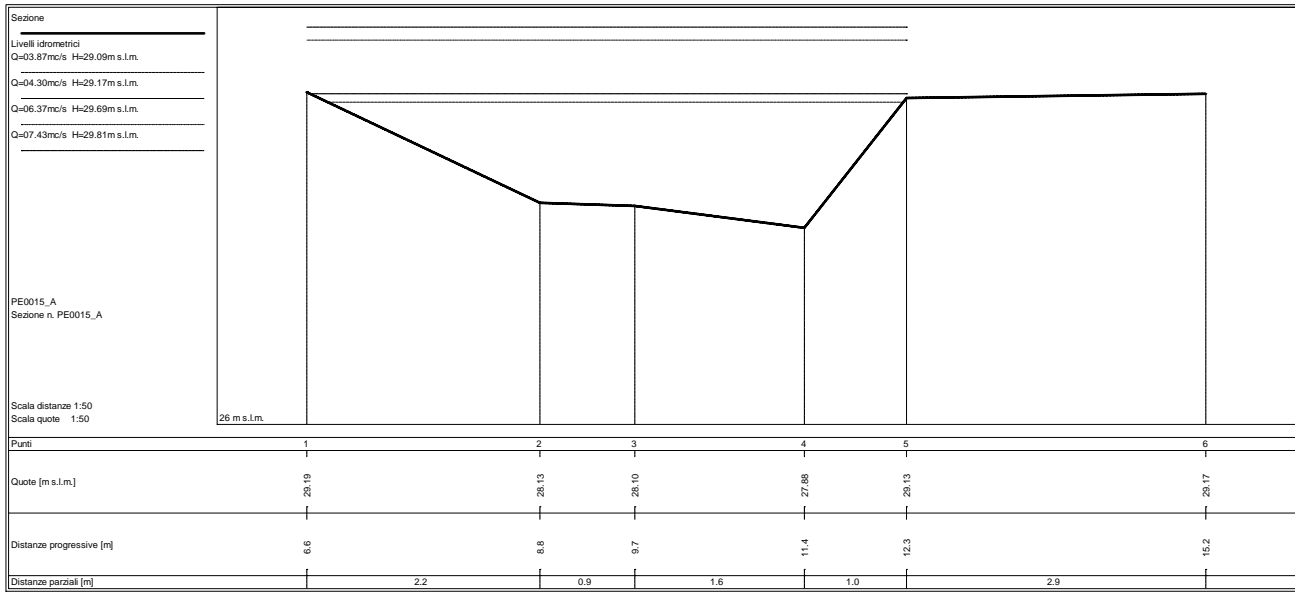

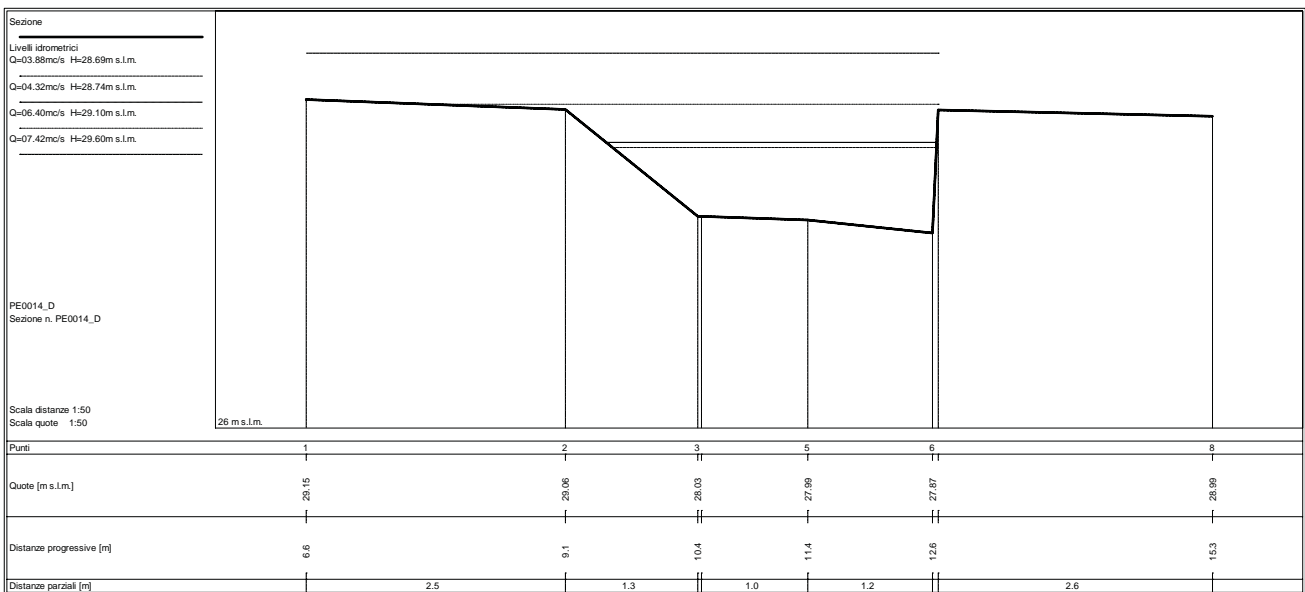
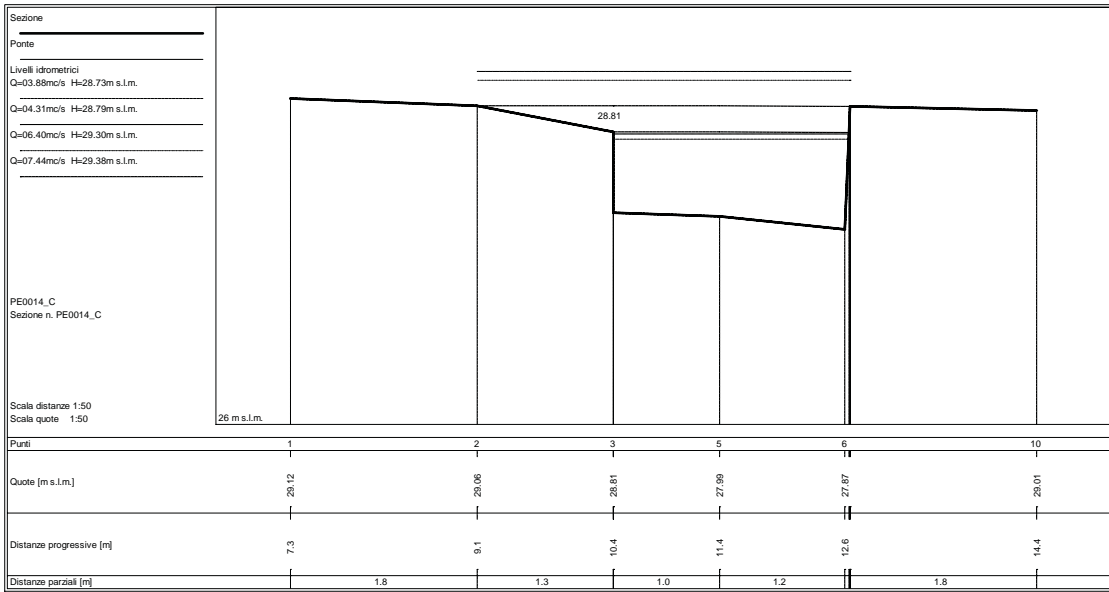

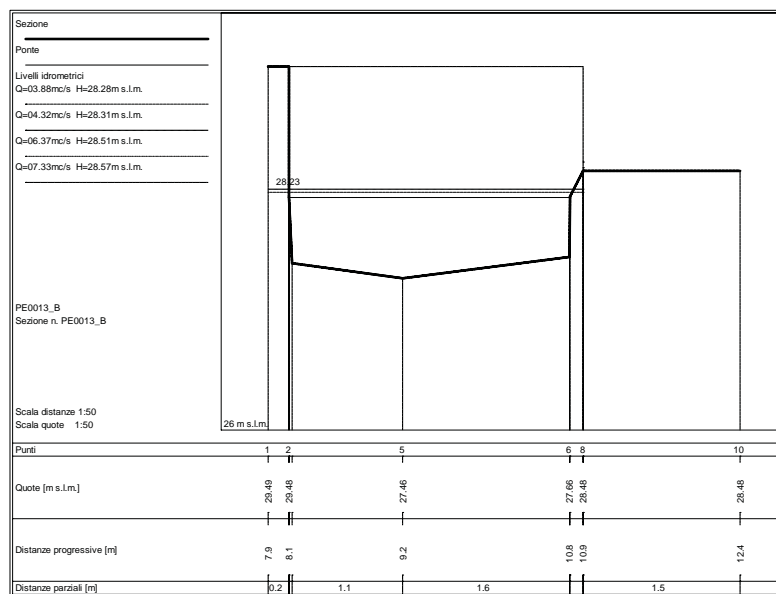
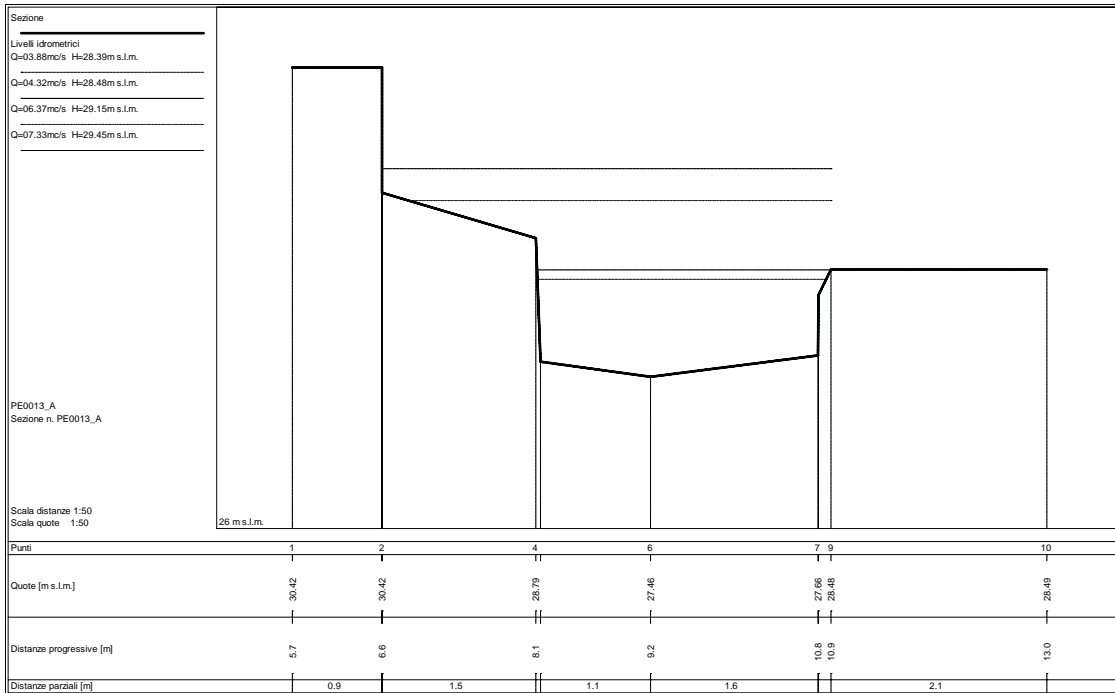

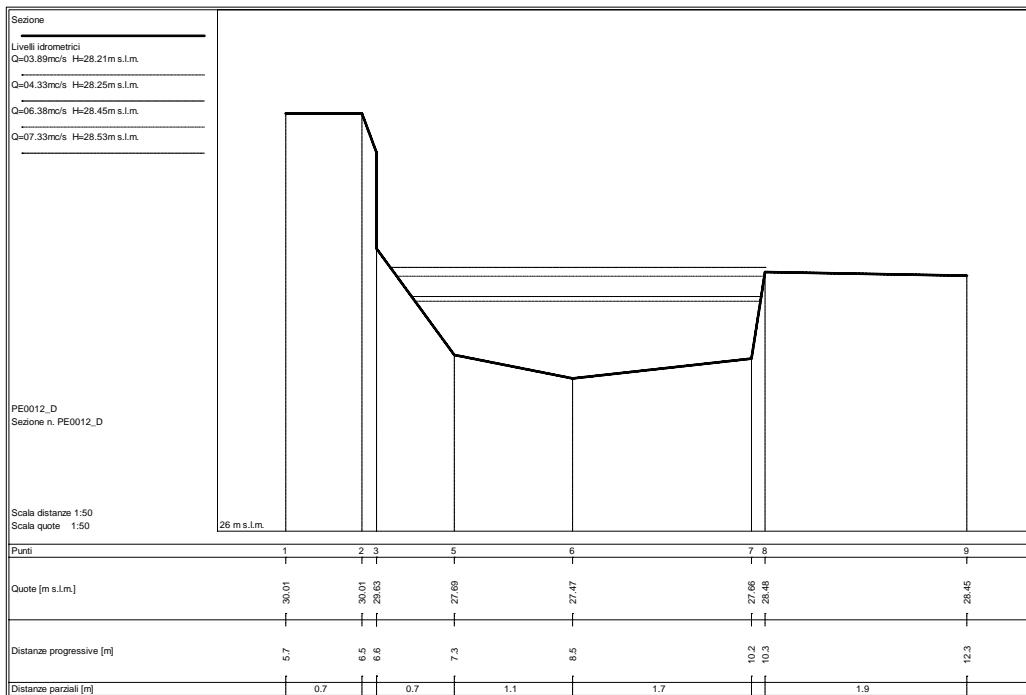
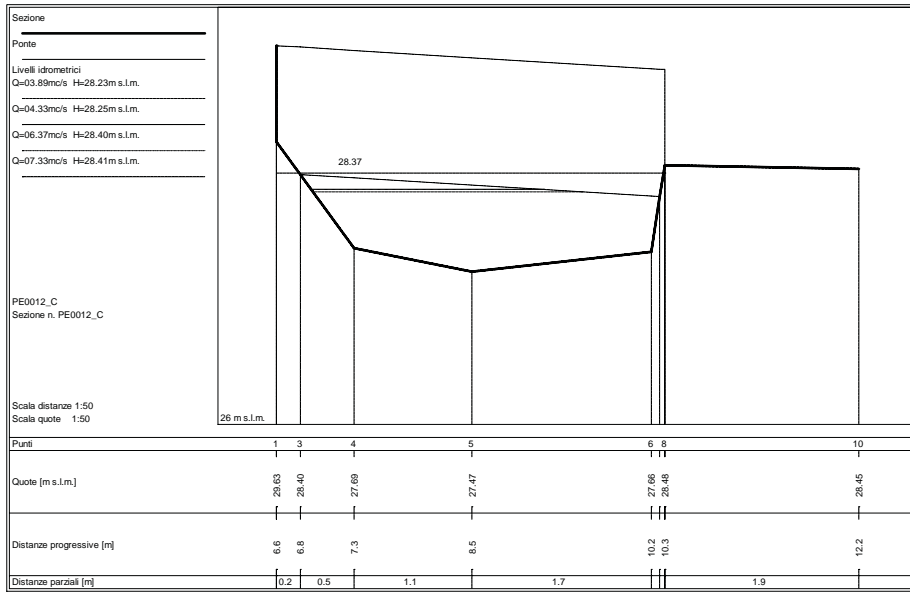

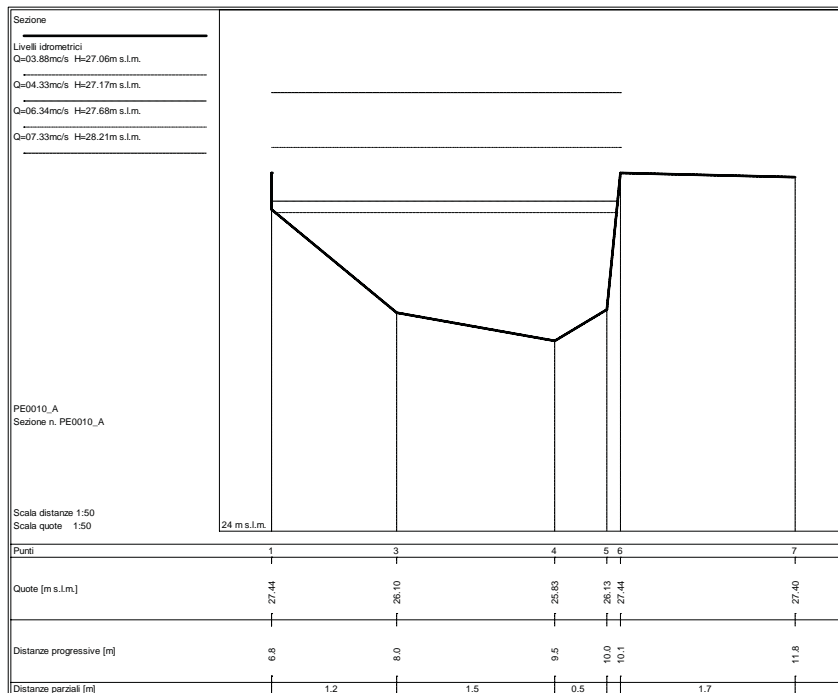
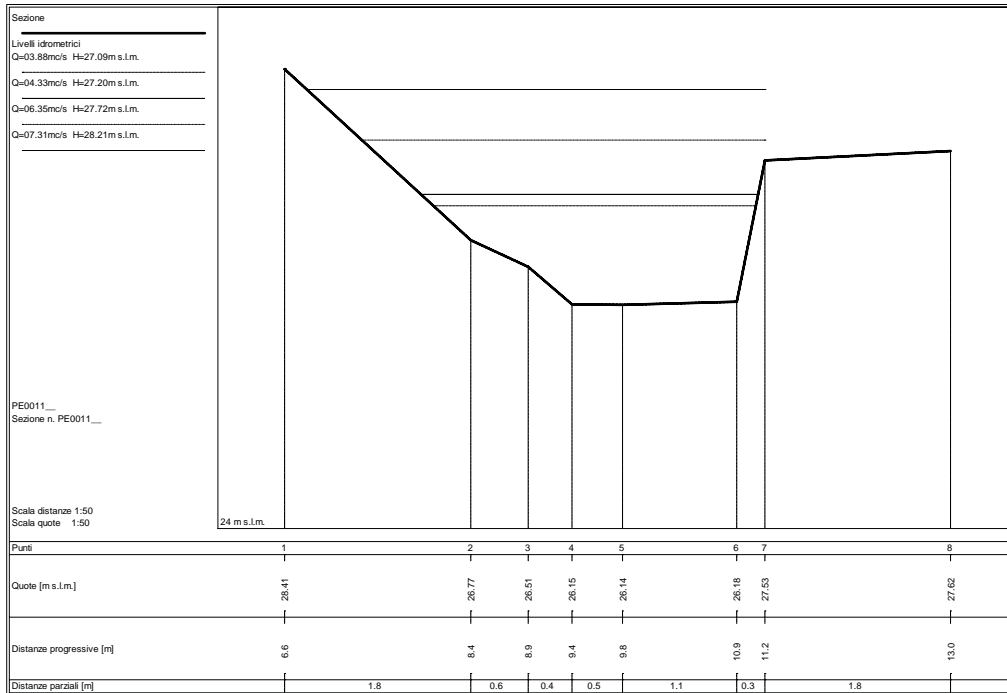

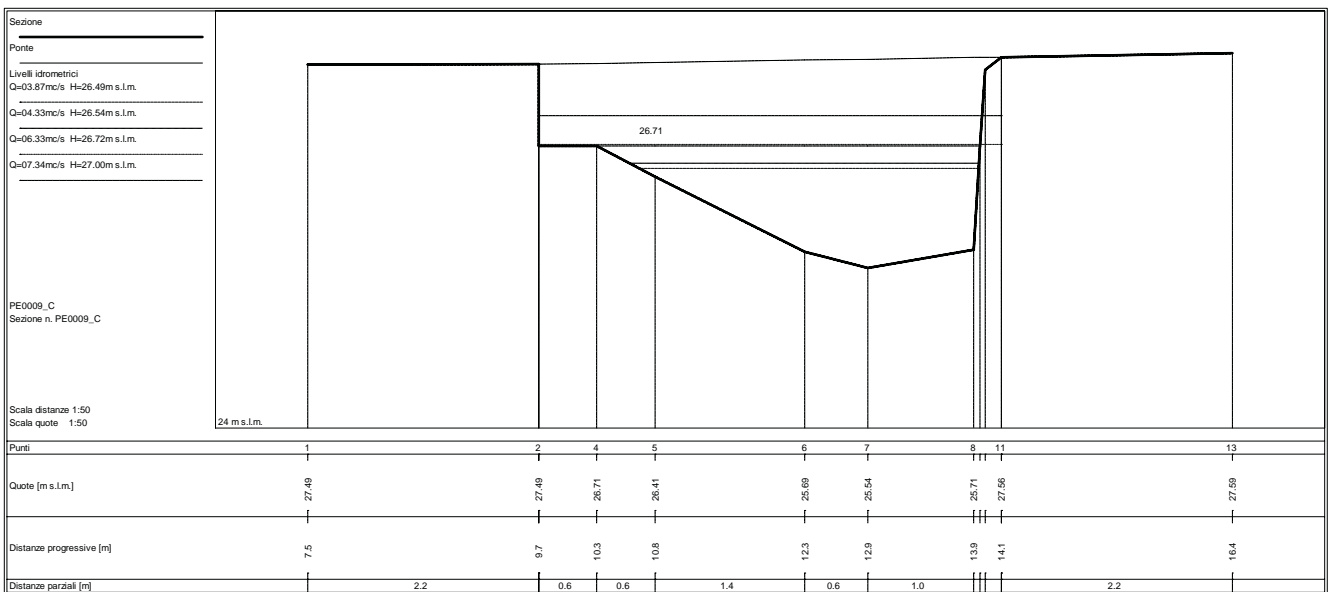
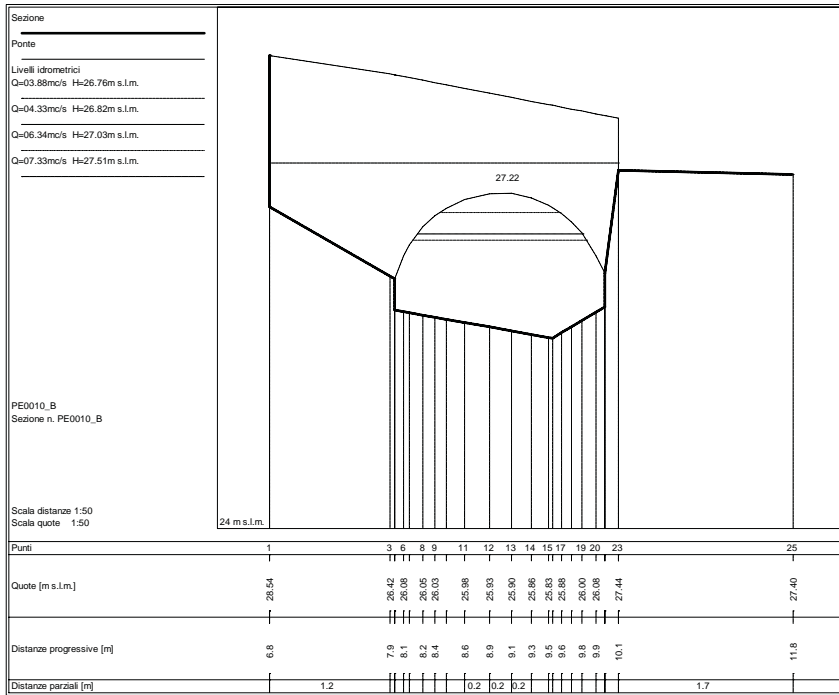

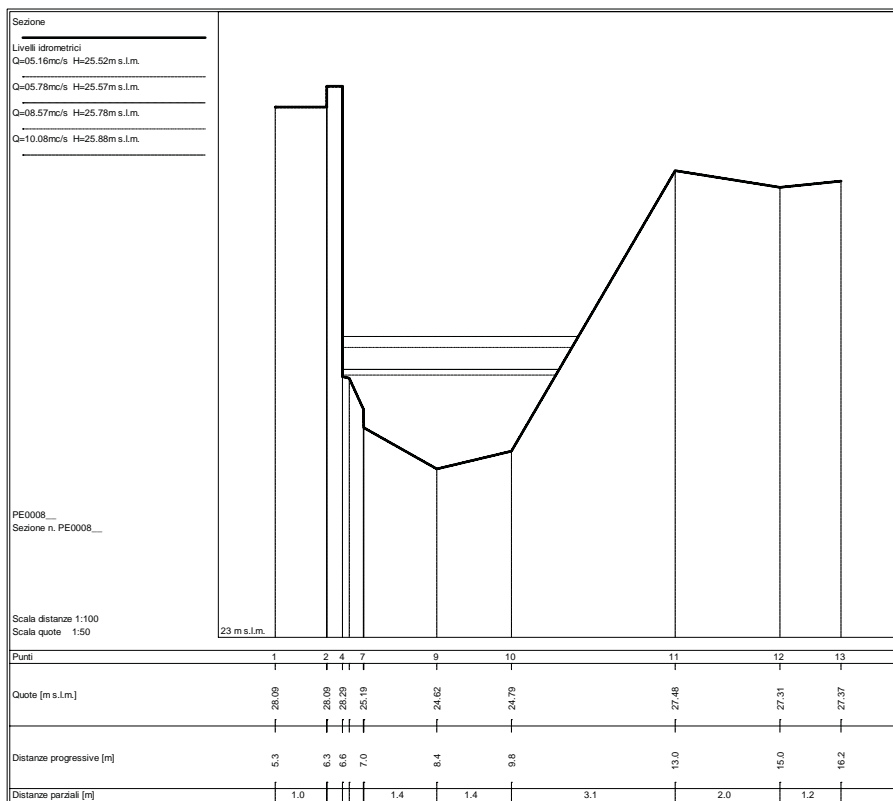
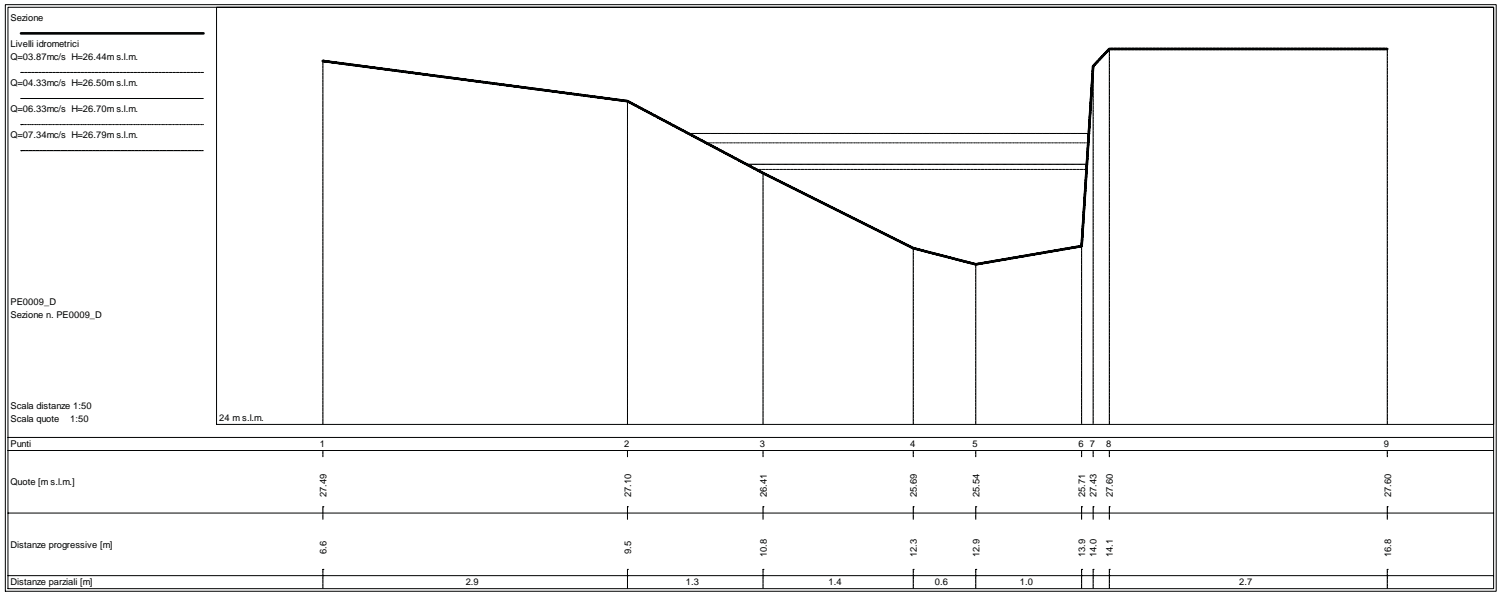

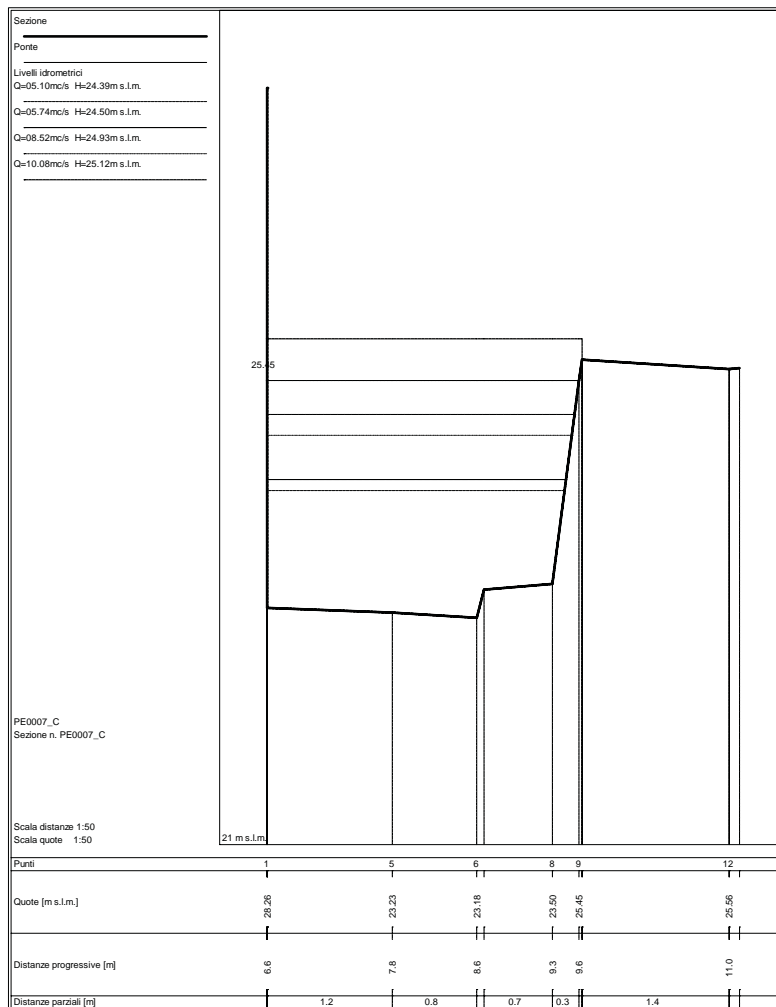
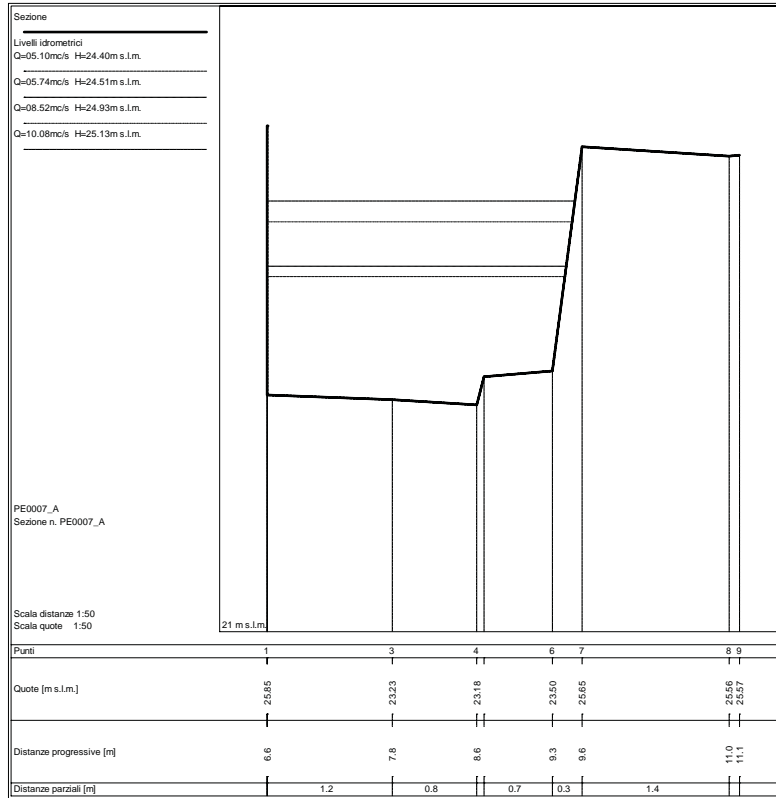

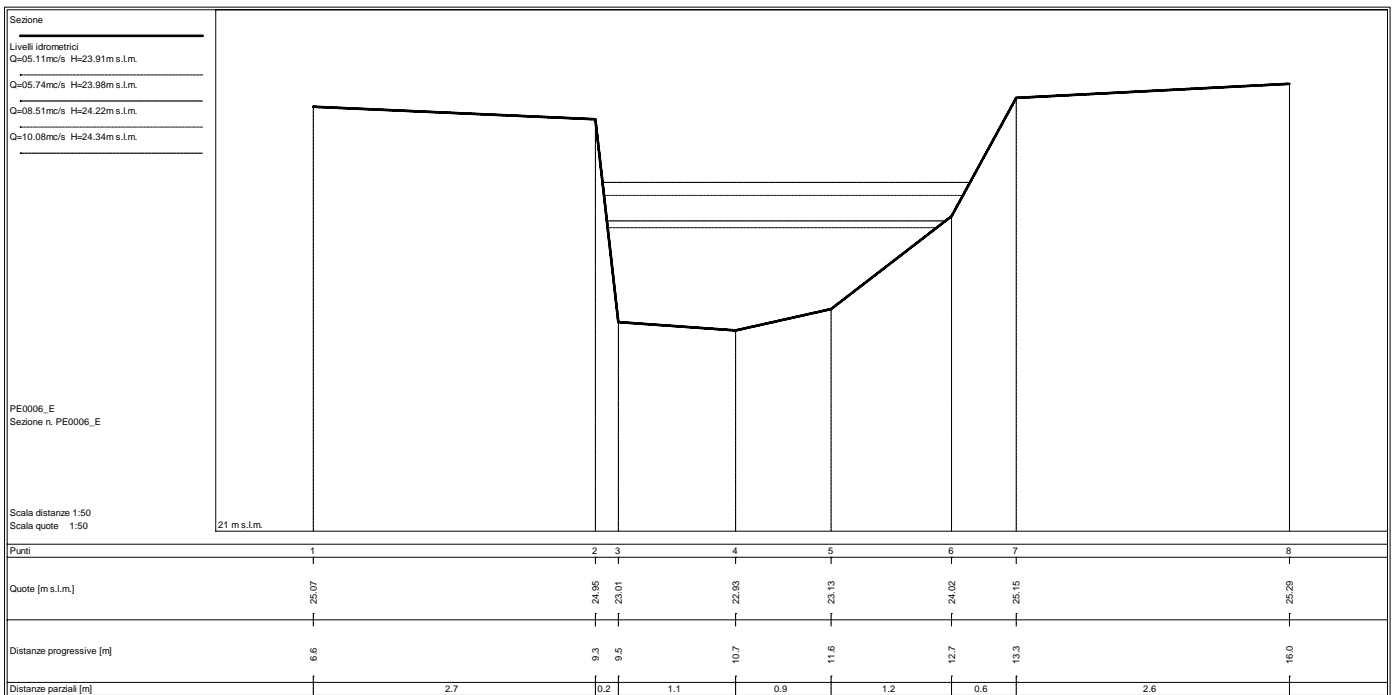
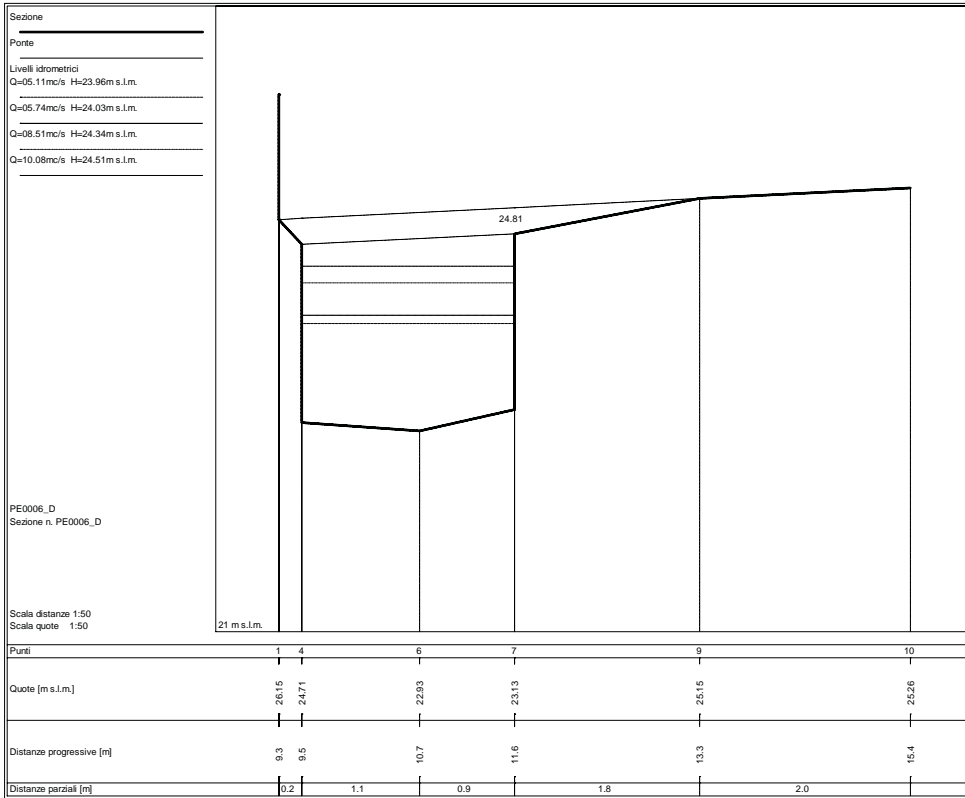

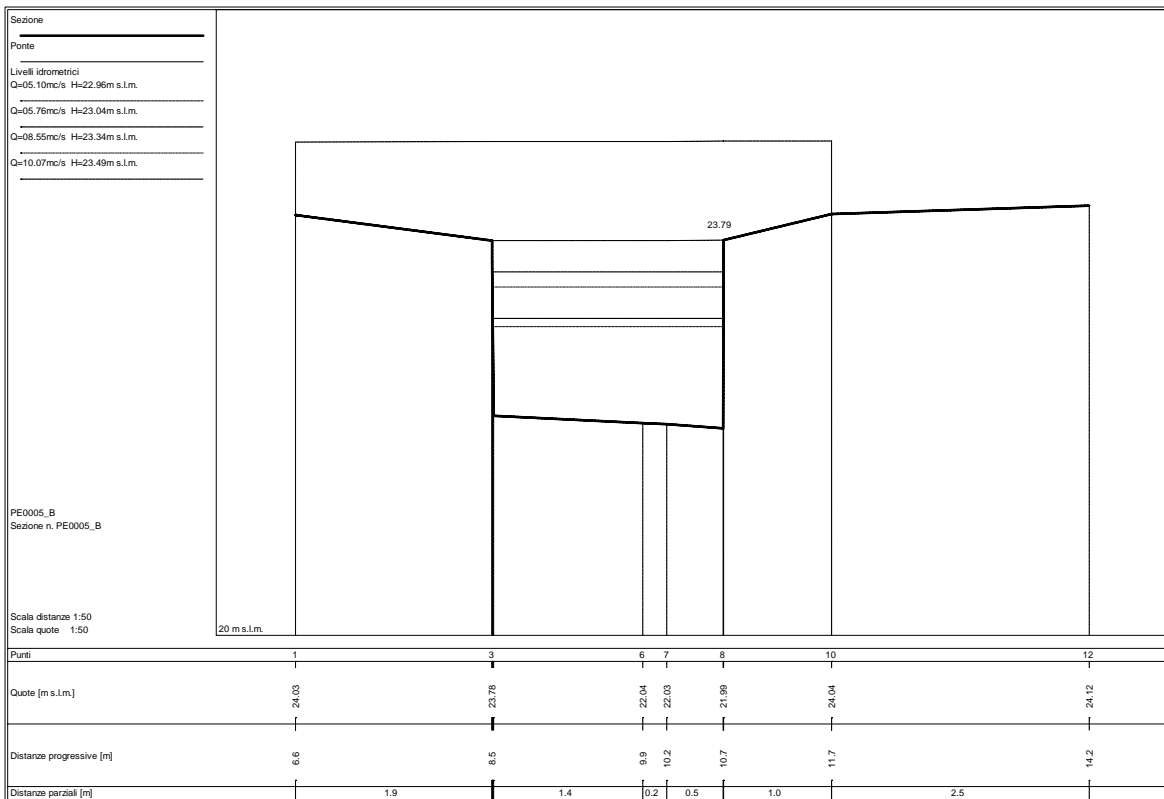
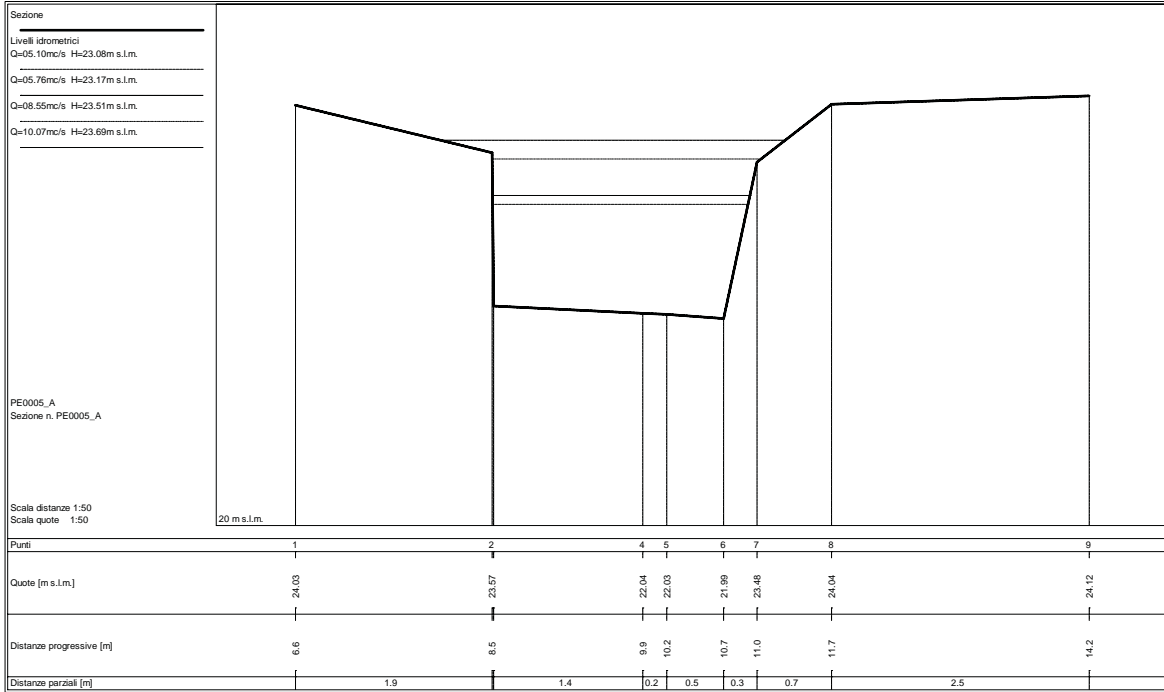

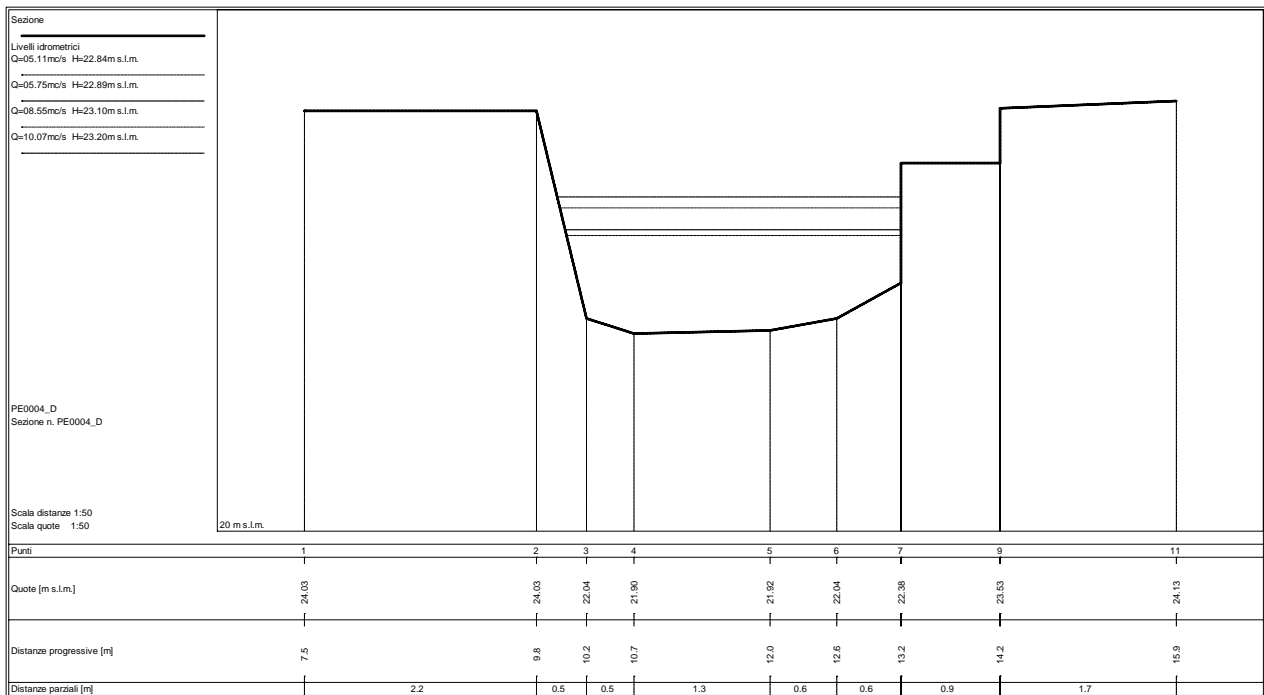
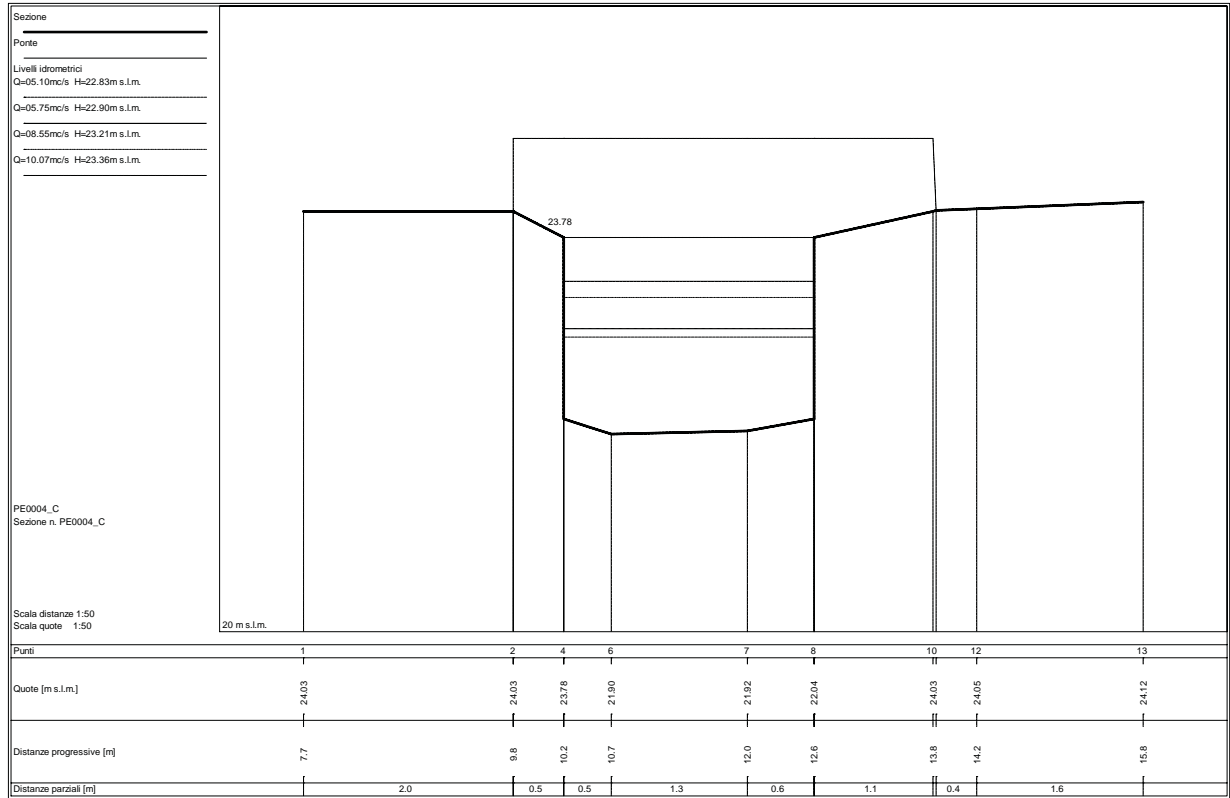

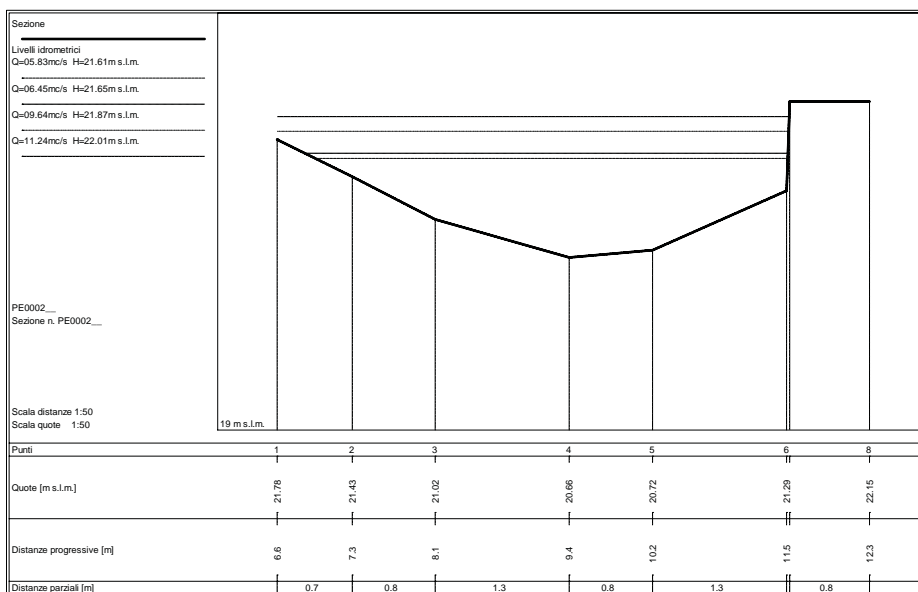
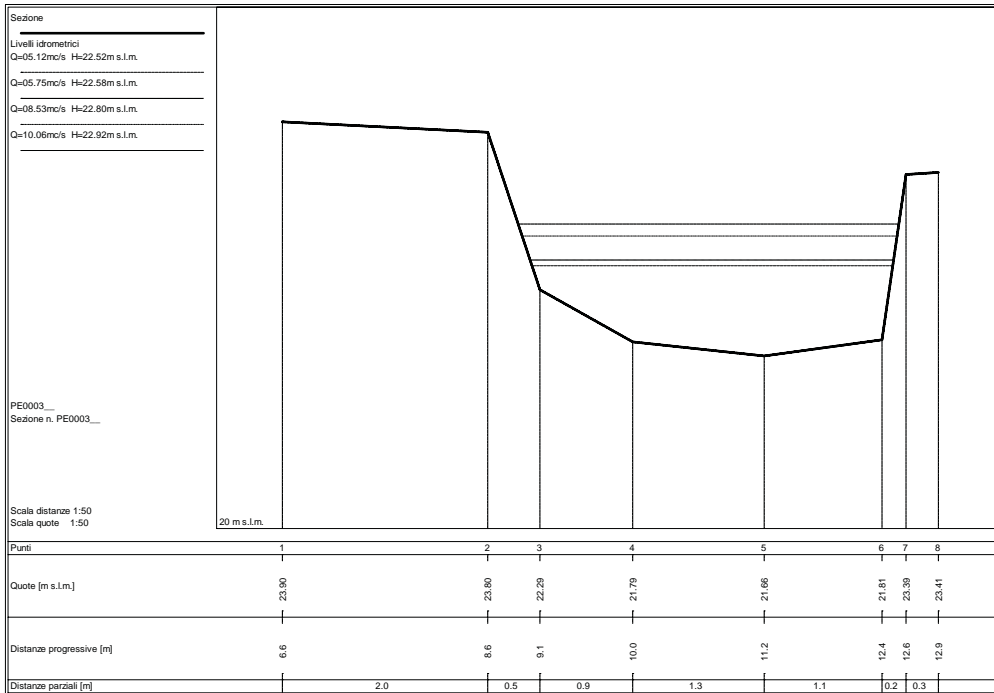

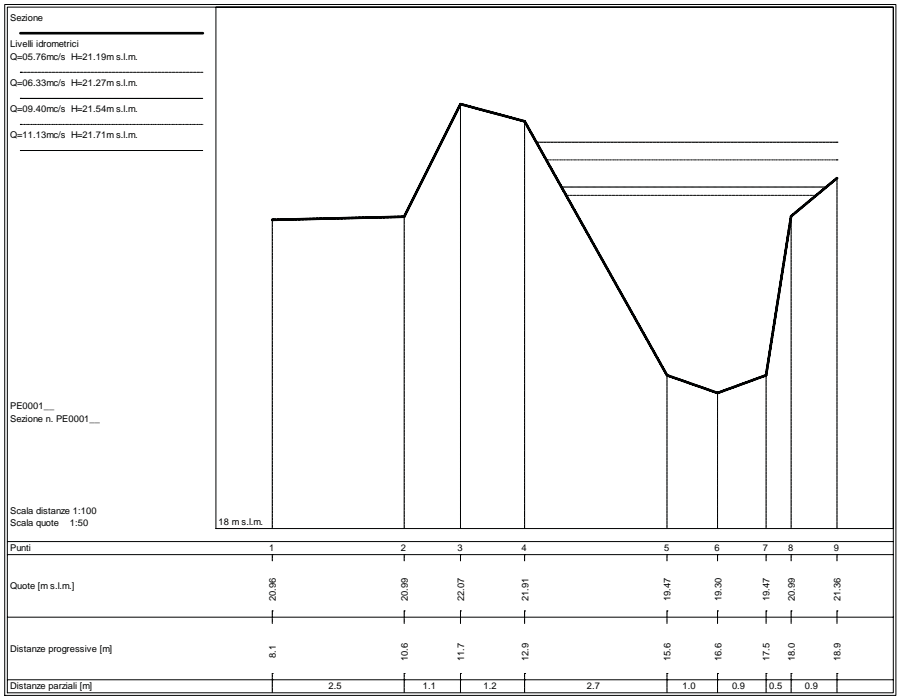

STATO ATTUALE

Sezioni fluviali fosso San Lorenzo

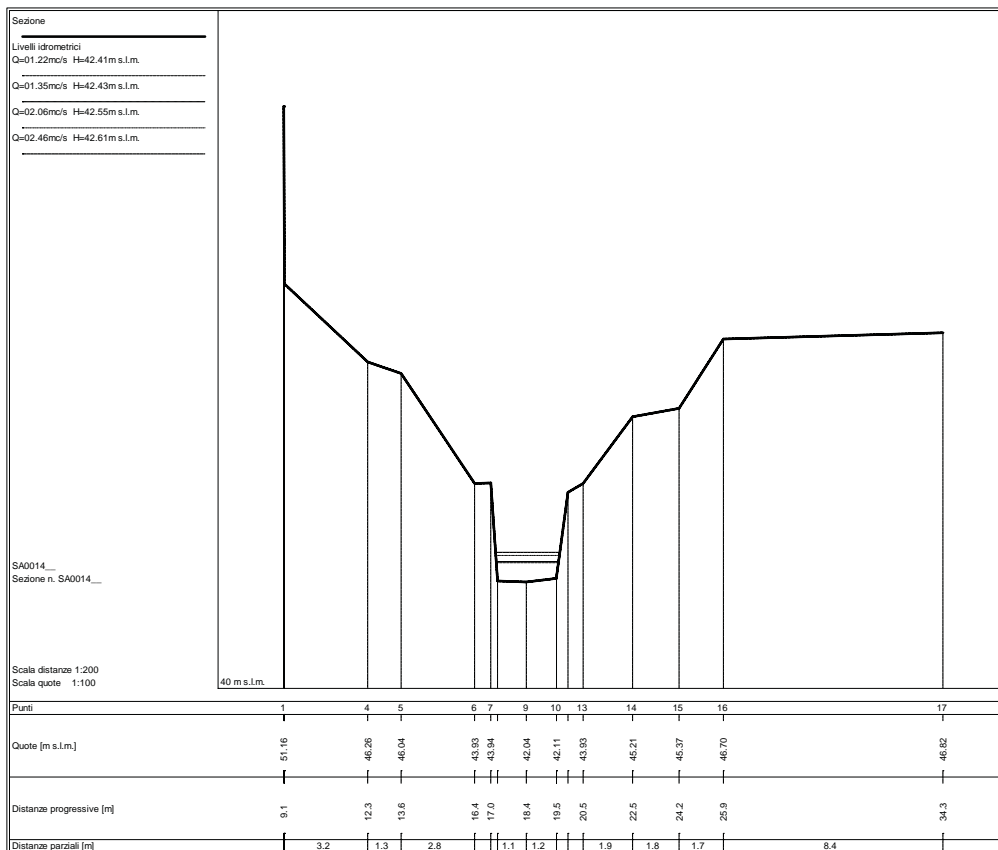
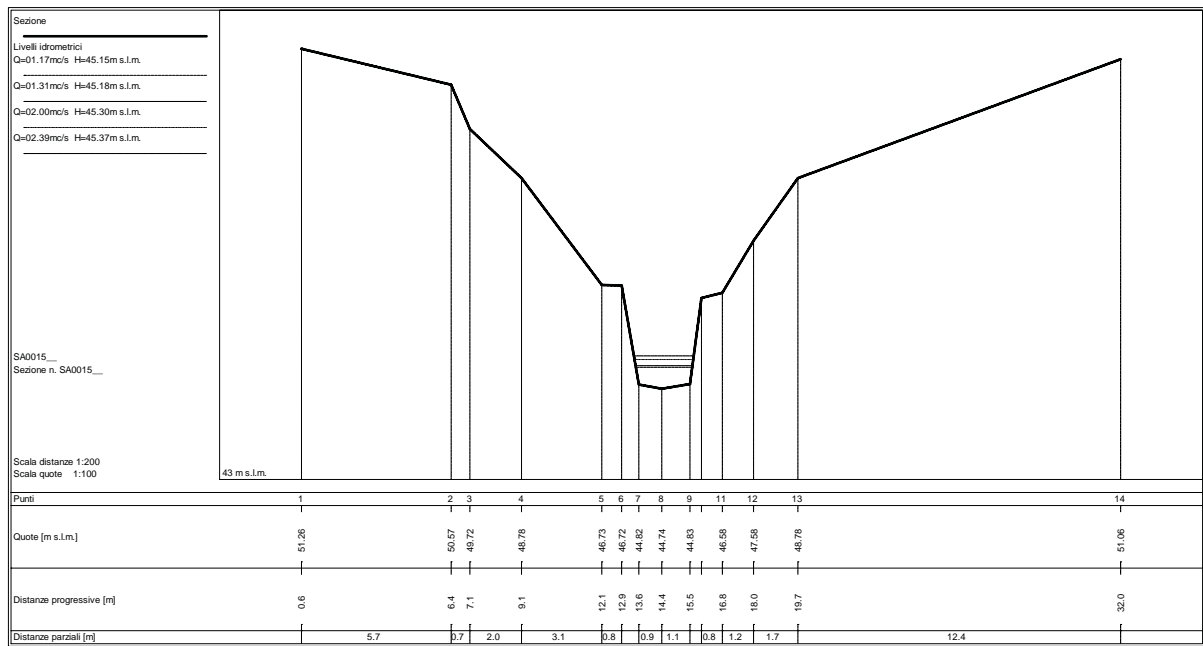

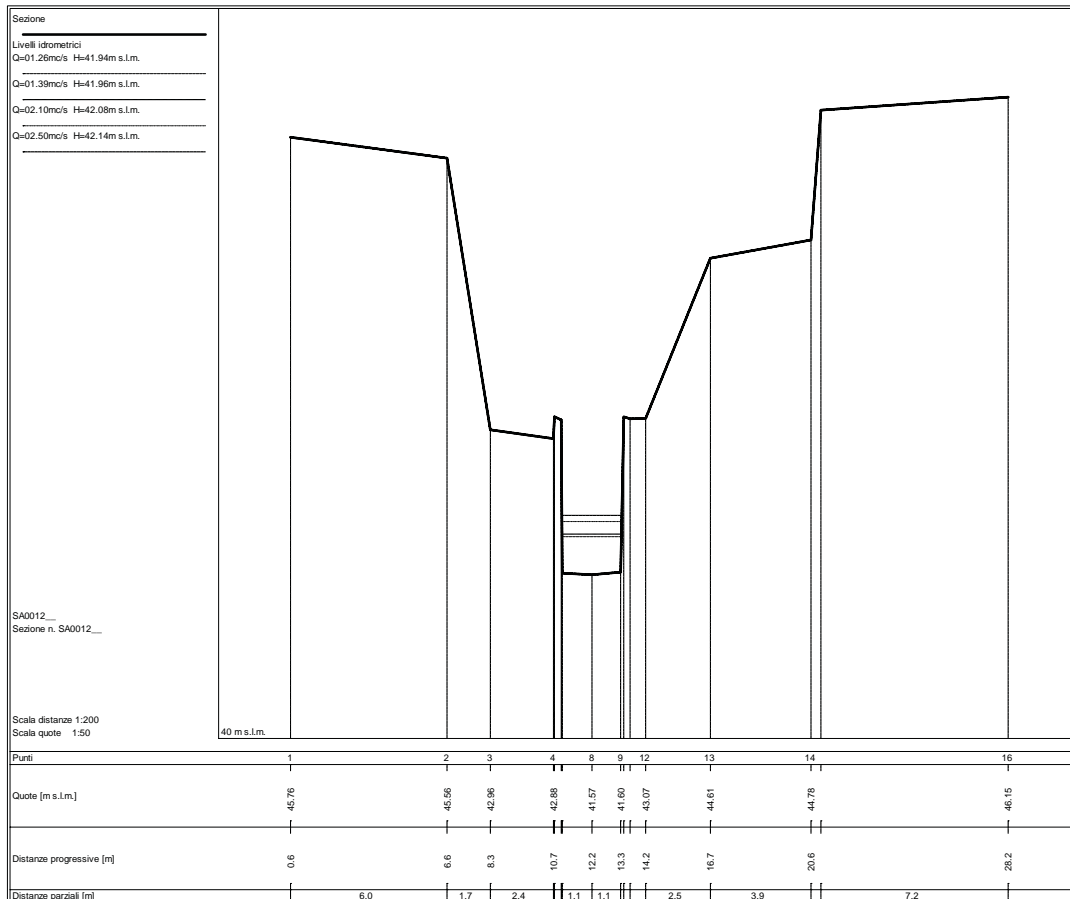
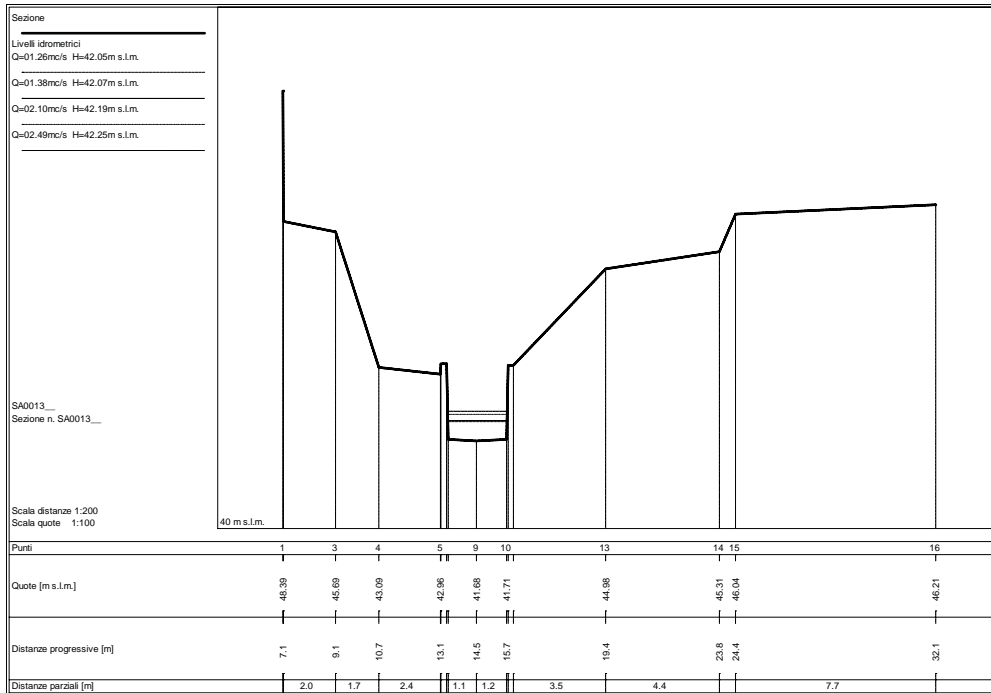

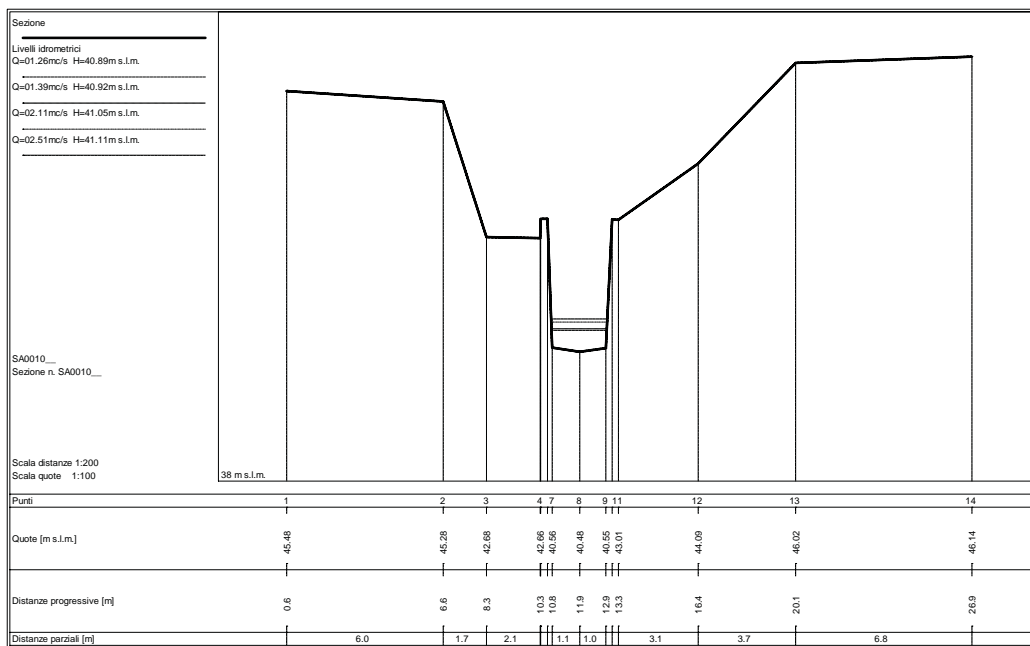
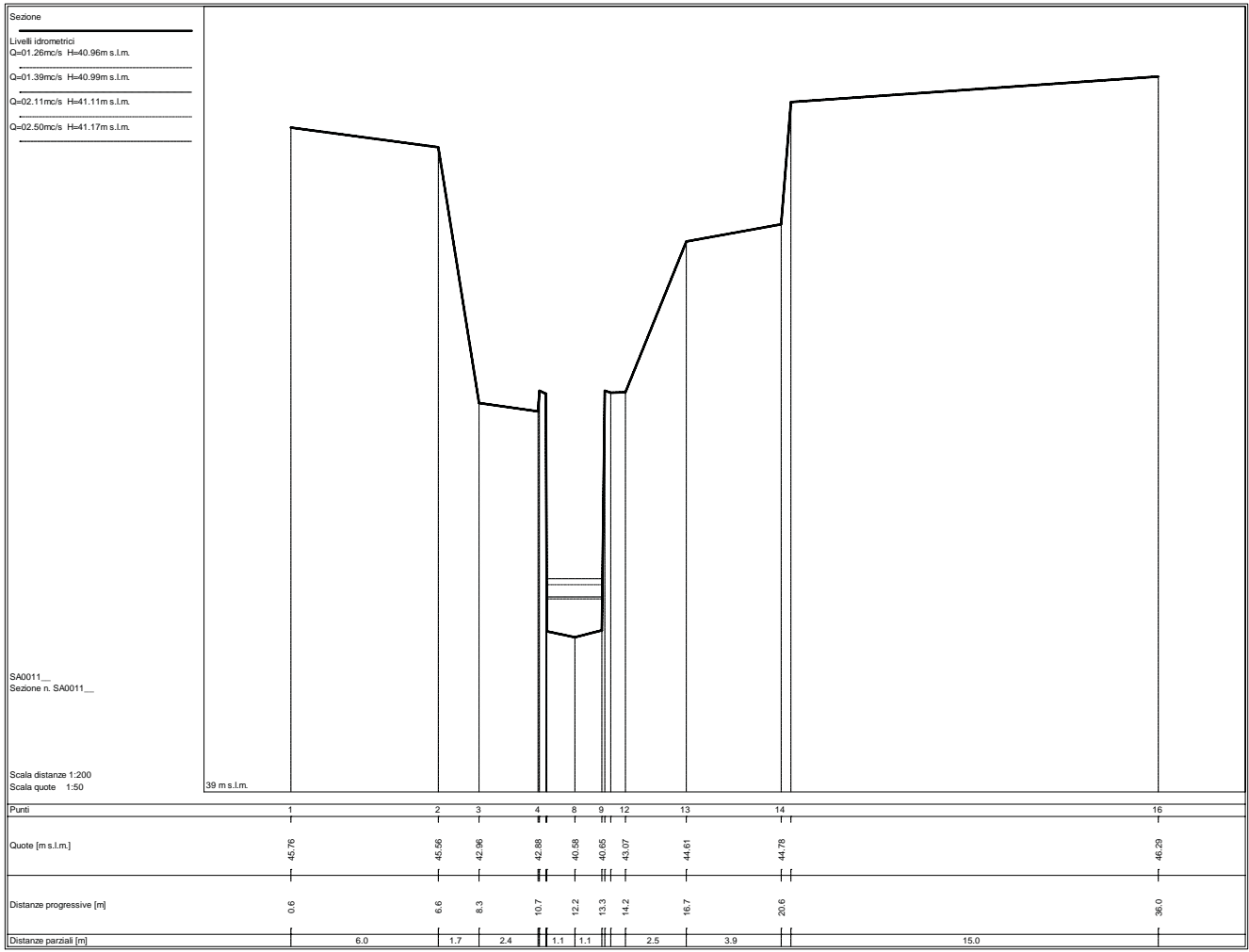

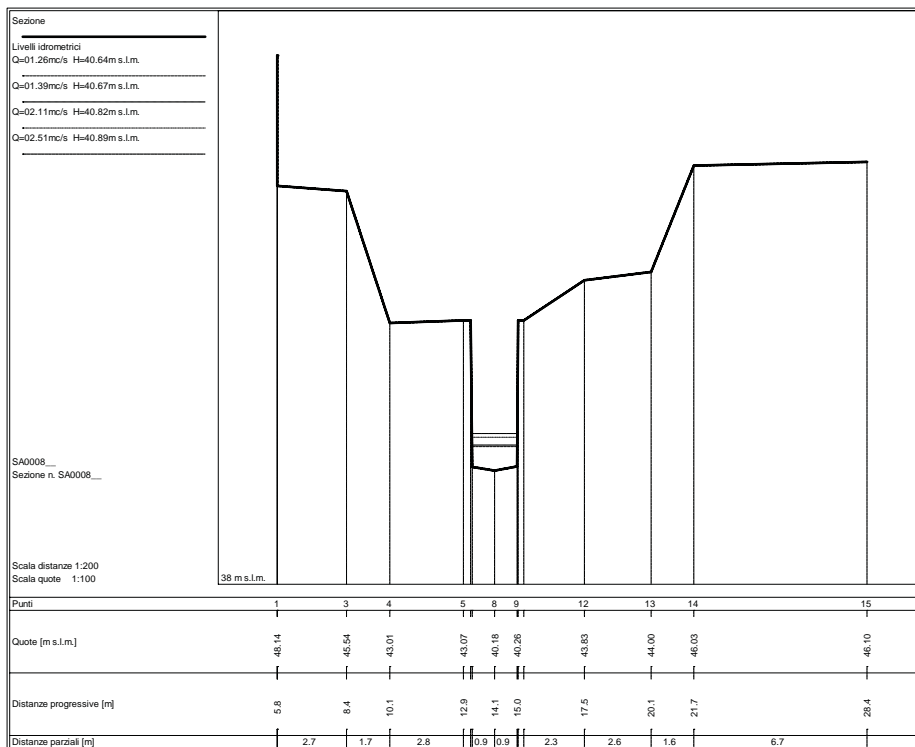
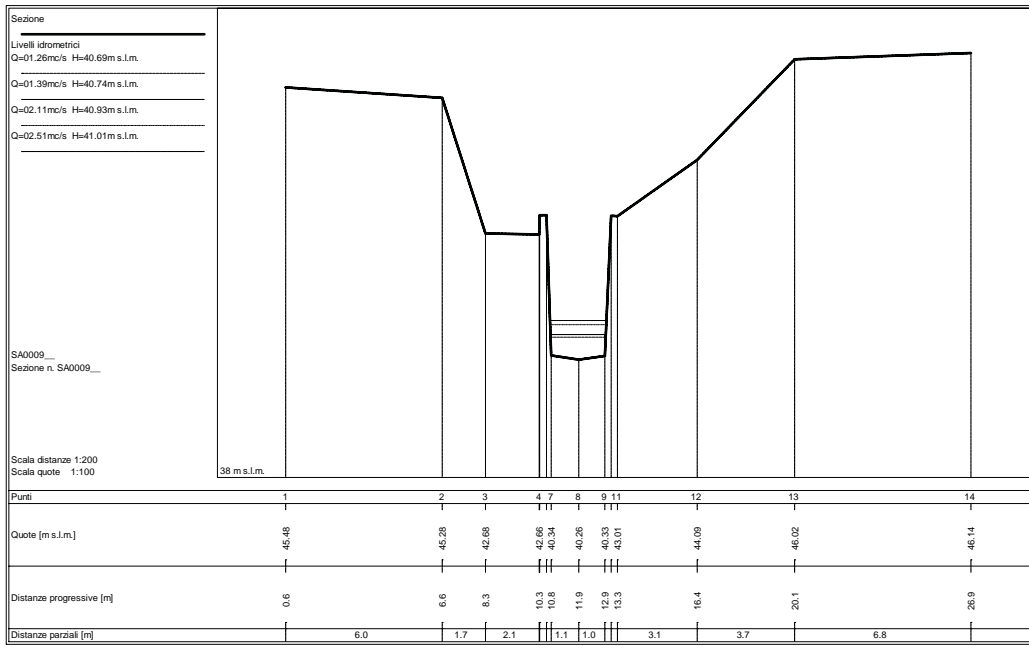

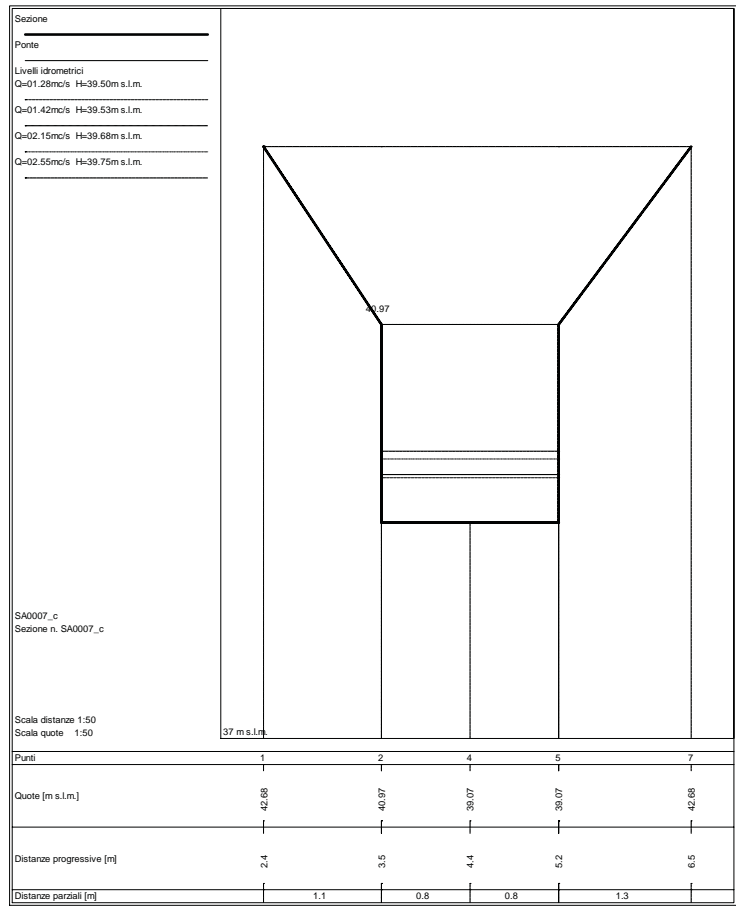
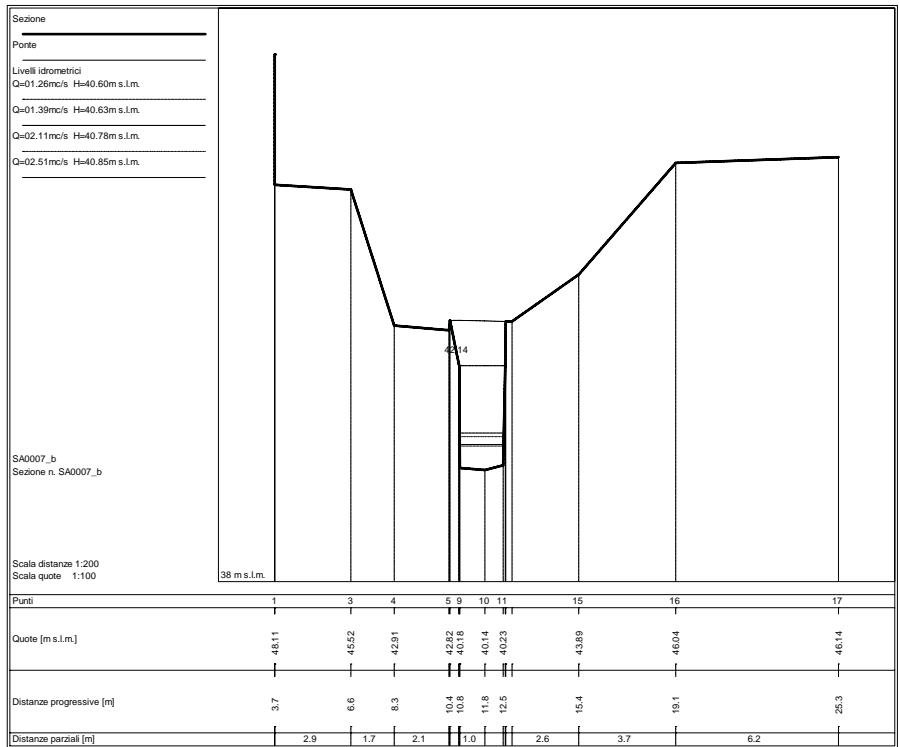

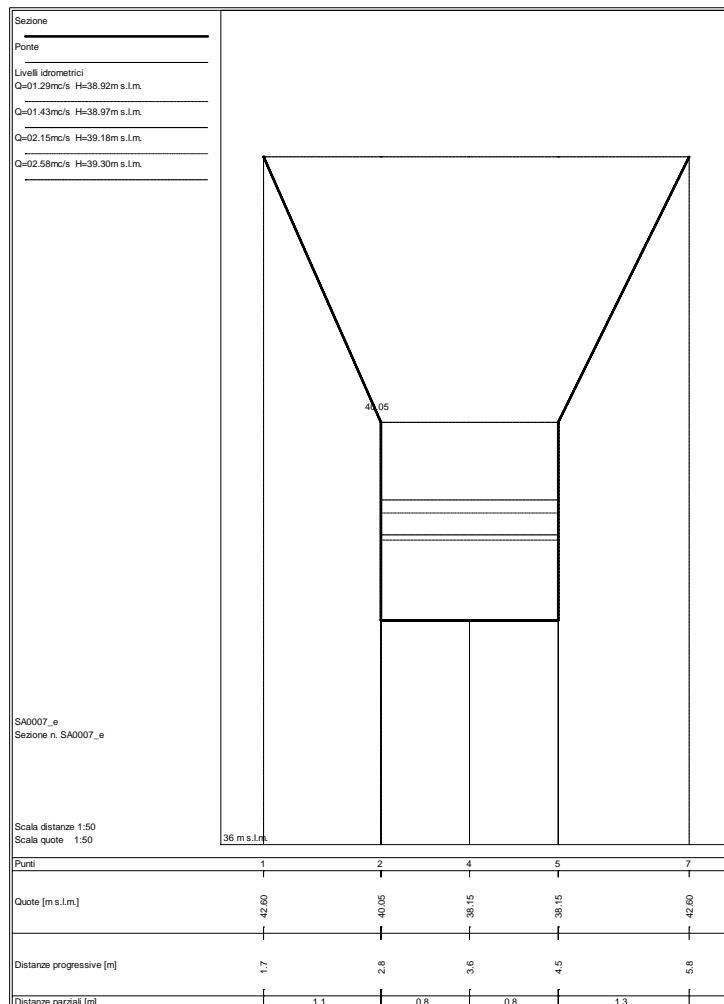
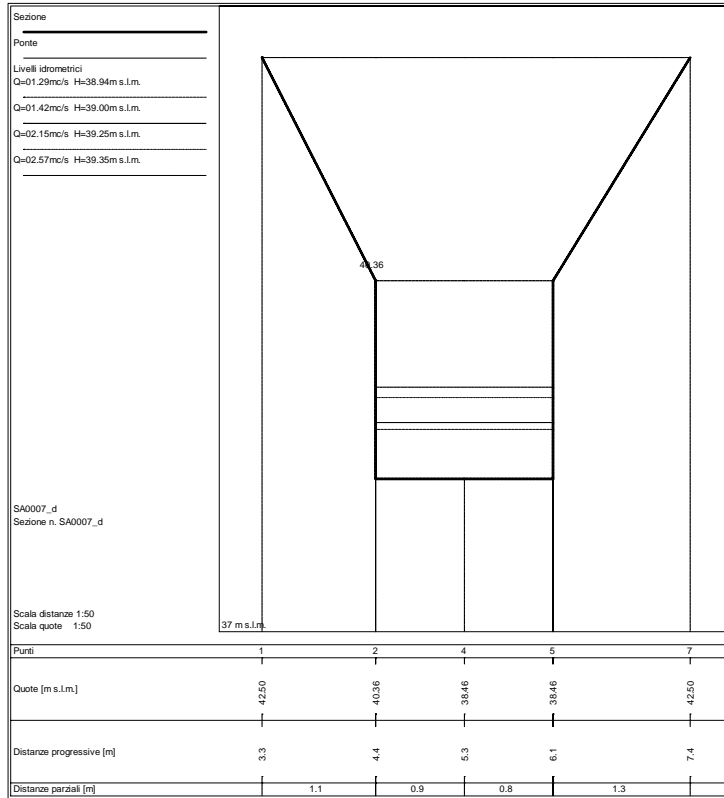

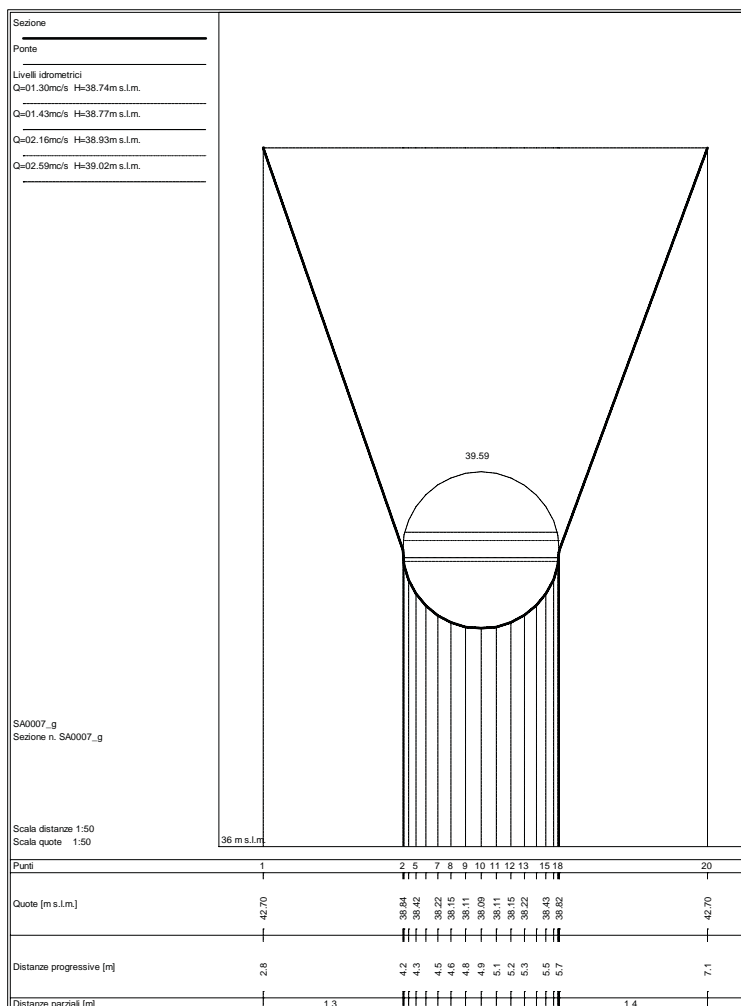
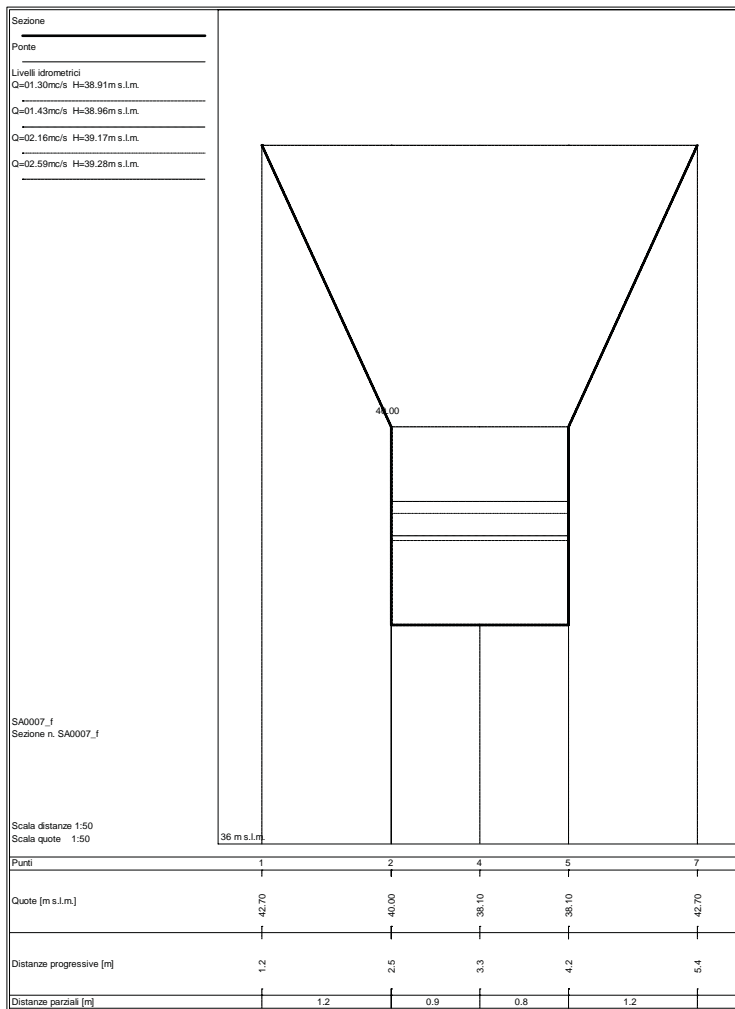

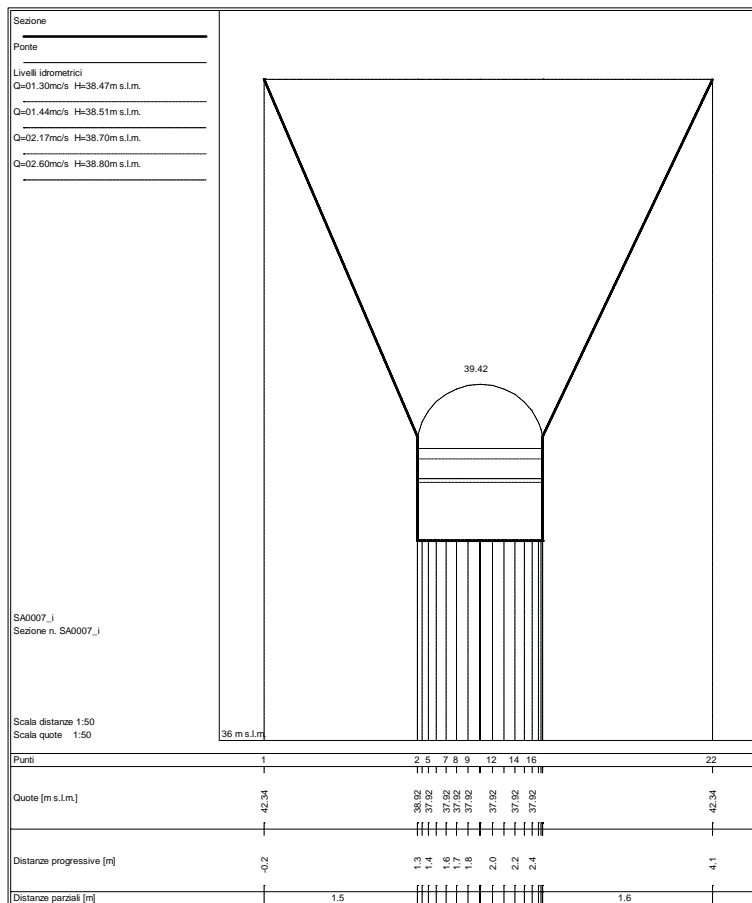
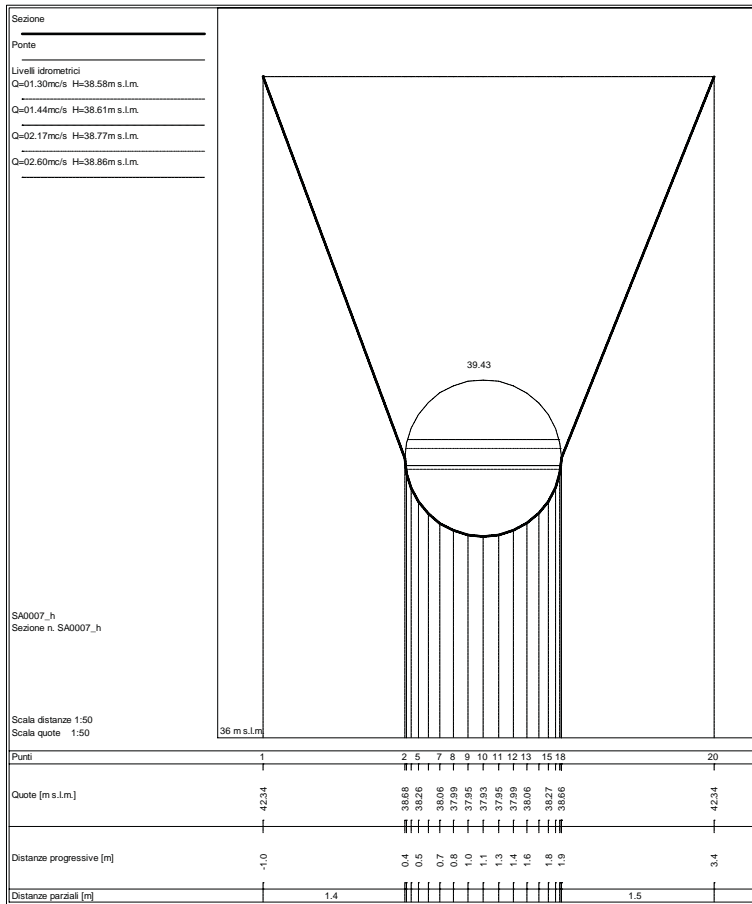

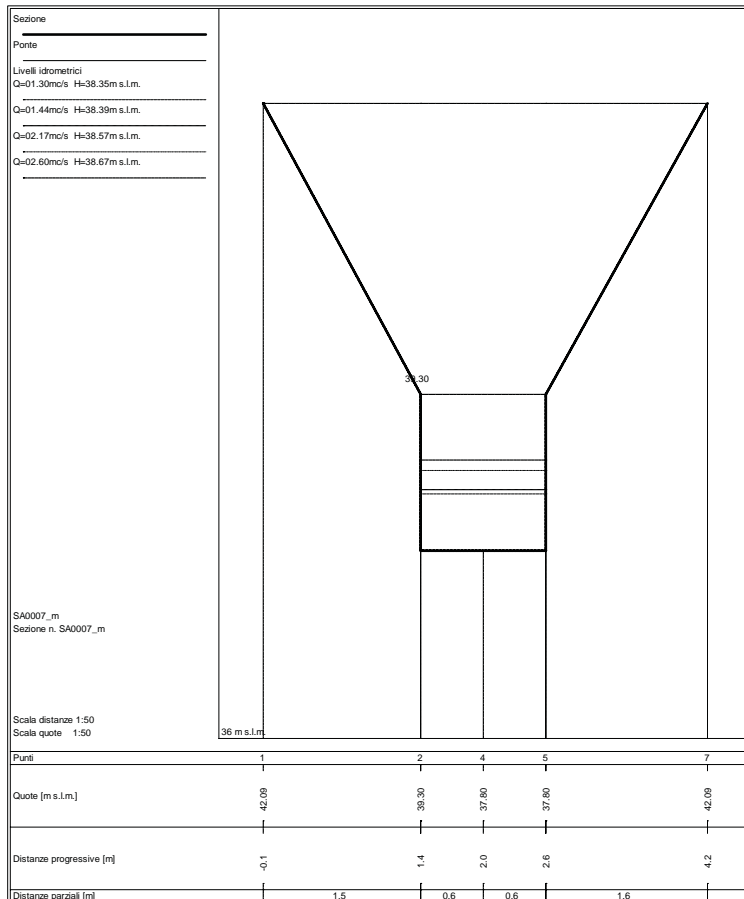
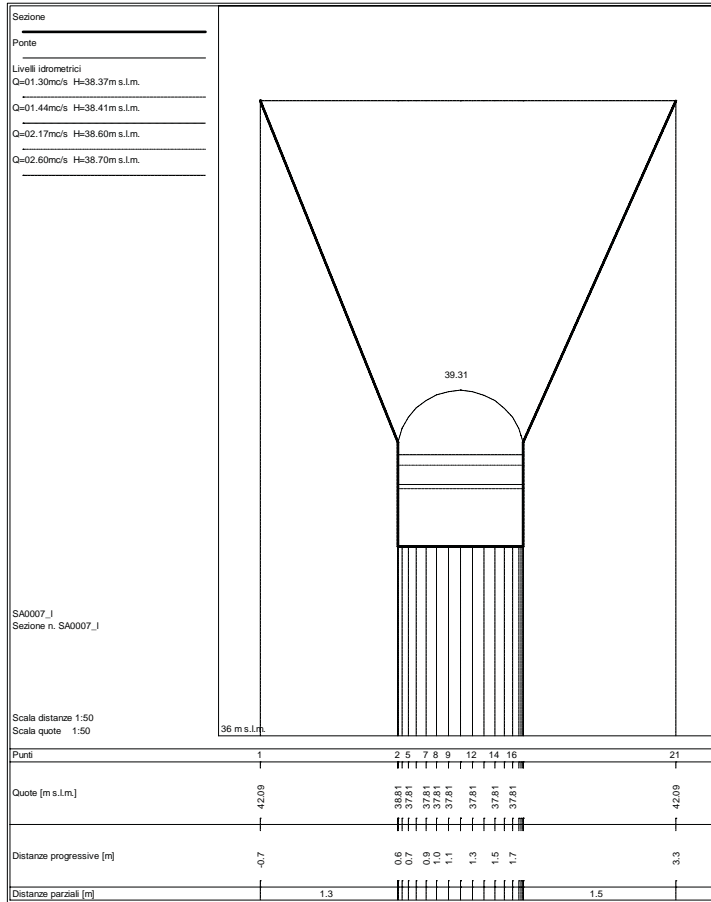

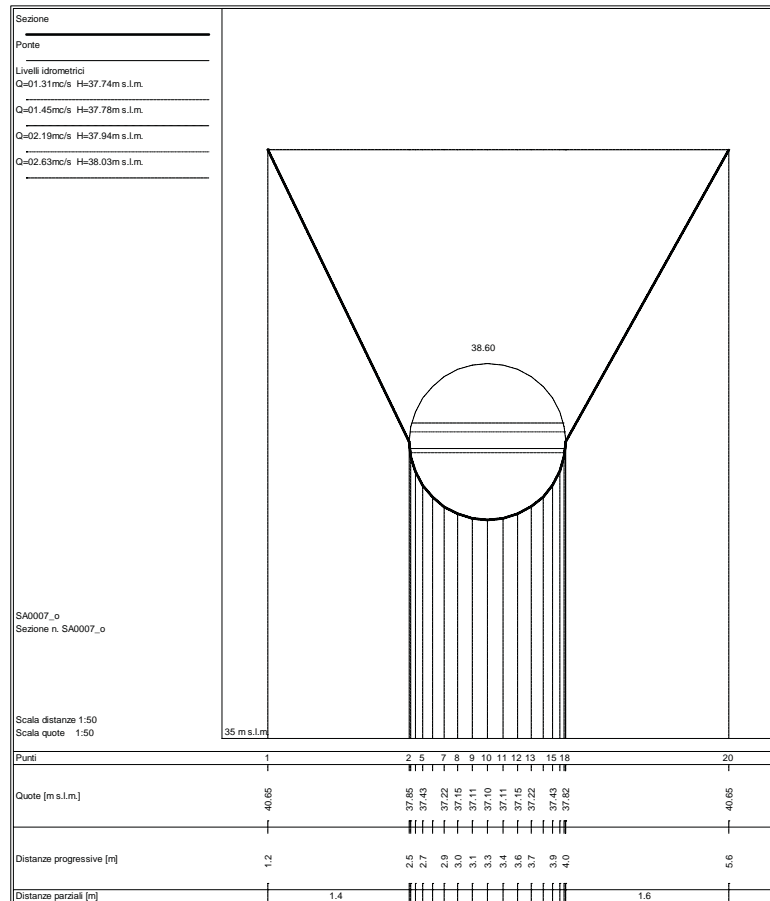
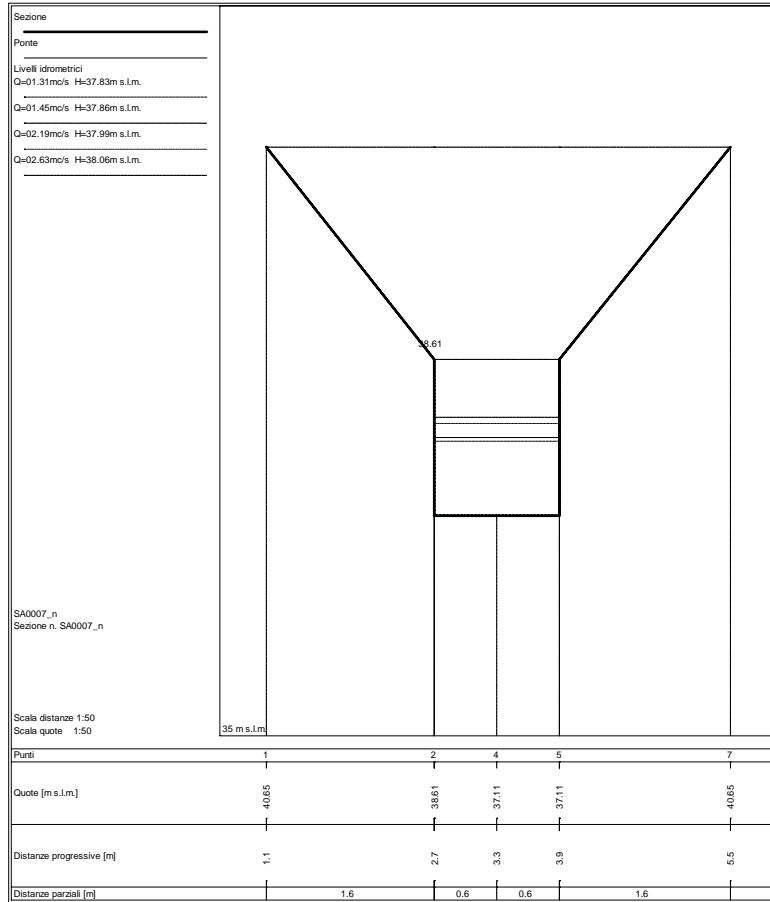

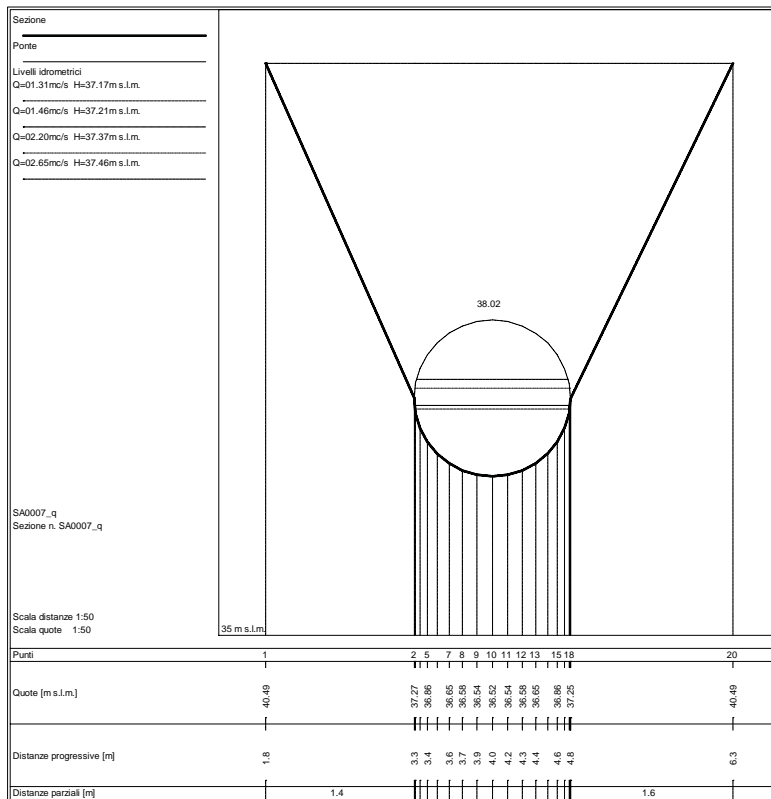
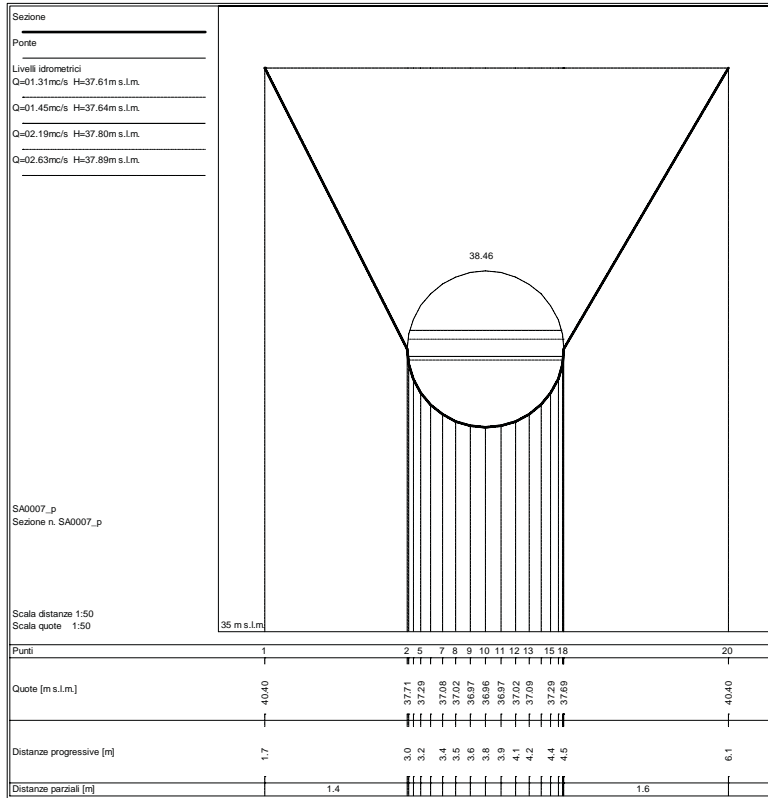

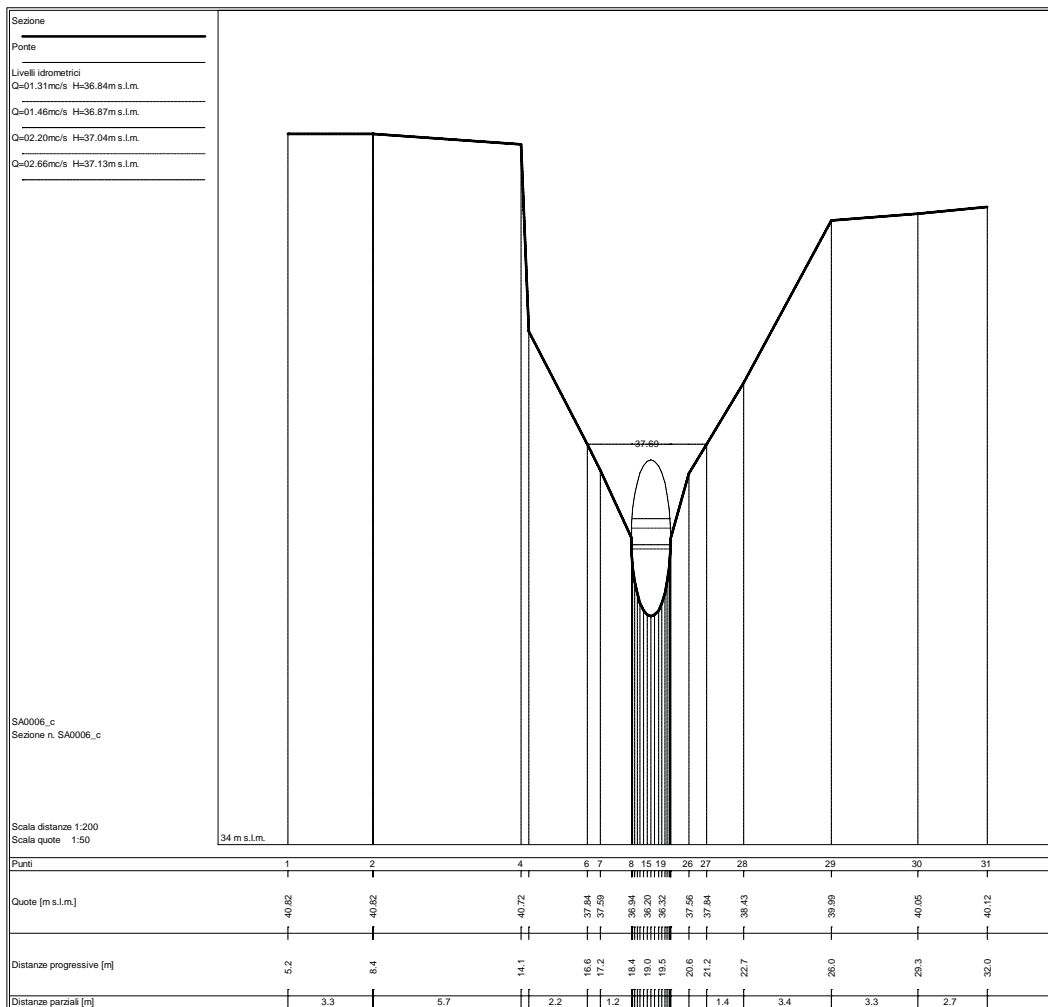
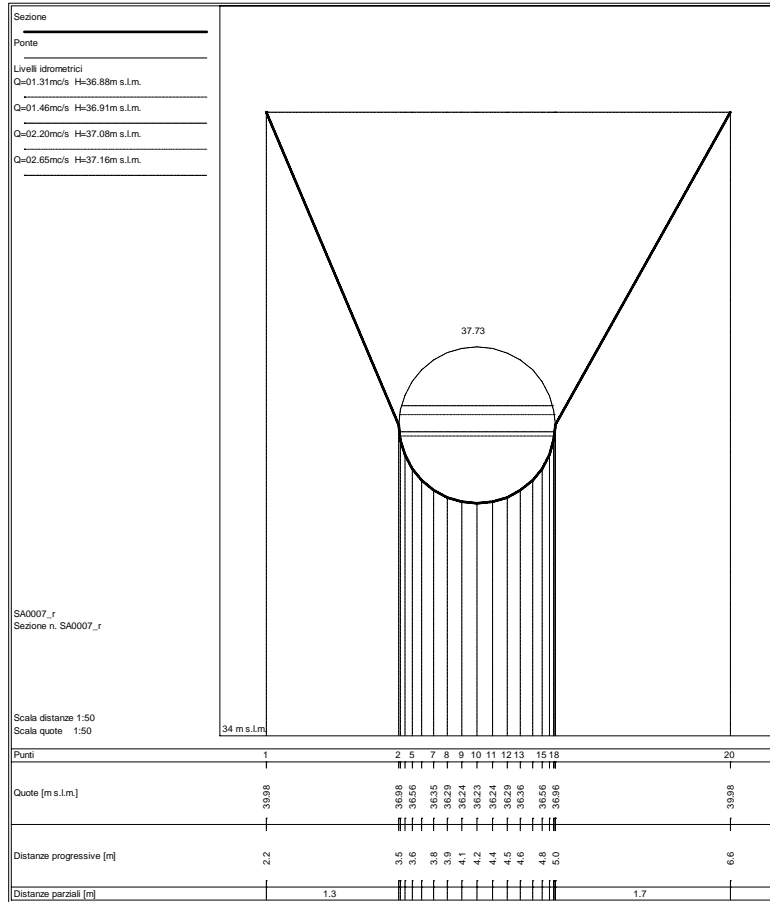

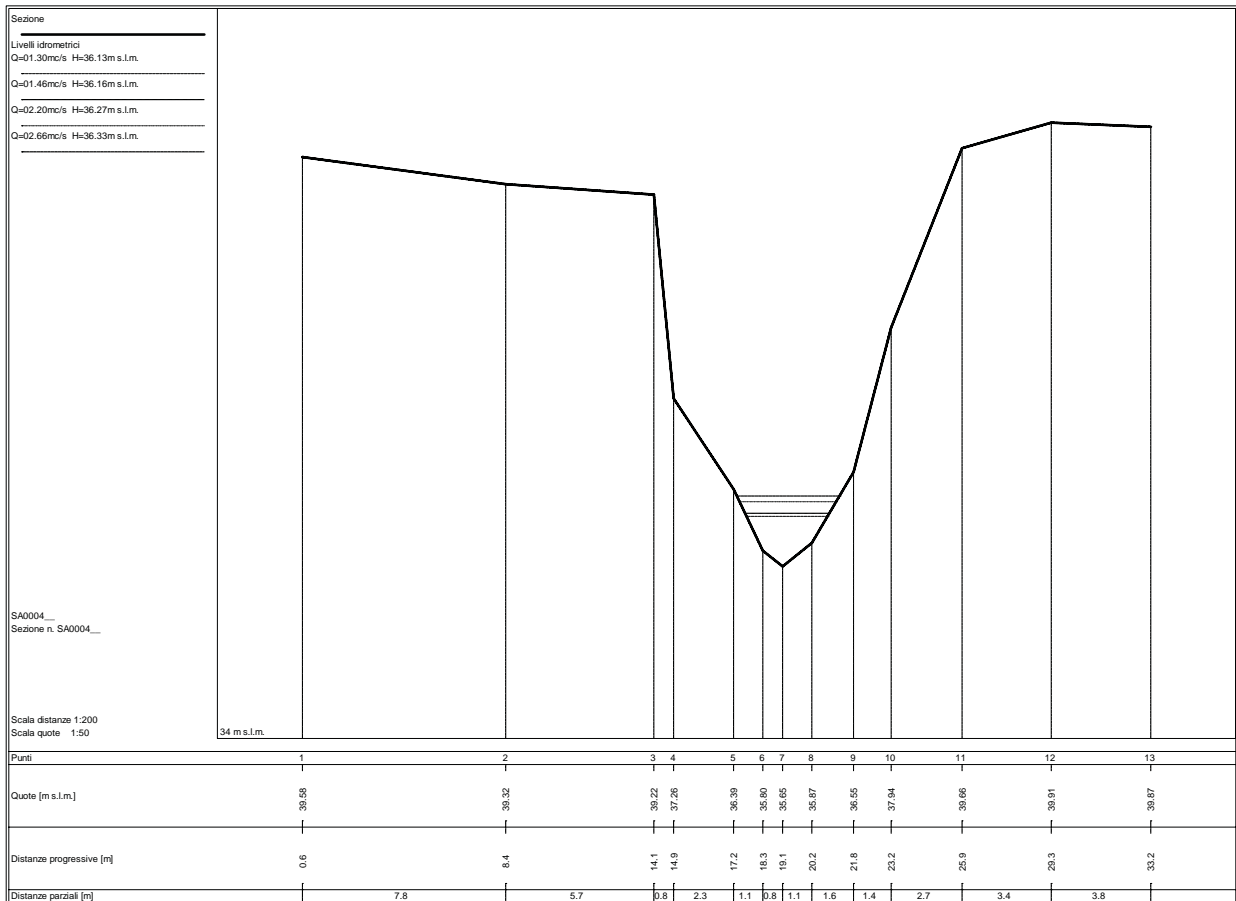
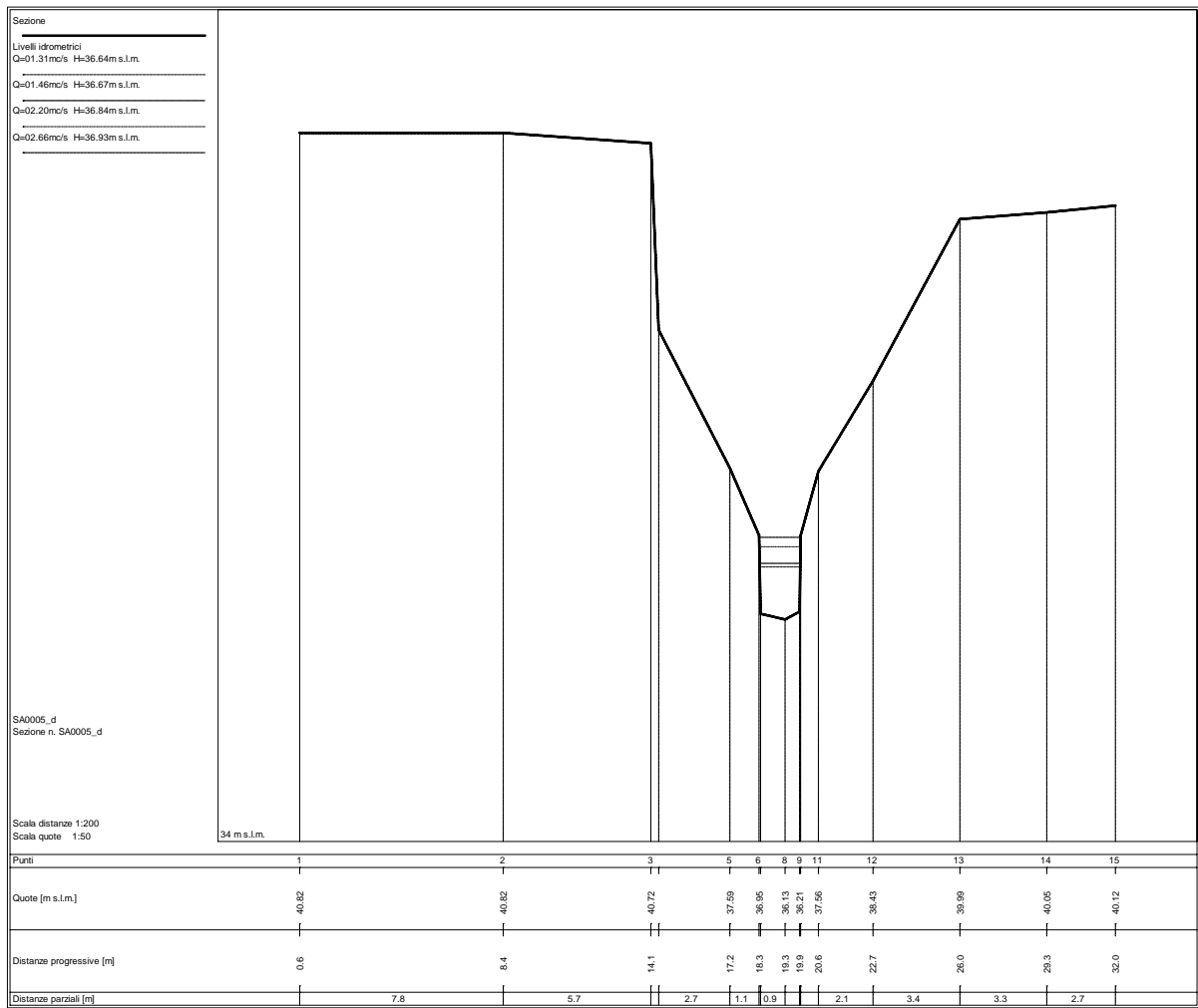

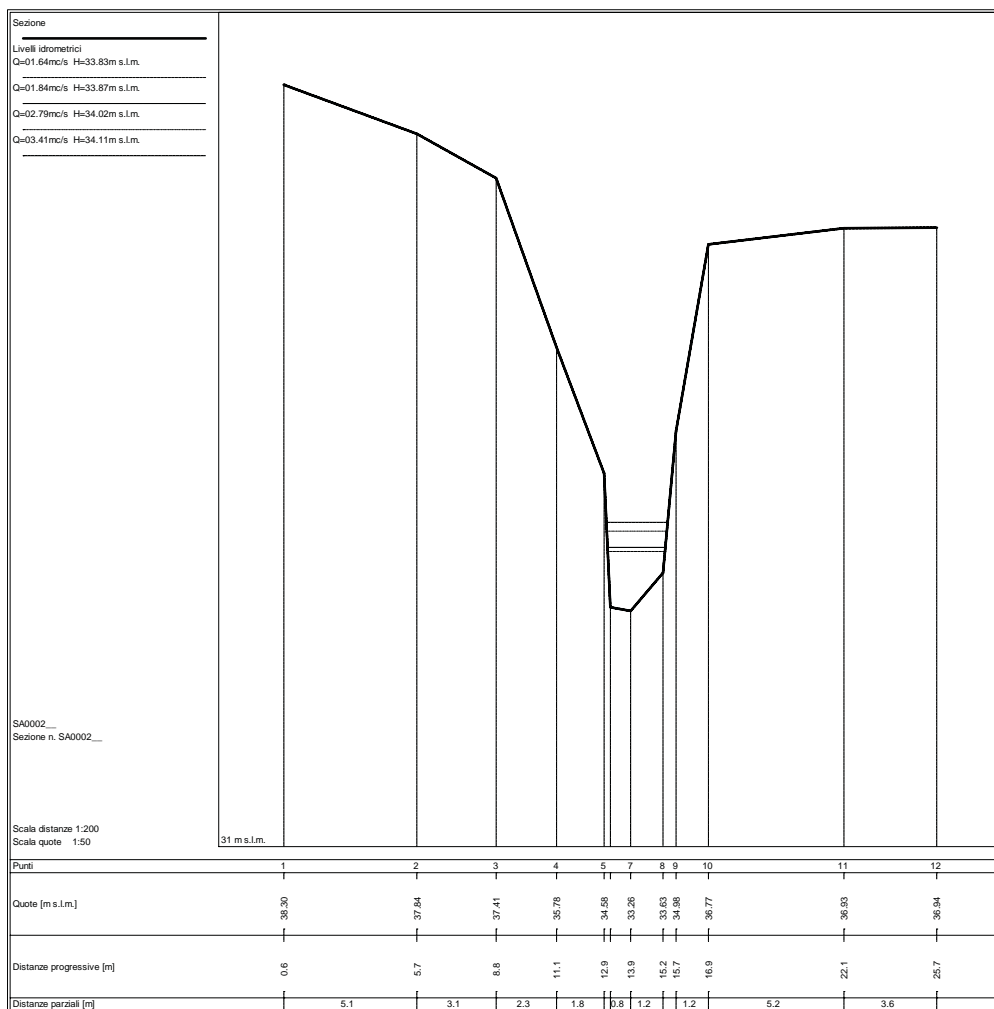
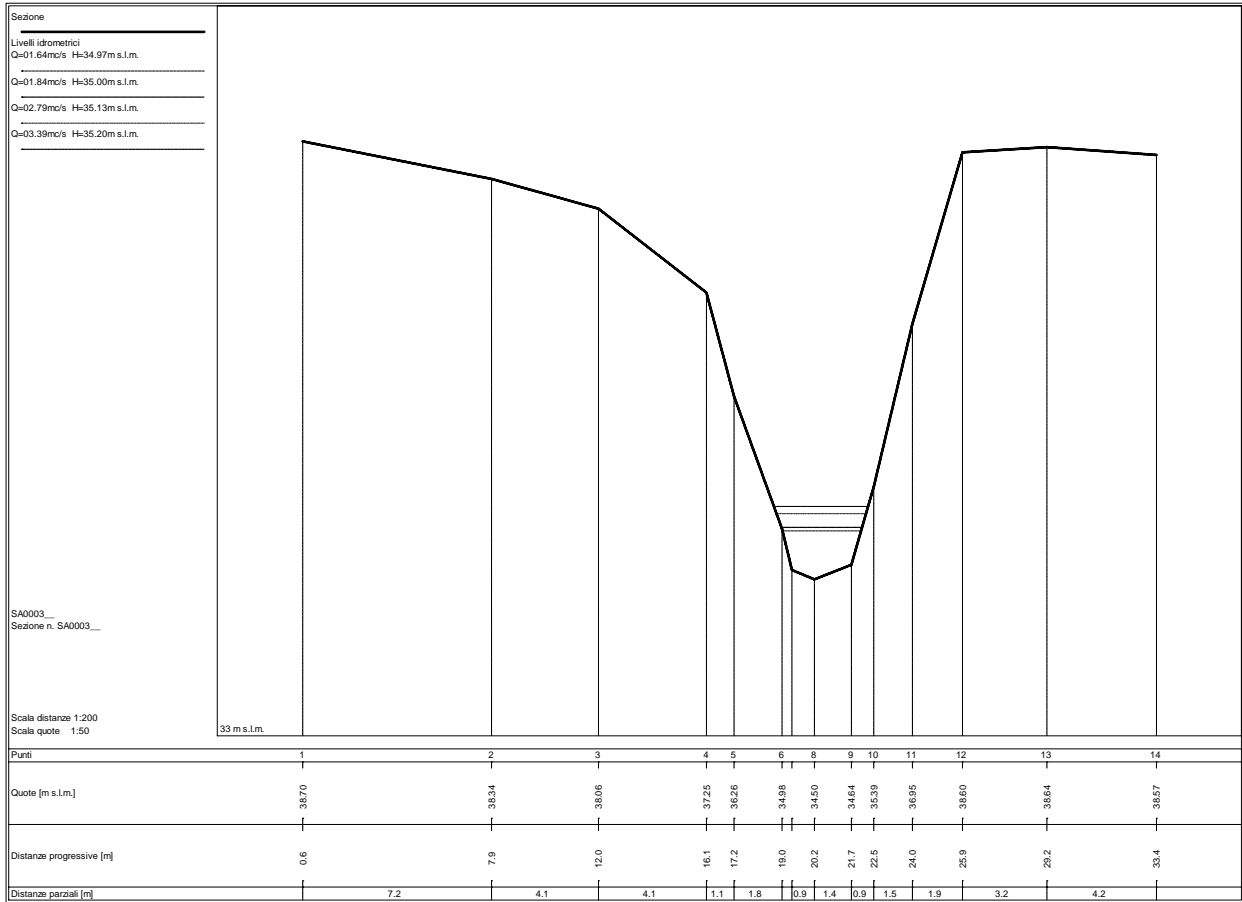

Sezione

Livelli idrometrici

Q=01.61mc/s H=32.82m s.Lm.

Q=01.82mc/s H=32.88m s.Lm.

Q=02.76mc/s H=33.07m s.Lm.

Q=03.41mc/s H=33.17m s.Lm.

SA0001_
Sezione n. SA0001_

Scala distanze 1:200
Scala quote 1:50

30 m s.l.m.

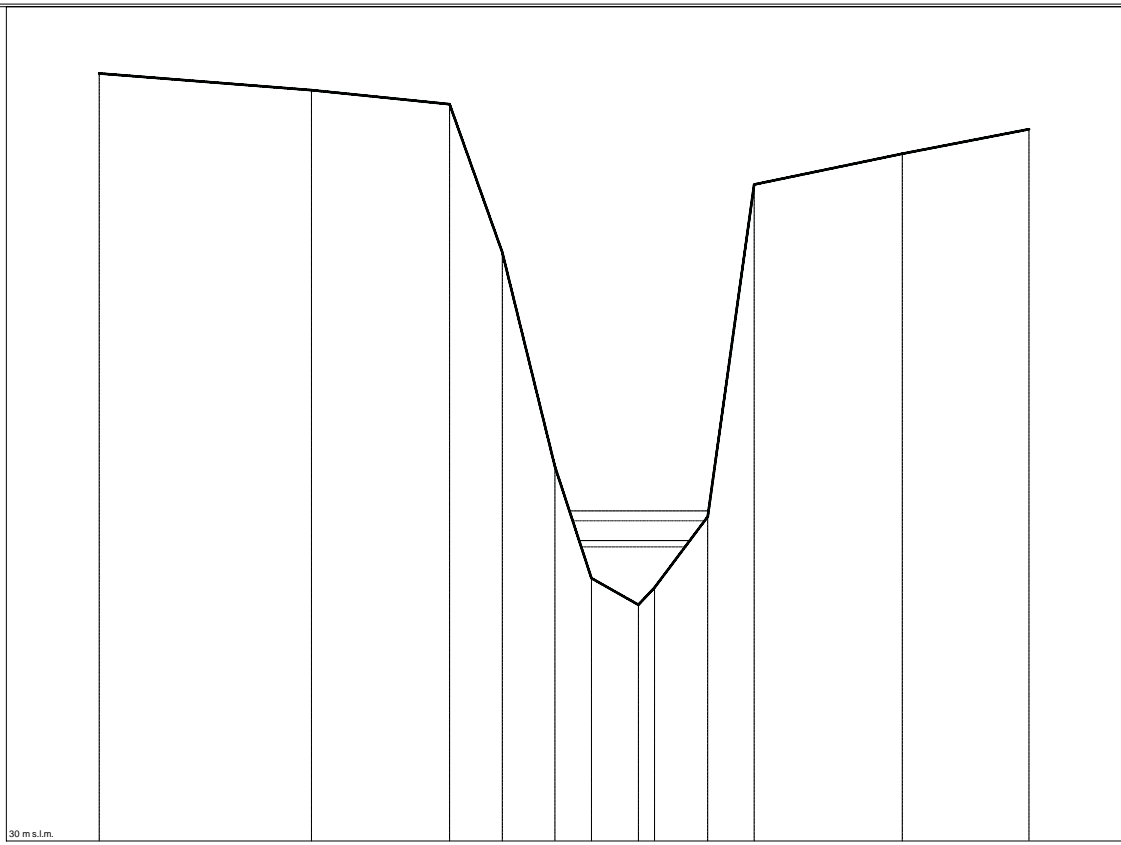

Punti	1	2	3	4	5	6	7	8	9	10	11	12
Quote [m s.l.m.]	37.36	37.20	37.06	36.64	33.59	32.62	32.27	32.43	33.11	36.30	36.59	36.82
Distanze progressive [m]	0.6	8.8	14.1	16.1	18.1	19.5	21.3	21.9	24.0	25.7	31.4	36.3
Distanze parziali [m]		8.1	5.3	2.0	2.0	1.4	1.8	2.0	1.8	5.7	4.9	

STATO ATTUALE

Sezioni fluviali fosso Castagnara

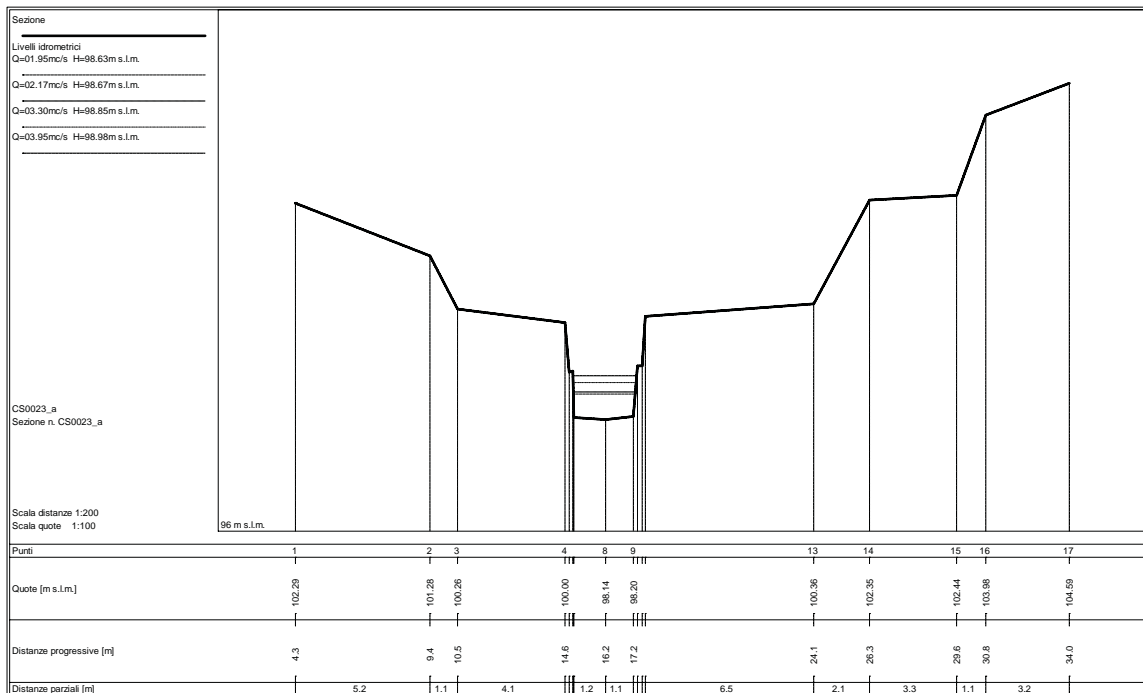
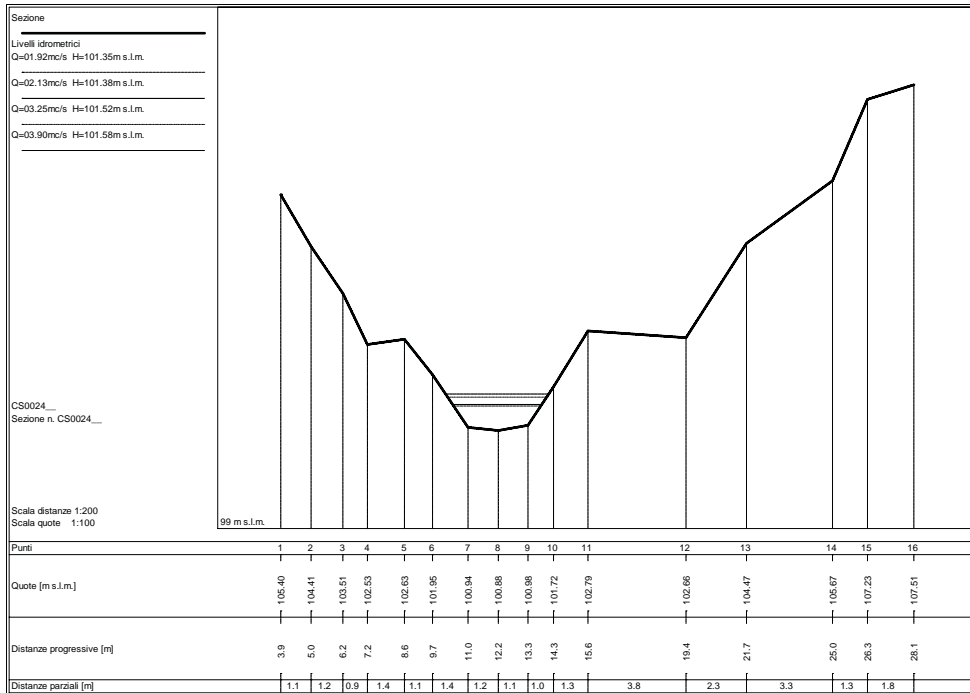

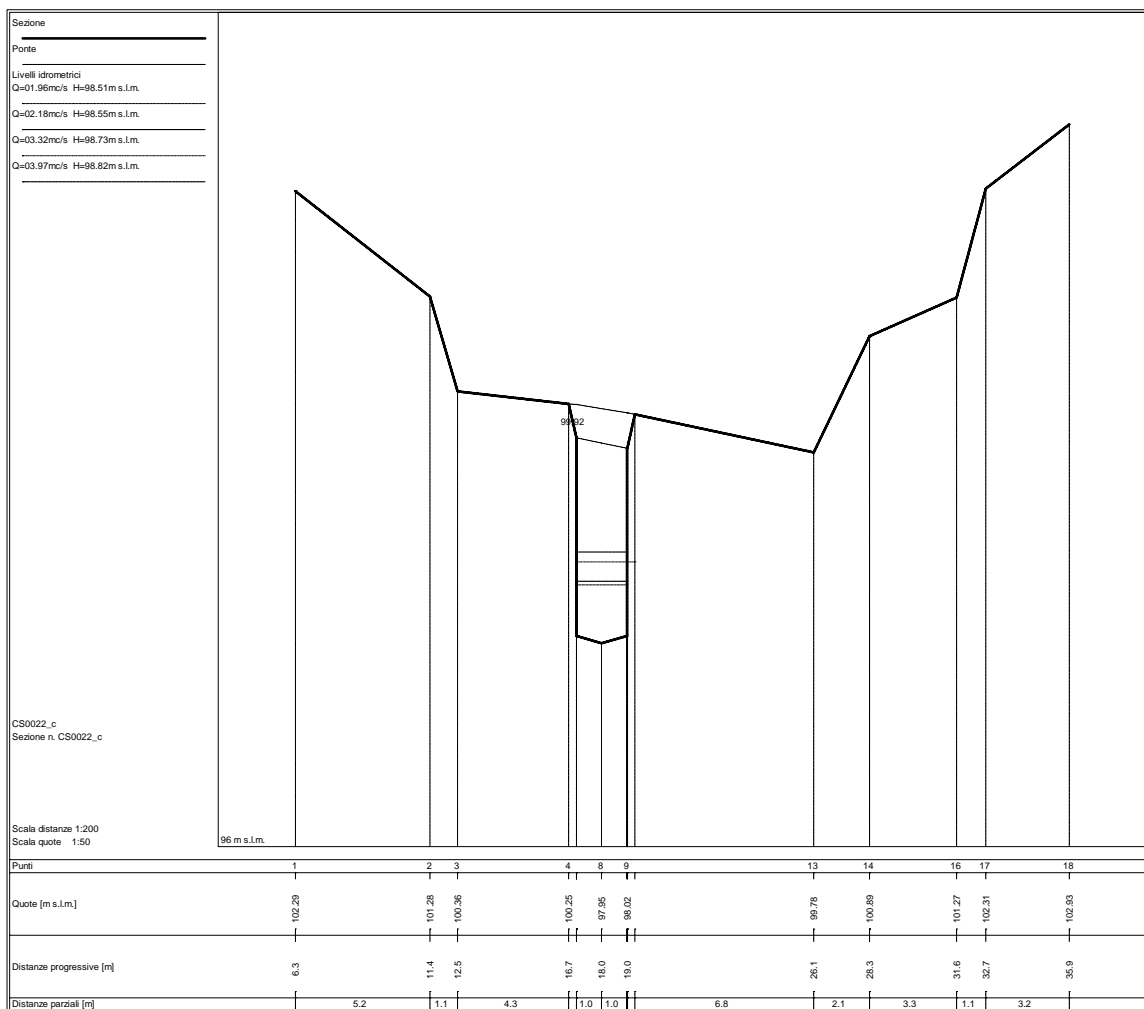
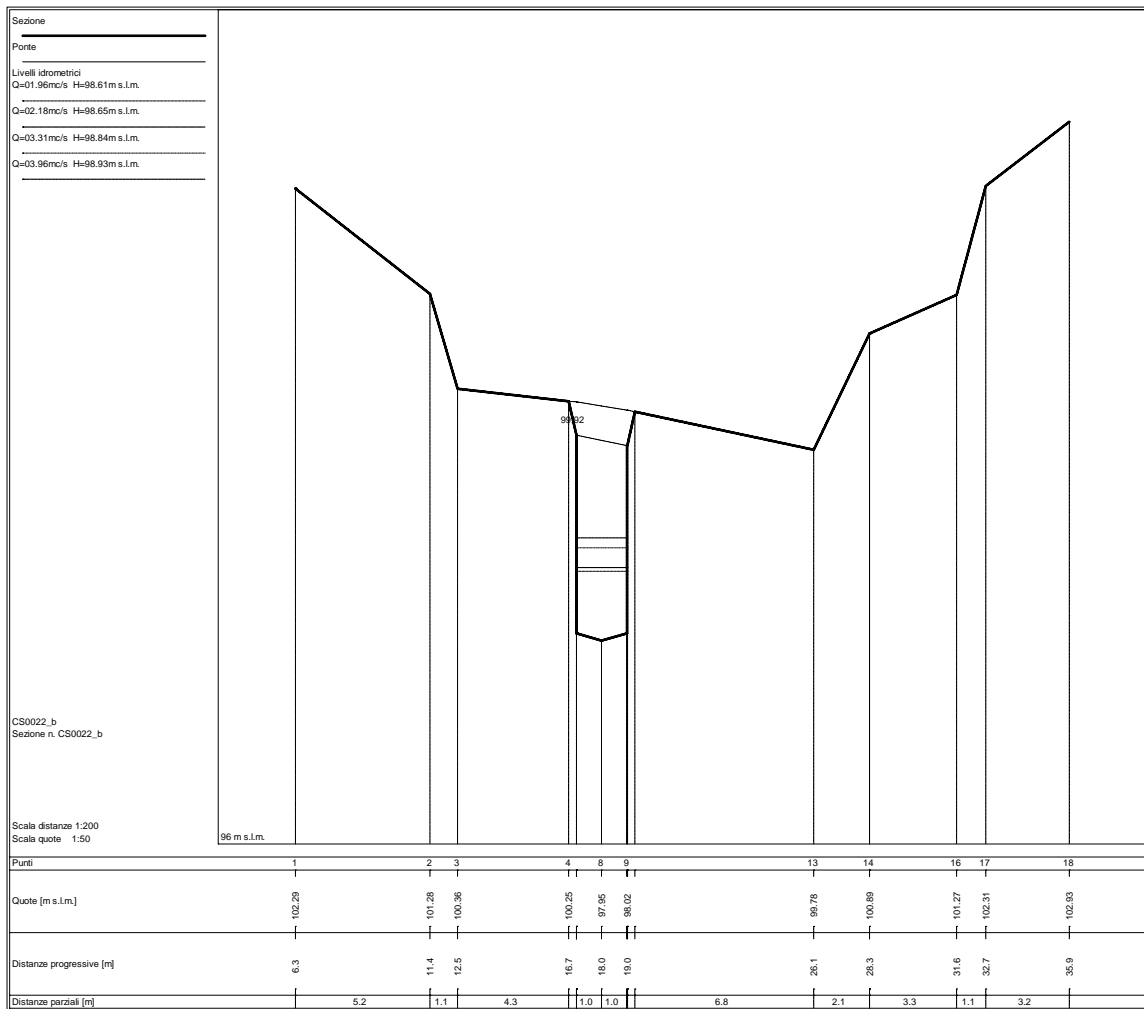

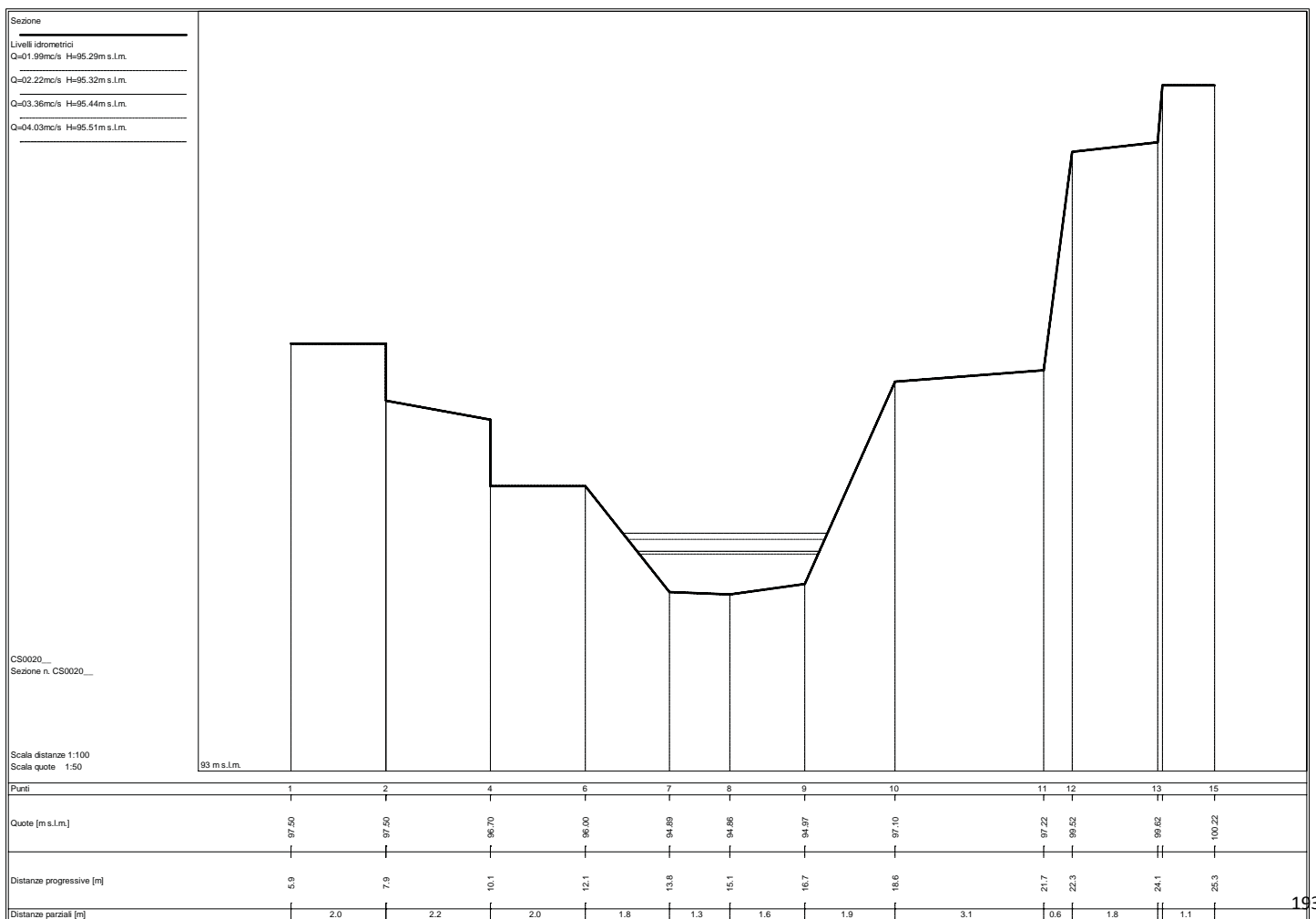
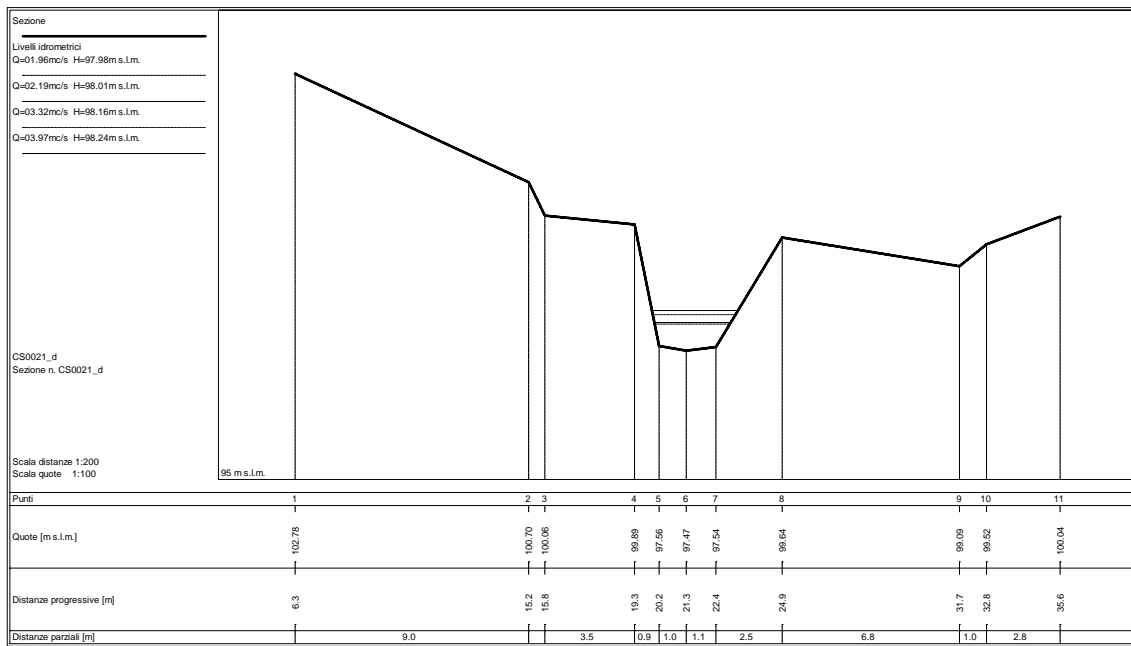

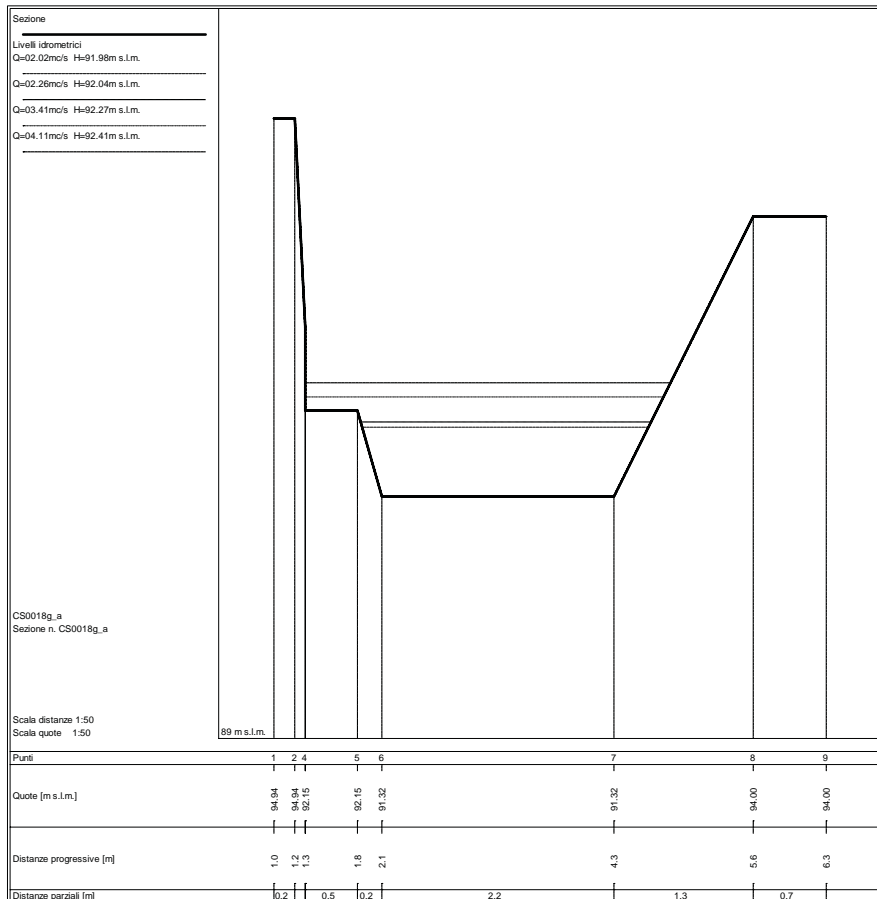
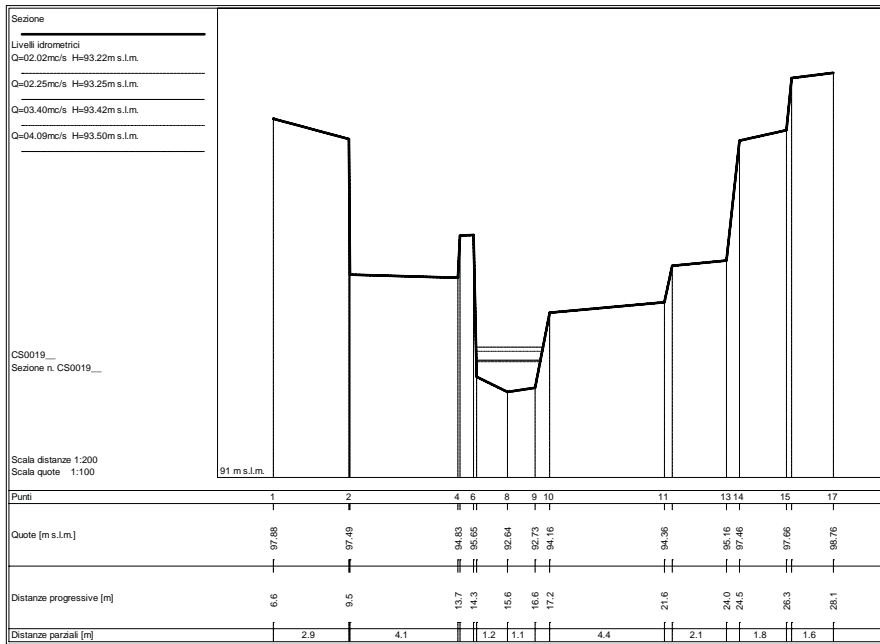

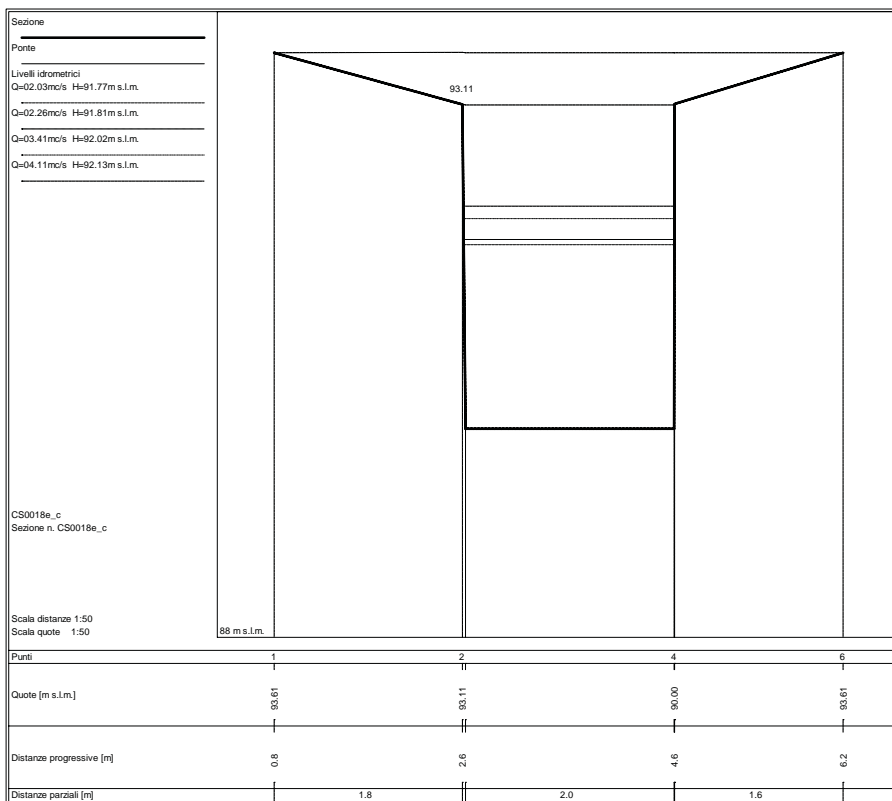
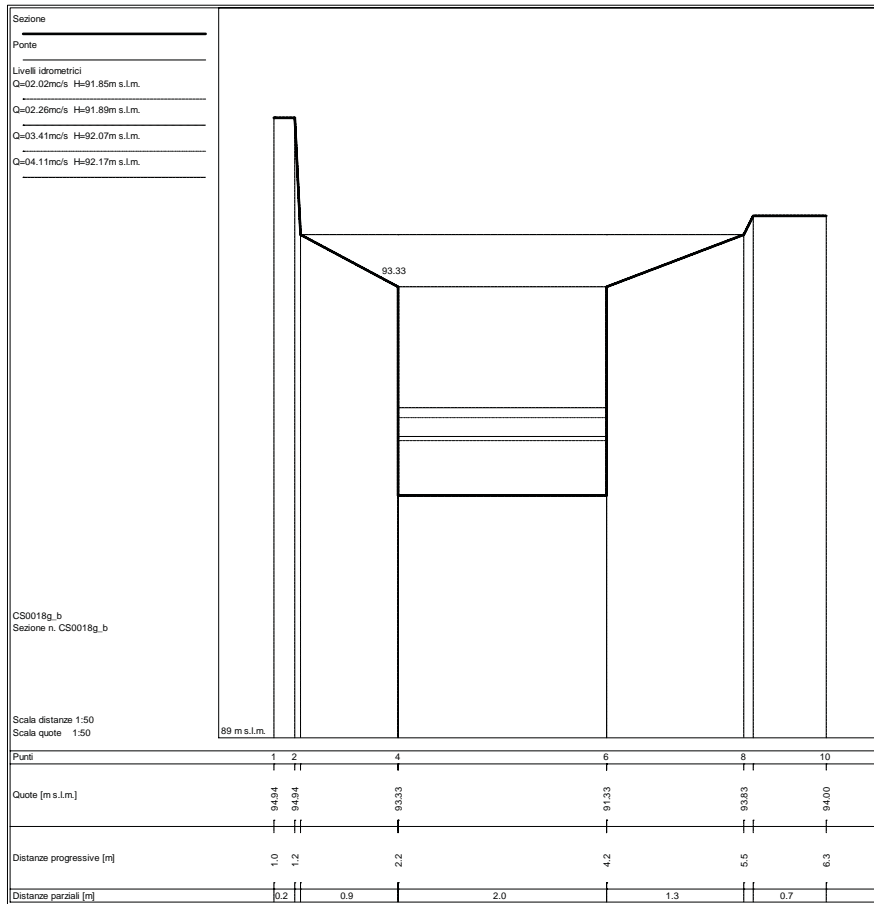

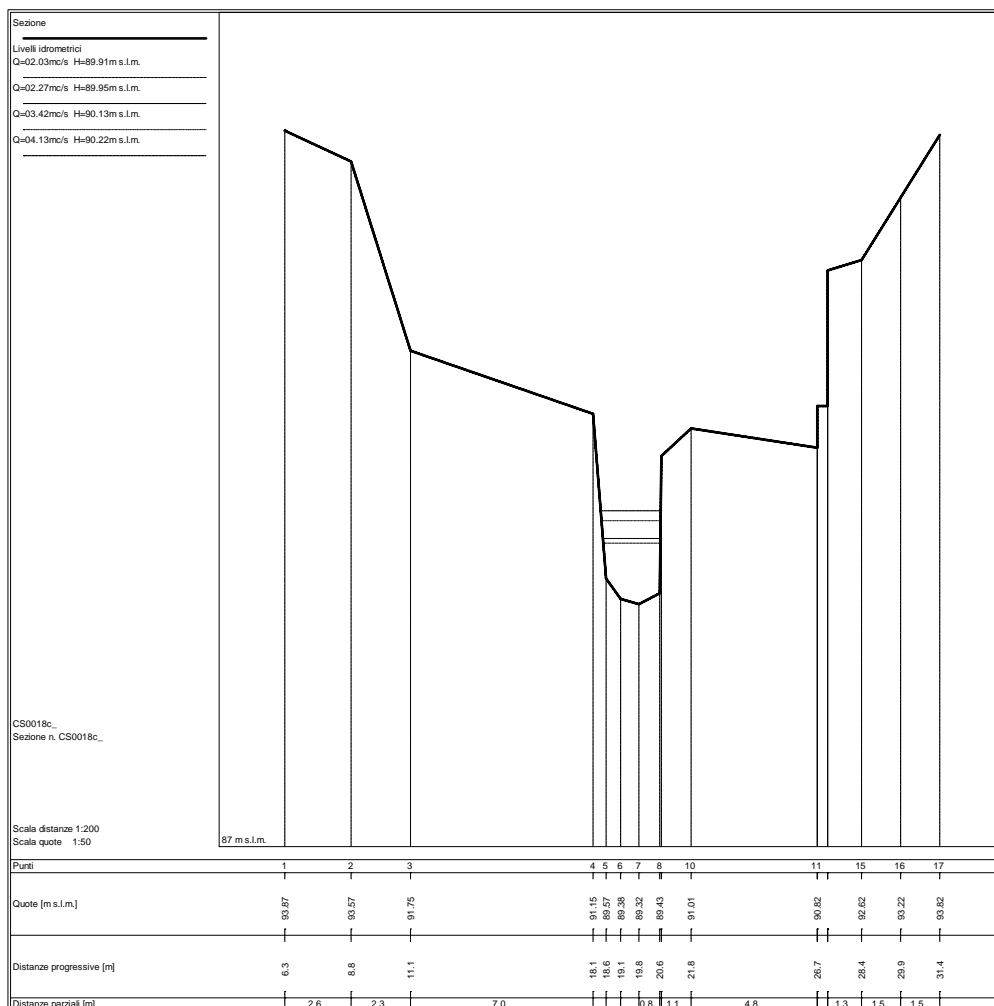
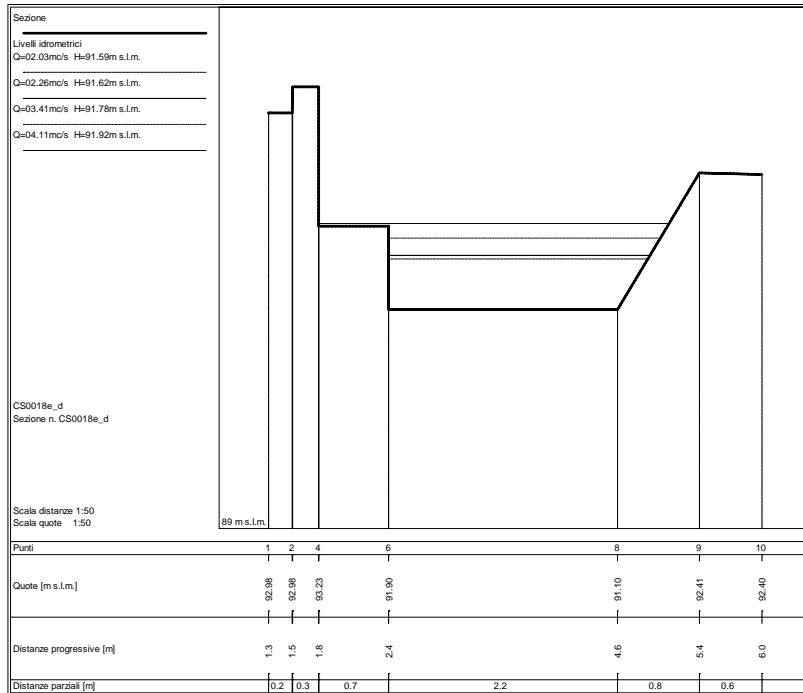

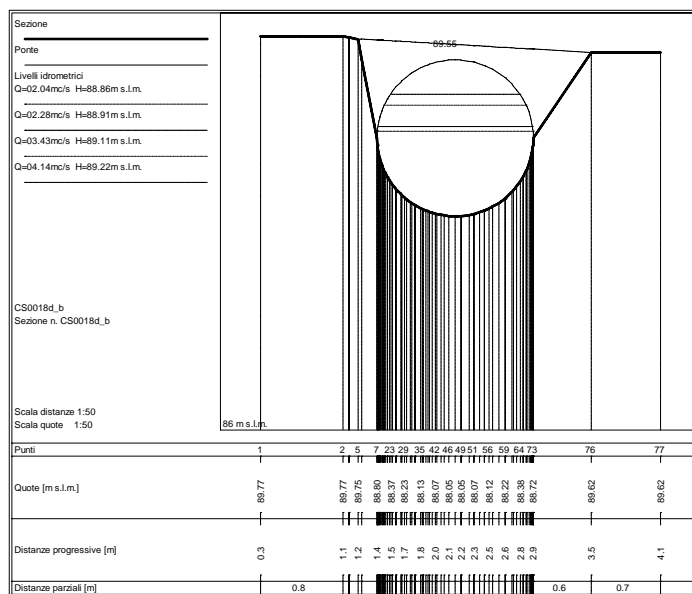
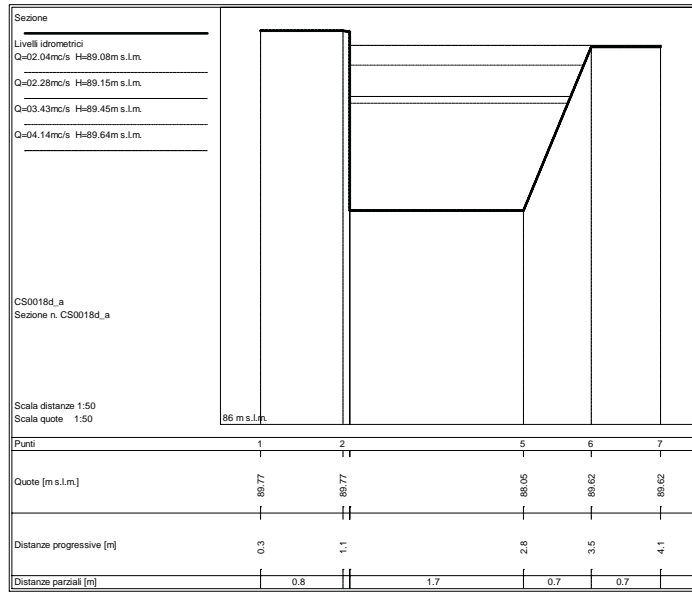

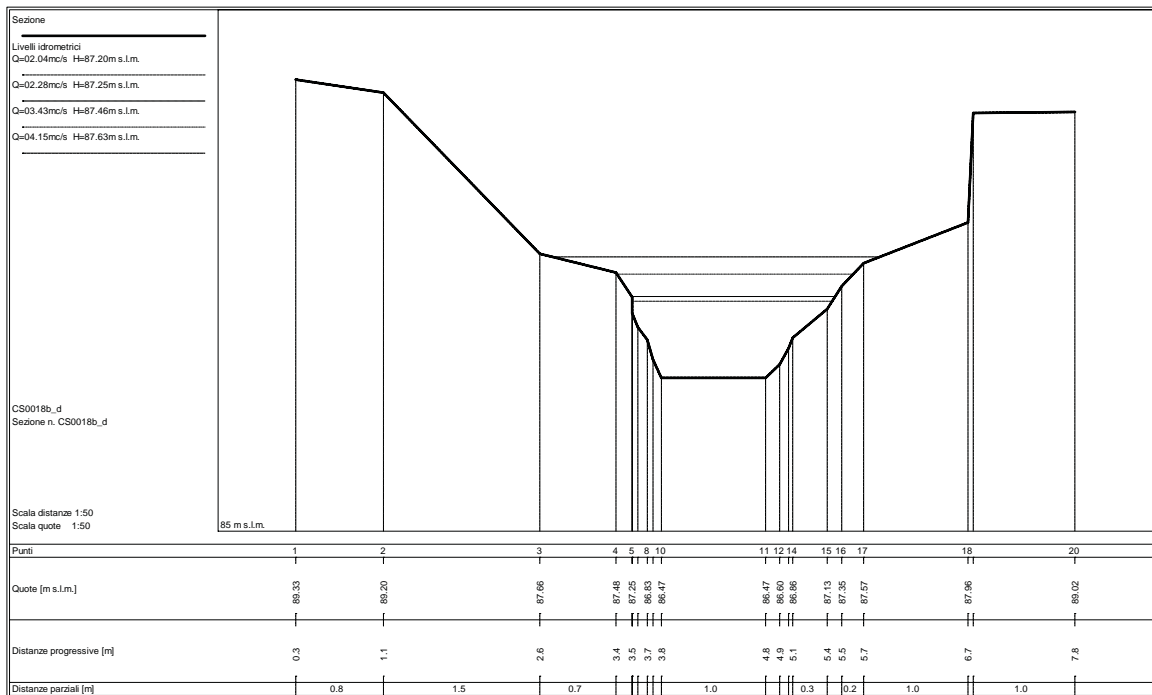
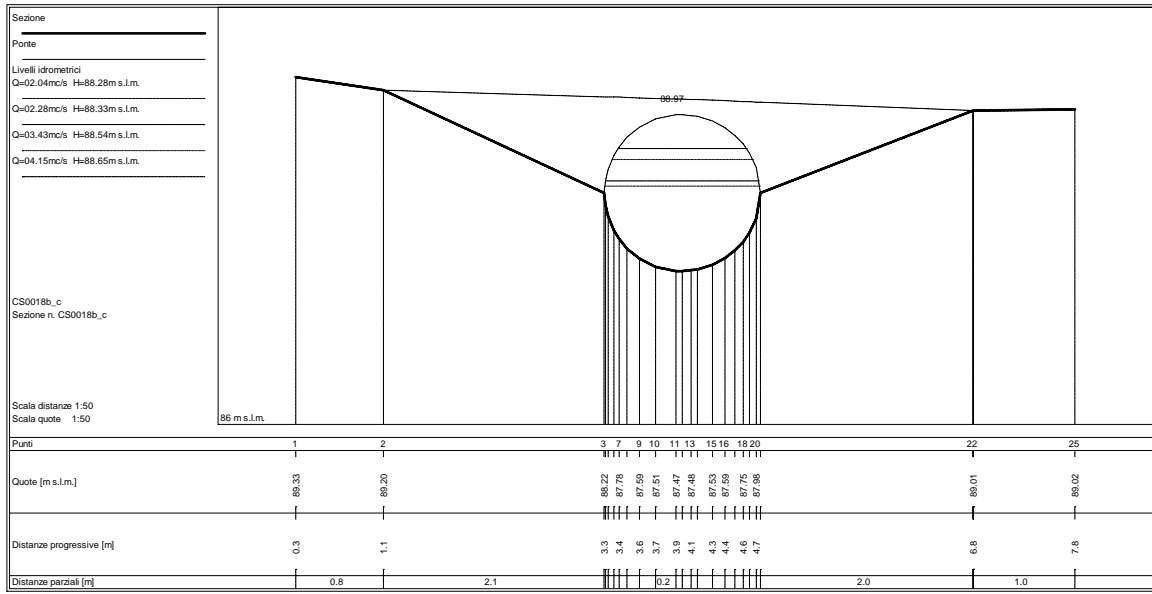

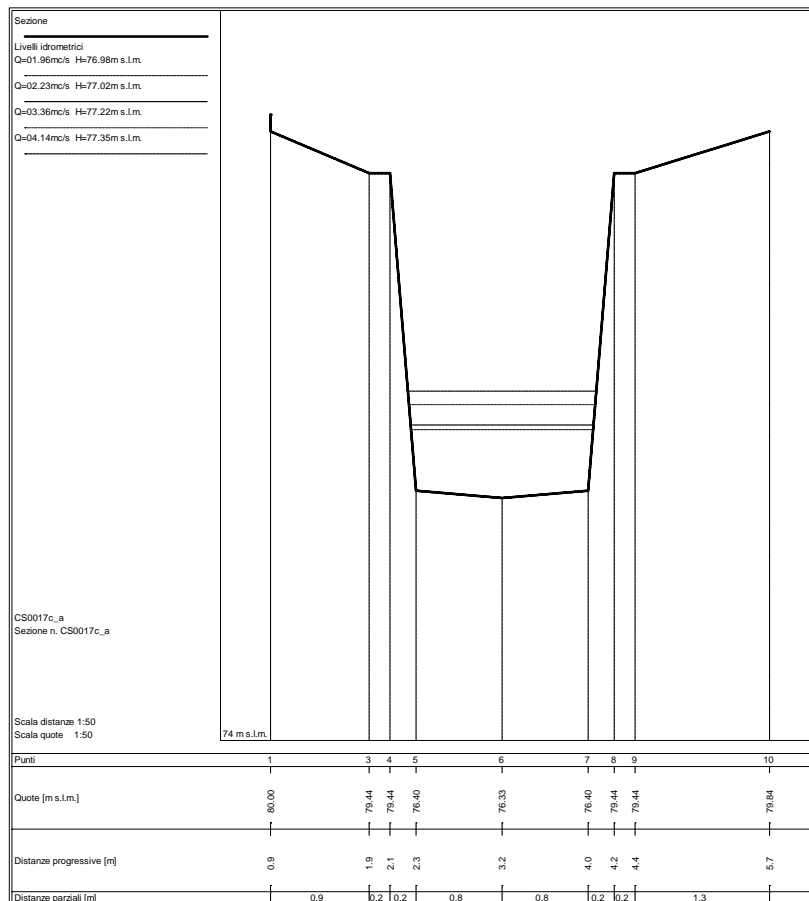
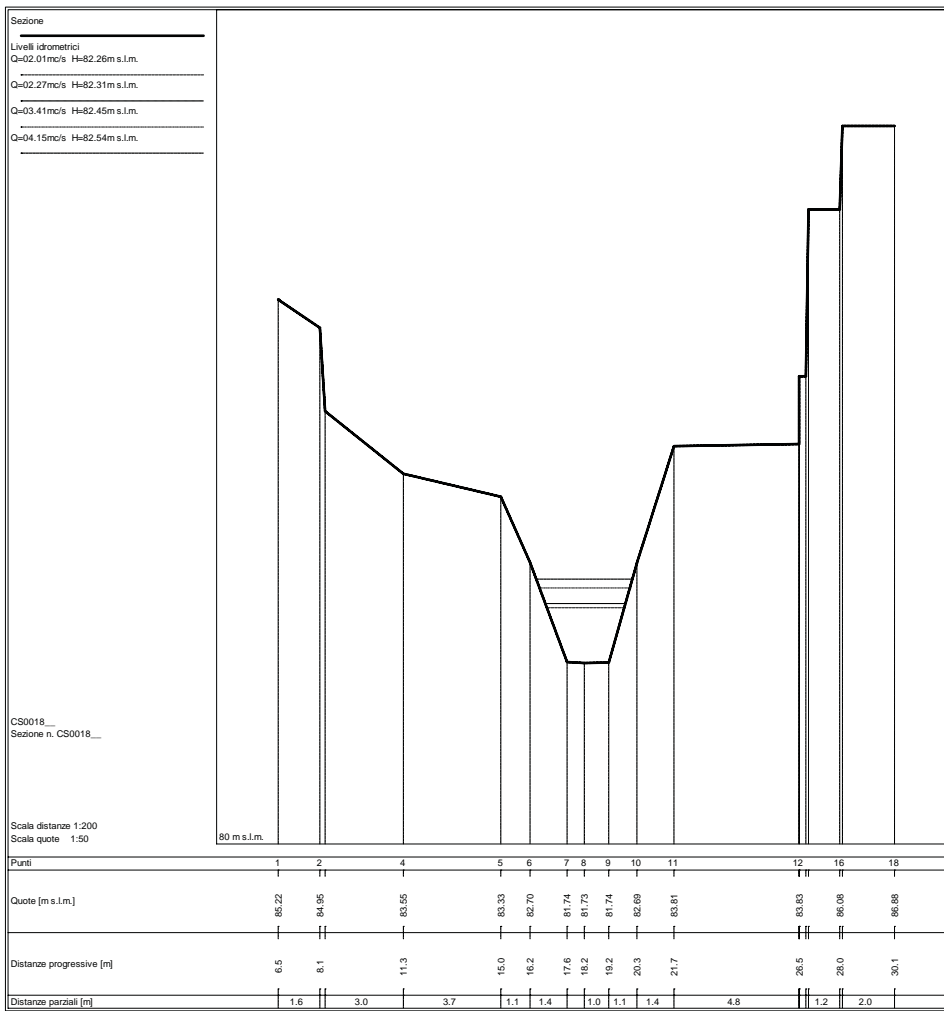

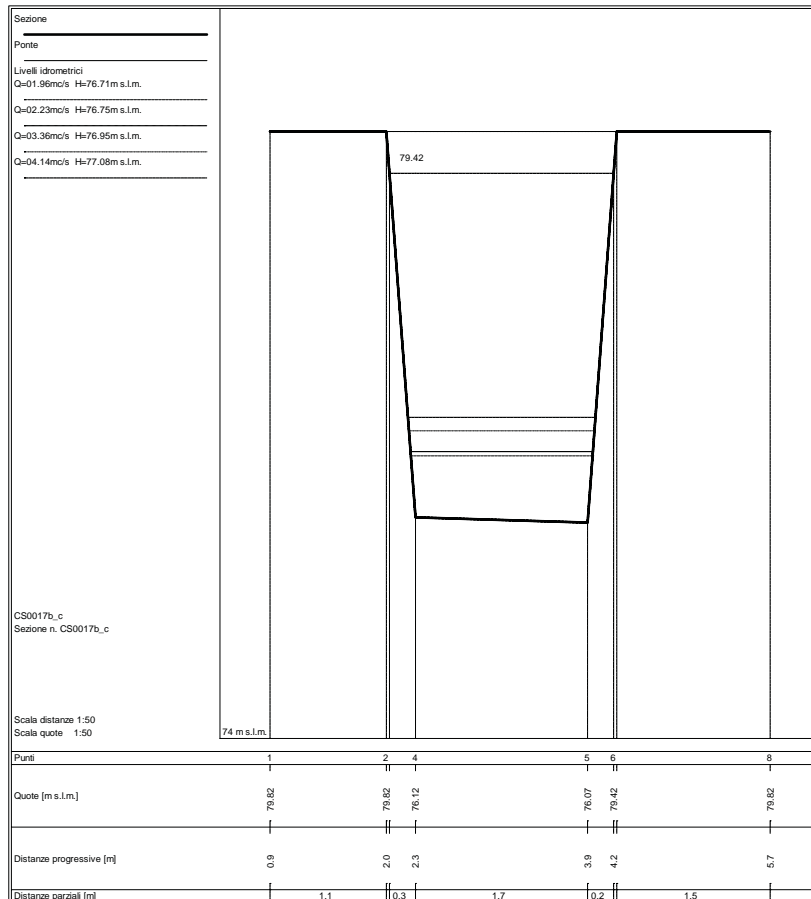
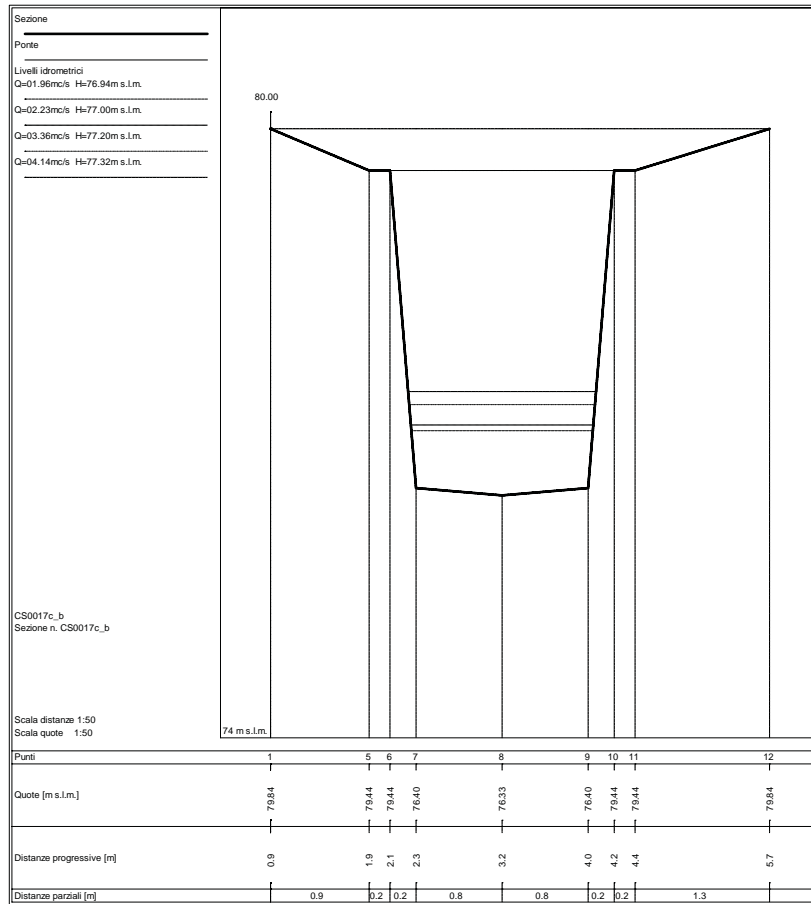

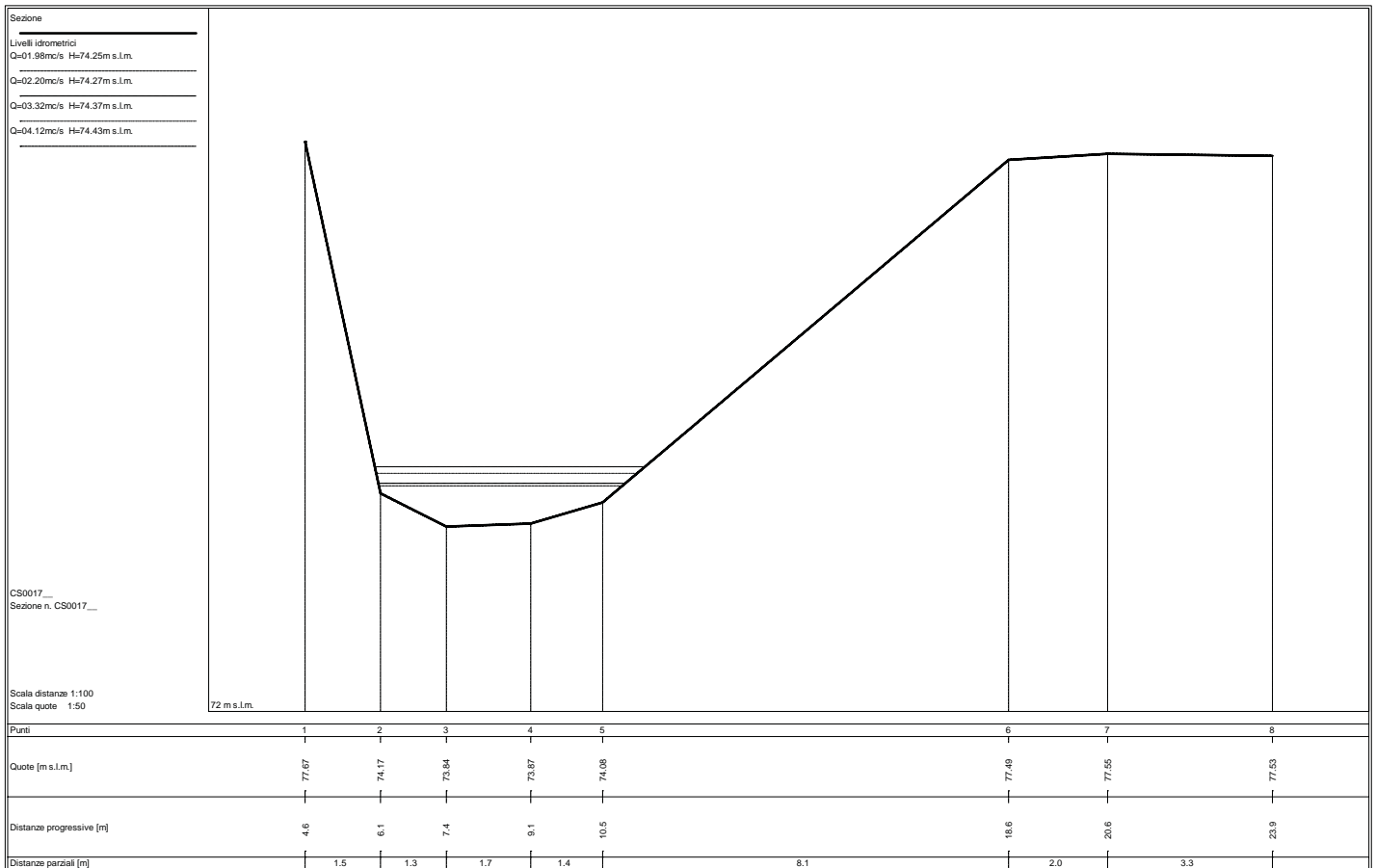
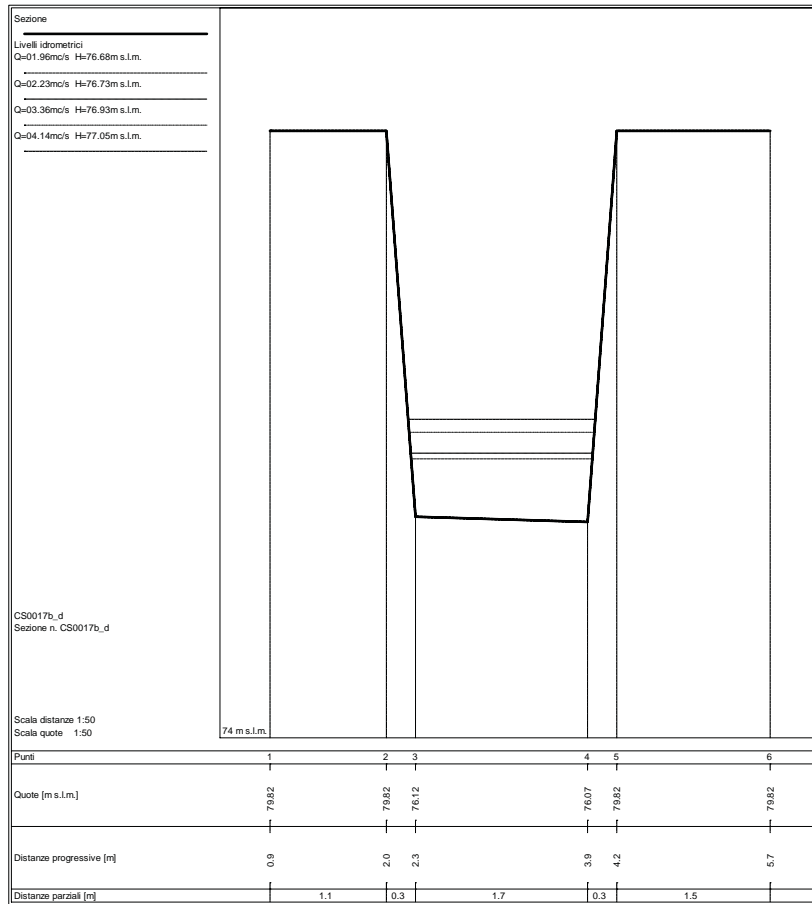

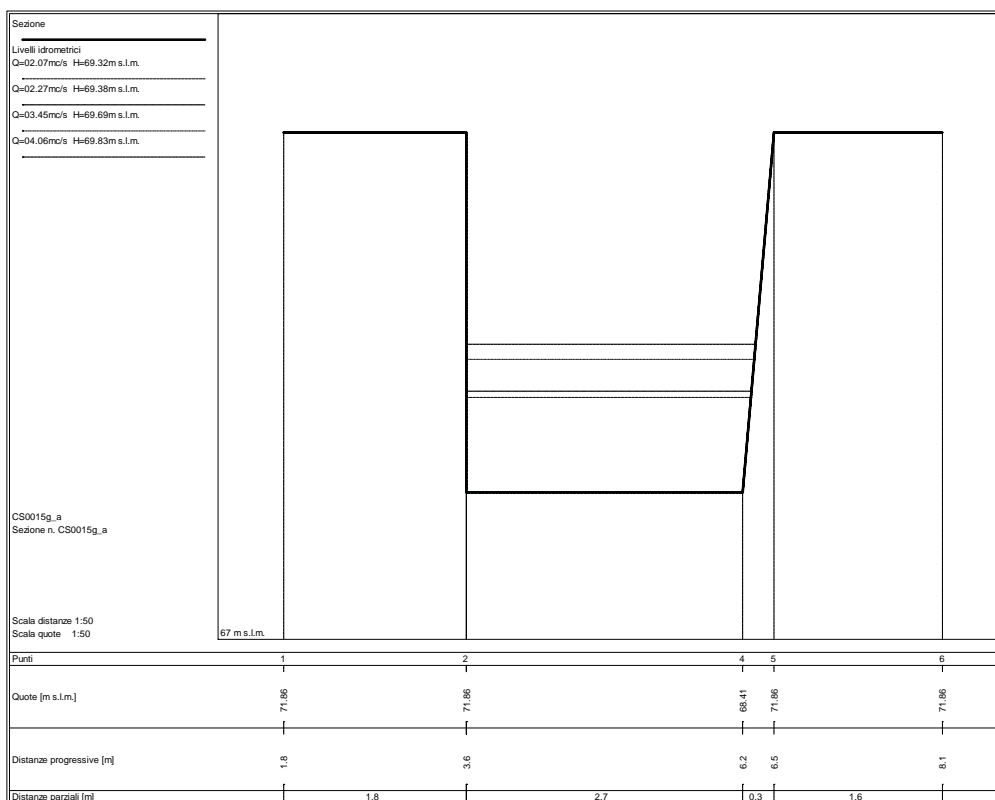
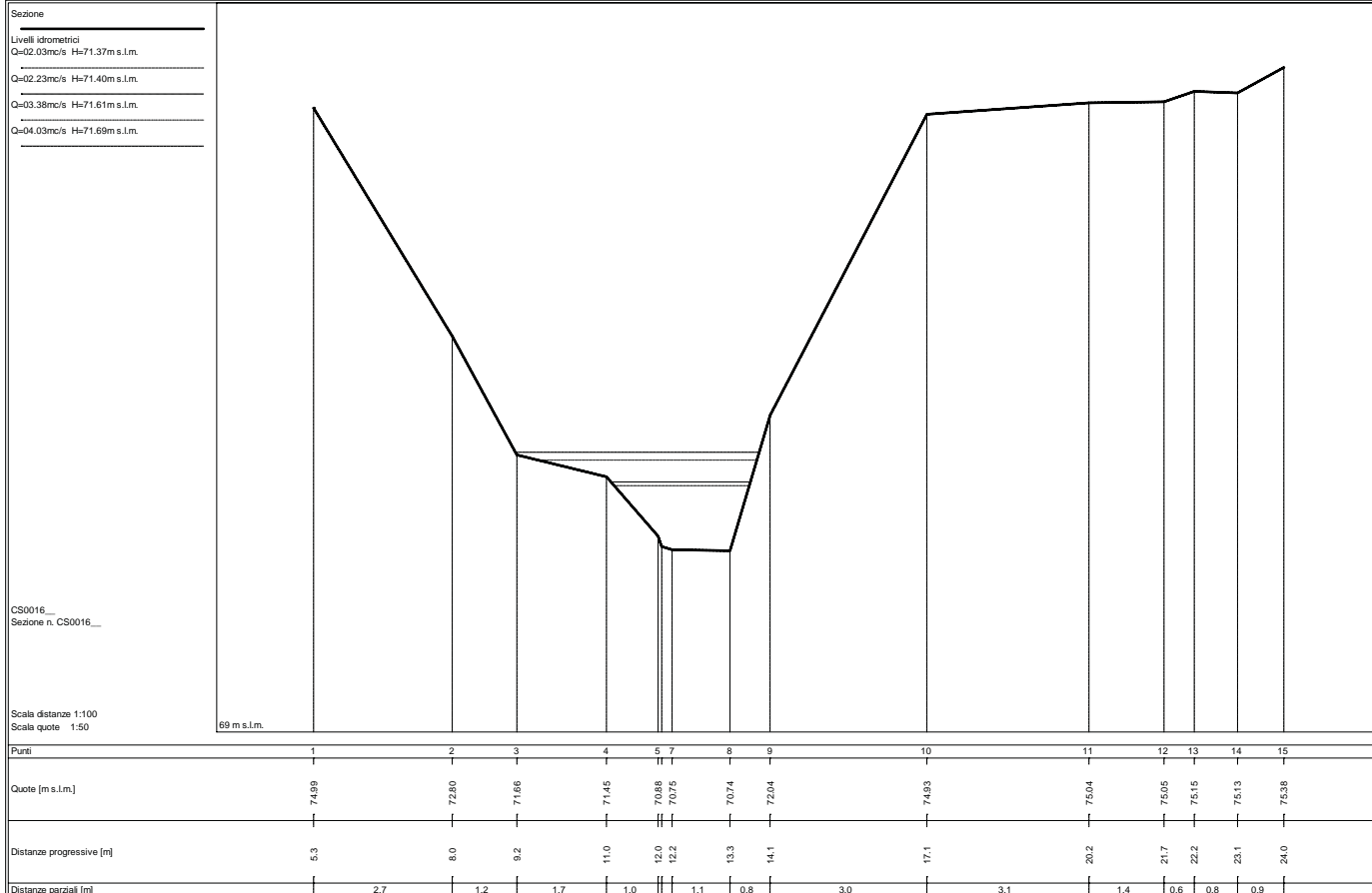

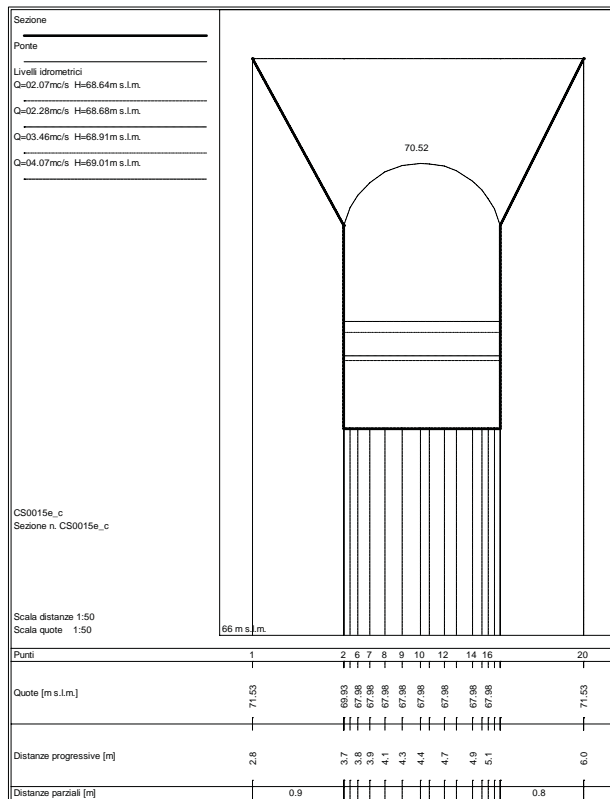
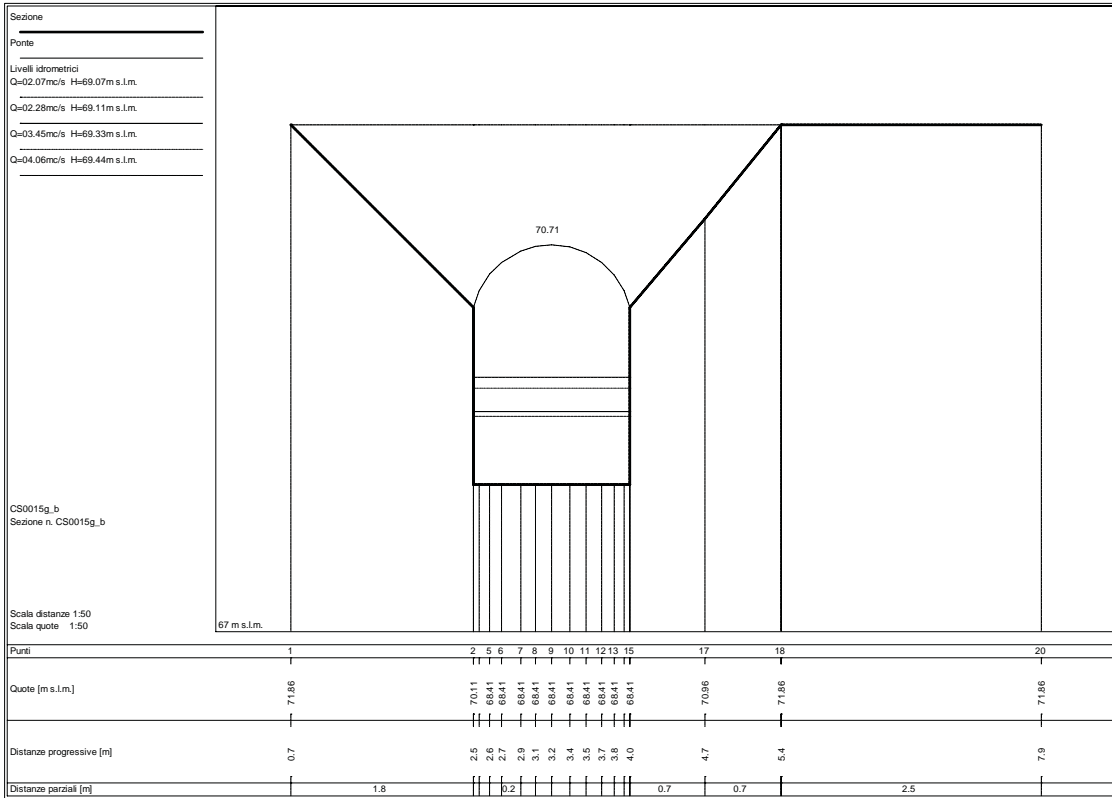

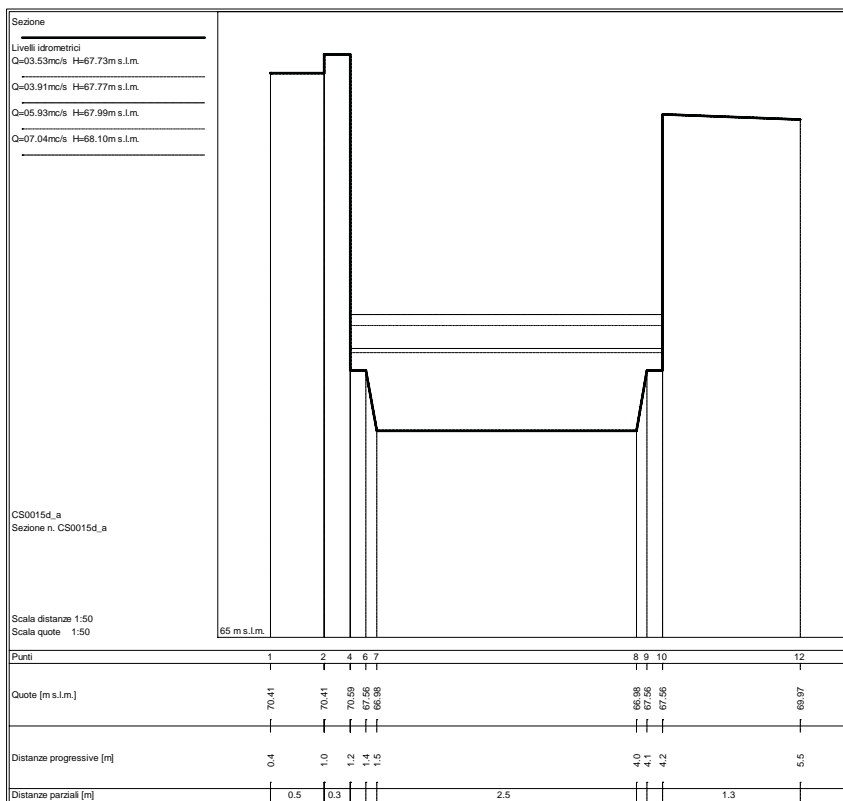
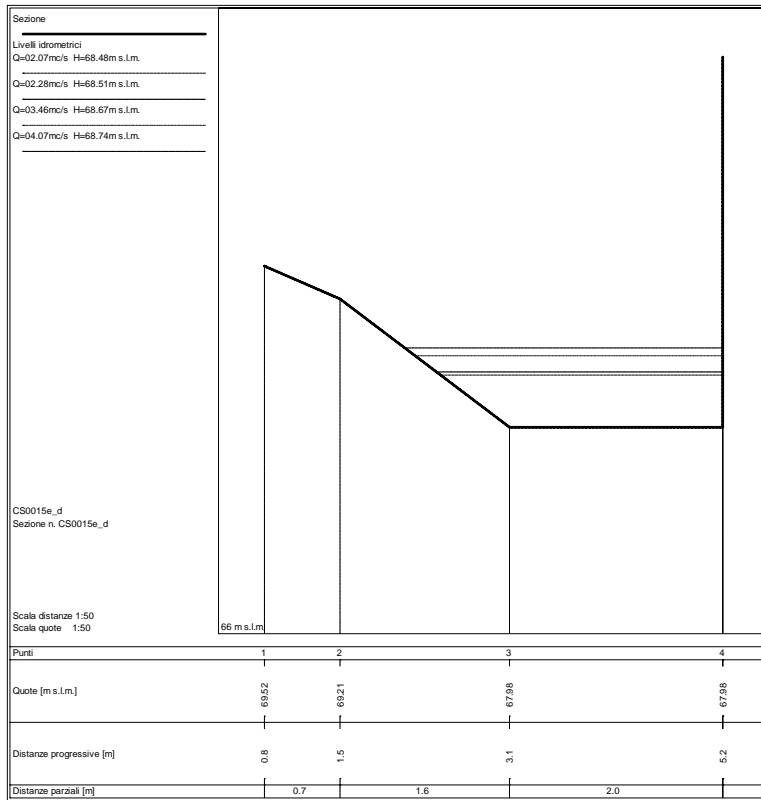

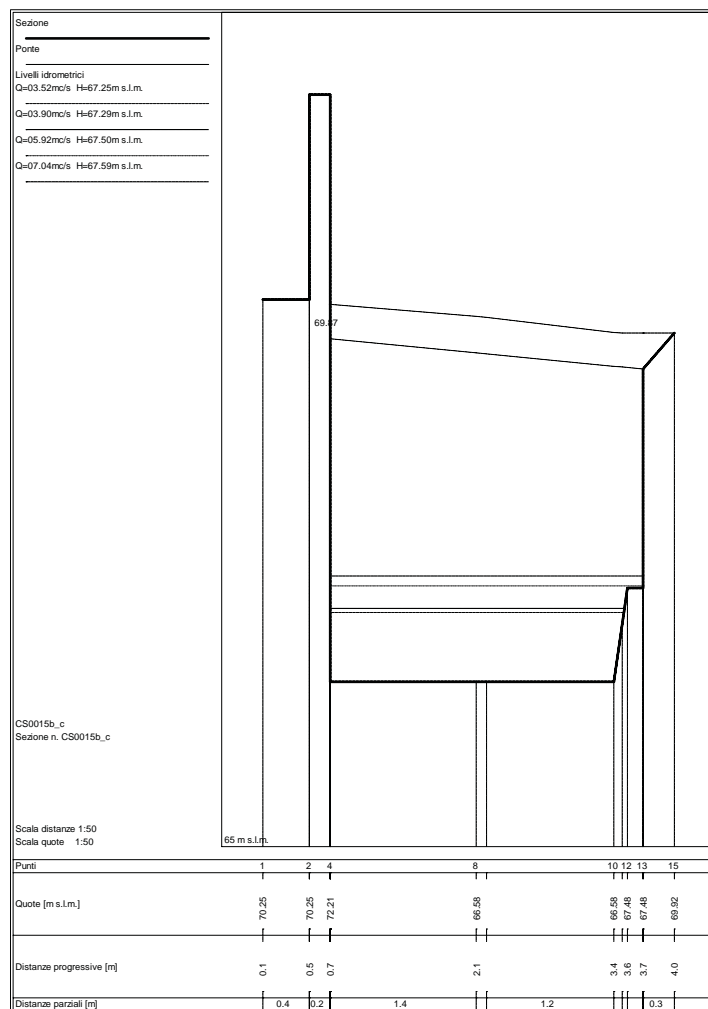
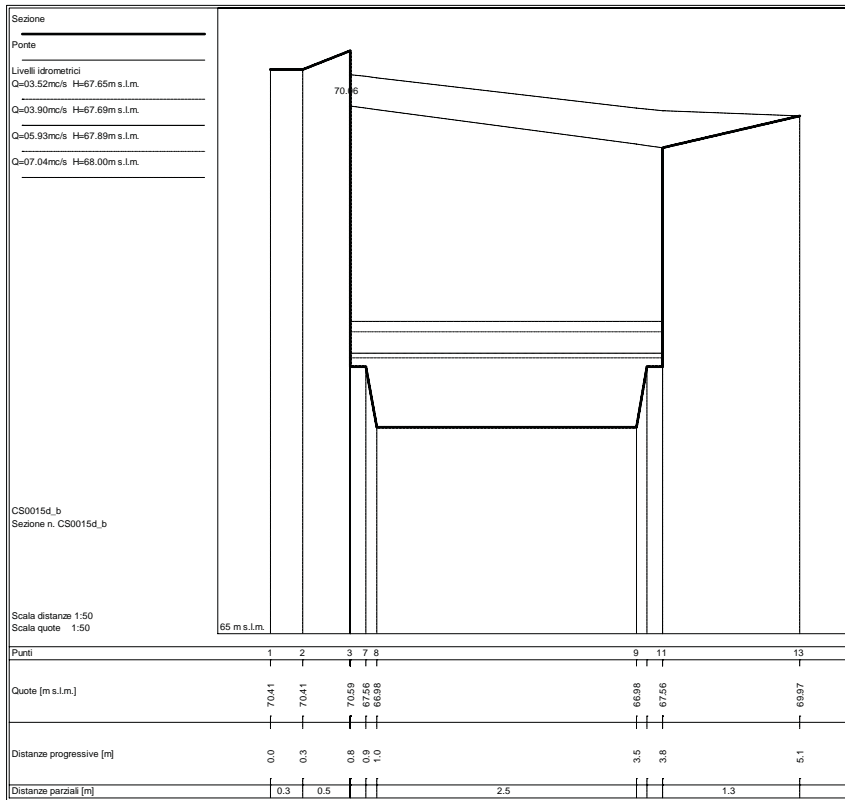

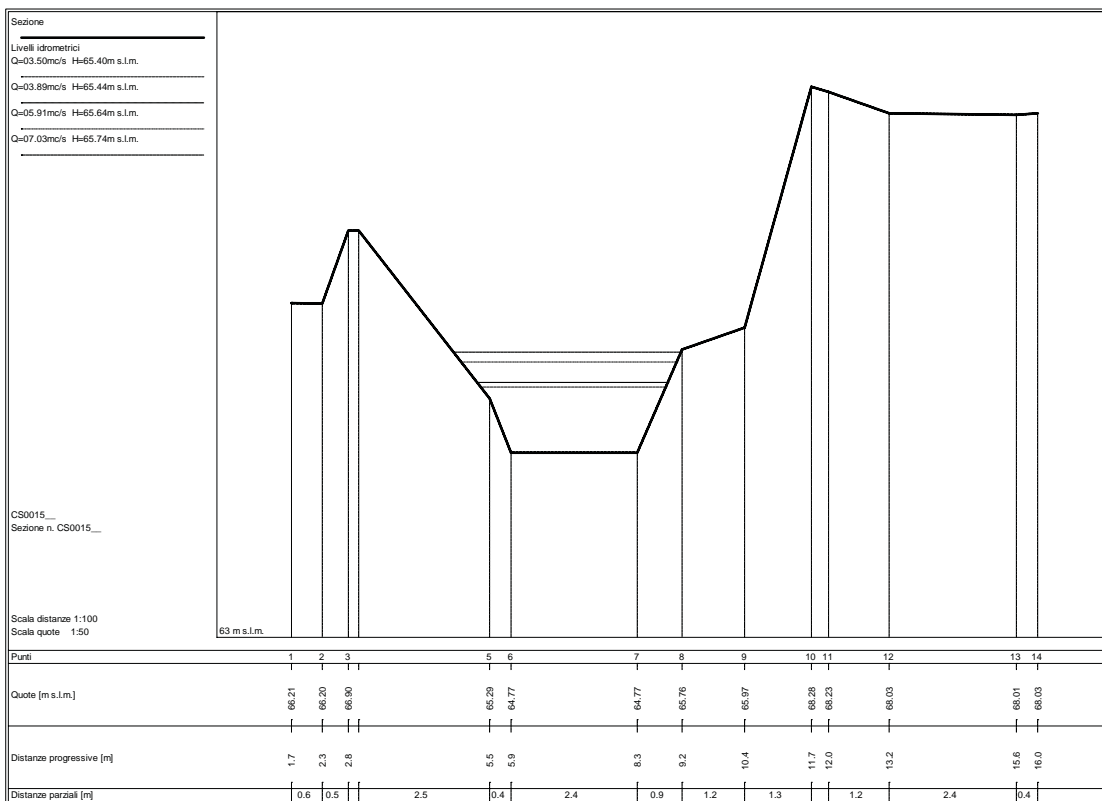
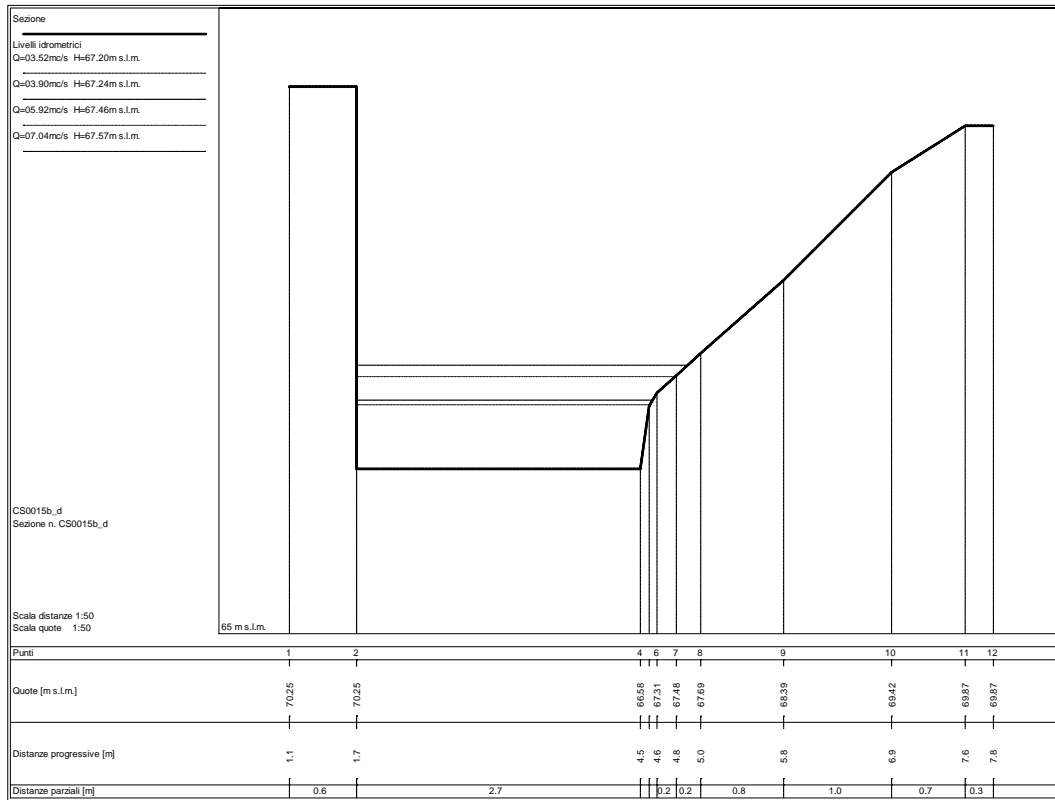

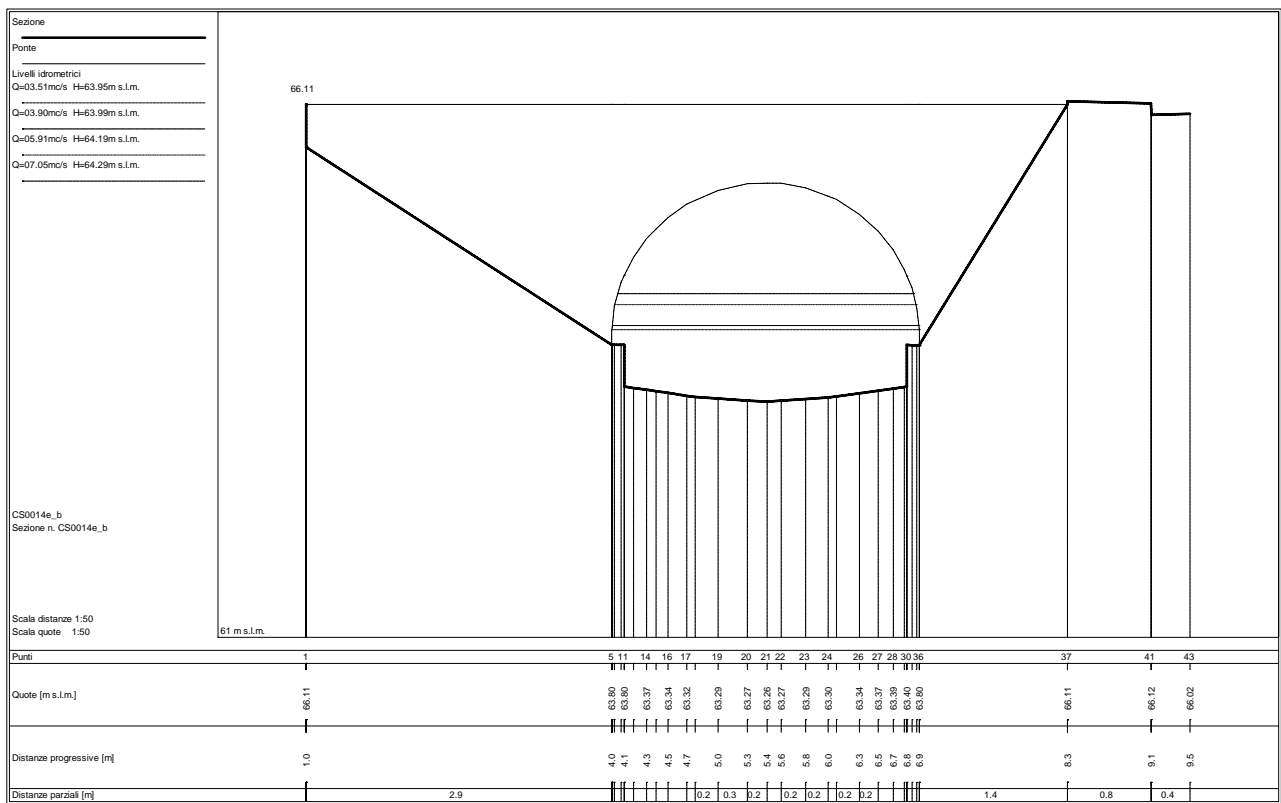
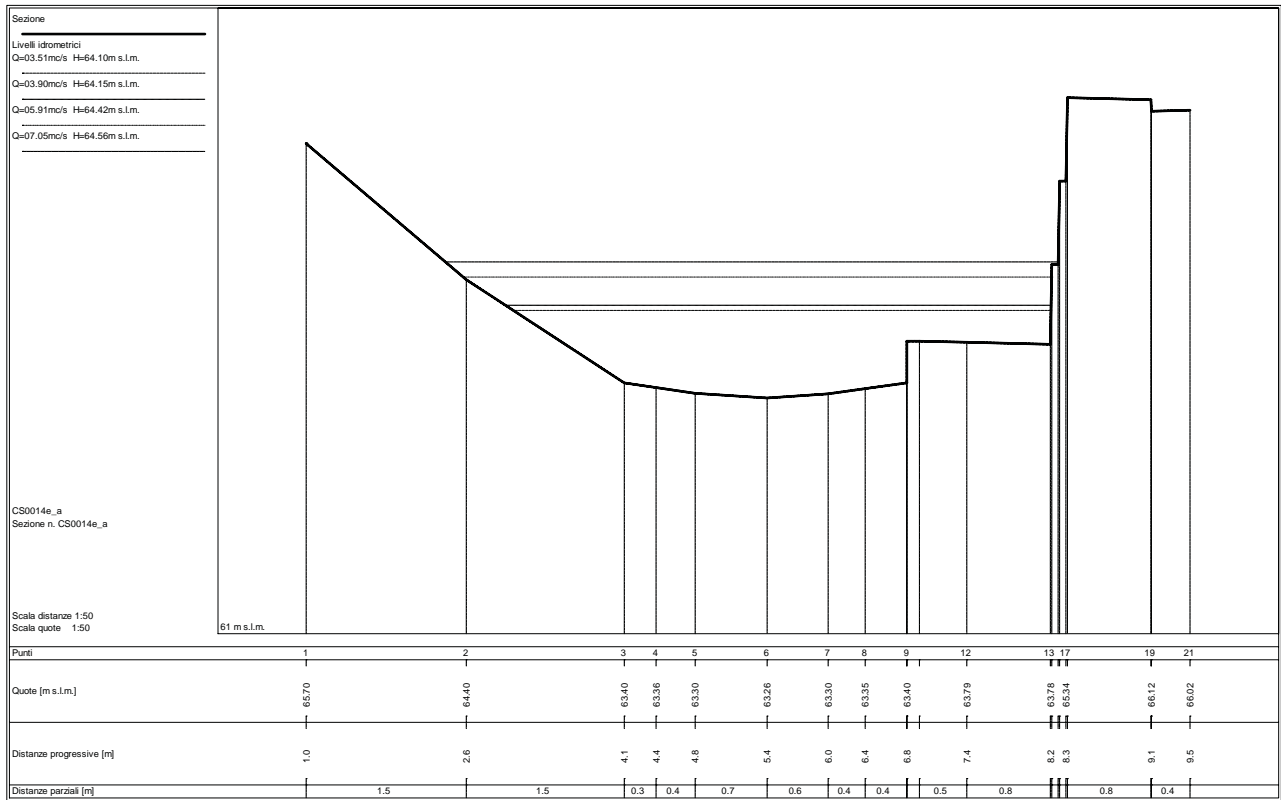

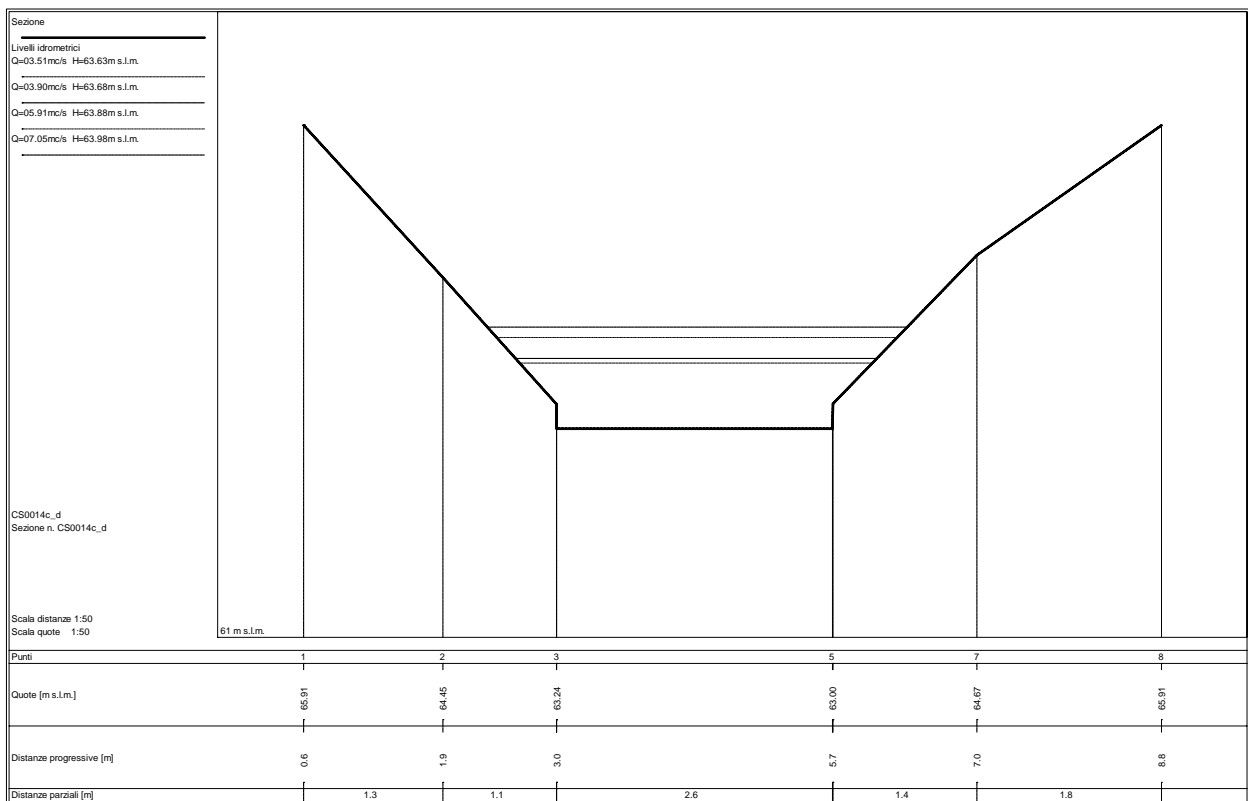
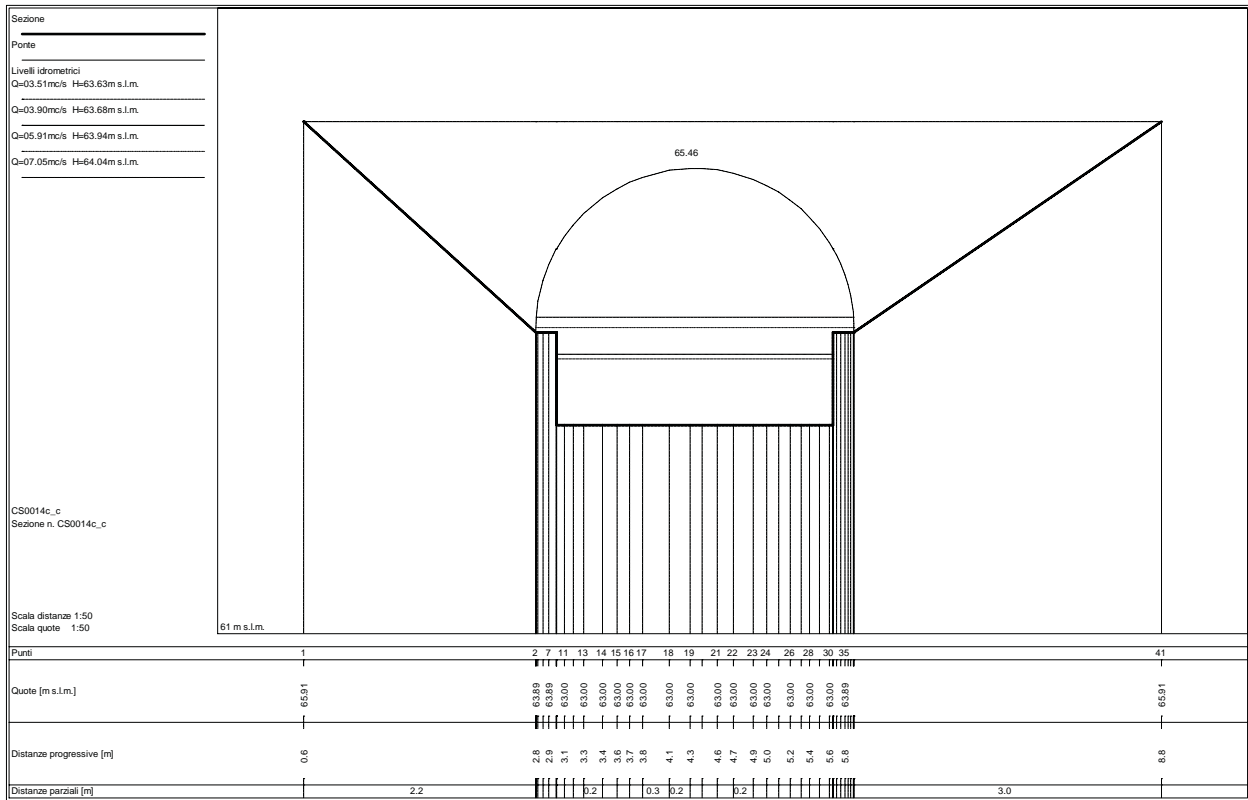

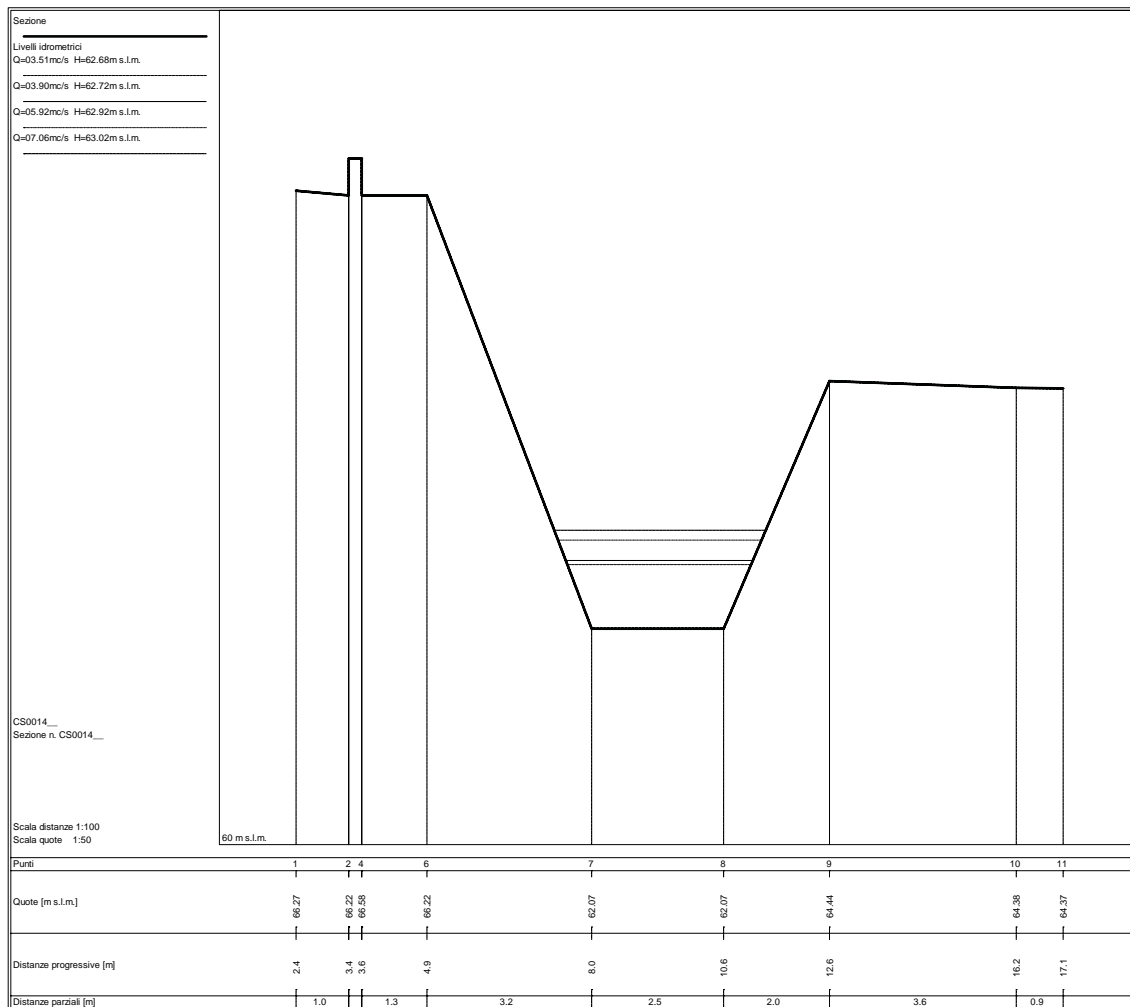
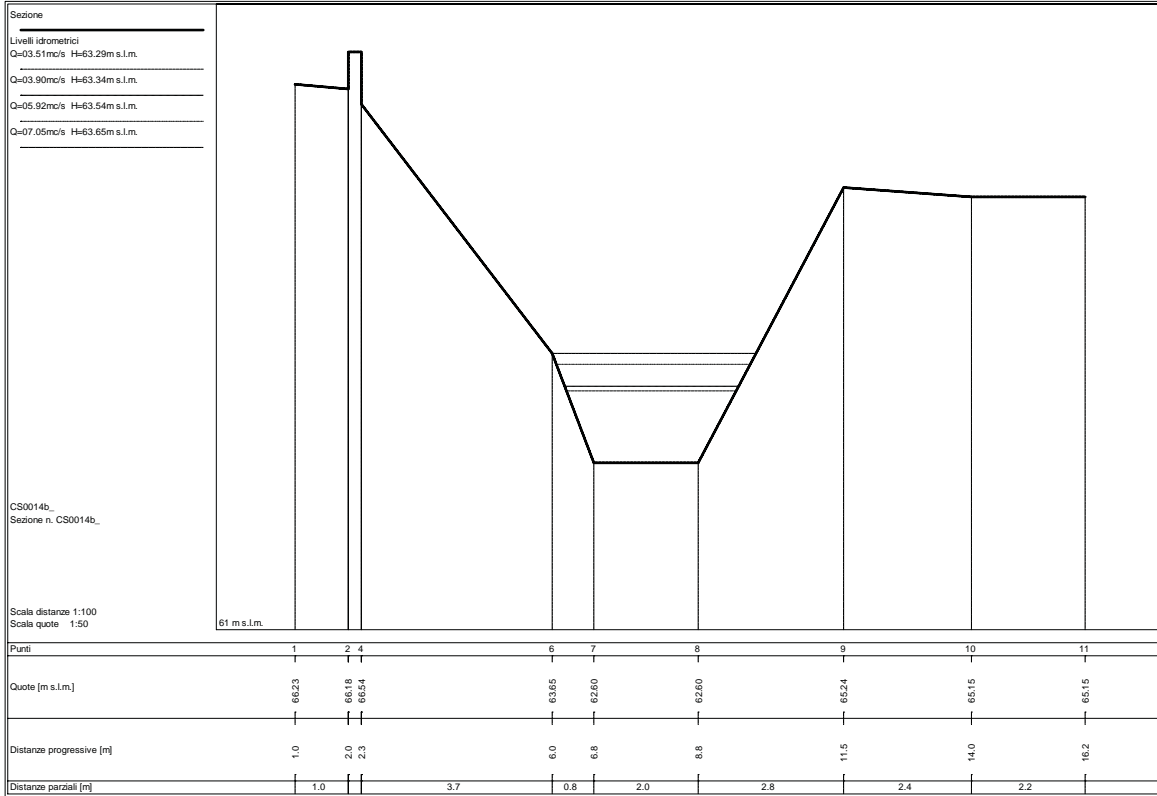

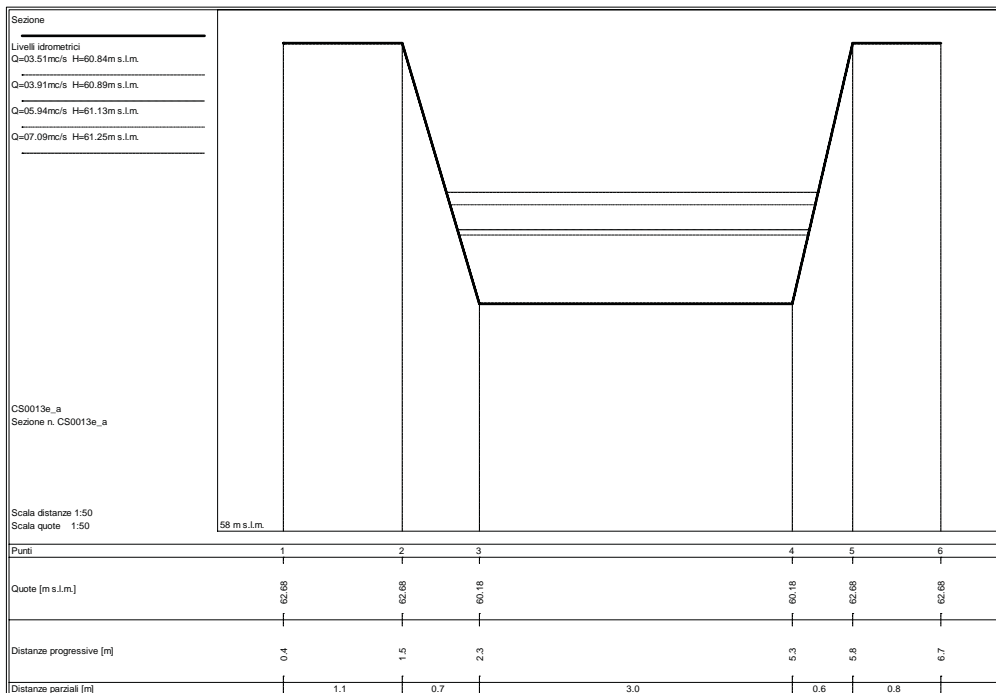
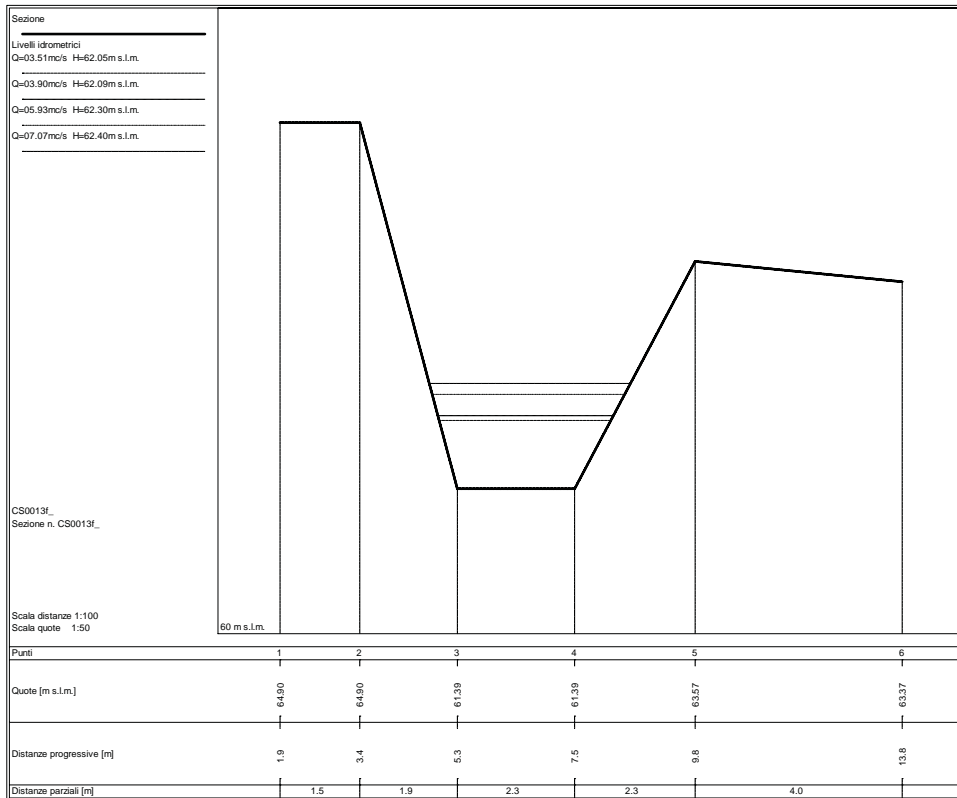

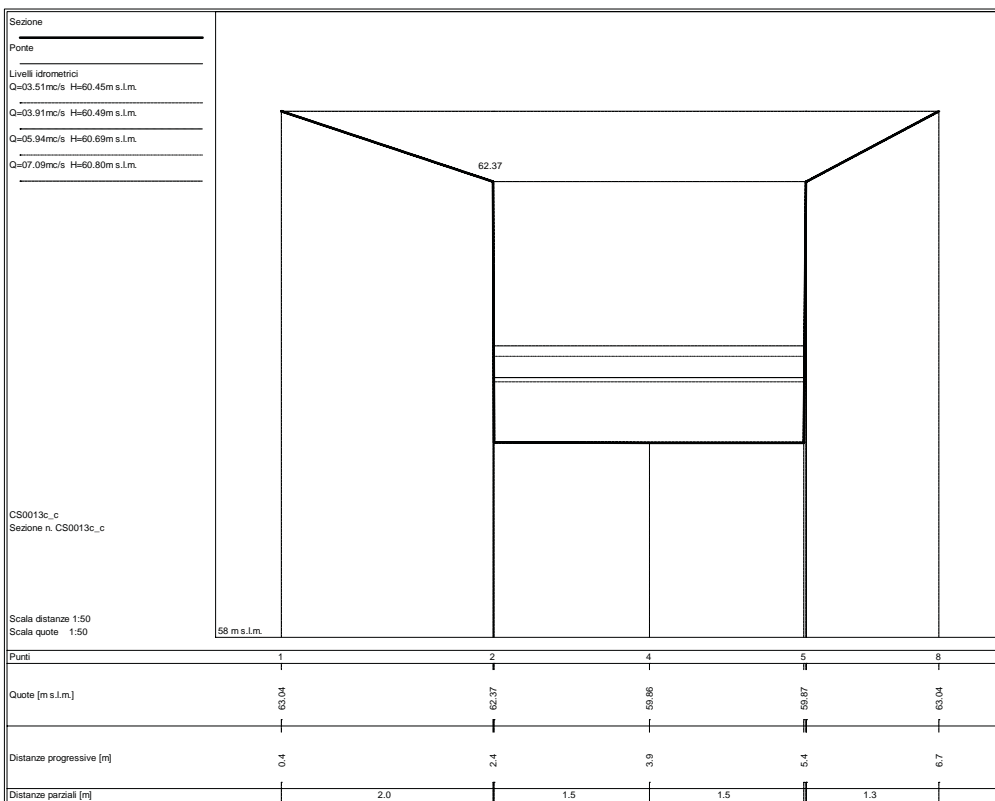
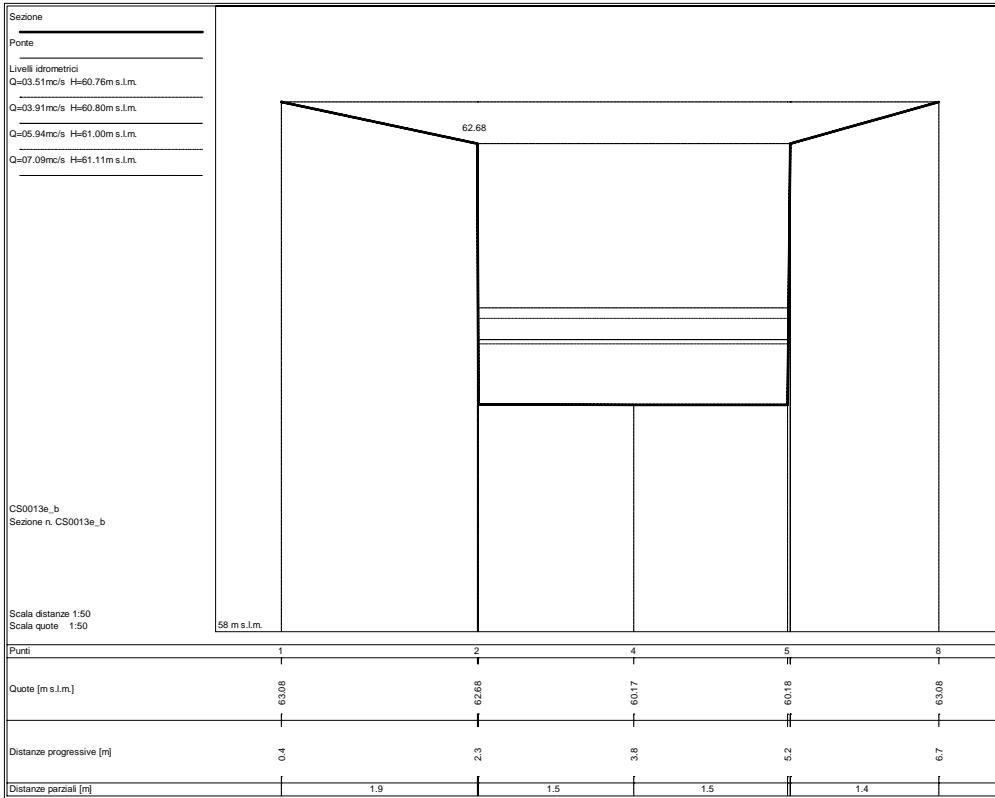

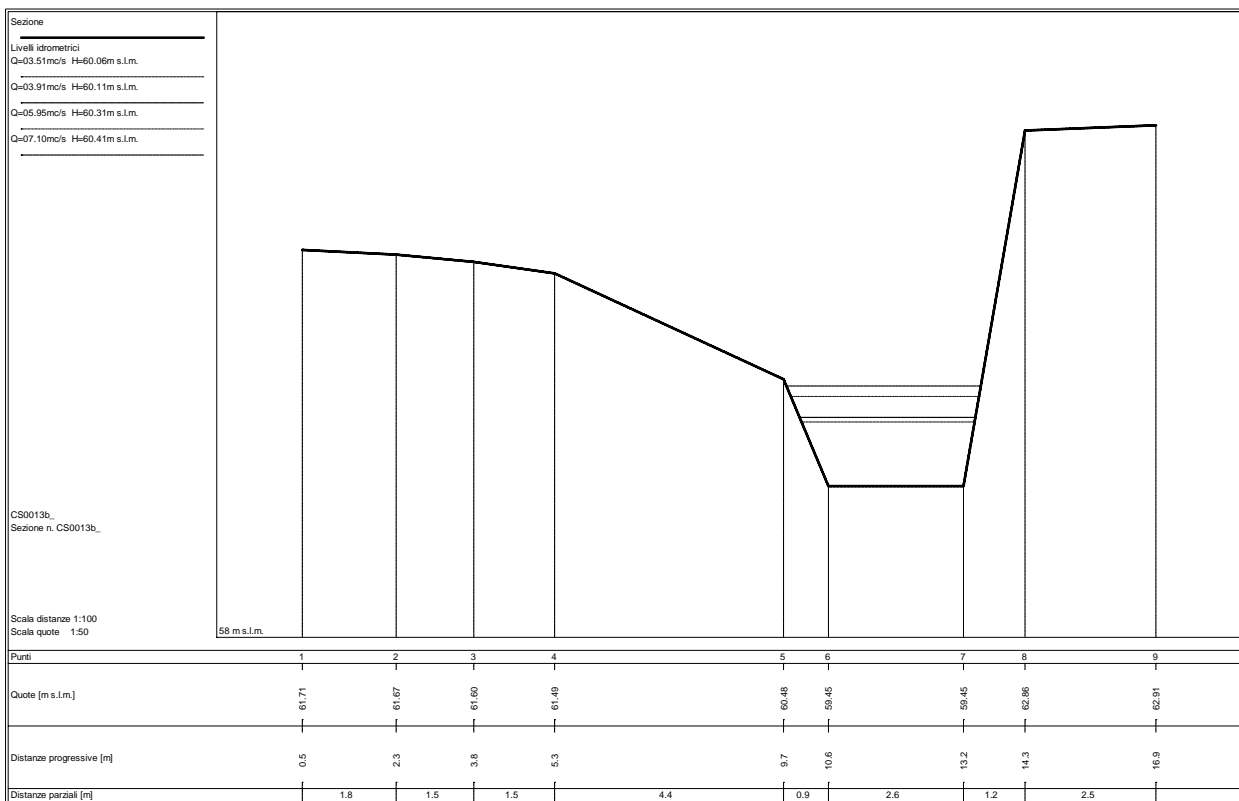
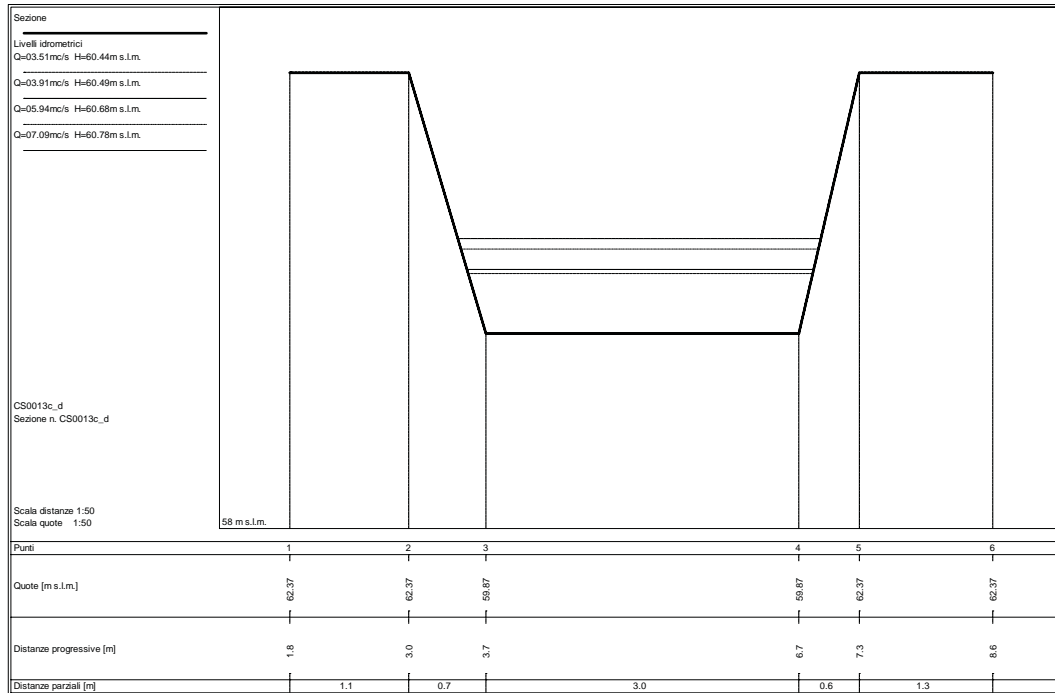

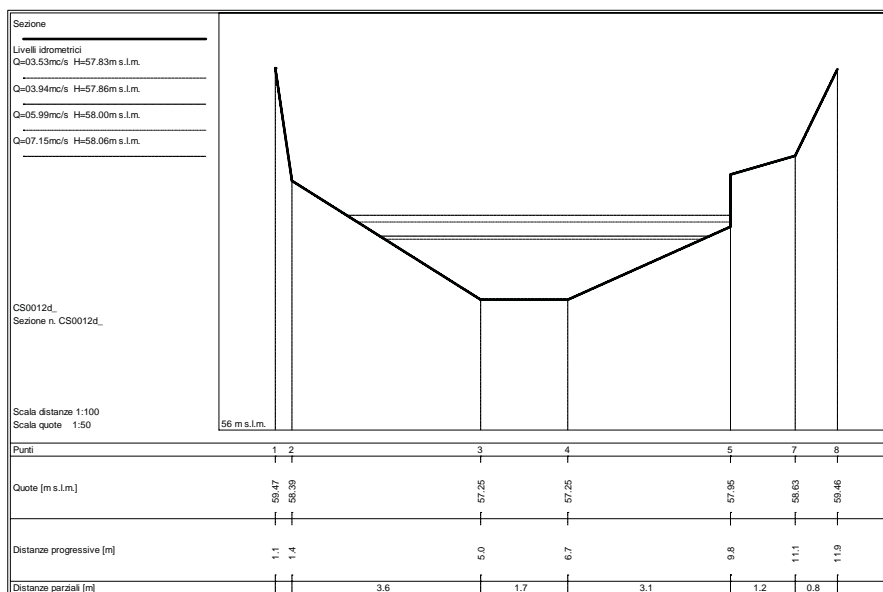
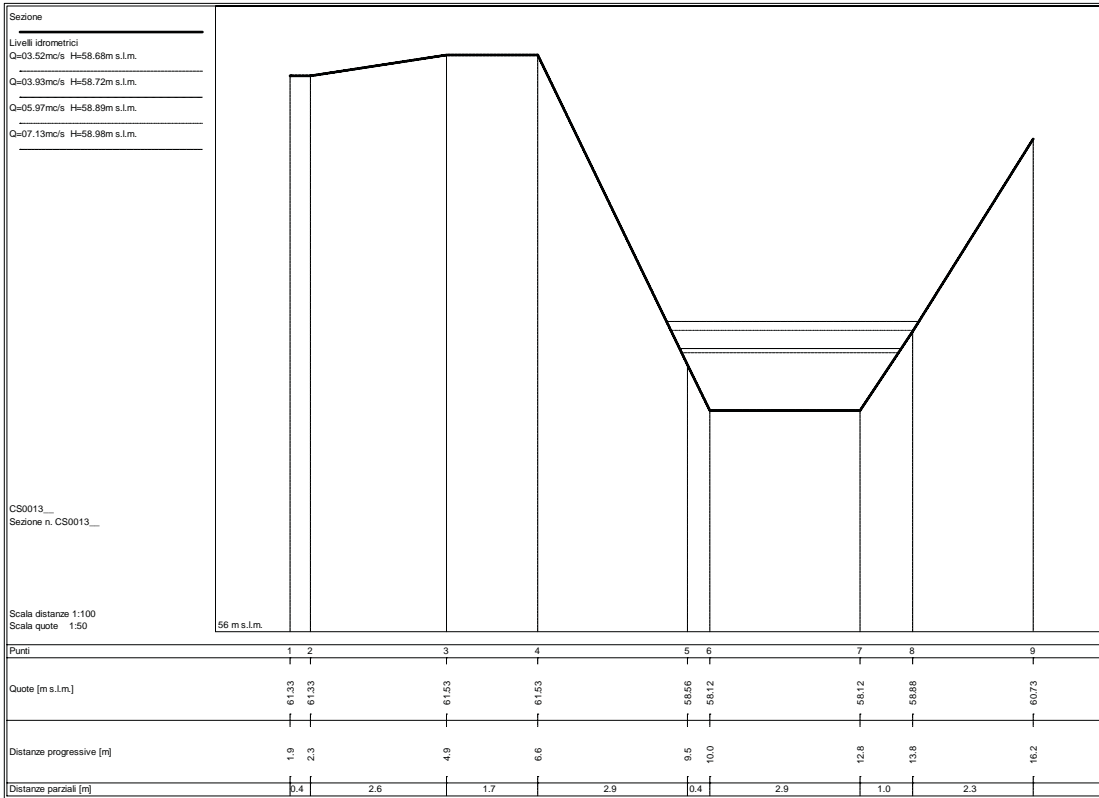

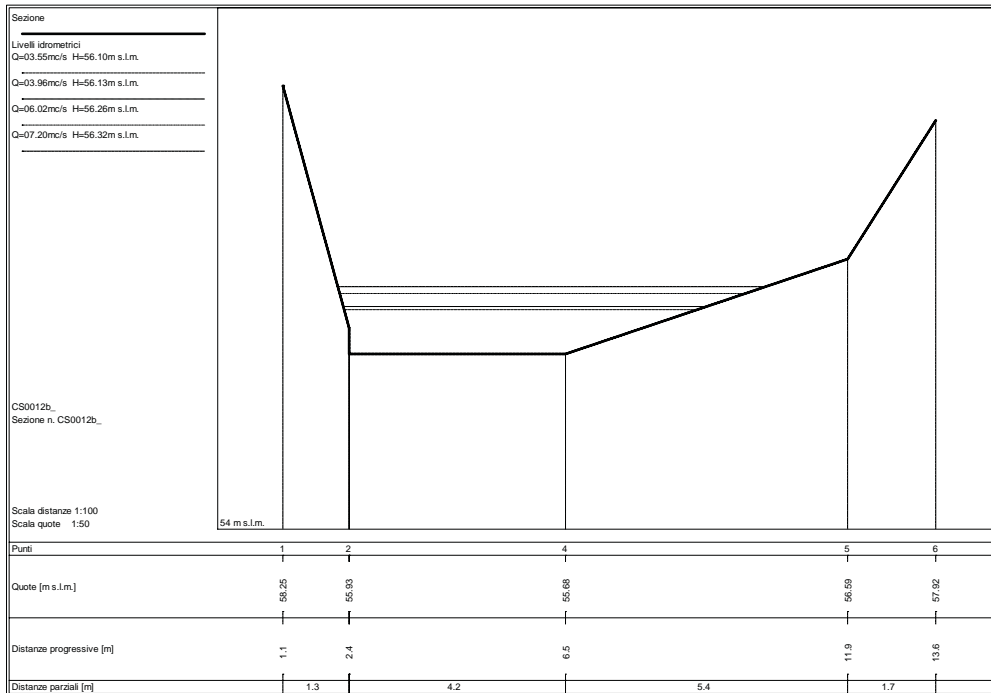
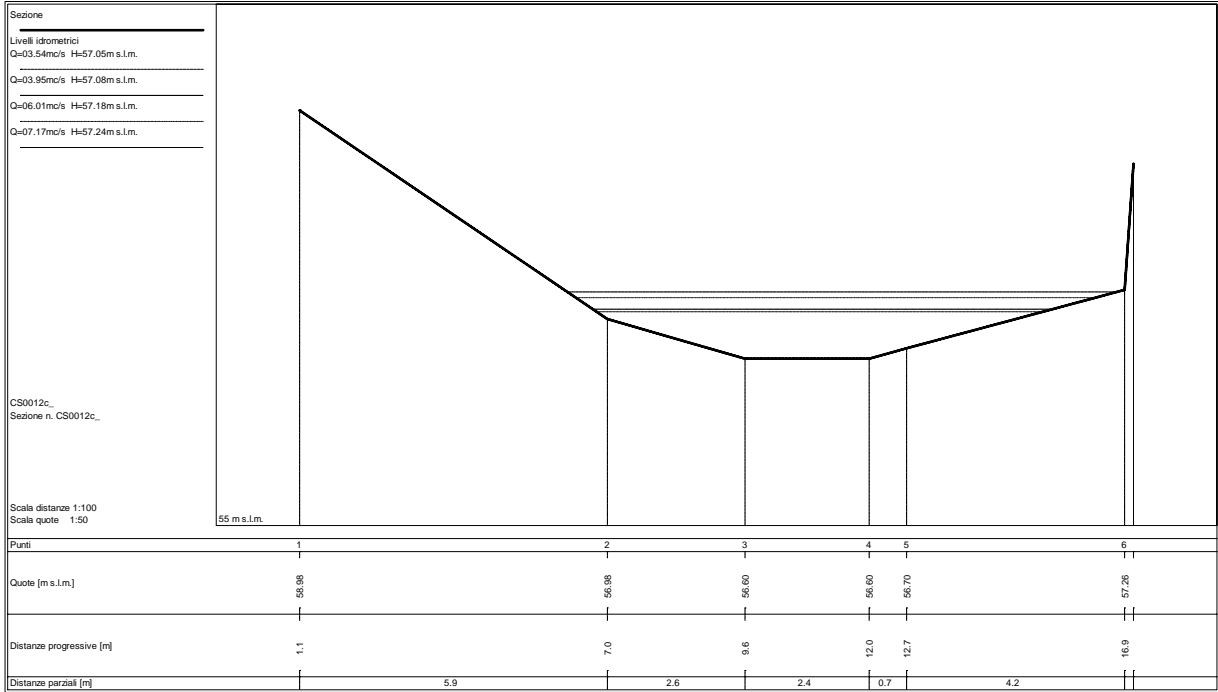

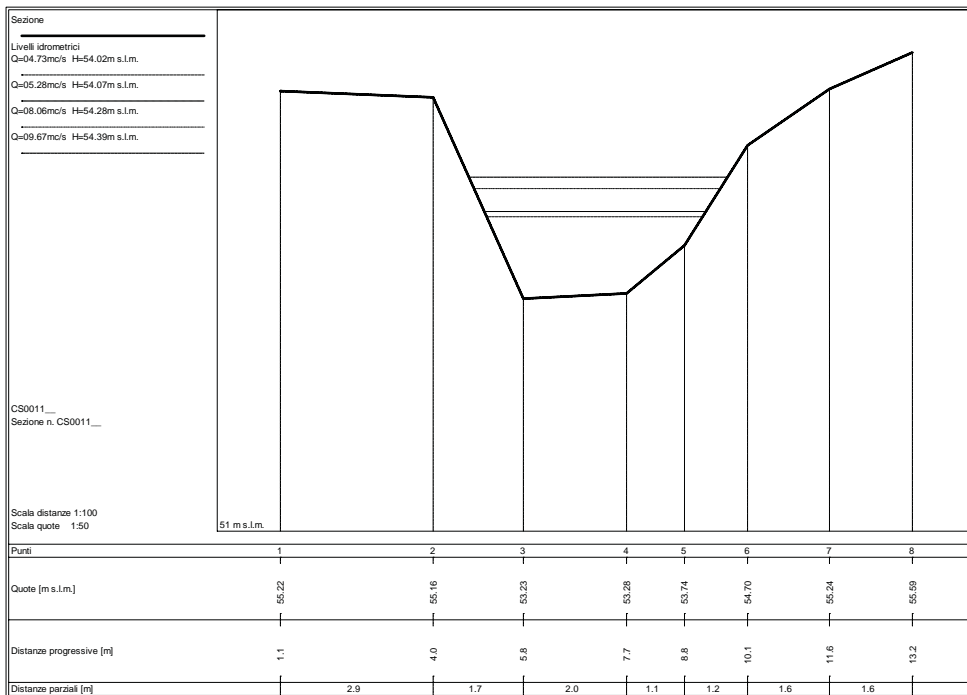
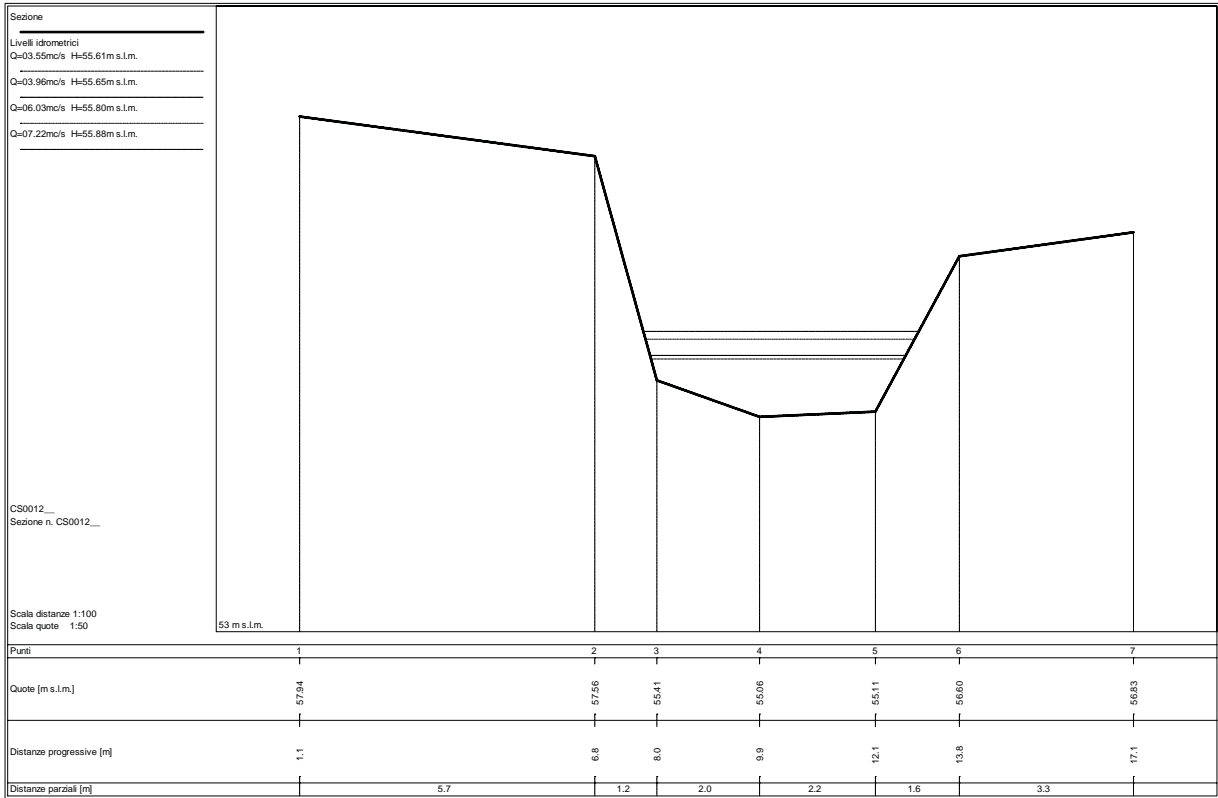

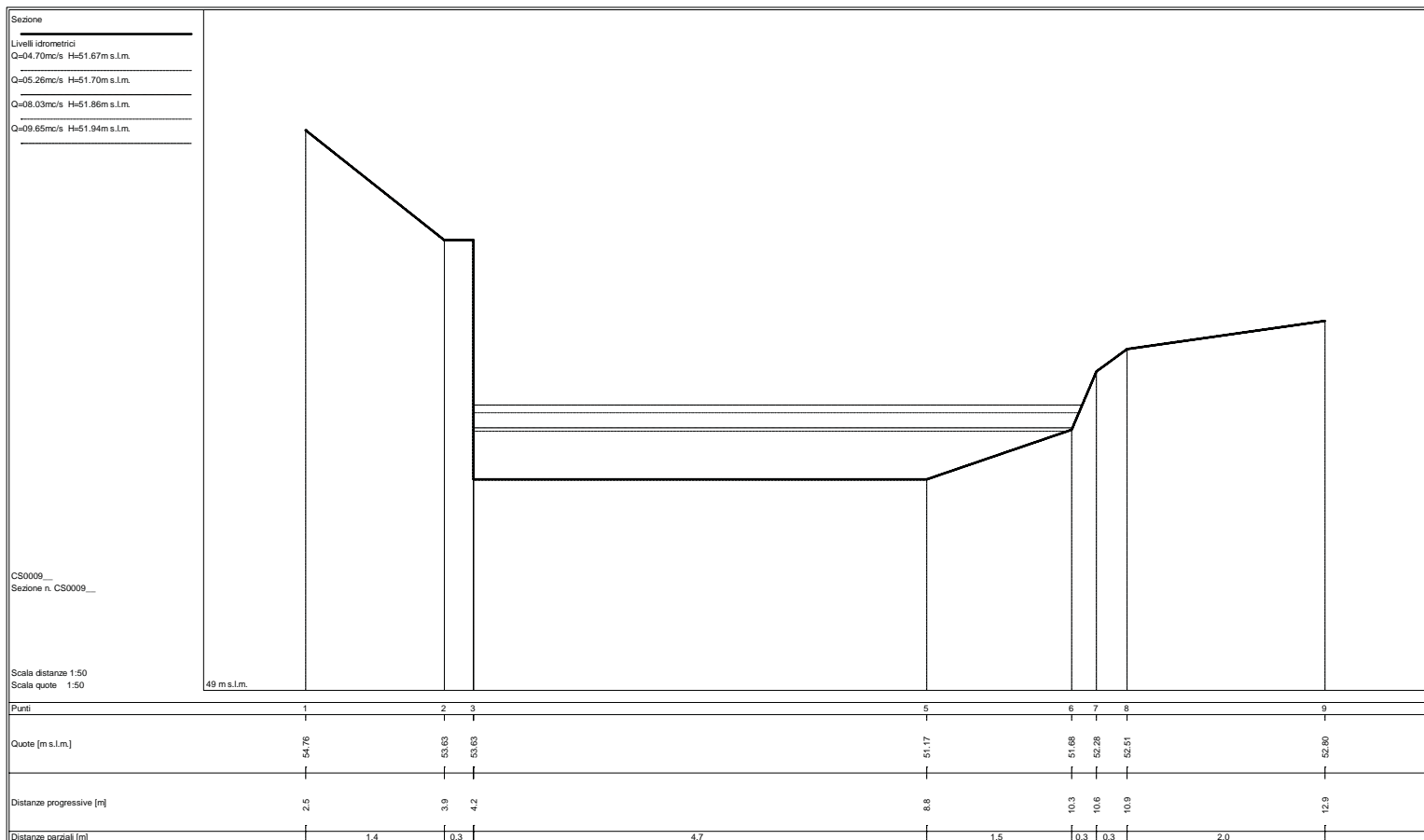
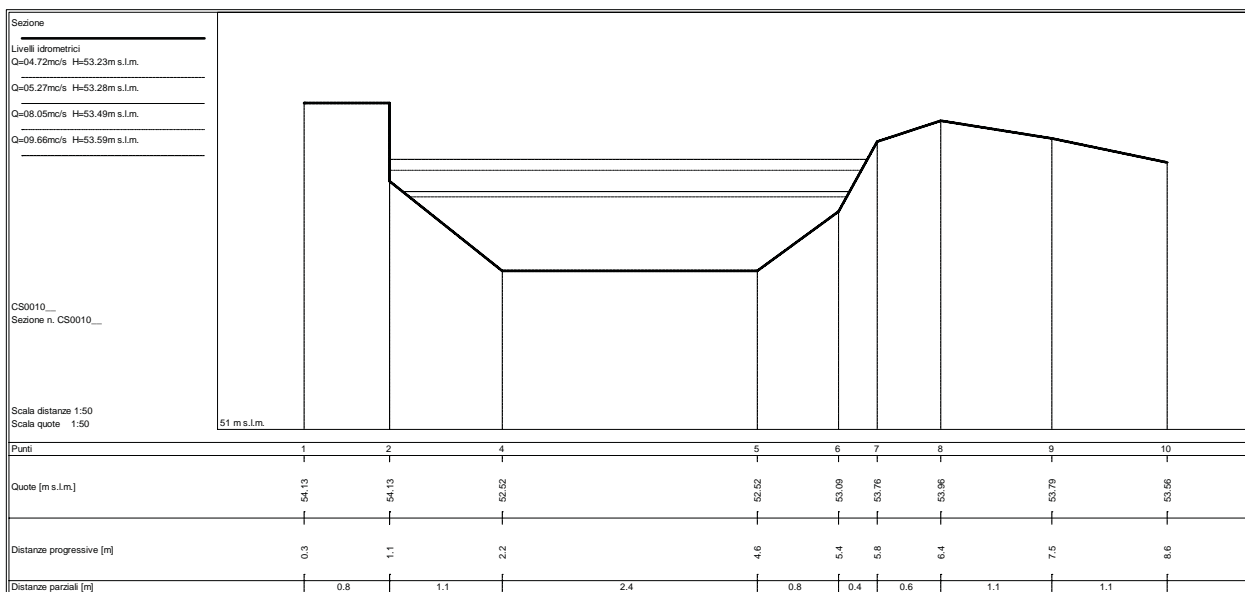

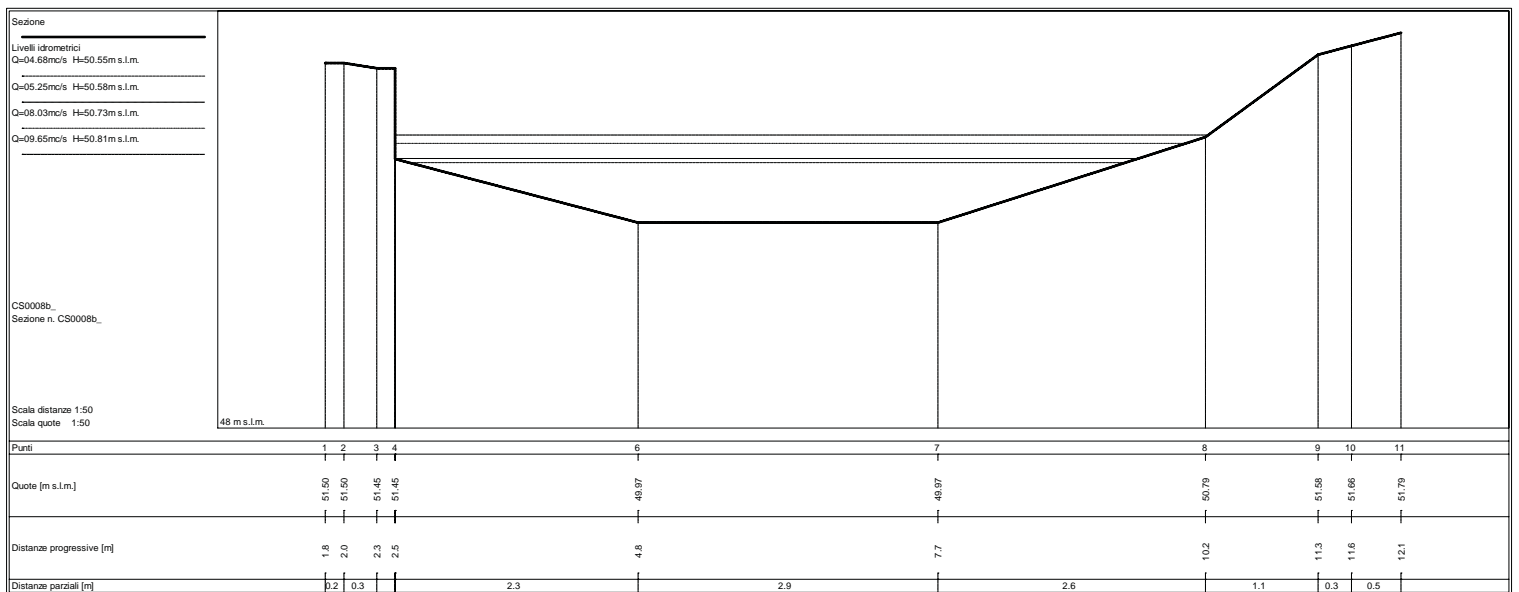
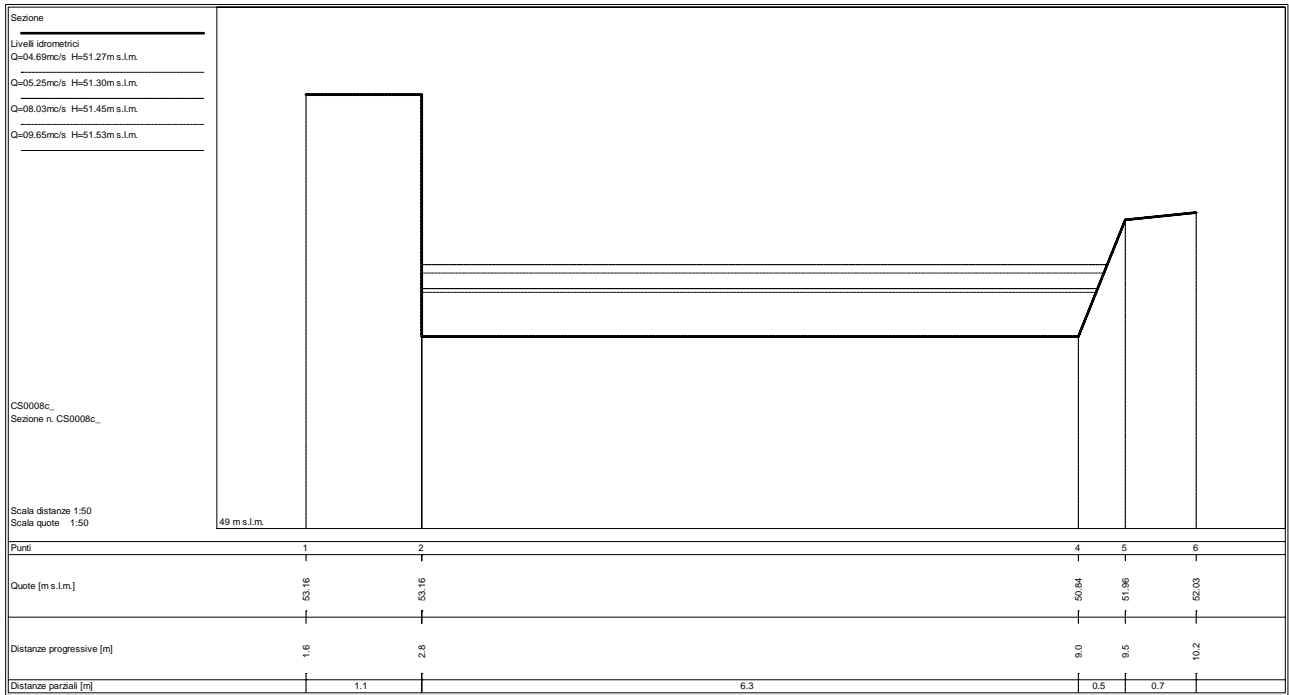

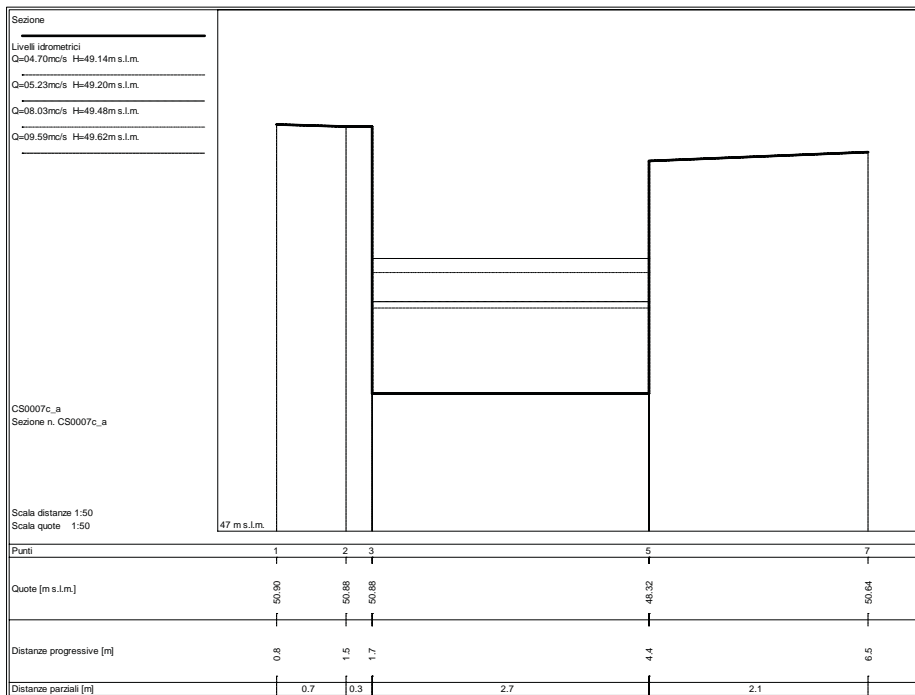
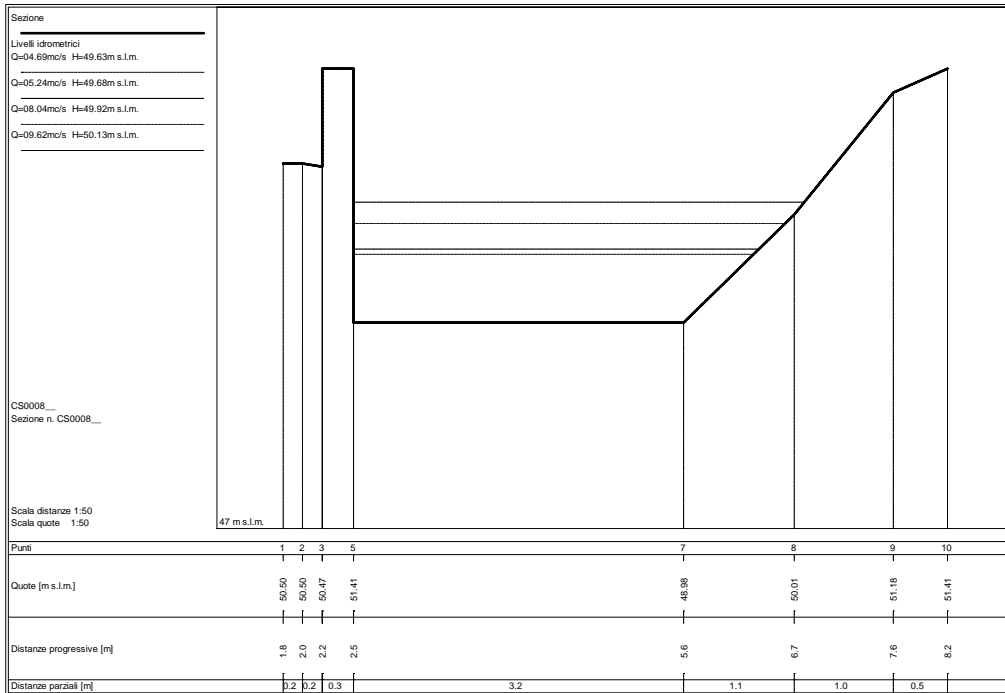

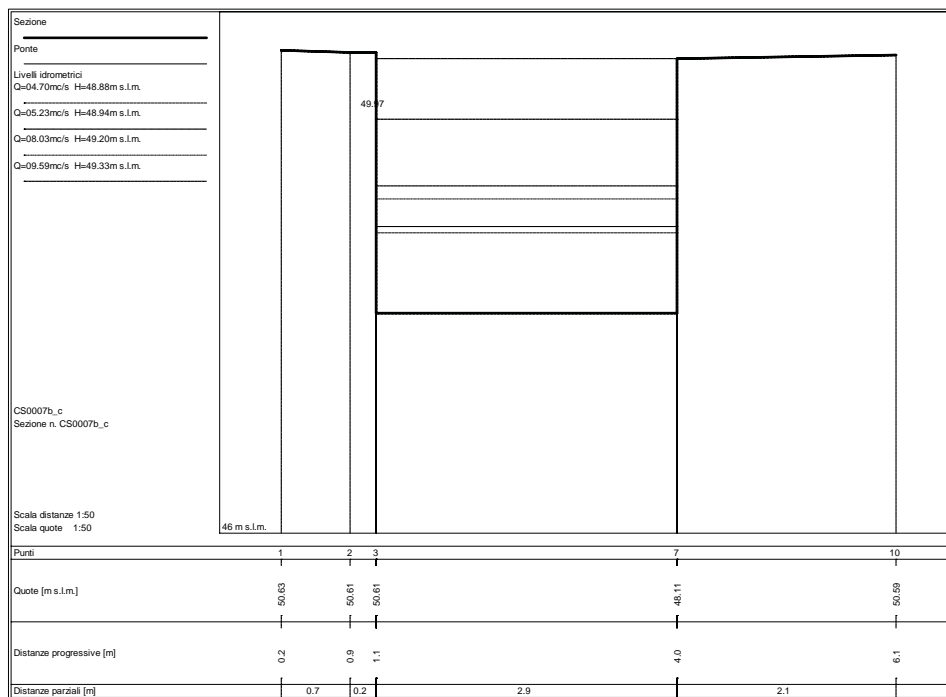
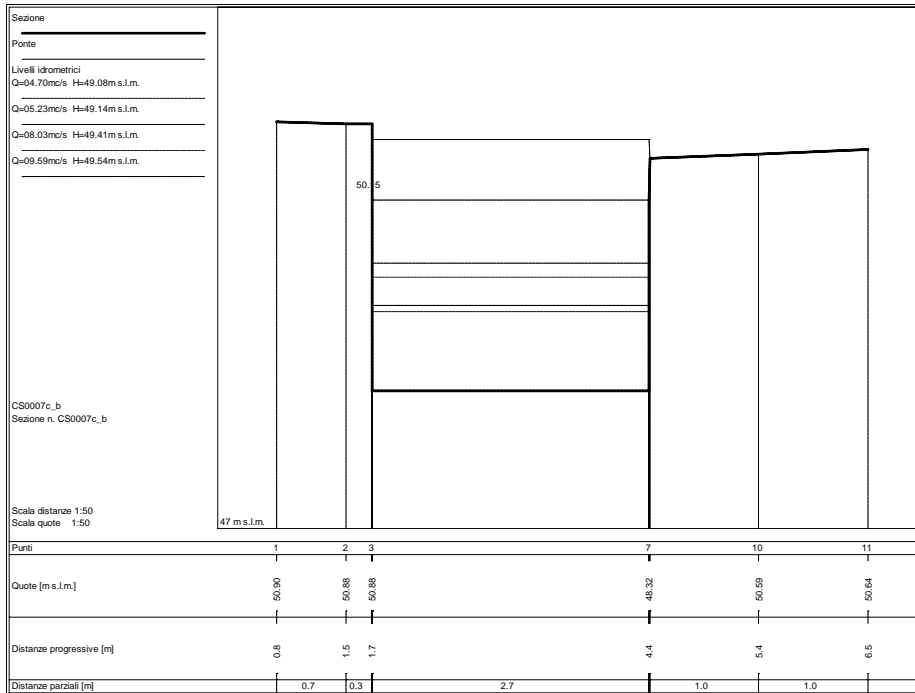

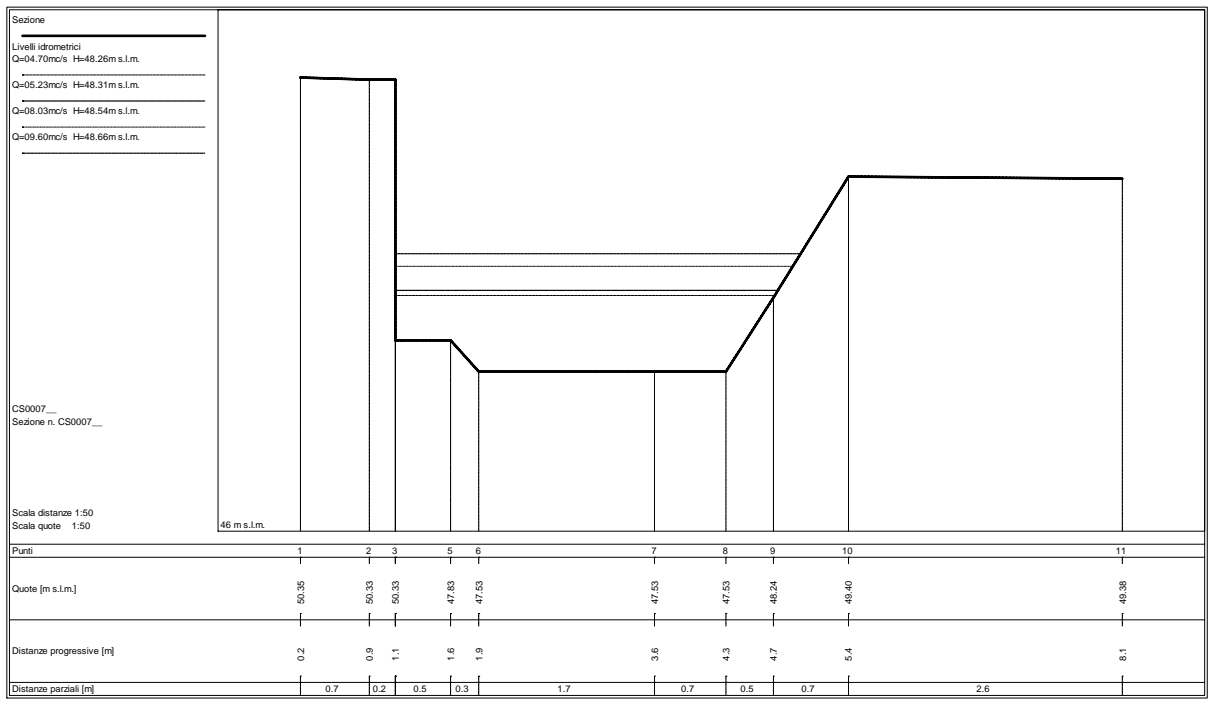
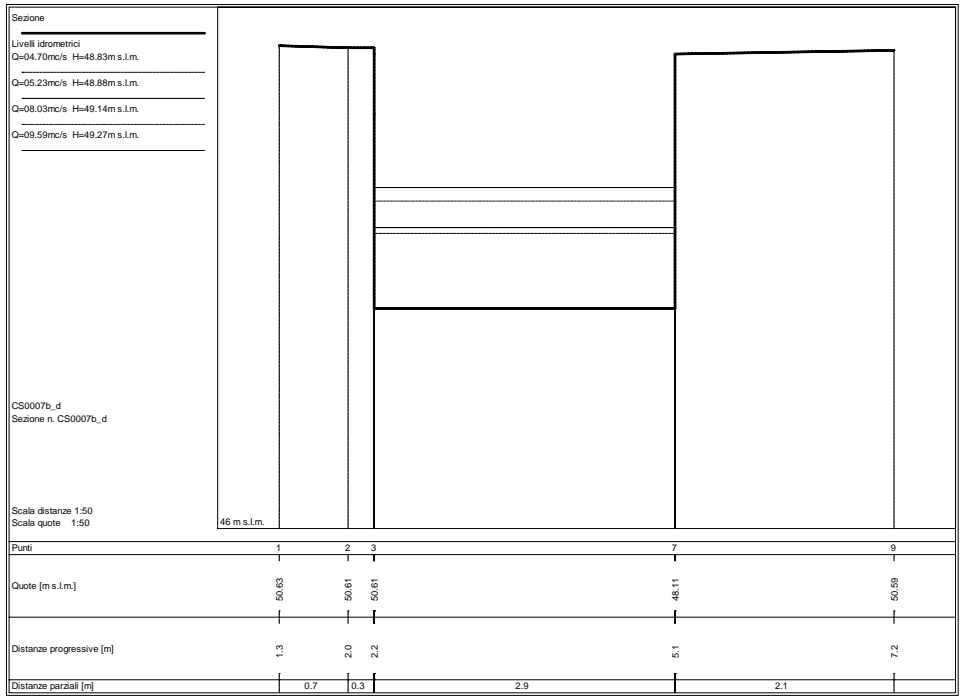

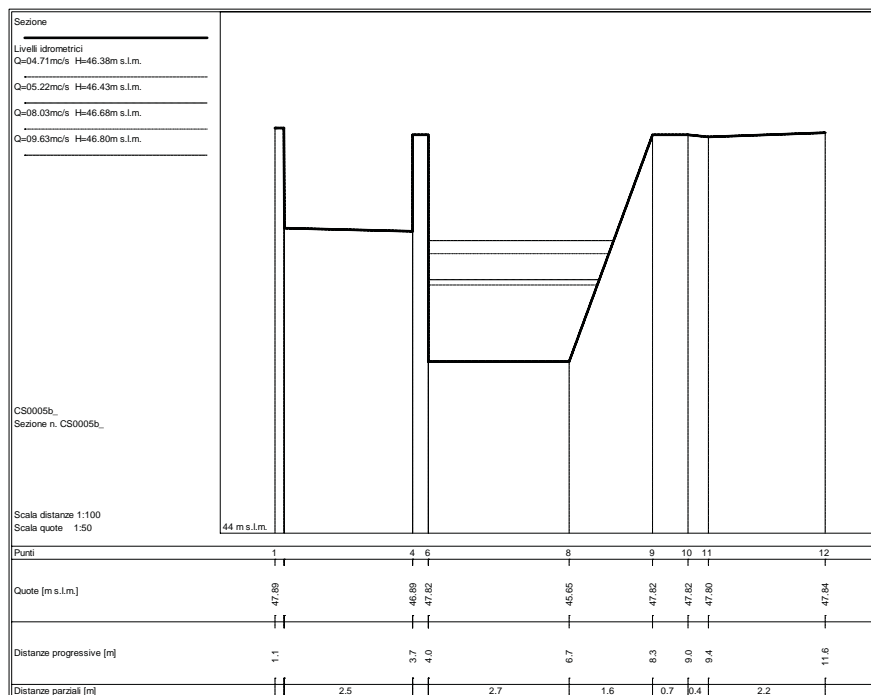
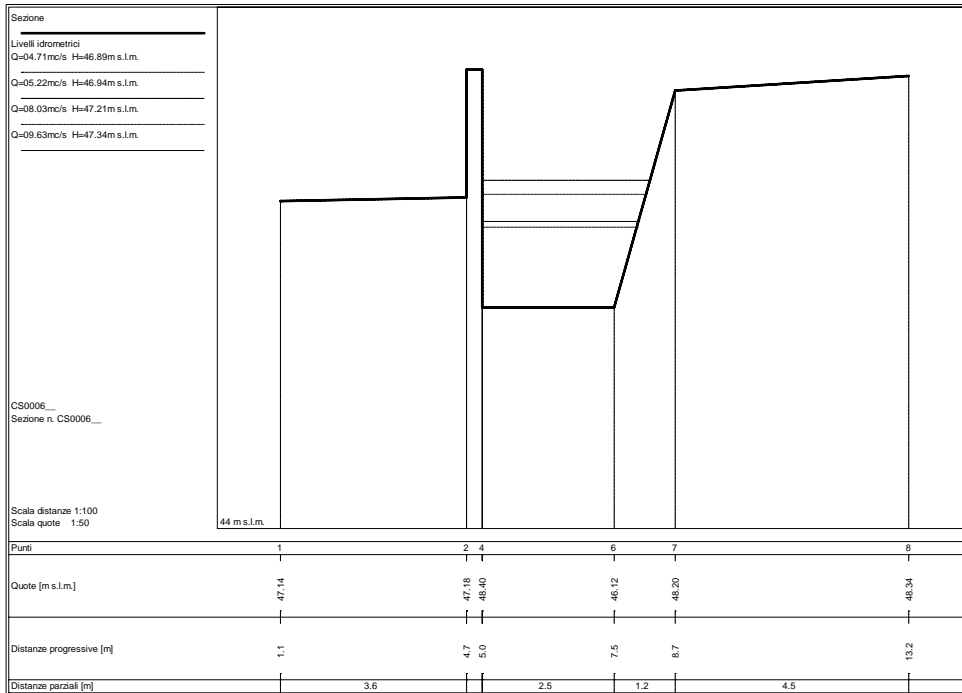

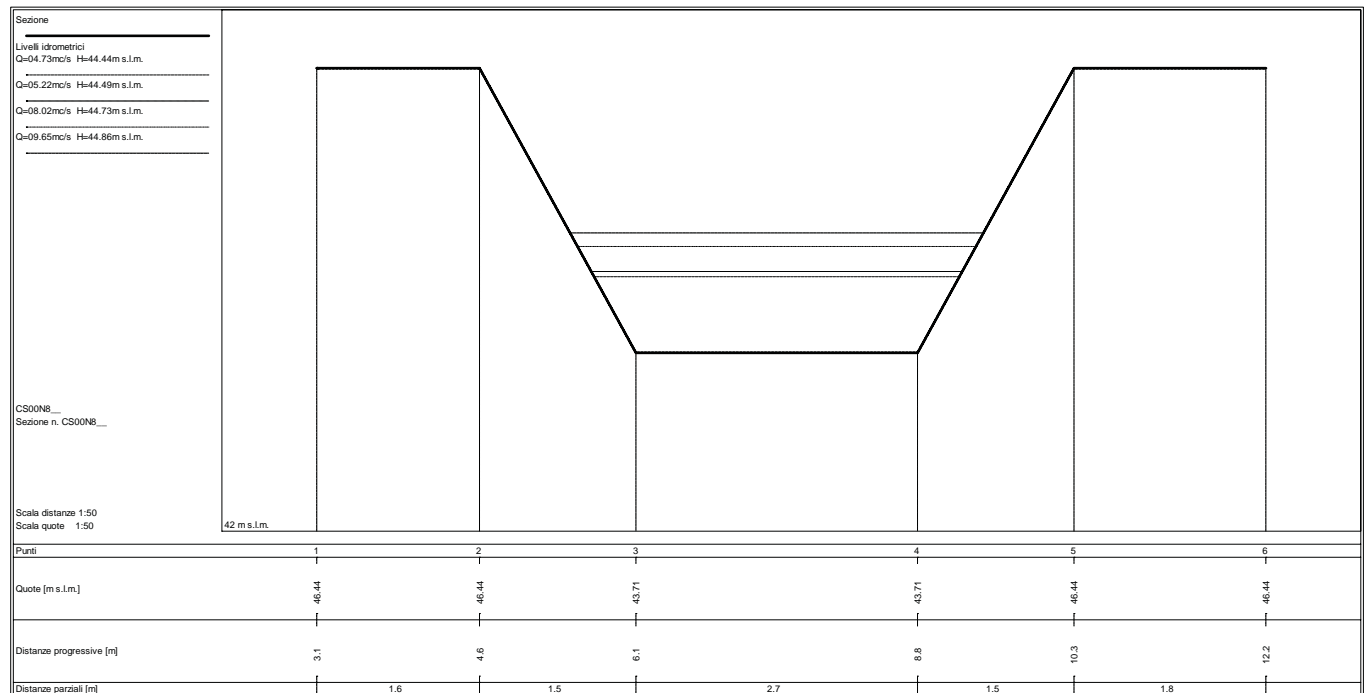
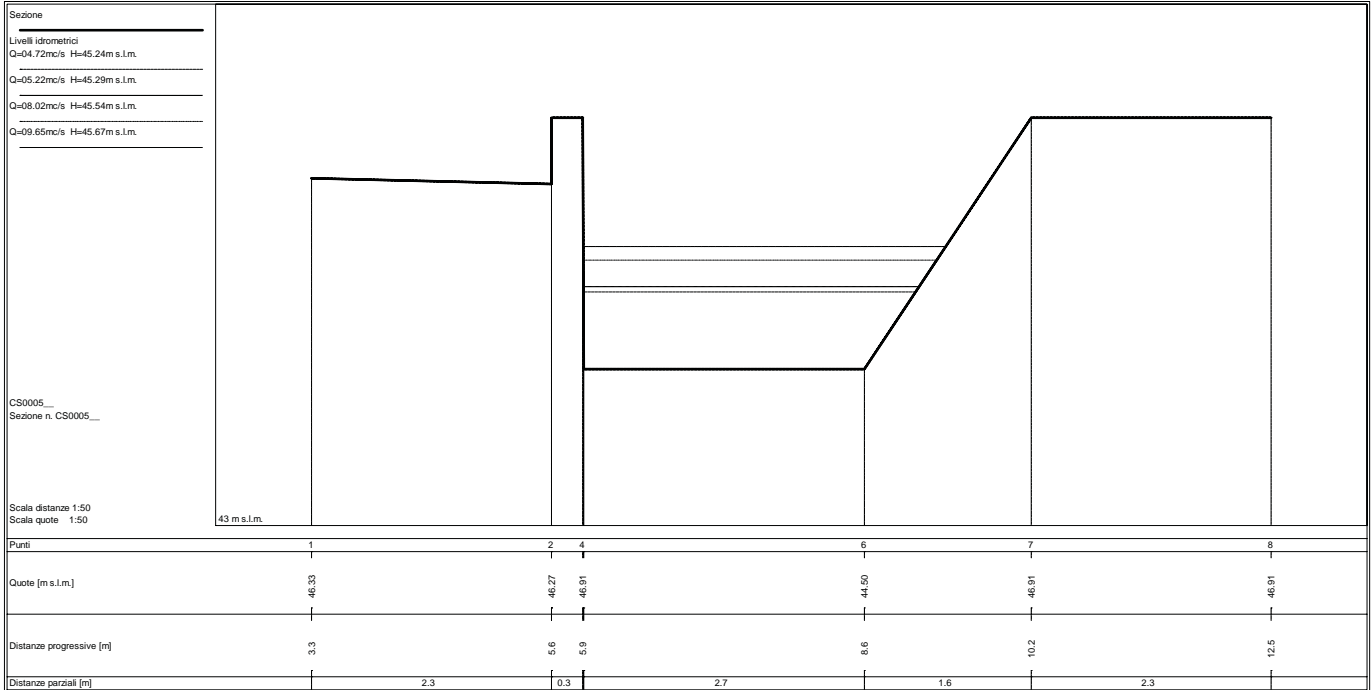

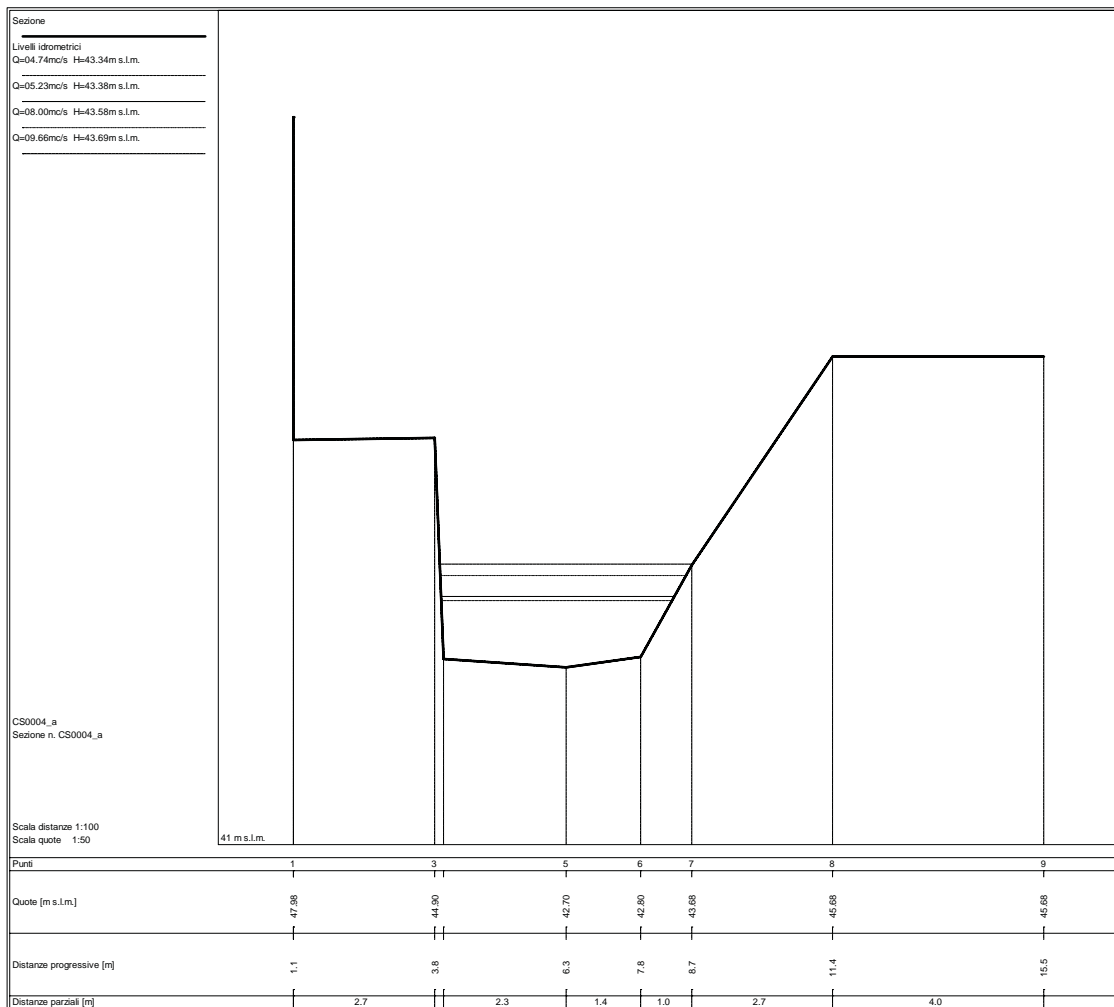
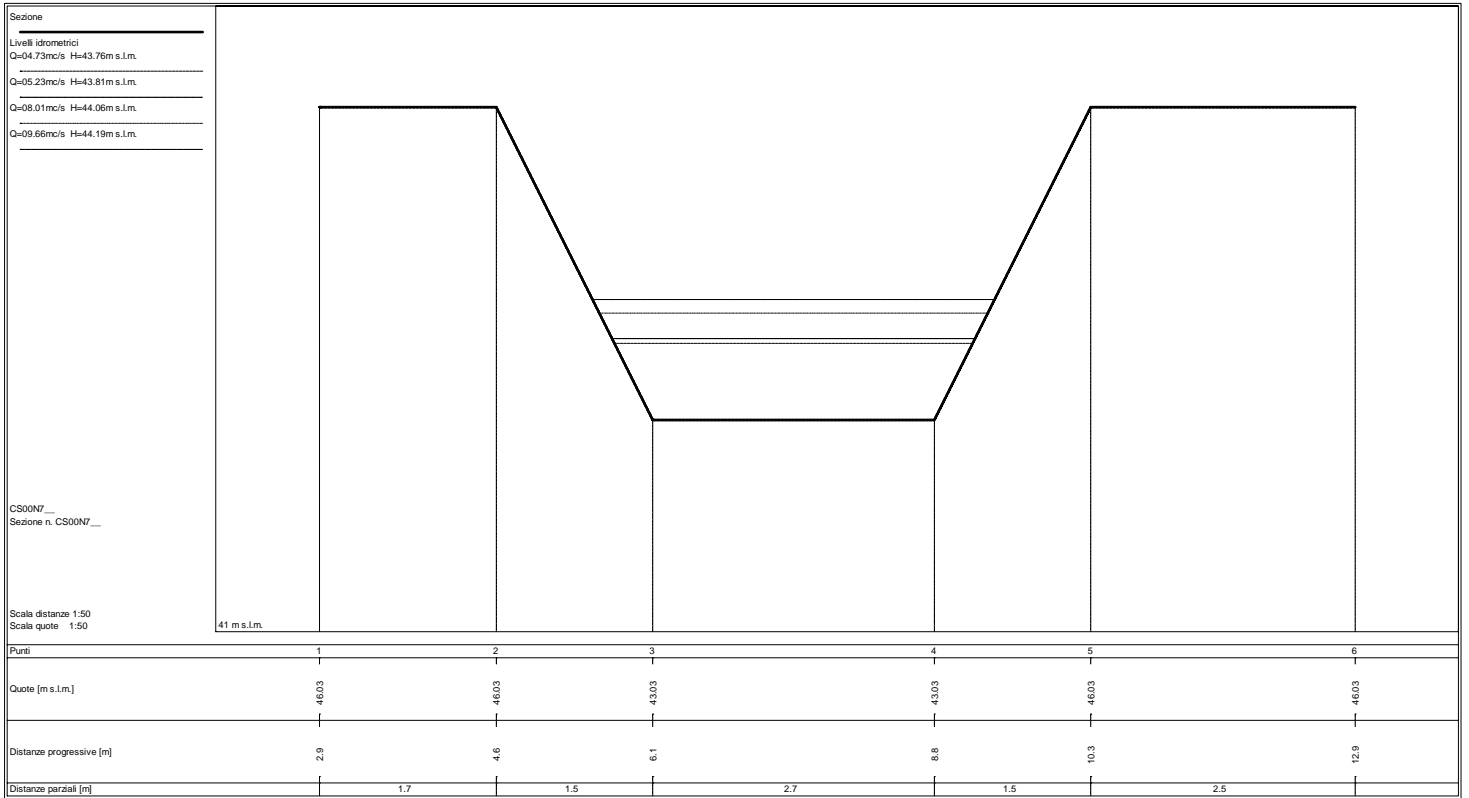

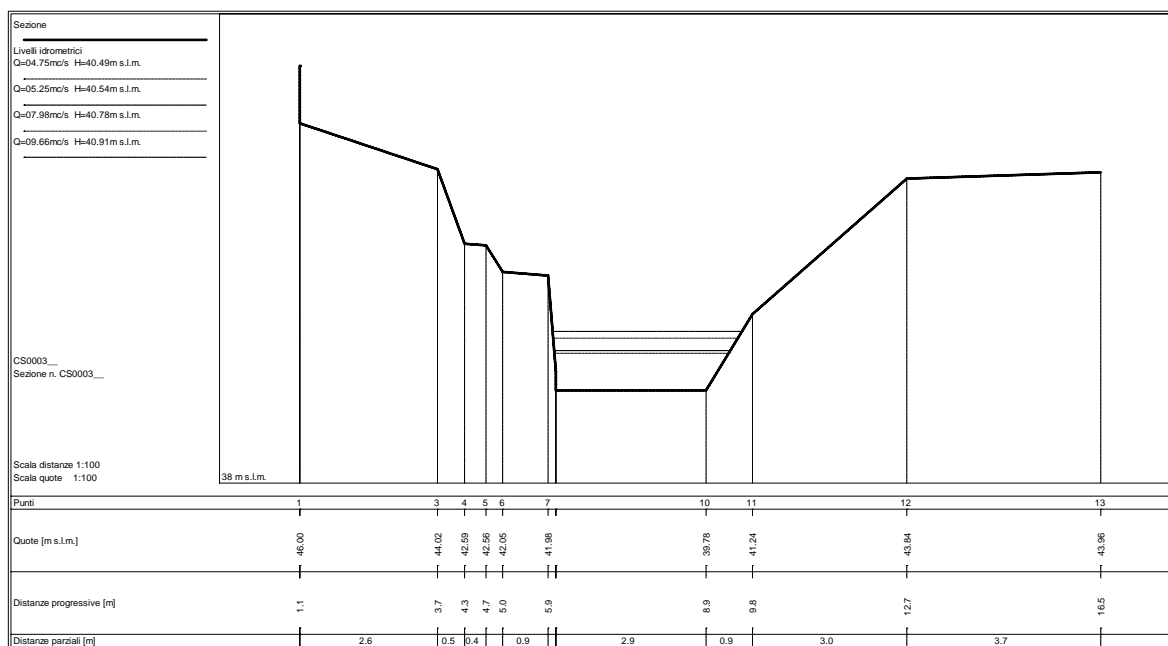
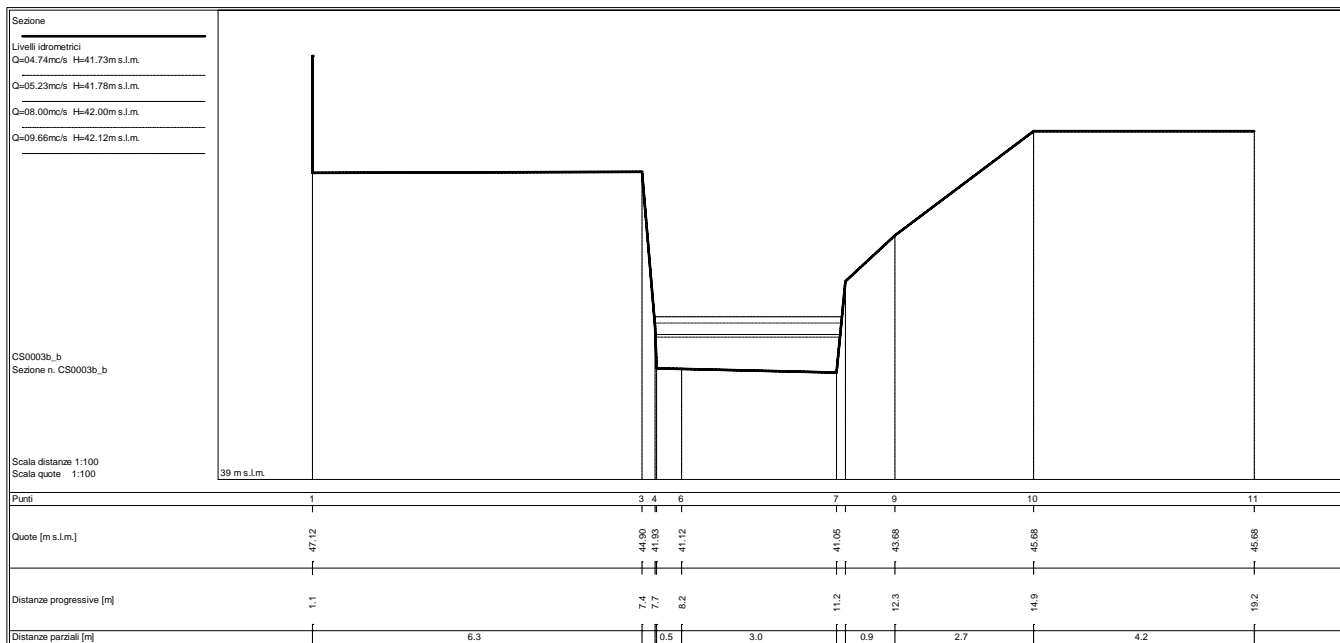

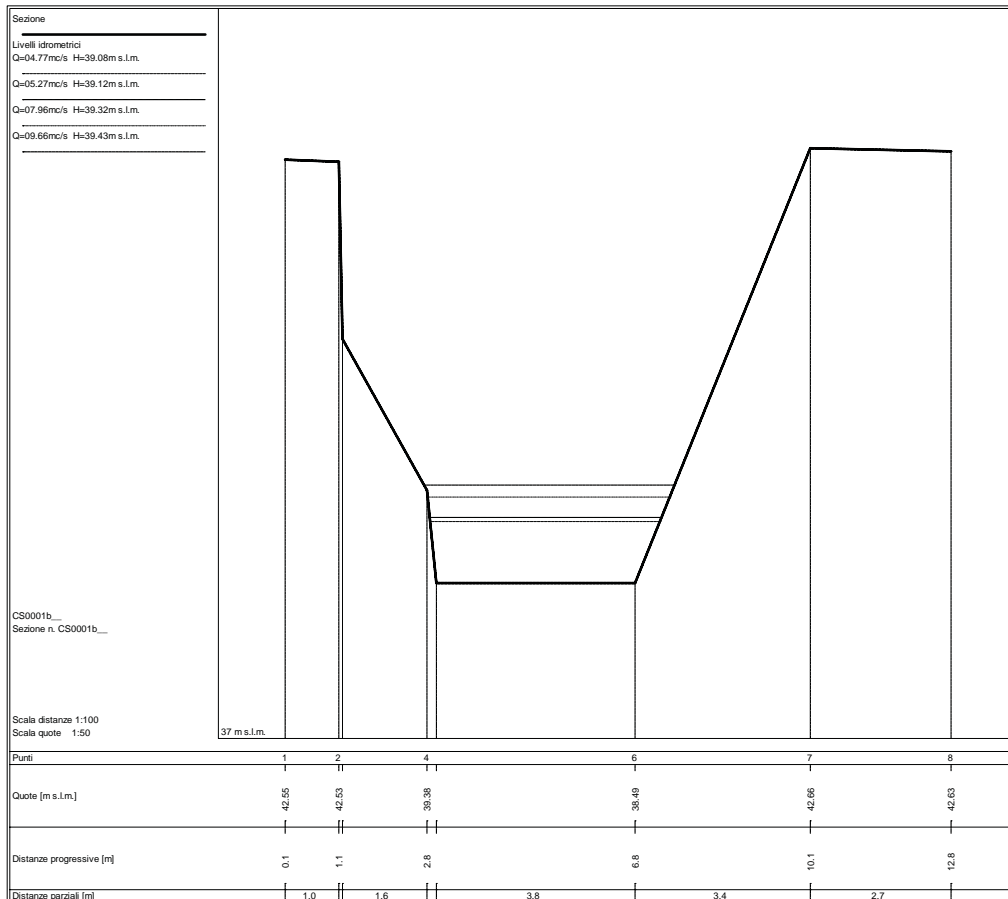
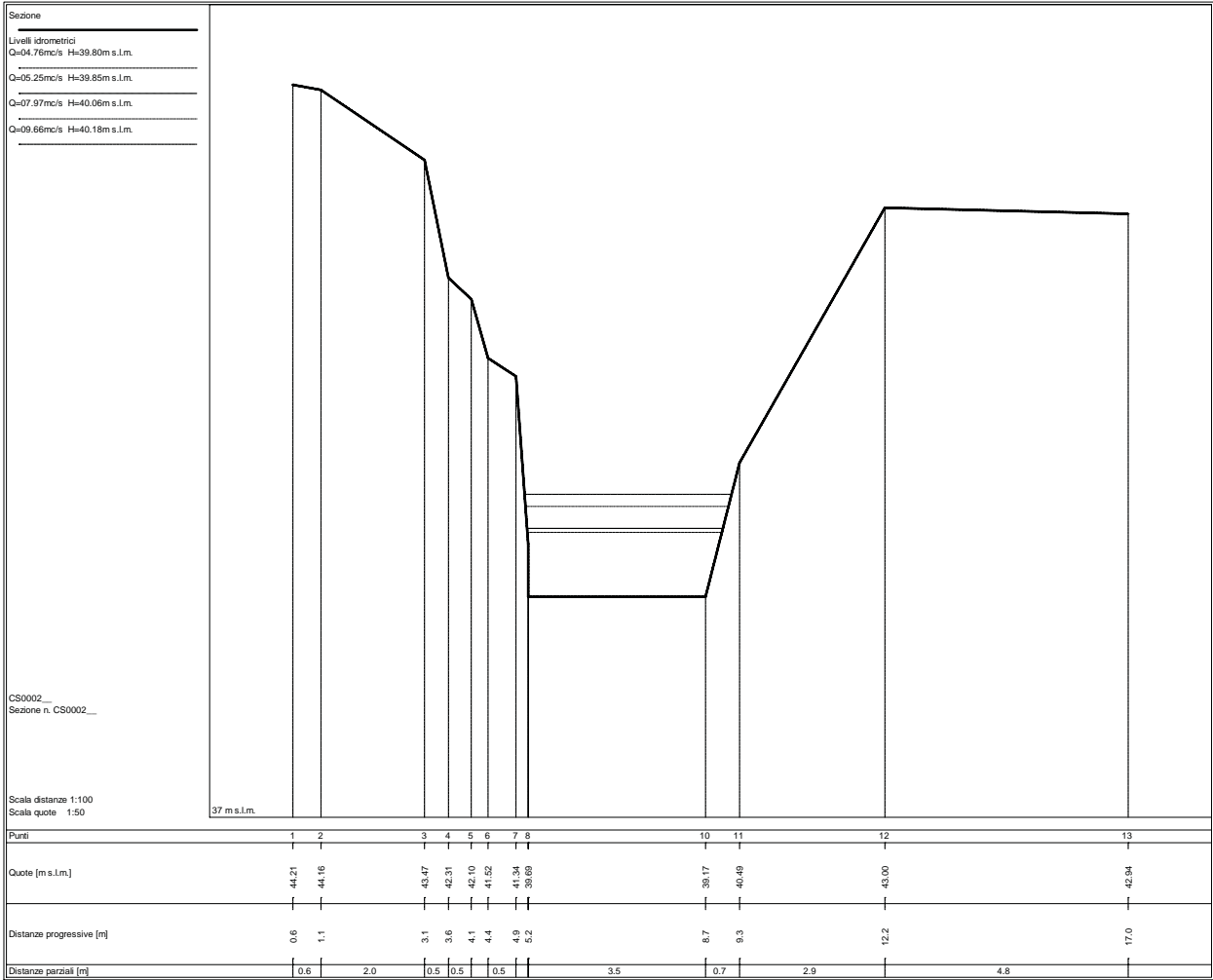

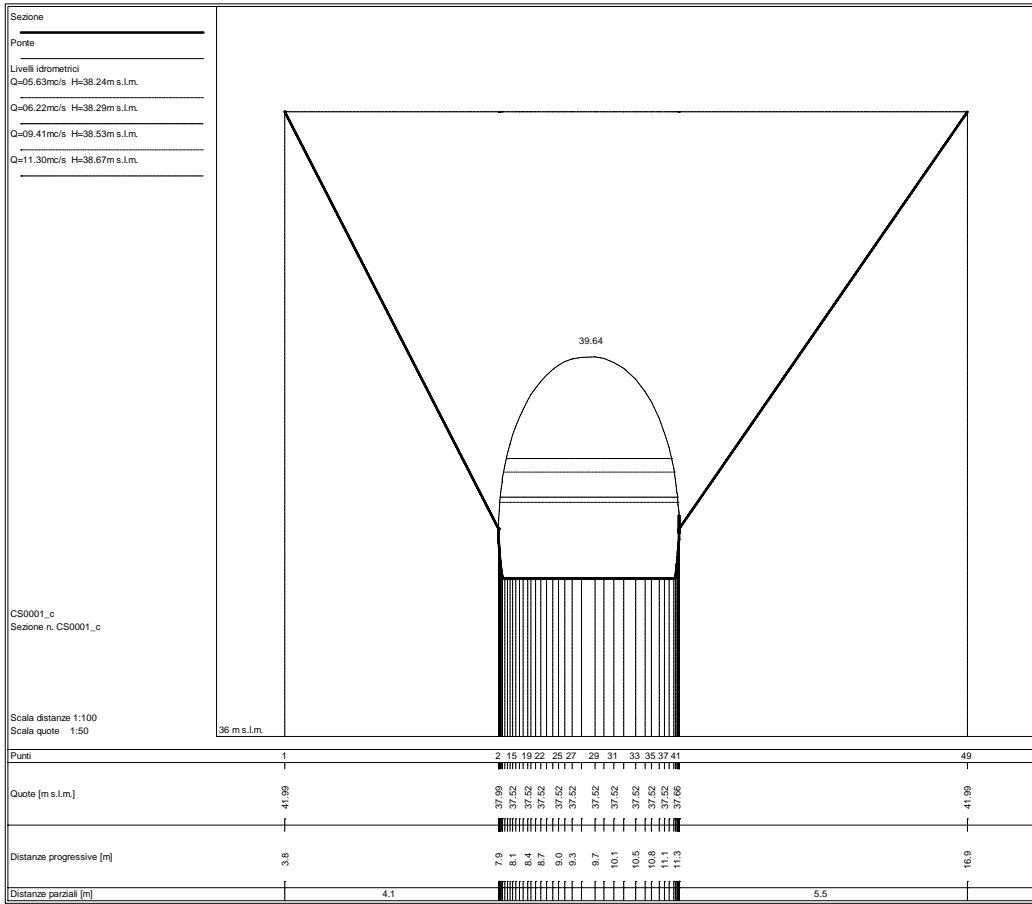
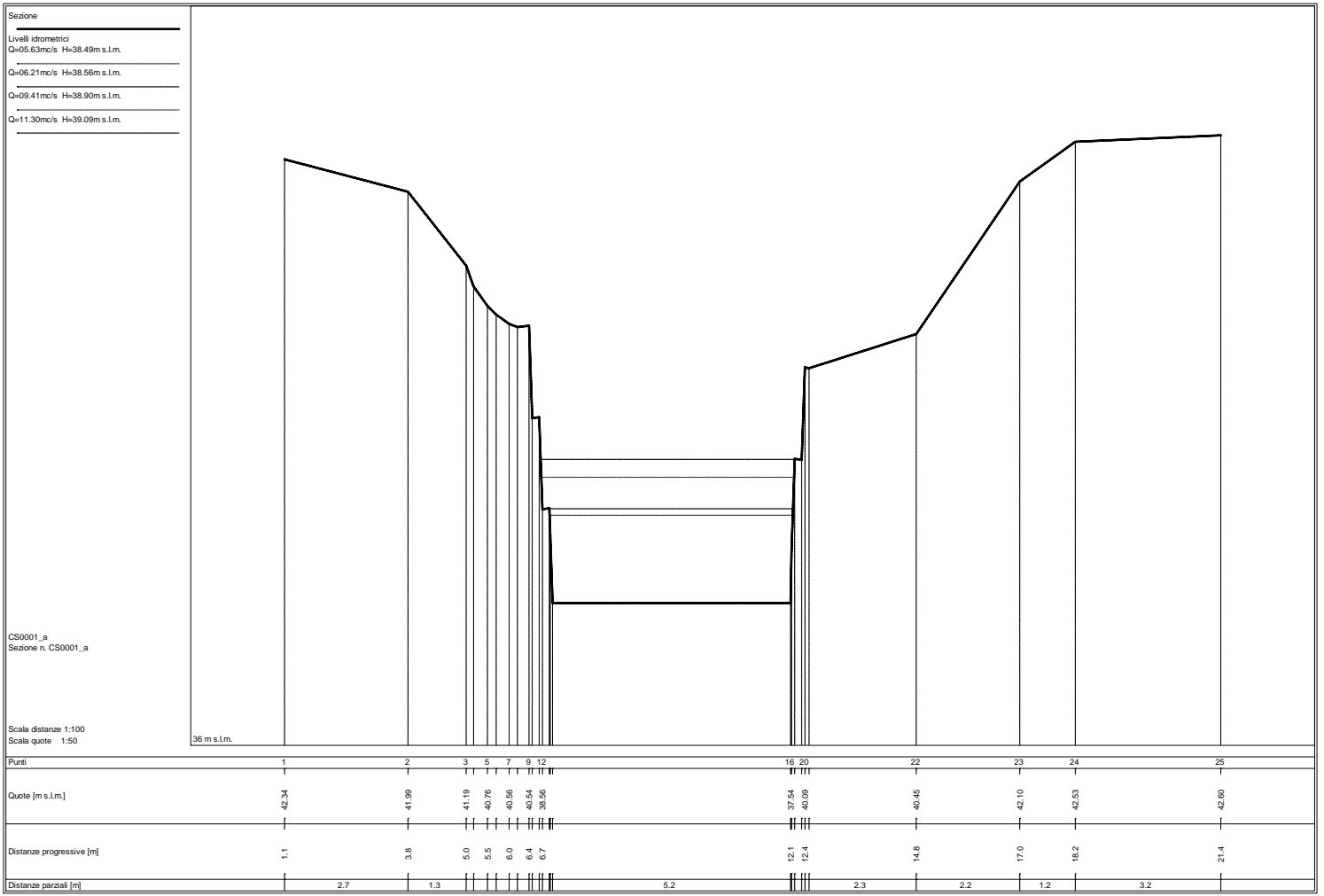

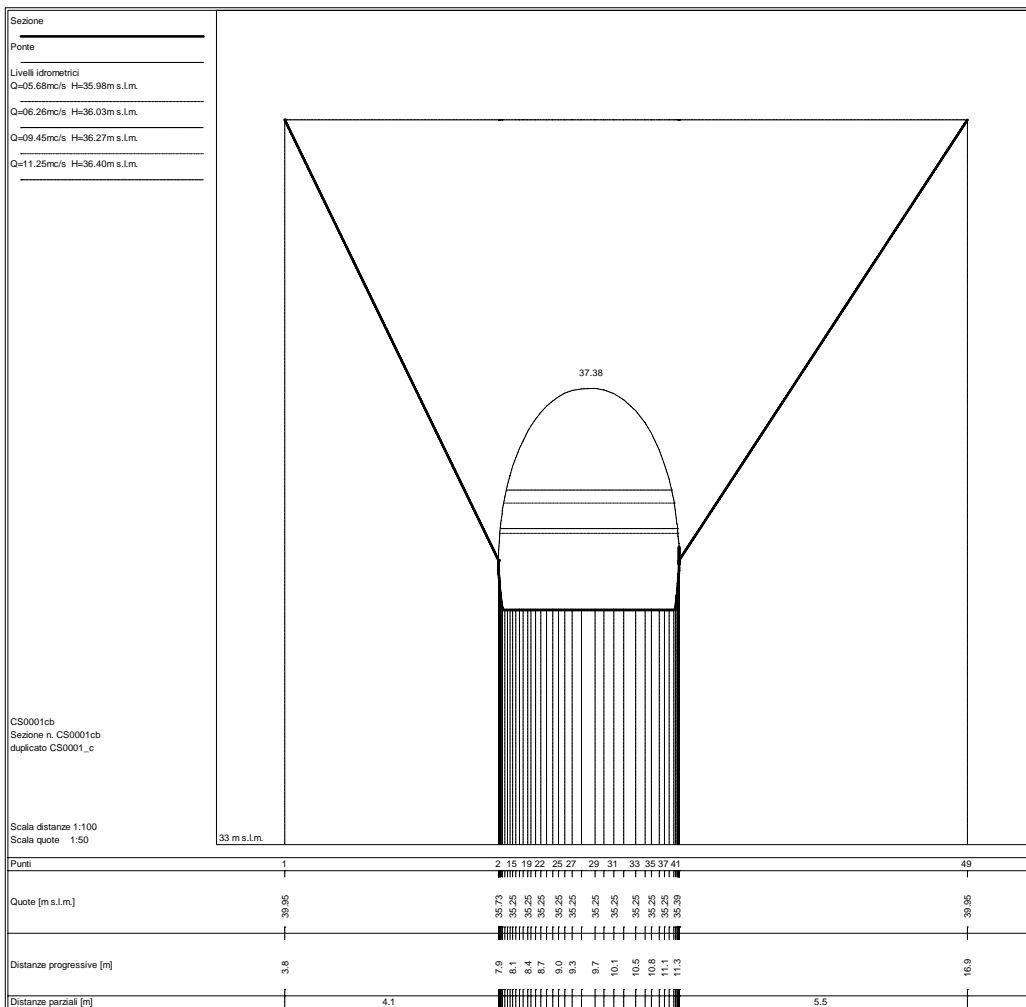
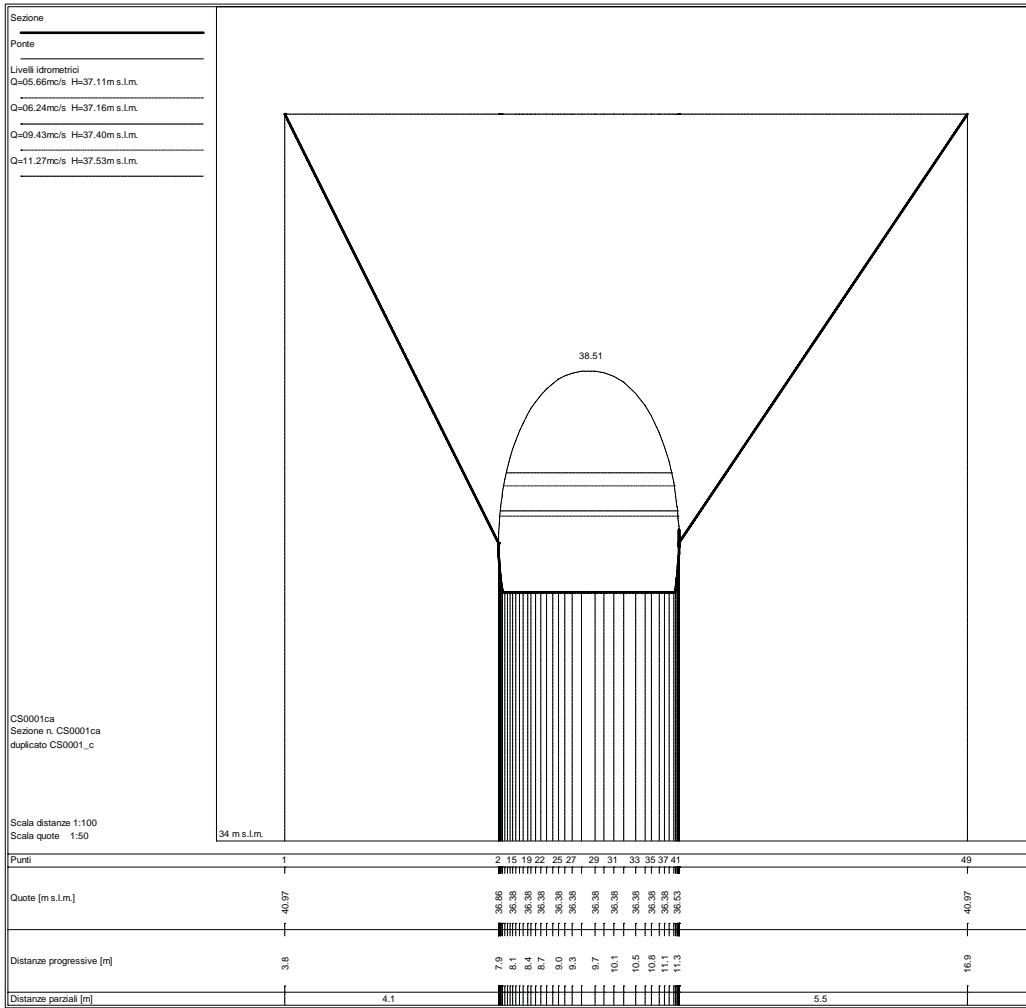

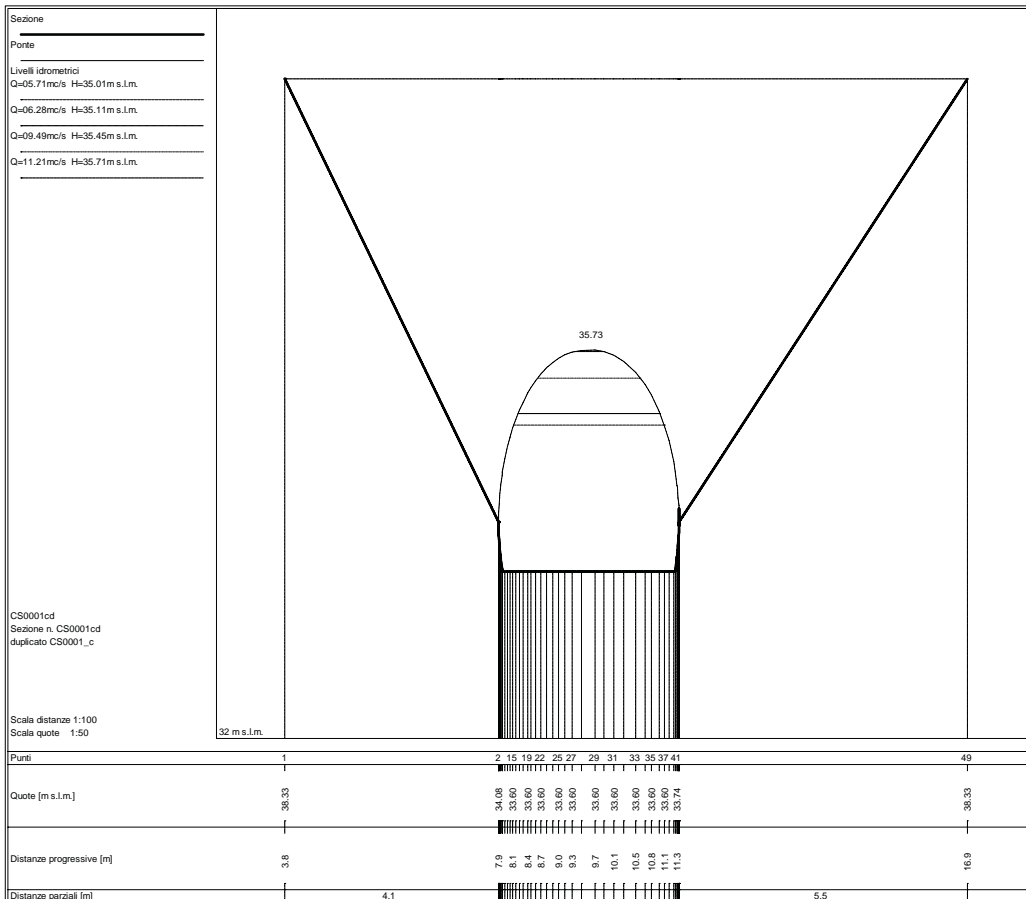
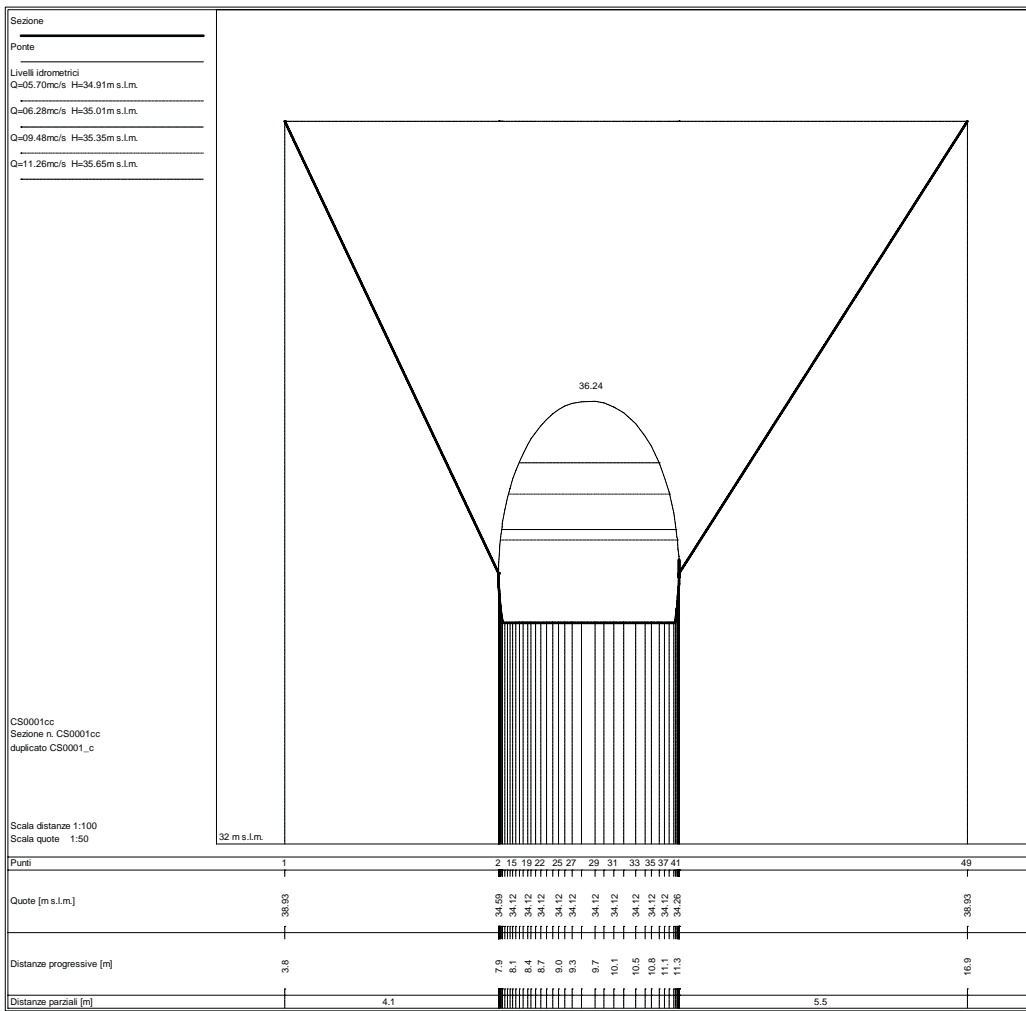

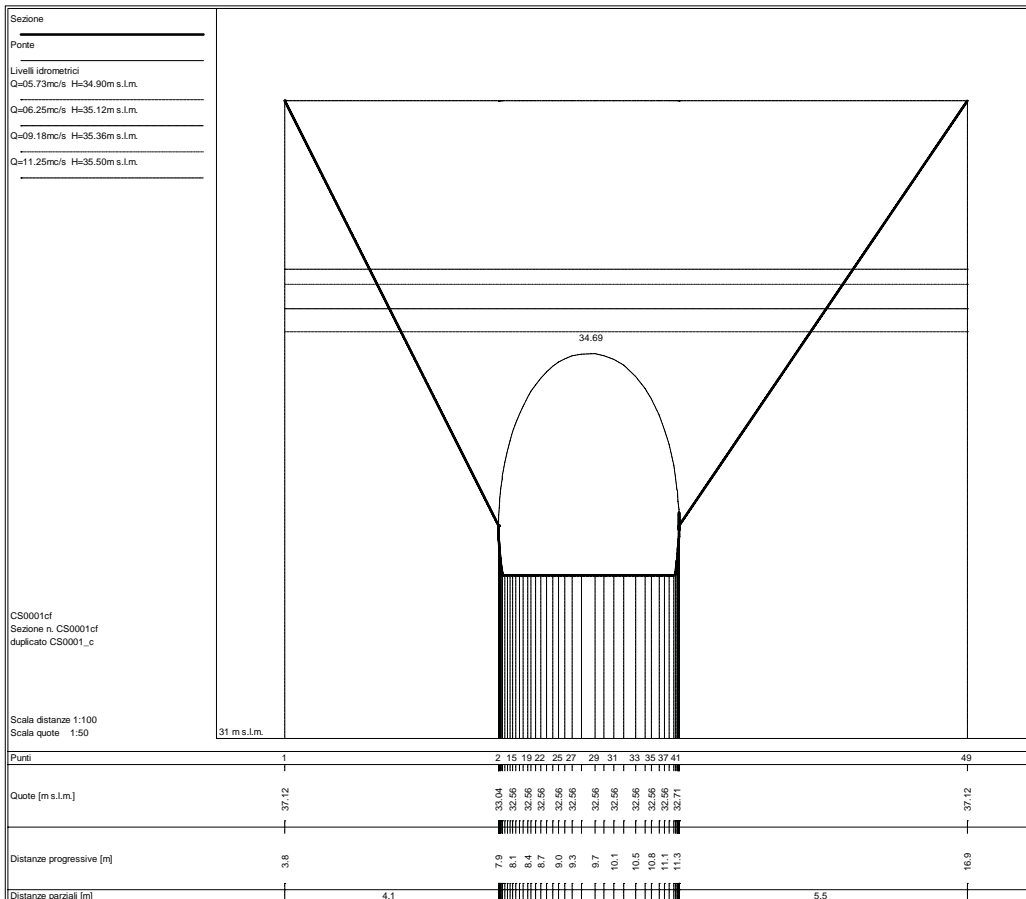
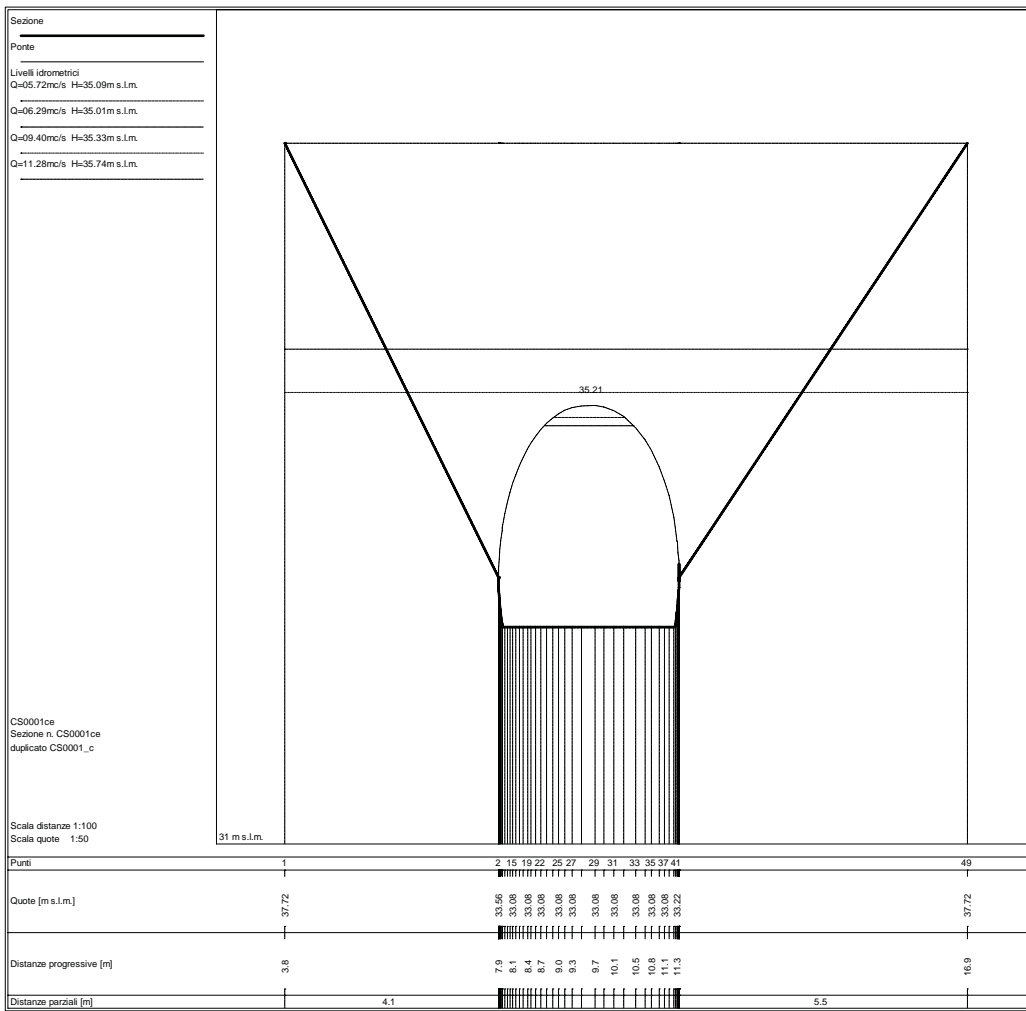

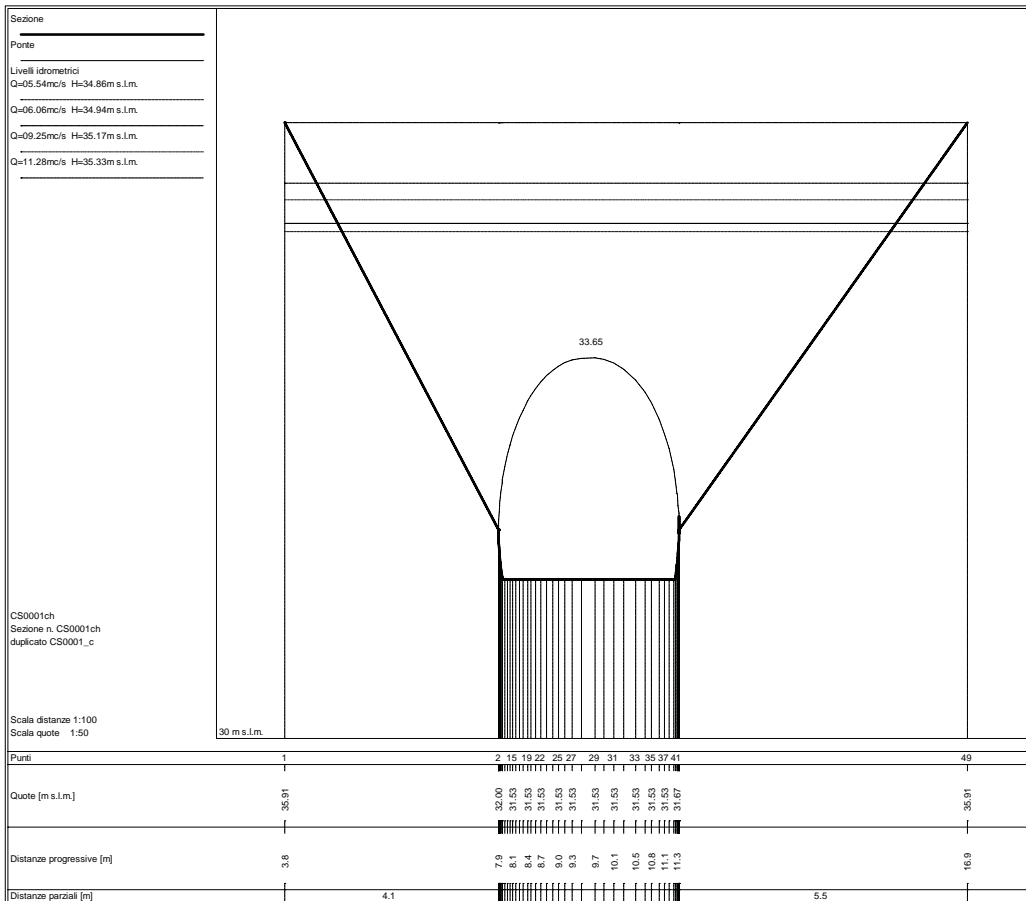
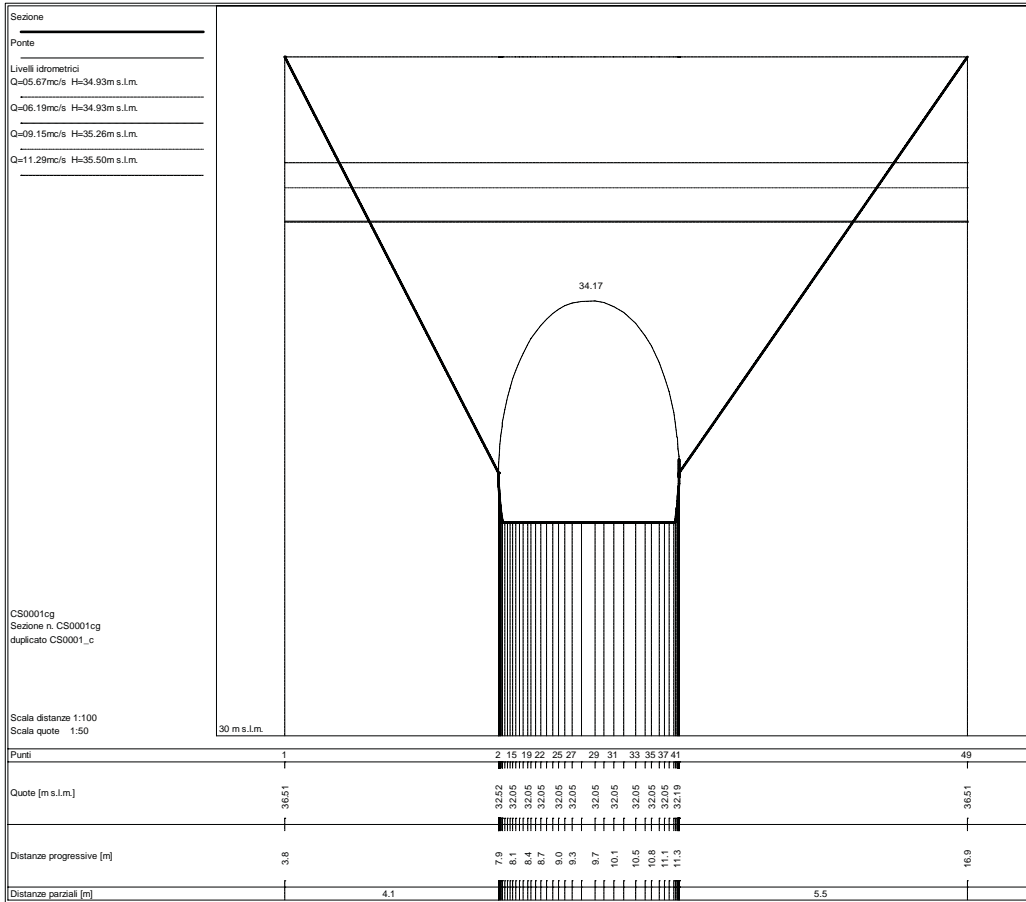

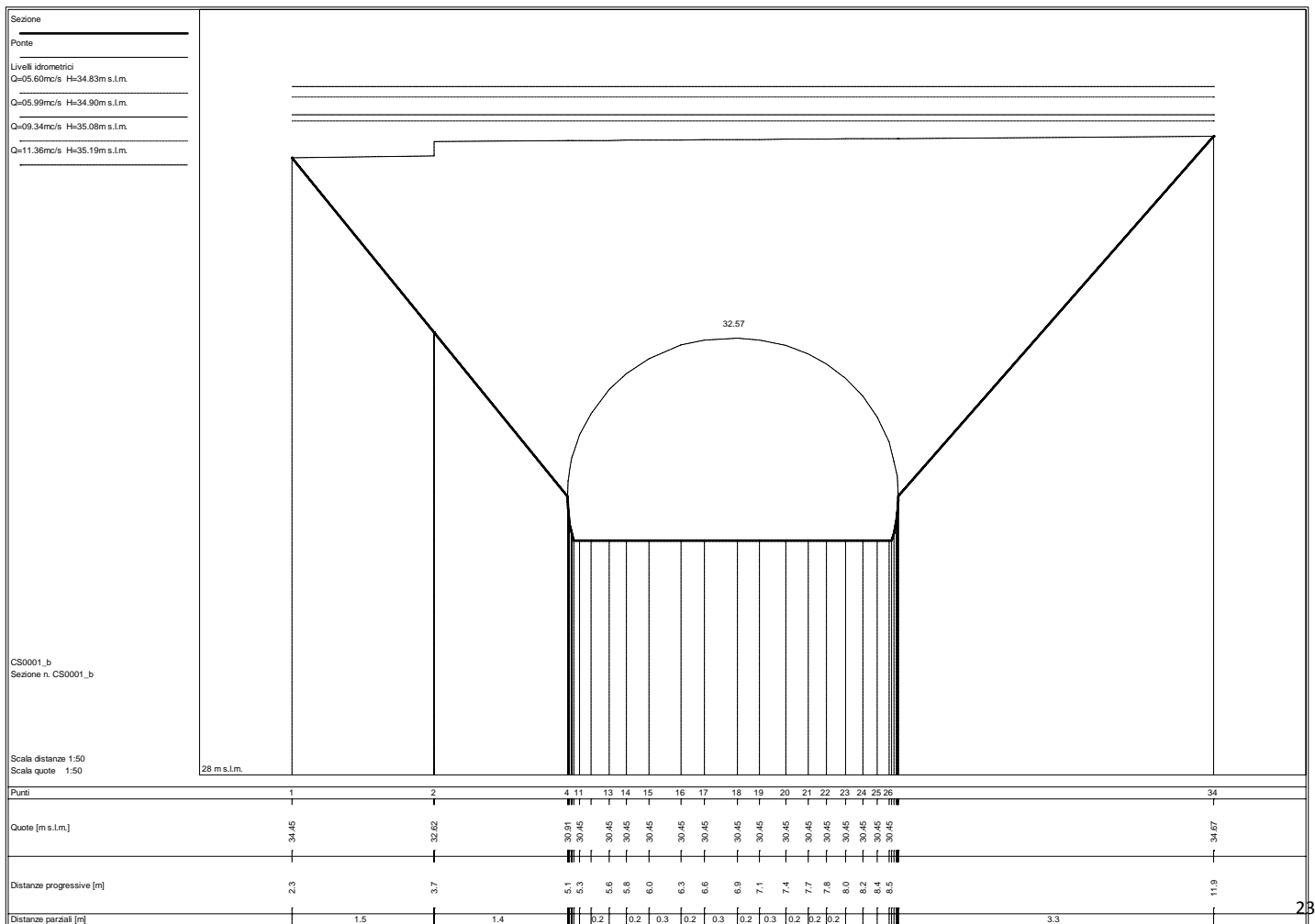
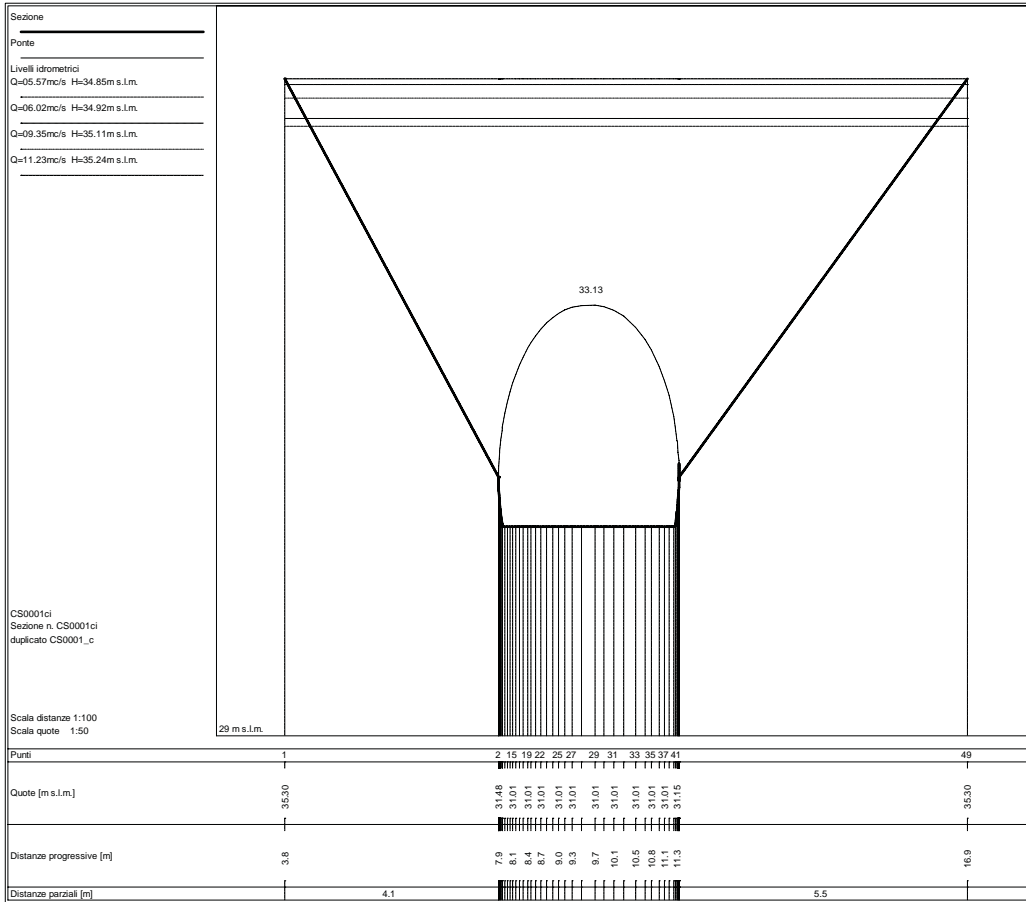

Sezione
 Livelli idrometrici
 Q=05.61mc/s H=34.85m s.l.m.
 Q=05.99mc/s H=34.92m s.l.m.
 Q=09.35mc/s H=35.12m s.l.m.
 Q=11.36mc/s H=35.24m s.l.m.

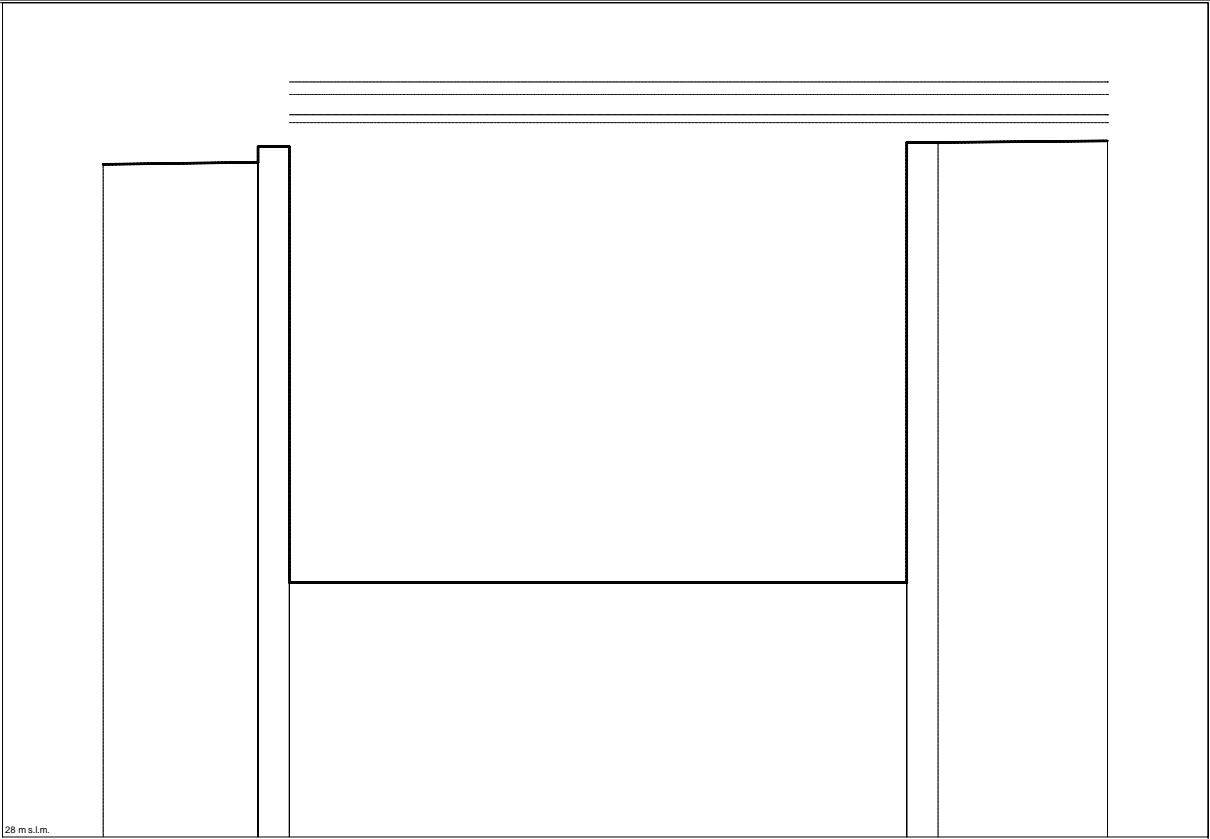

CS0001_d
 Sezione n. CS0001_d

Scala distanze 1:50
 Scala quote 1:50

28 m s.l.m.

Punti	1	2	4	6	8	9
Quote [m s.l.m.]	34.45	34.47	34.62	34.44	34.66	34.67
Distanze progressive [m]	2.3	3.8	4.1	10.0	10.3	11.9
Distanze parziali [m]		1.5	0.3	5.9	0.3	1.6

STATO ATTUALE

Sezioni fluviali fosso Brugiano – BR_a_P

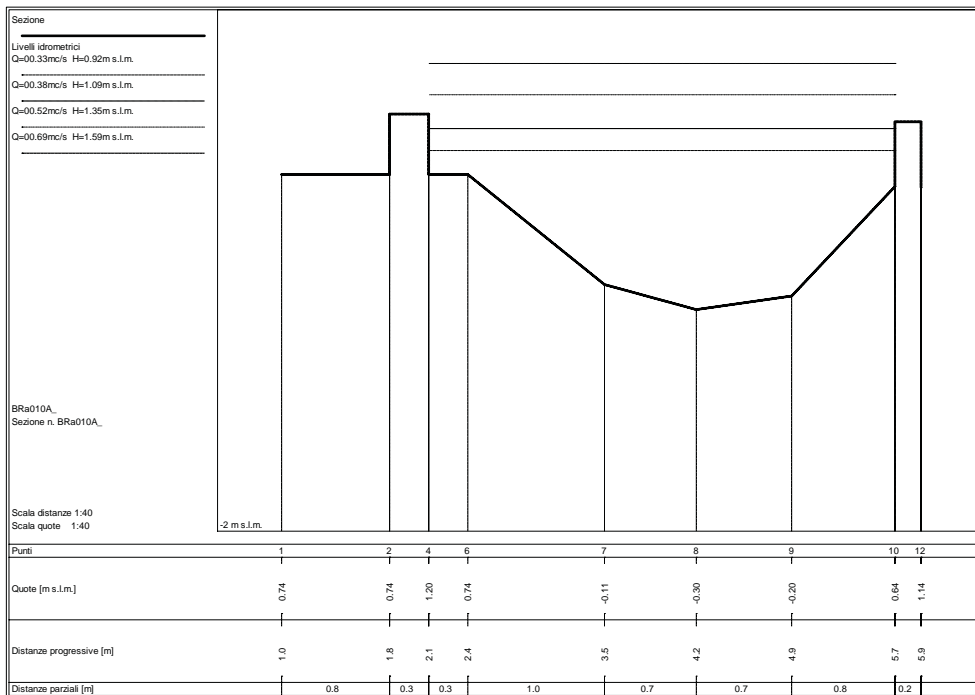
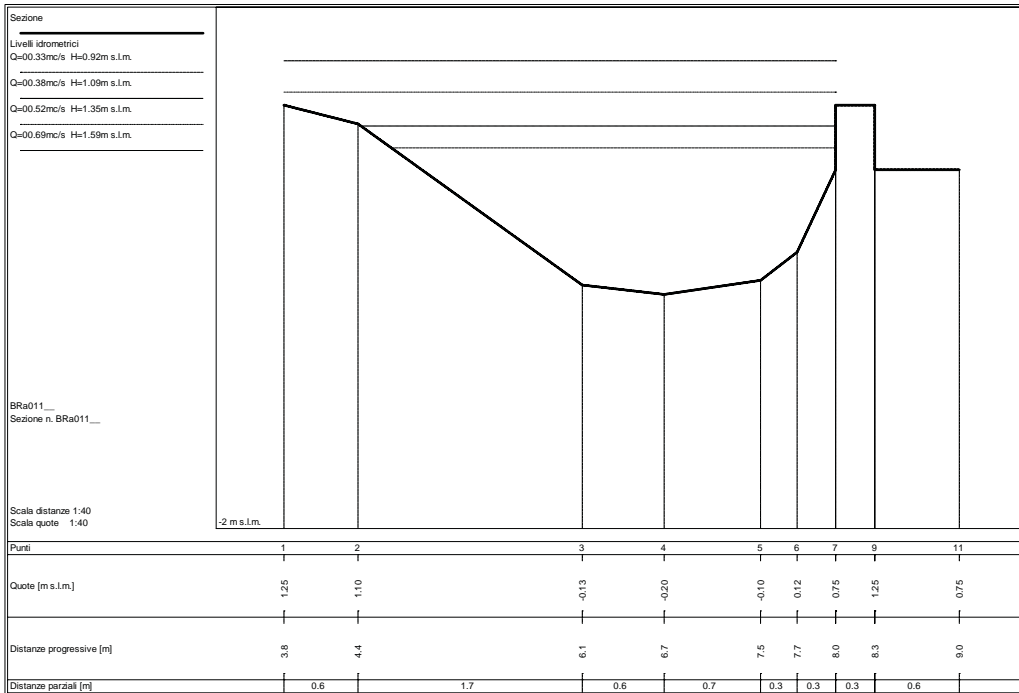

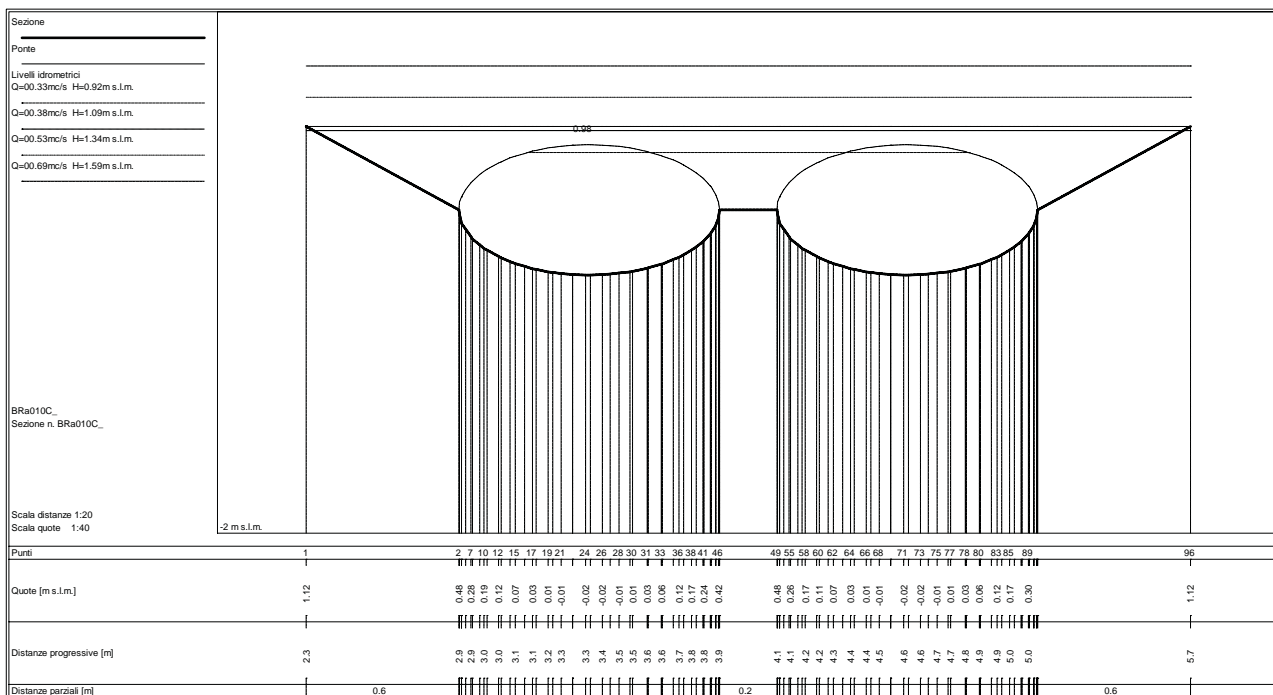
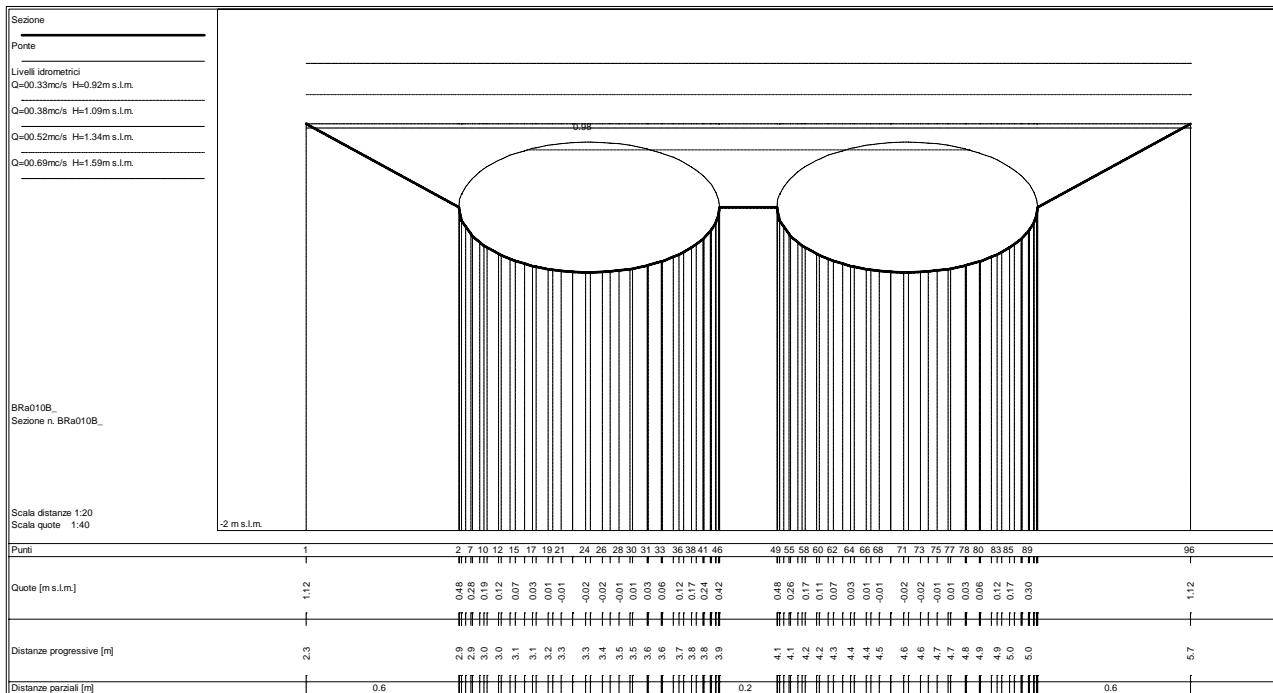

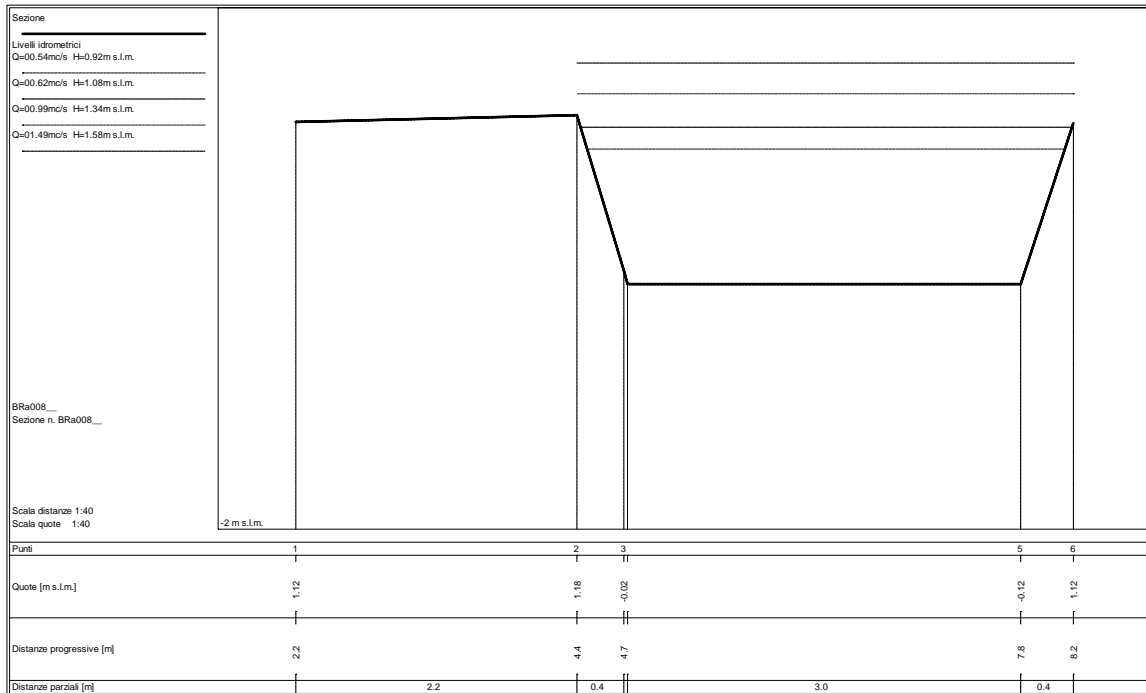
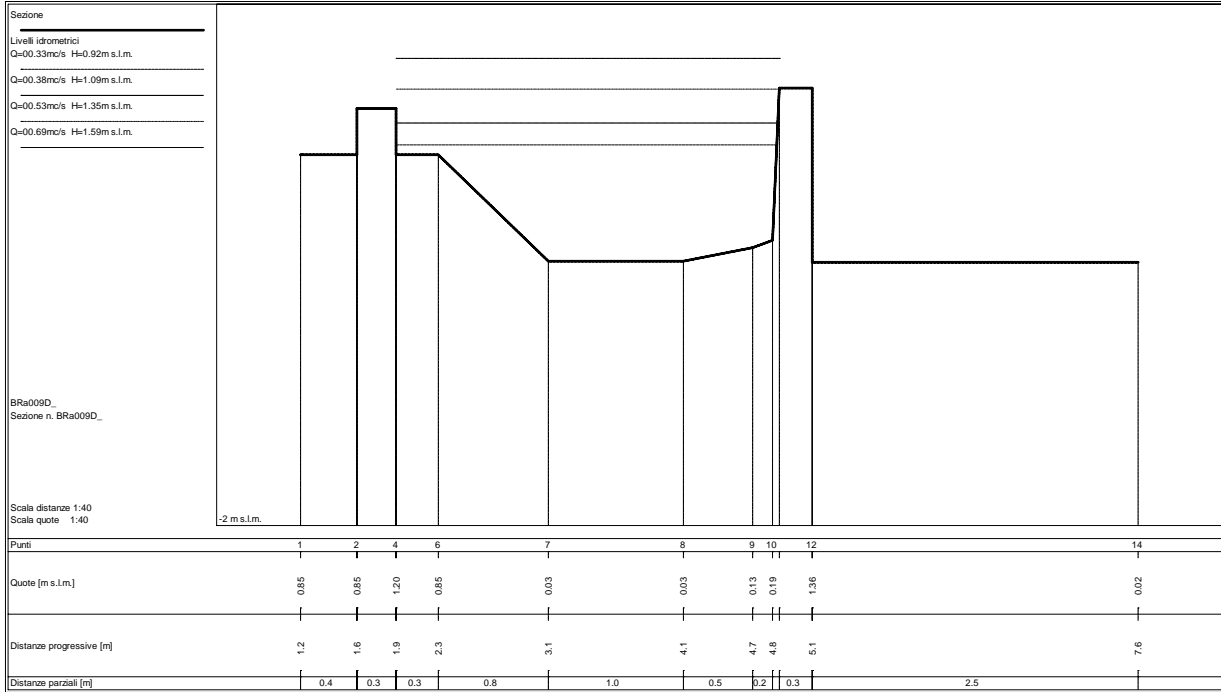

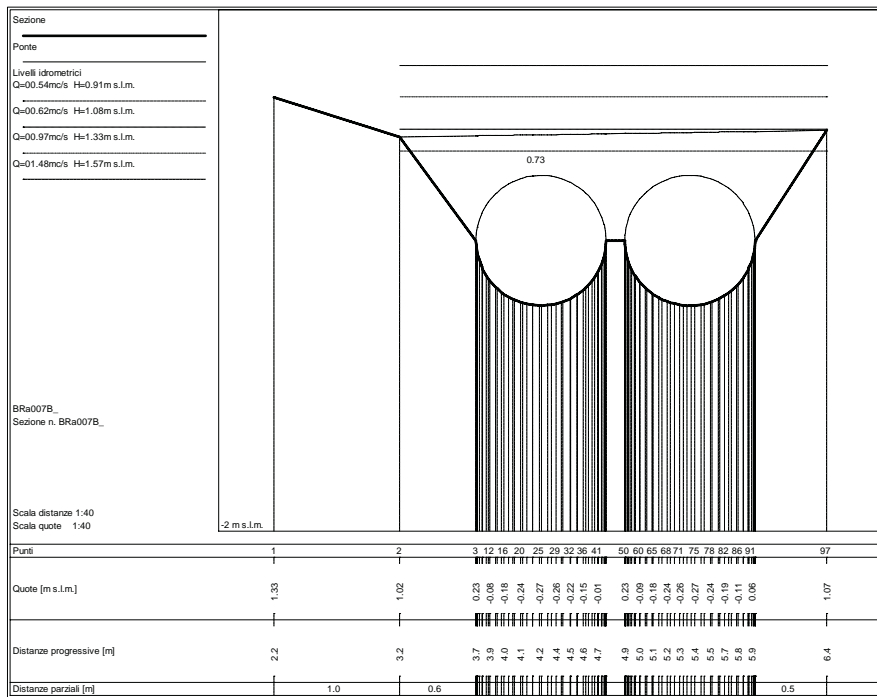
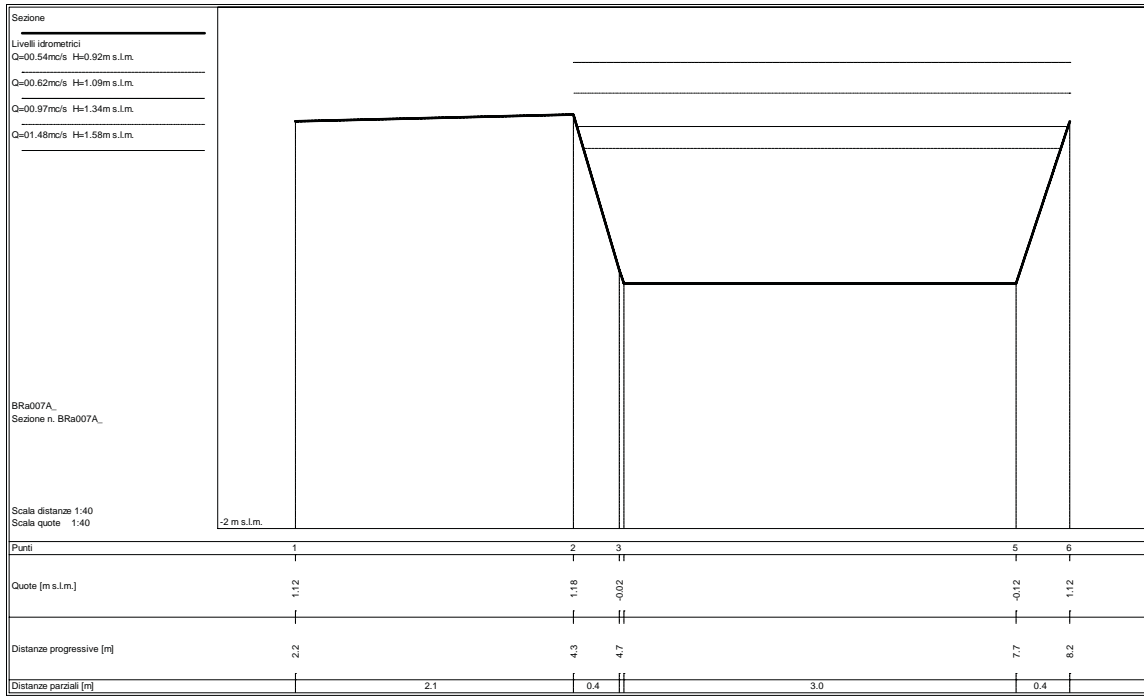

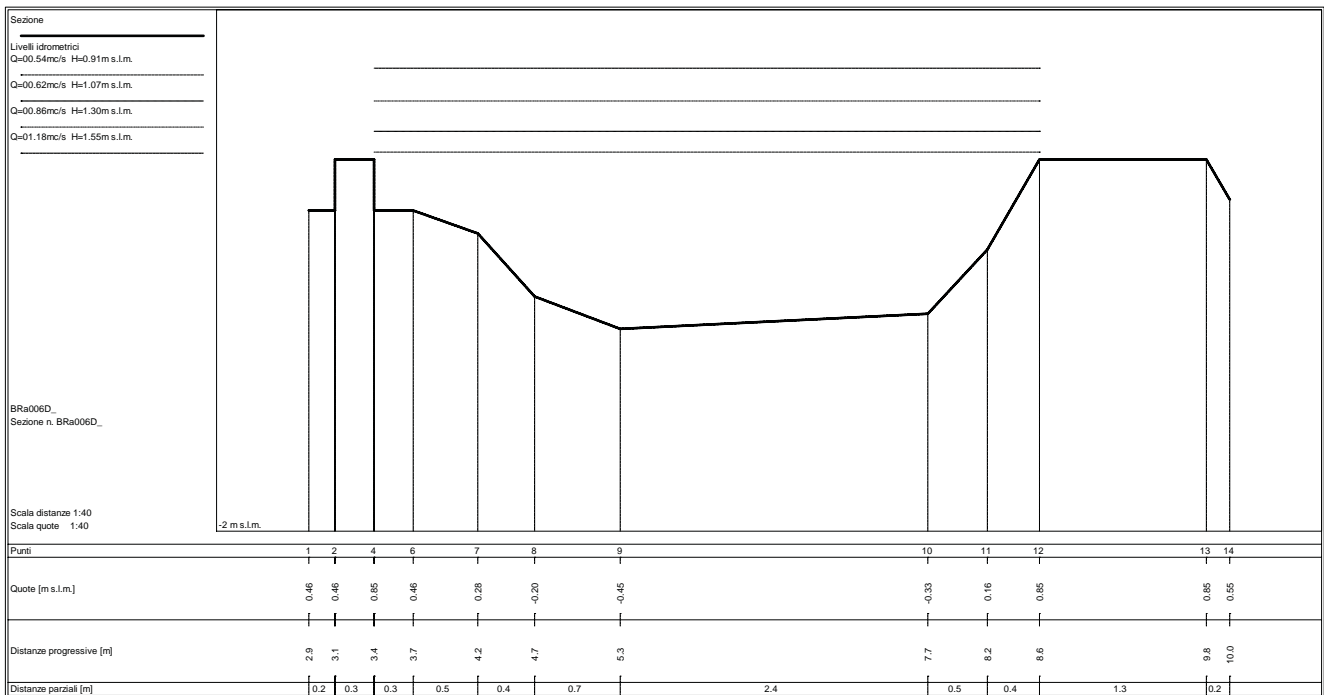
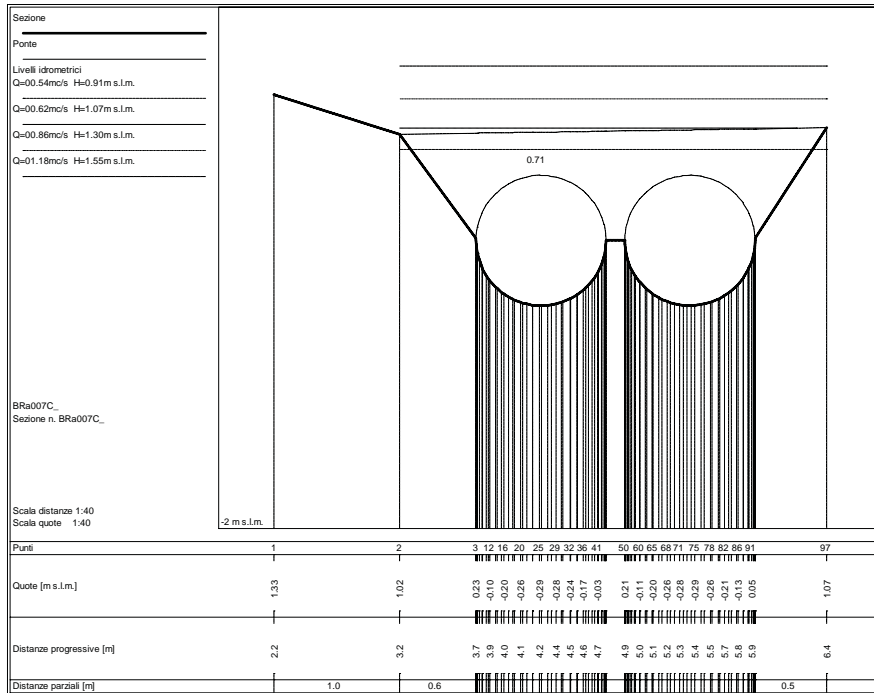

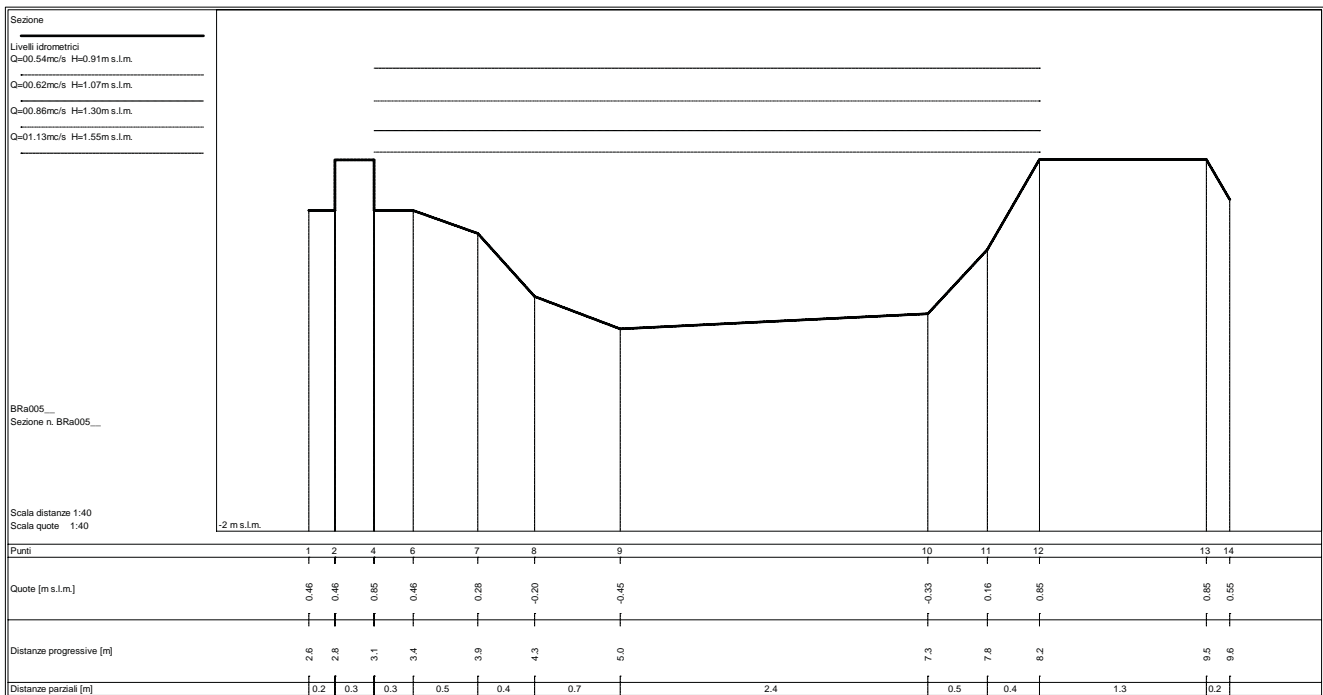
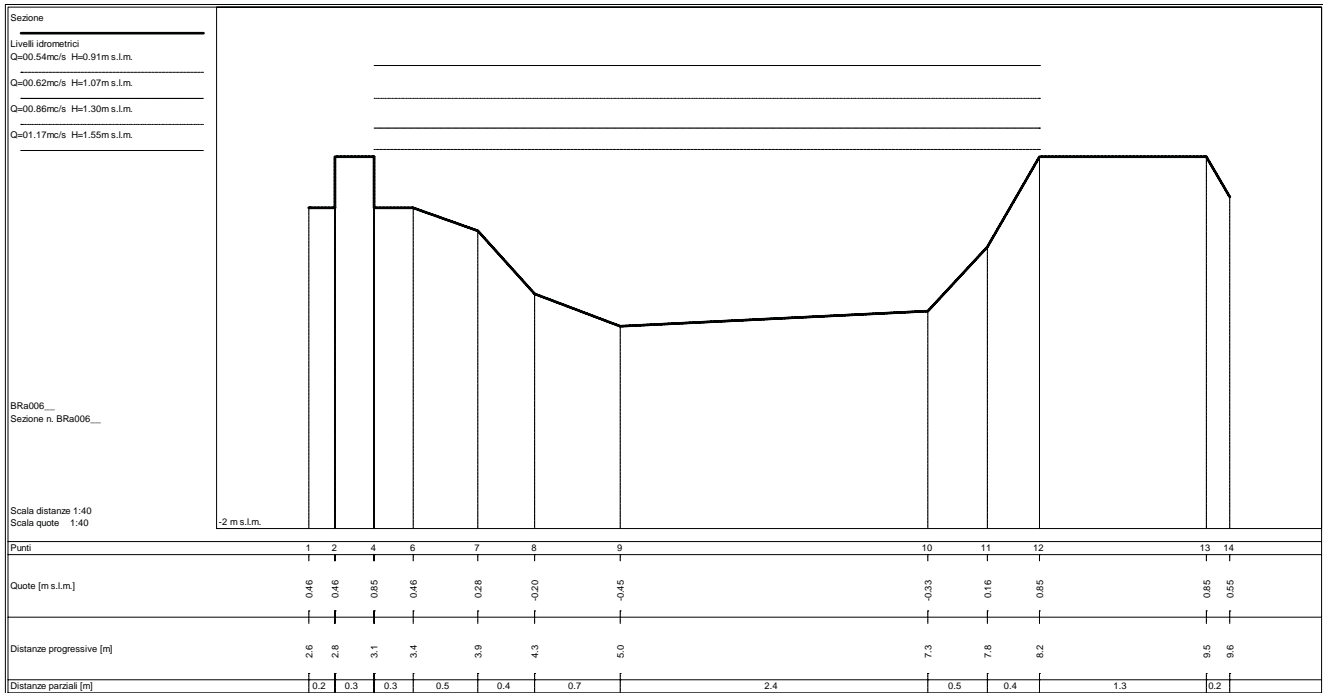

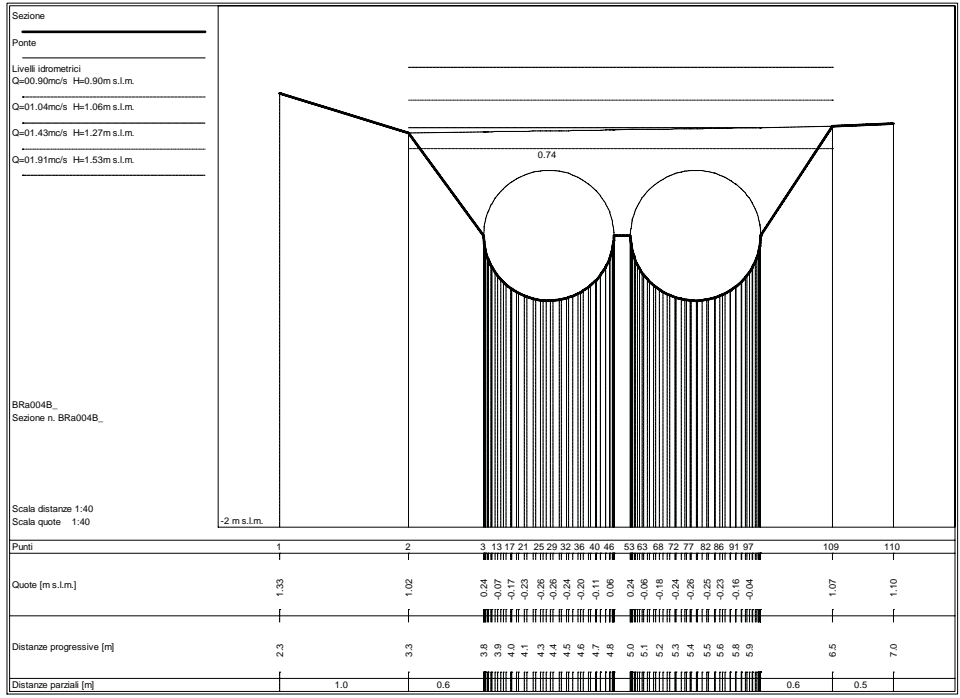
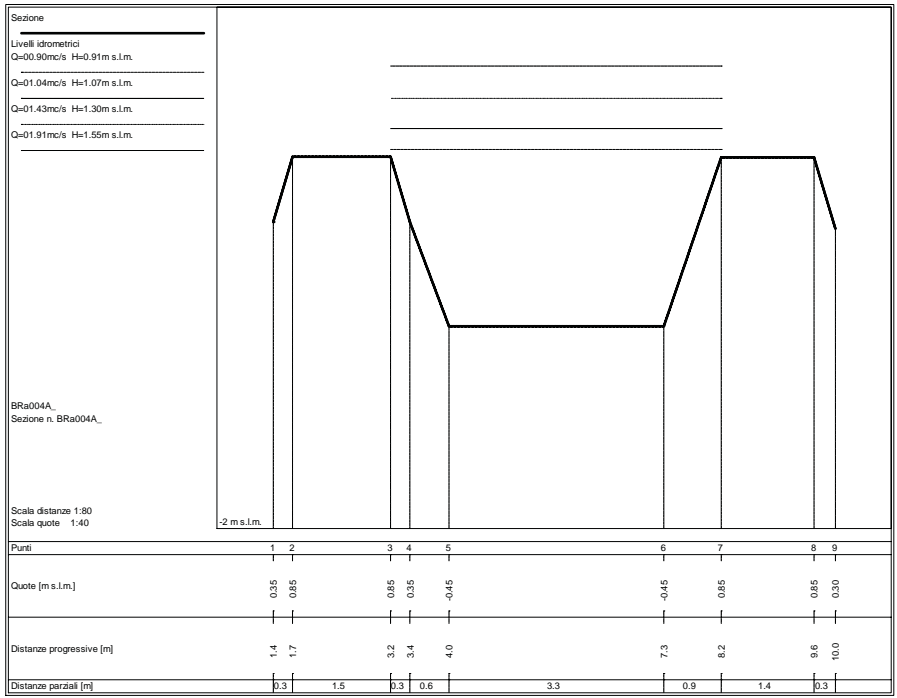

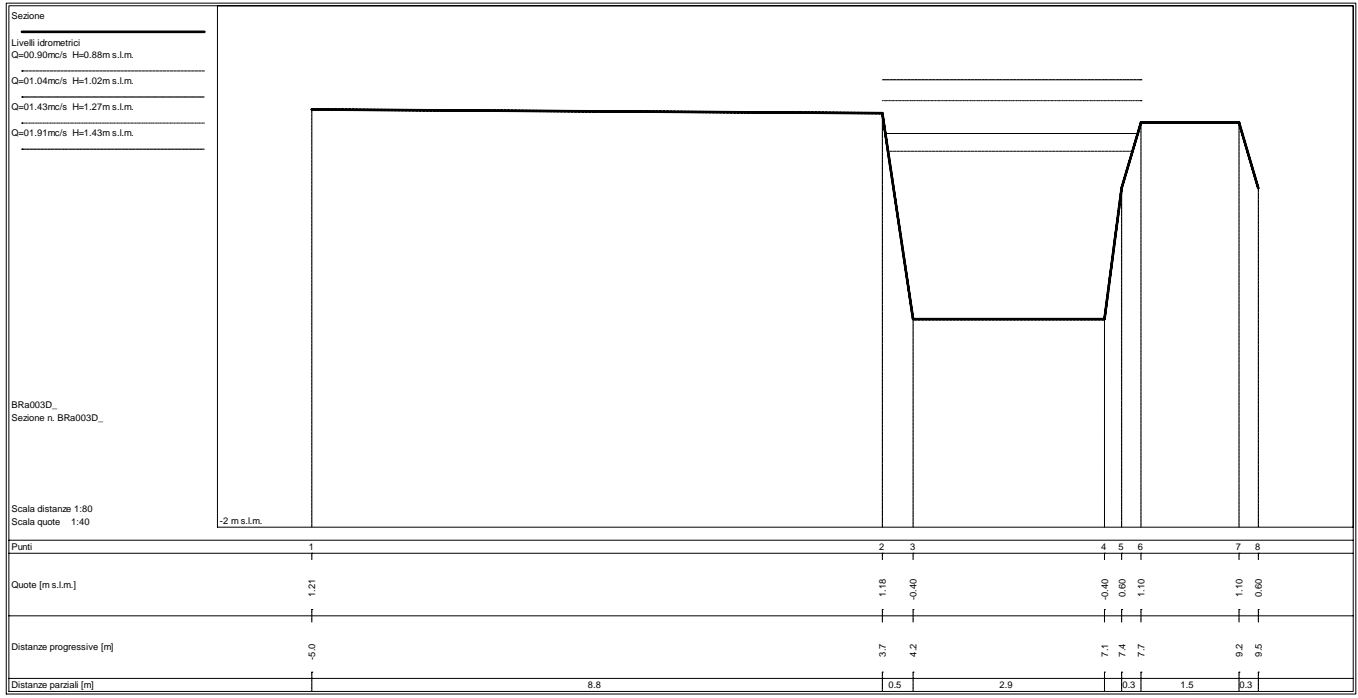
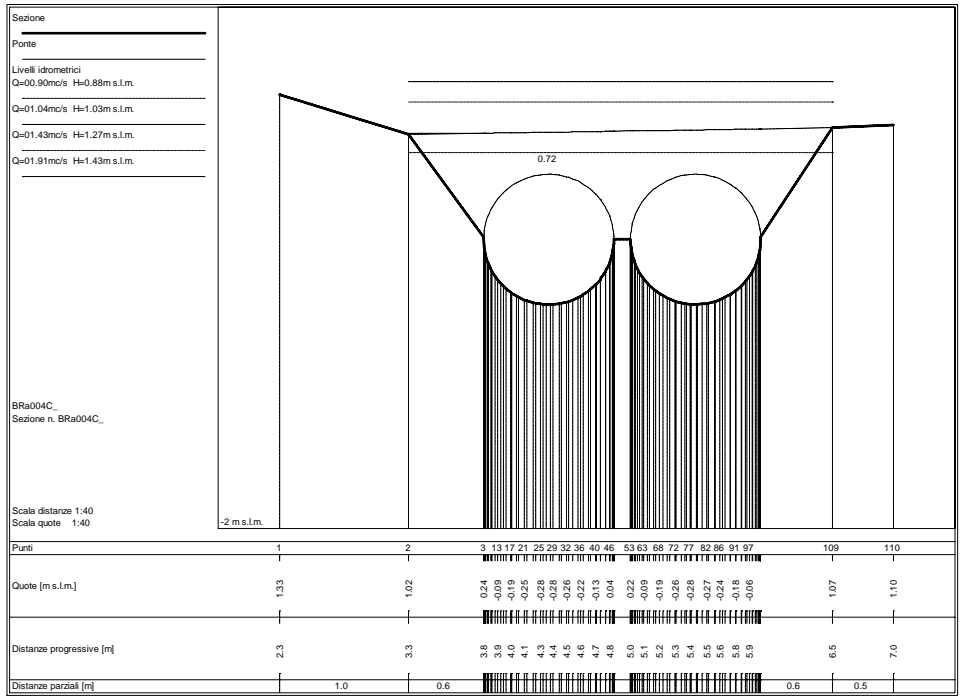

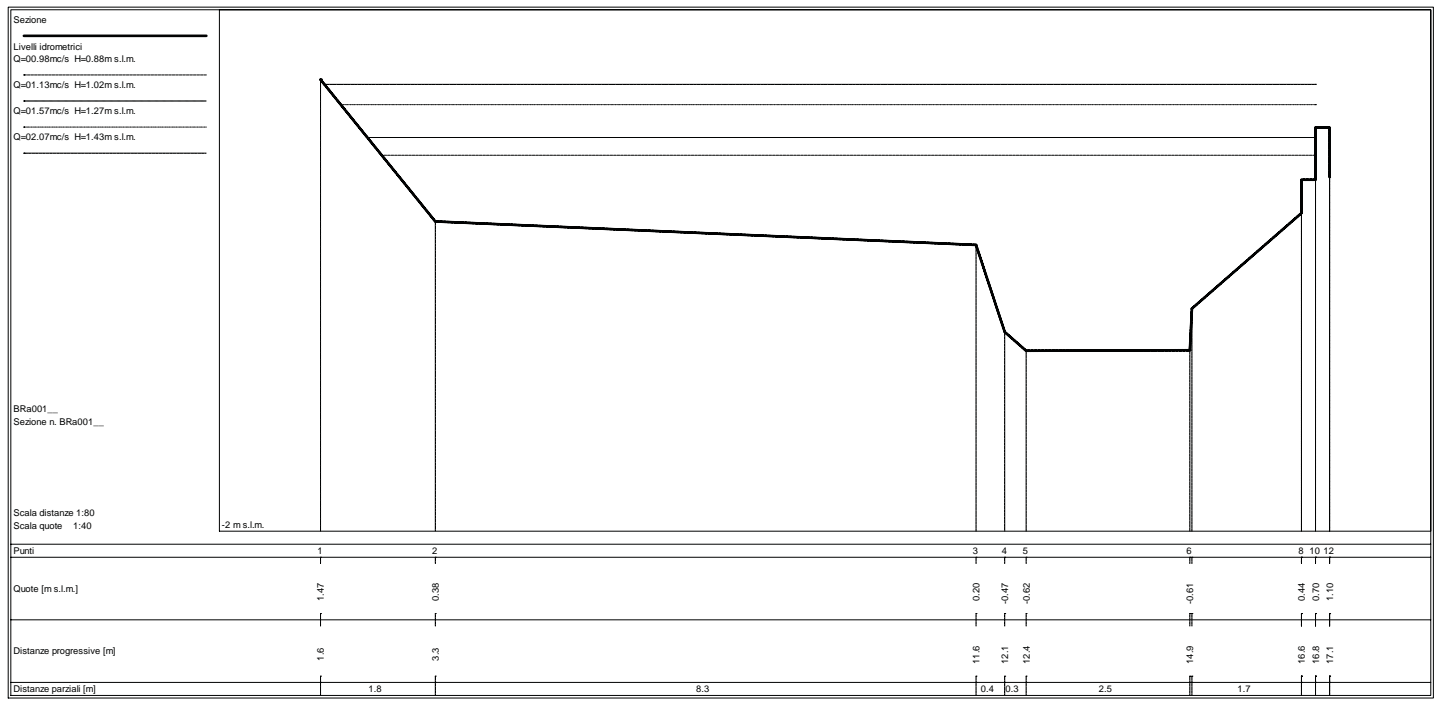
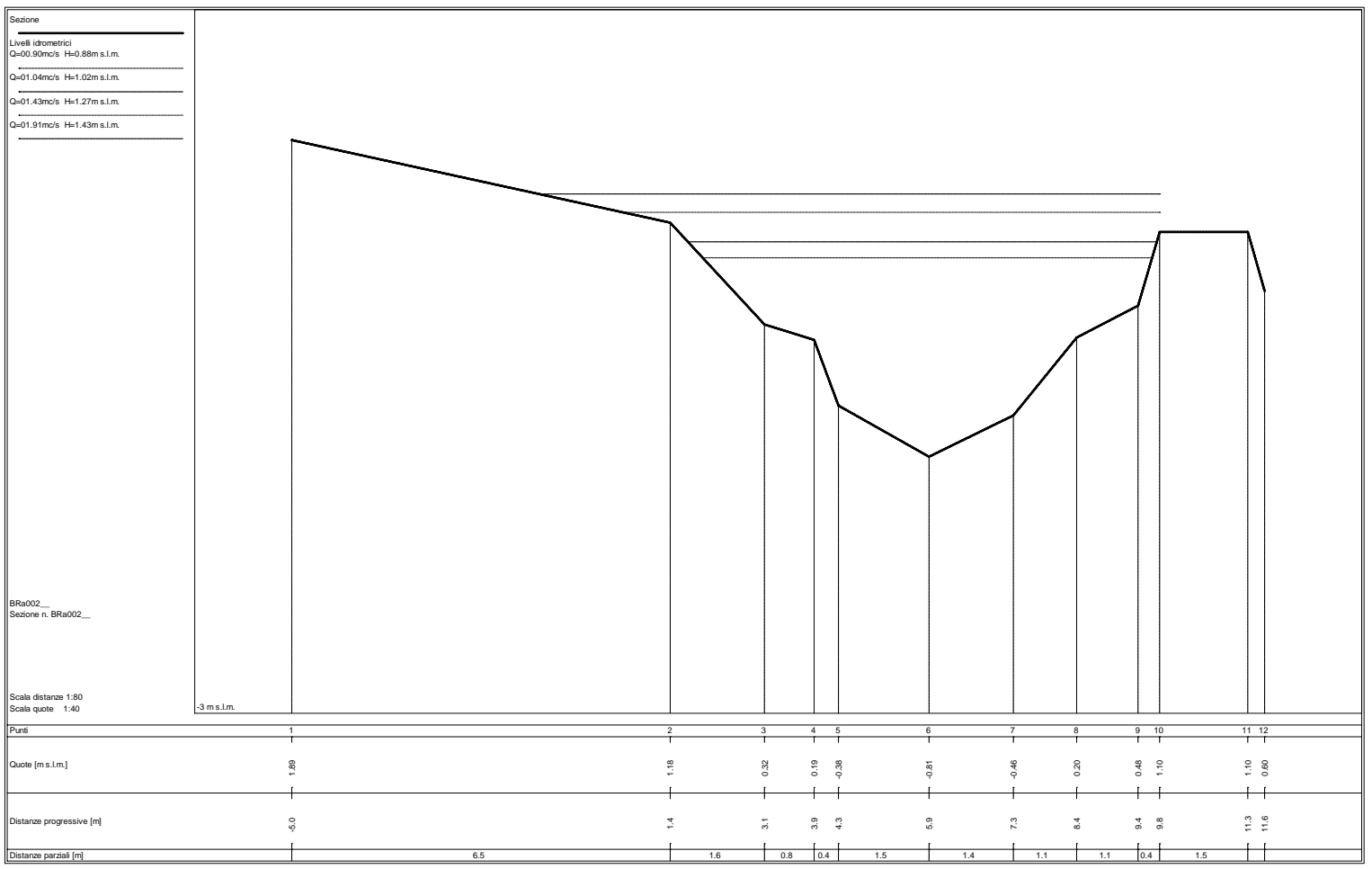

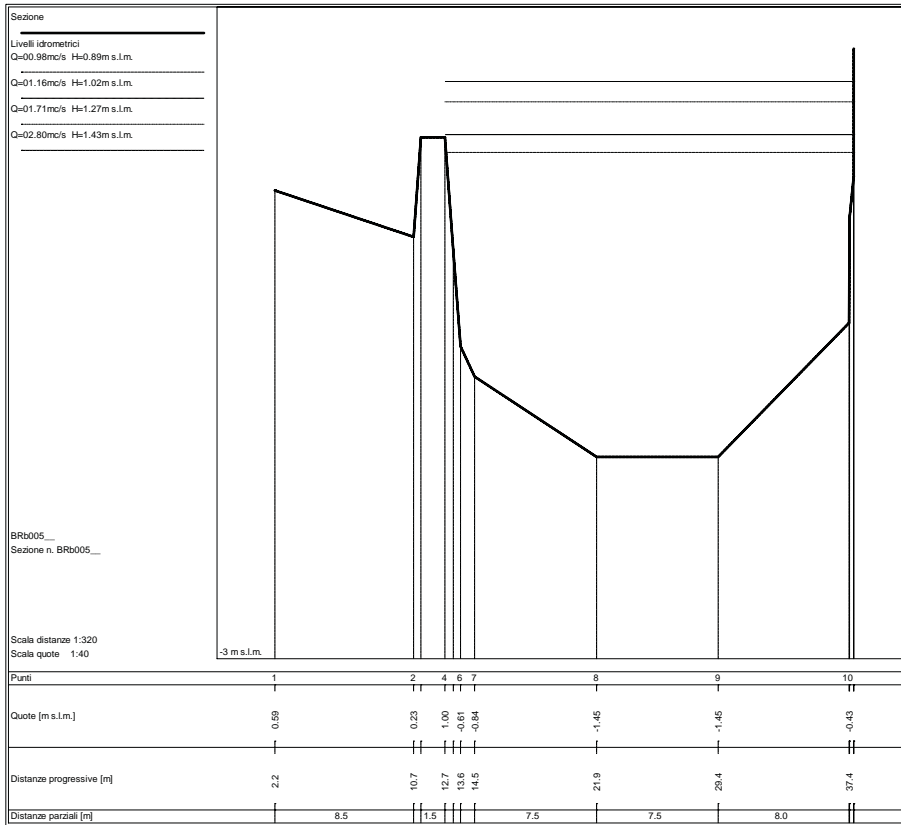

STATO ATTUALE

Sezioni fluviali fosso Brugiano – BR_b_P

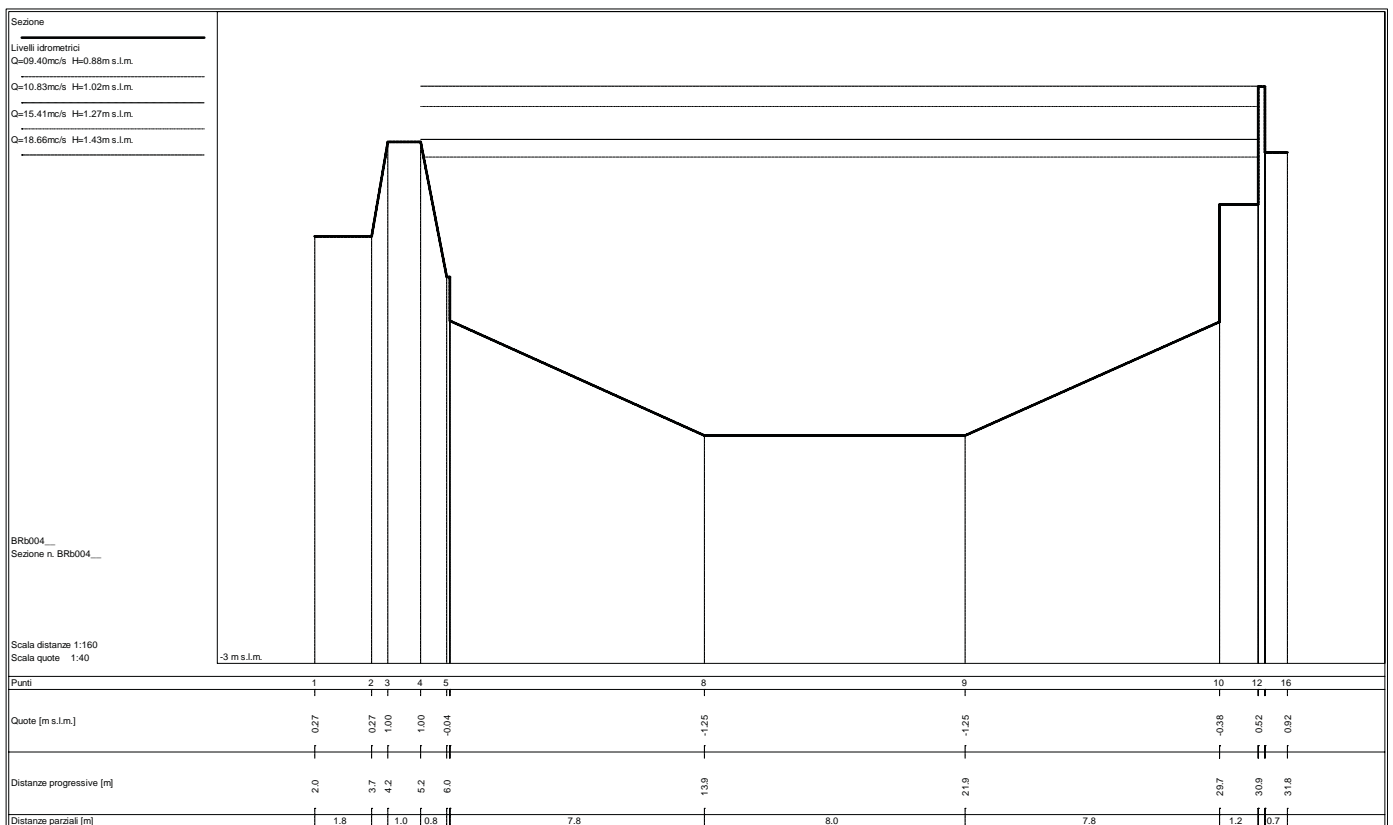
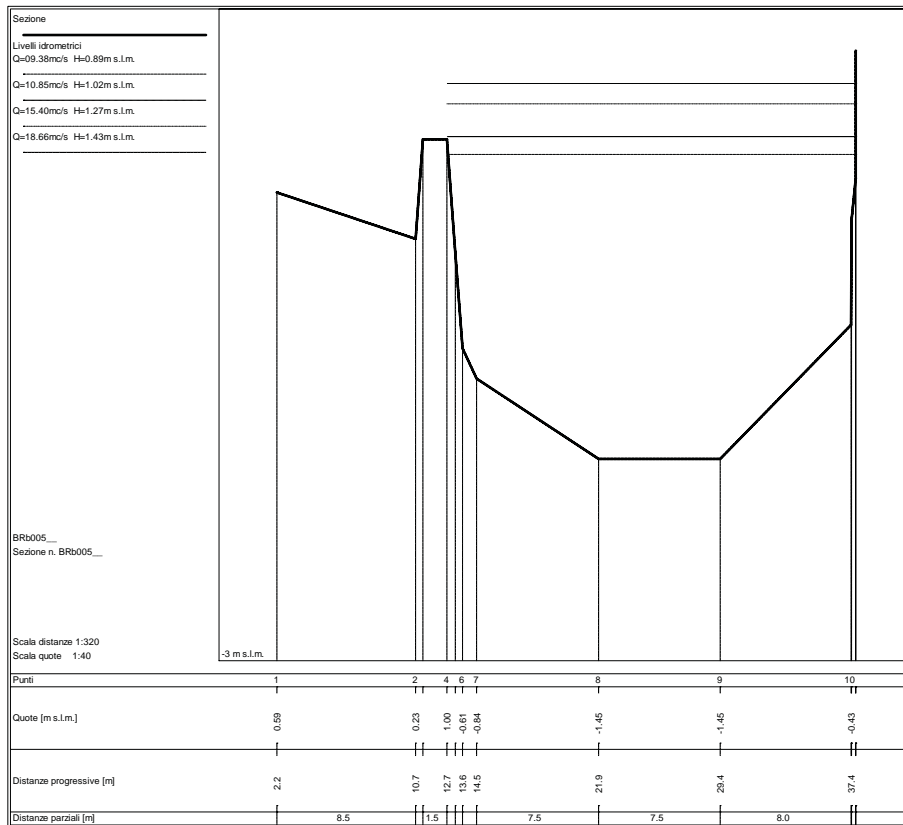

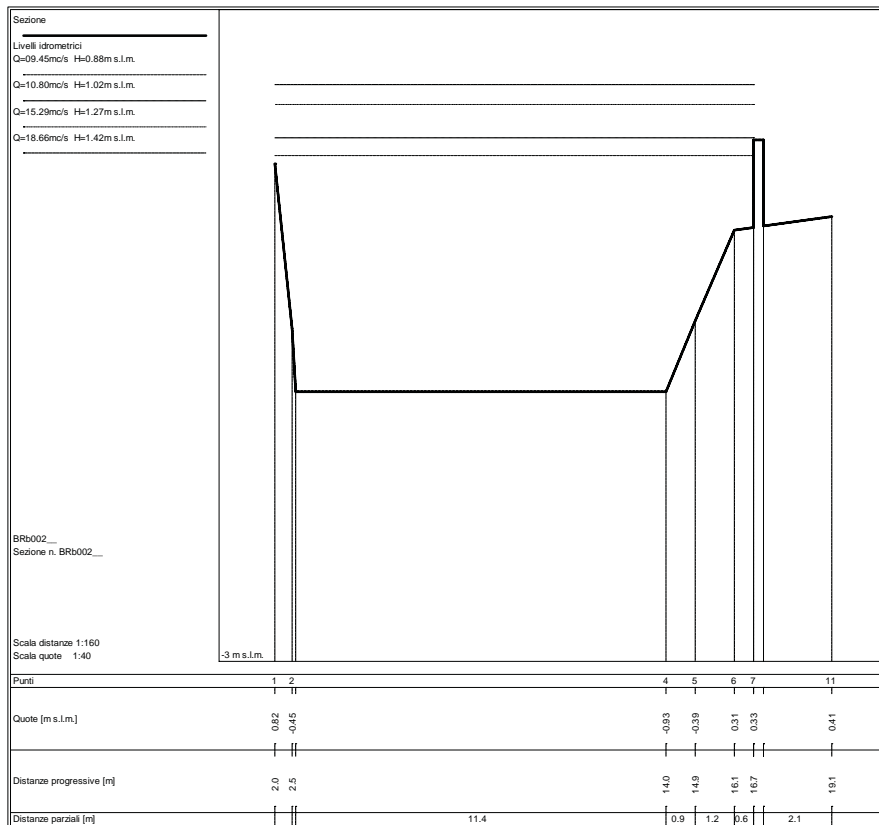
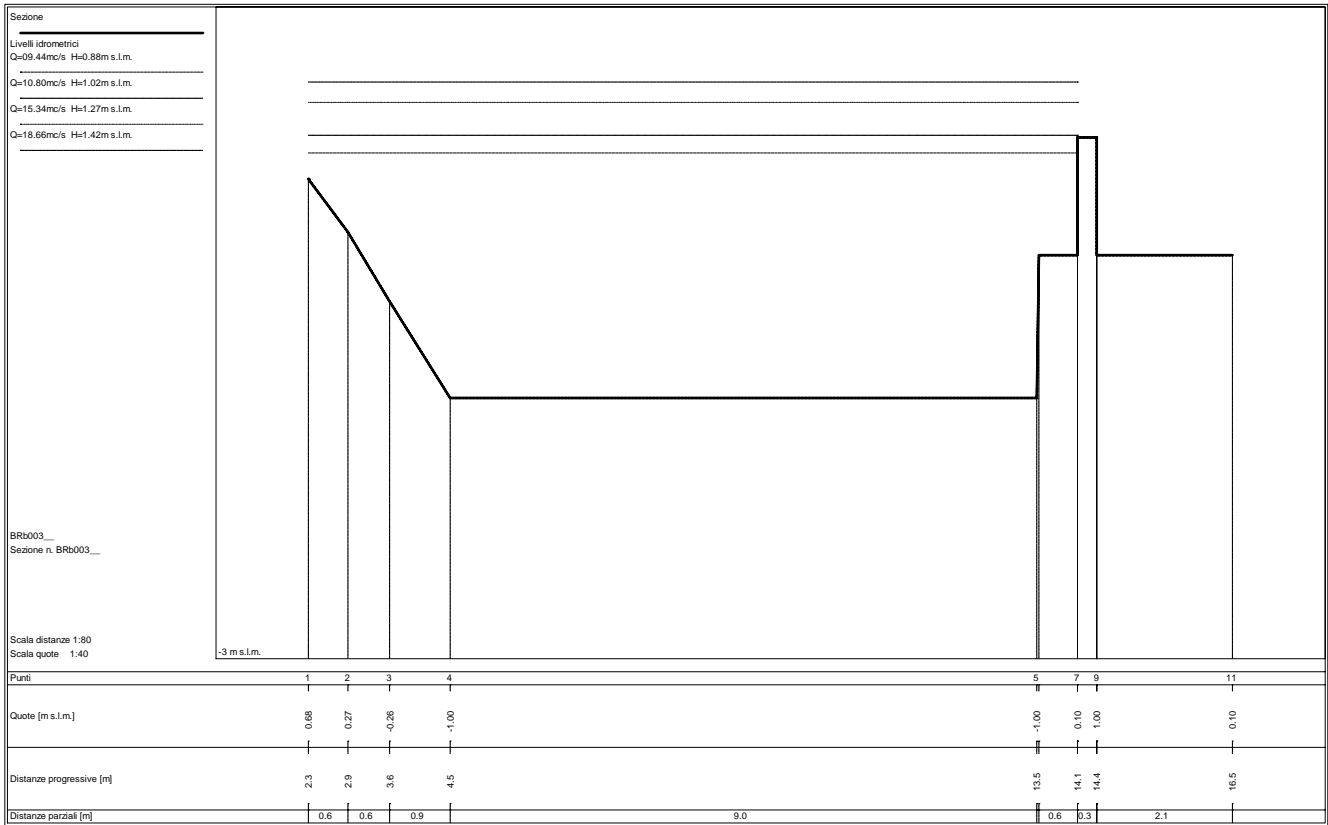

Sezione

Livelli idrometrici
 Q=11.33mc/s H=0.88m s.l.m.
 Q=12.81mc/s H=1.02m s.l.m.
 Q=17.86mc/s H=1.27m s.l.m.
 Q=23.24mc/s H=1.42m s.l.m.

BR001__
 Sezione n. BR001__

Scala distanze 1:160
 Scala quote 1:40

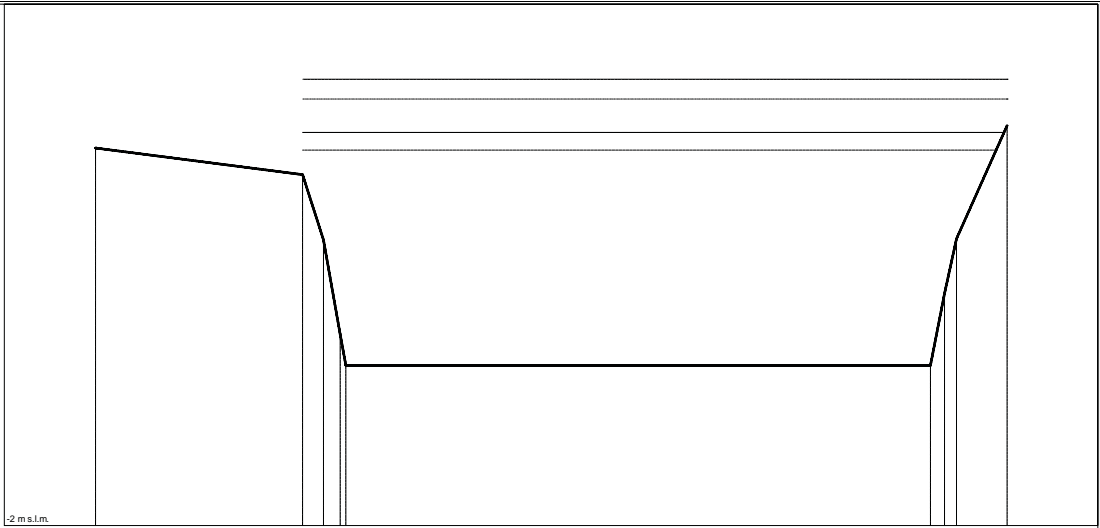

Punti	1	2	3	4	6	7	8	9
Quote [m s.l.m.]	0.90	0.89	0.19	-0.83	-0.77	-0.22	0.20	1.07
Distanze progressive [m]	2.0	8.3	9.0	9.5	27.6	28.0	28.4	30.0
Distanze parziali [m]		6.4	0.6		17.9		1.6	

STATO ATTUALE

Sezioni fluviali fosso Brugiano – BR_c_P

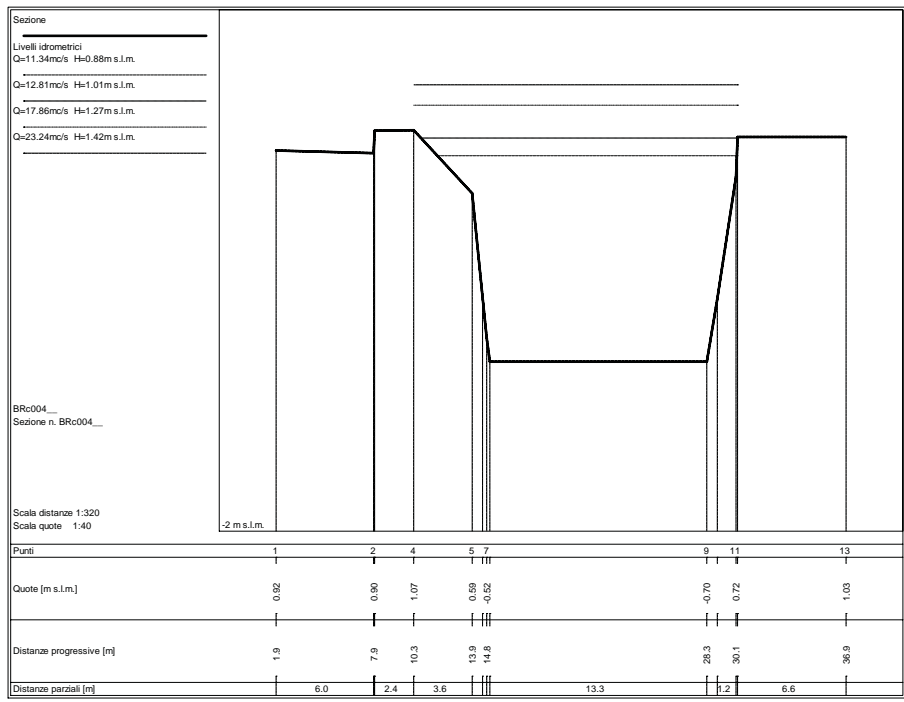
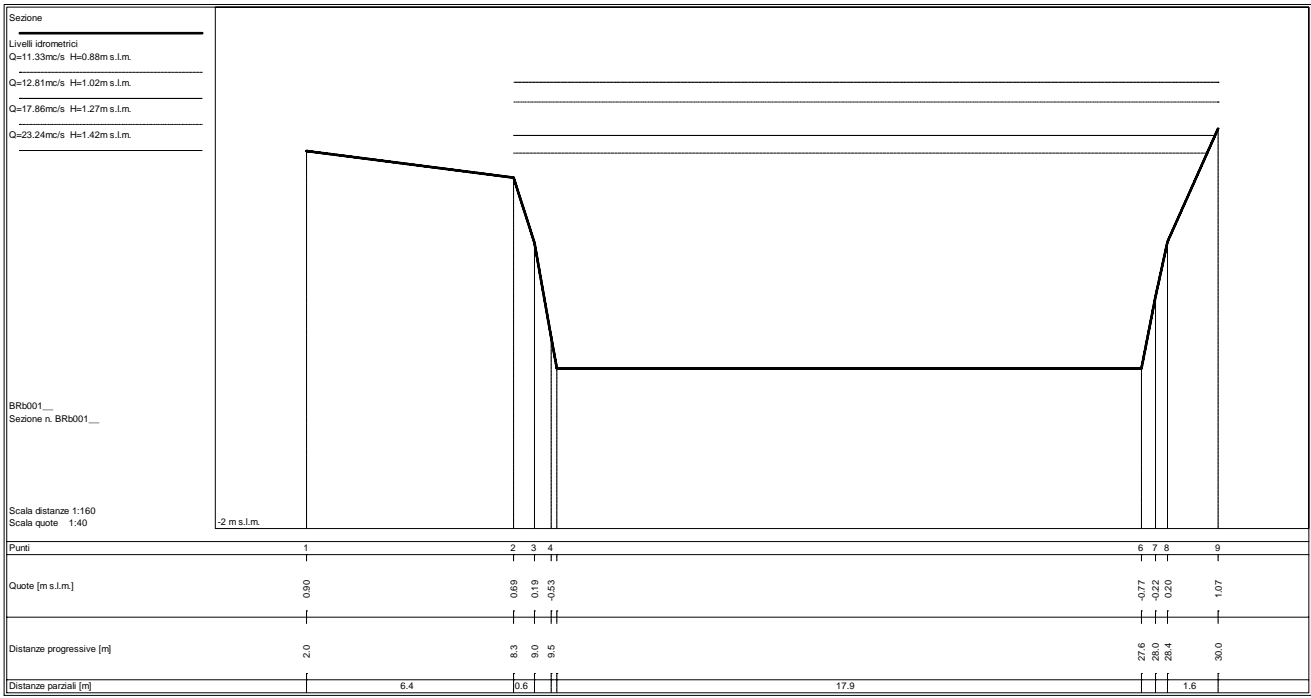

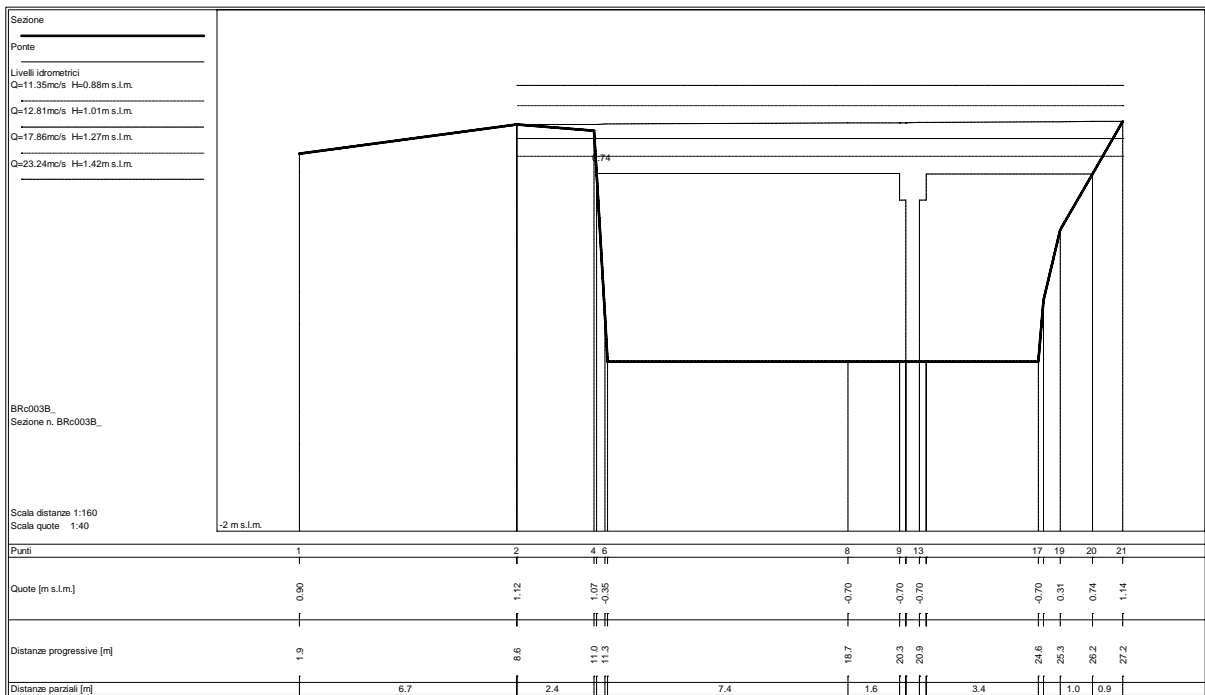
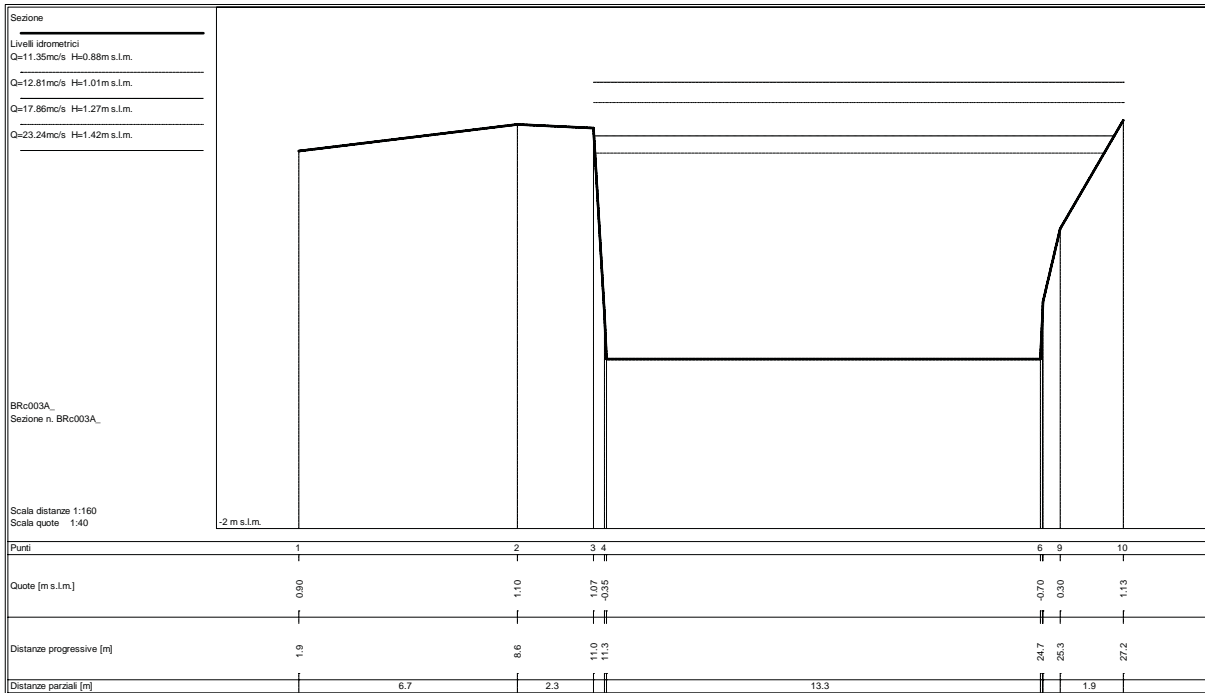

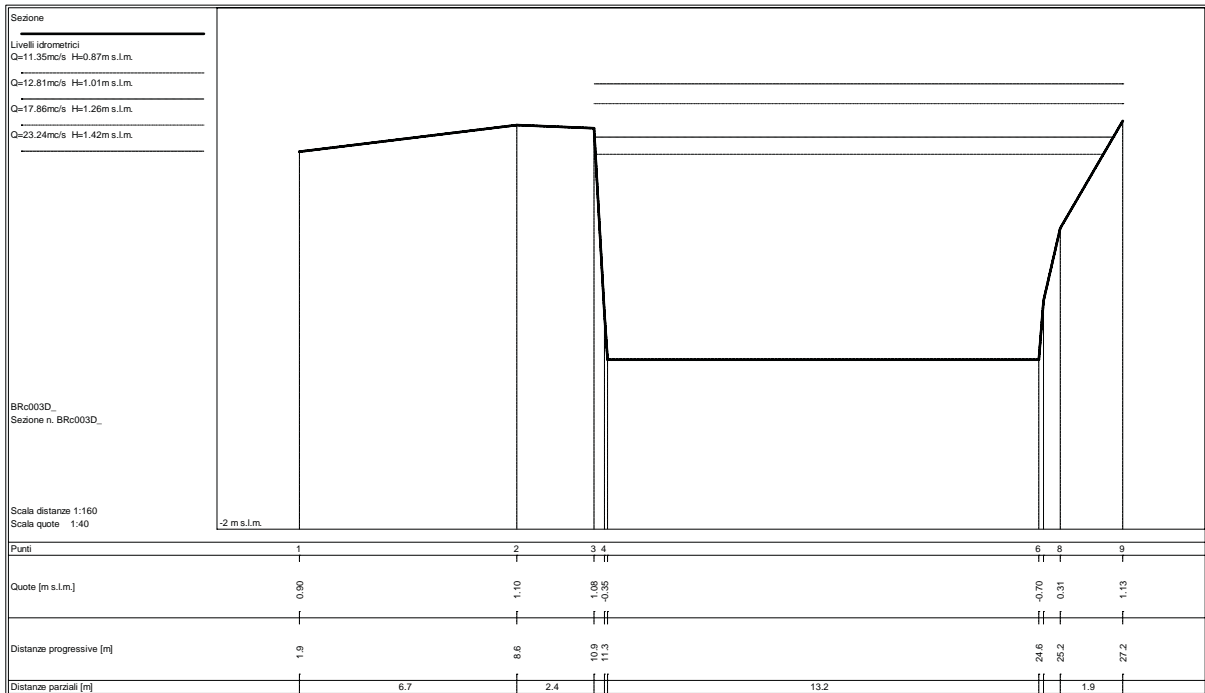
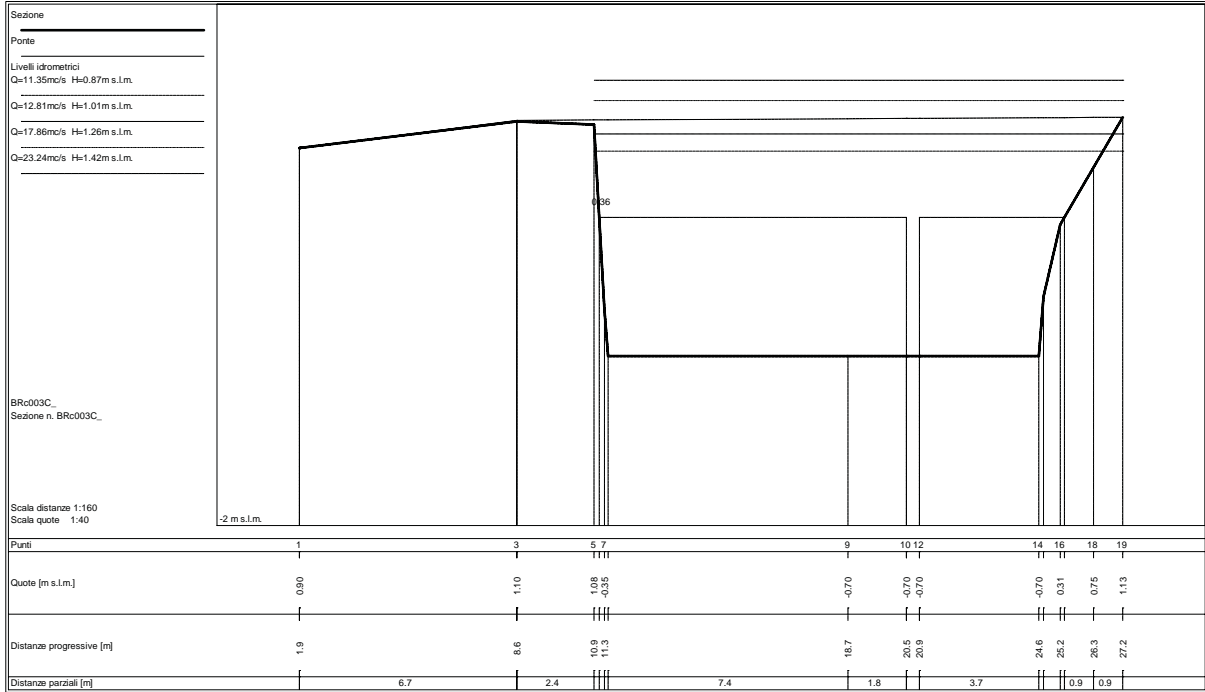

Sezione

 Livelli idrometrici
 Q=11.35mc/s H=0.88m s.l.m.

 Q=12.81mc/s H=1.01m s.l.m.

 Q=17.86mc/s H=1.26m s.l.m.

 Q=23.24mc/s H=1.42m s.l.m.

BRc002
 Sezione n. BRc002

Scala distanze 1:160
 Scala quote 1:40

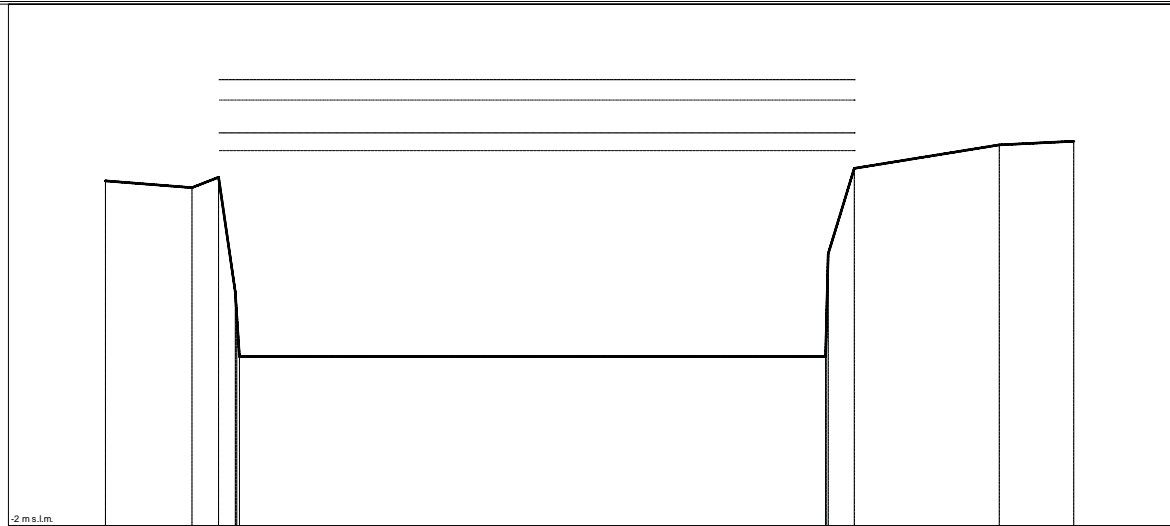

Punti	1	2	3	4	7	10	11	12
Quote [m s.l.m.]	0.64	0.59	0.67	-0.21	-0.70	0.74	0.92	0.95
Distanze progressive [m]	1.9	4.6	5.4	5.9	24.0	24.9	29.3	31.6
Distanze parziali [m]		2.7	0.8		18.0	0.8	4.4	2.3

Sezione

 Livelli idrometrici
 Q=11.40mc/s H=0.87m s.l.m.

 Q=12.87mc/s H=1.01m s.l.m.

 Q=17.94mc/s H=1.27m s.l.m.

 Q=23.35mc/s H=1.42m s.l.m.

BRc001
 Sezione n. BRc001

Scala distanze 1:160
 Scala quote 1:40

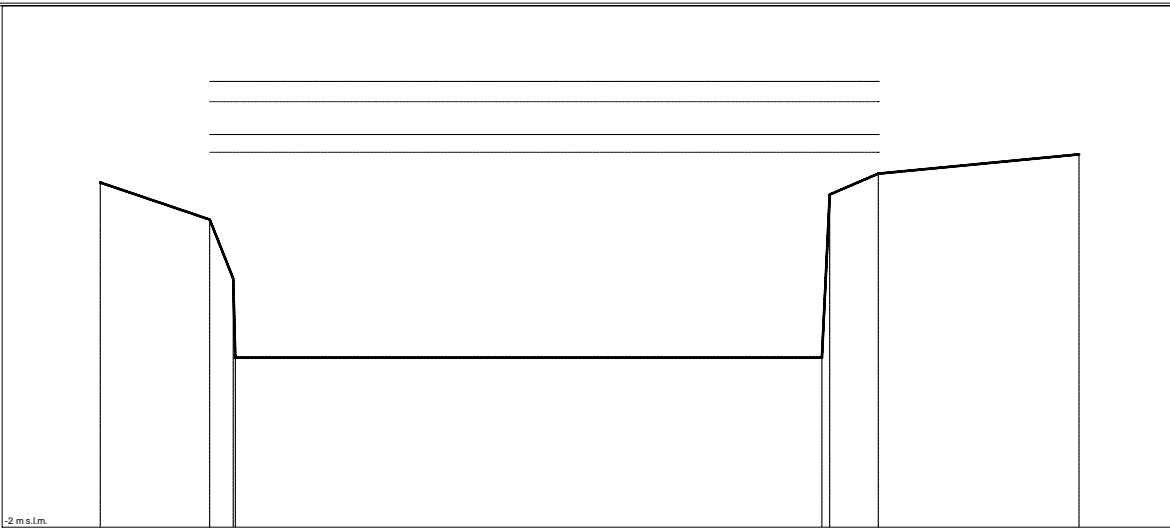

Punti	1	2	3	5	7	8
Quote [m s.l.m.]	0.65	0.36	-0.09	-0.70	0.71	0.96
Distanze progressive [m]	1.9	5.3	6.0	24.1	25.8	32.0
Distanze parziali [m]		3.4	0.7	18.0	1.5	6.2

STATO ATTUALE

Sezioni fluviali fosso Brugiano – BR_d_P

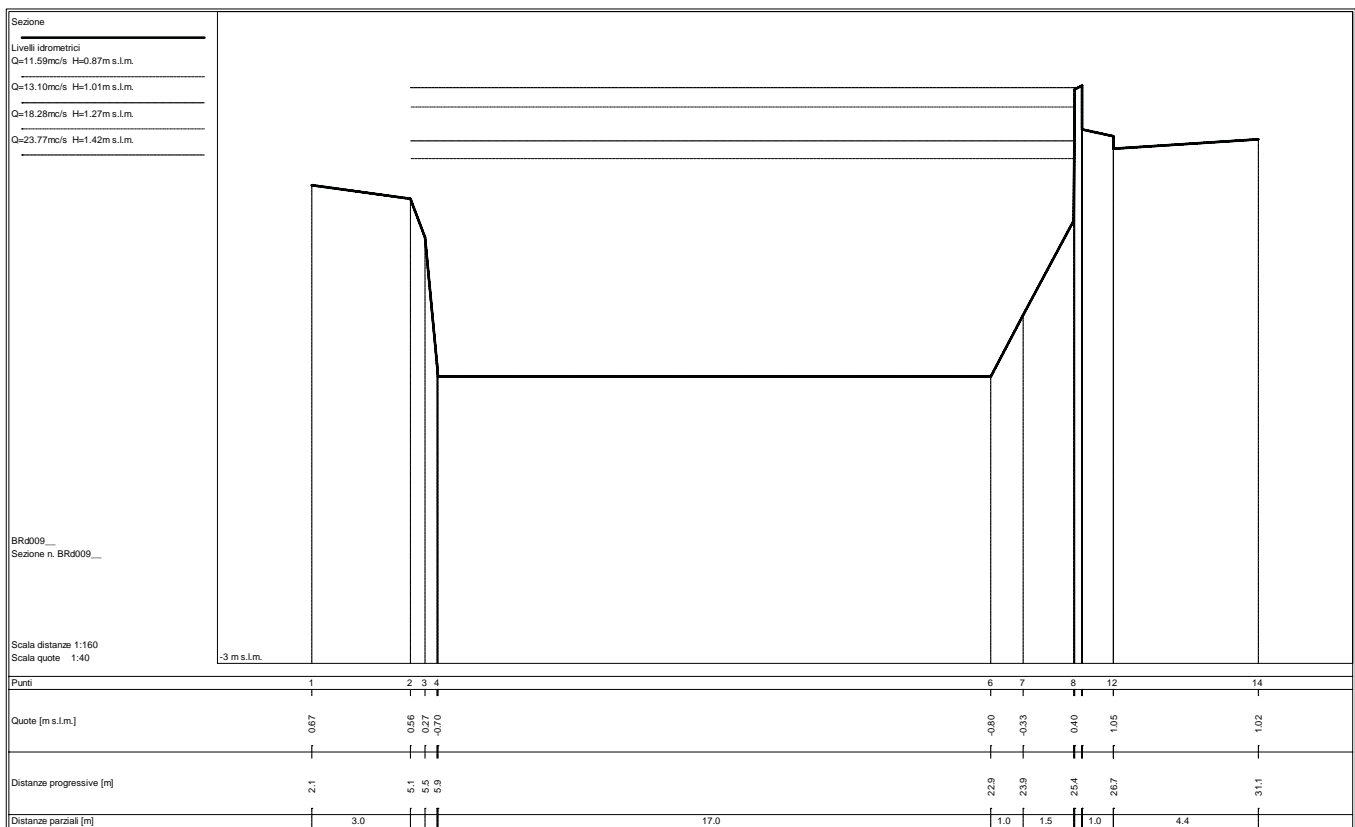
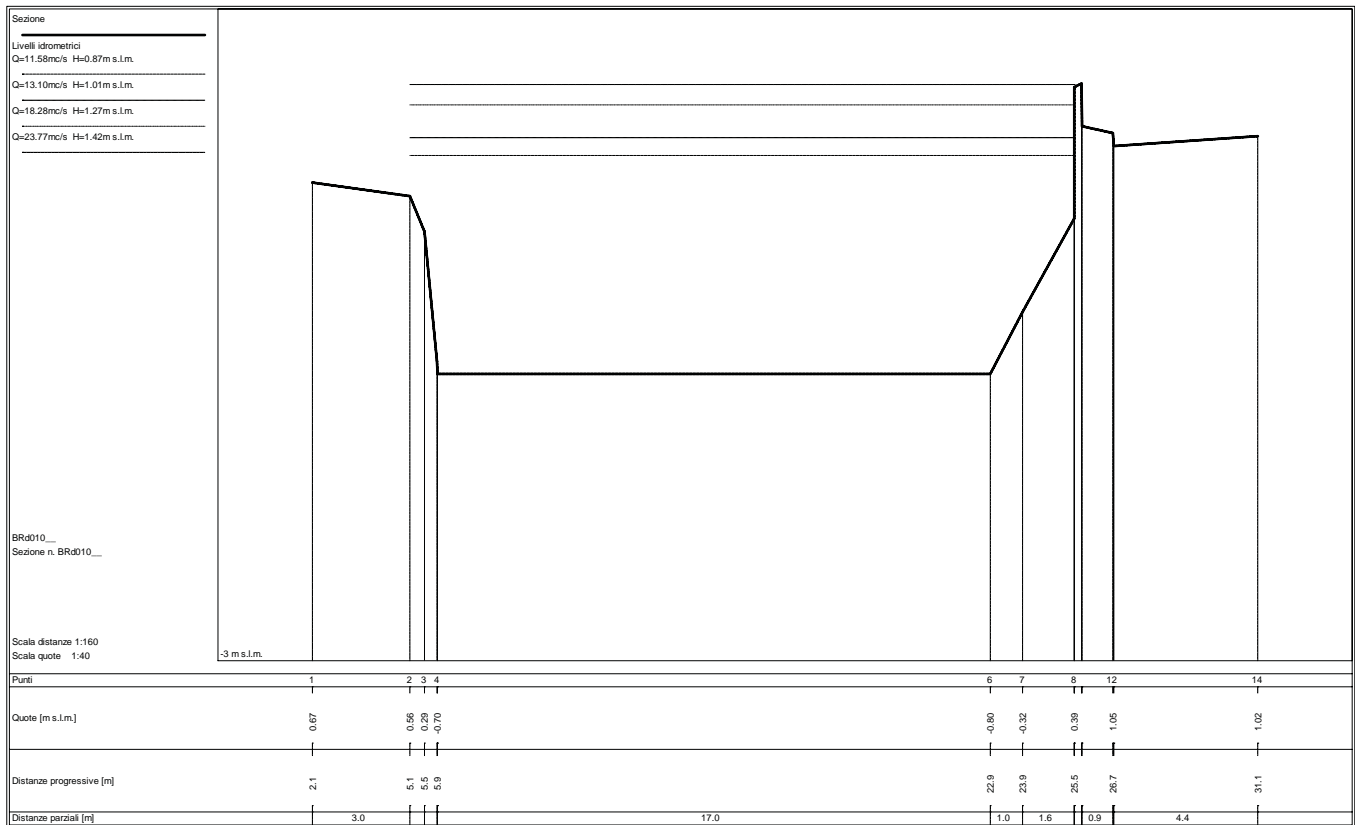

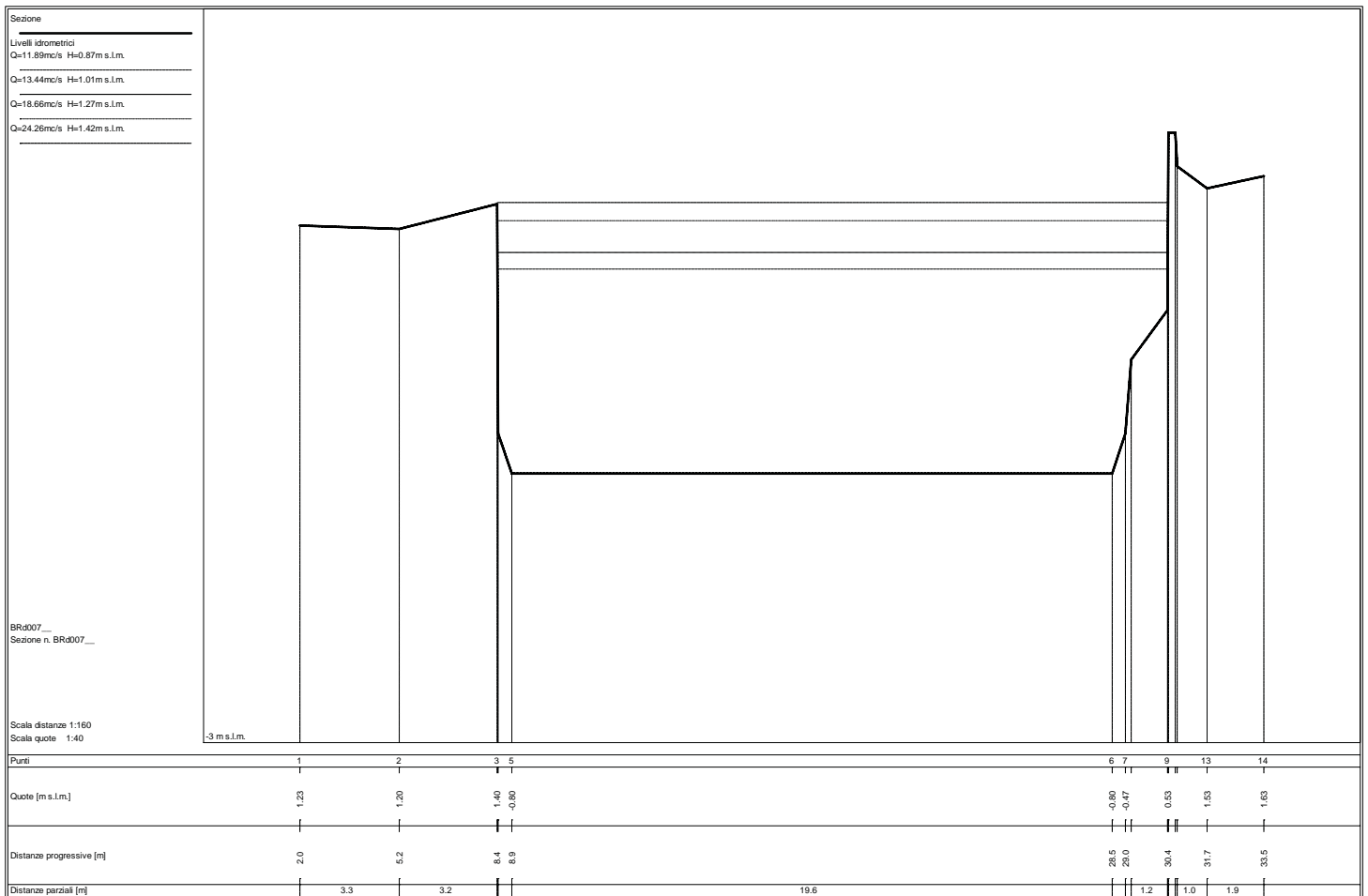
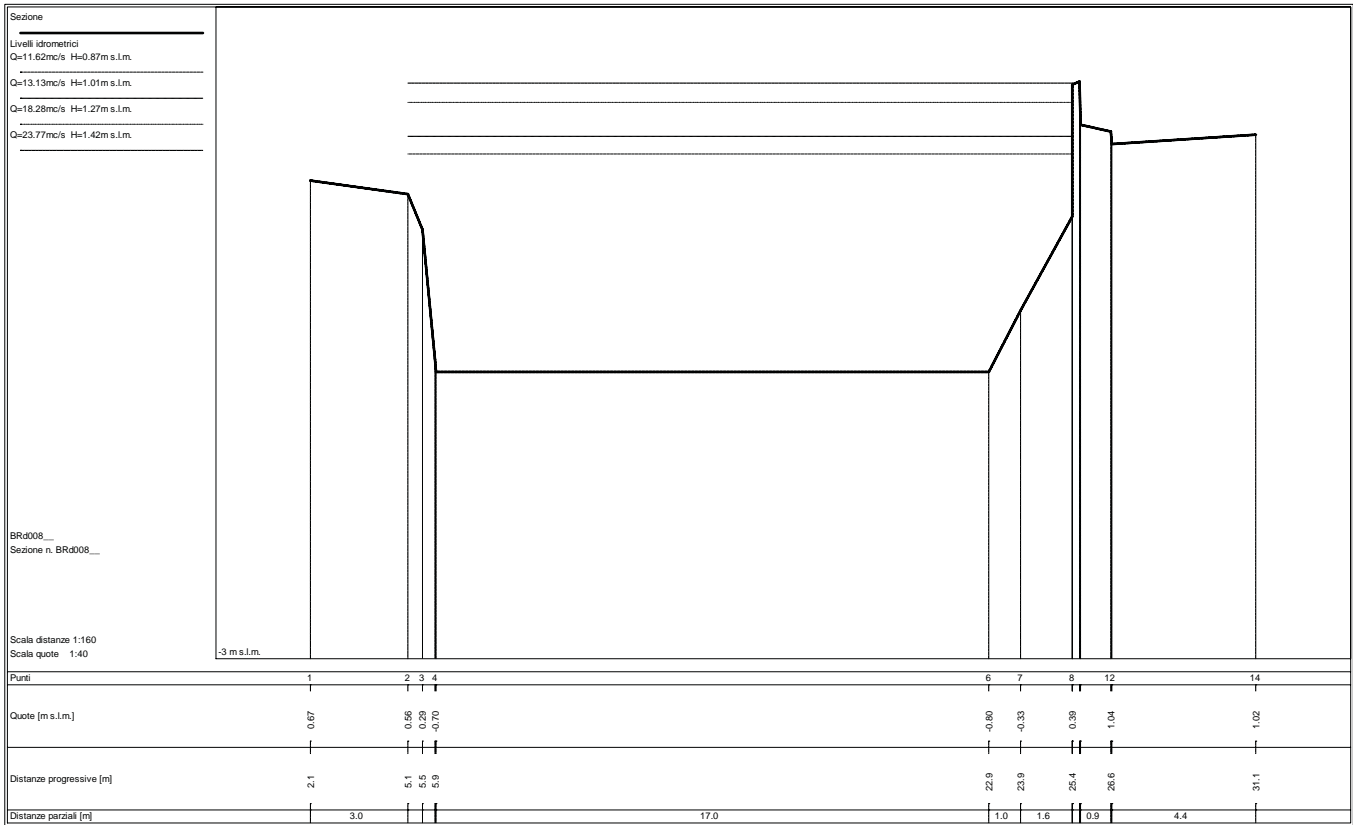

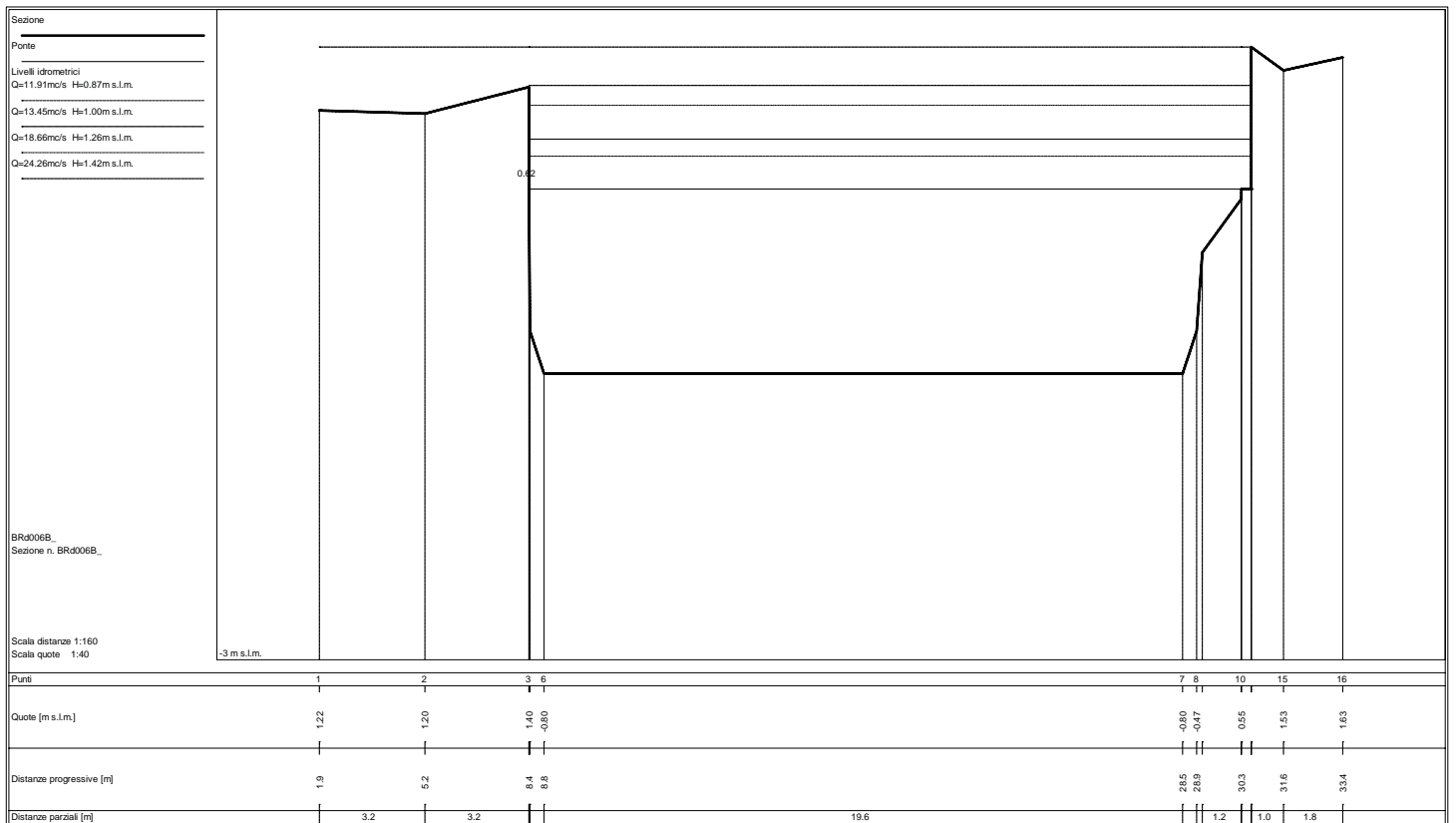
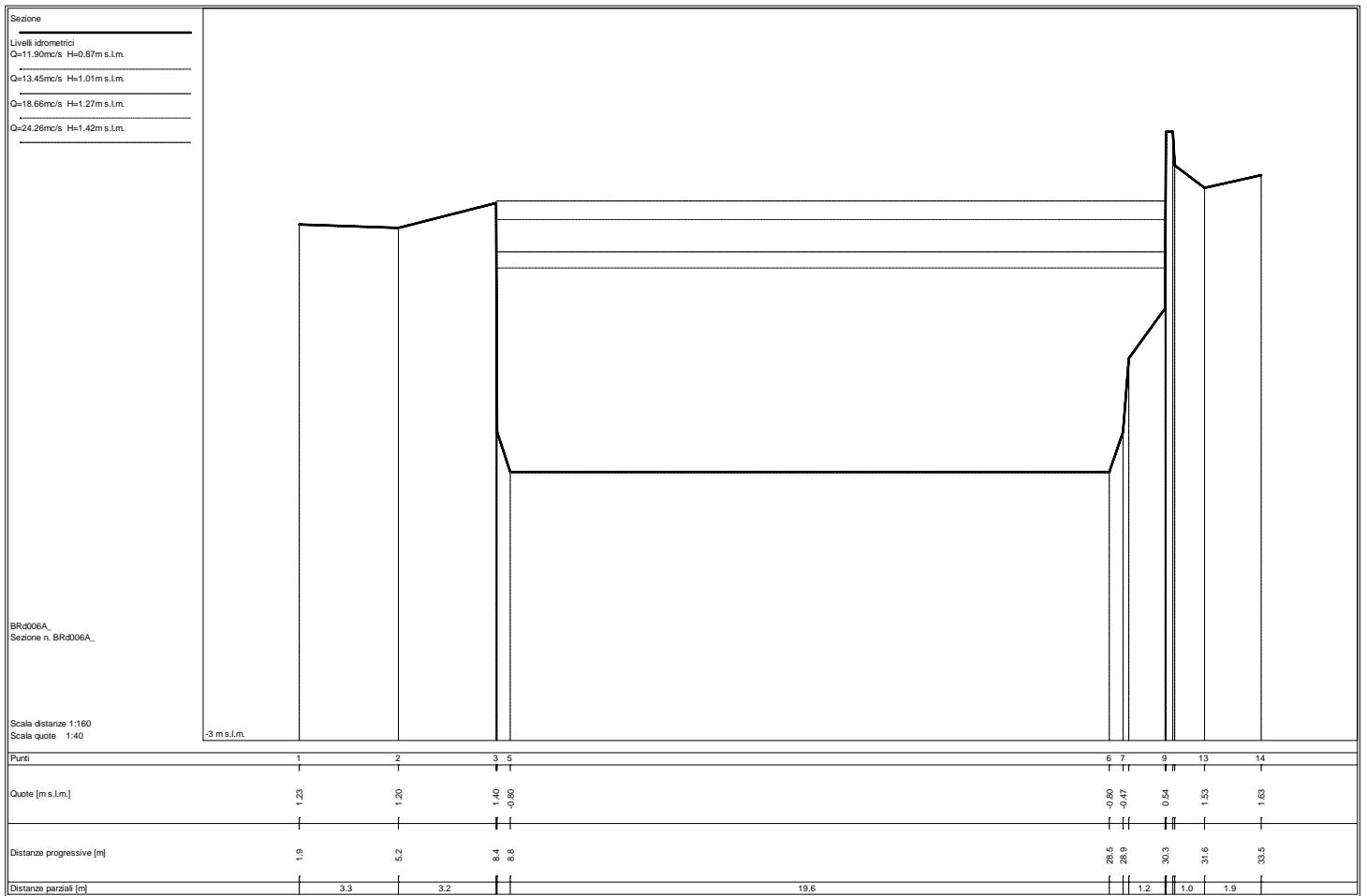

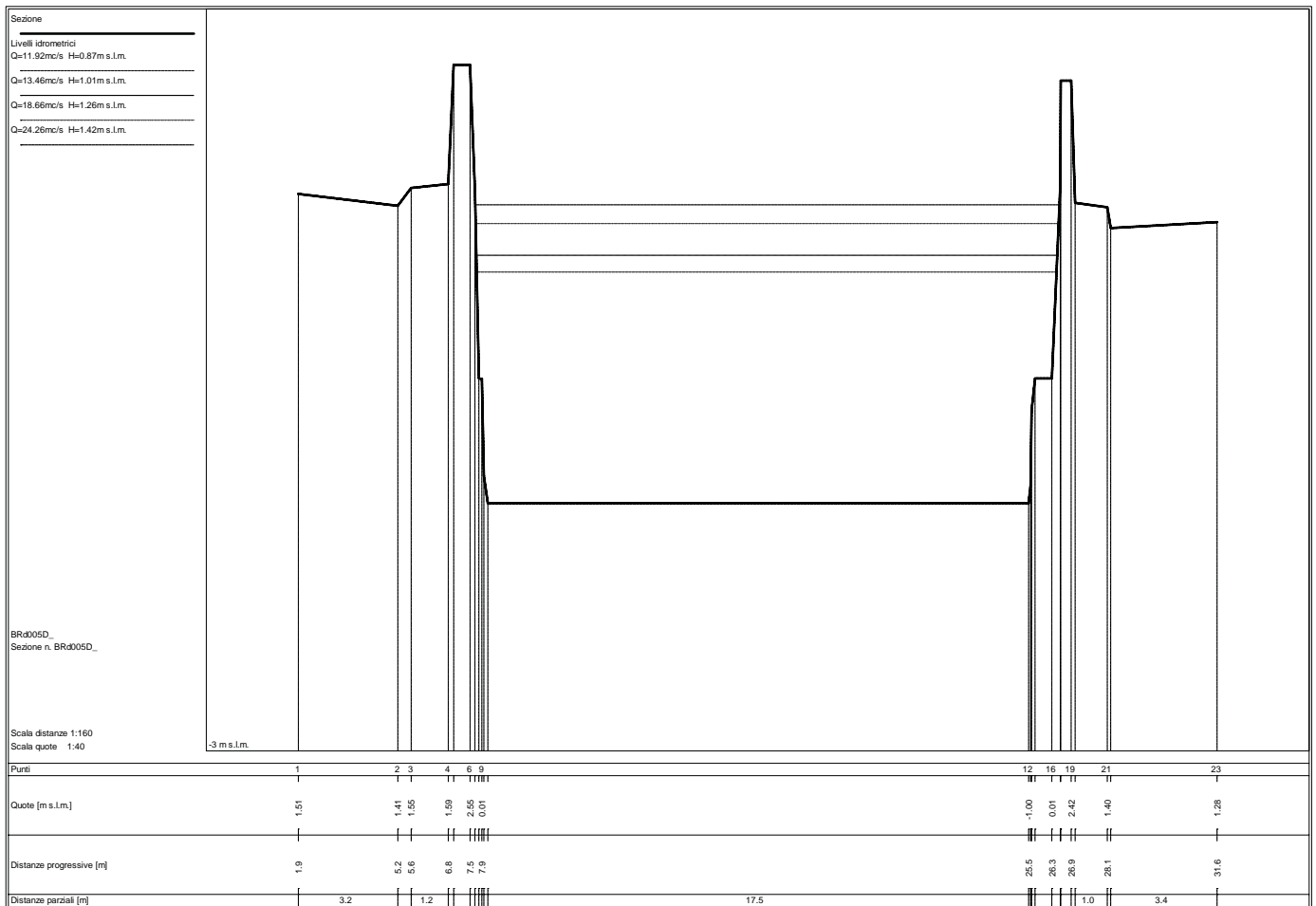
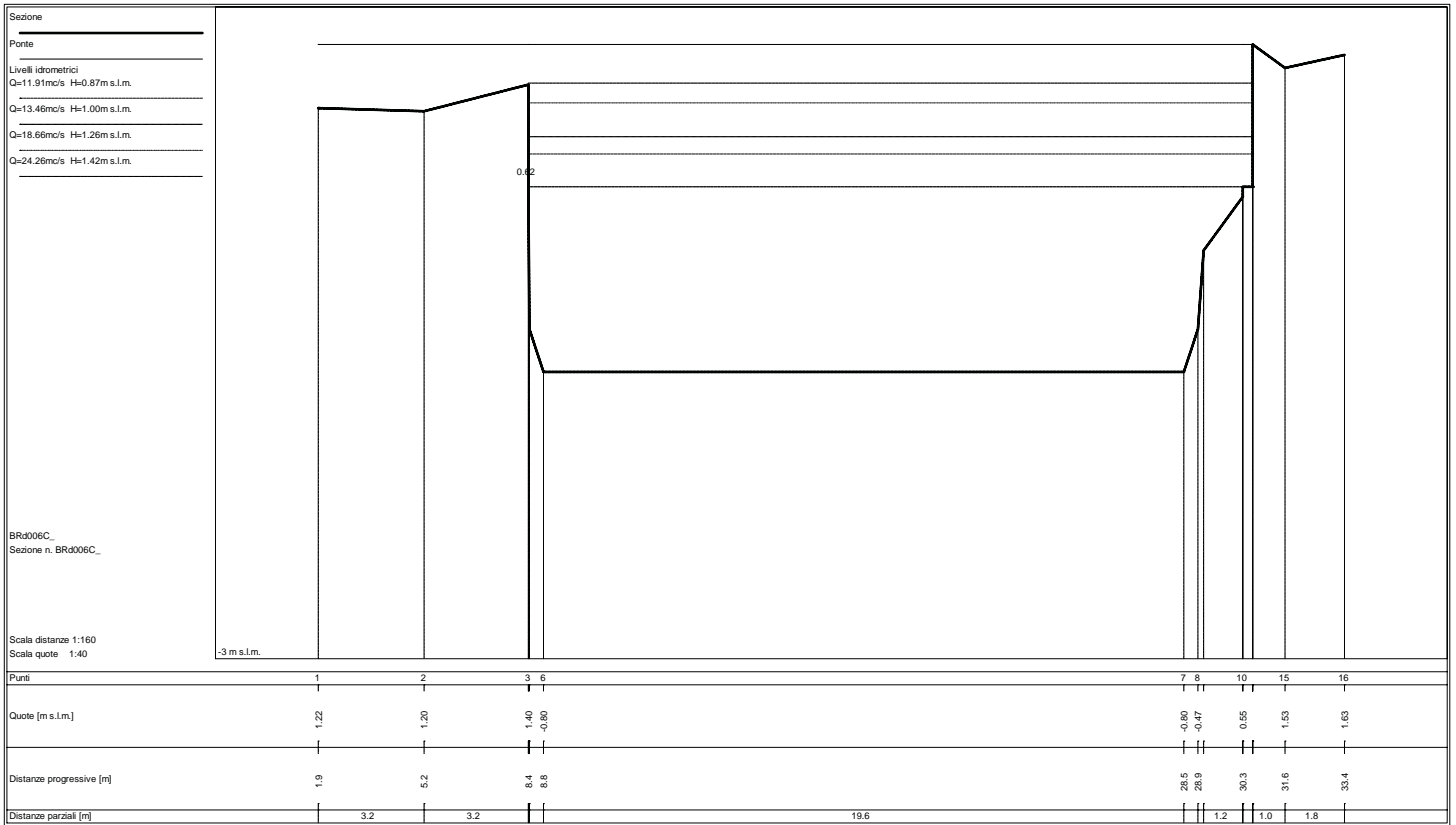

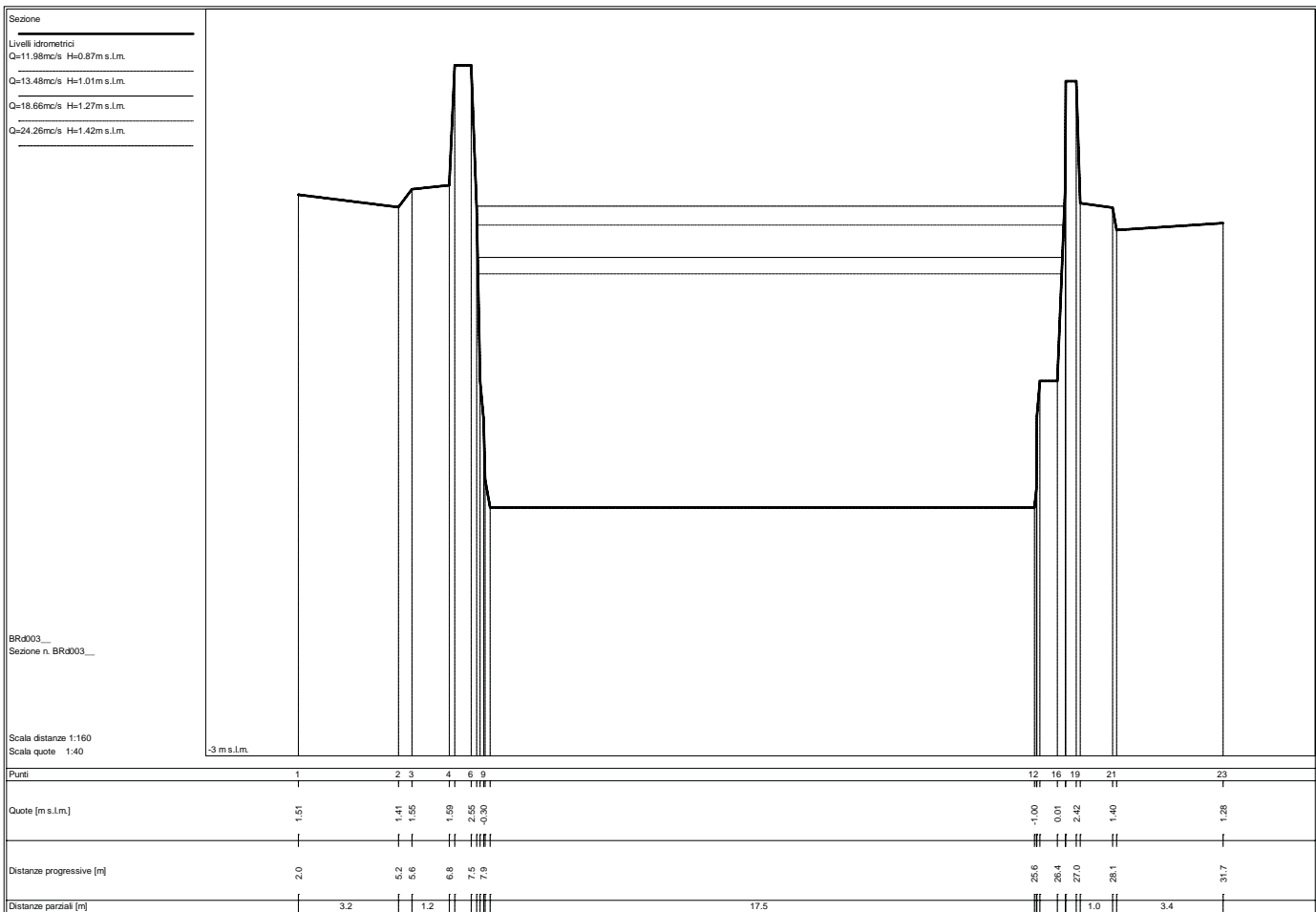
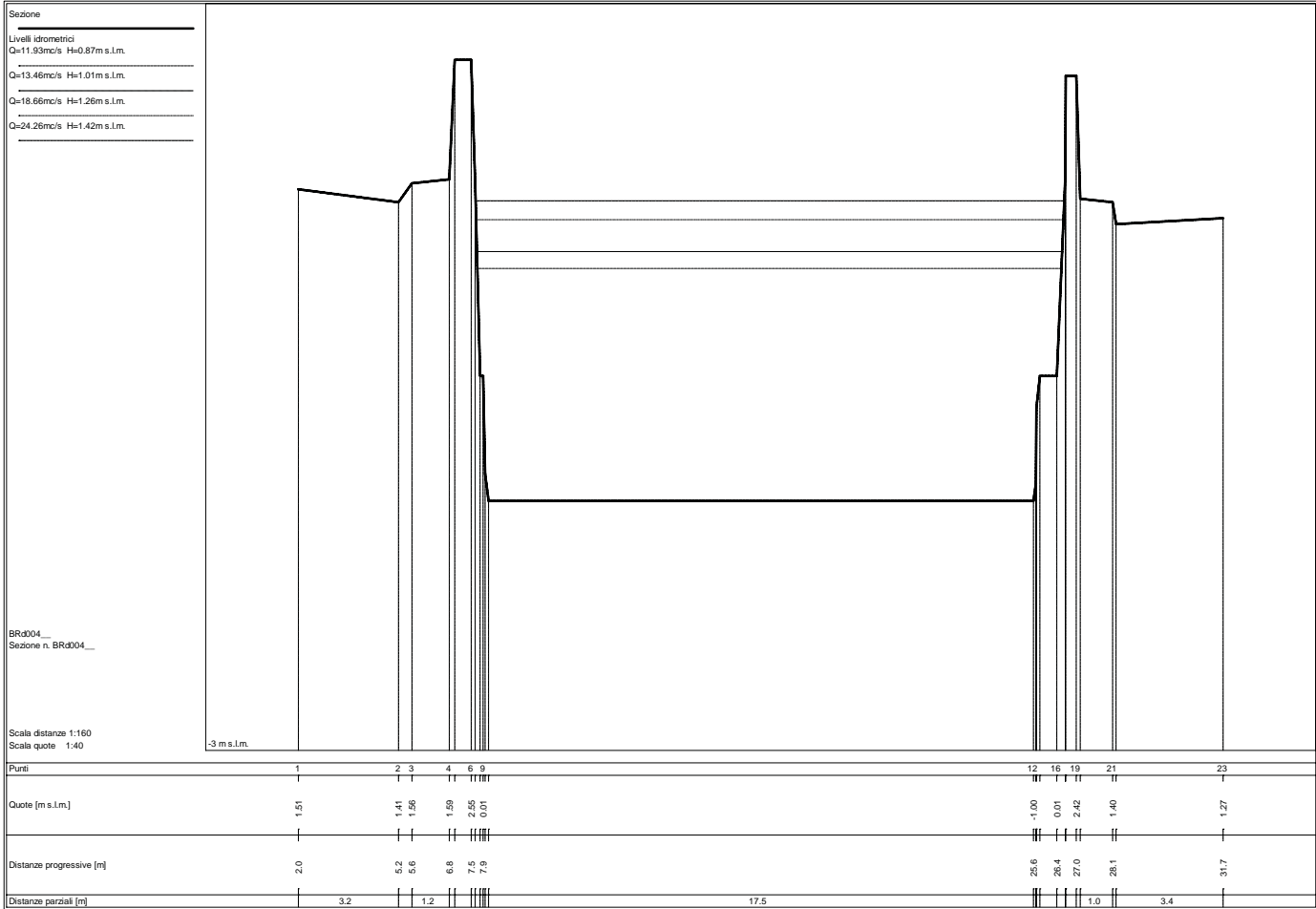

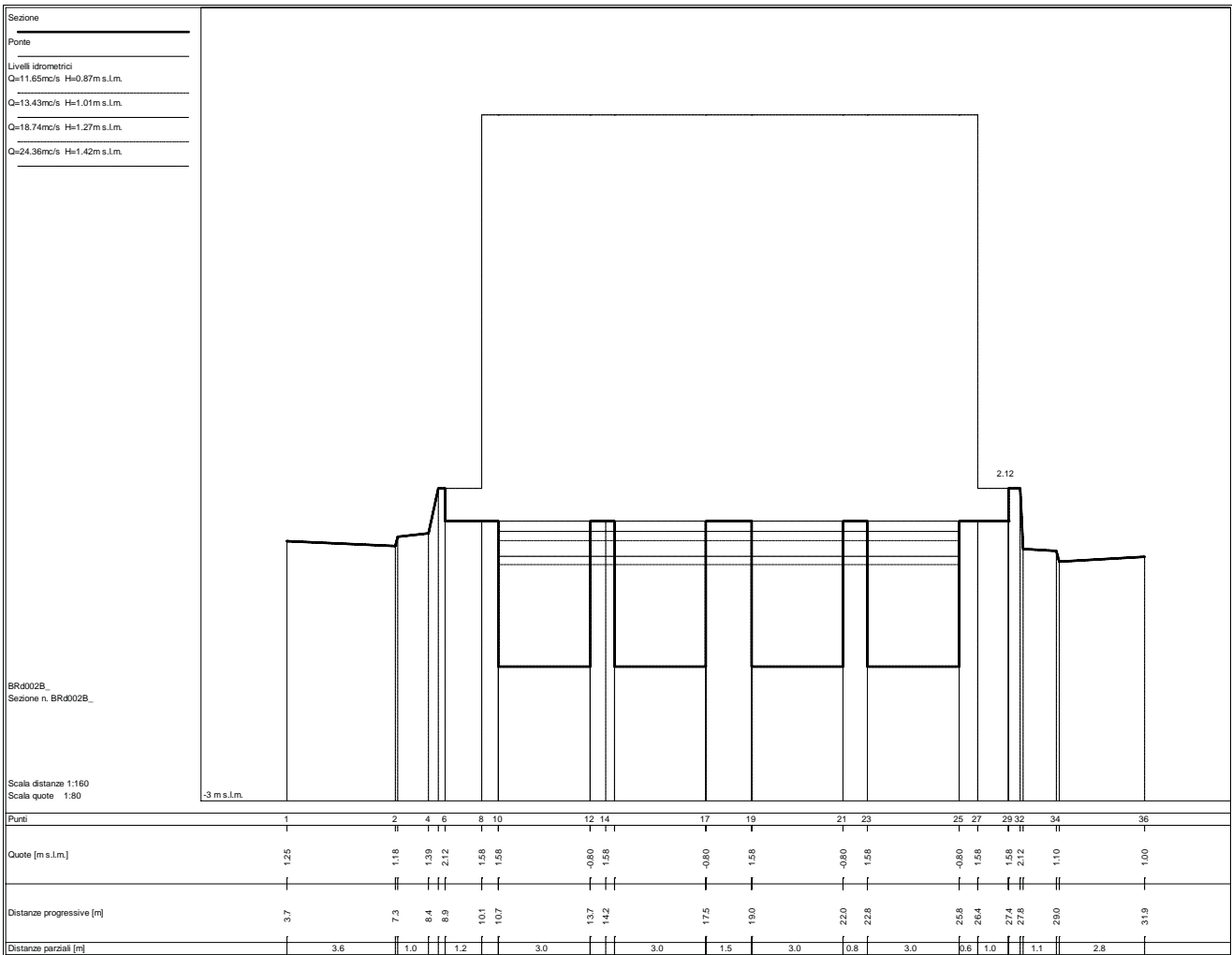
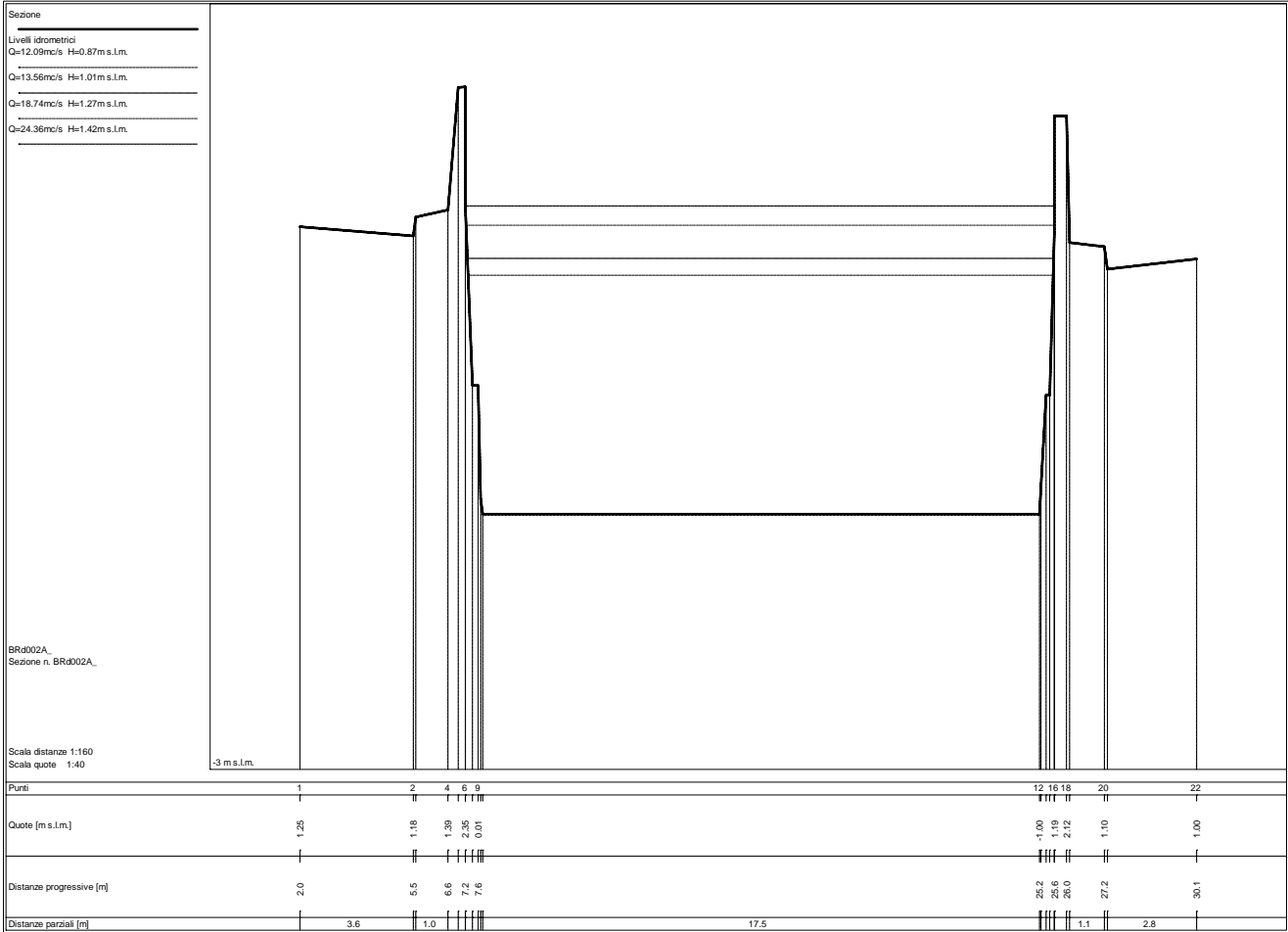

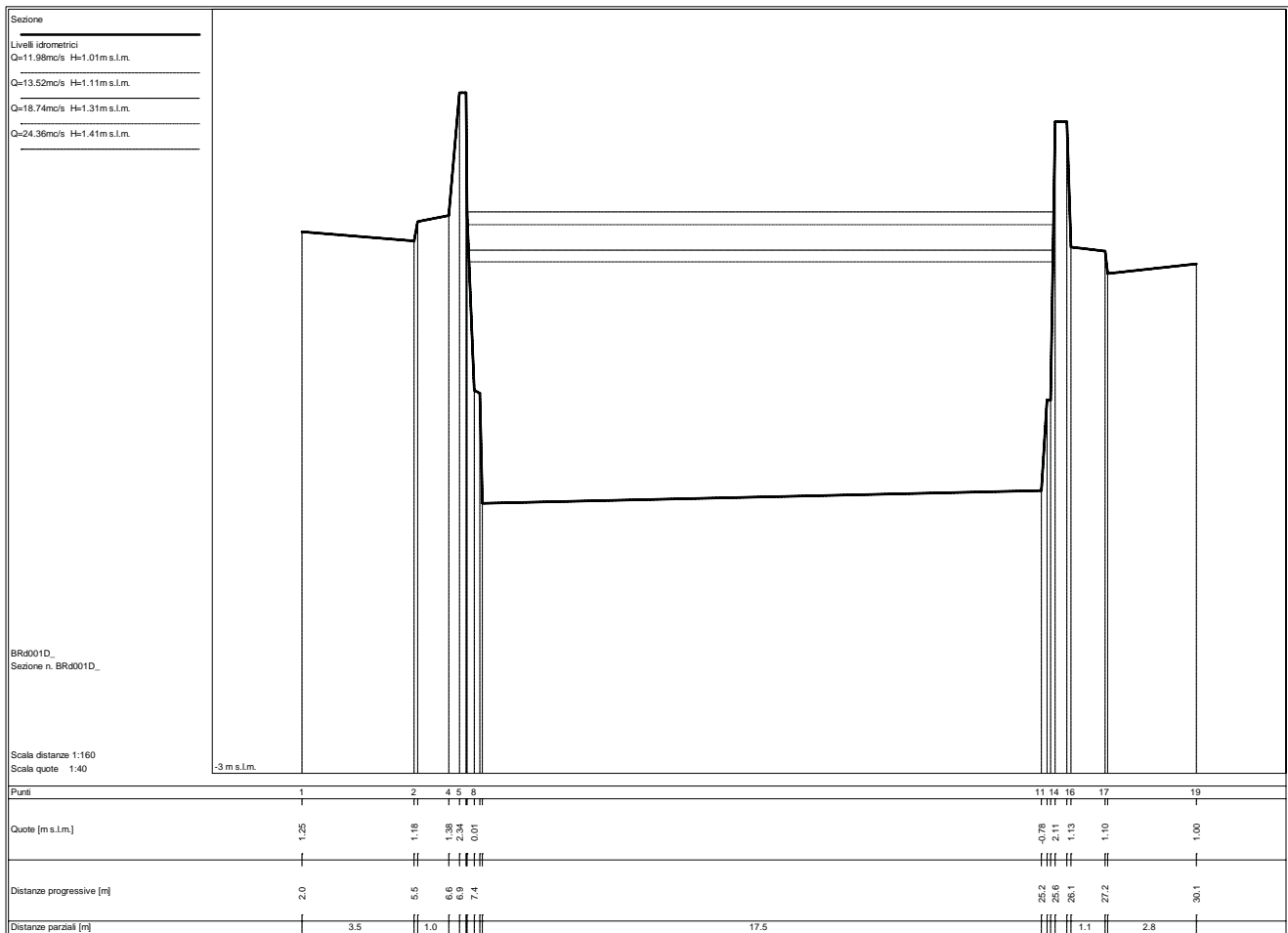
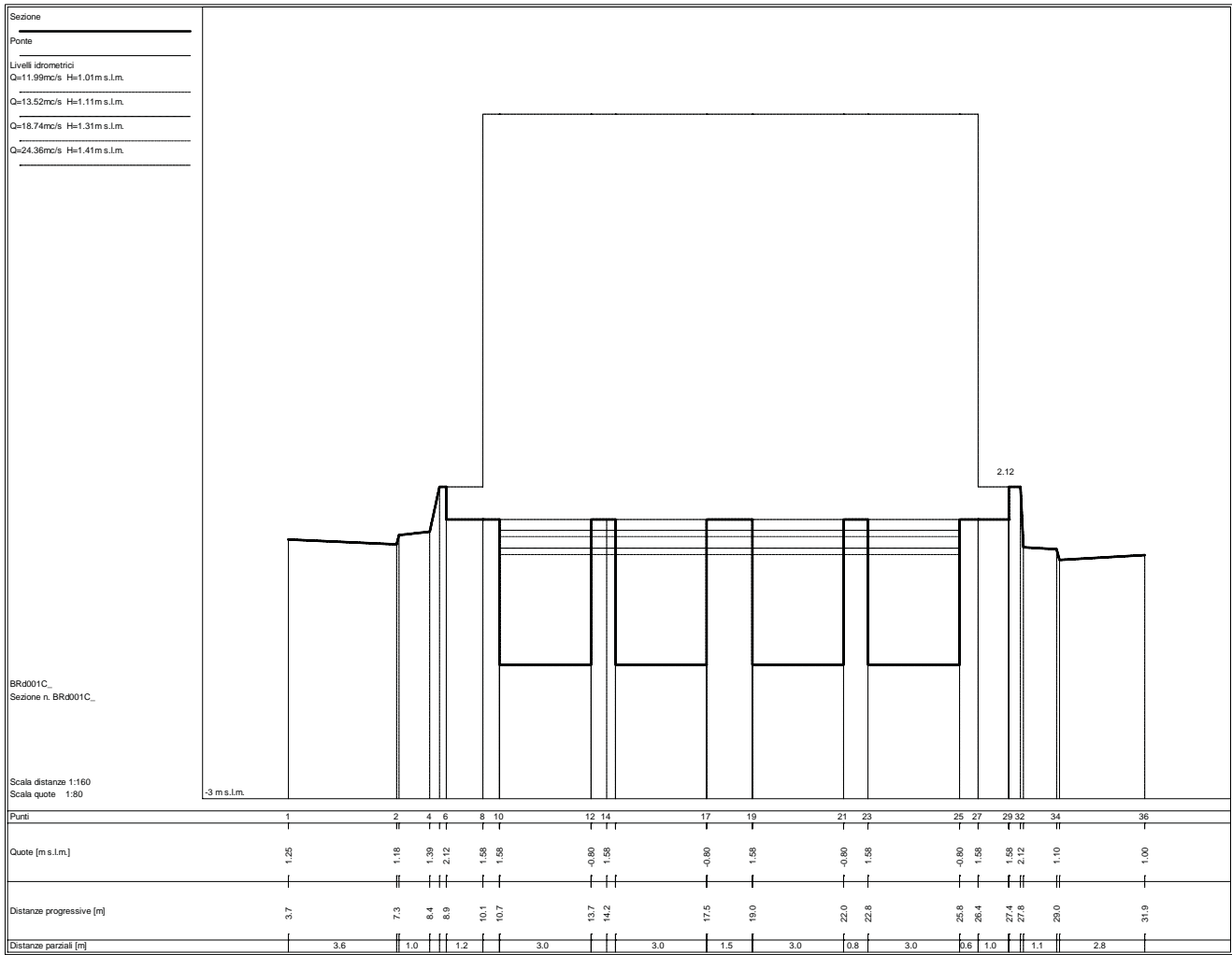

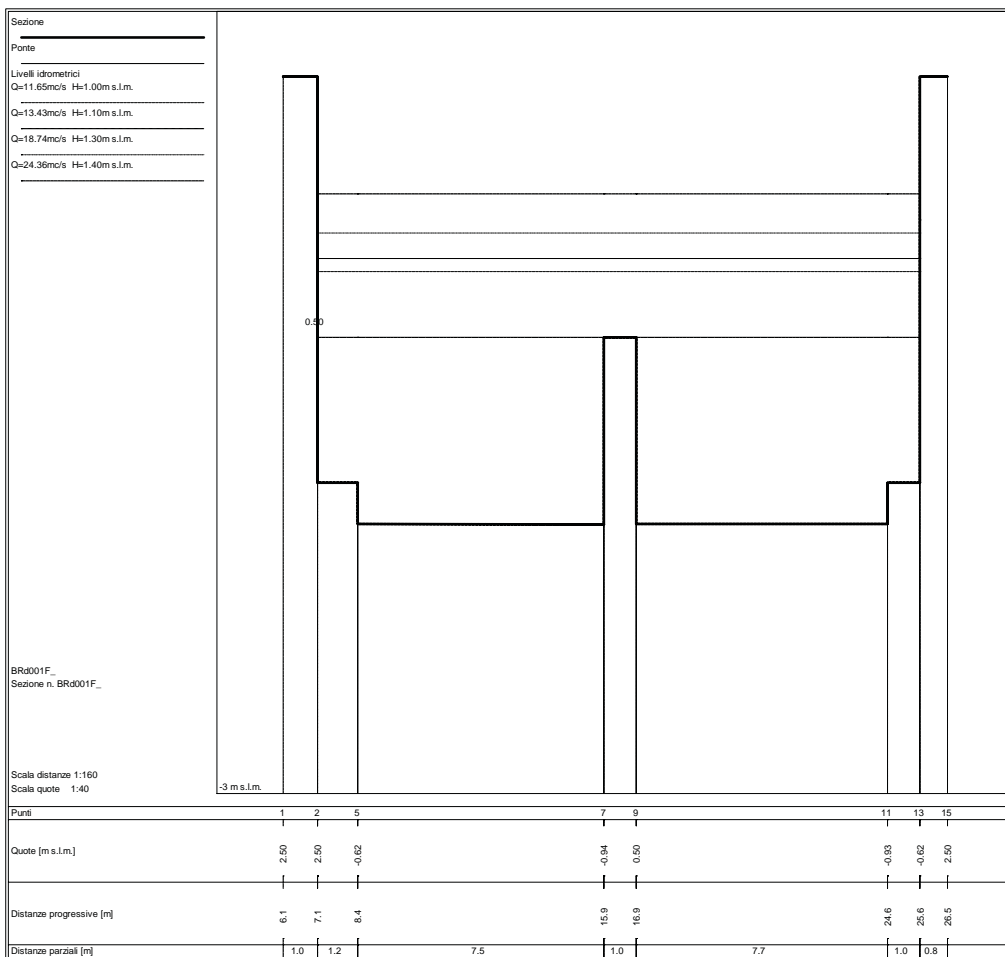
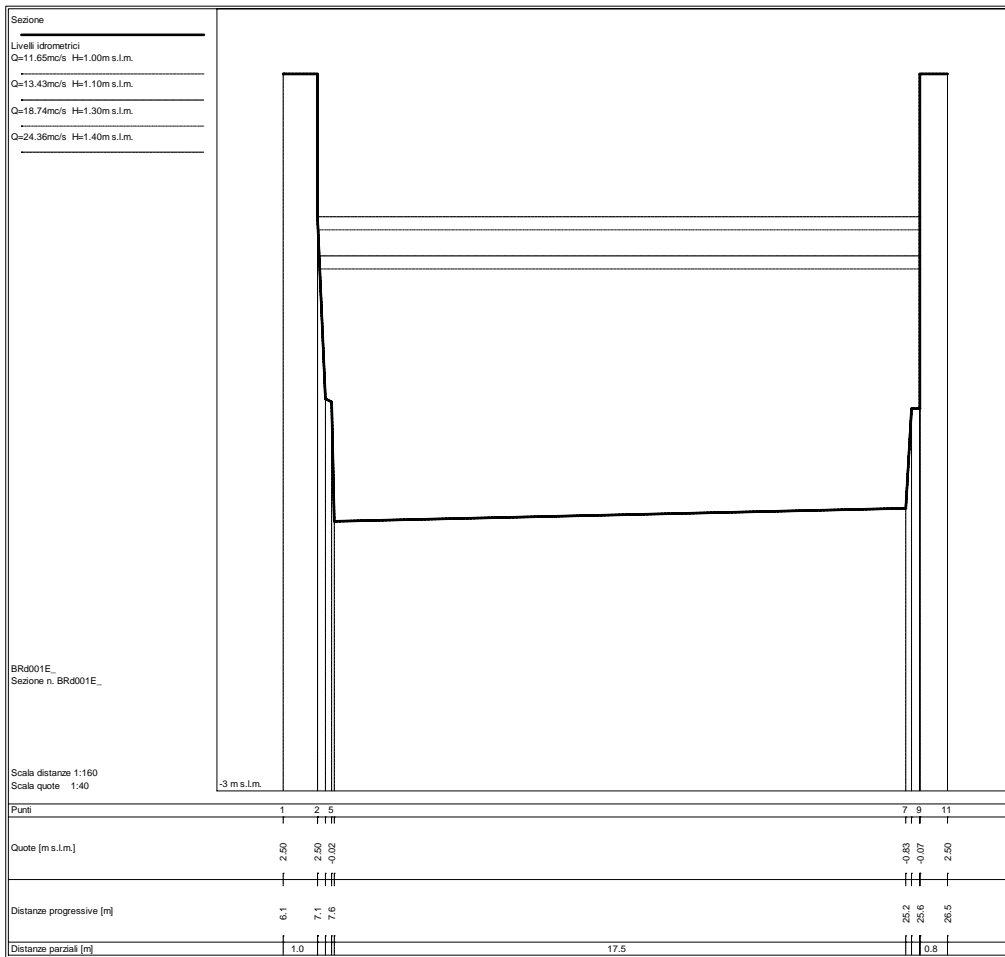

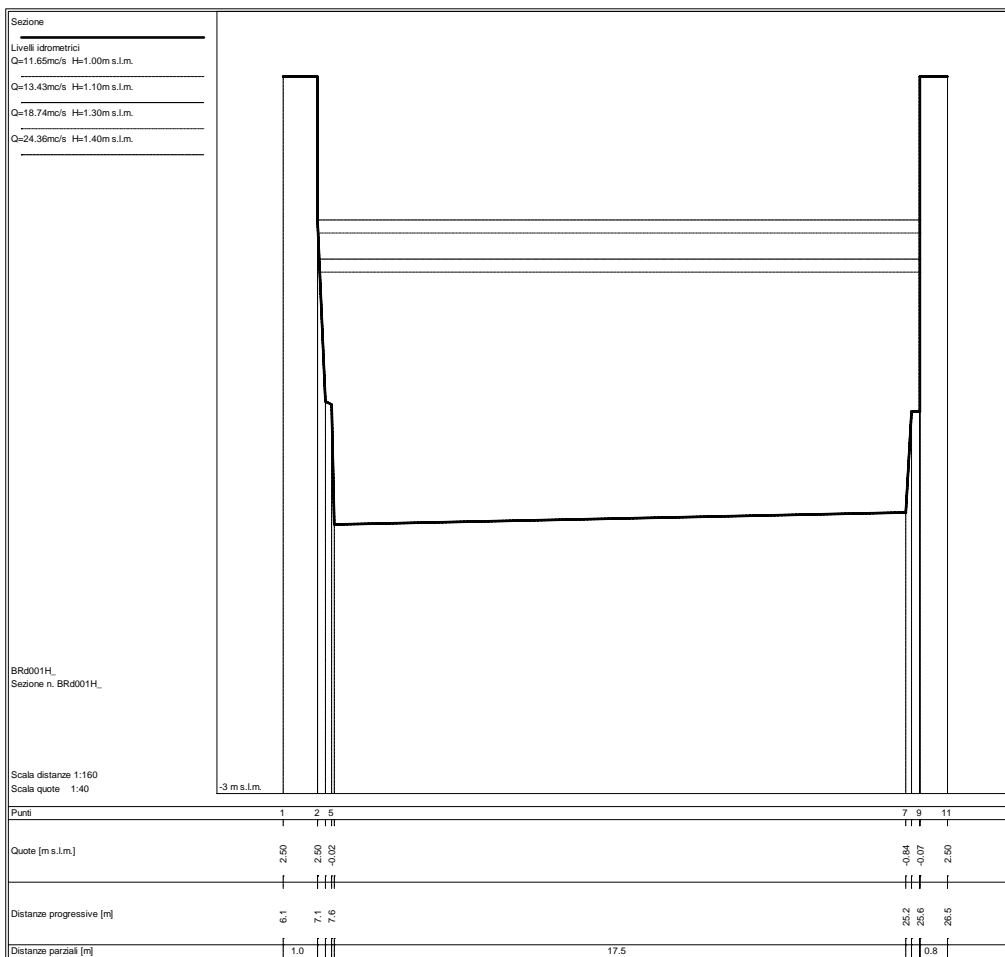
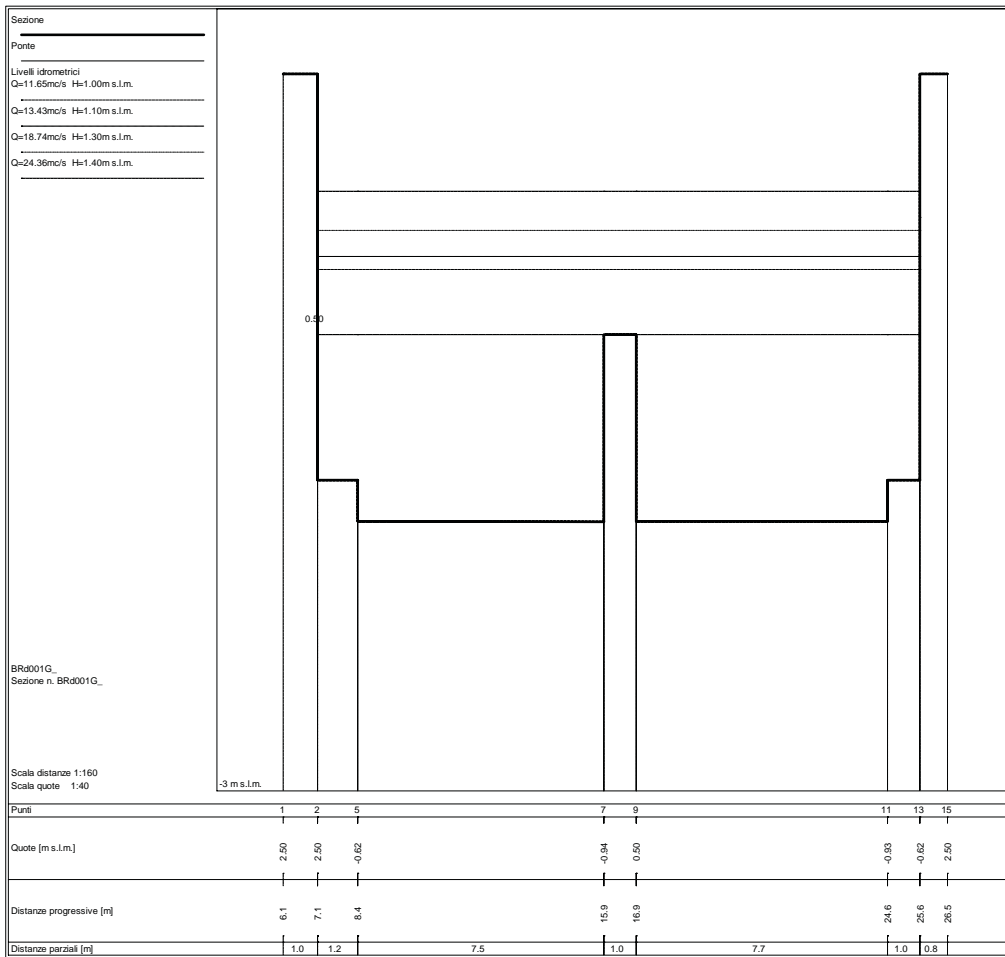

STATO ATTUALE
Sezioni fluviali fosso Becaro

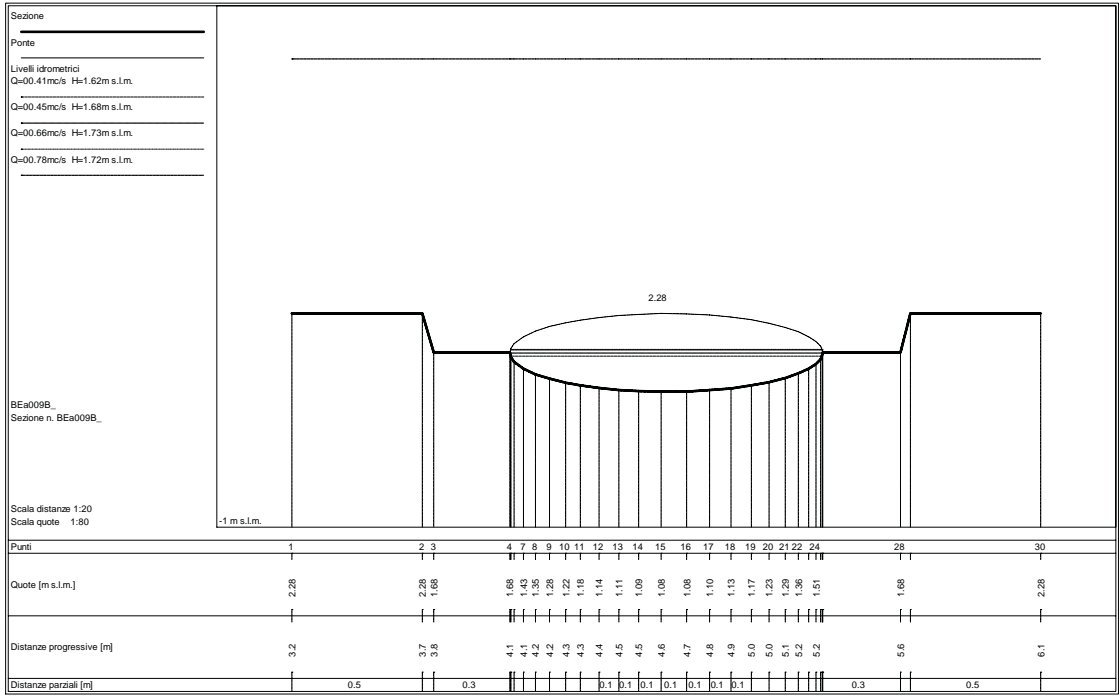
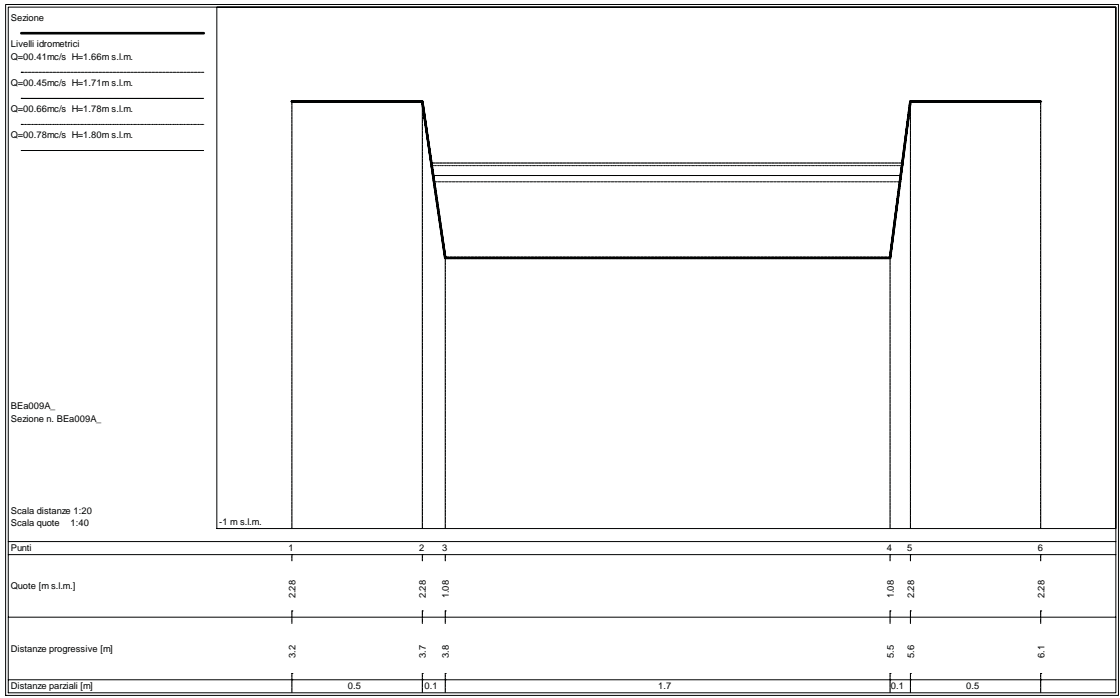

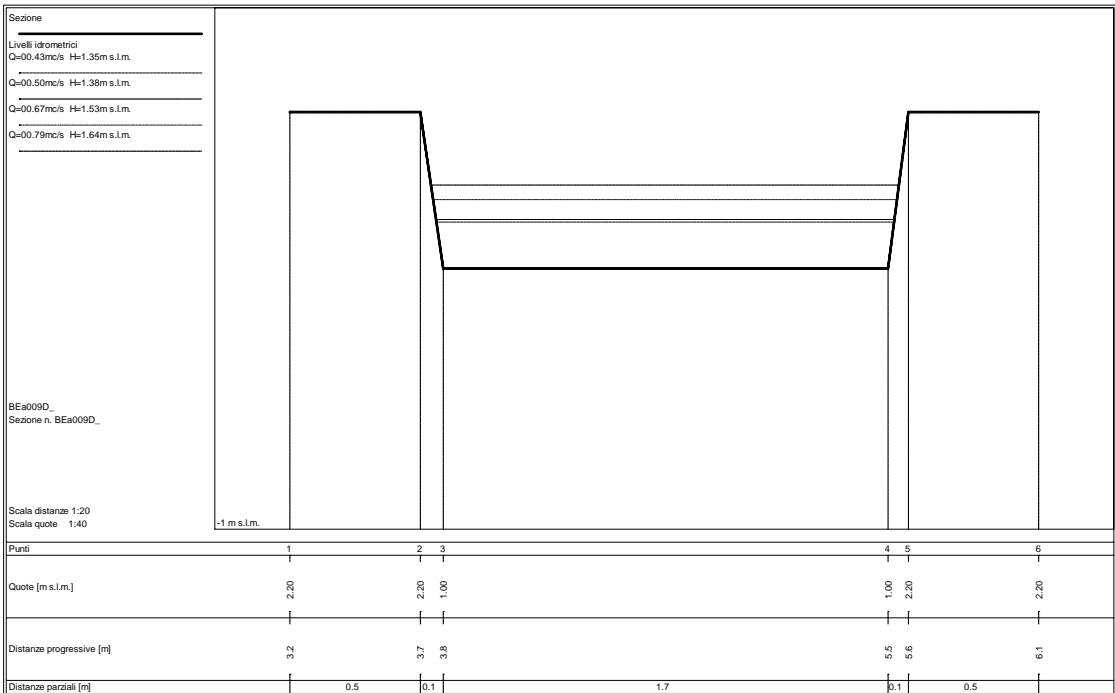
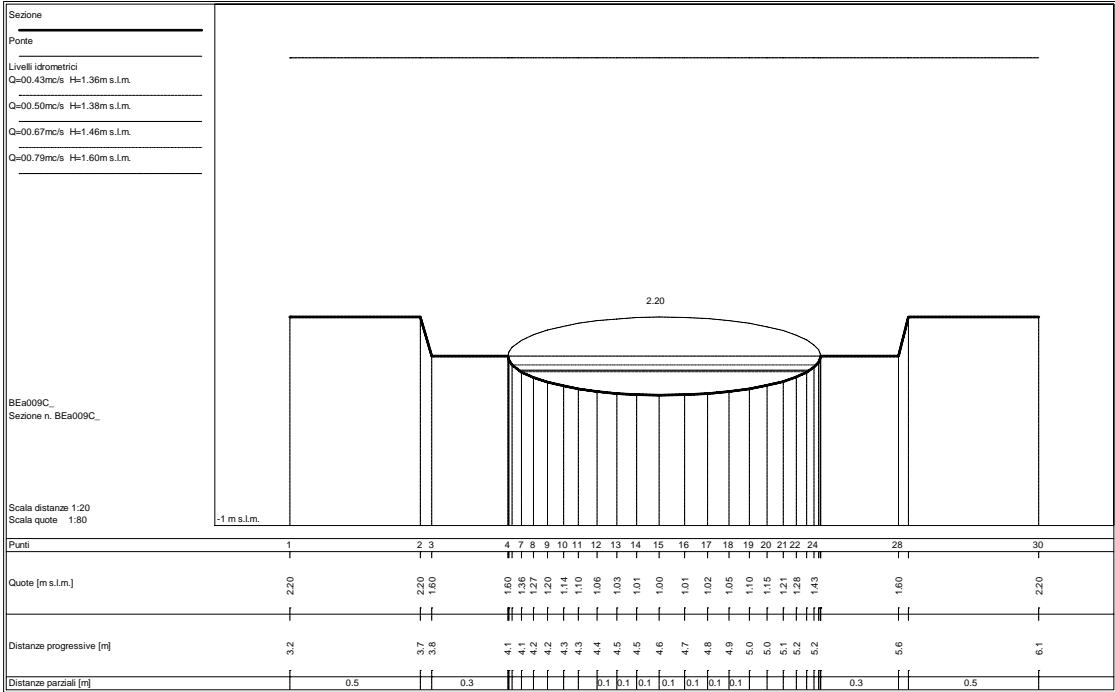

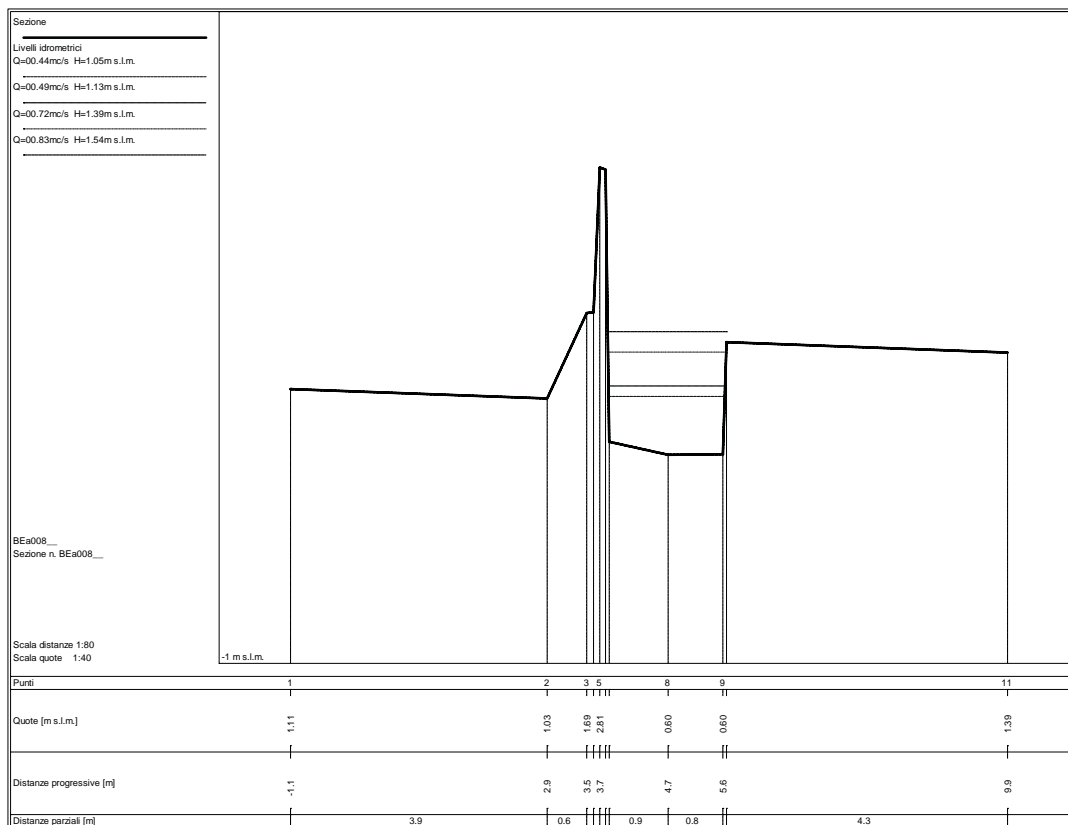
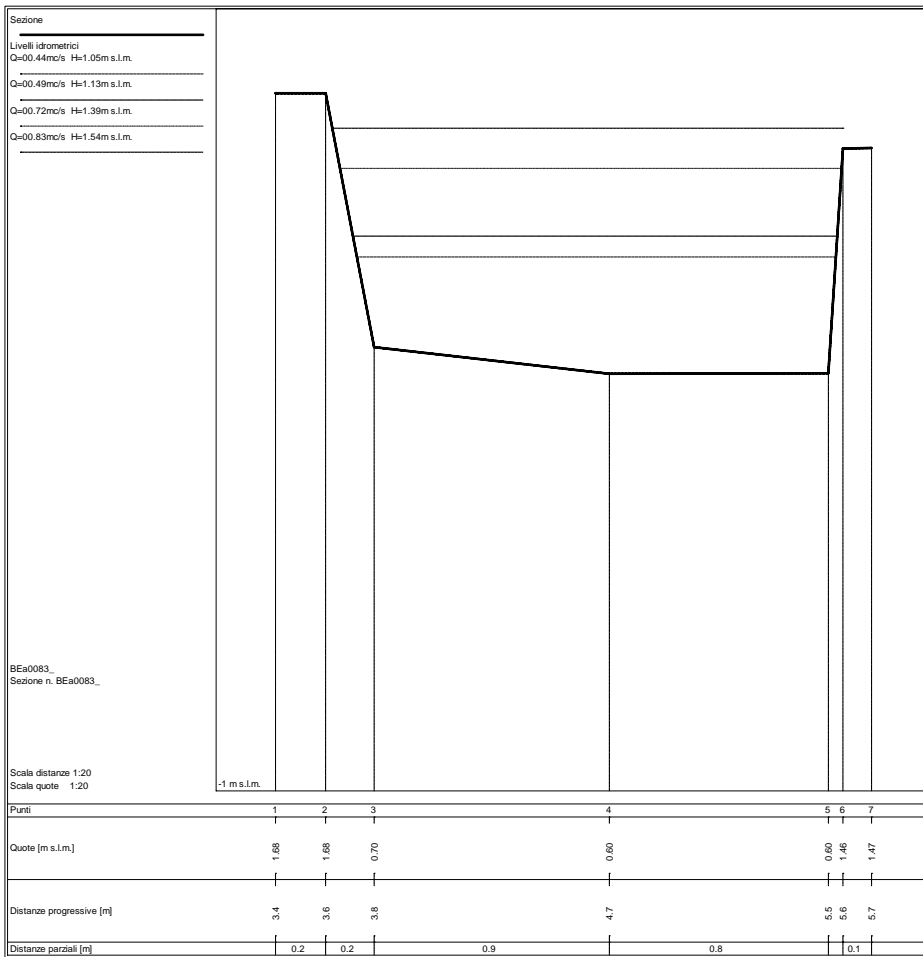

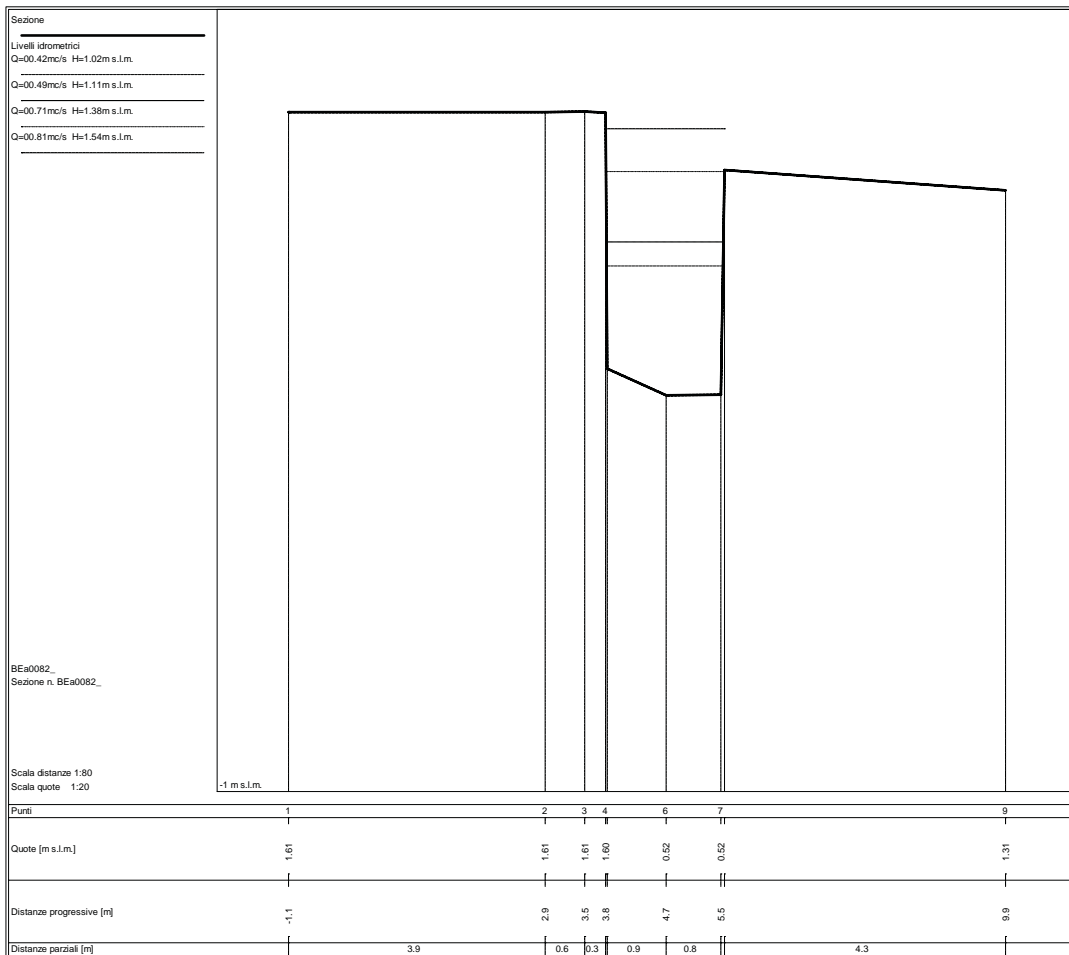
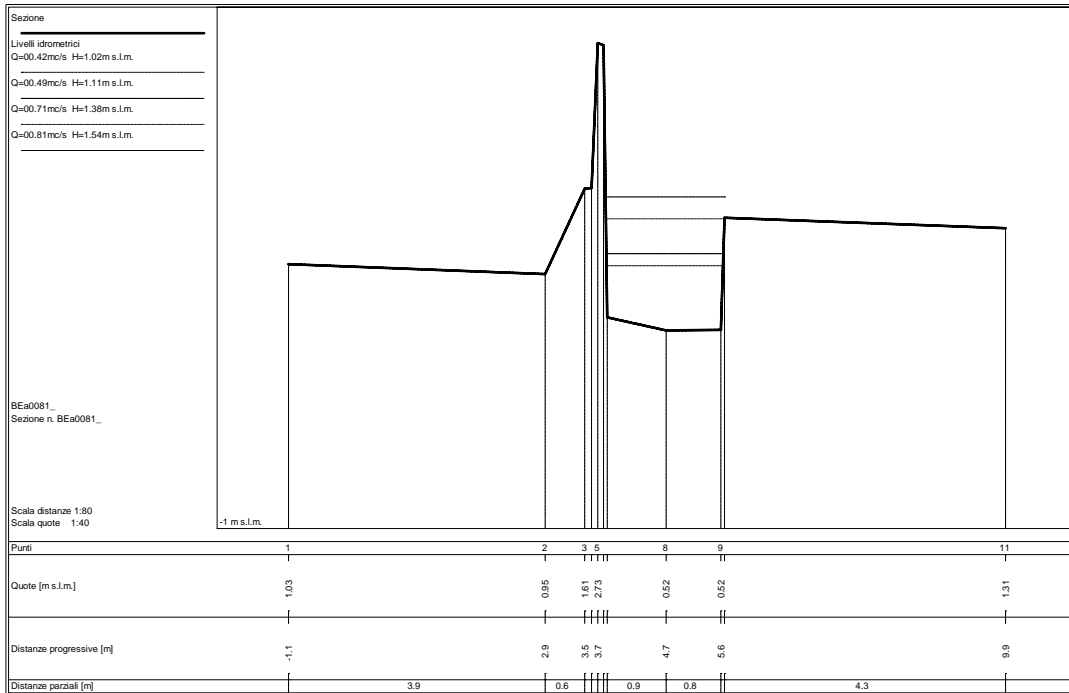

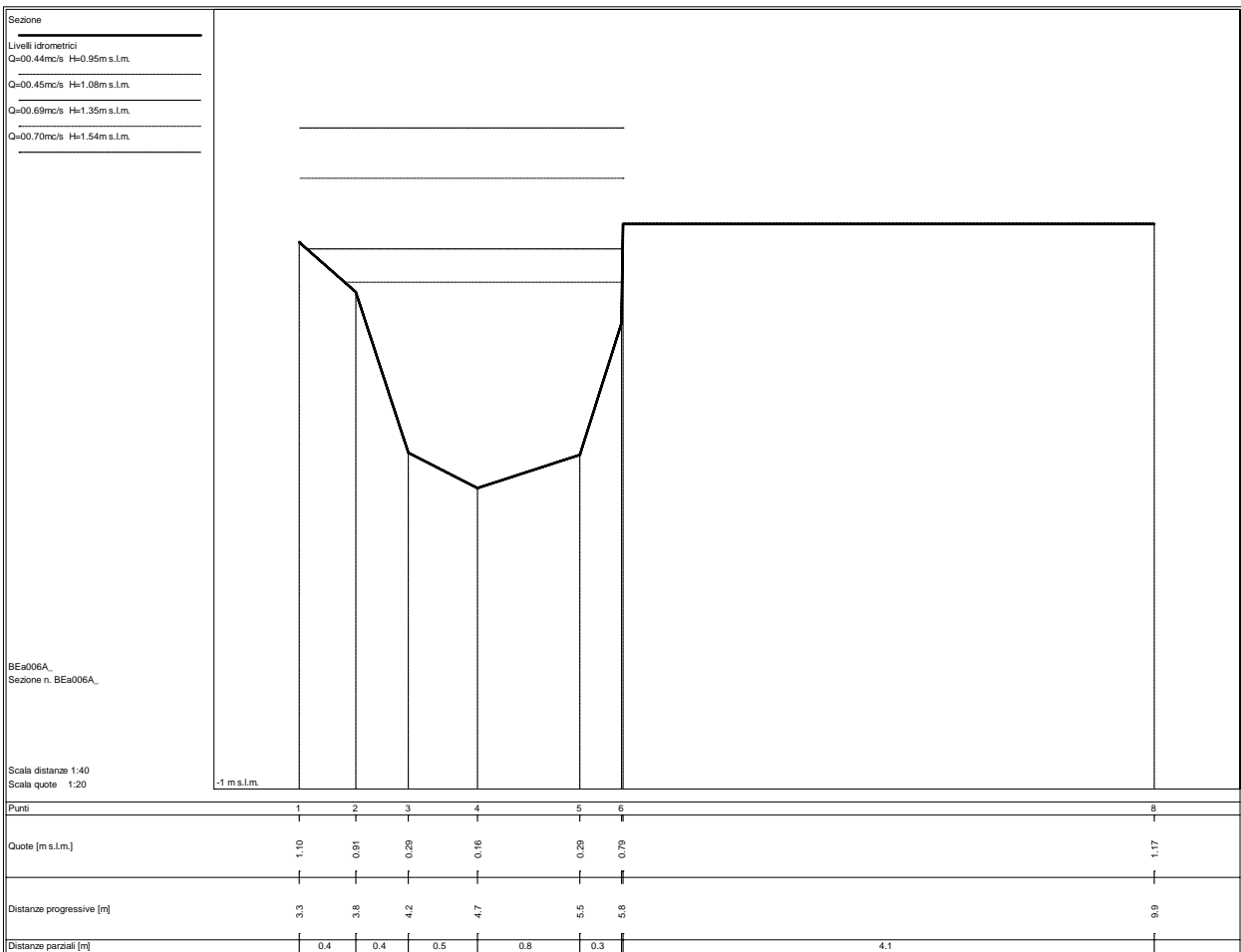
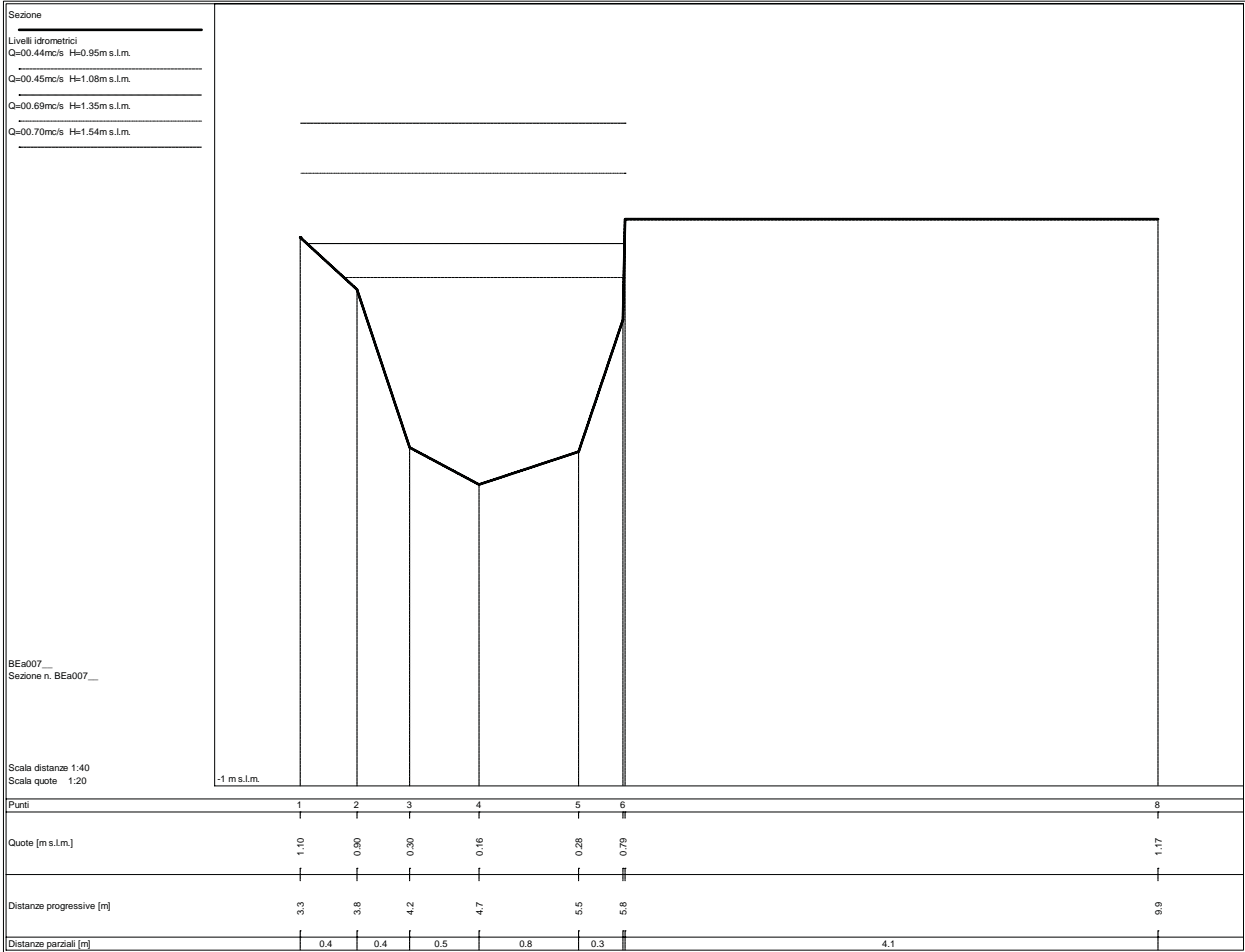

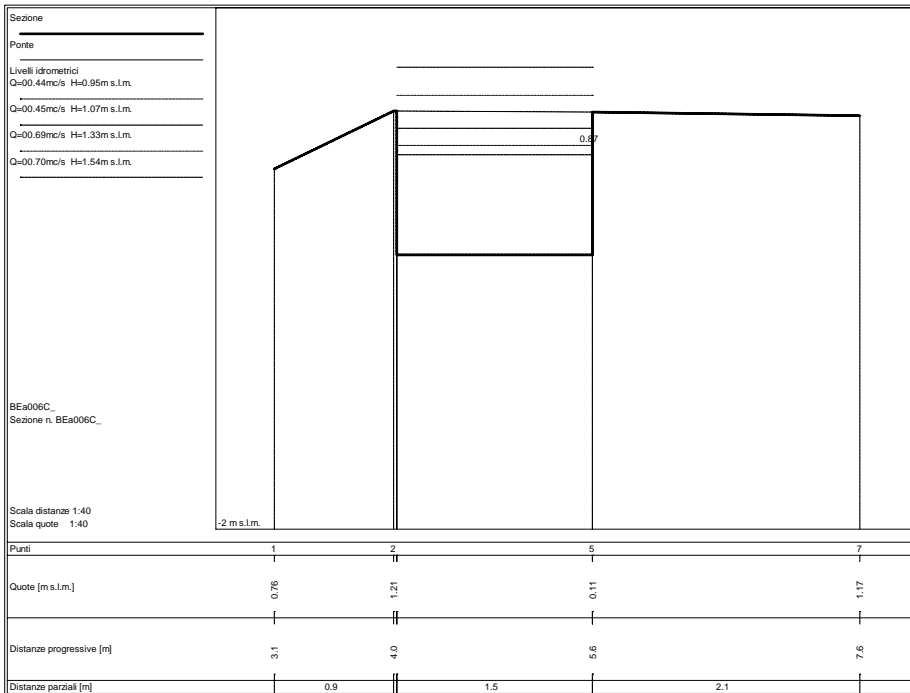
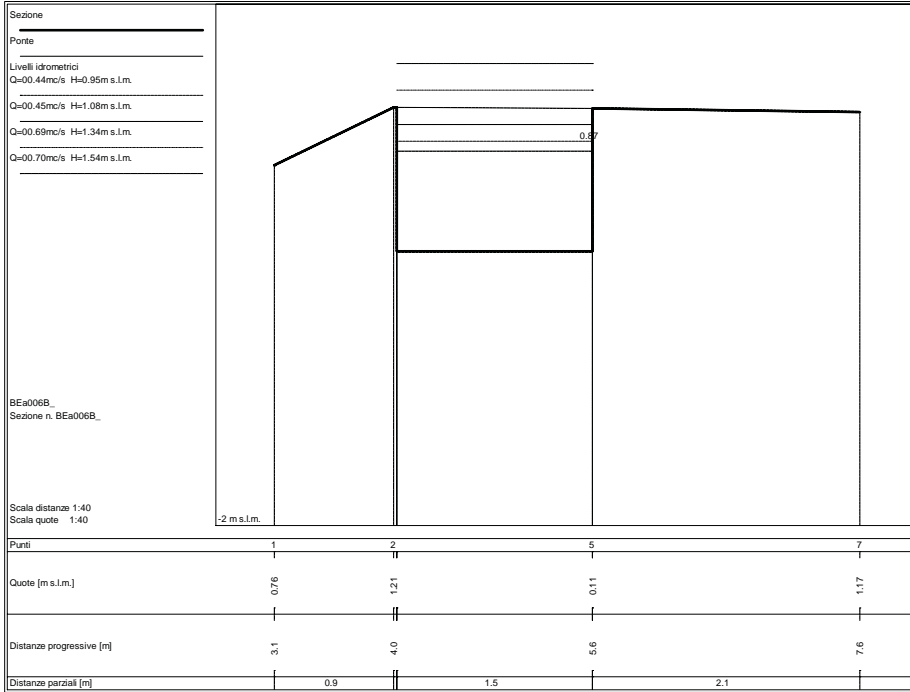

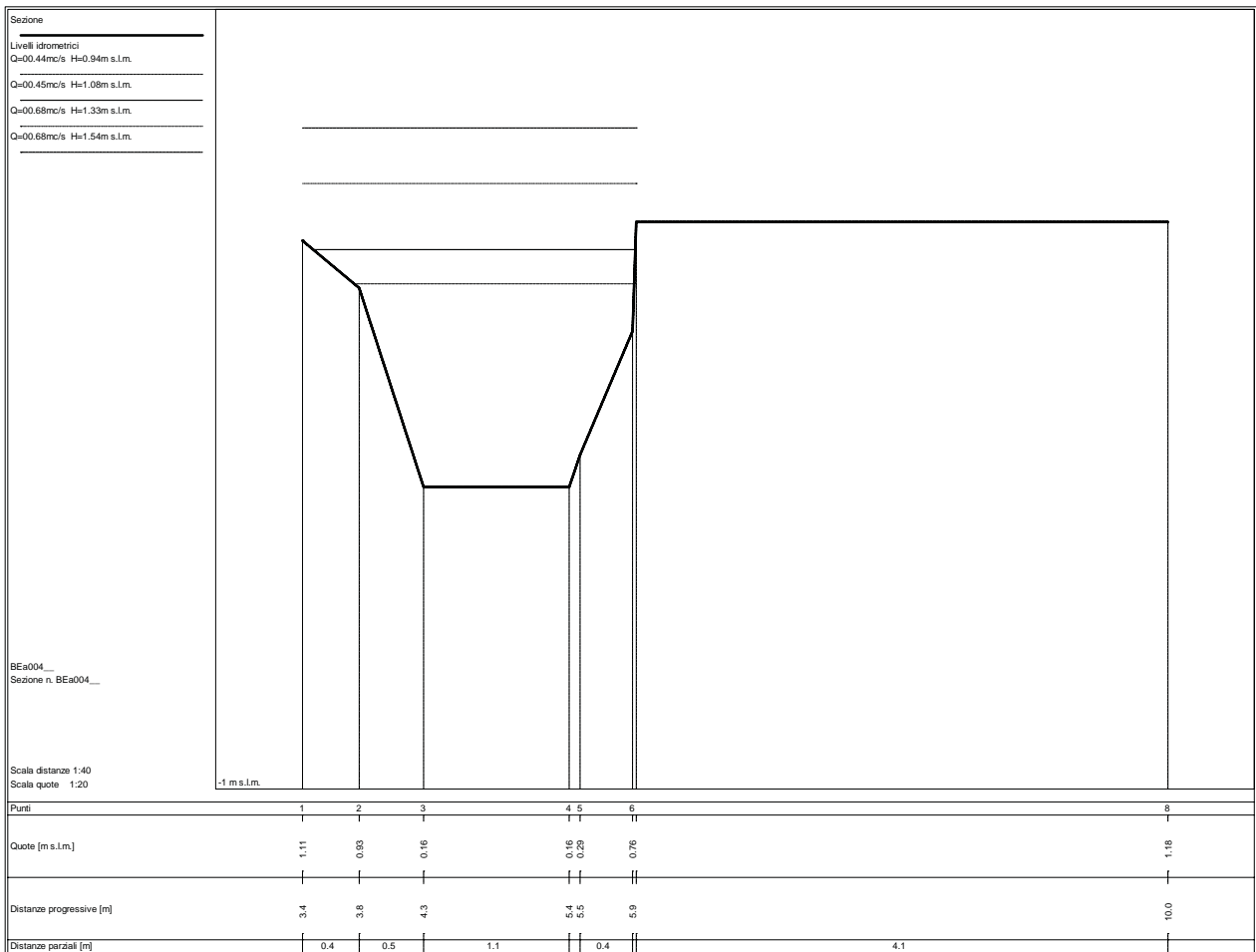
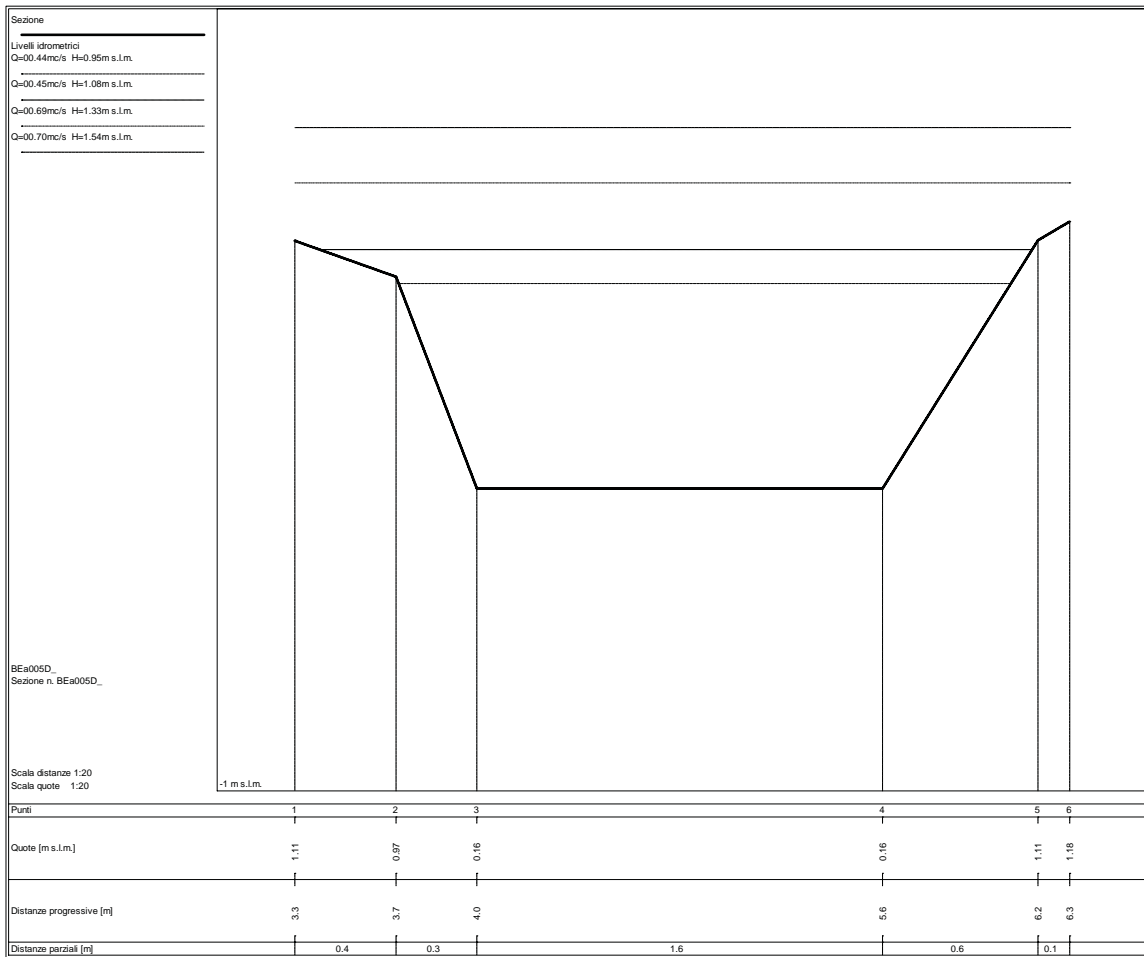

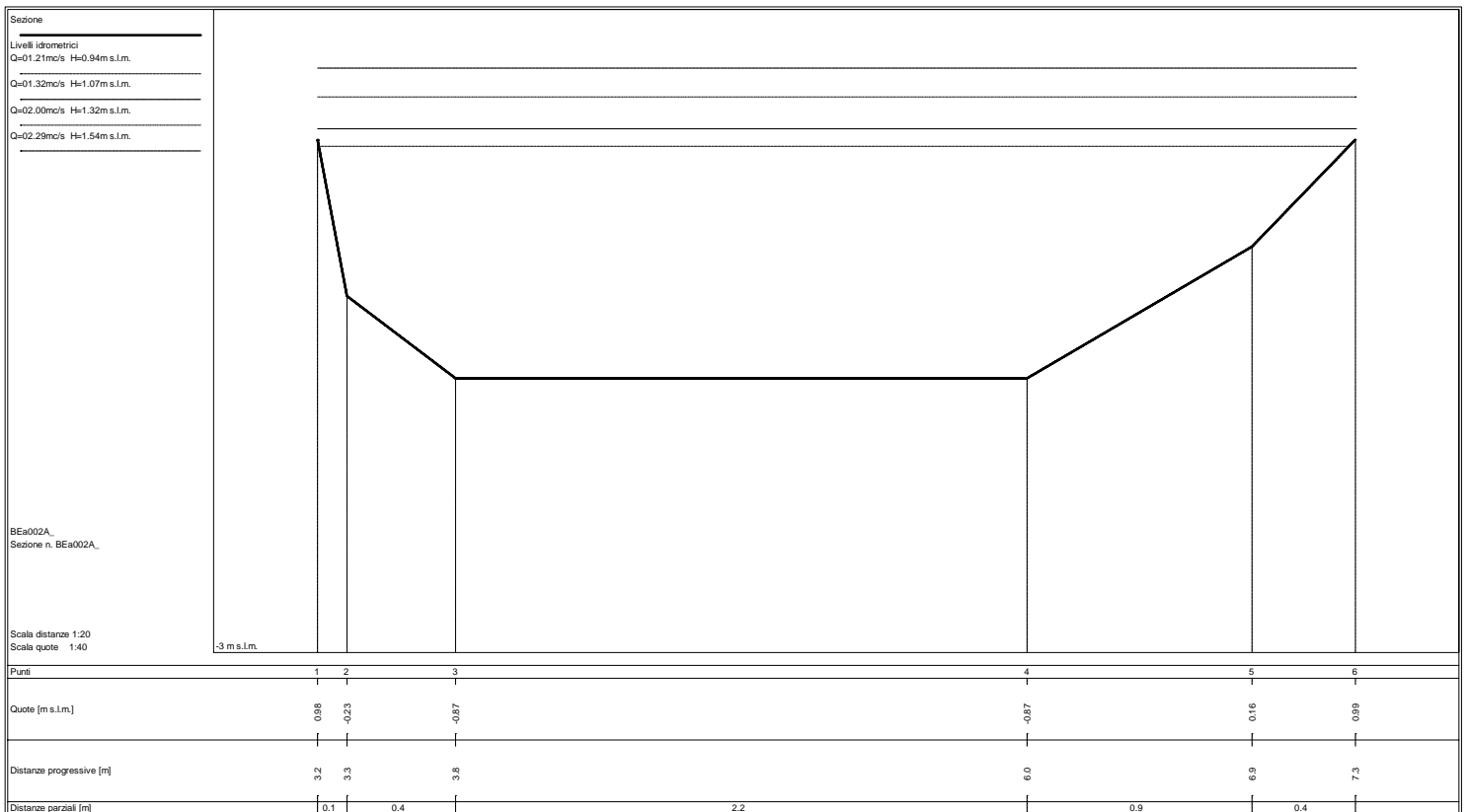
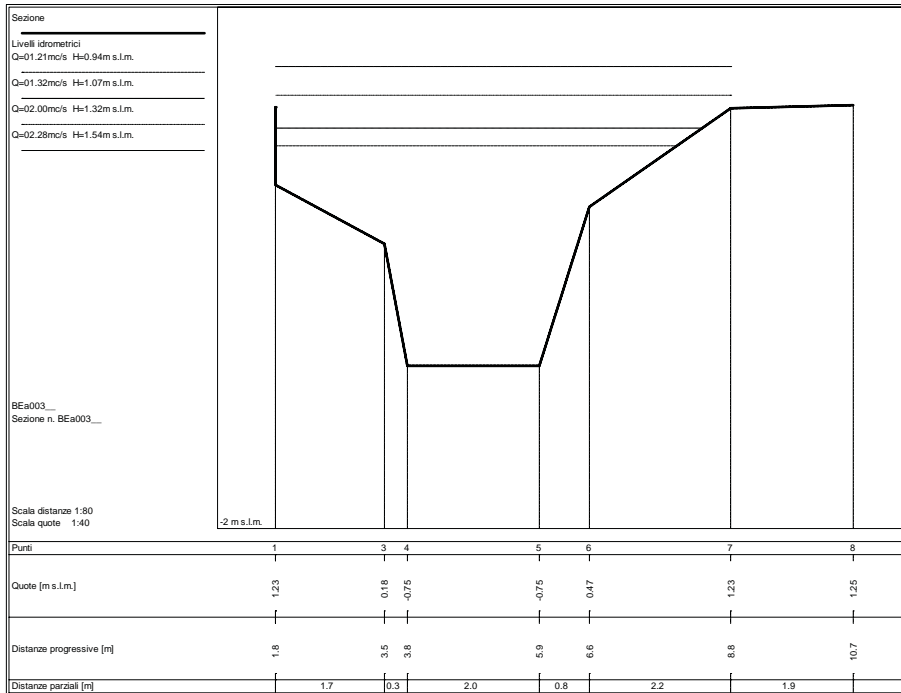

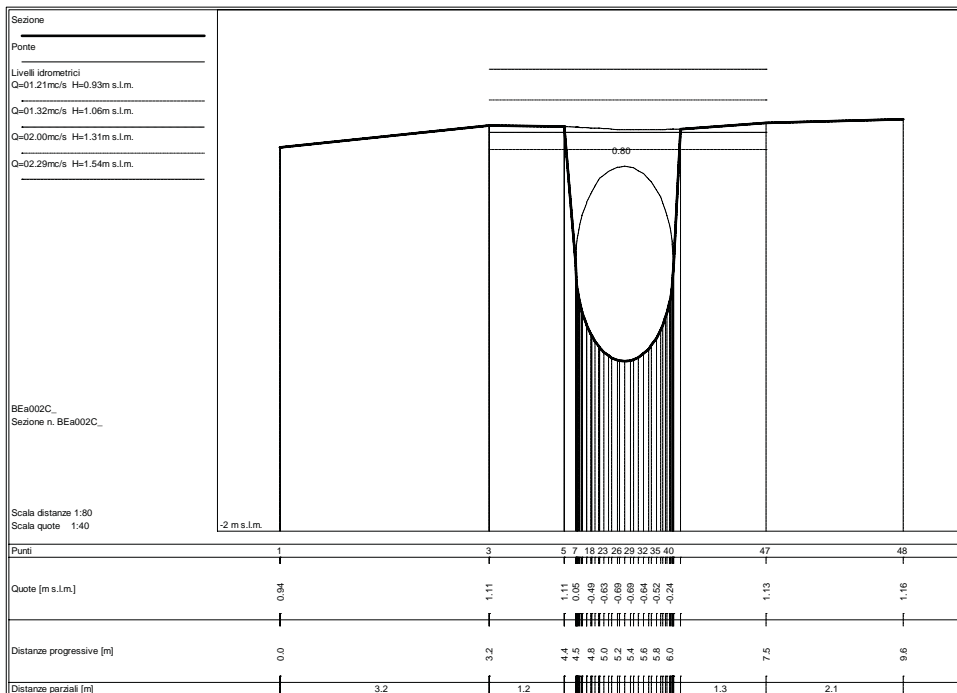
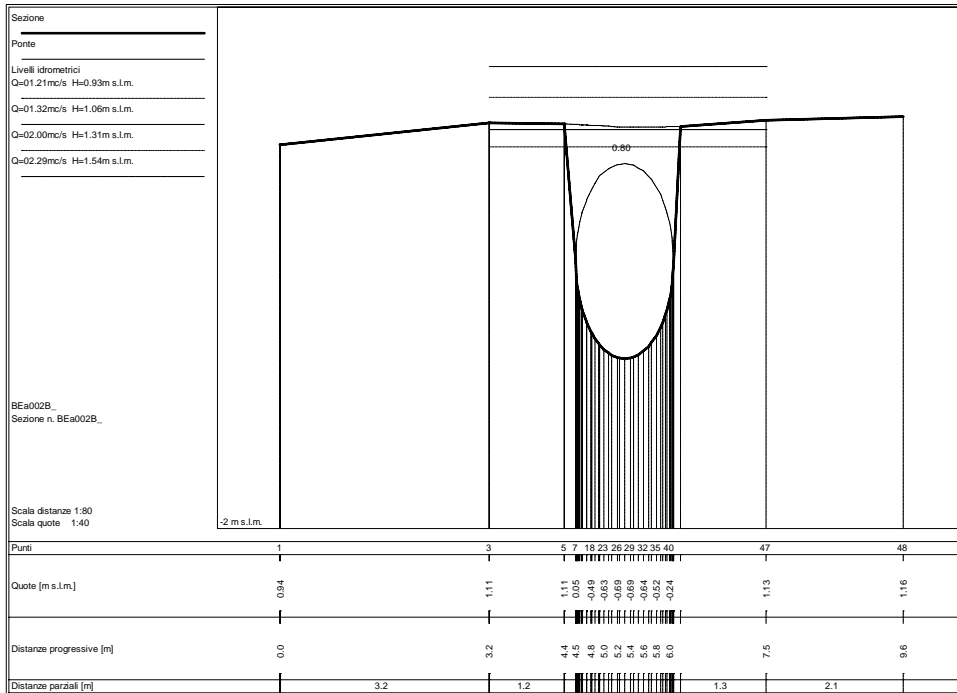

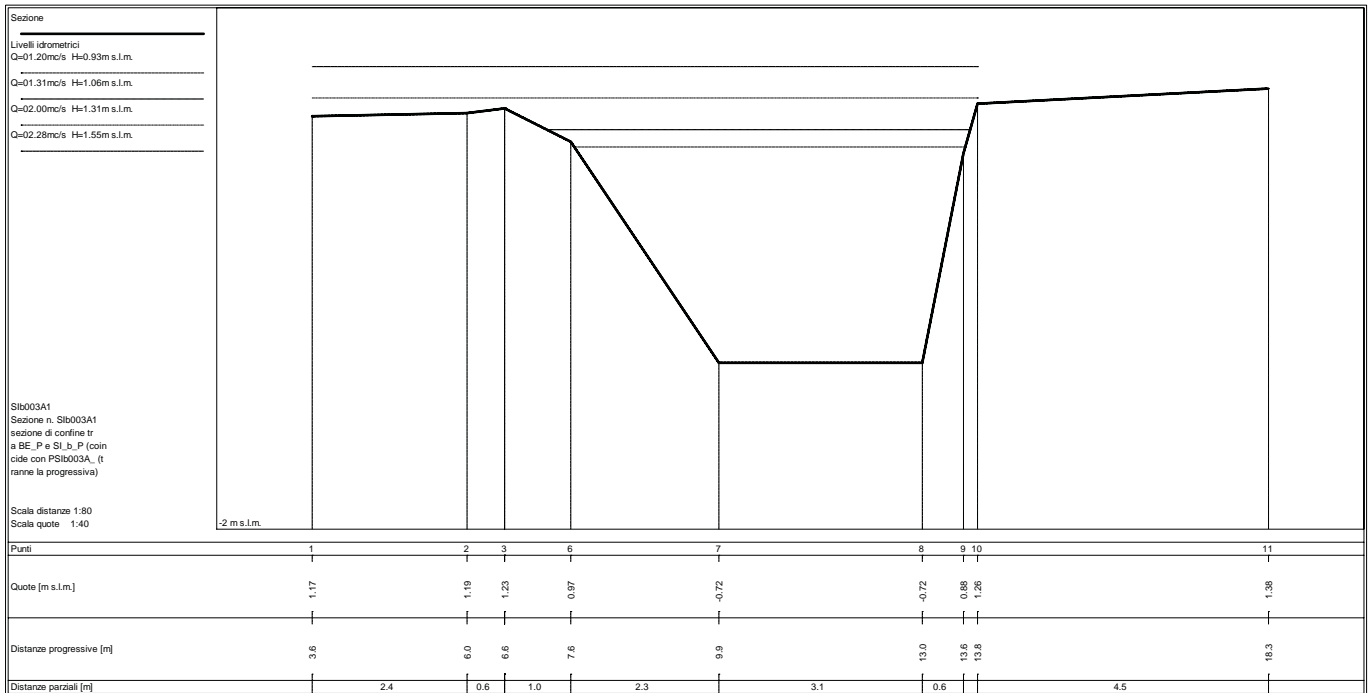
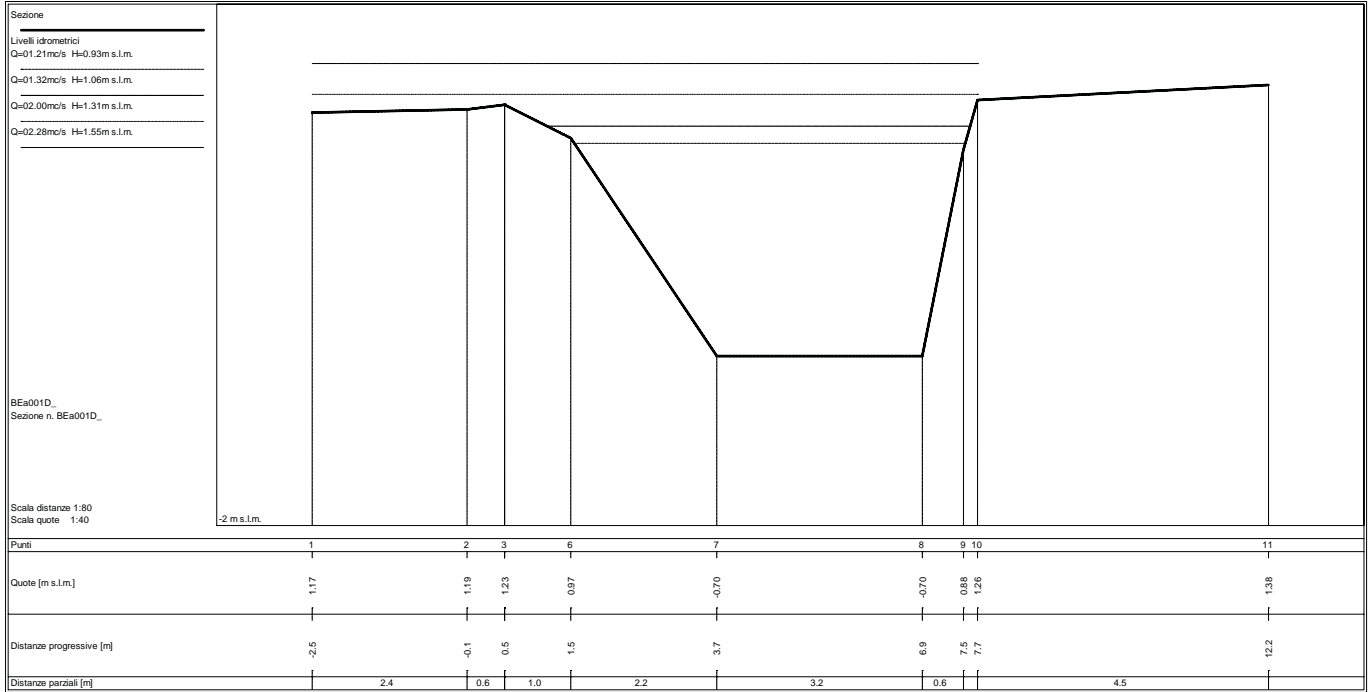

STATO ATTUALE

Sezioni fluviali fosso Connettore – C1_P

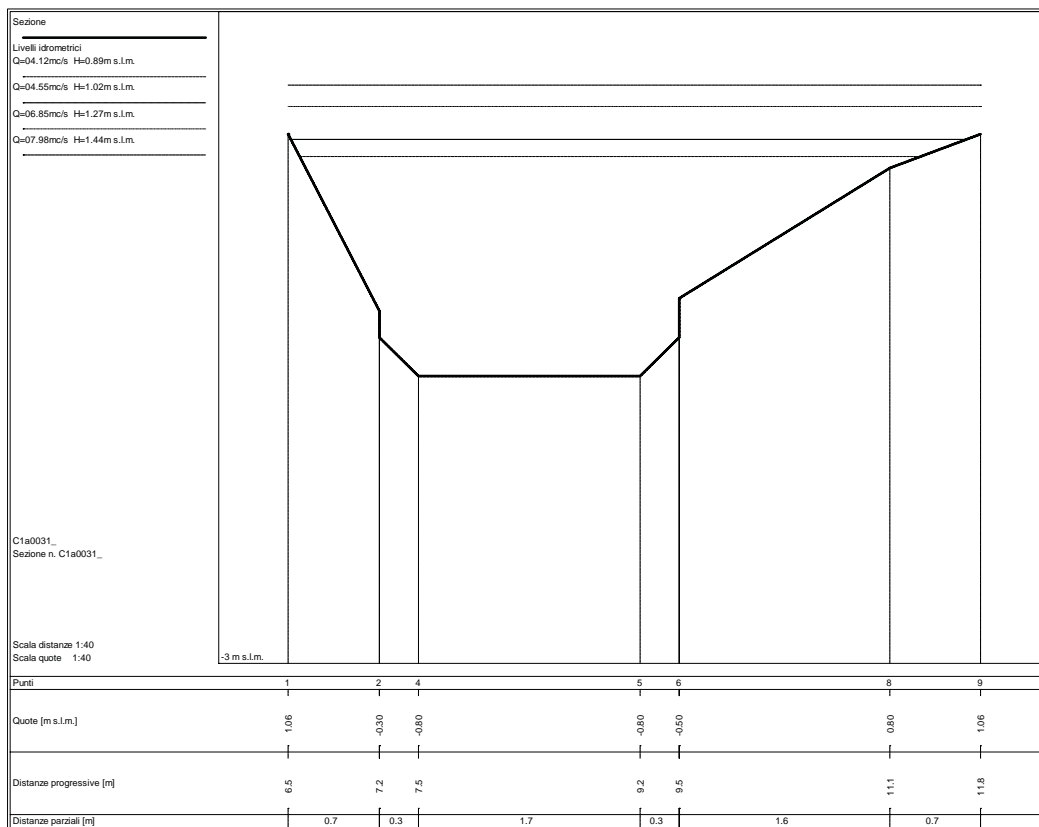
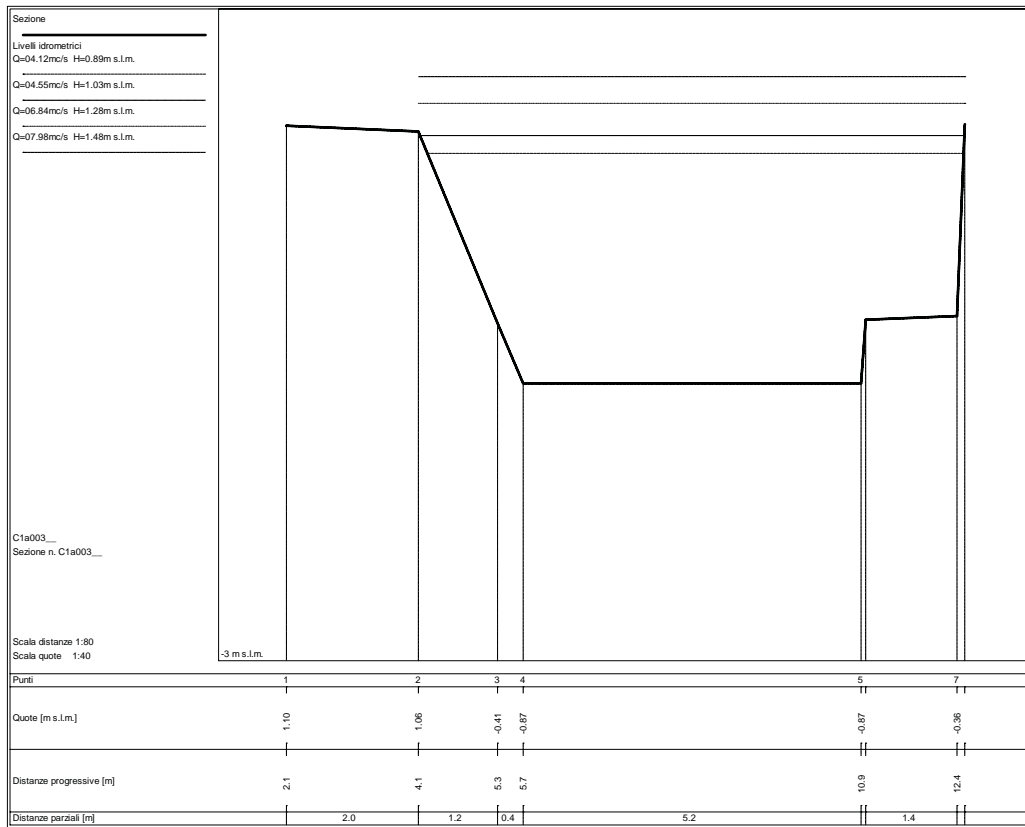

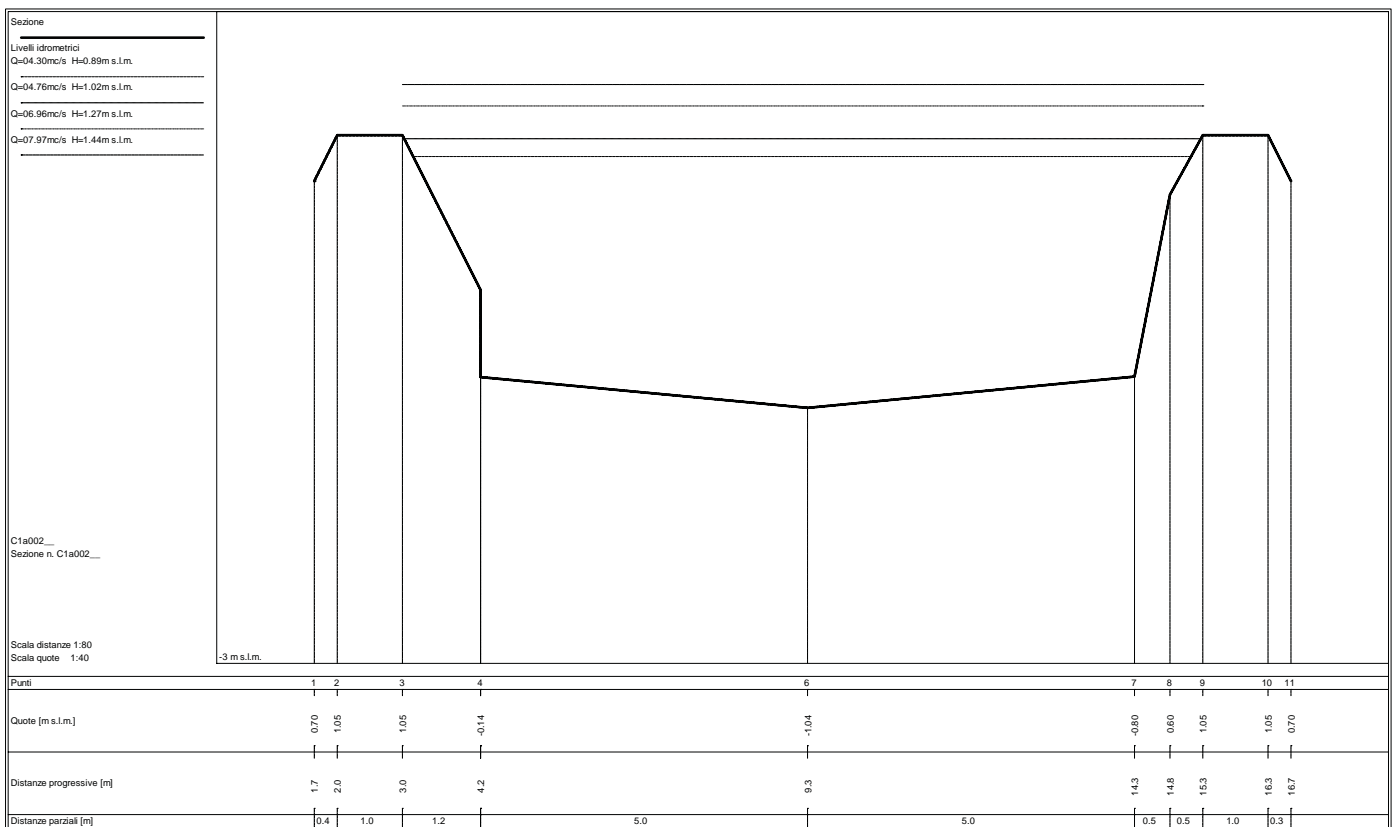
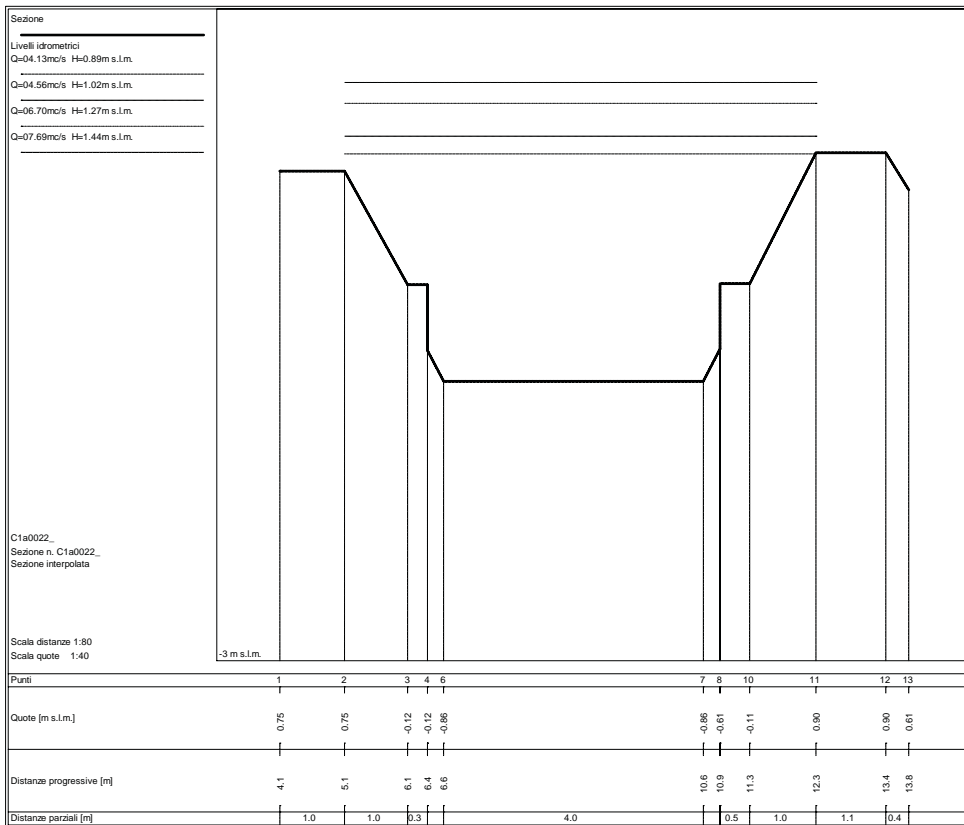

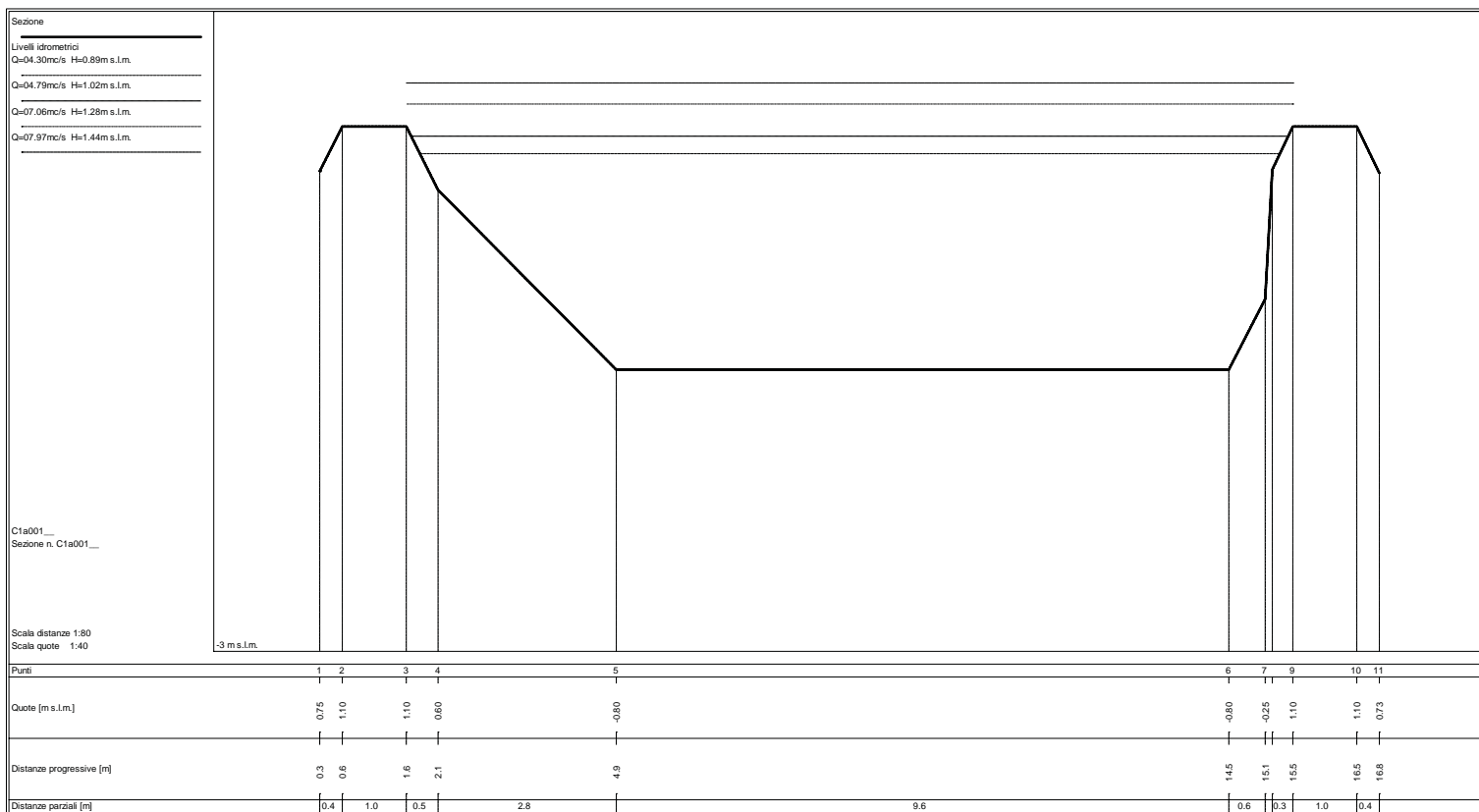
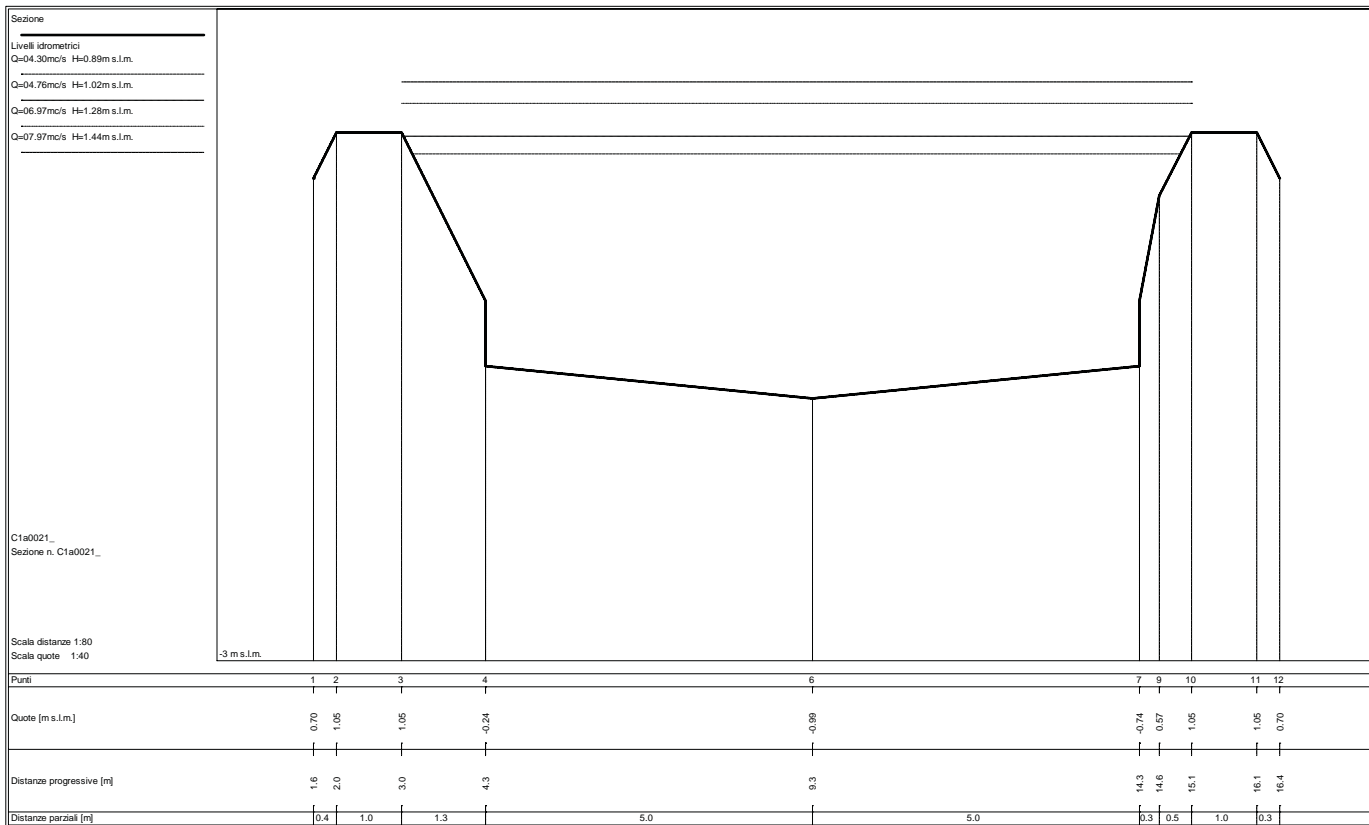

Sezione

-
-
-
-
-
-

C2a005_
Sezione n. C2a005_

Scala distanze 1:80
Scala quote 1:40

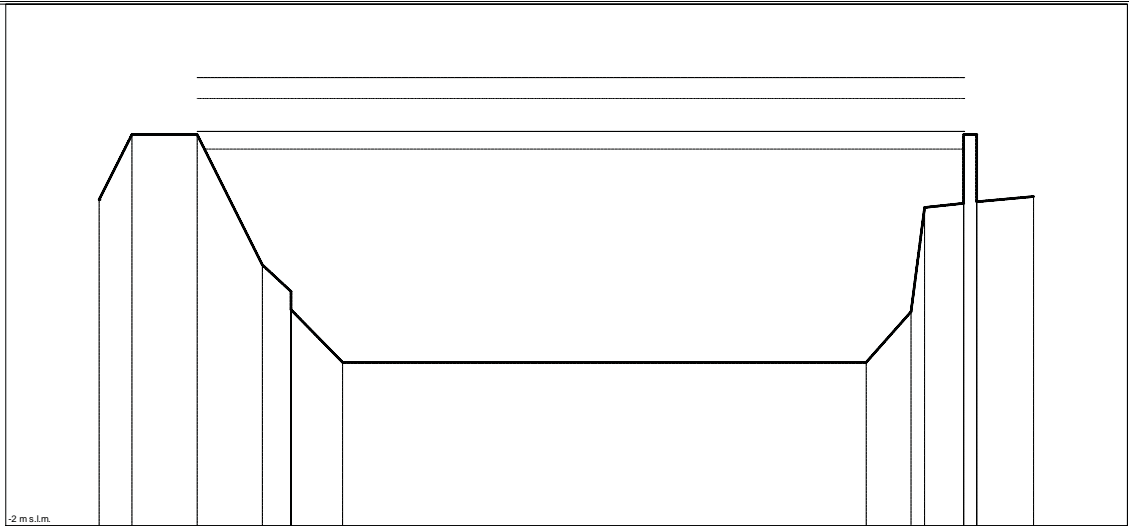

Punti	1	2	3	4	5	7	8	9	10	11	13	15
Quote [m s.l.m.]	0.50	1.00	1.00	0.00	-0.20	-0.75	-0.75	-0.36	0.44	0.47	1.00	0.52
Distanze progressive [m]	2.9	3.4	4.4	5.4	5.8	6.6	14.7	15.4	15.6	16.2	16.4	17.2
Distanze parziali [m]	0.5	1.0	1.0	0.4	0.8	8.0	0.7	0.6	0.9			

STATO ATTUALE

Sezioni fluviali fosso Connettore – C2_P

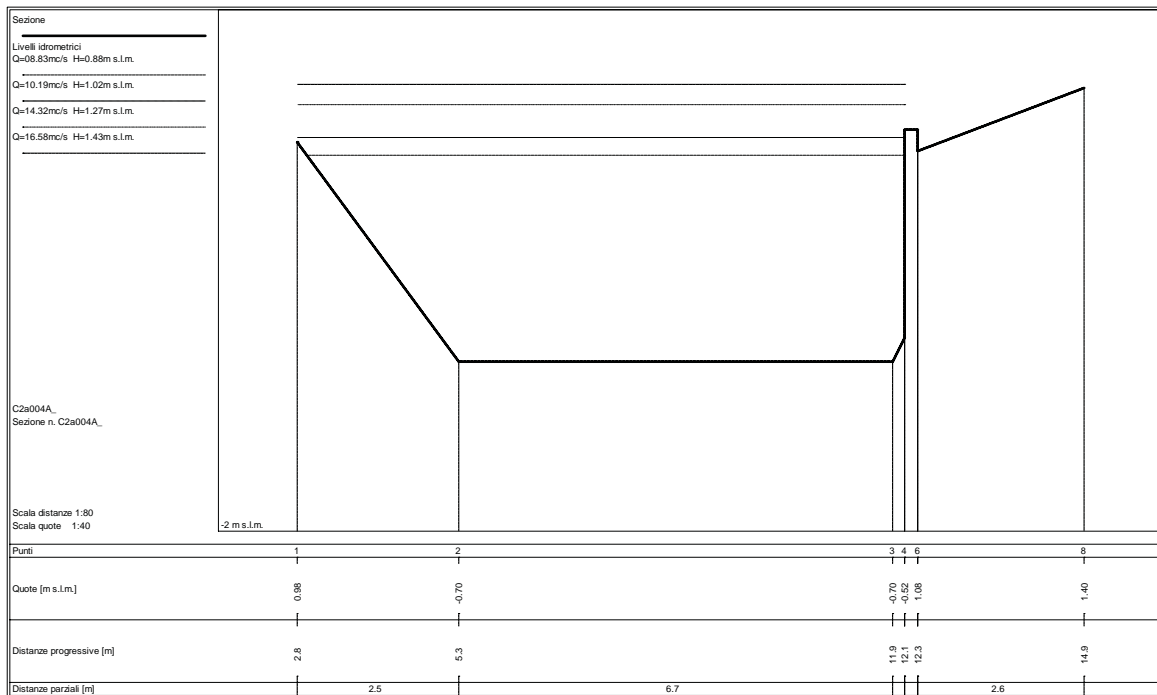
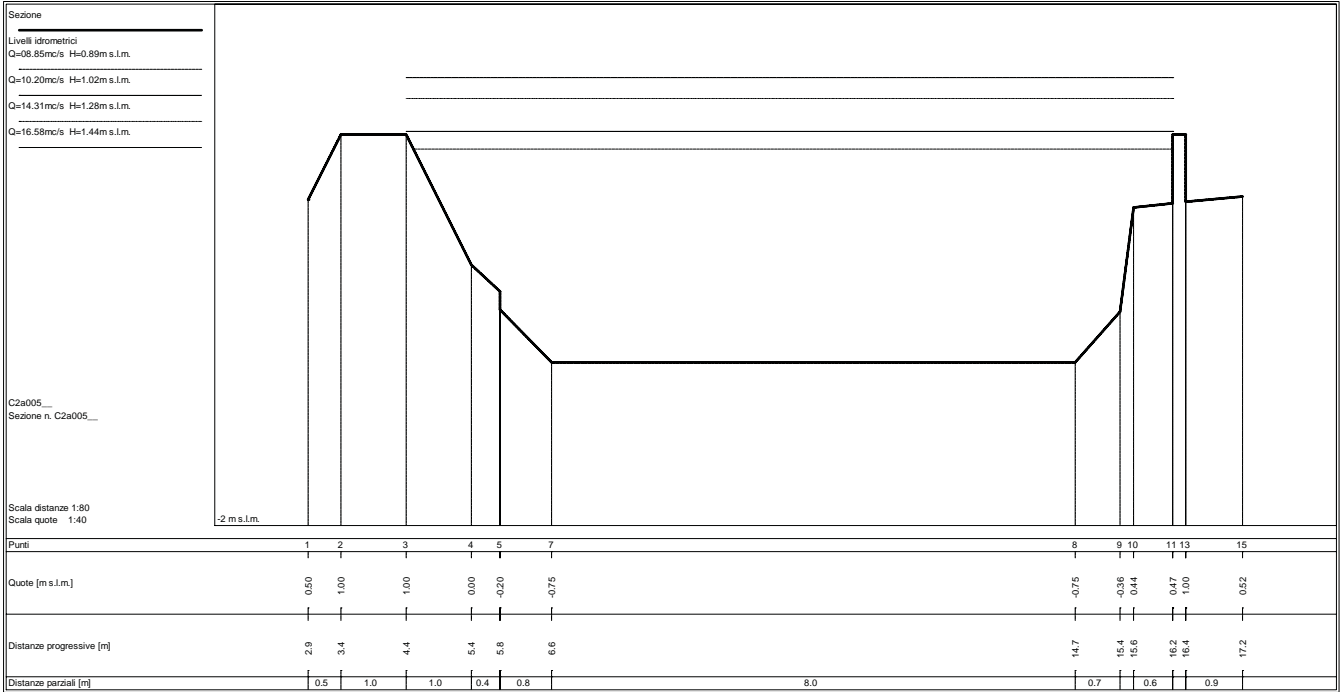

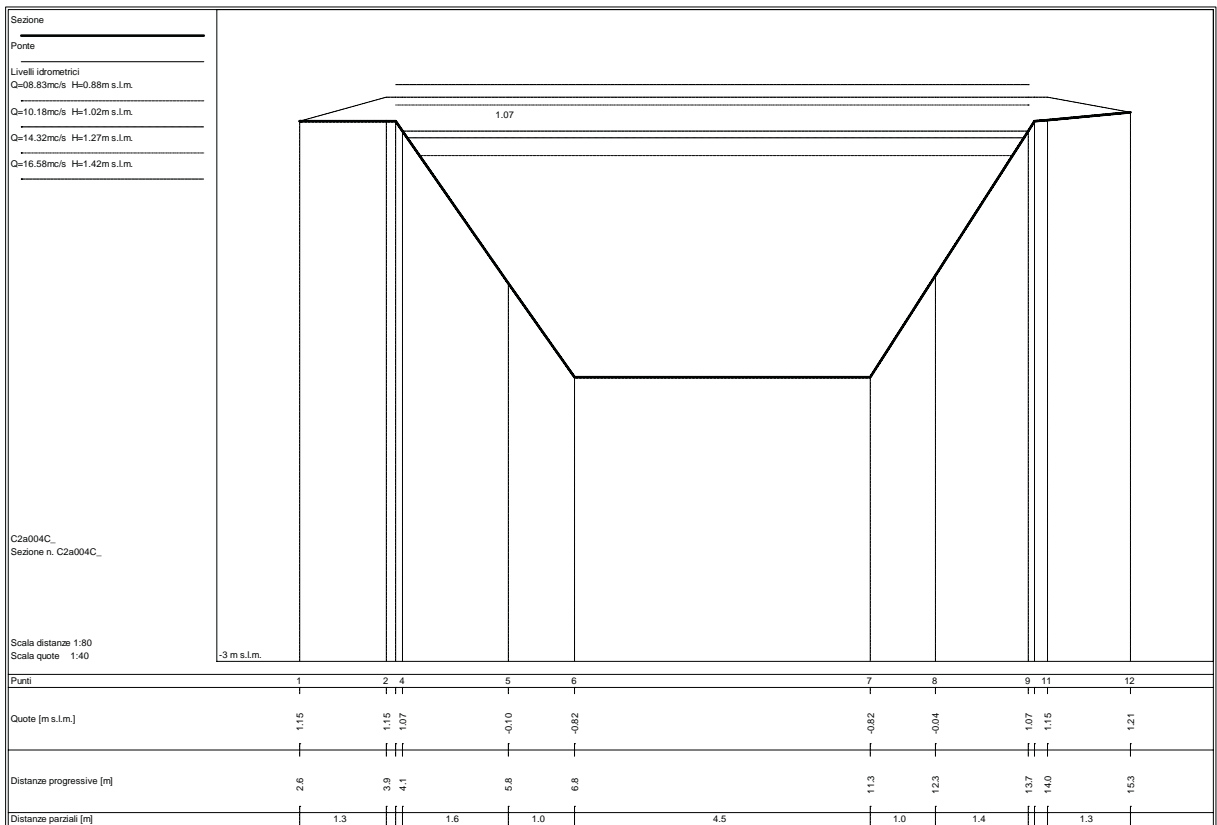
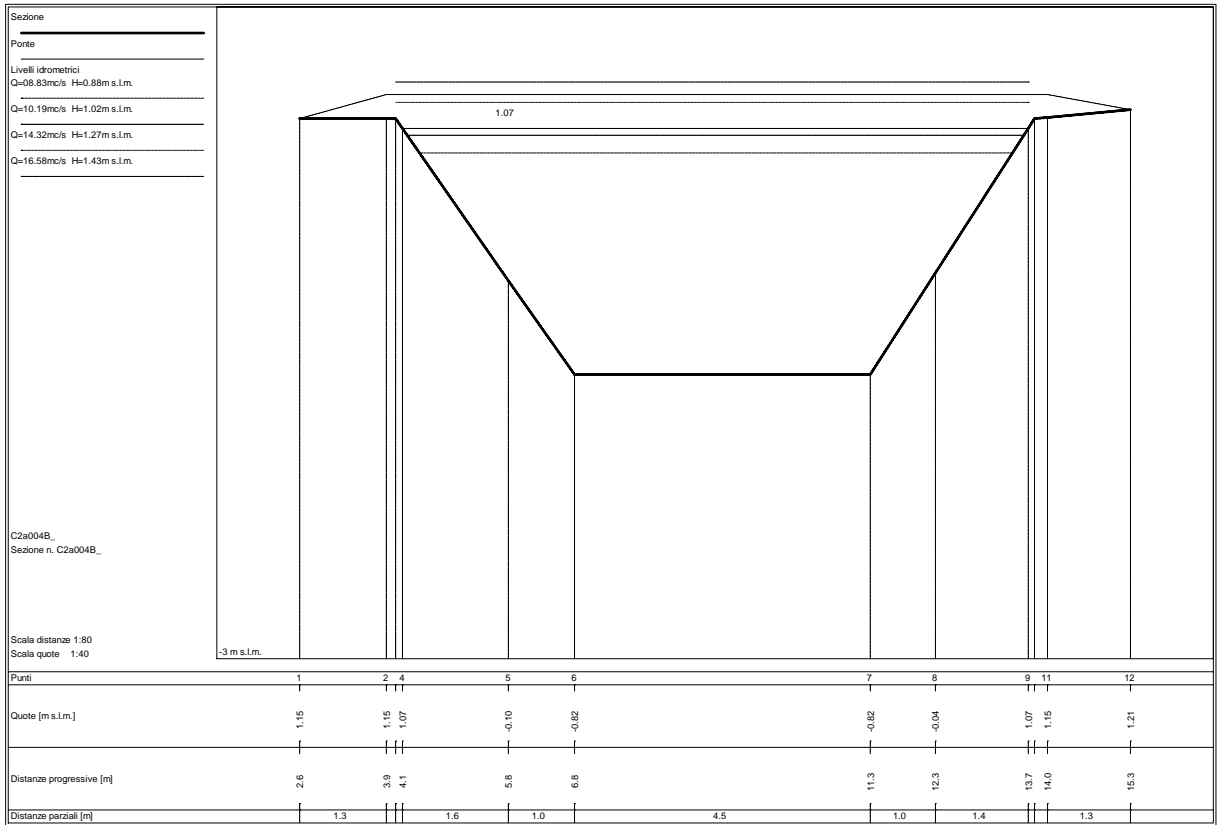

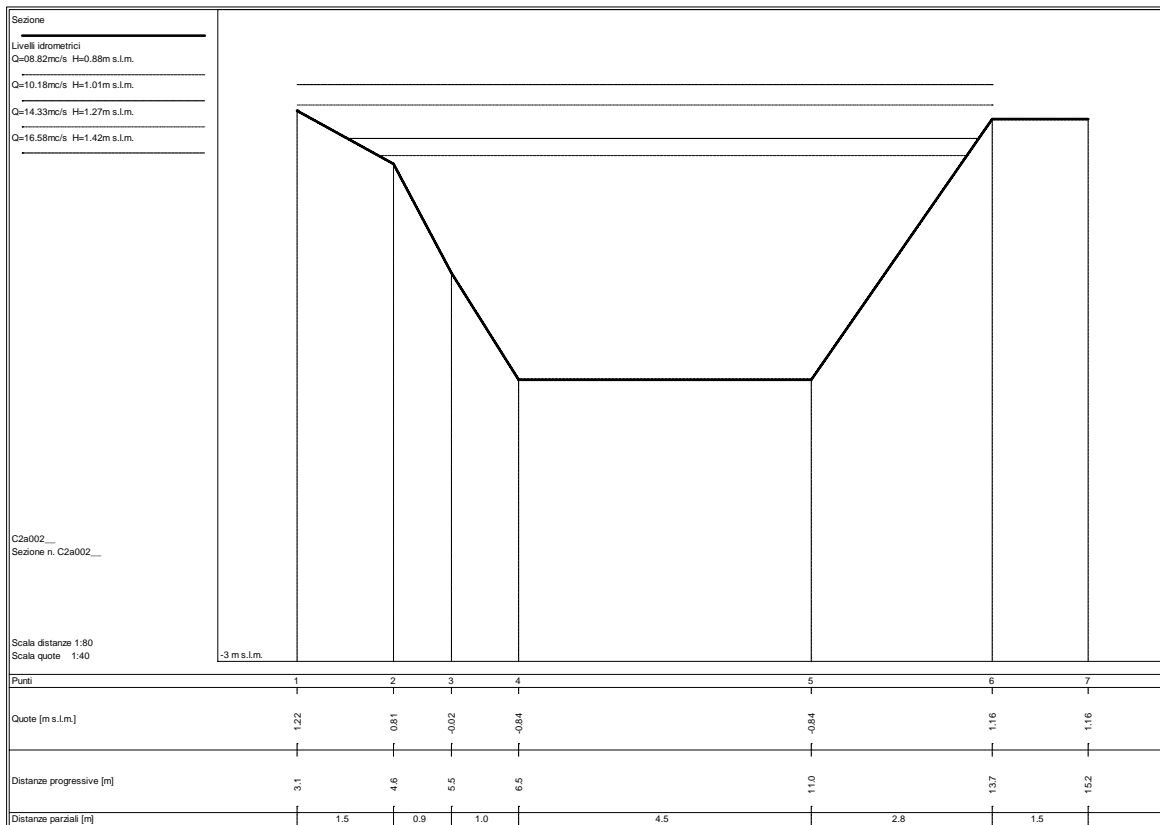
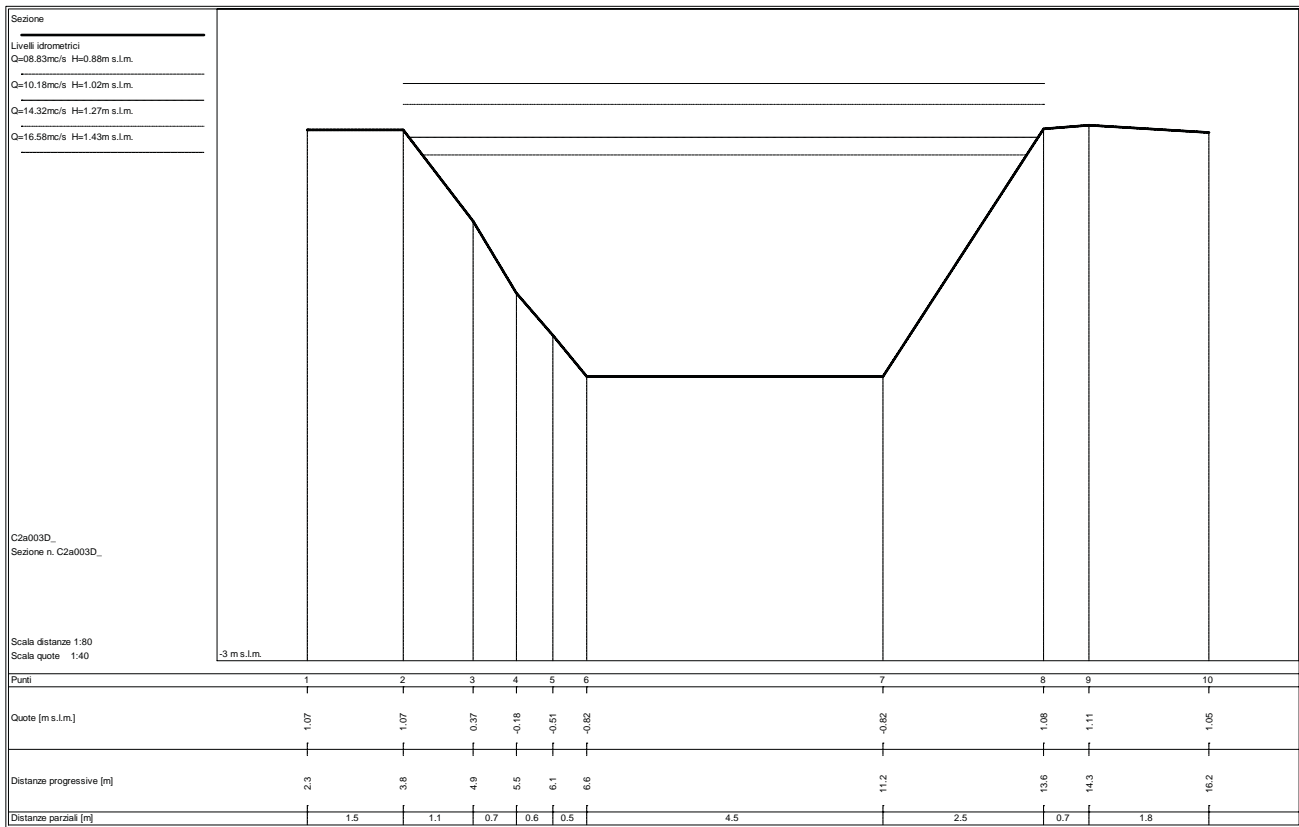

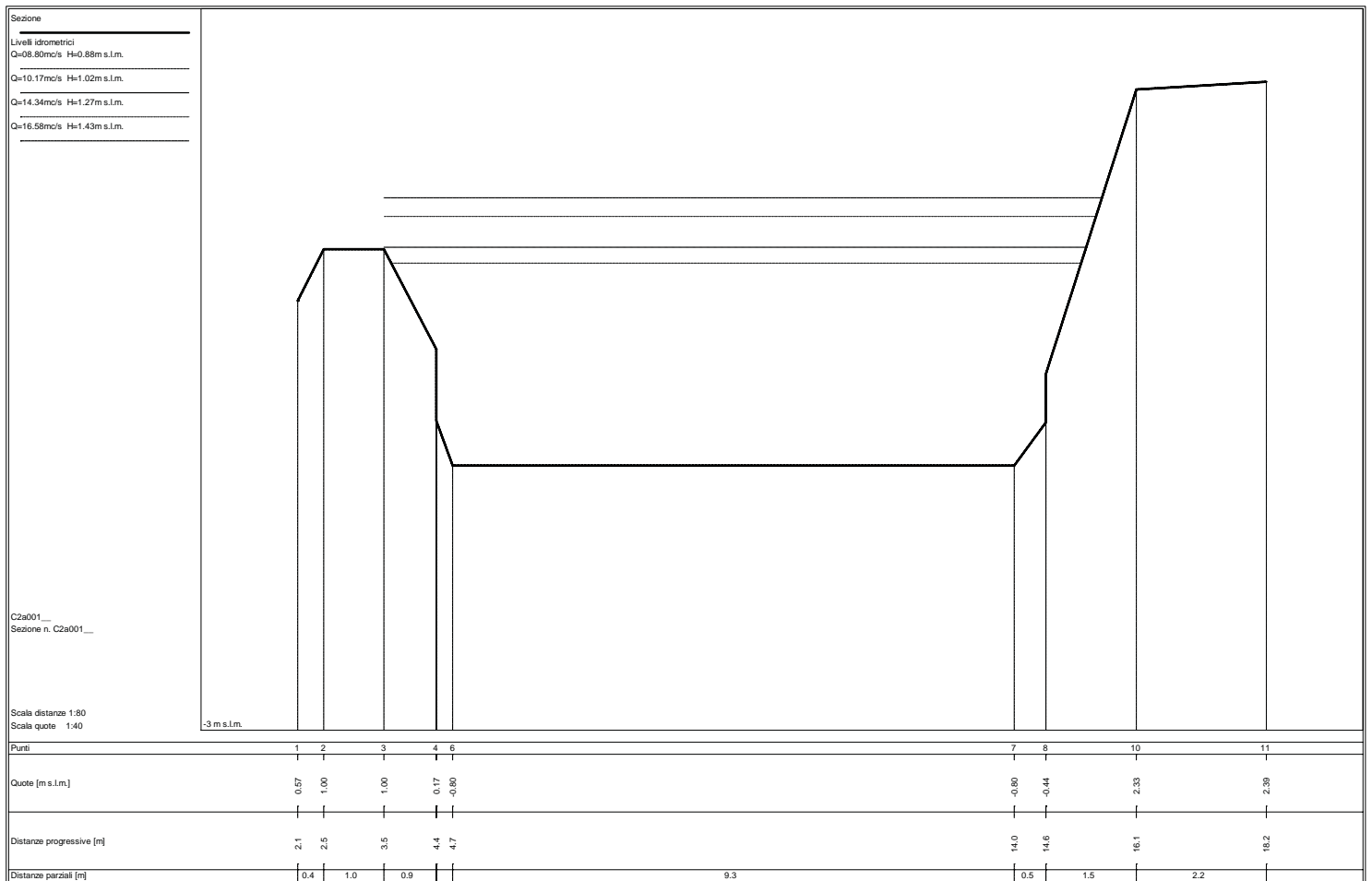
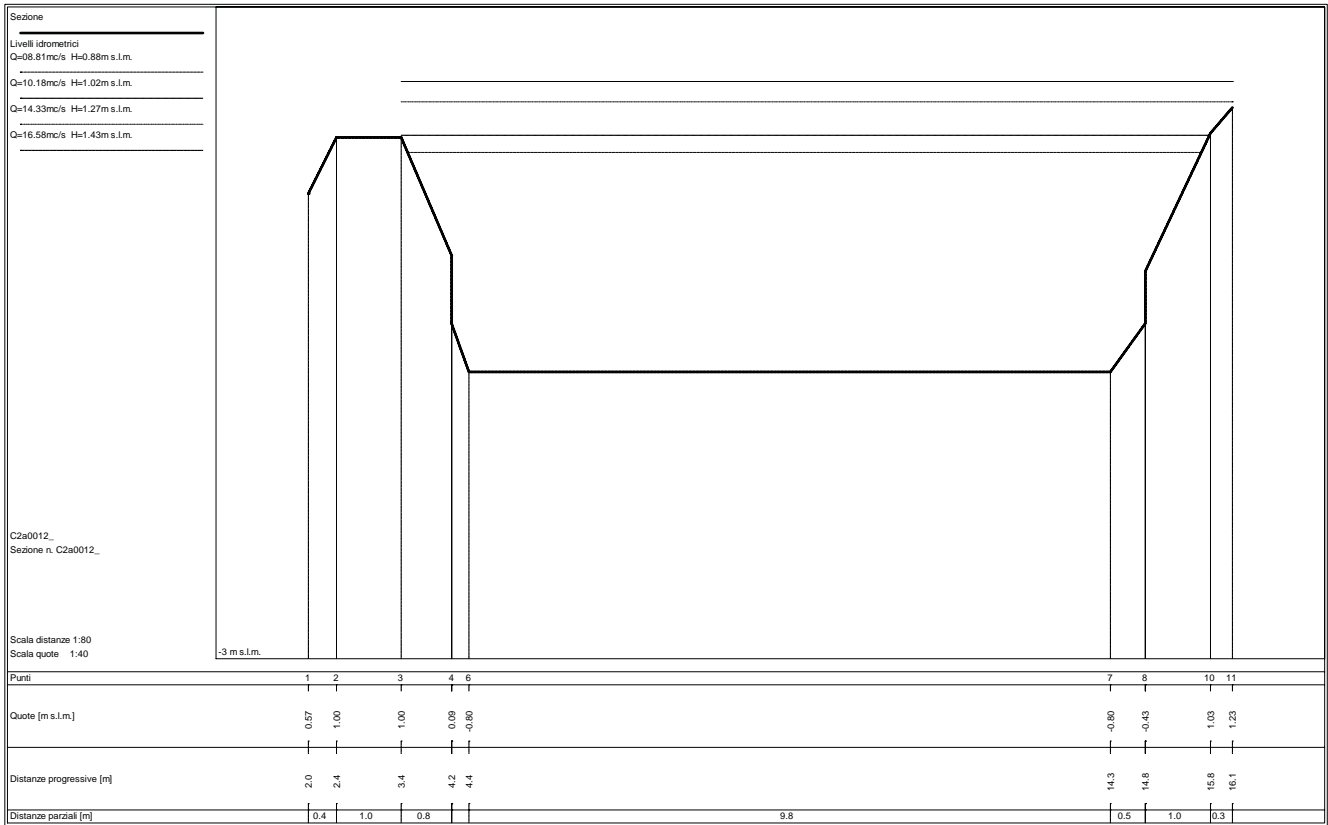

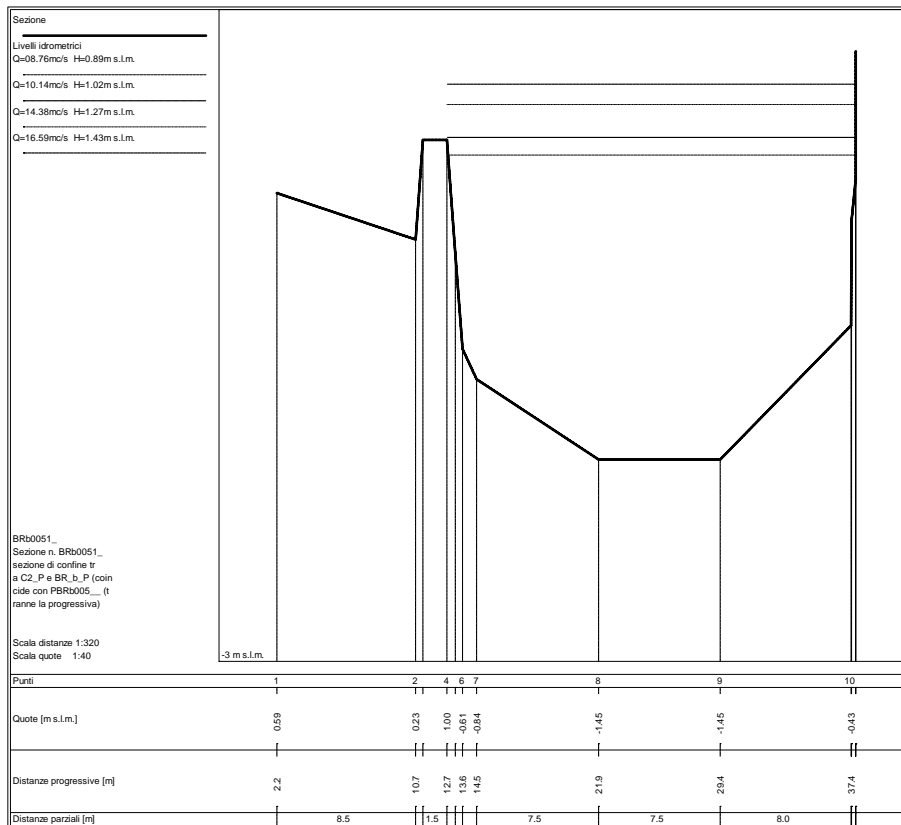
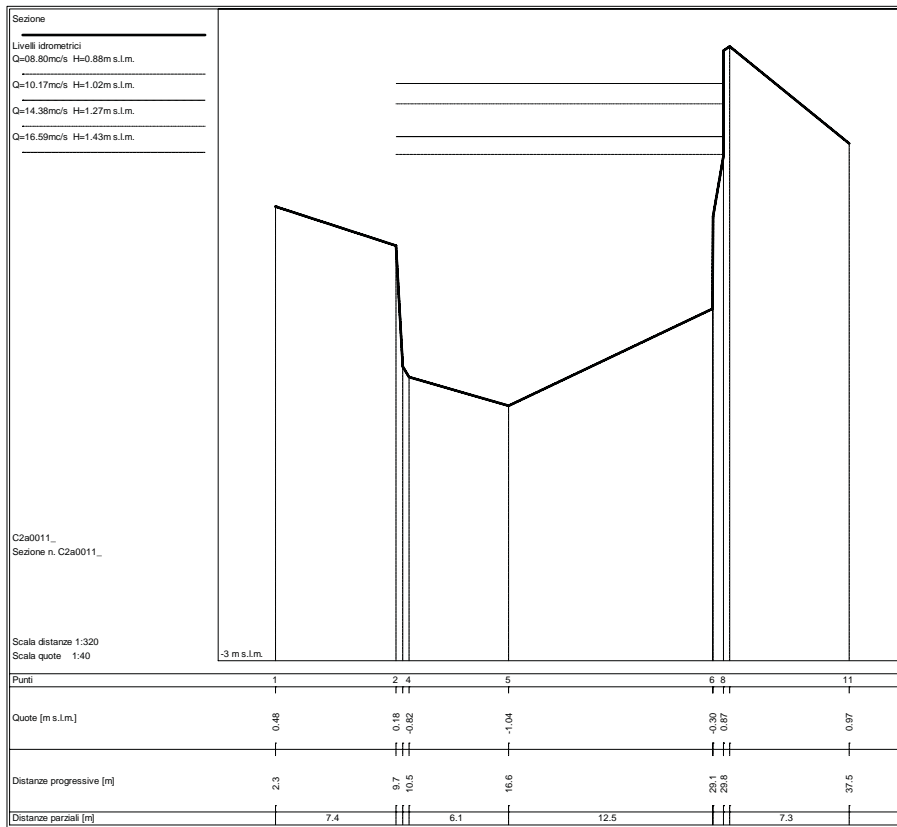

STATO ATTUALE
Sezioni fluviali fosso Dalmine

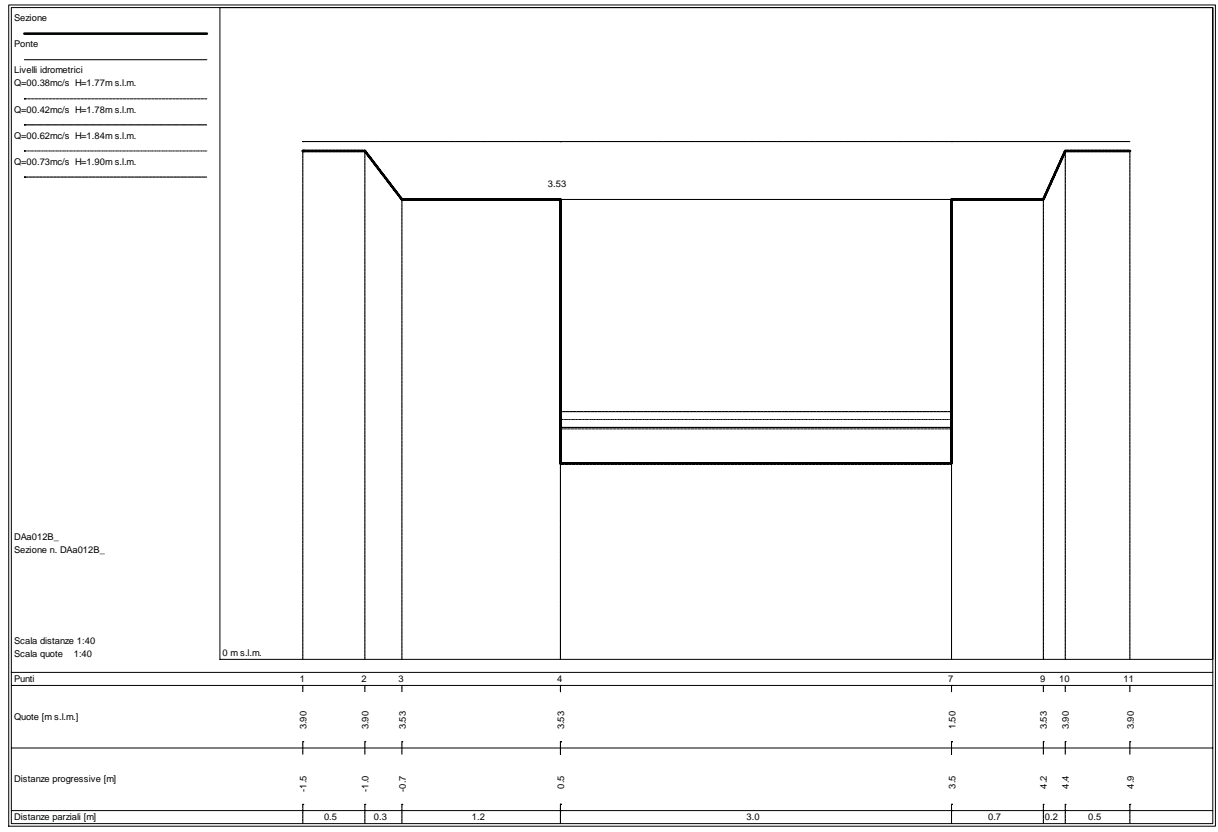
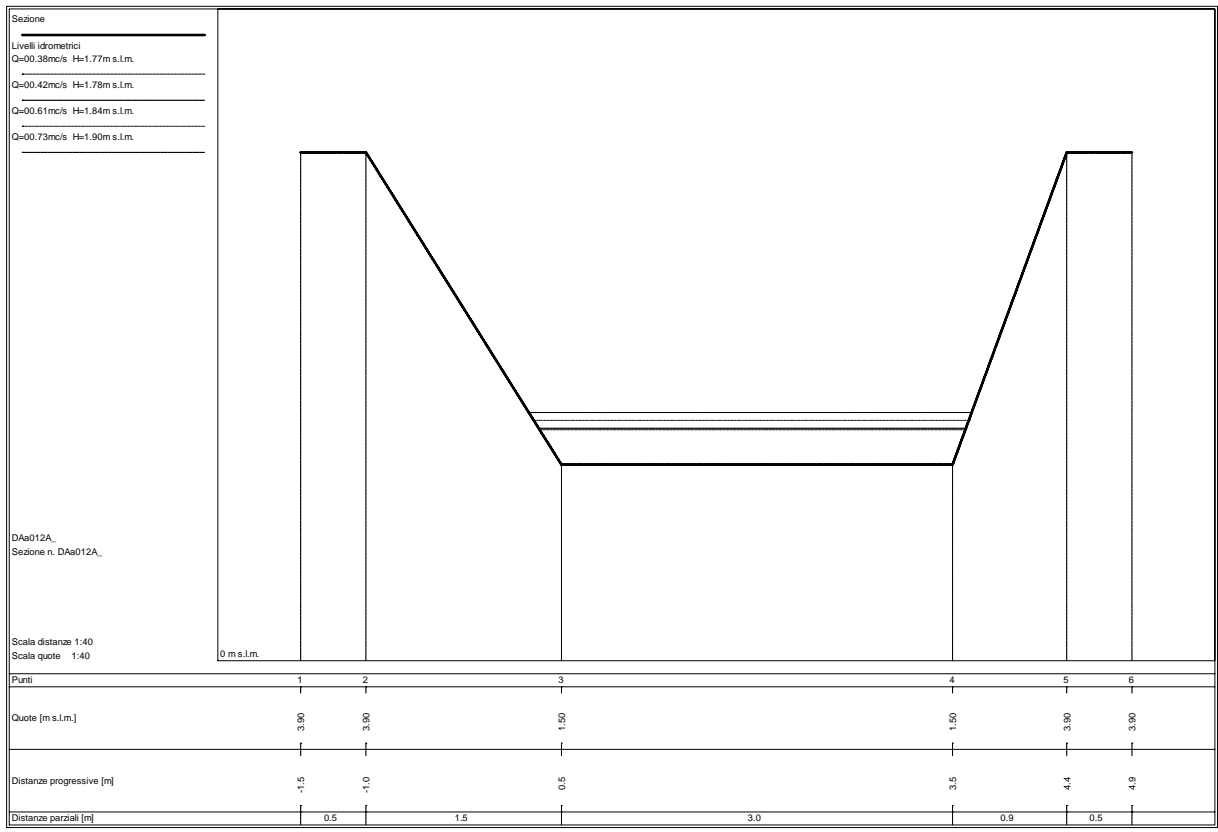

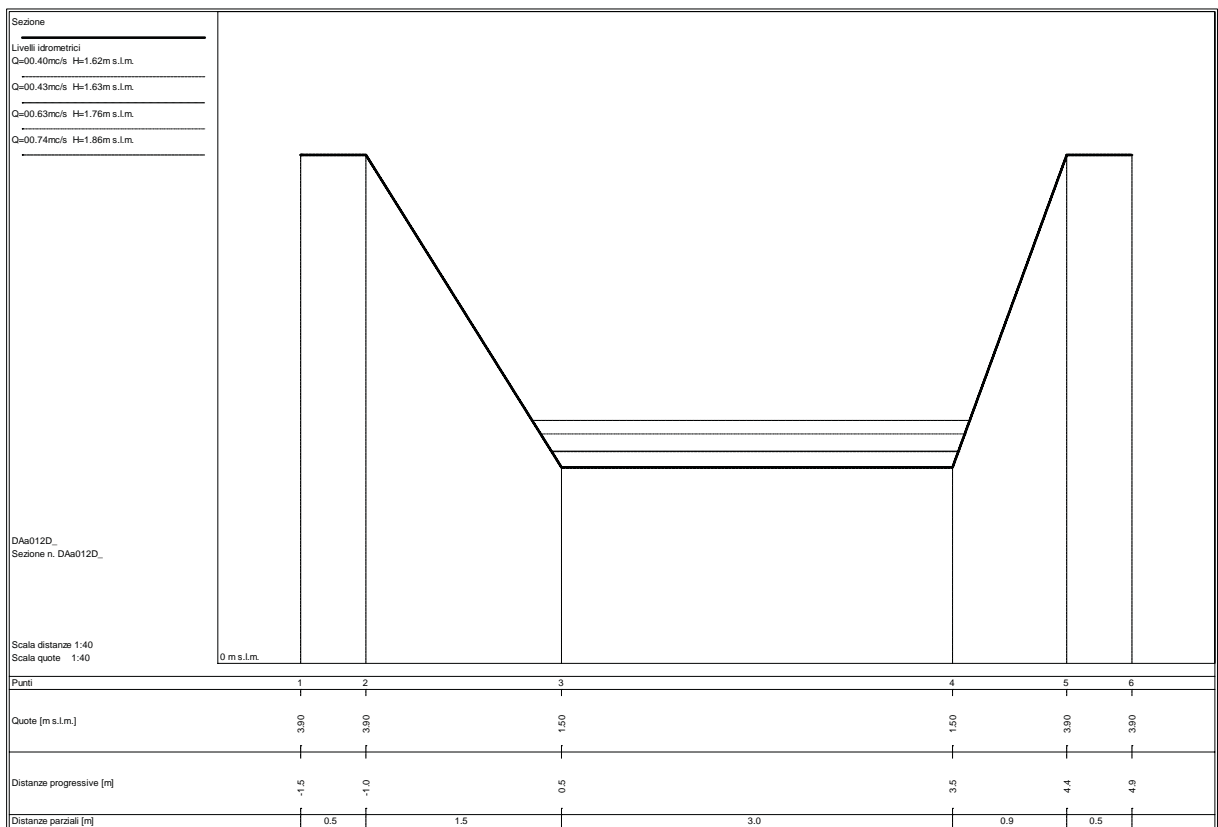
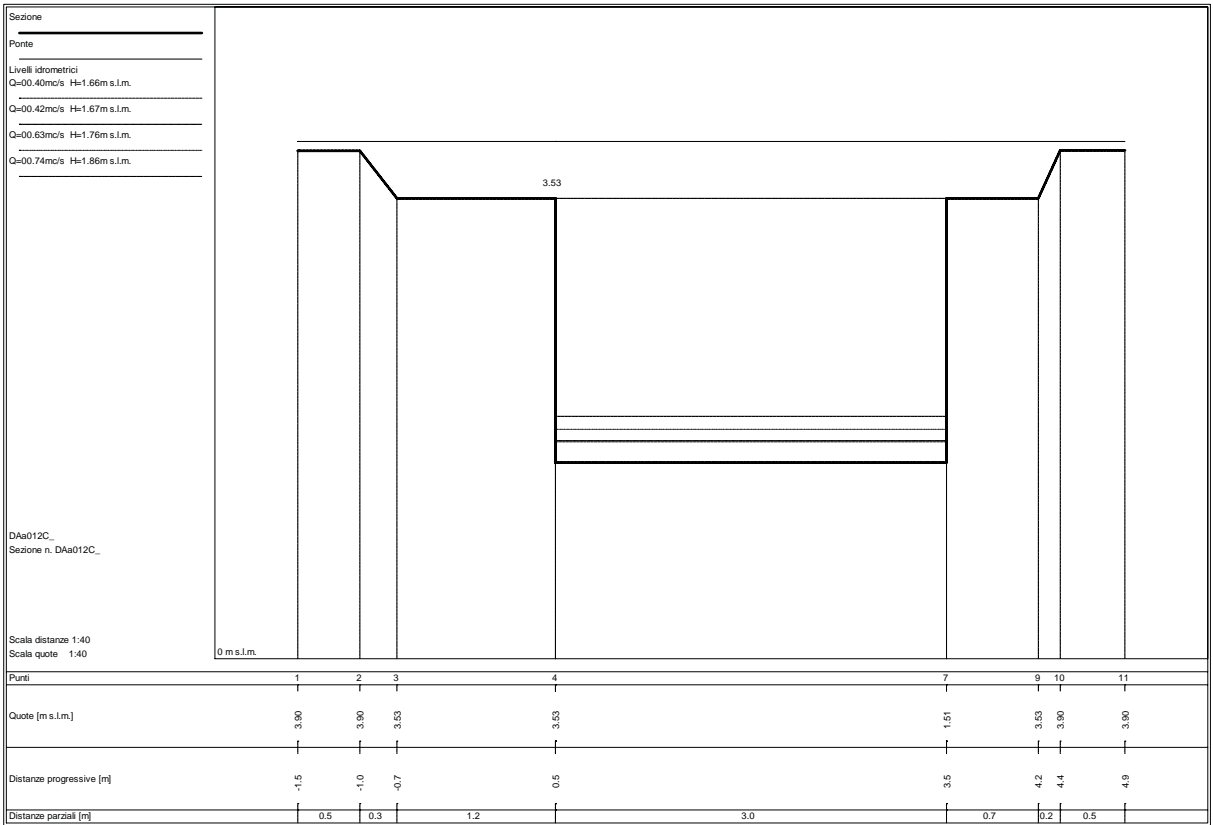

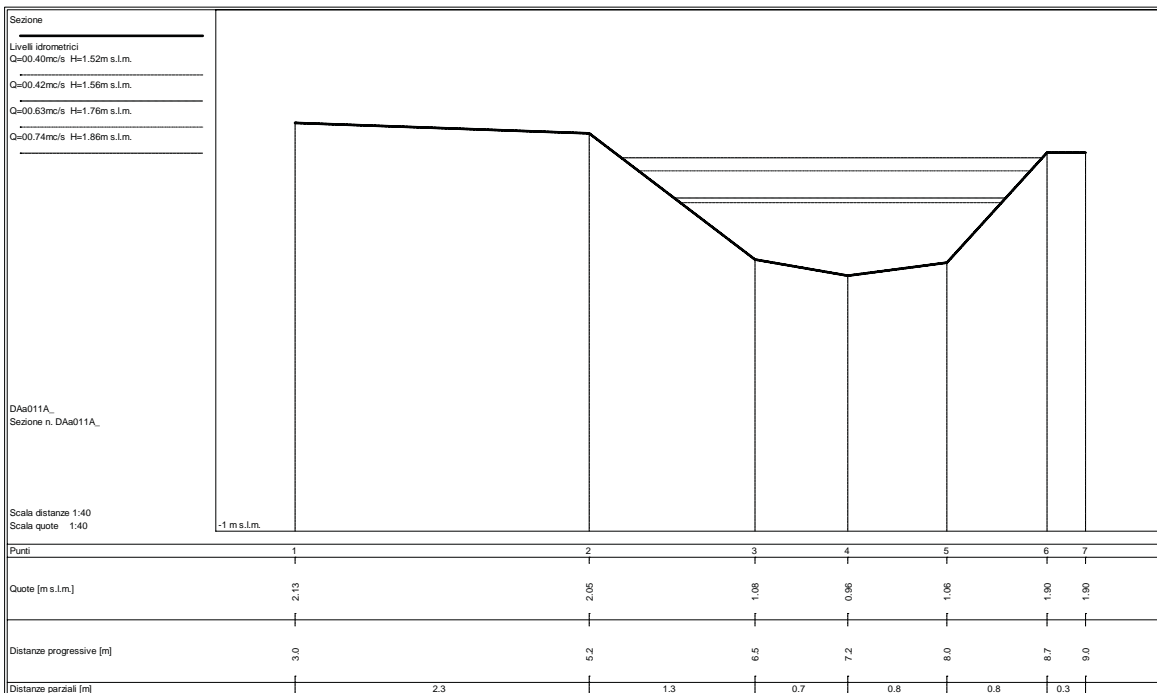
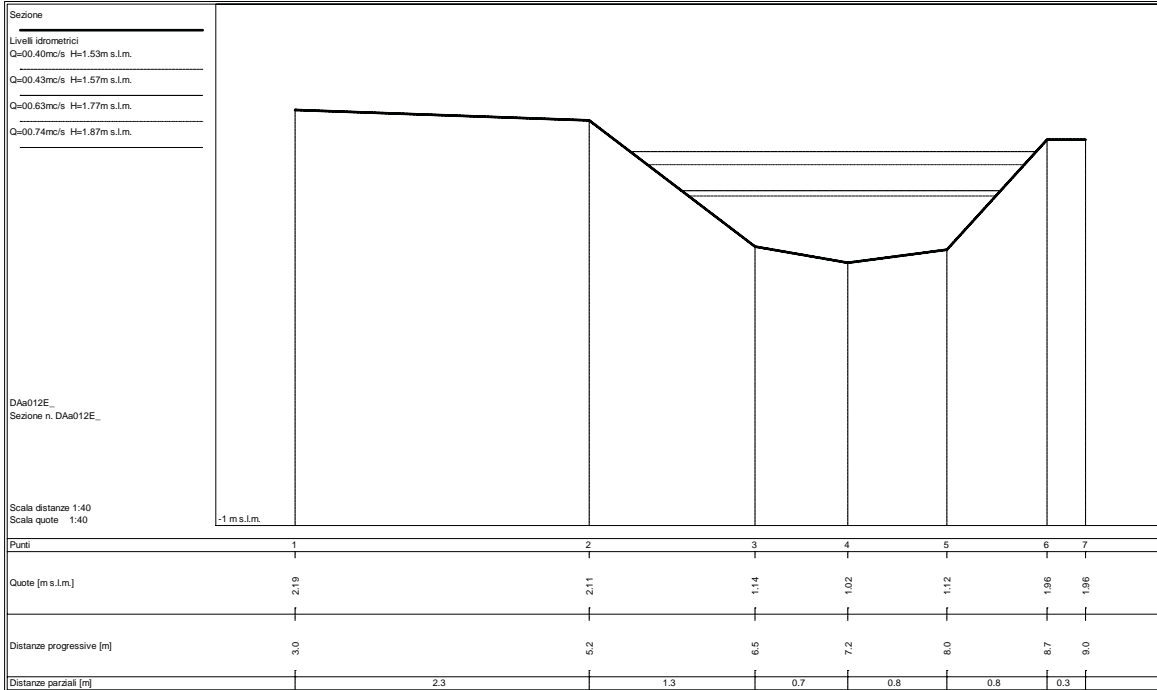

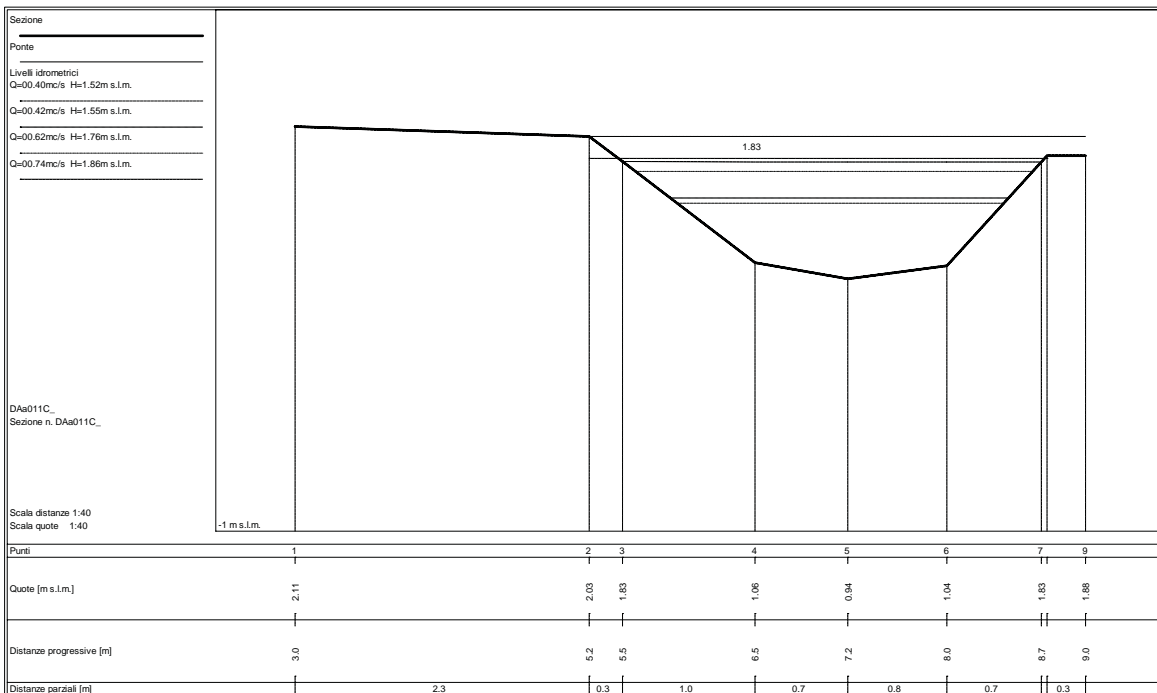
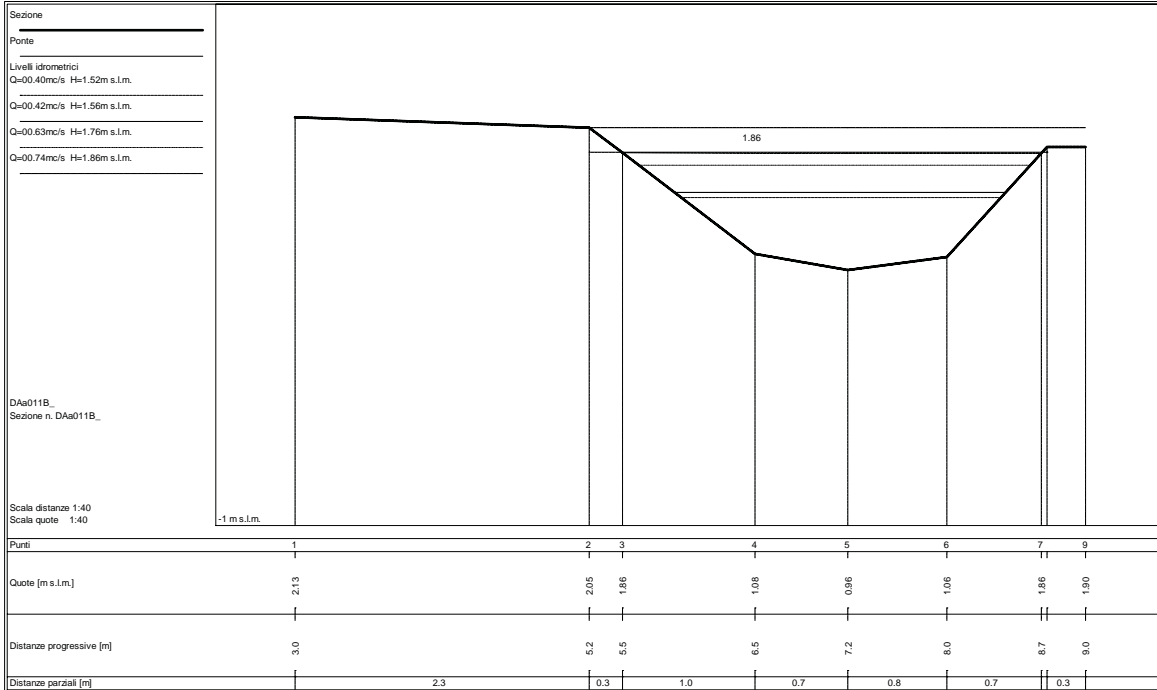

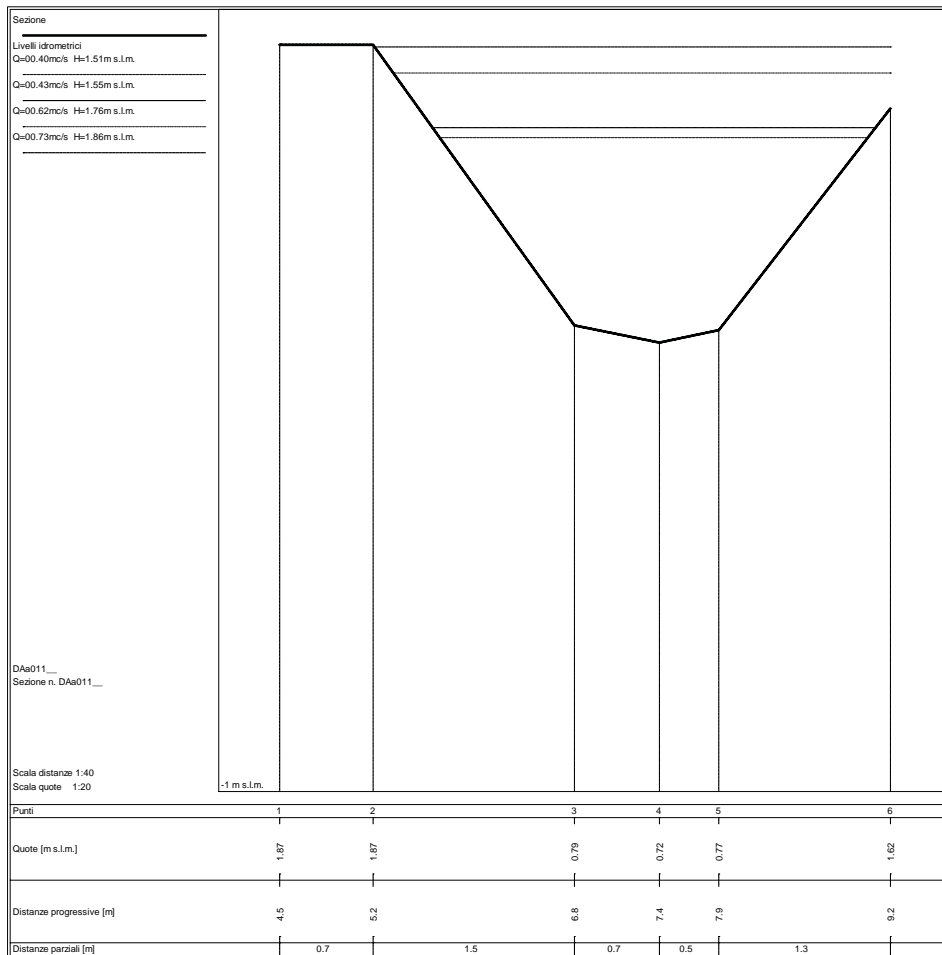
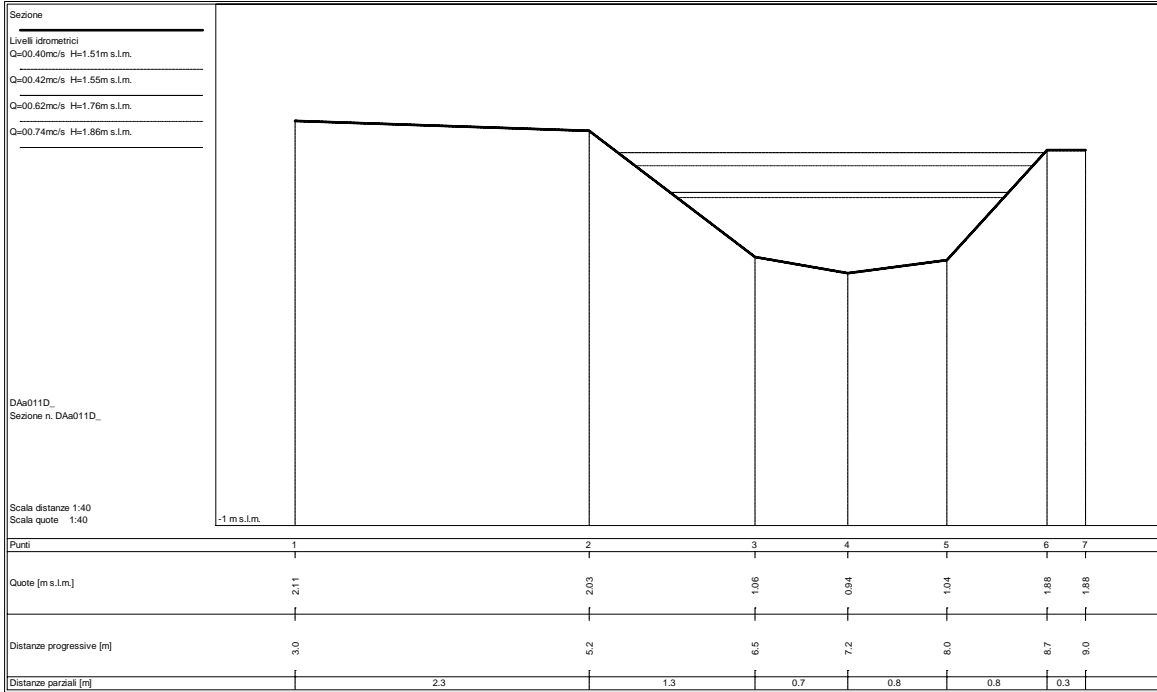

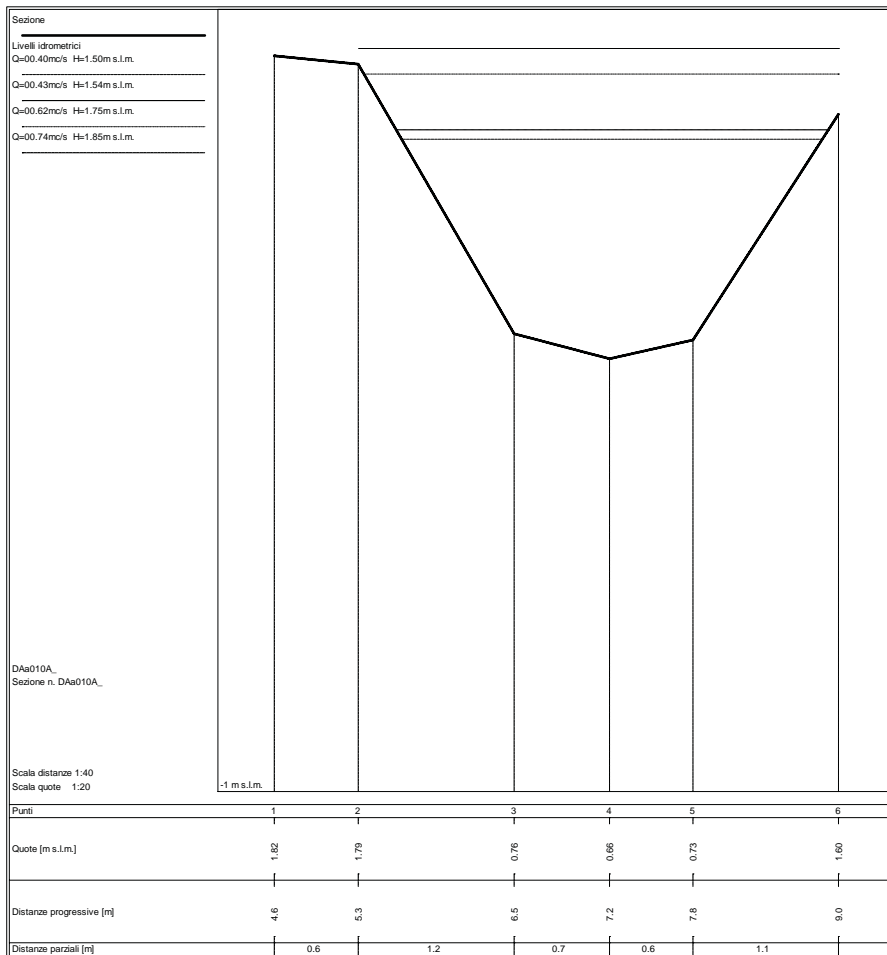
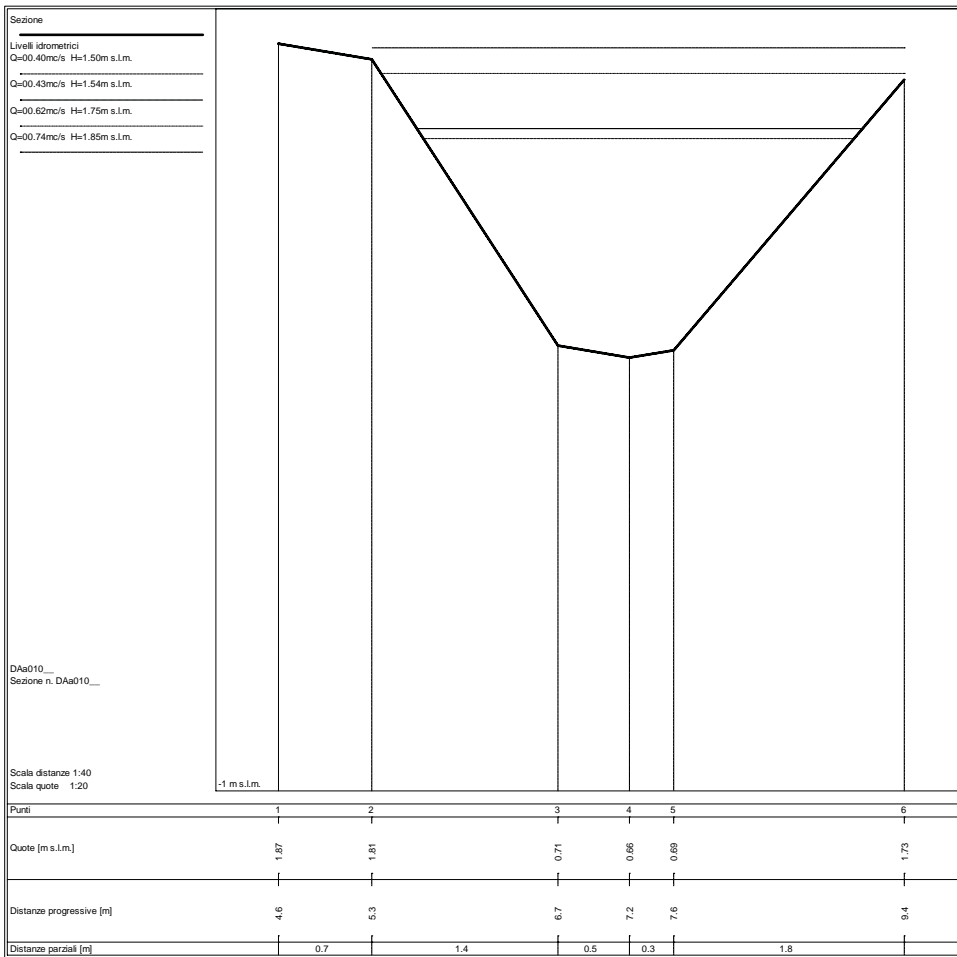

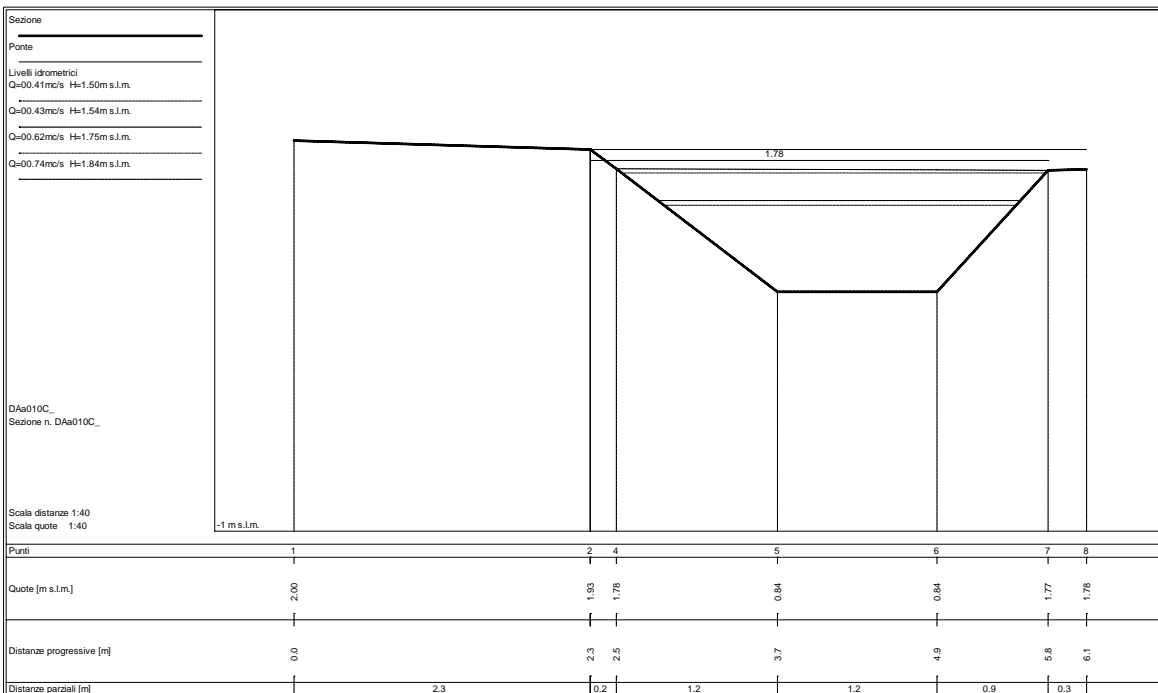
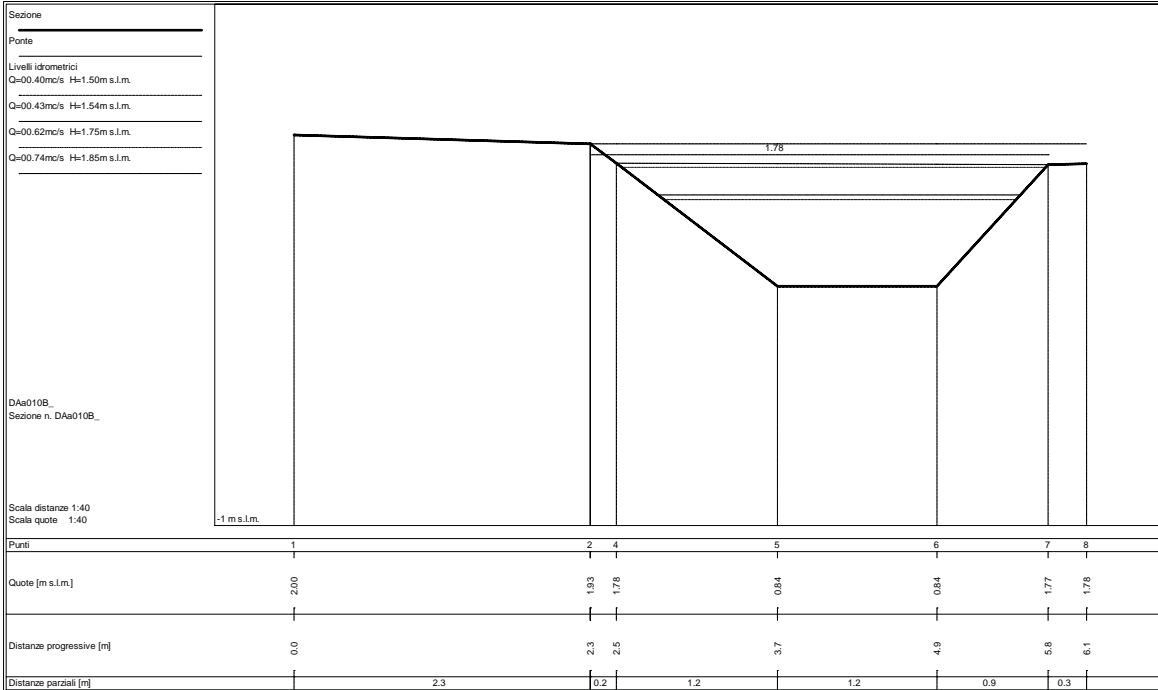

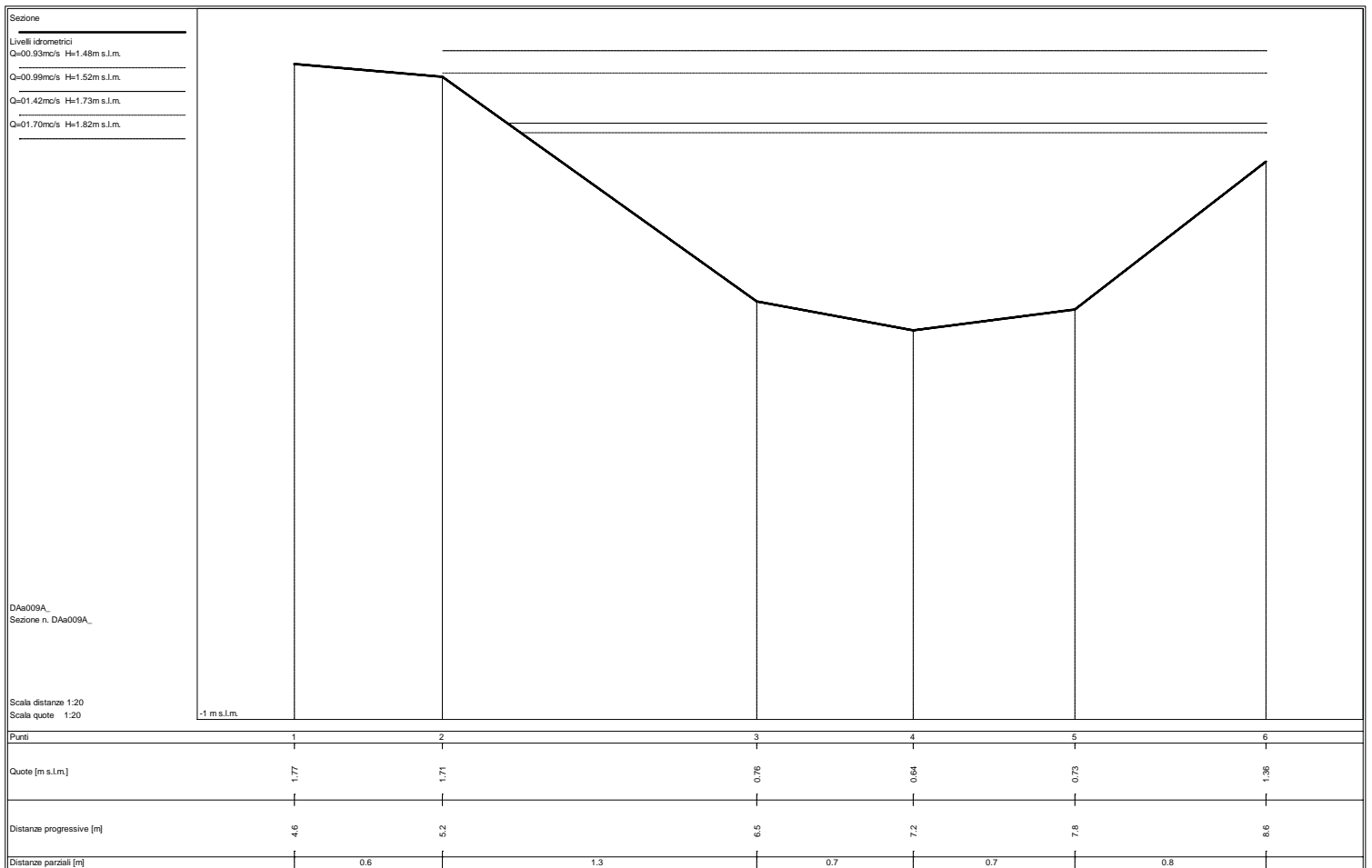
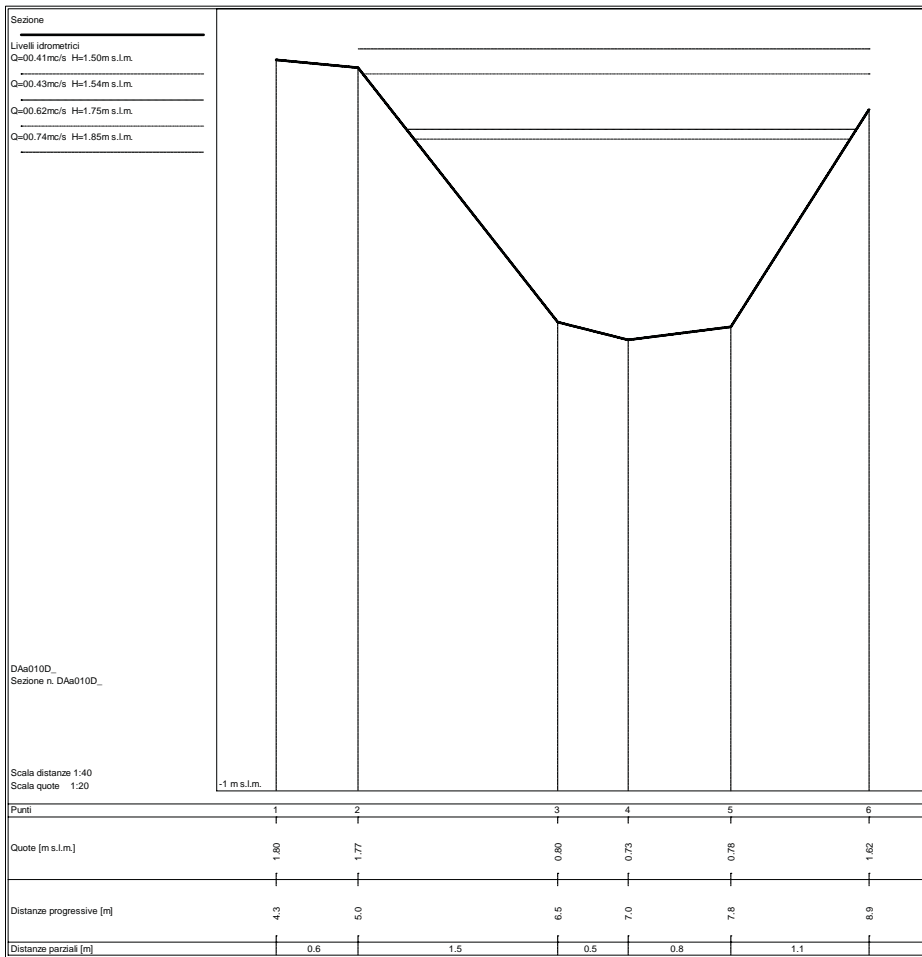

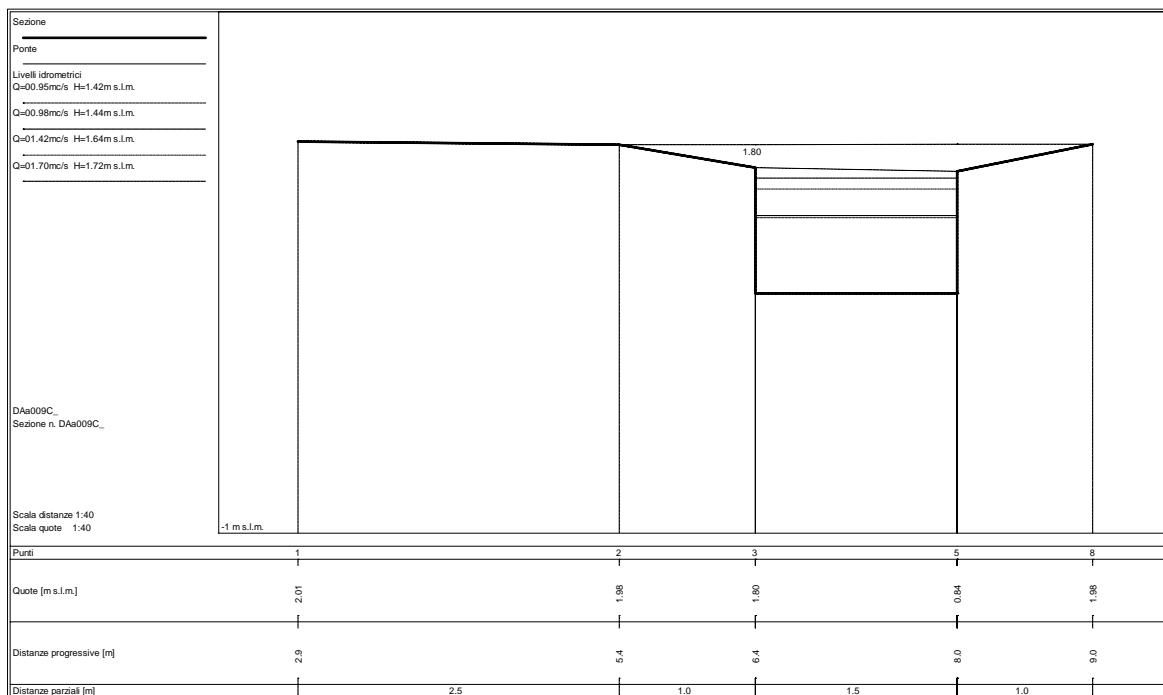
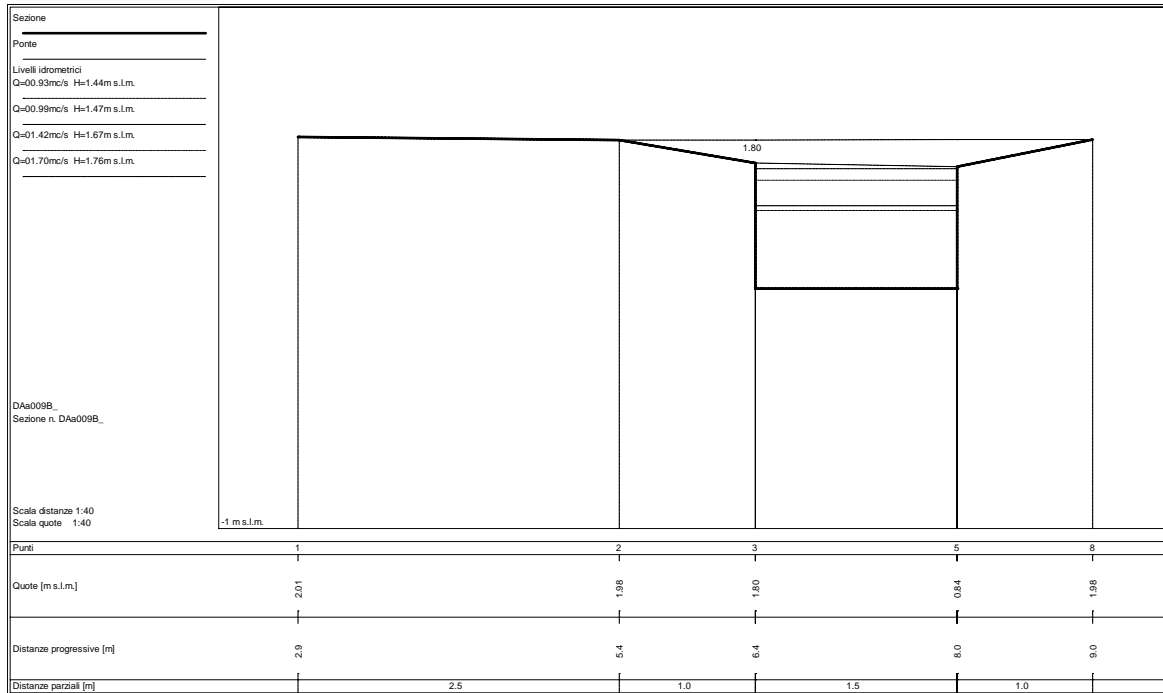

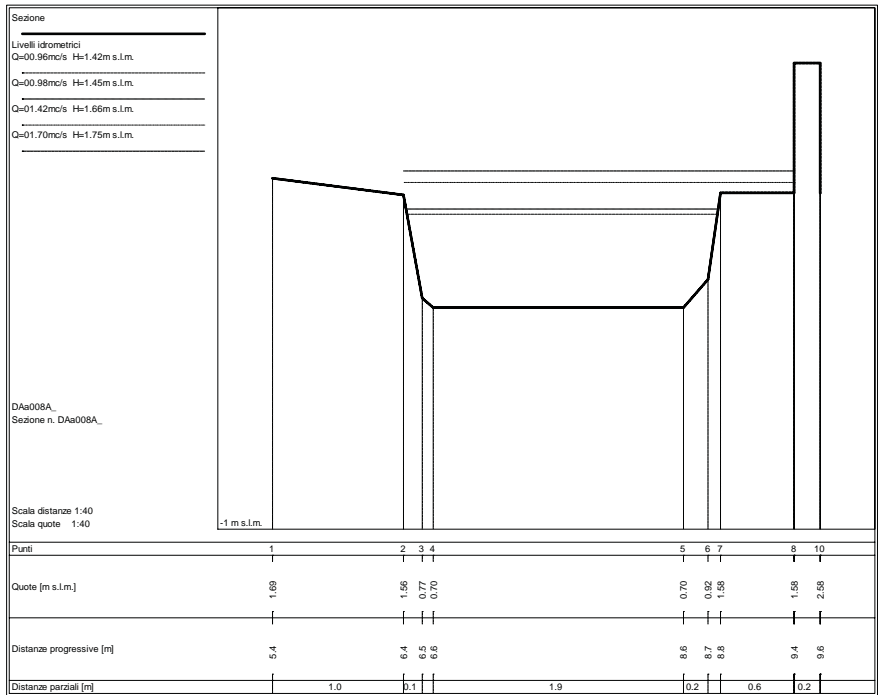
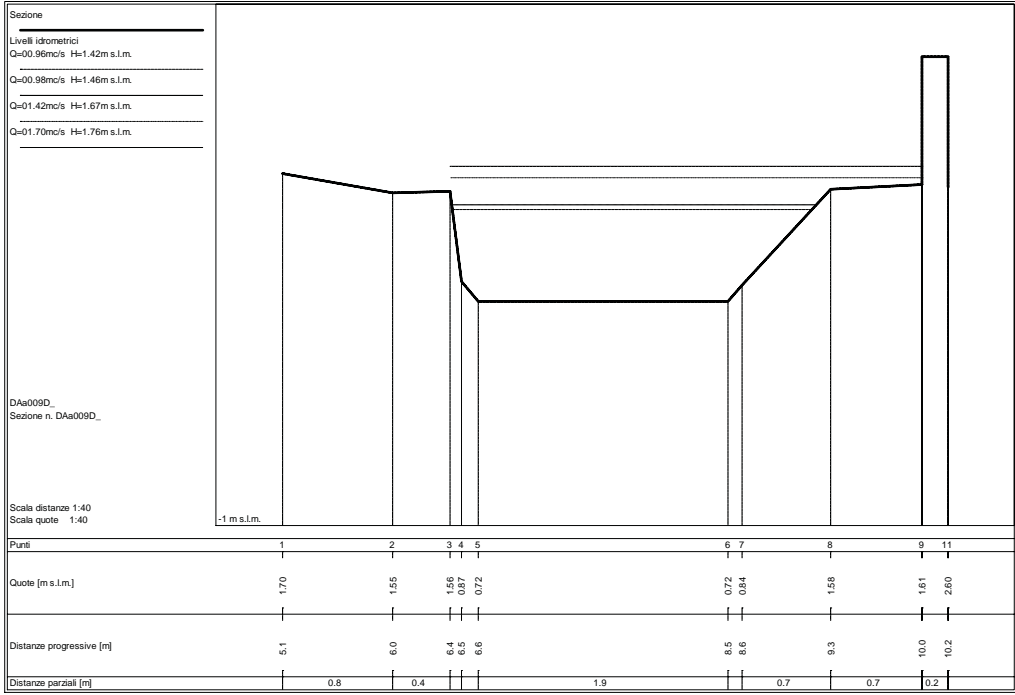

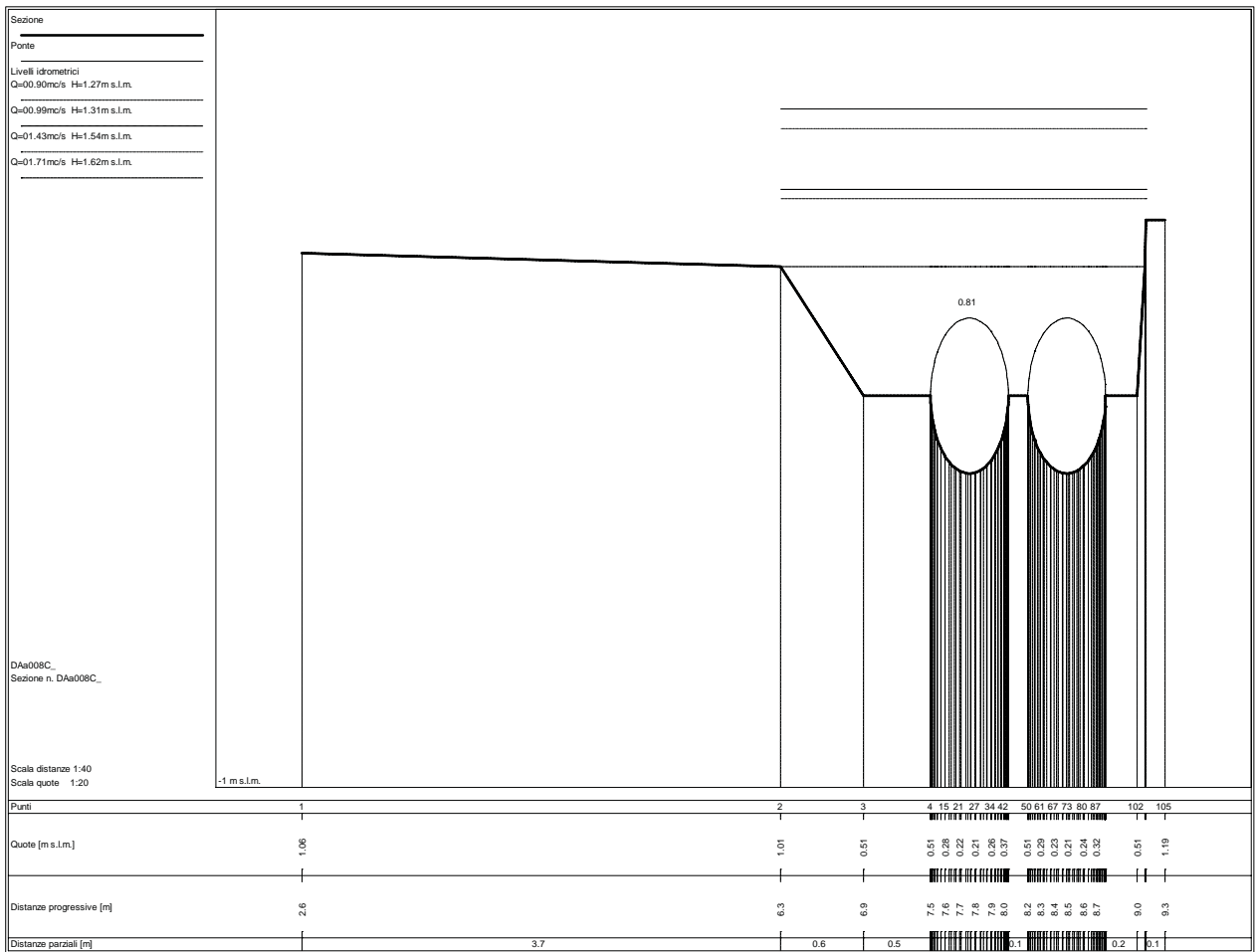
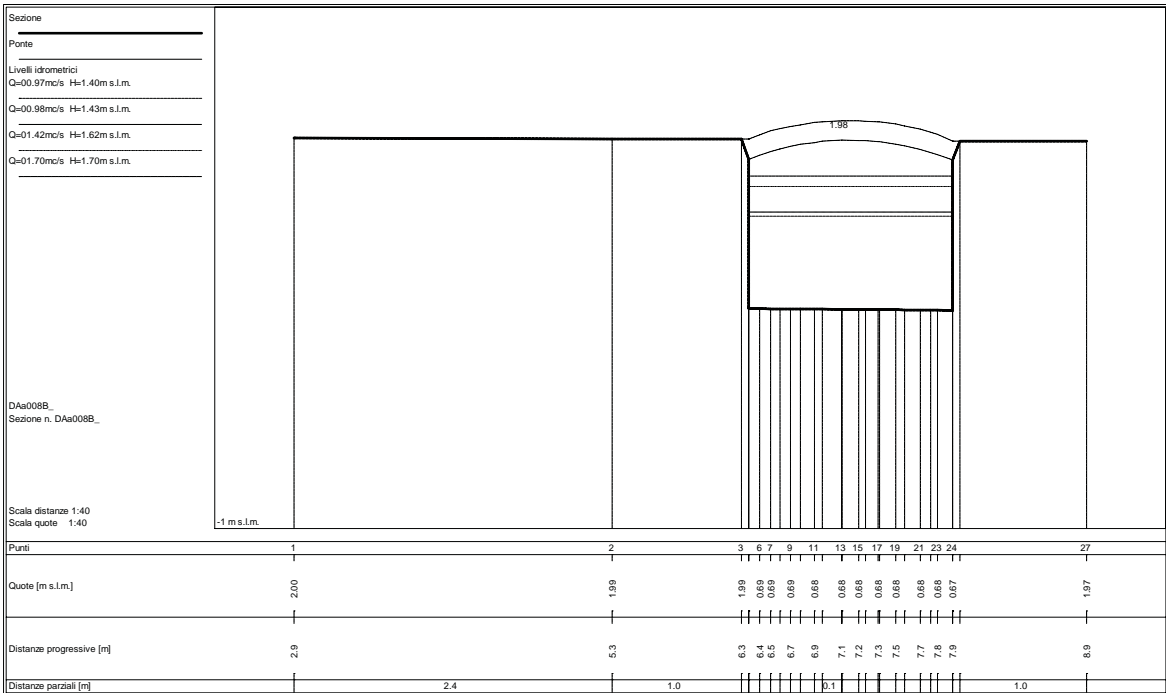

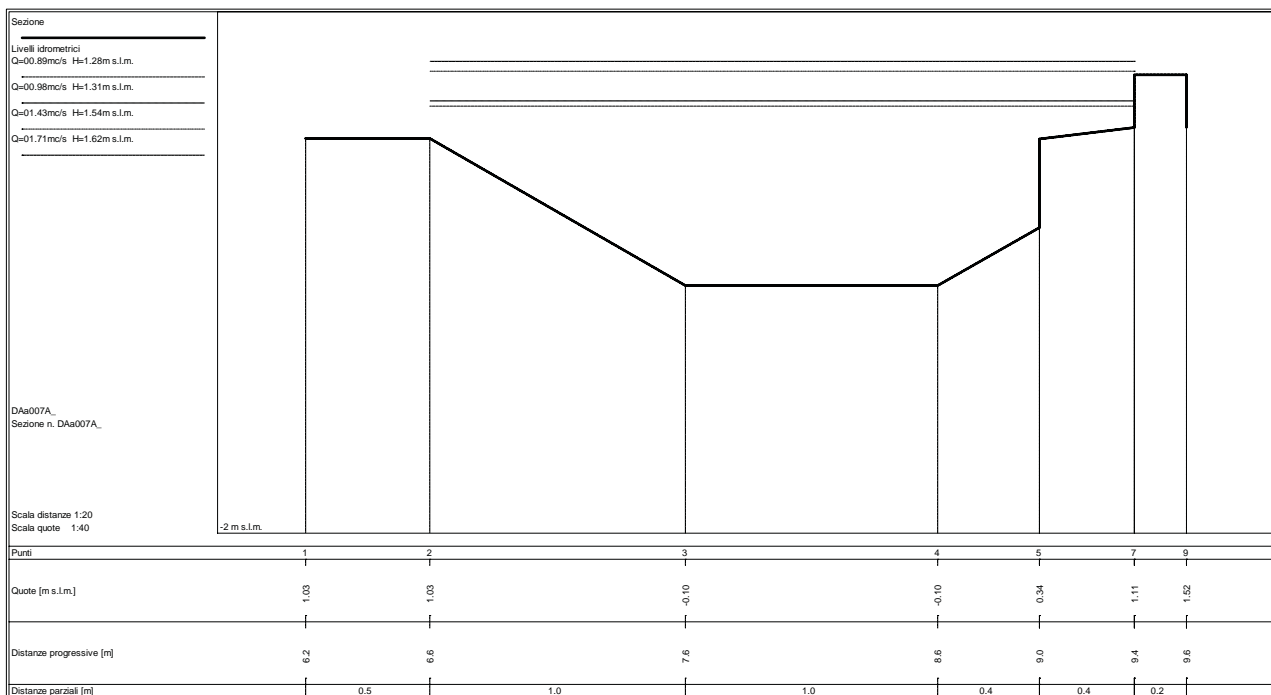
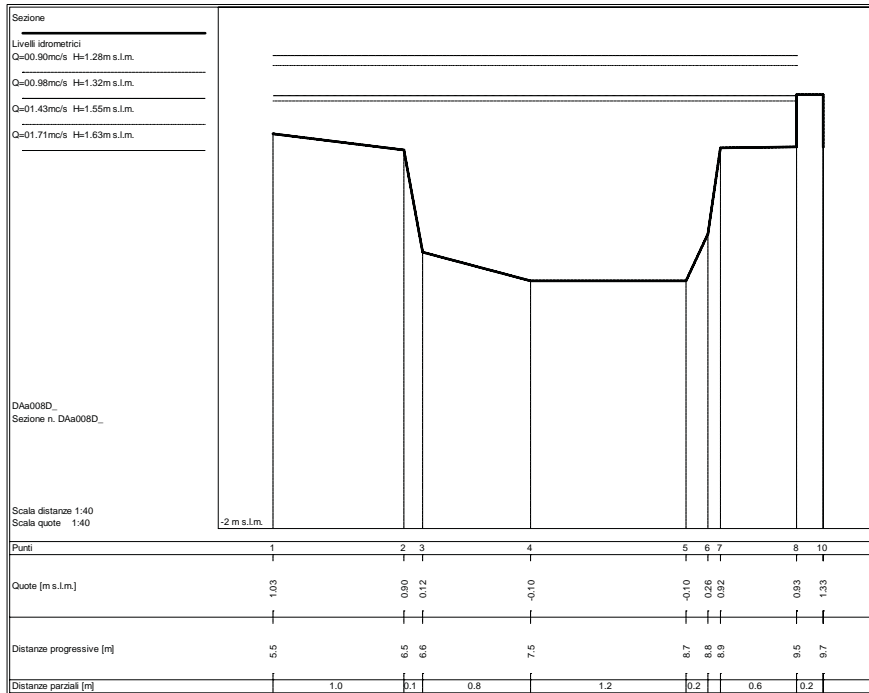

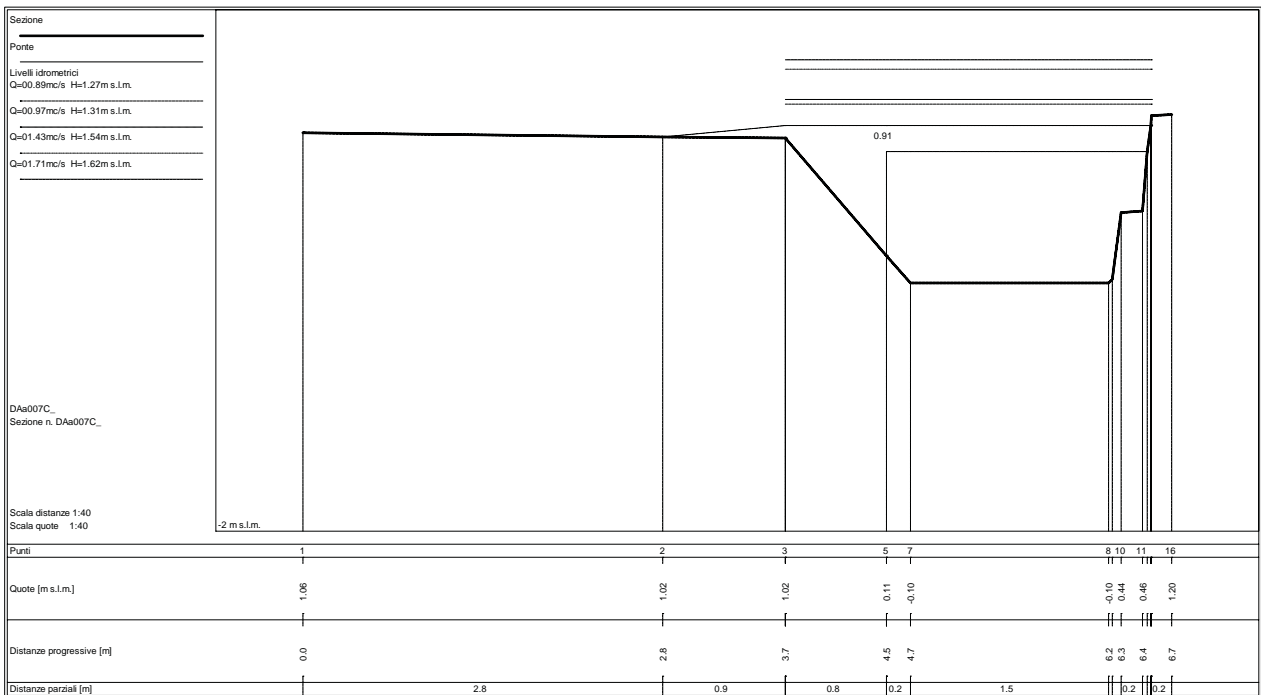
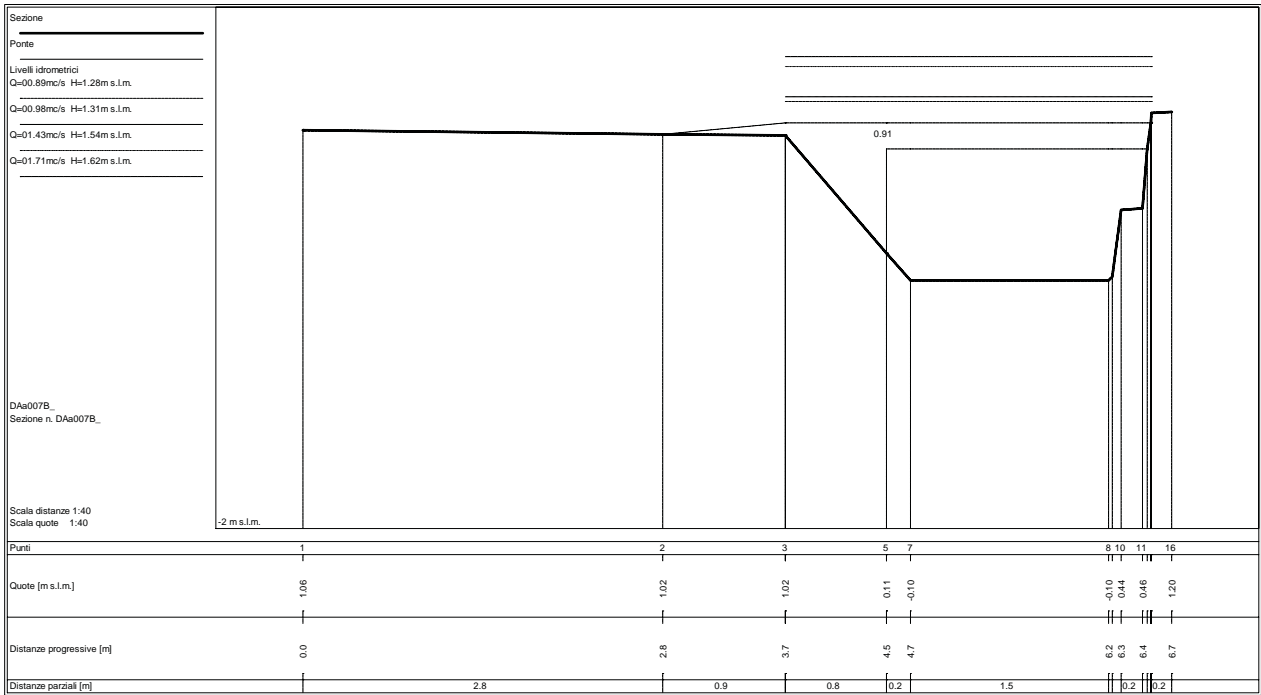

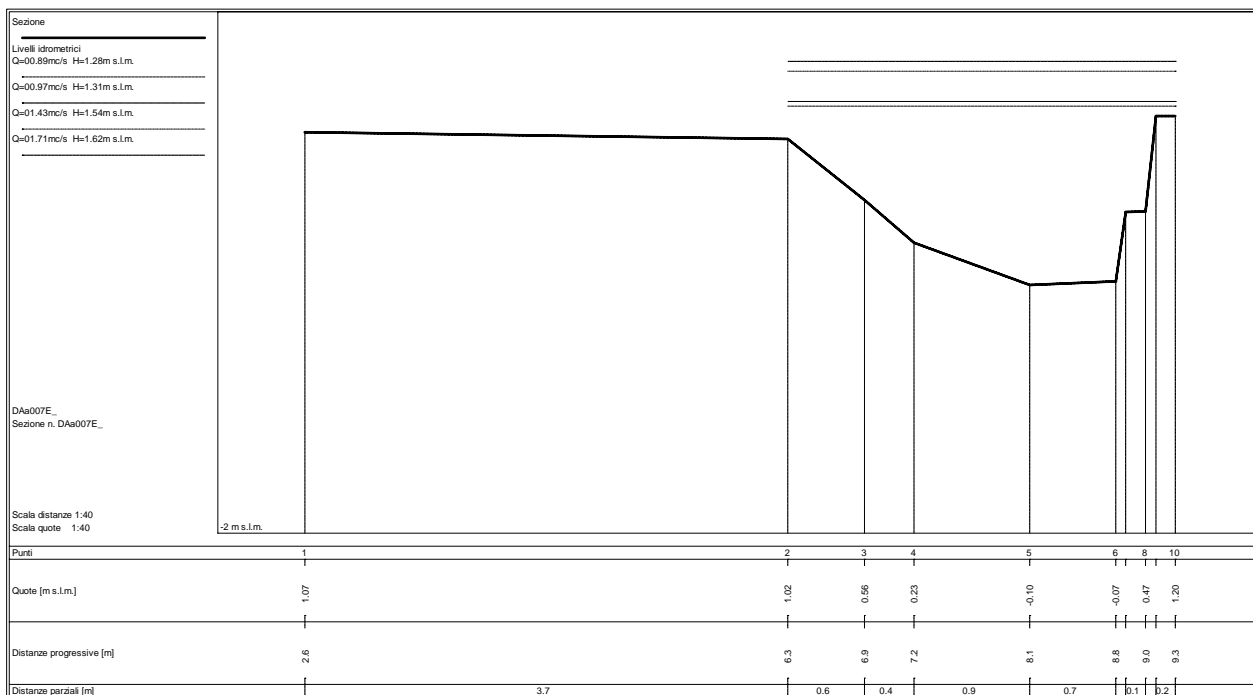
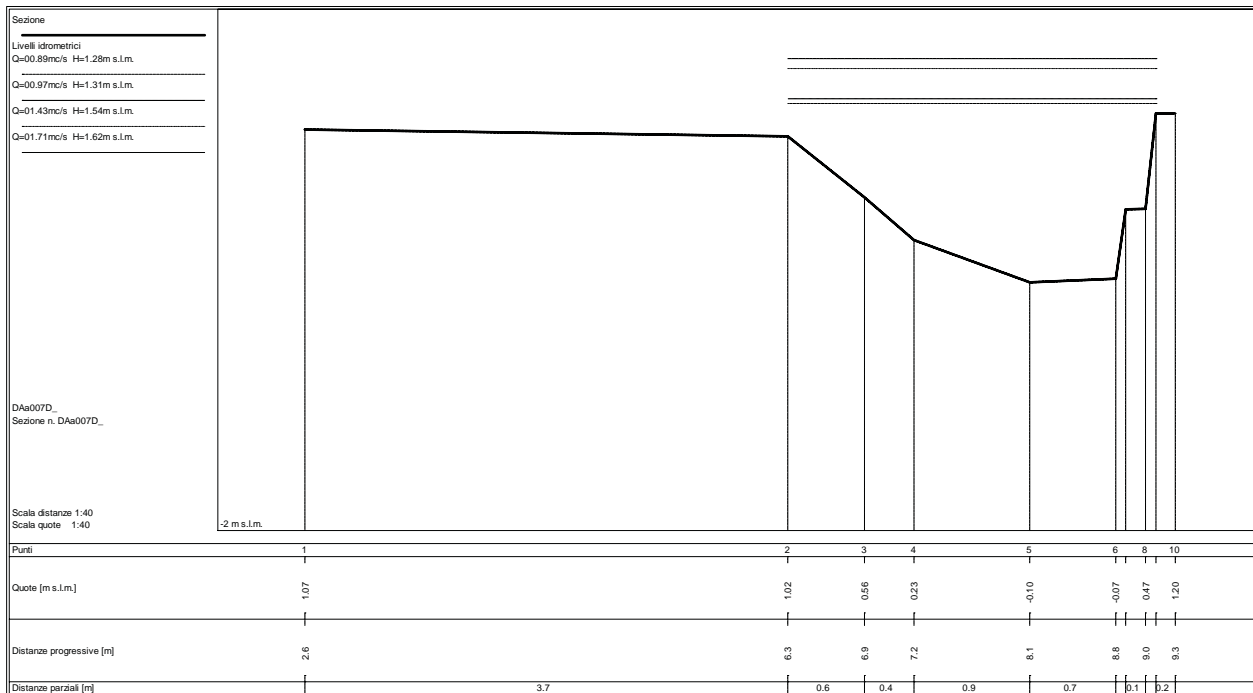

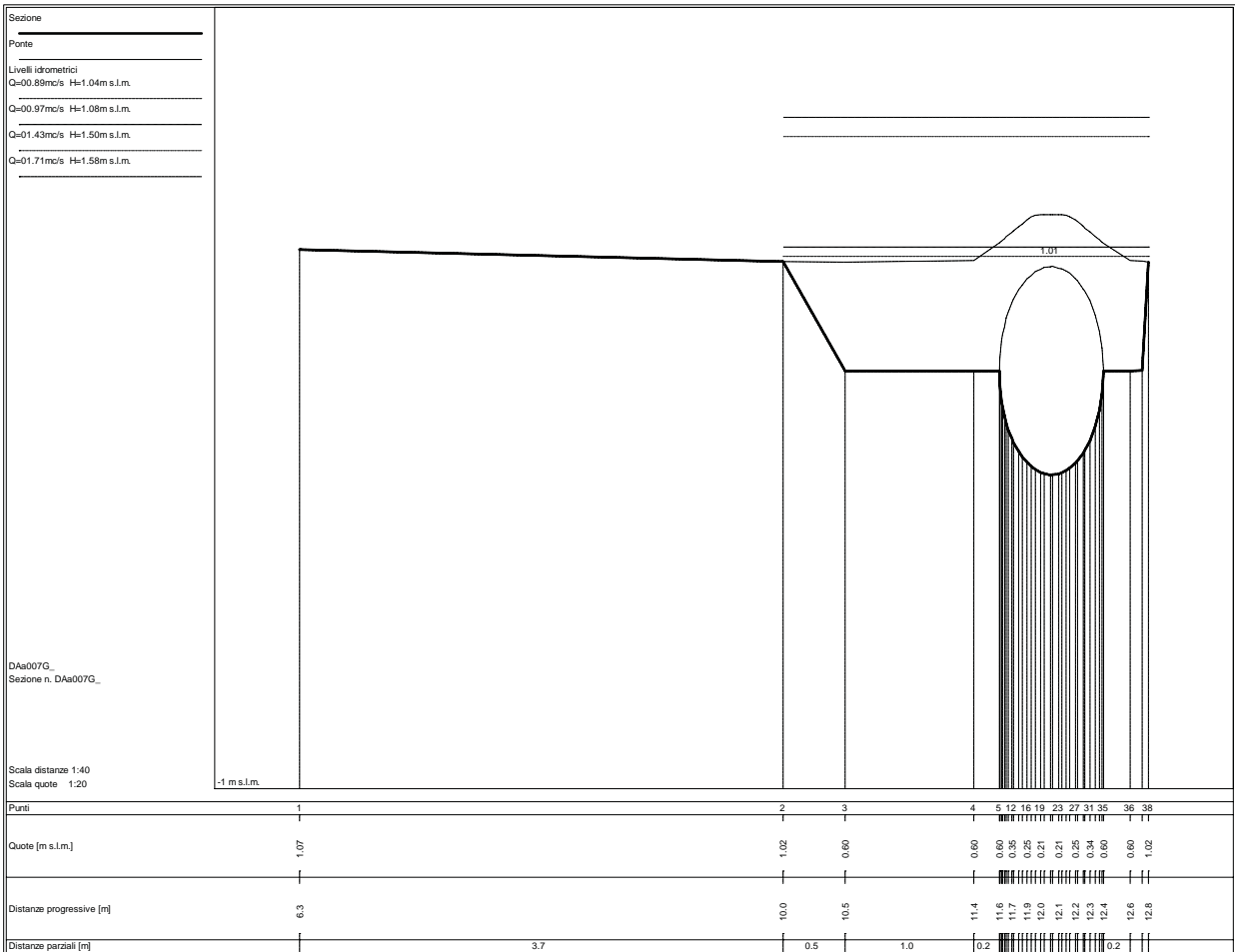
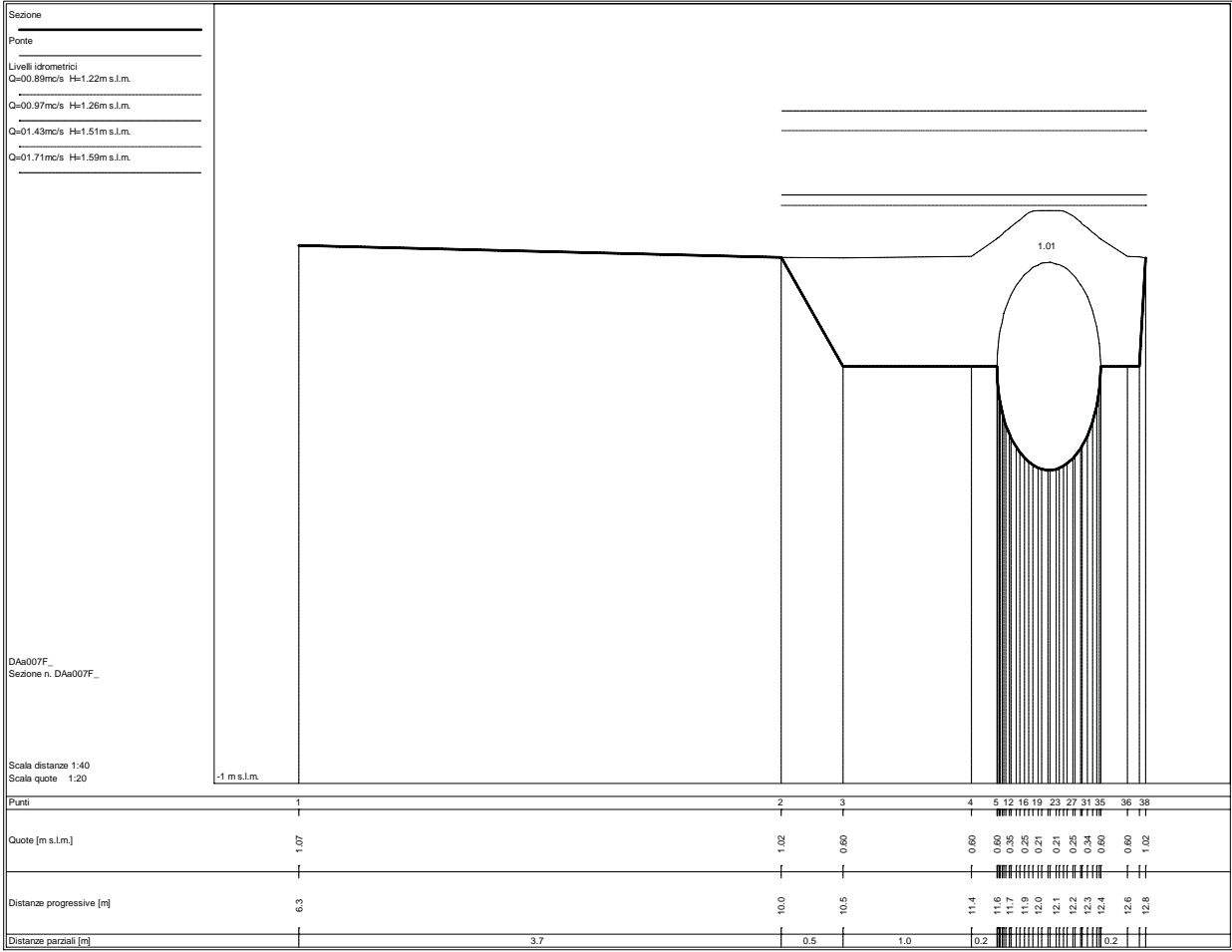

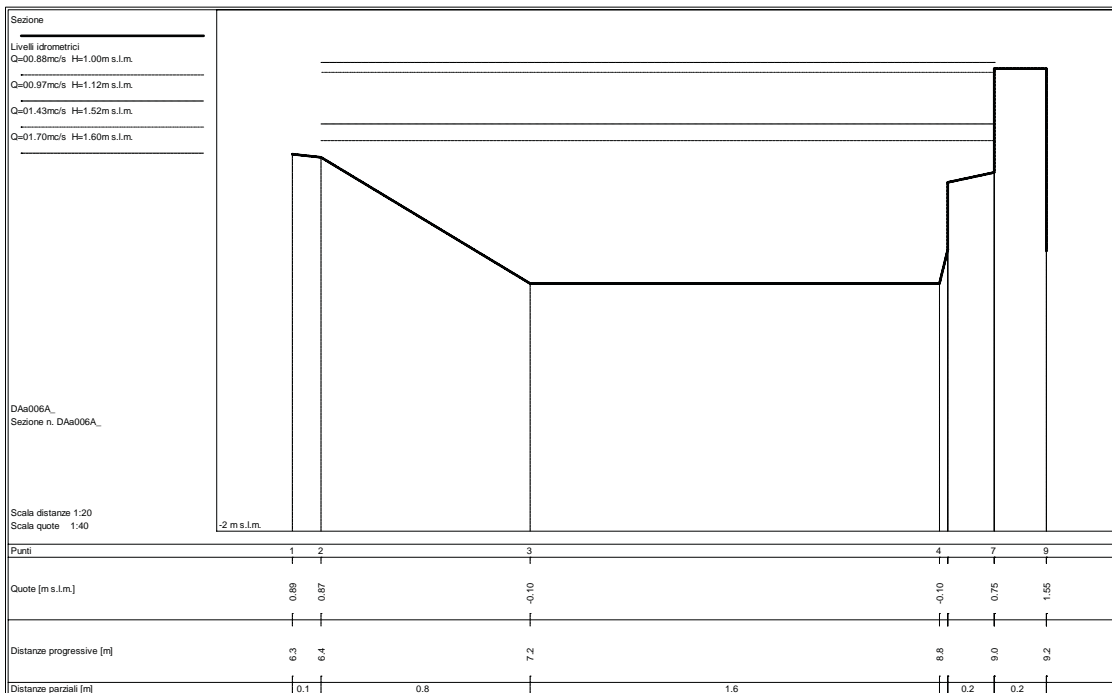
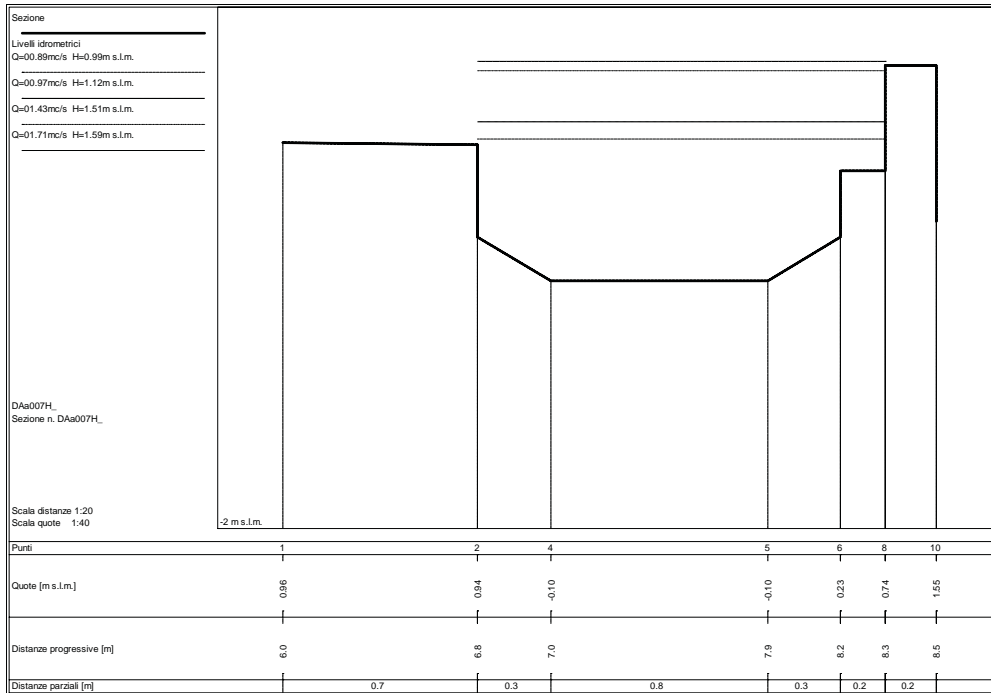

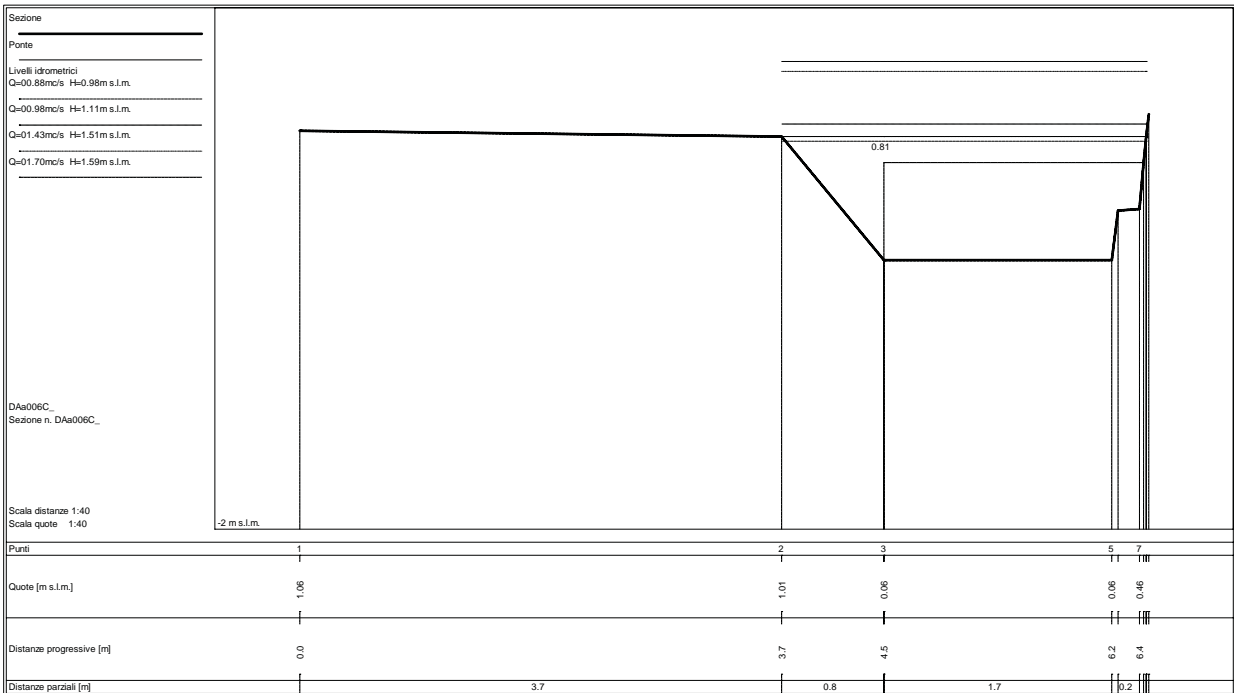
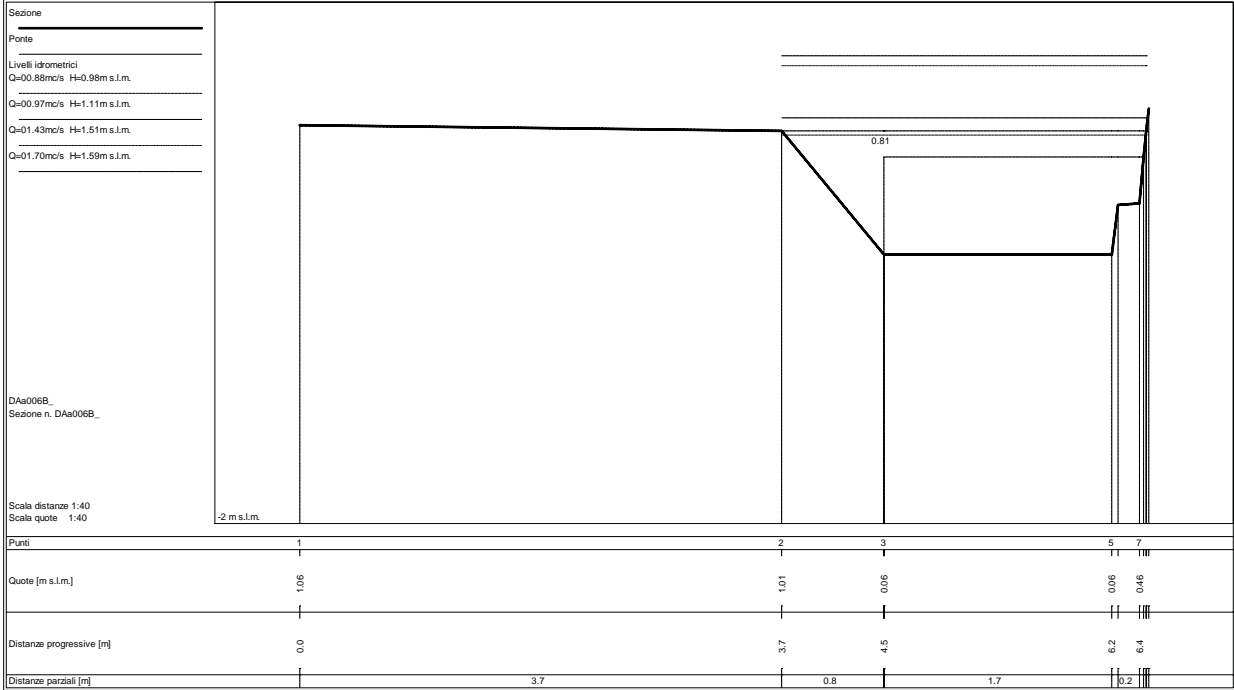

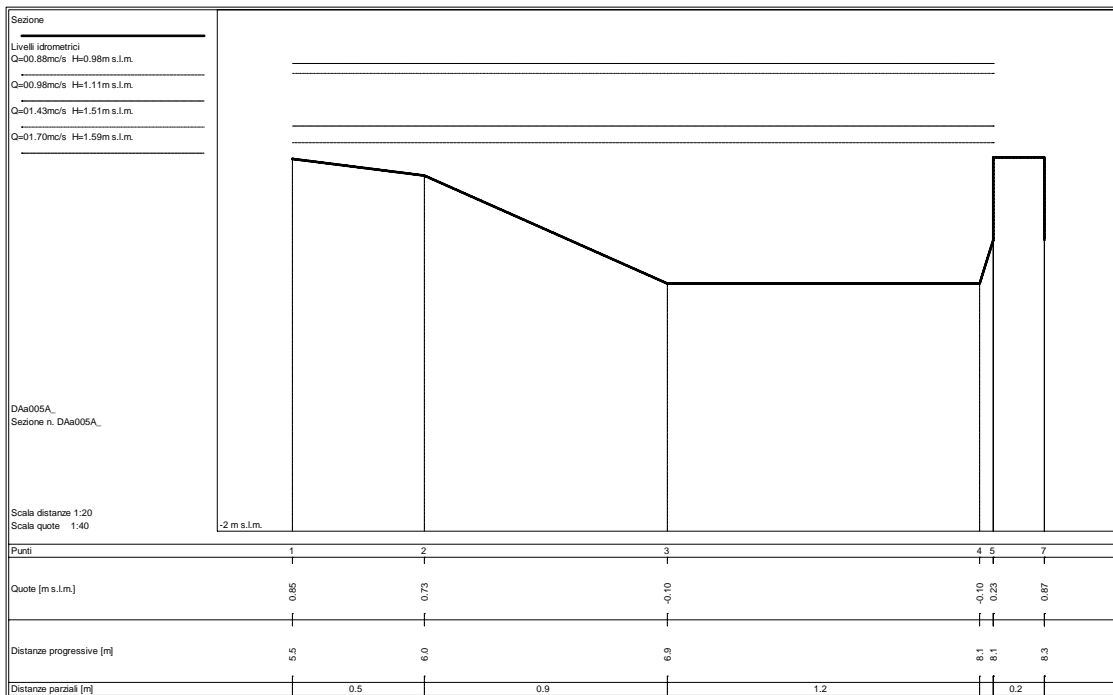
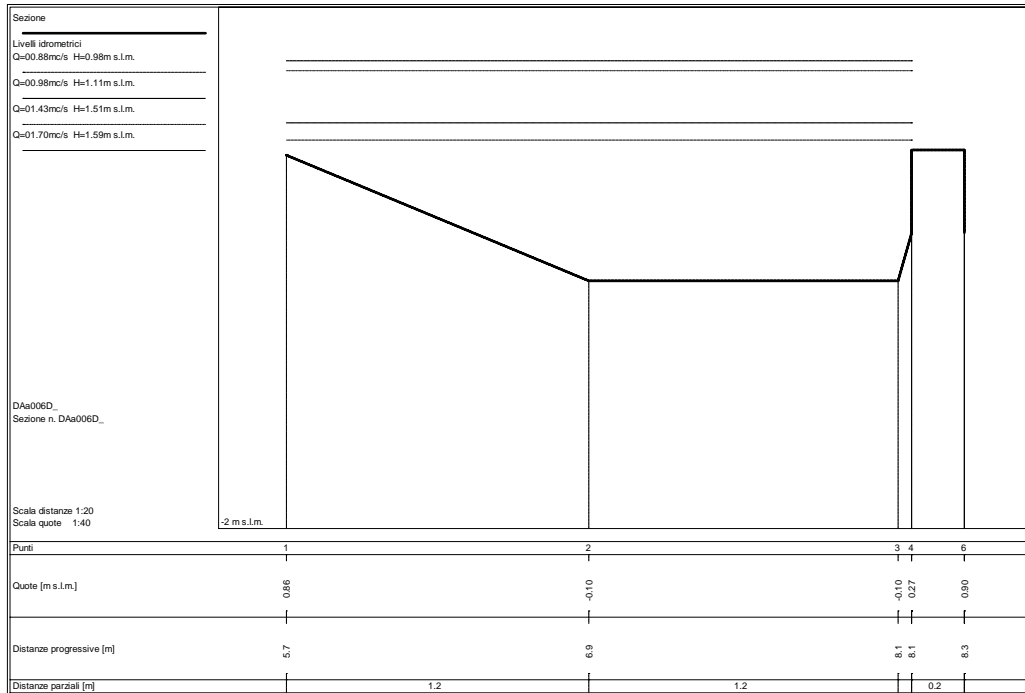

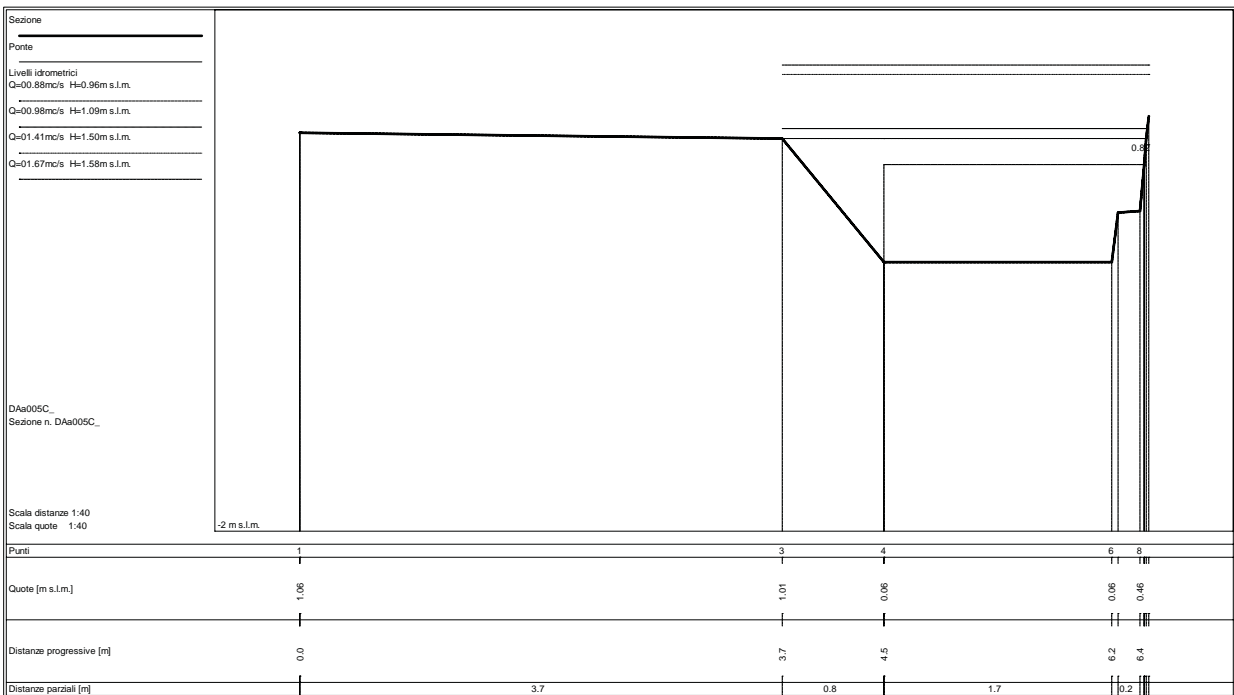
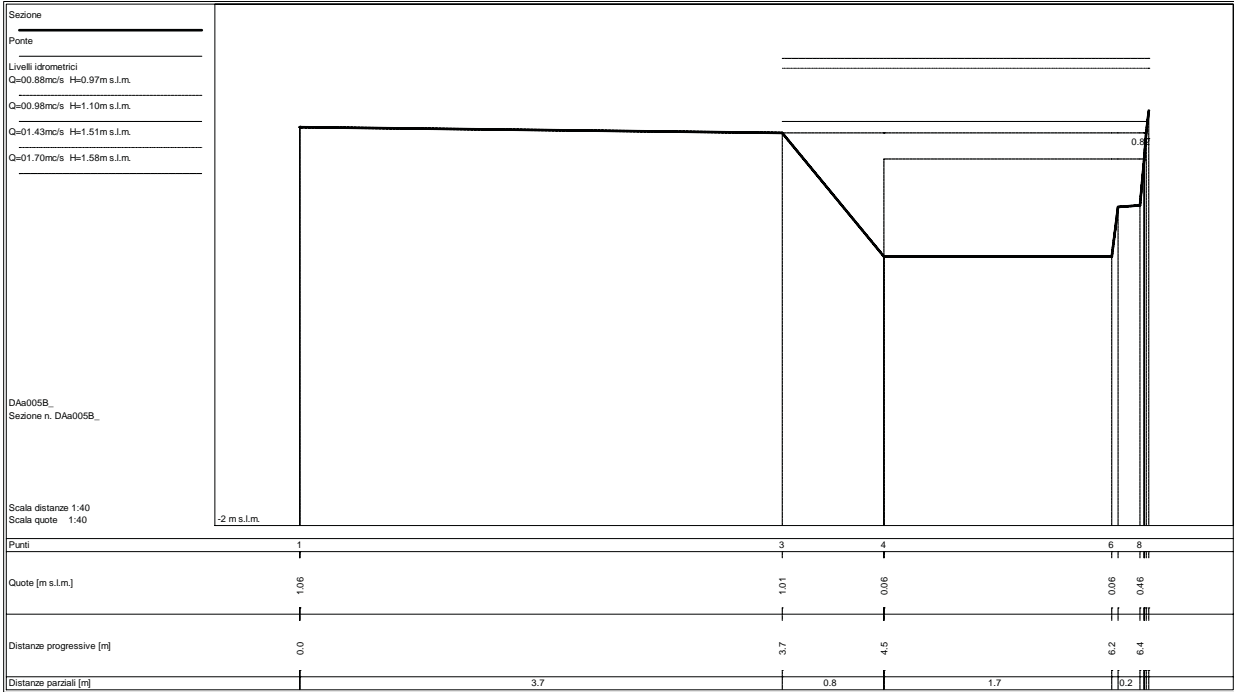

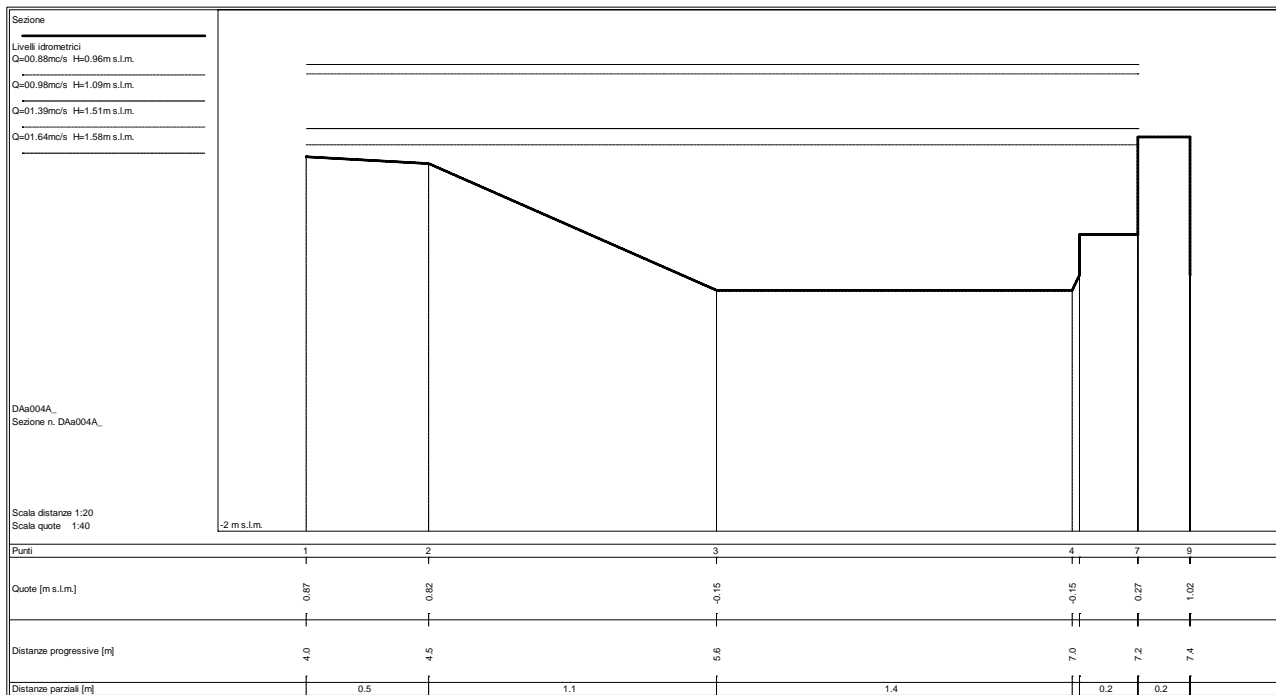
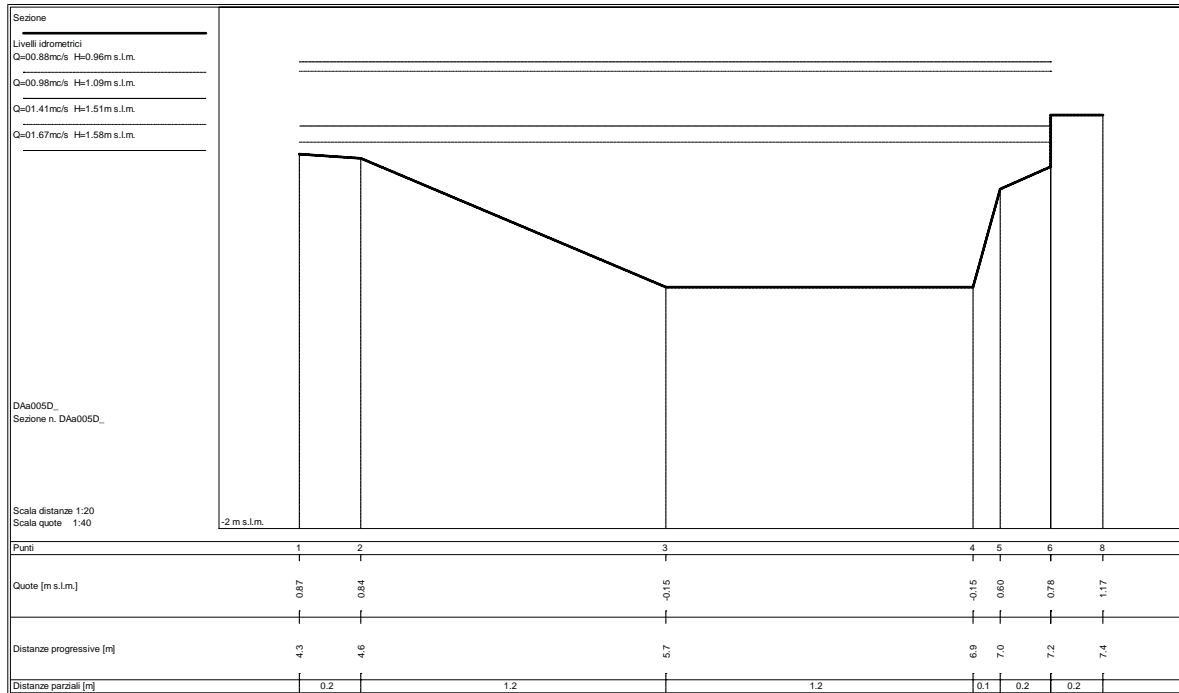

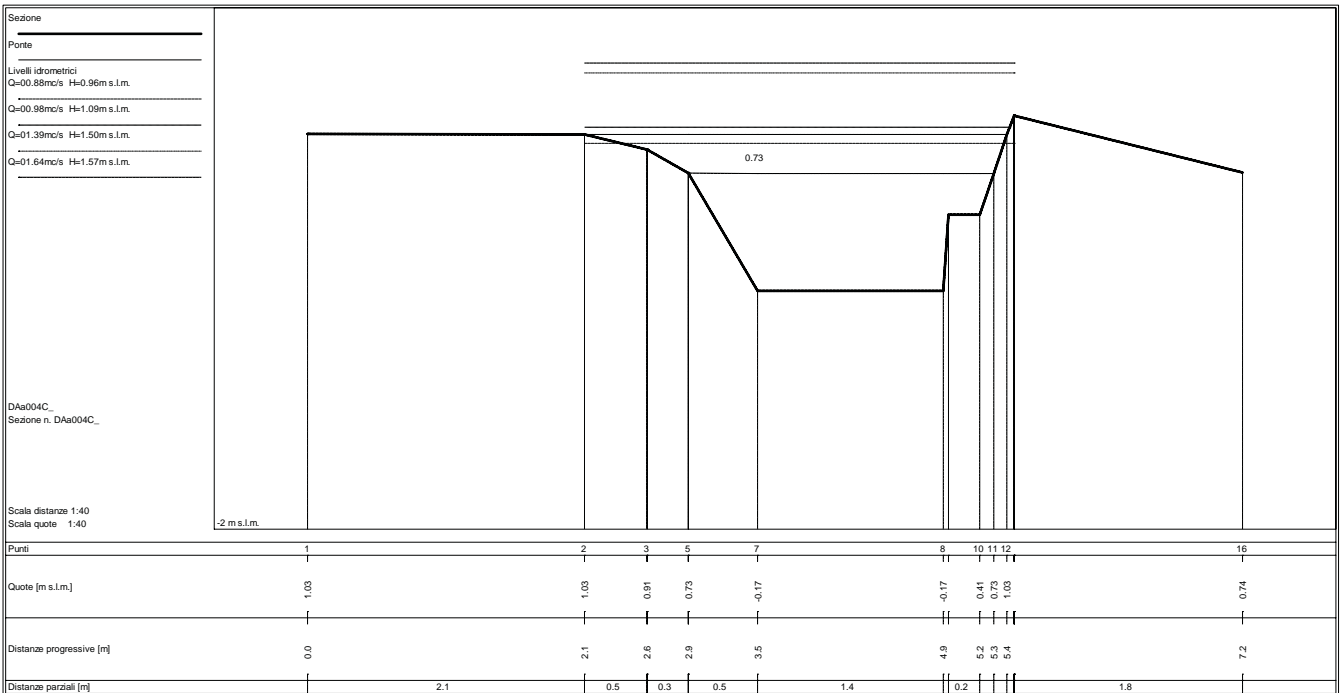
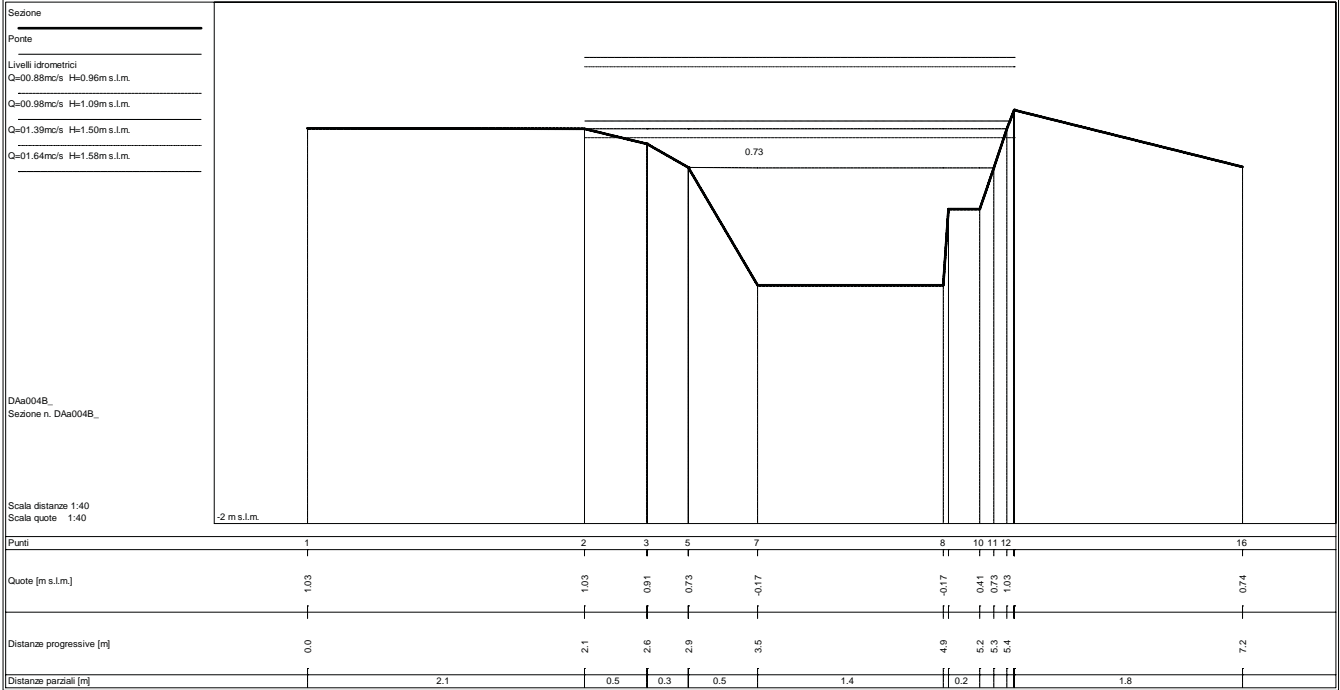

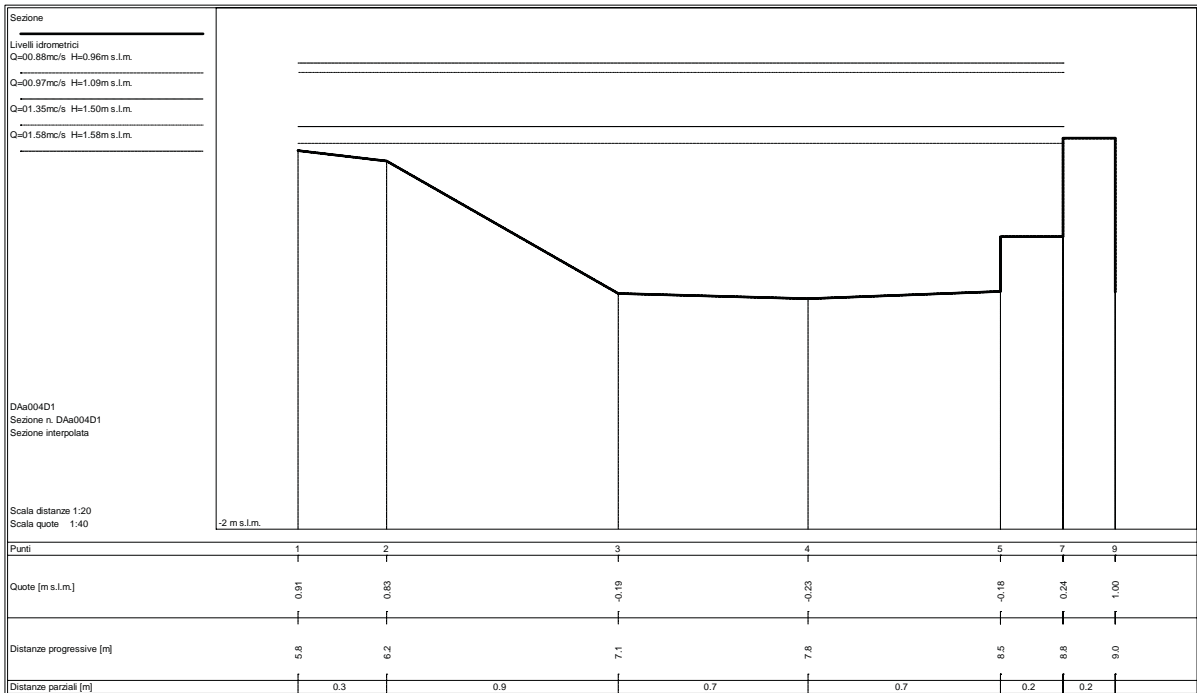
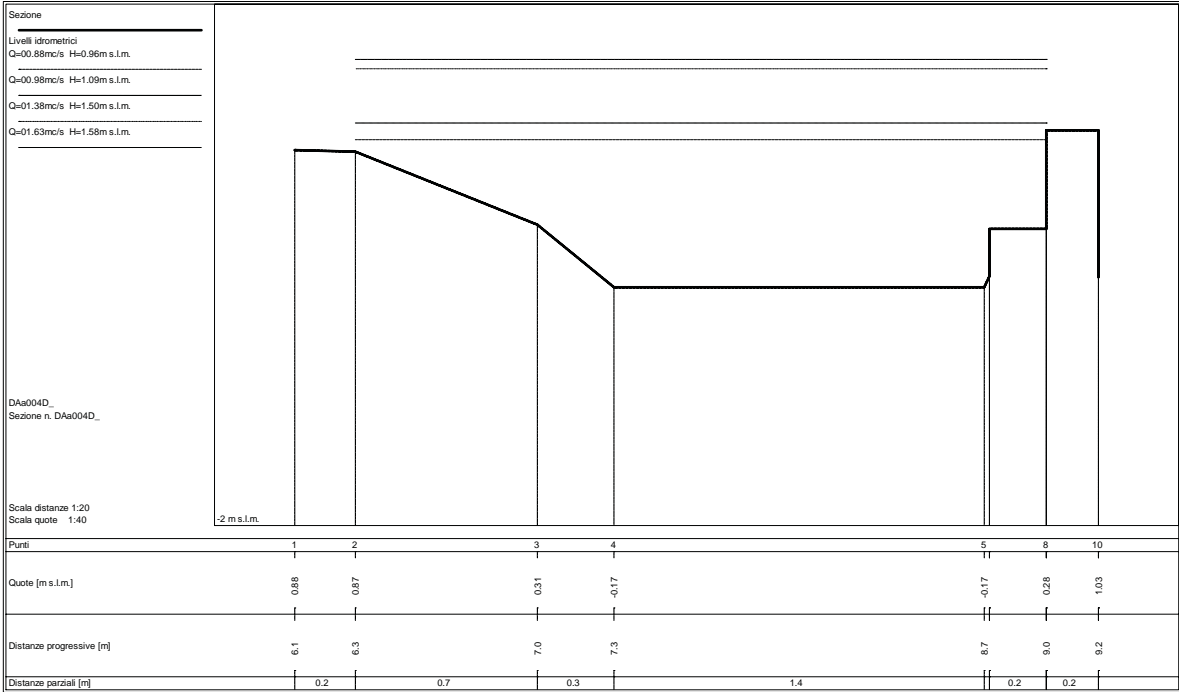

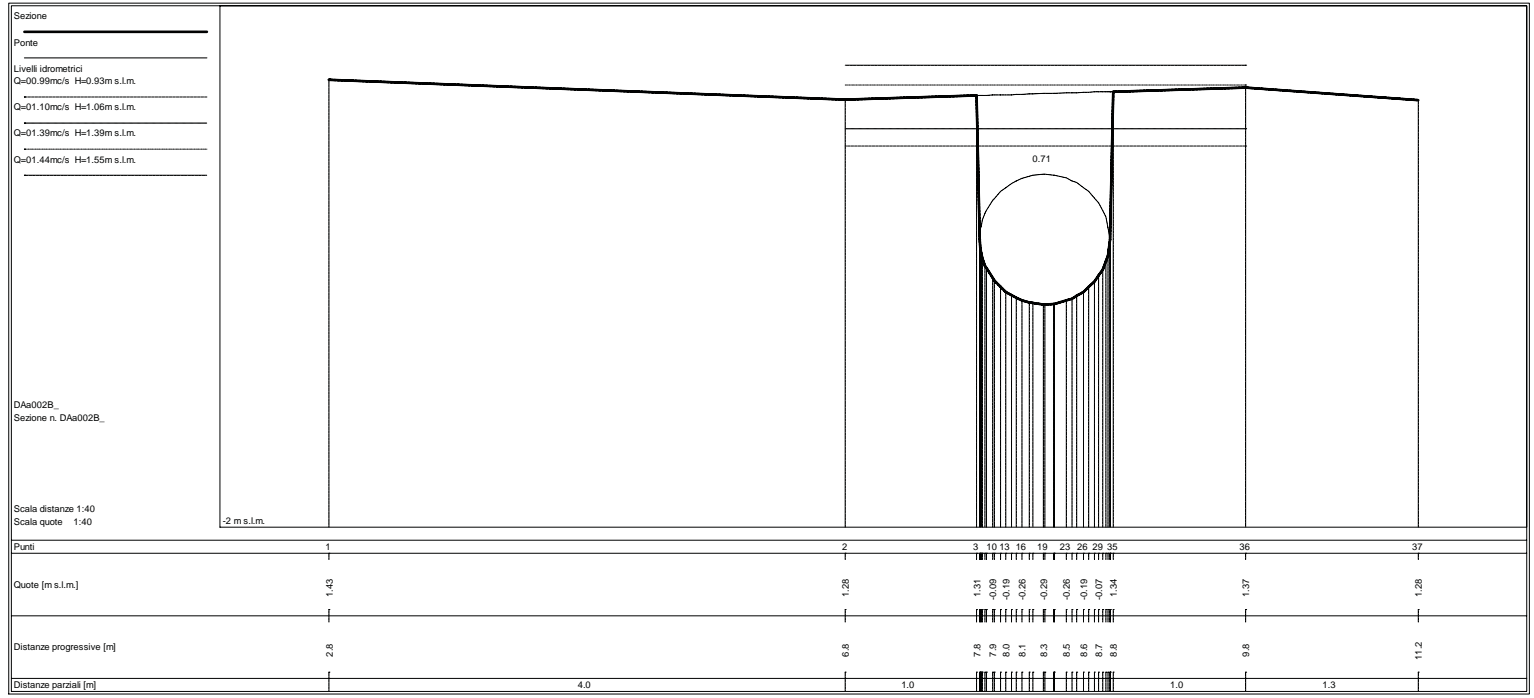
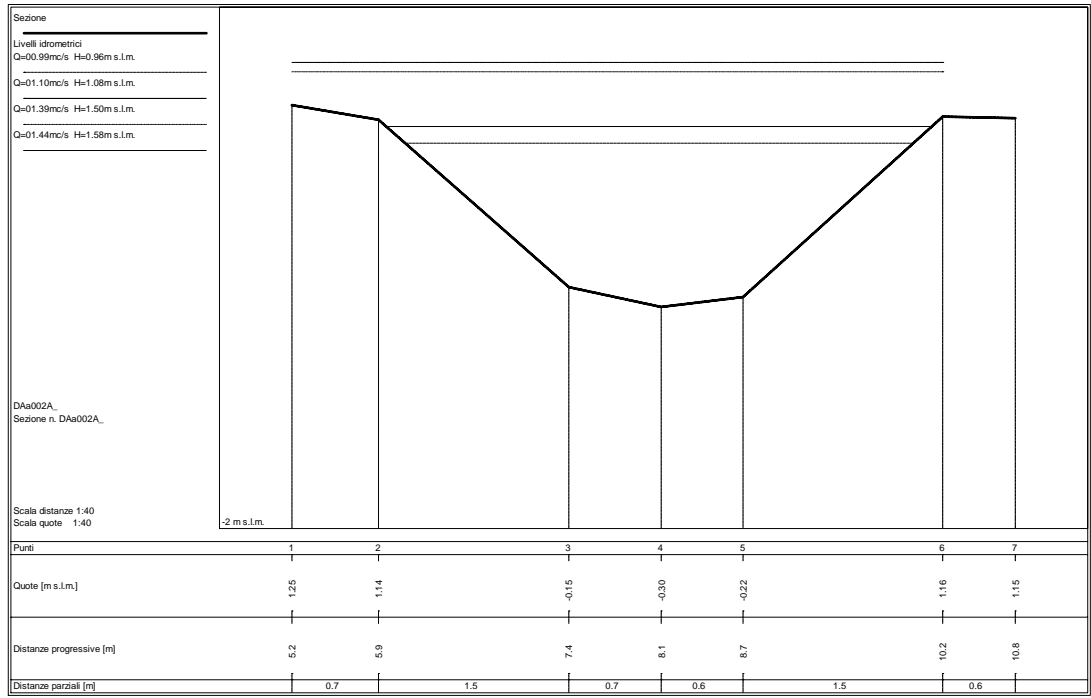

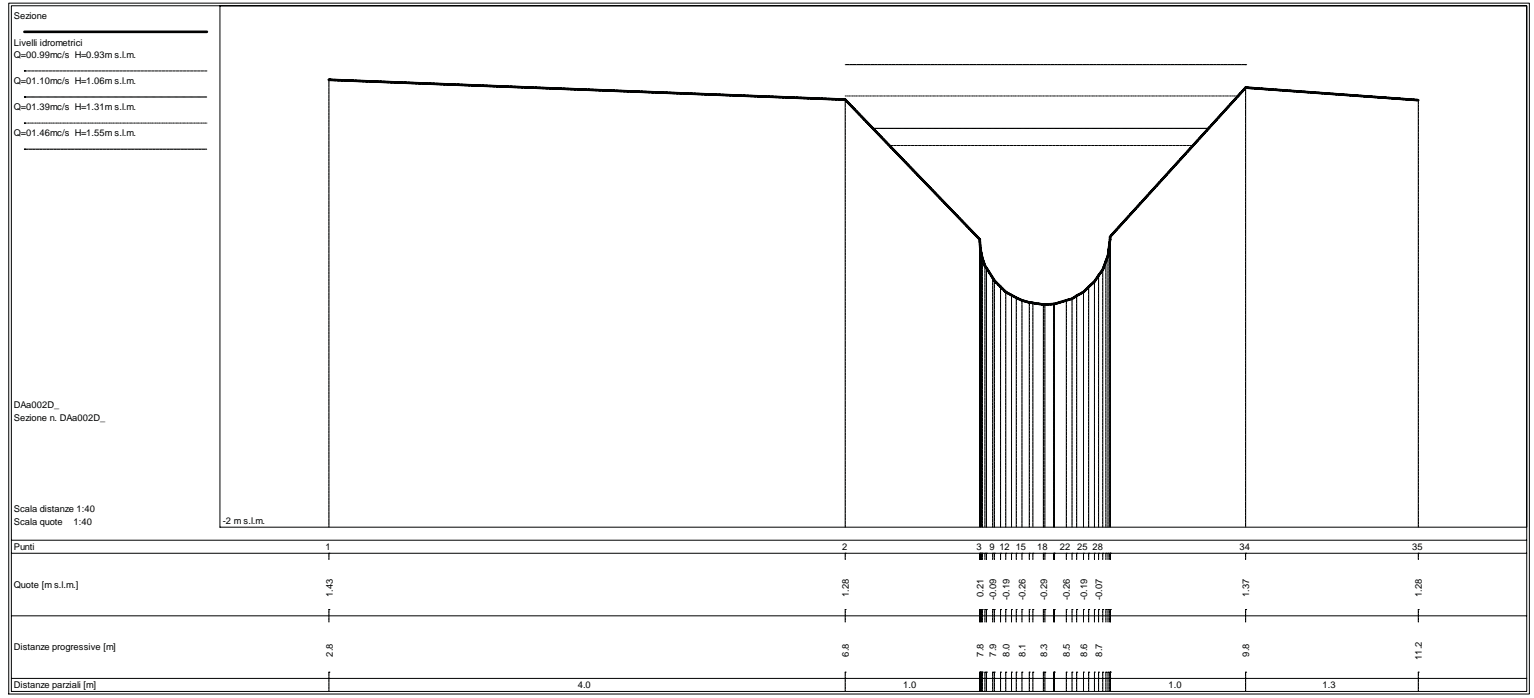
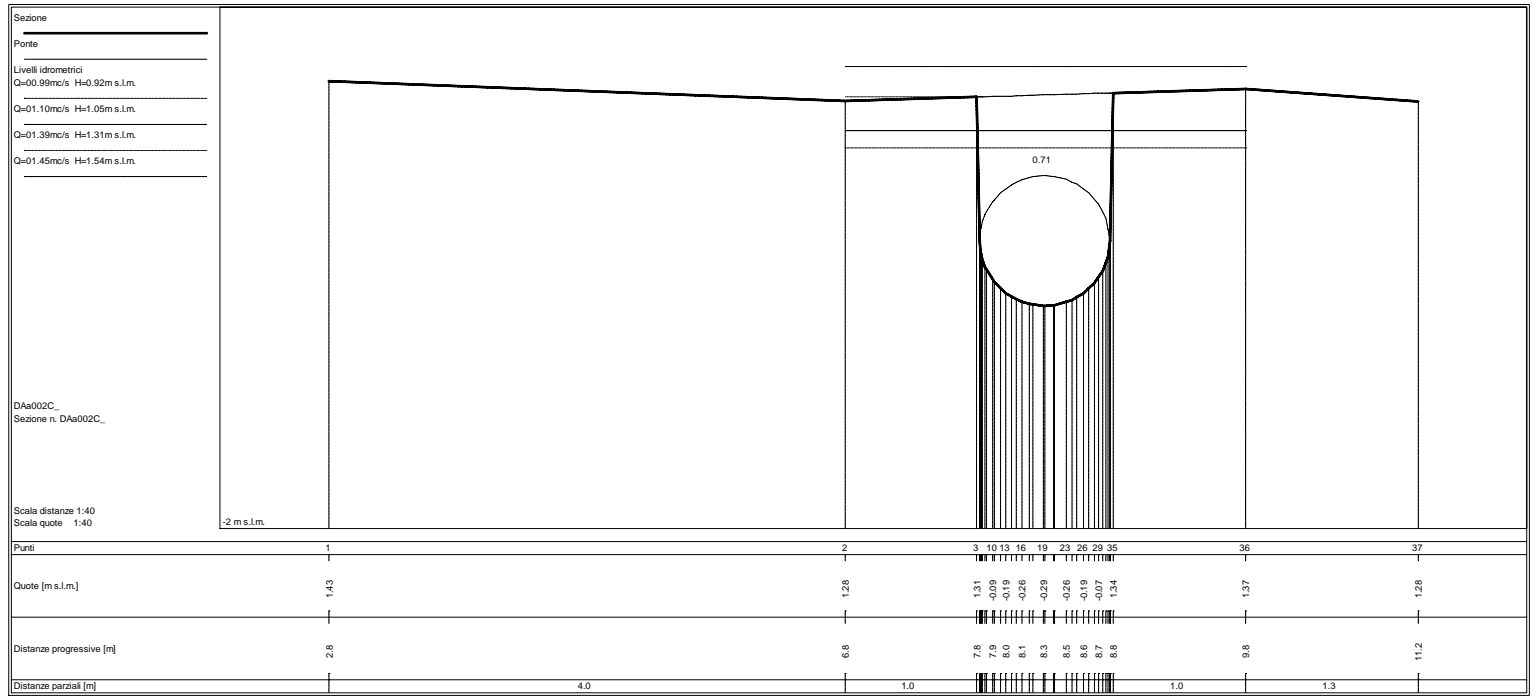

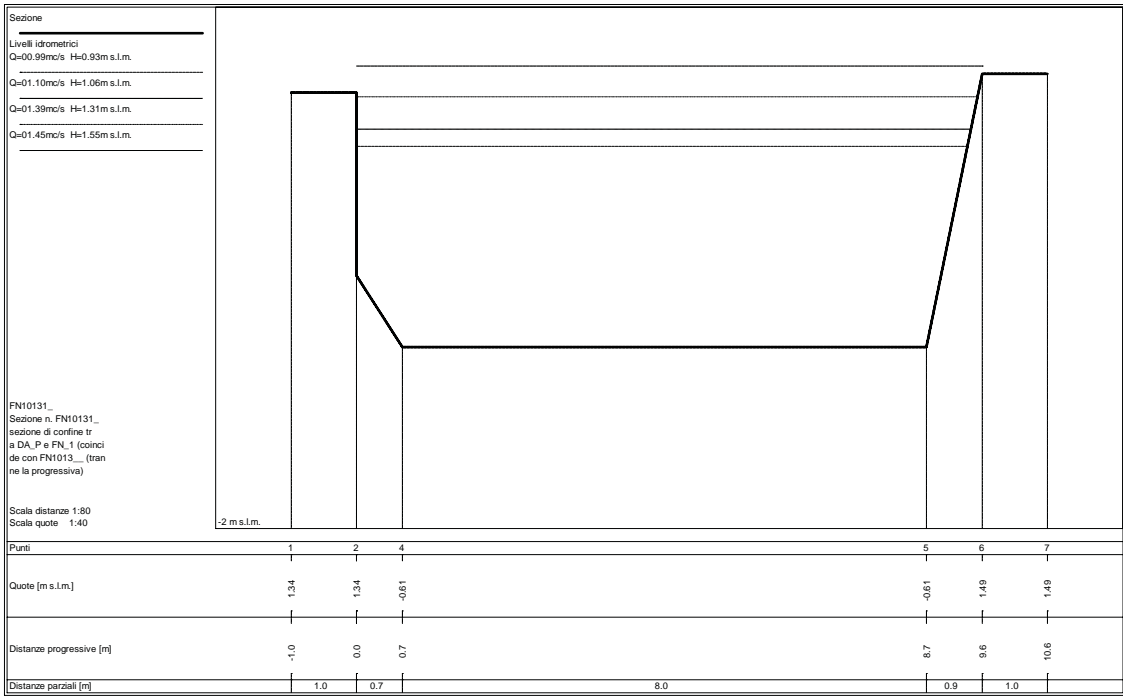

STATO ATTUALE

Sezioni fluviali fosso Nuovo – FN_1_a

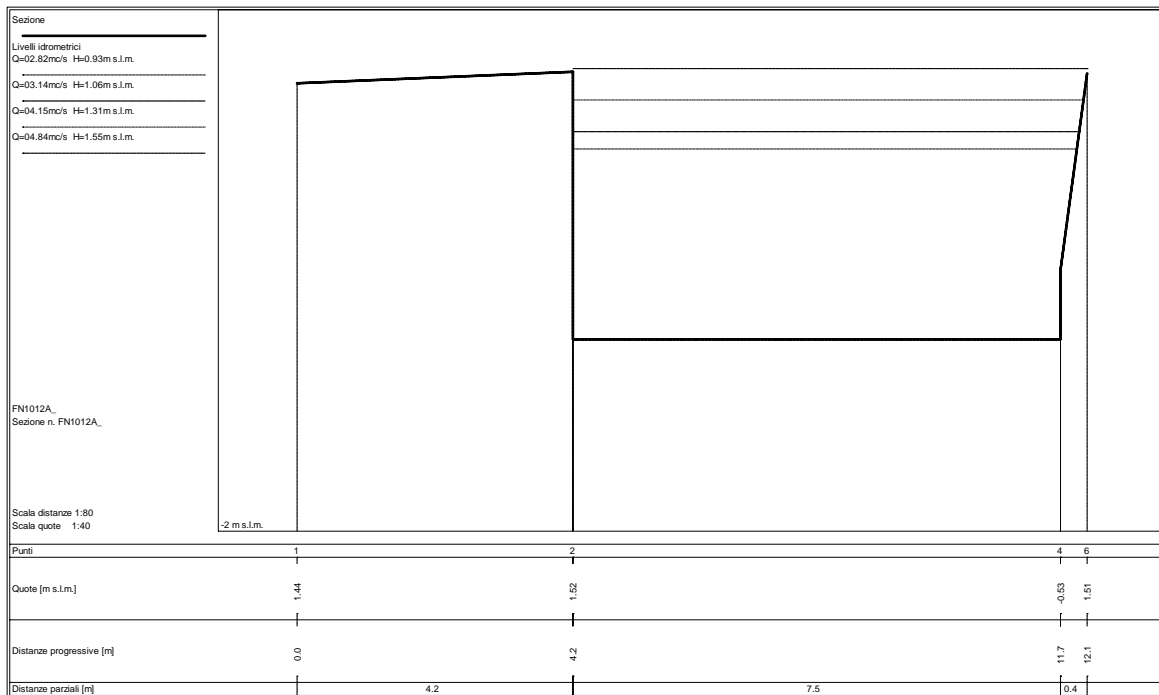
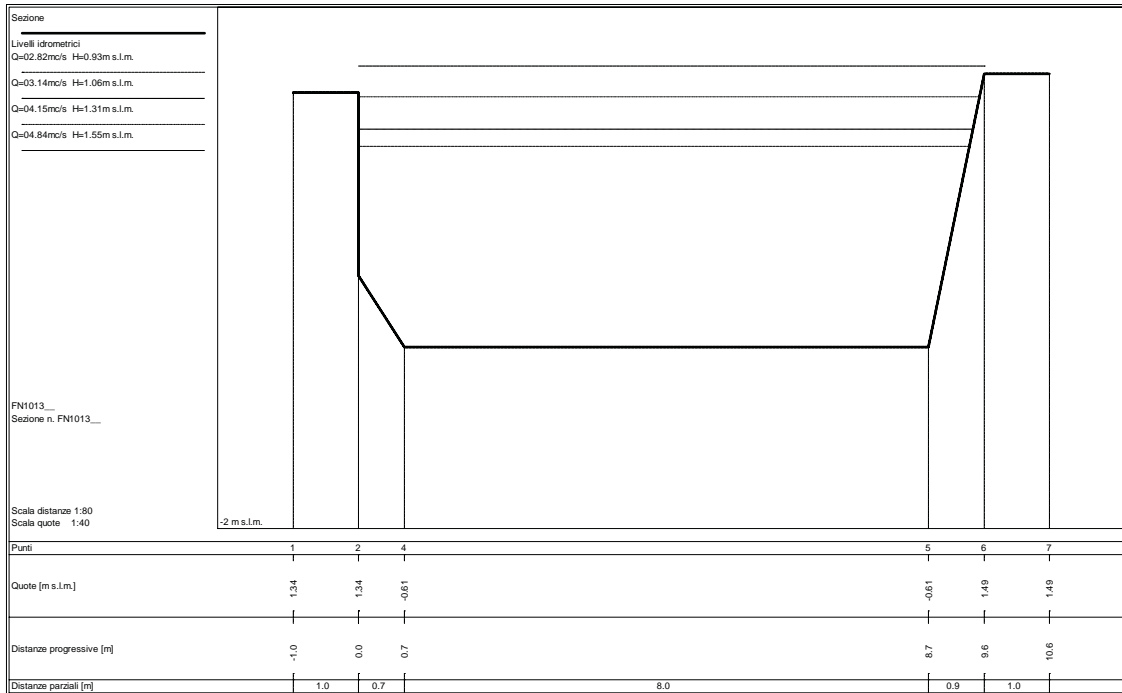

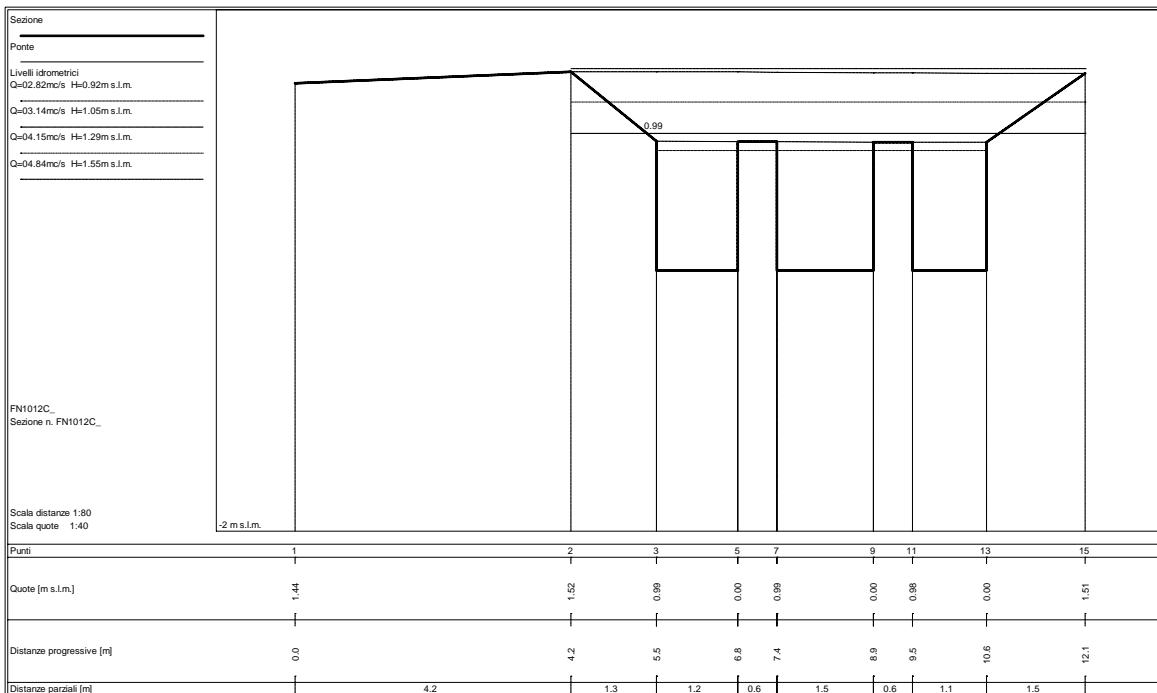
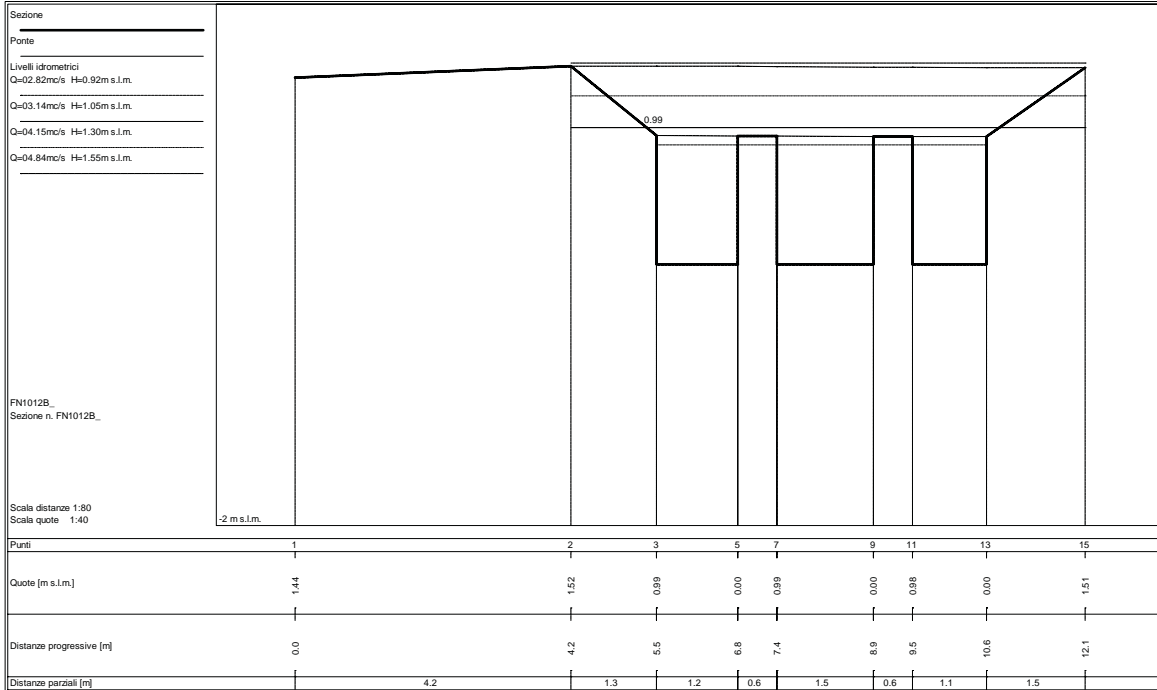

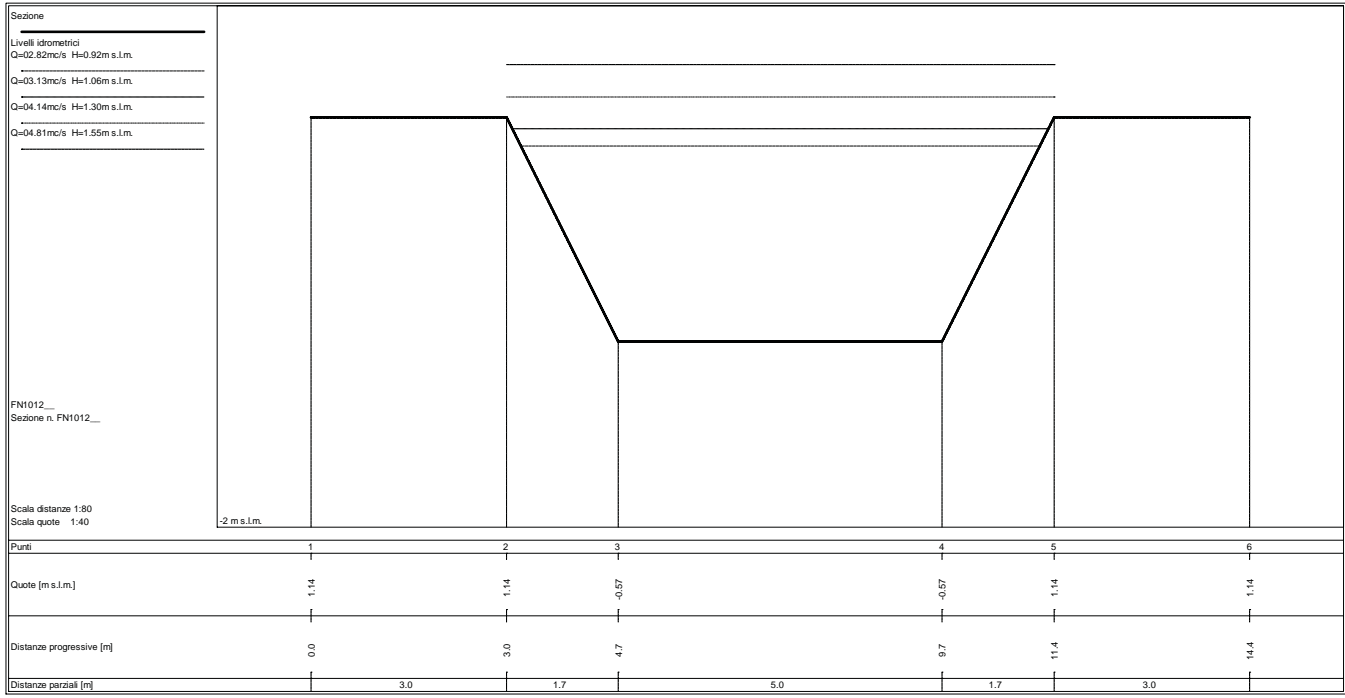
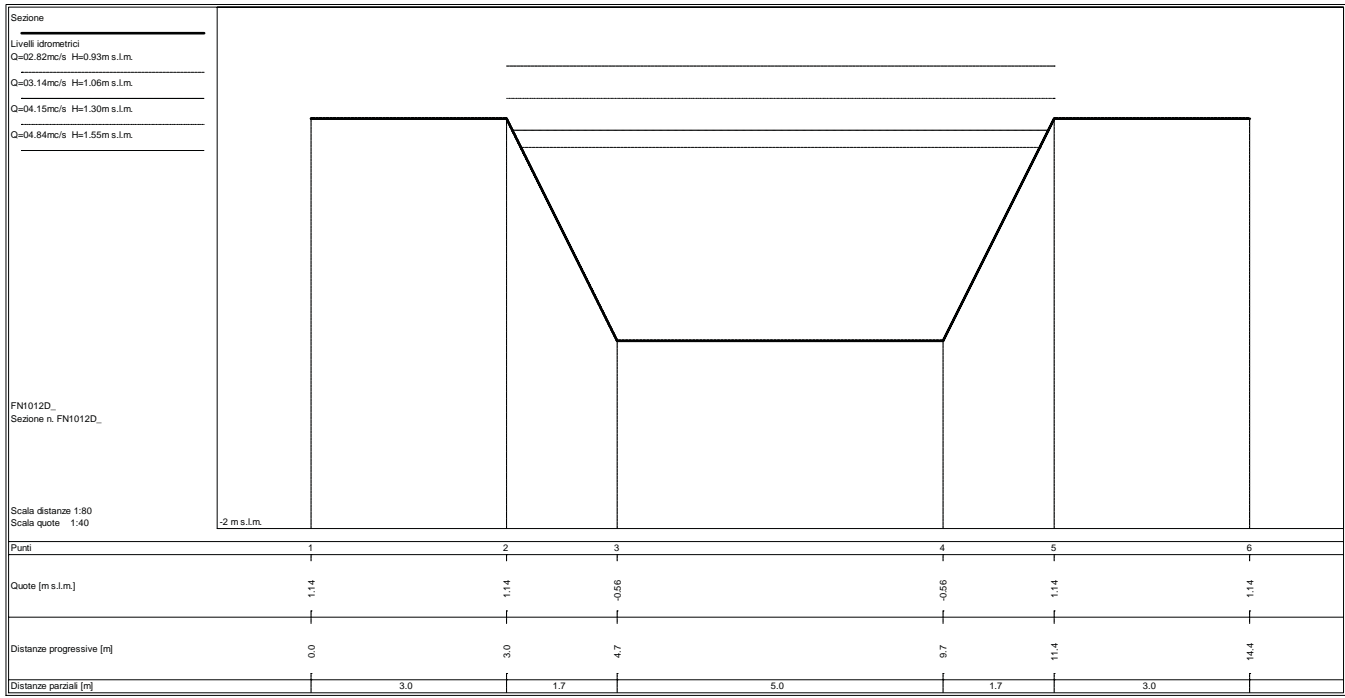

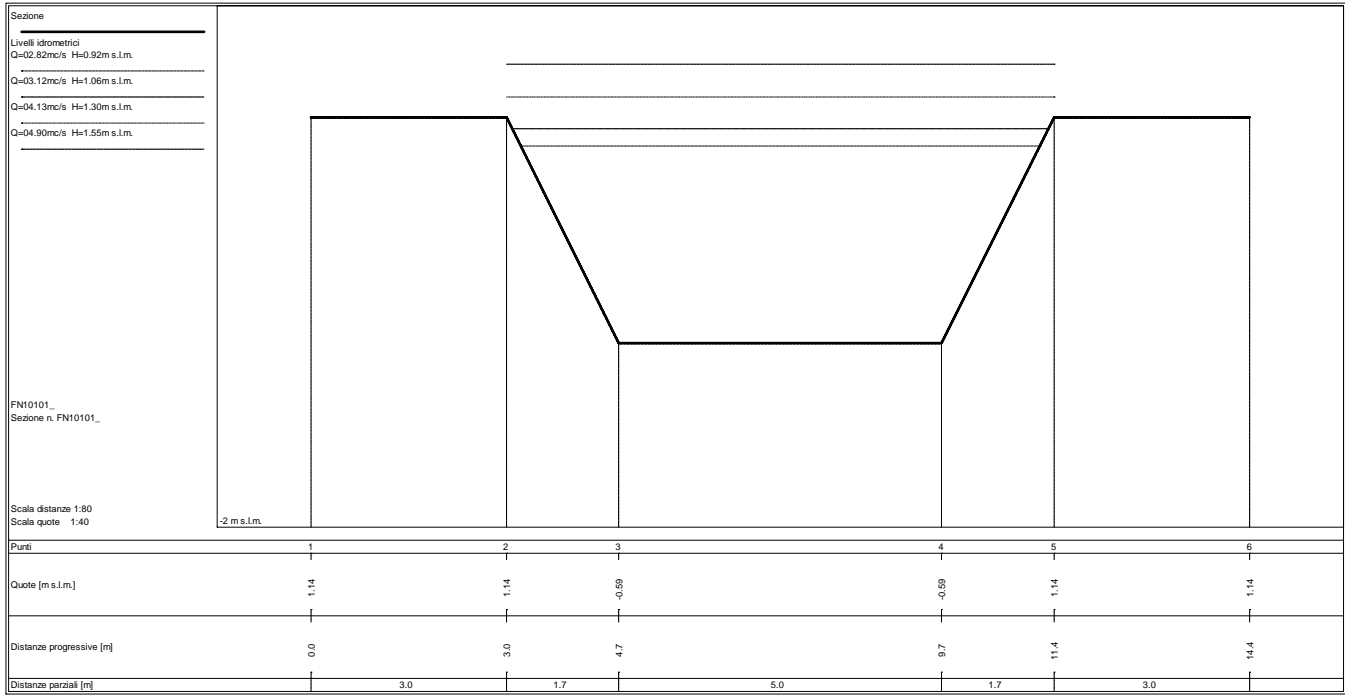
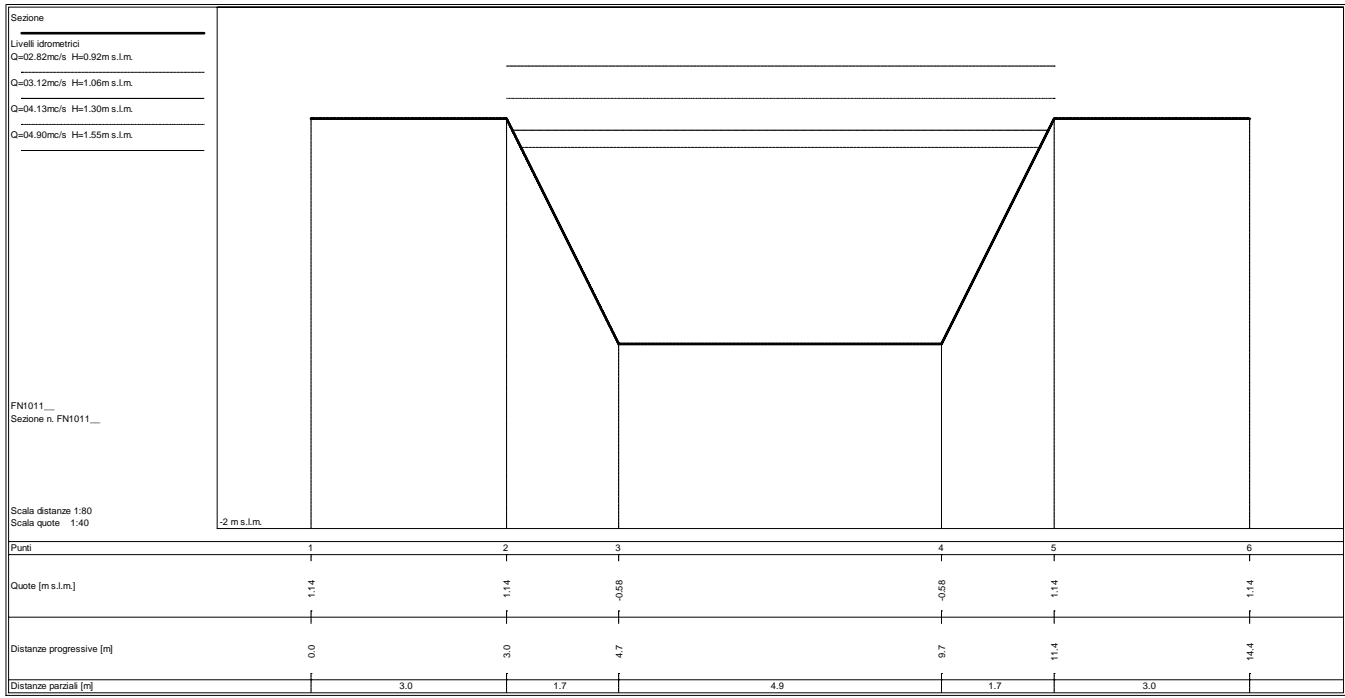

STATO ATTUALE

Sezioni fluviali fosso Nuovo – FN_1_b

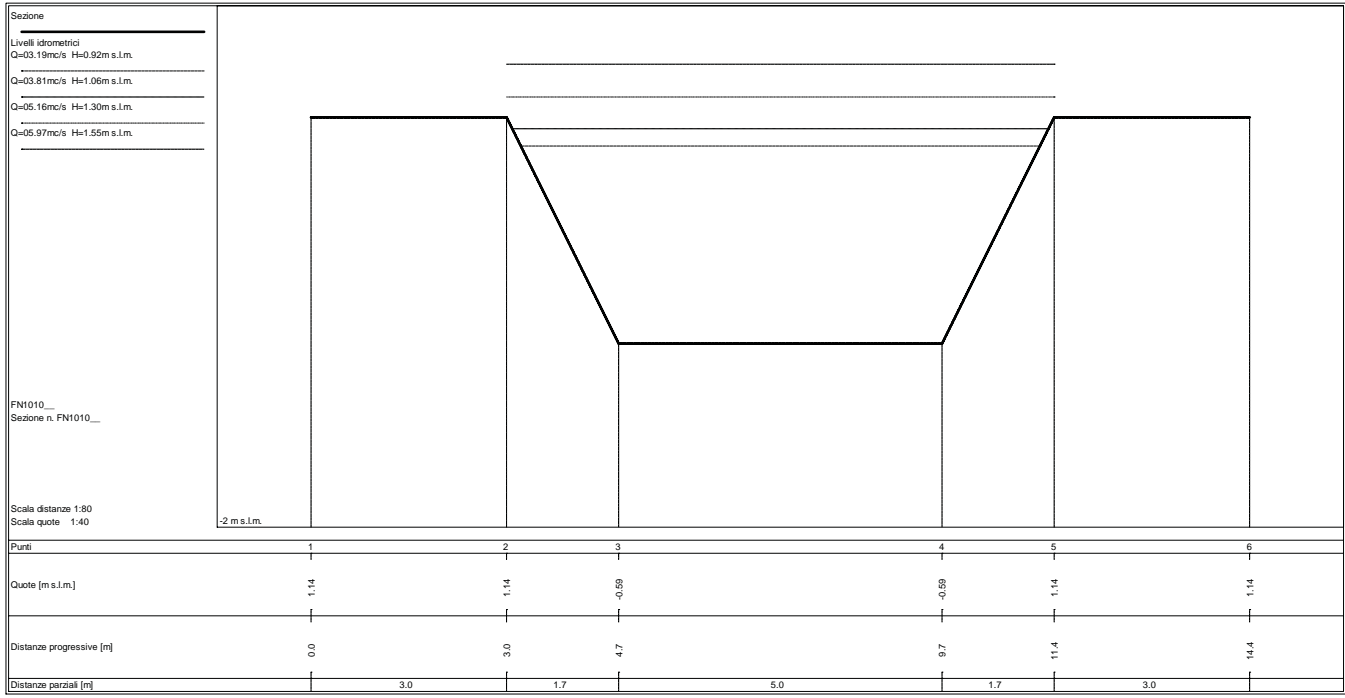
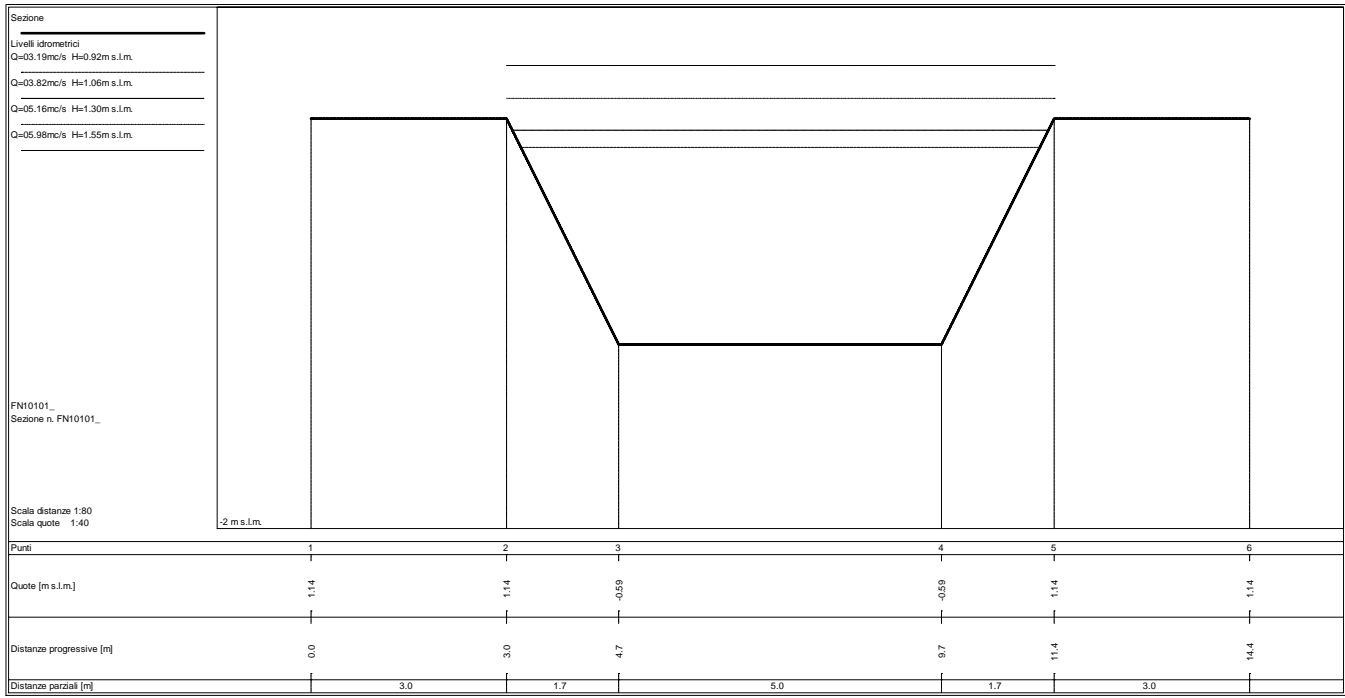

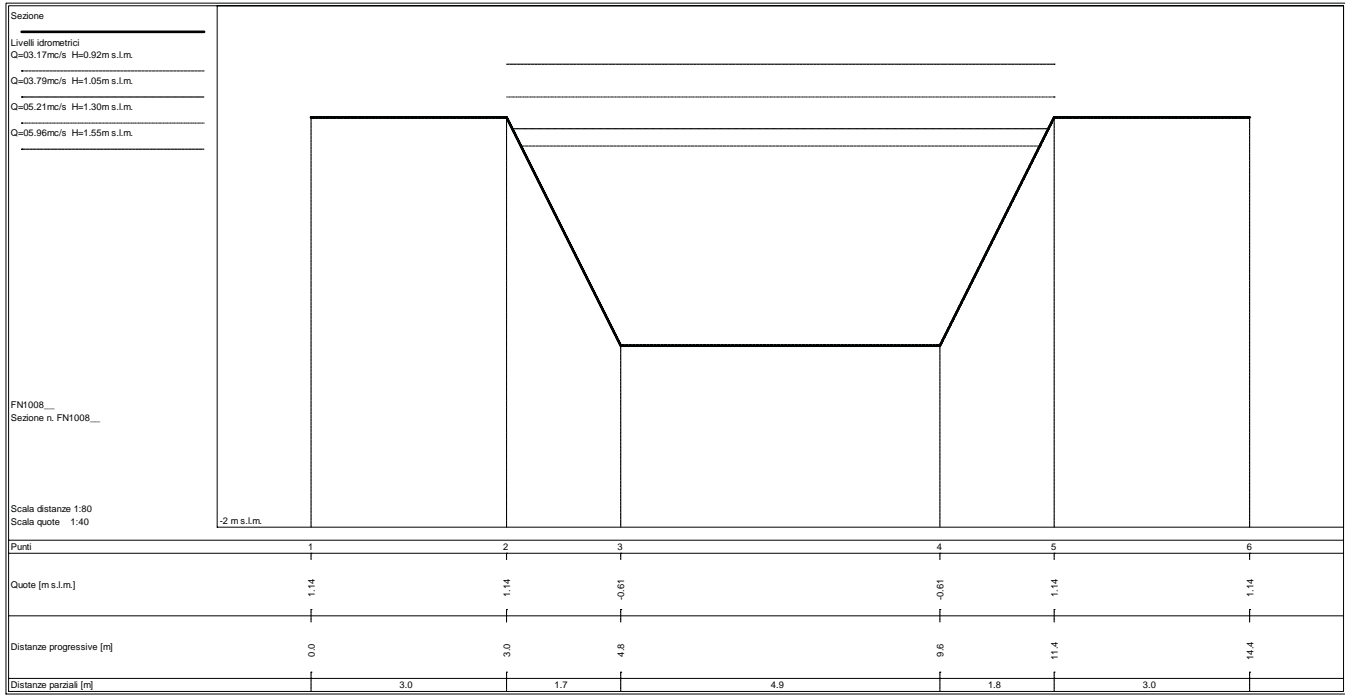
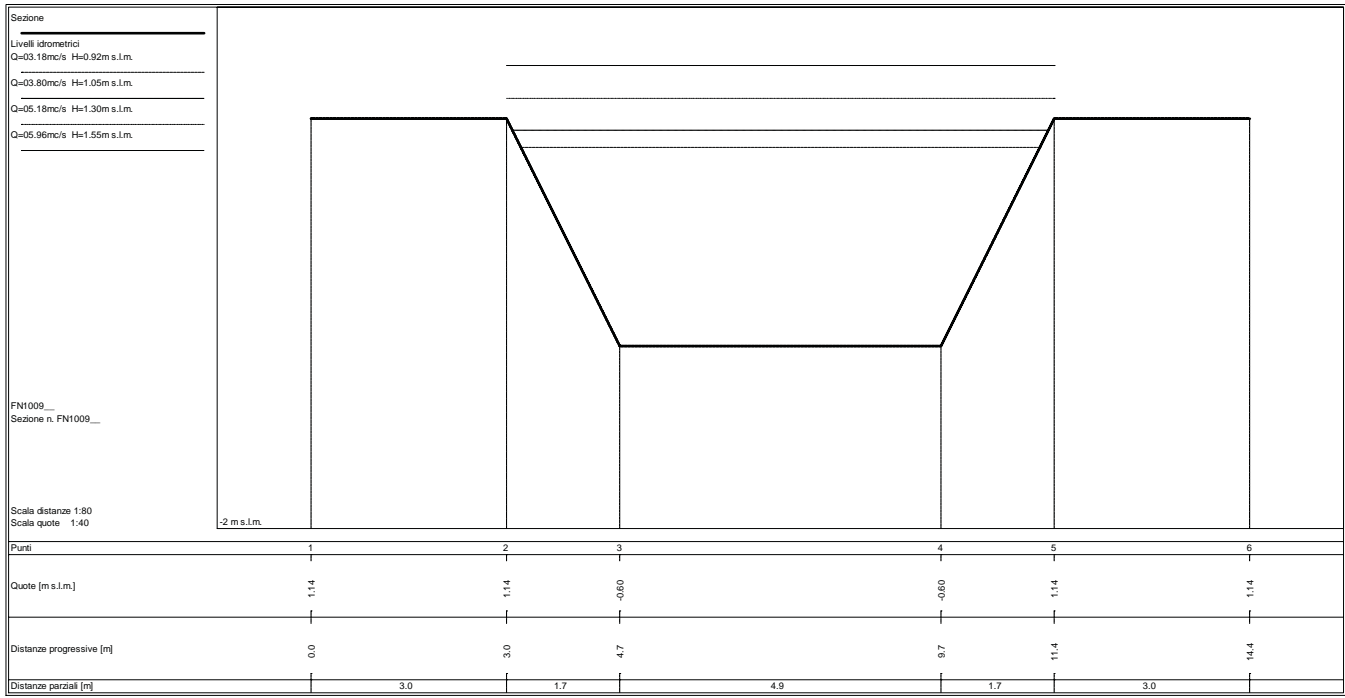

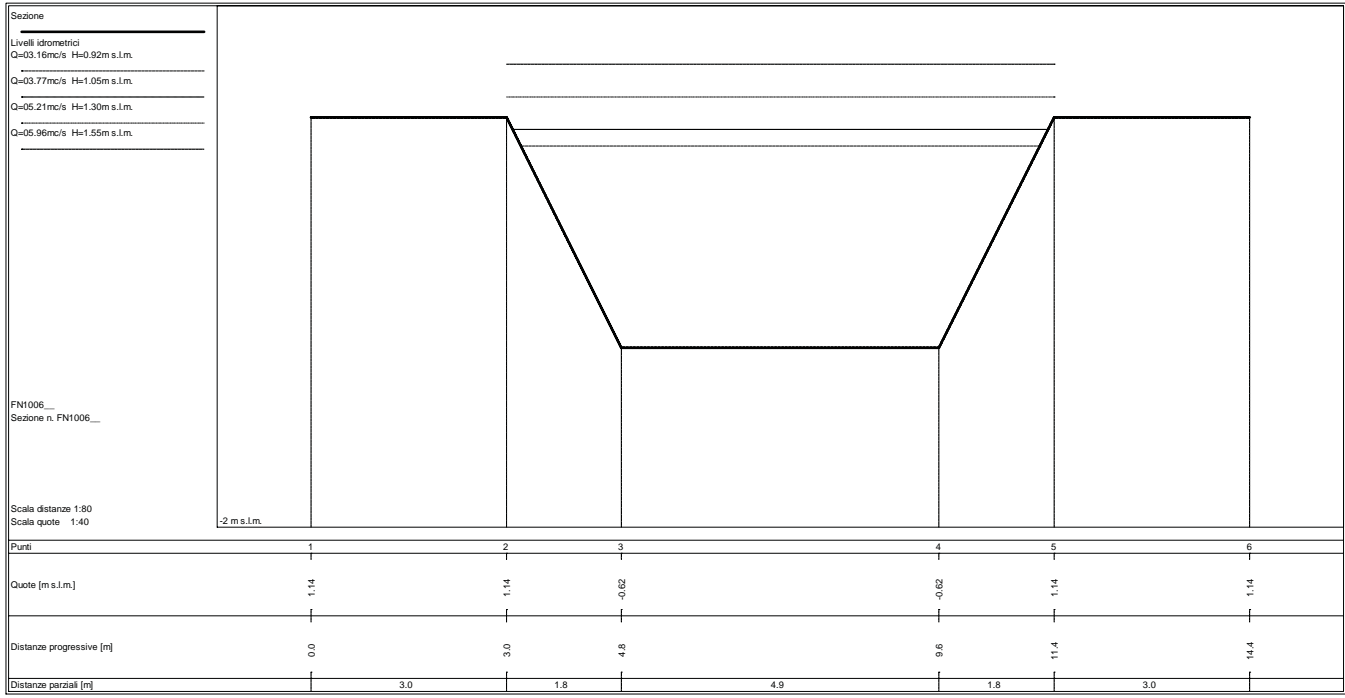
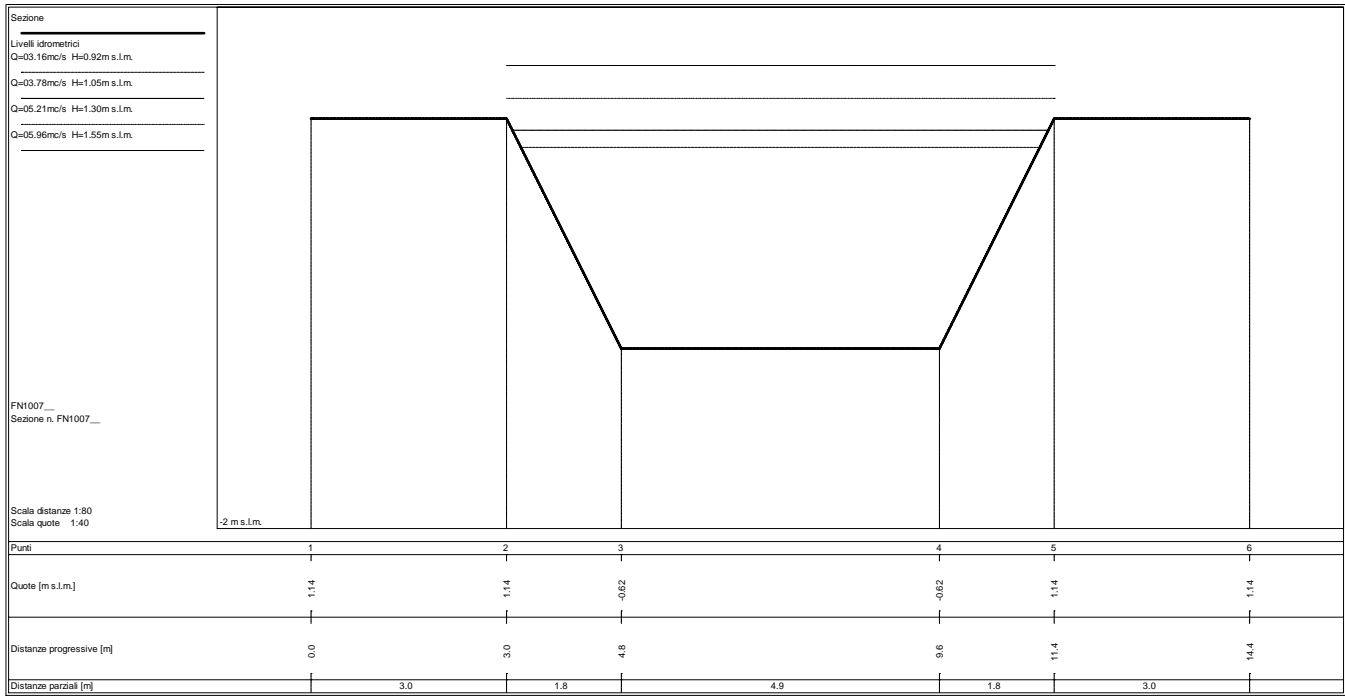

STATO ATTUALE

Sezioni fluviali fosso Nuovo – FN_1_c

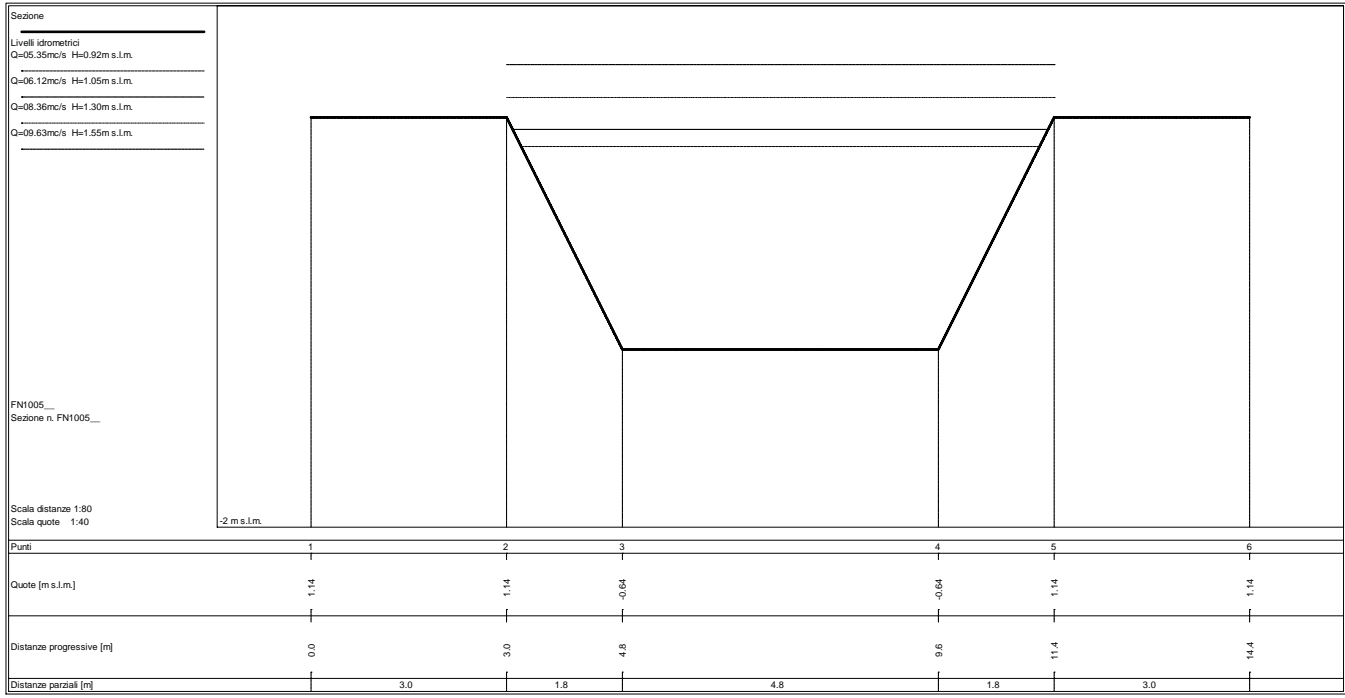
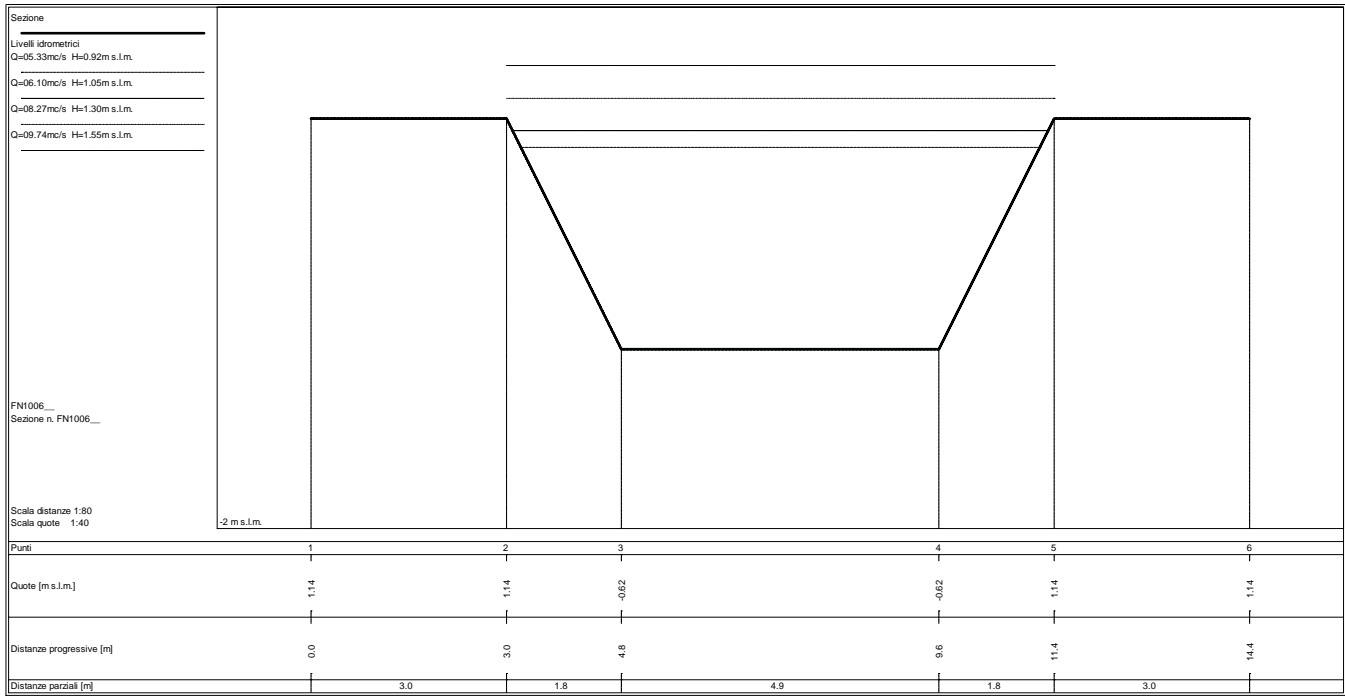

Sezione

Livelli idrometrici
 Q=05.33mc/s H=0.92m s.l.m.
 Q=06.11mc/s H=1.05m s.l.m.
 Q=08.30mc/s H=1.30m s.l.m.
 Q=09.41mc/s H=1.54m s.l.m.

FN1004_
 Sezione n. FN1004_

Scala distanze 1:80
 Scala quote 1:40

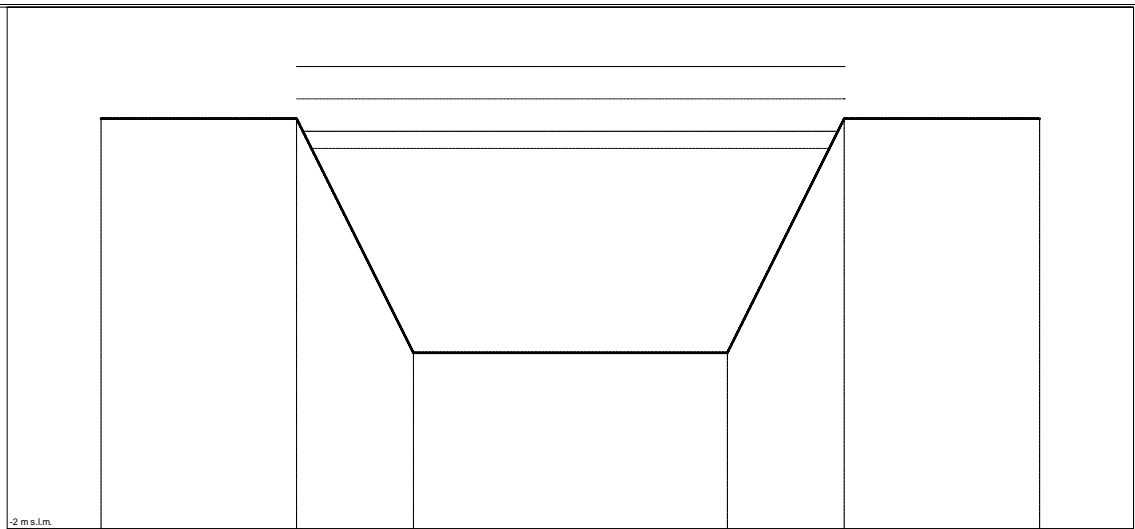

Punti	1	2	3	4	5	6
Quote [m s.l.m.]	1.14	1.14	-0.65	-0.65	1.14	1.14
Distanze progressive [m]	0.0	3.0	4.8	9.6	11.4	14.4
Distanze parziali [m]		3.0	1.8	4.8	1.8	3.0

Sezione

Livelli idrometrici
 Q=05.31mc/s H=0.91m s.l.m.
 Q=06.10mc/s H=1.05m s.l.m.
 Q=08.30mc/s H=1.29m s.l.m.
 Q=09.40mc/s H=1.54m s.l.m.

FN1003_
 Sezione n. FN1003_

Scala distanze 1:80
 Scala quote 1:40

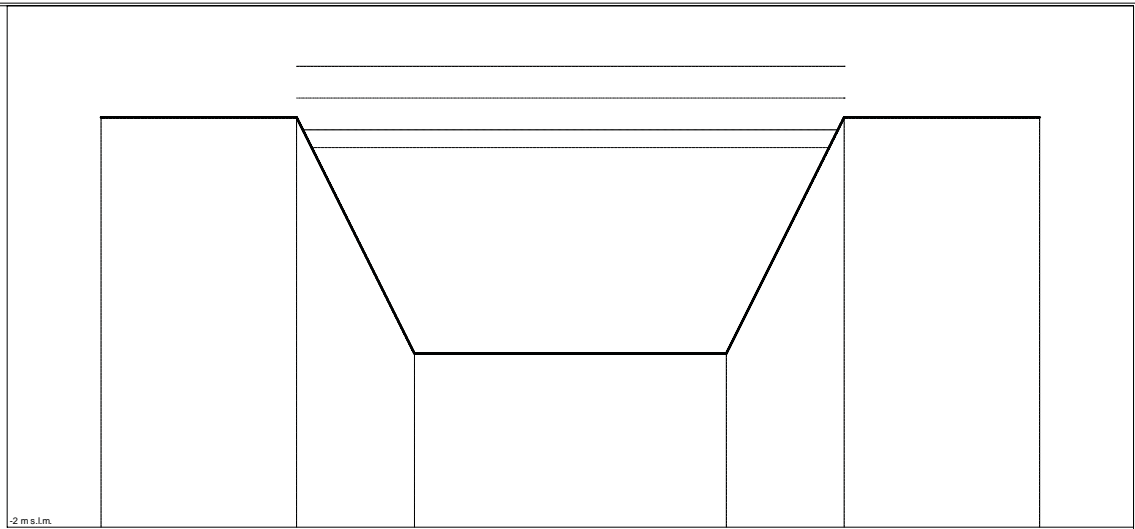

Punti	1	2	3	4	5	6
Quote [m s.l.m.]	1.14	1.14	-0.67	-0.67	1.14	1.14
Distanze progressive [m]	0.0	3.0	4.8	9.6	11.4	14.4
Distanze parziali [m]		3.0	1.8	4.8	1.8	3.0

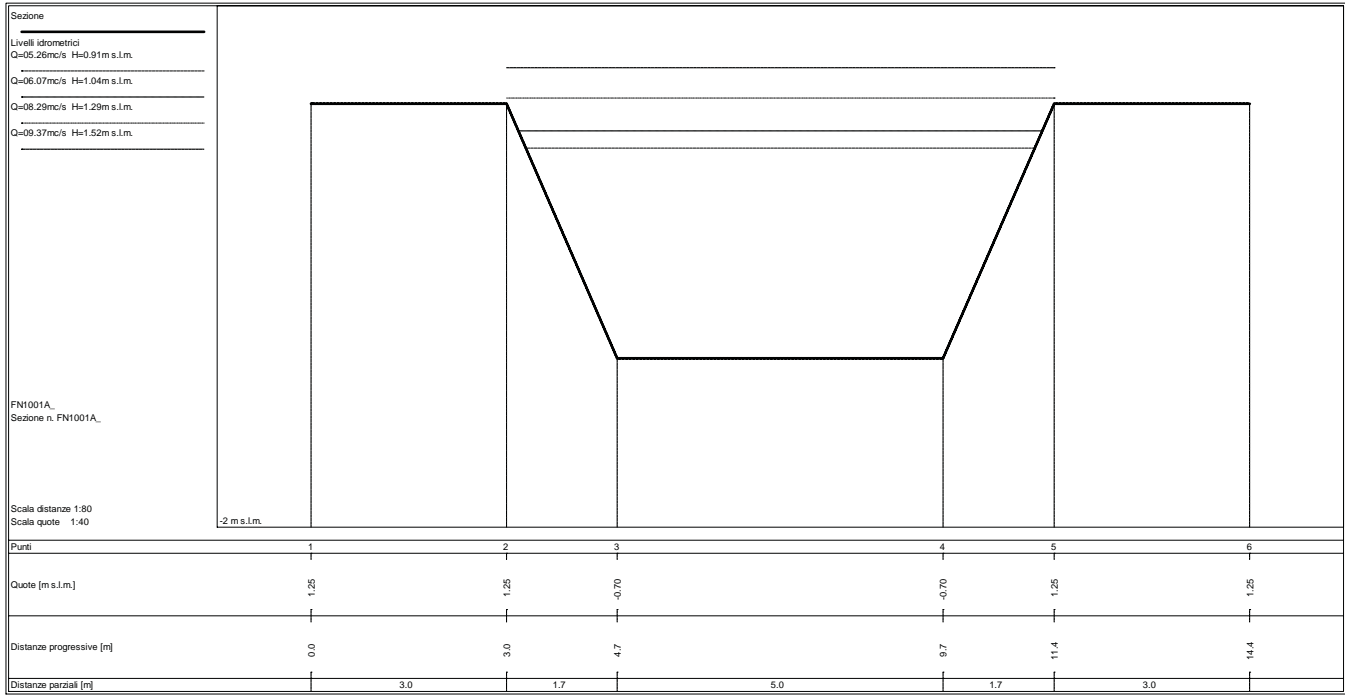
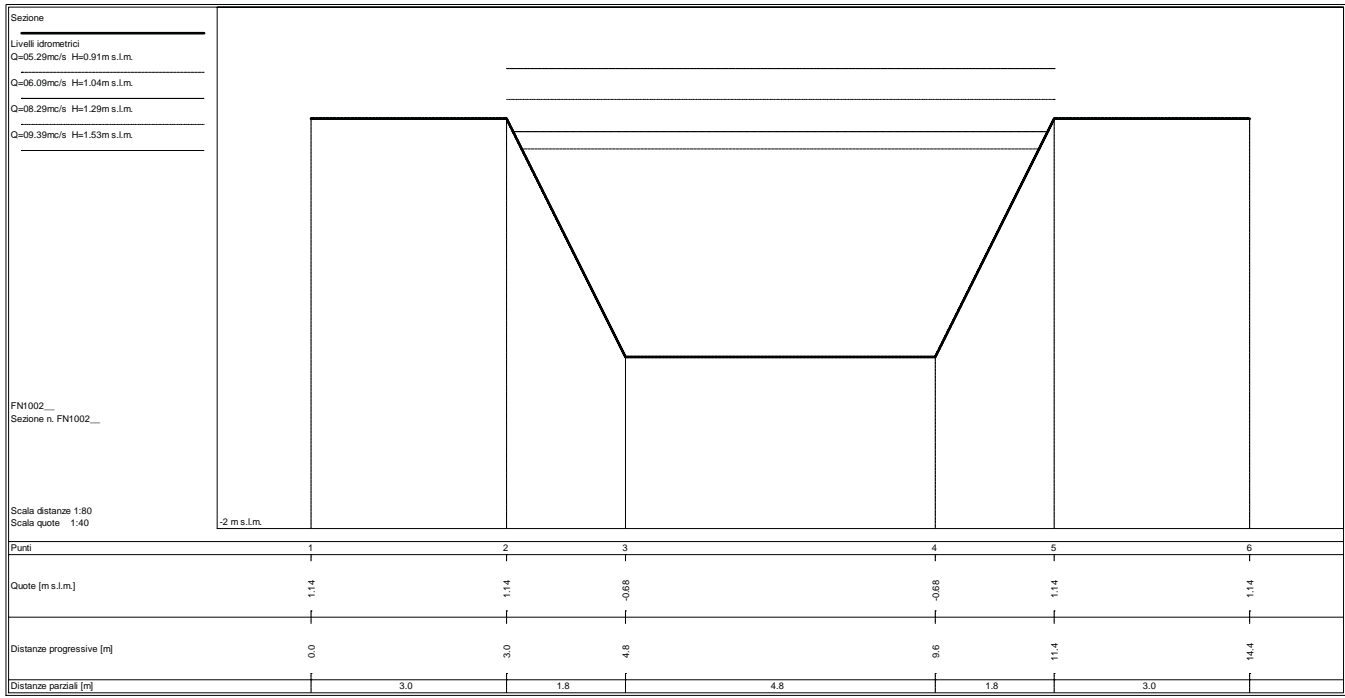

Sezione

Ponte

Livelli idrometrici

Q=05.26mc/s H=0.91m s.l.m.

Q=06.07mc/s H=1.04m s.l.m.

Q=08.29mc/s H=1.29m s.l.m.

Q=09.37mc/s H=1.49m s.l.m.

FN1001B_

Sezione n. FN1001B_

Scala distanze 1:80

Scala quote 1:40

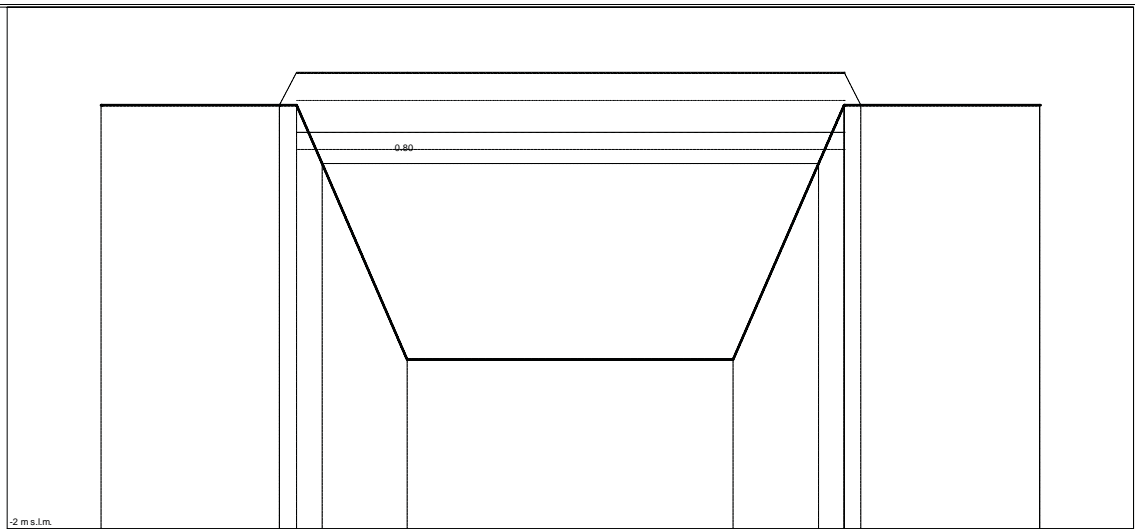

Punti	1	2	4	5	6	7	8	9	11	12
Quote [m s.l.m.]	1.25	1.25	1.25	0.80	-0.70	-0.70	0.80	1.25	1.25	1.25
Distanze progressive [m]	0.0	2.7	3.0	3.4	4.7	9.7	11.0	11.4	11.7	14.4
Distanze parziali [m]		2.7	0.4	1.3		5.0	1.3	0.4		2.7

Sezione

Ponte

Livelli idrometrici

Q=05.25mc/s H=0.91m s.l.m.

Q=06.07mc/s H=1.04m s.l.m.

Q=08.29mc/s H=1.28m s.l.m.

Q=09.37mc/s H=1.48m s.l.m.

FN1001C_

Sezione n. FN1001C_

Scala distanze 1:80

Scala quote 1:40

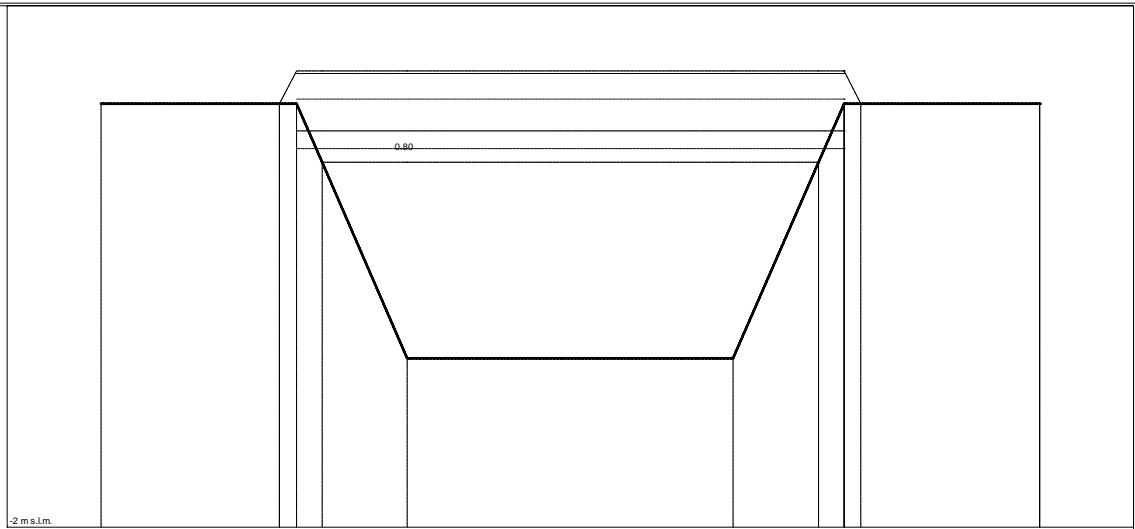

Punti	1	2	4	5	6	7	8	9	11	12
Quote [m s.l.m.]	1.25	1.25	1.25	0.80	-0.70	-0.70	0.80	1.25	1.25	1.25
Distanze progressive [m]	0.0	2.7	3.0	3.4	4.7	9.7	11.0	11.4	11.7	14.4
Distanze parziali [m]		2.7	0.4	1.3		5.0	1.3	0.4		2.7

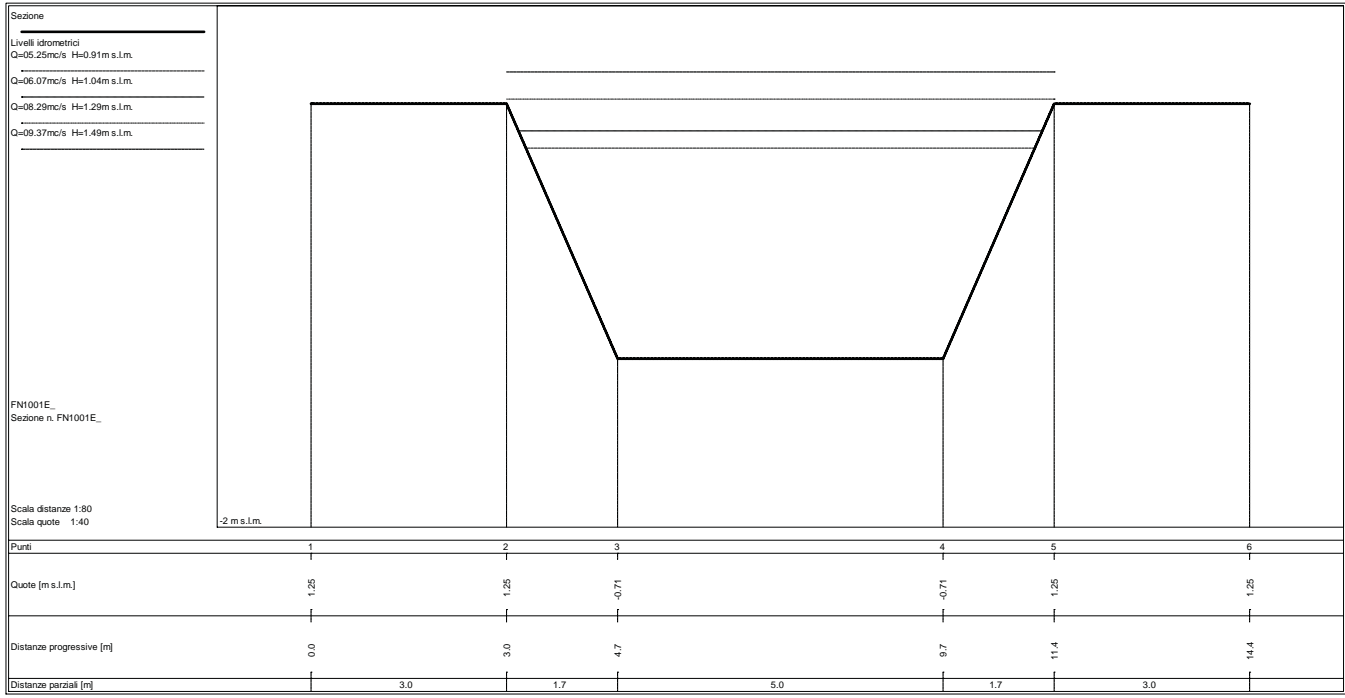
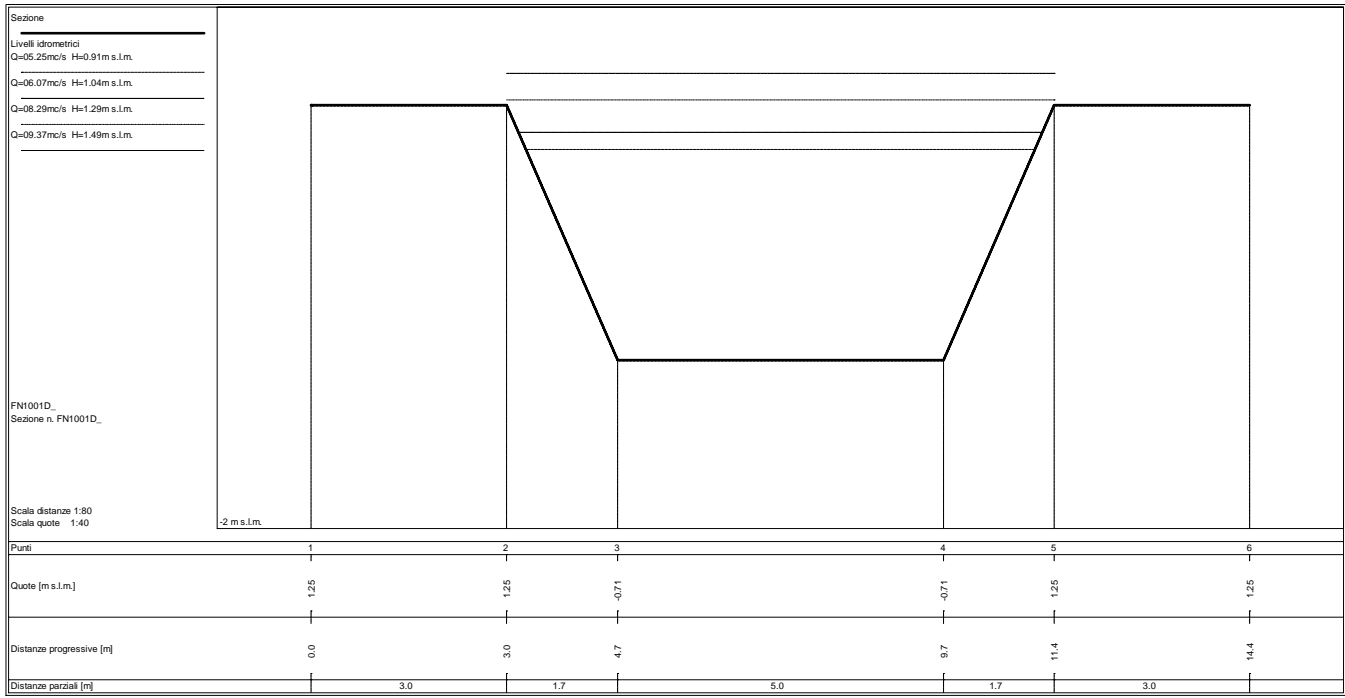

Sezione

Livelli idrometrici
 Q=05.28mc/s H=0.91m s.l.m.
 Q=06.12mc/s H=1.04m s.l.m.
 Q=08.38mc/s H=1.28m s.l.m.
 Q=09.38mc/s H=1.49m s.l.m.

FN1001_
 Sezione n. FN1001_

Scala distanze 1:80
 Scala quote 1:40

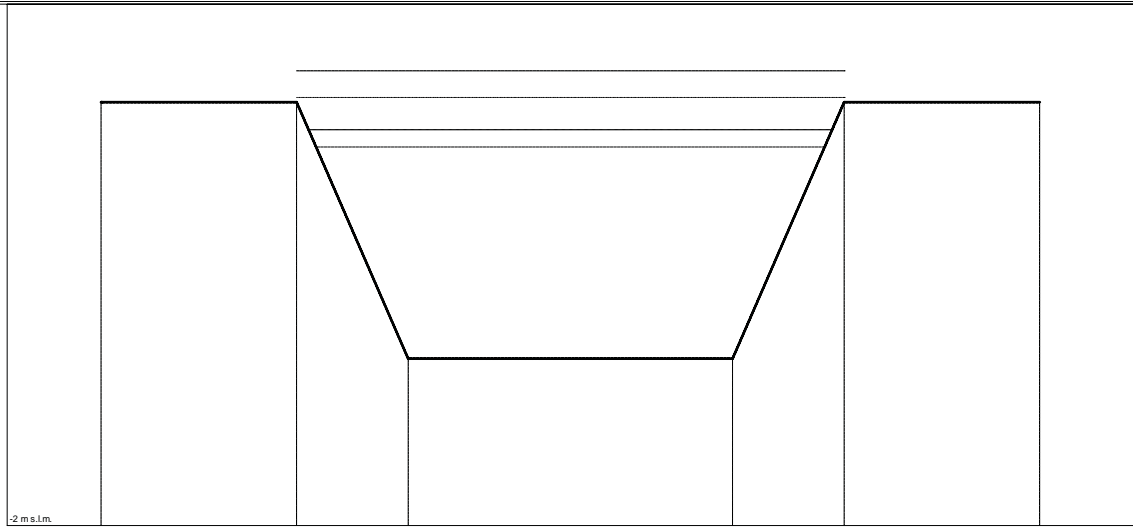

Punti	1	2	3	4	5	6
Quote [m s.l.m.]	1.25	1.25	-0.72	-0.72	1.25	1.25
Distanze progressive [m]	0.0	3.0	4.7	9.7	11.4	14.4
Distanze parziali [m]		3.0	1.7	5.0	1.7	3.0

Sezione

Livelli idrometrici
 Q=05.28mc/s H=0.90m s.l.m.
 Q=06.12mc/s H=1.04m s.l.m.
 Q=08.38mc/s H=1.29m s.l.m.
 Q=09.37mc/s H=1.49m s.l.m.

FN10011_
 Sezione n. FN10011_
 sezione di confine tra FN_1 e ME_c_P

Scala distanze 1:80
 Scala quote 1:40

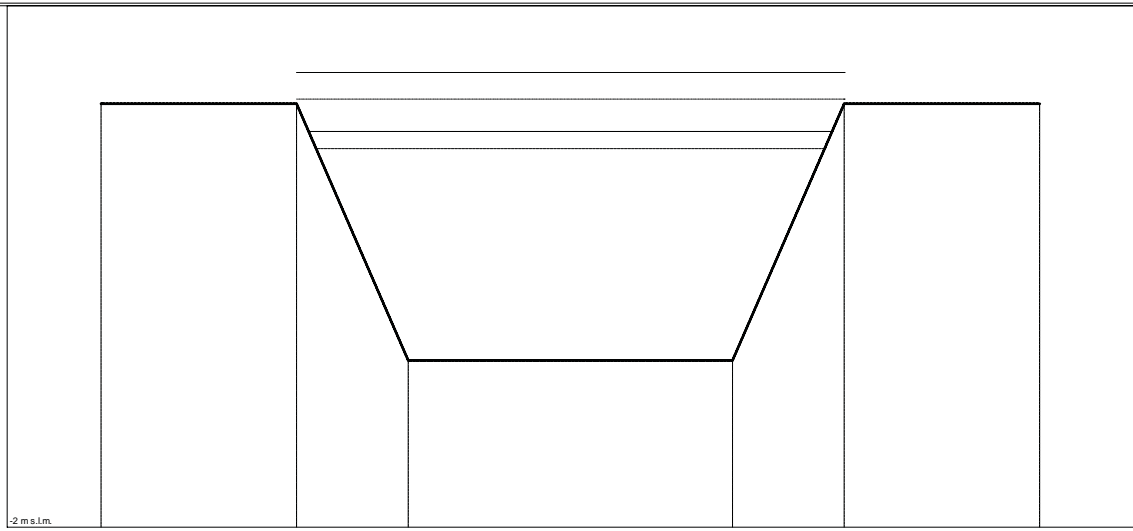

Punti	1	2	3	4	5	6
Quote [m s.l.m.]	1.25	1.25	-0.72	-0.72	1.25	1.25
Distanze progressive [m]	0.0	3.0	4.7	9.7	11.4	14.4
Distanze parziali [m]		3.0	1.7	5.0	1.7	3.0

STATO ATTUALE

Sezioni fluviali fosso Nuovo – FN_2

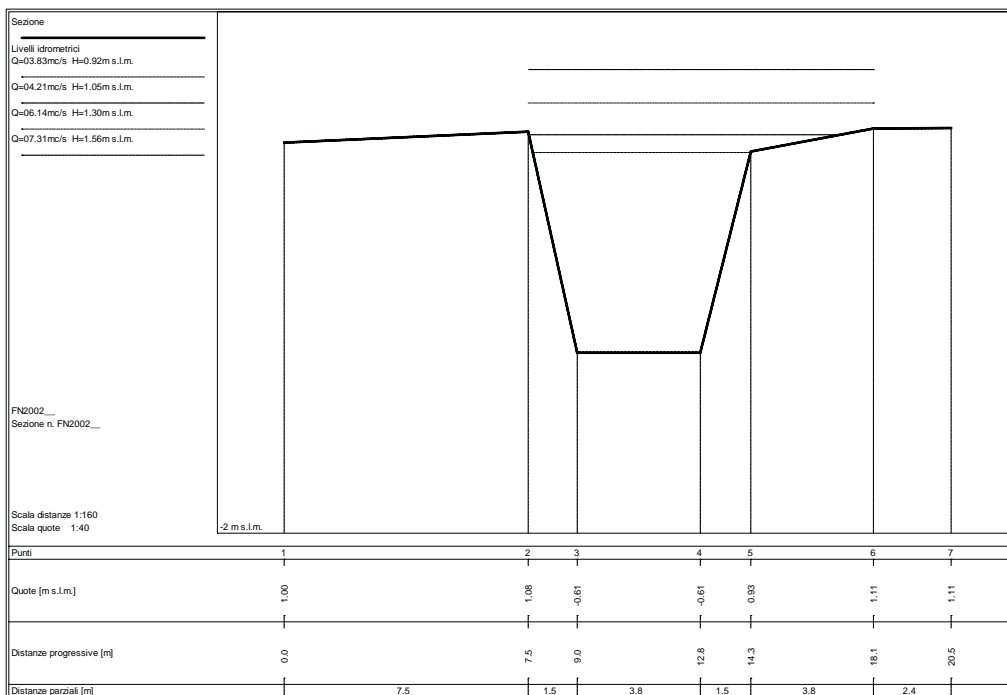
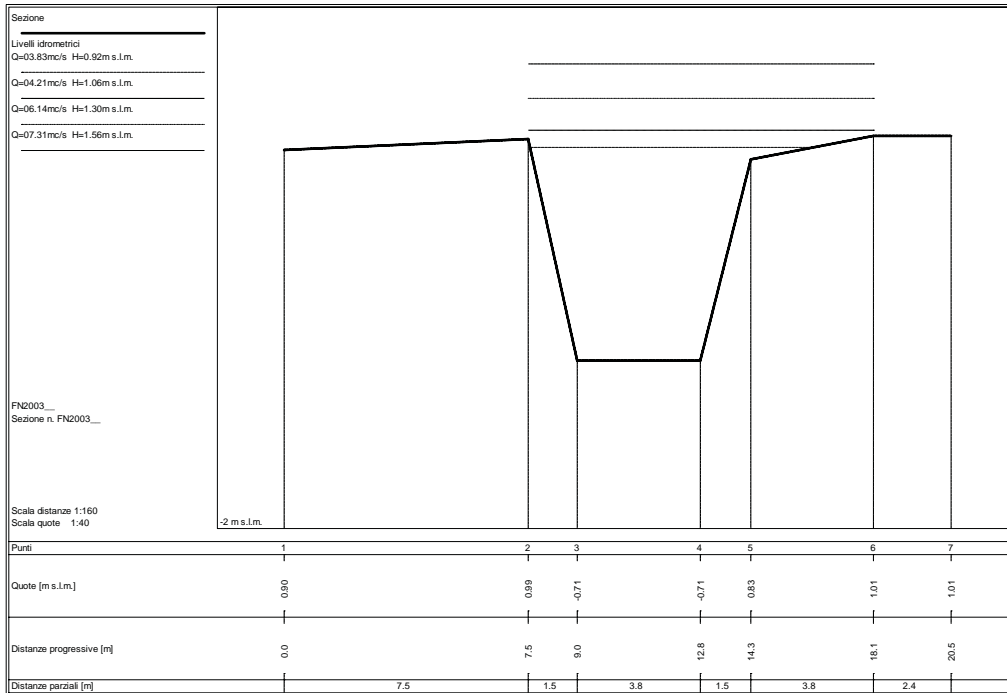

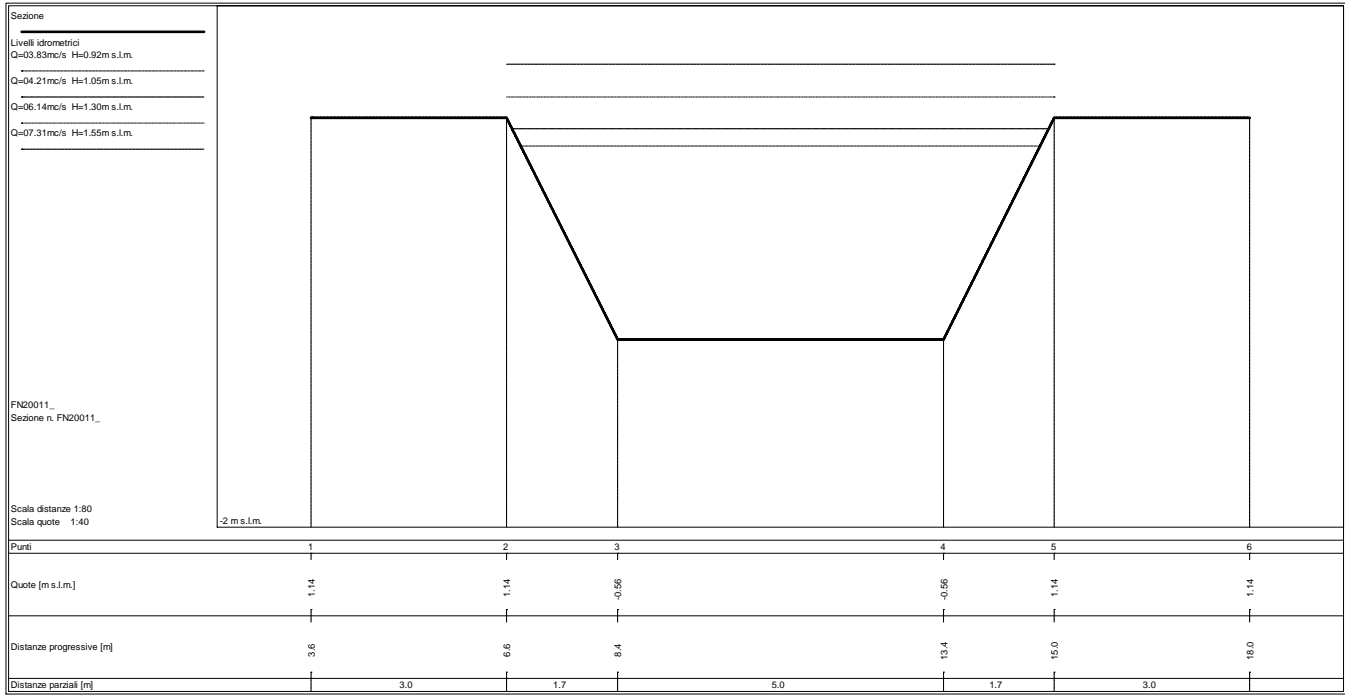
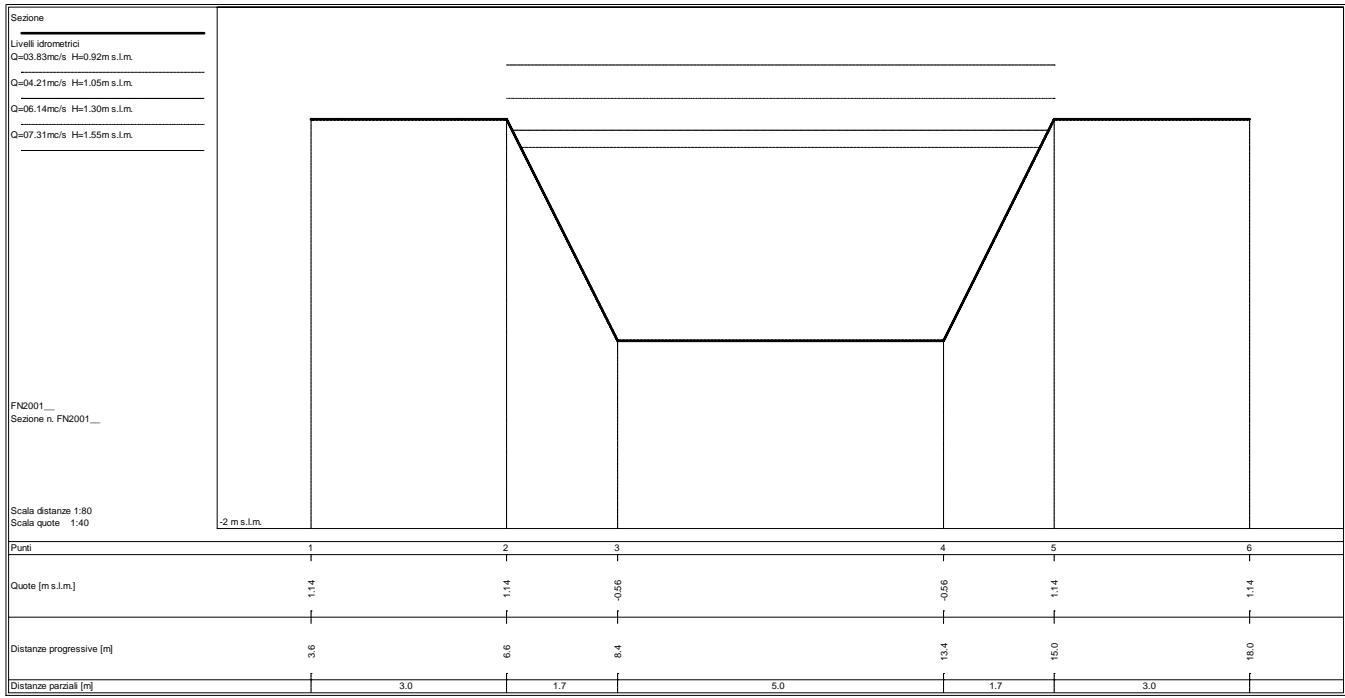

Sezione

-
-
-
-
-
-

FN10061_
 Sezione n. FN10061_
 sezione di confine tr
 a FN_2 e FN_1 (conci
 de con FN1006_ (tran
 ne la progressiva)

Scala distanze 1:80
 Scala quote 1:40

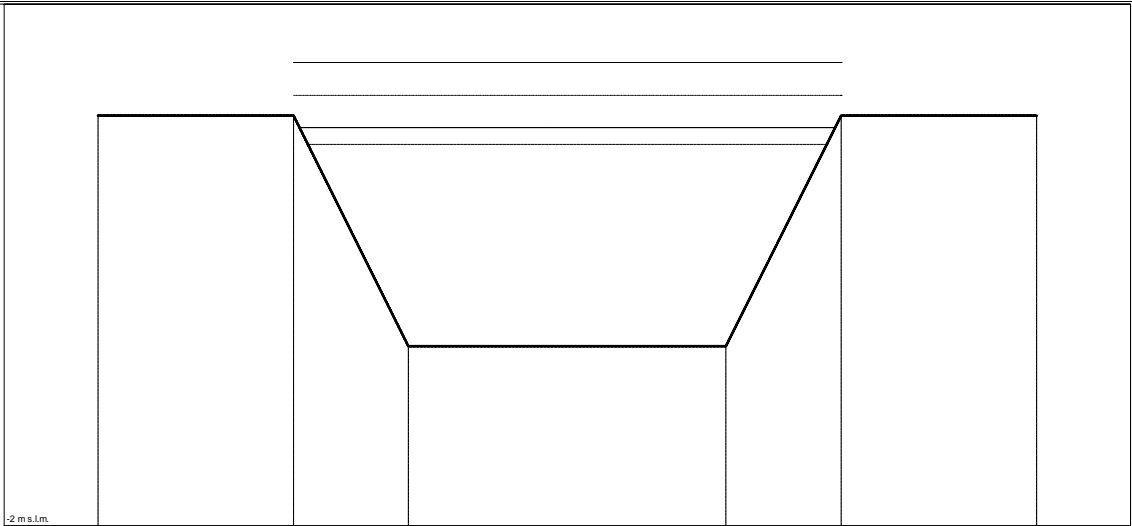

Punti	1	2	3	4	5	6
Quote [m s.l.m.]	1,14	1,14	-0,82	-0,82	1,14	1,14
Distanze progressive [m]	0,0	3,0	4,8	9,6	11,4	14,4
Distanze parziali [m]		3,0	1,8	4,9	1,8	3,0

STATO ATTUALE

Sezioni fluviali fosso Nuovo – FN_3

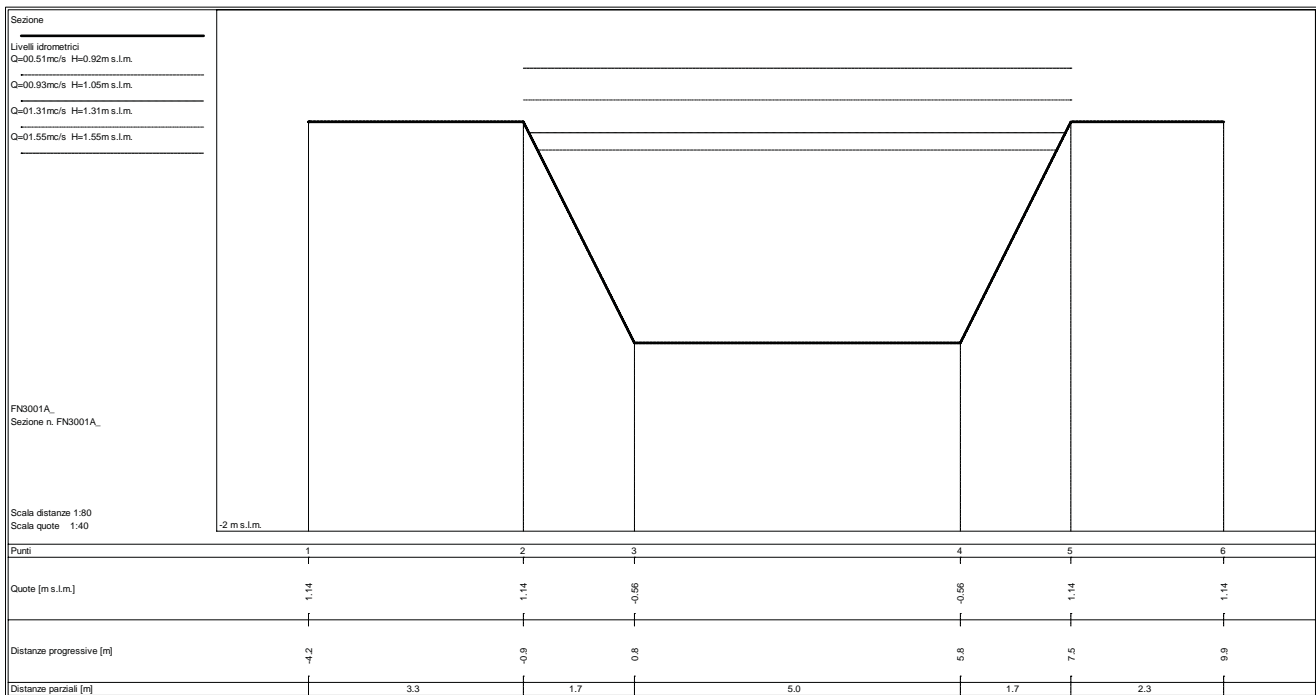
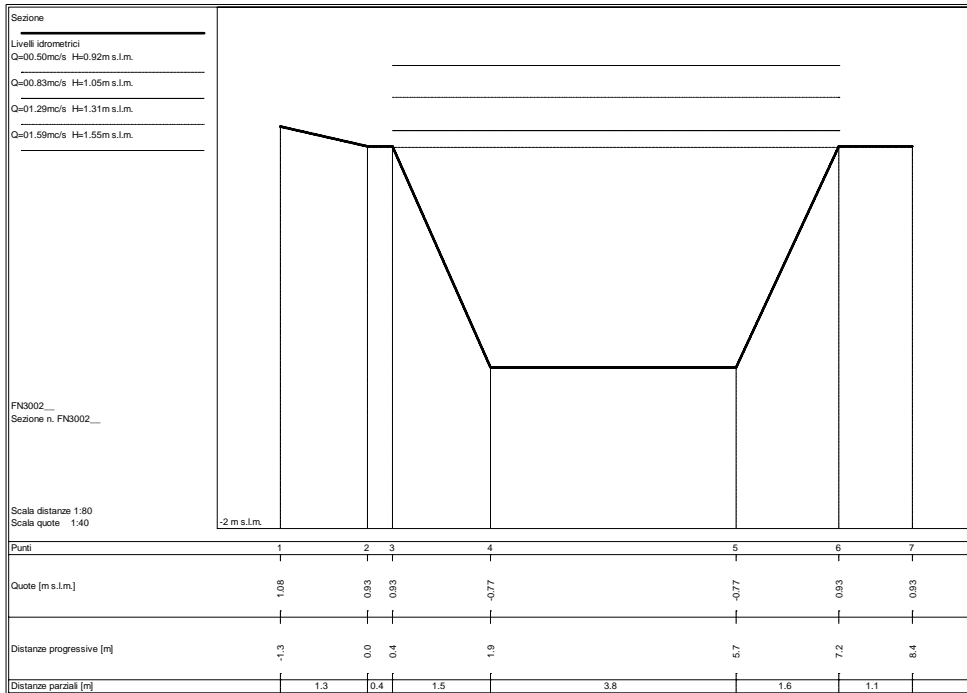

Sezione

Porta

Livelli idrometrici

Q=0.51mc/s H=0.92m s.l.m.

Q=0.93mc/s H=1.05m s.l.m.

Q=0.131mc/s H=1.30m s.l.m.

Q=0.155mc/s H=1.55m s.l.m.

FN3001B_
Sezione n. FN3001B_

Scala distanze 1:80
Scala quote 1:40

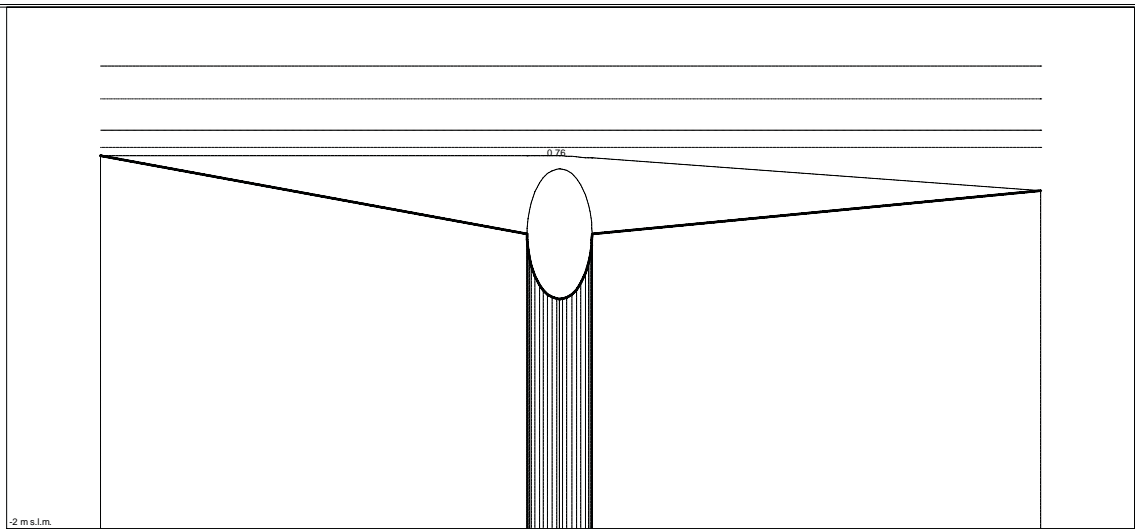

Punti	1	2	5	11	16	19	26
Quote [m s.l.m.]	0.86	0.26	0.14	-0.23	-0.23	-0.12	0.59
Distanze progressive [m]	0.0	6.5	6.9	7.2	7.4		14.4
Distanze parziali [m]		6.5				6.9	

Sezione

Porta

Livelli idrometrici

Q=0.51mc/s H=0.92m s.l.m.

Q=0.93mc/s H=1.05m s.l.m.

Q=0.131mc/s H=1.30m s.l.m.

Q=0.155mc/s H=1.55m s.l.m.

FN3001C_
Sezione n. FN3001C_

Scala distanze 1:80
Scala quote 1:40

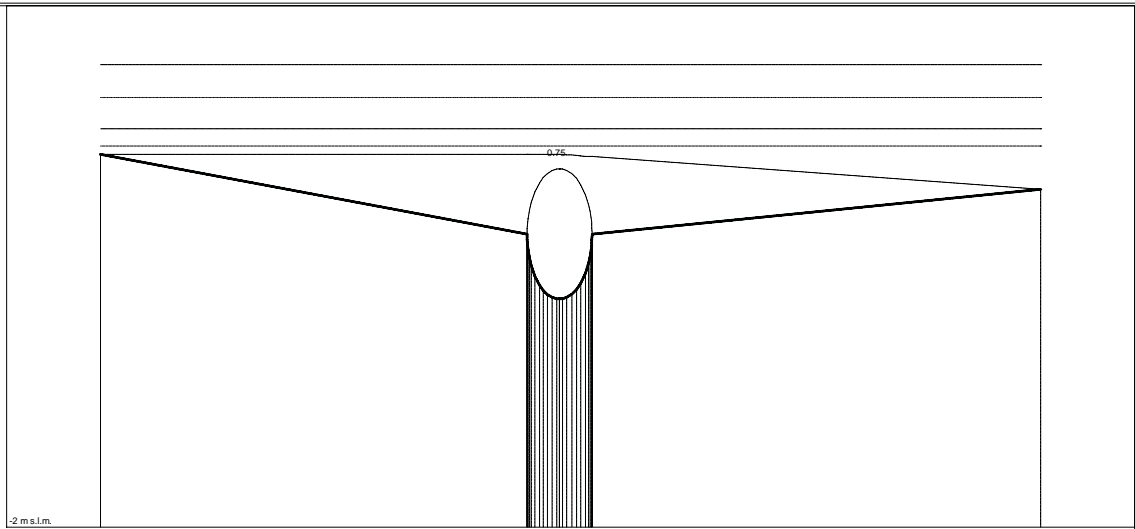

Punti	1	2	5	11	16	19	26
Quote [m s.l.m.]	0.86	0.25	0.14	-0.24	-0.24	-0.13	0.59
Distanze progressive [m]	0.0	6.5	6.9	7.2	7.4		14.4
Distanze parziali [m]		6.5				6.9	

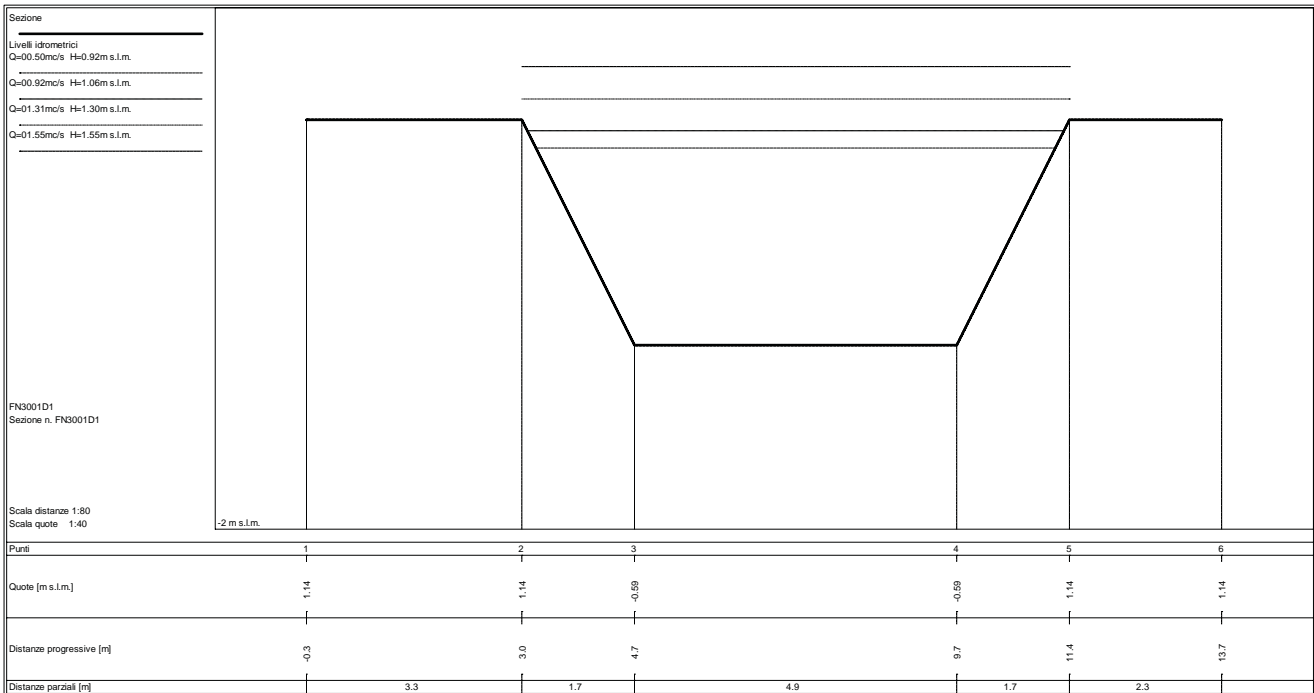
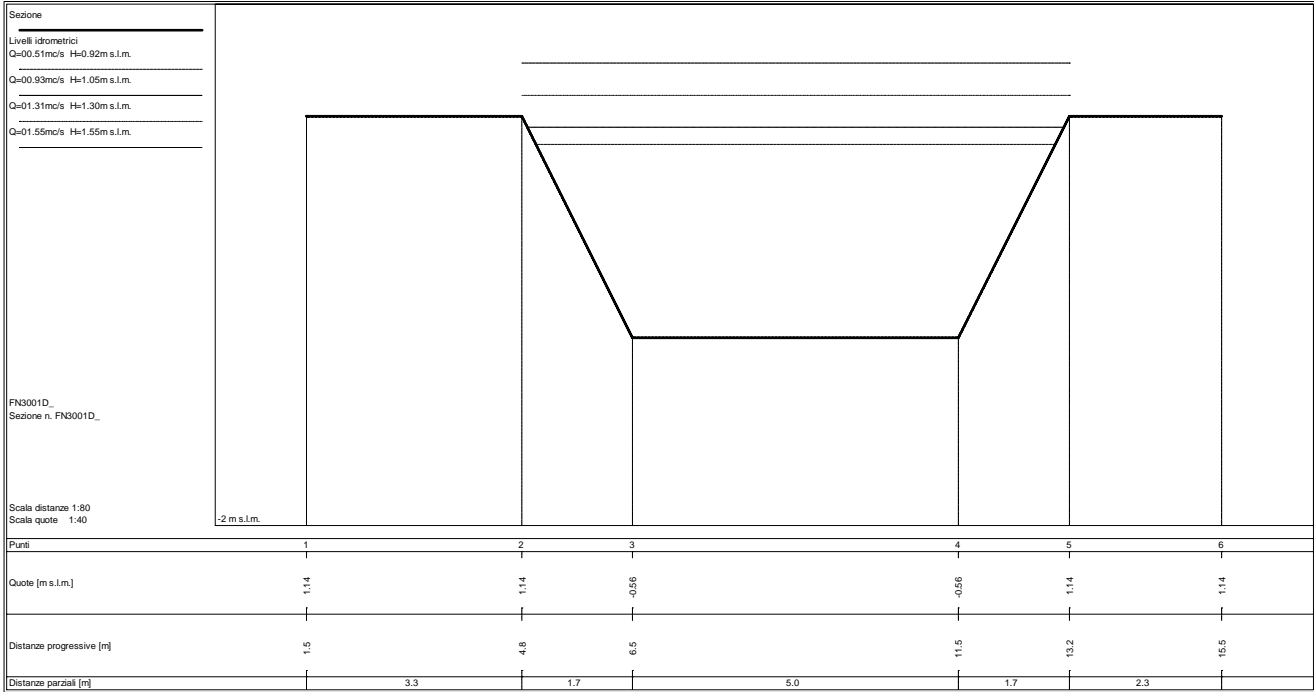

Sezione

-
-
-
-
-

FN101011
 Sezione n. FN101011
 sezione di confine tra
 la FN_3 e FN_1 (conosci
 de con FN10101_ (tran
 ne la progressiva)

Scala distanze 1:80
 Scala quote 1:40

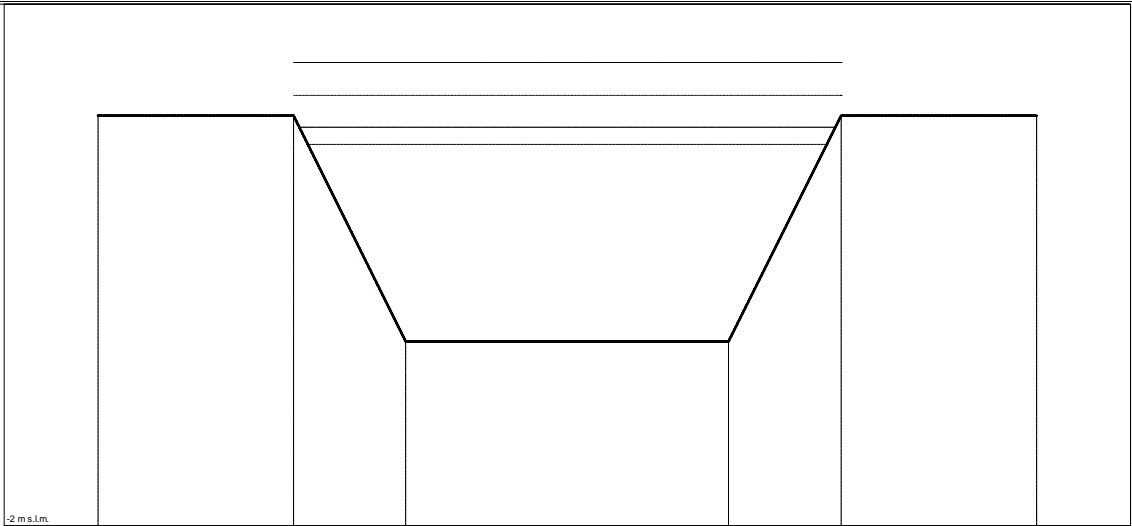

Punti	1	2	3	4	5	6
Quote [m s.l.m.]	1.14	1.14	-0.69	-0.69	1.14	1.14
Distanze progressive [m]	0.0	3.0	4.7	9.7	11.4	14.4
Distanze parziali [m]		3.0	1.7	5.0	1.7	3.0

STATO ATTUALE
Sezioni fluviali Fosso Lodolina

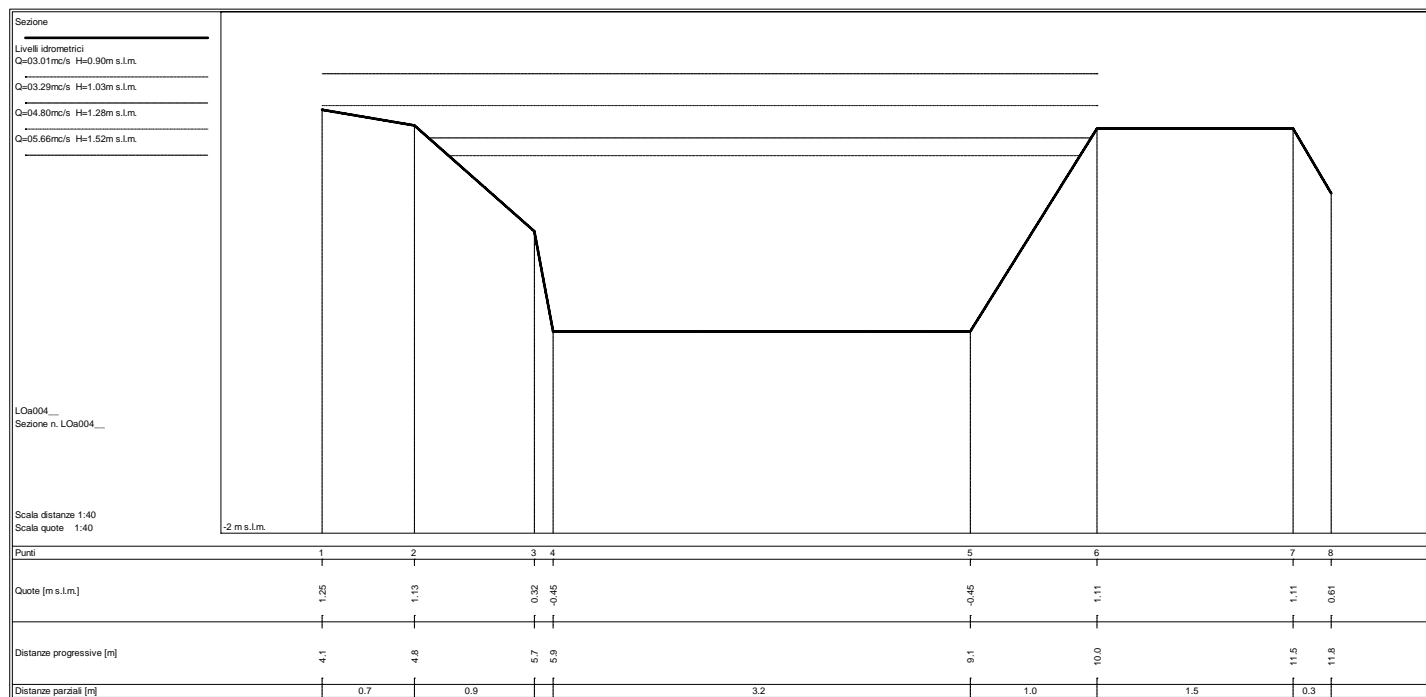
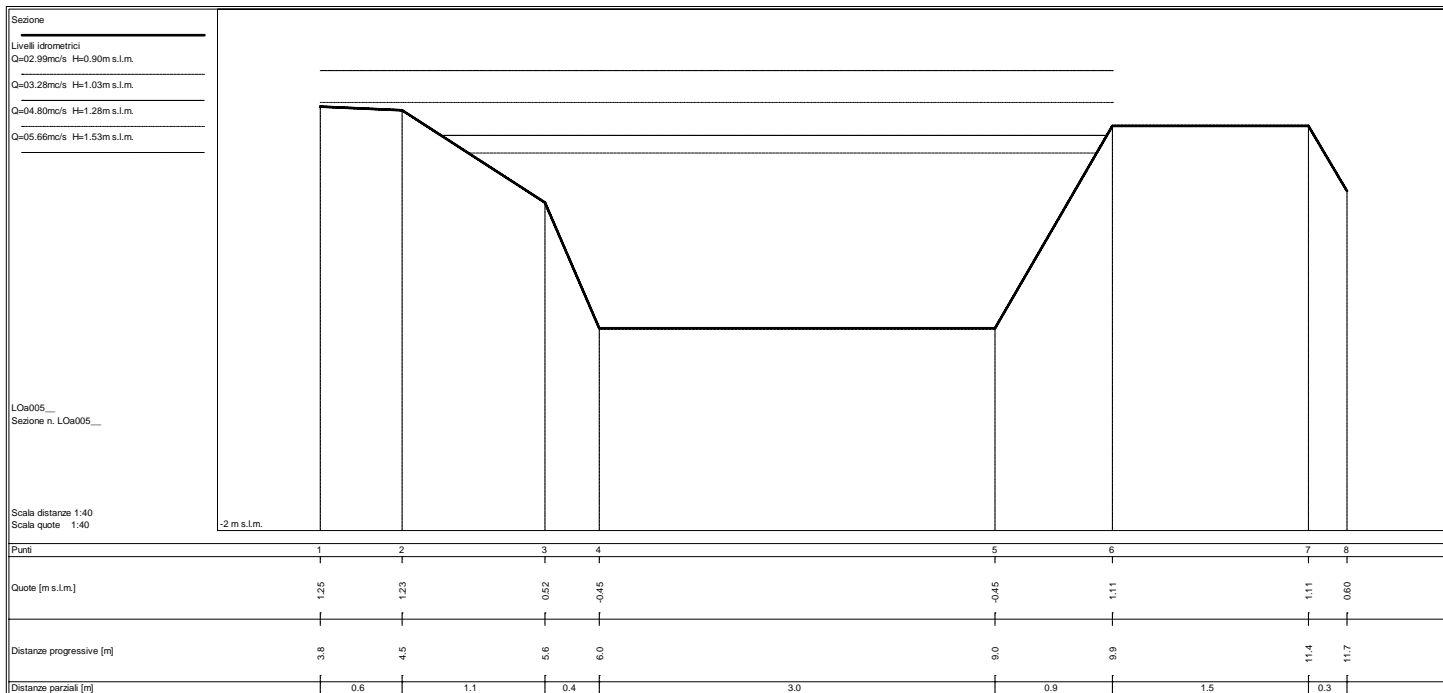

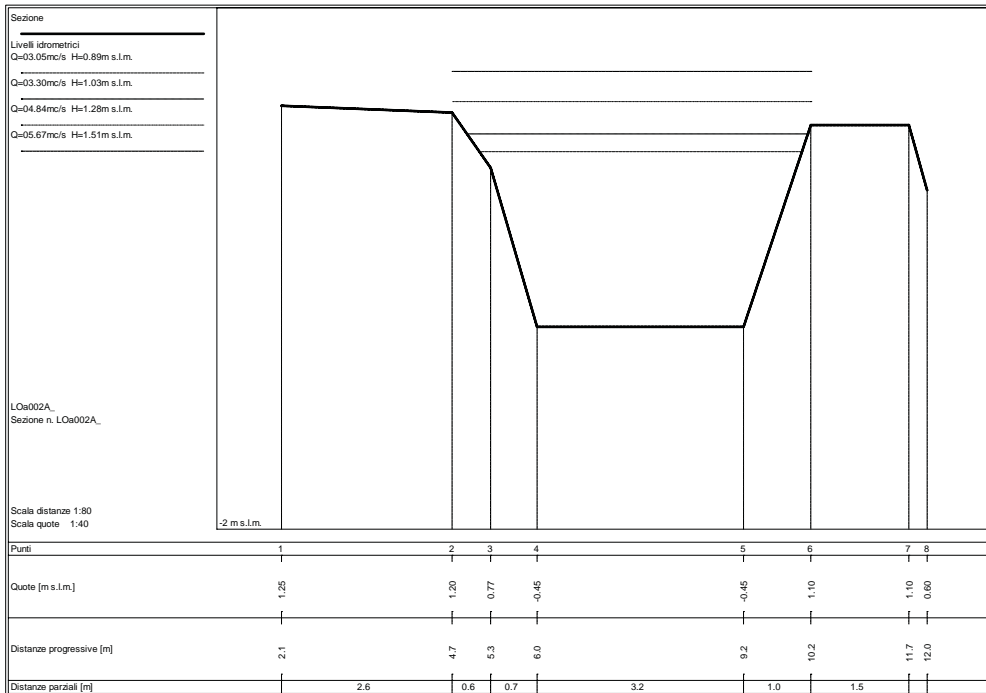
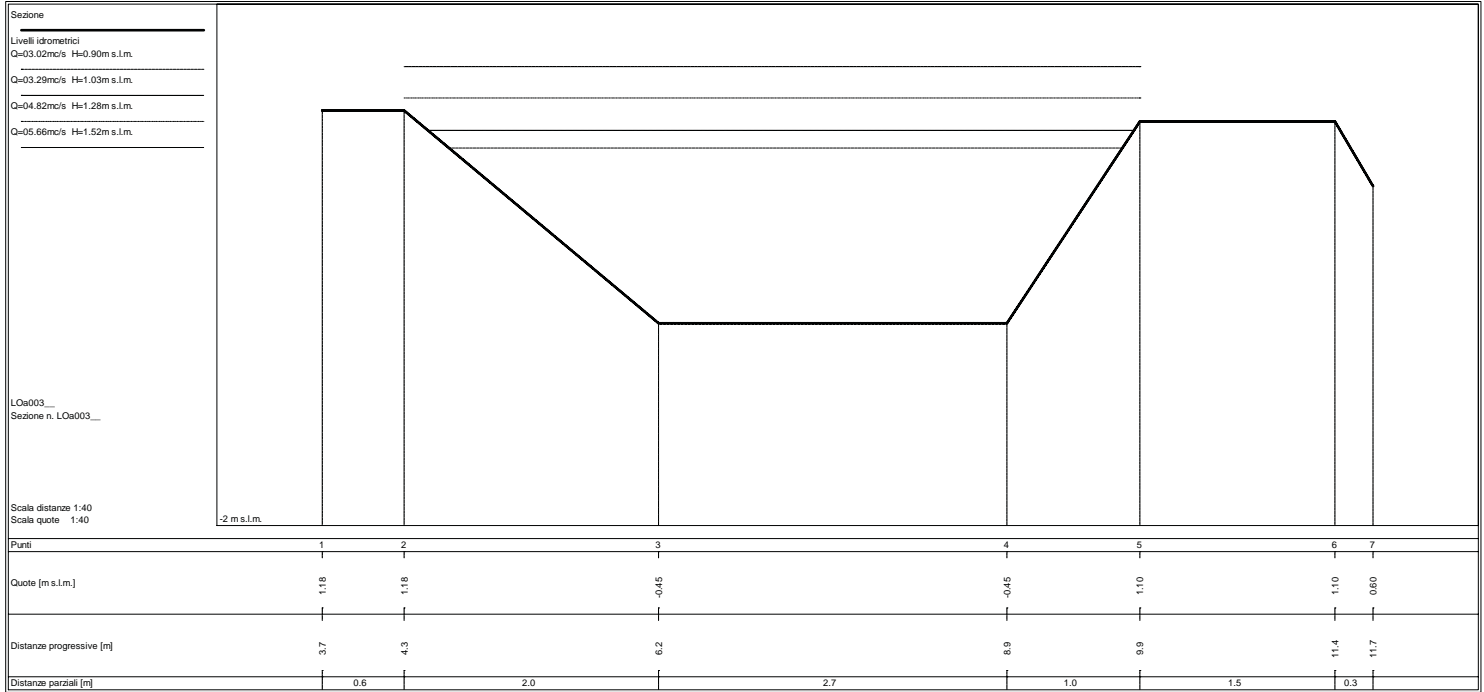

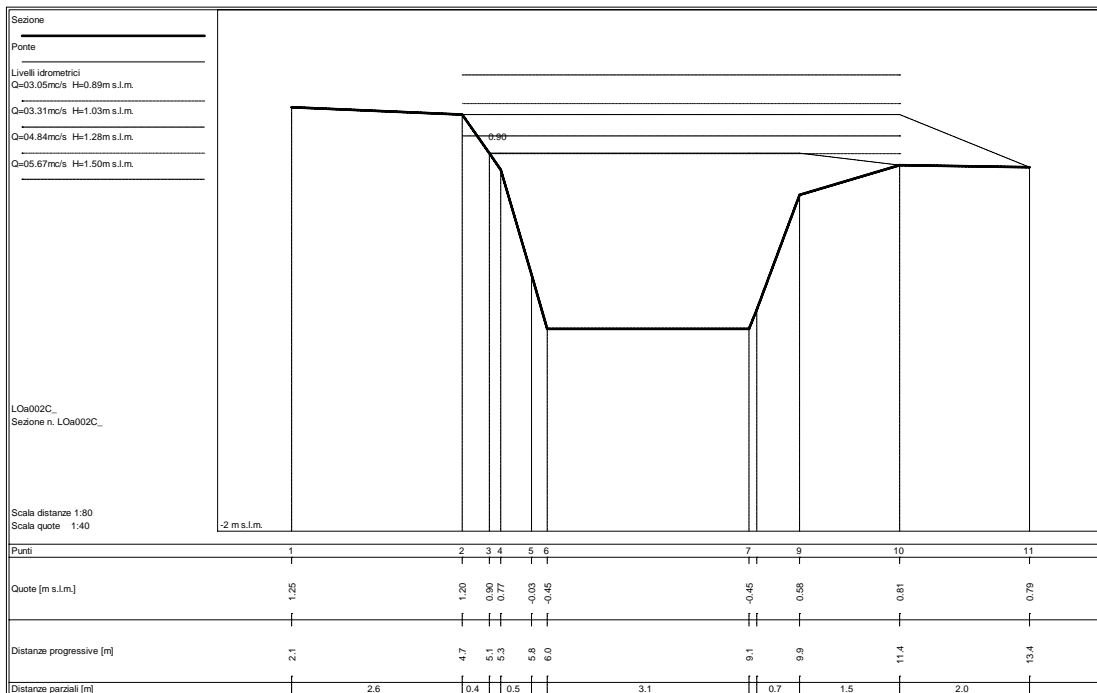
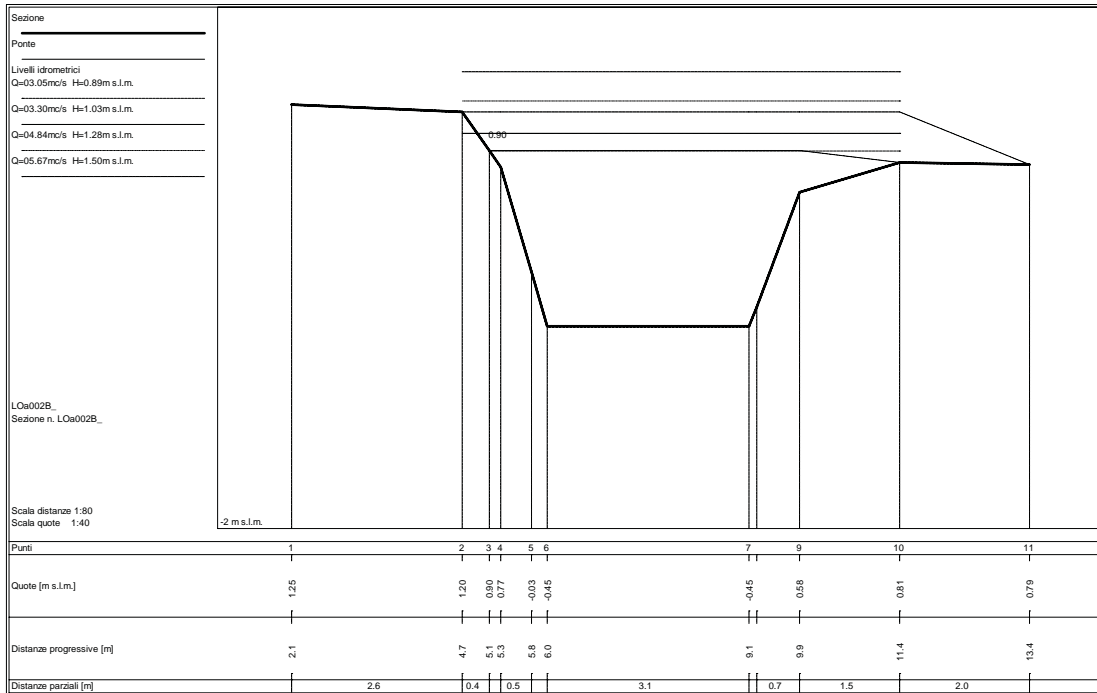

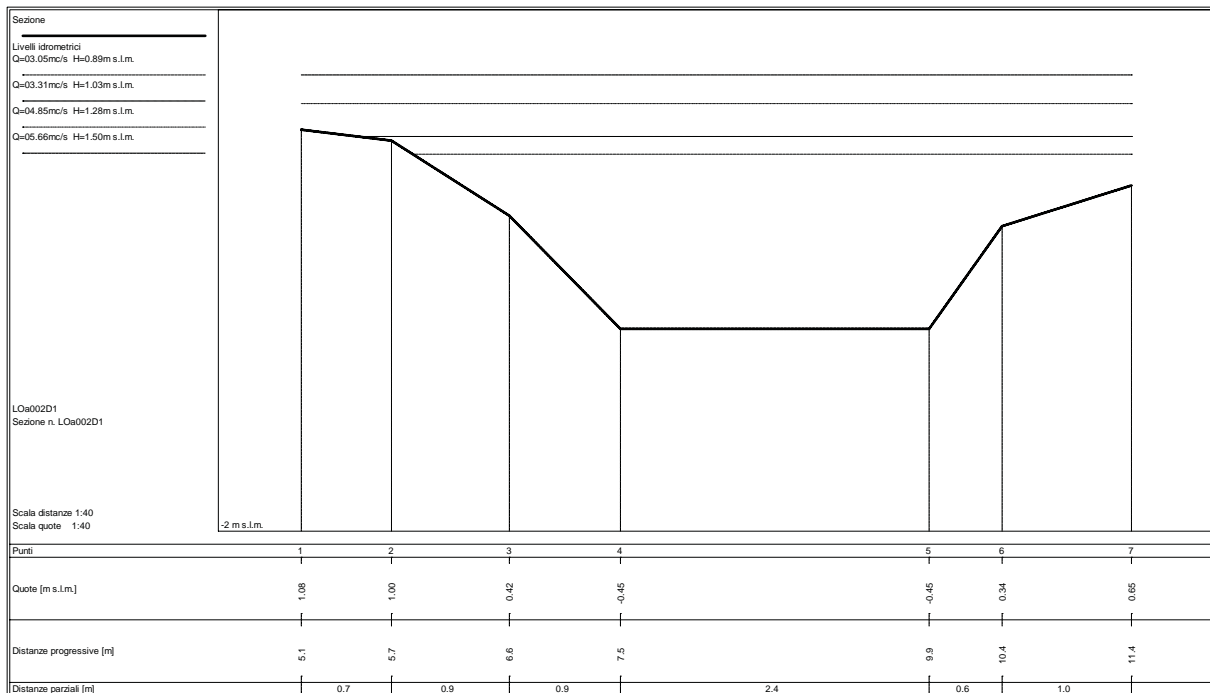
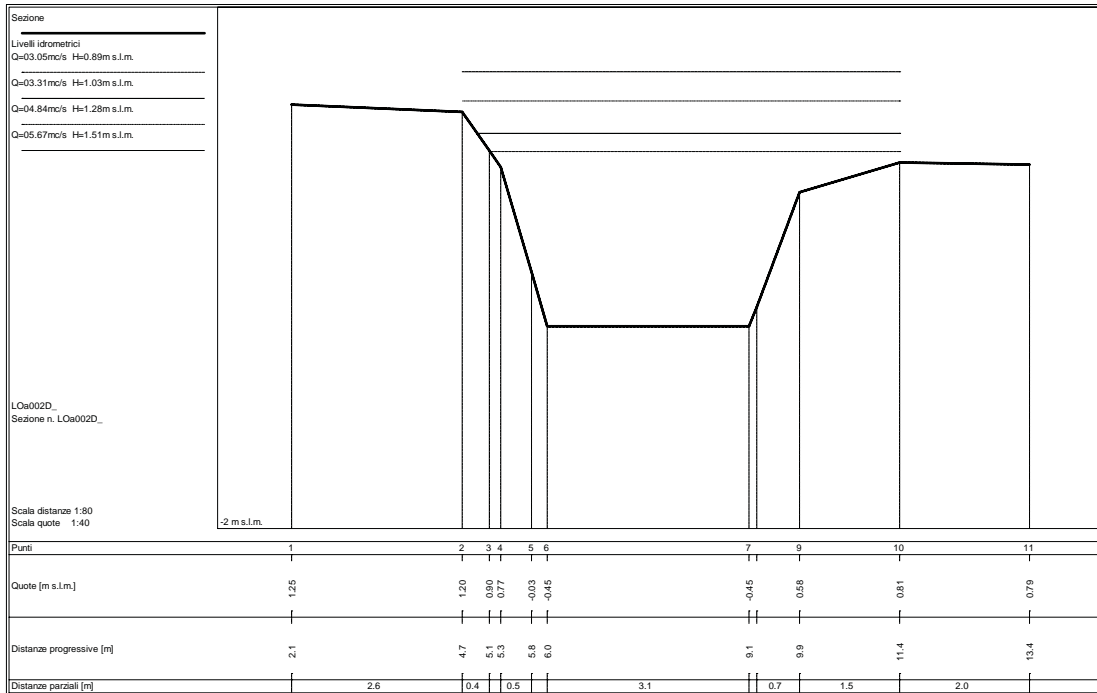

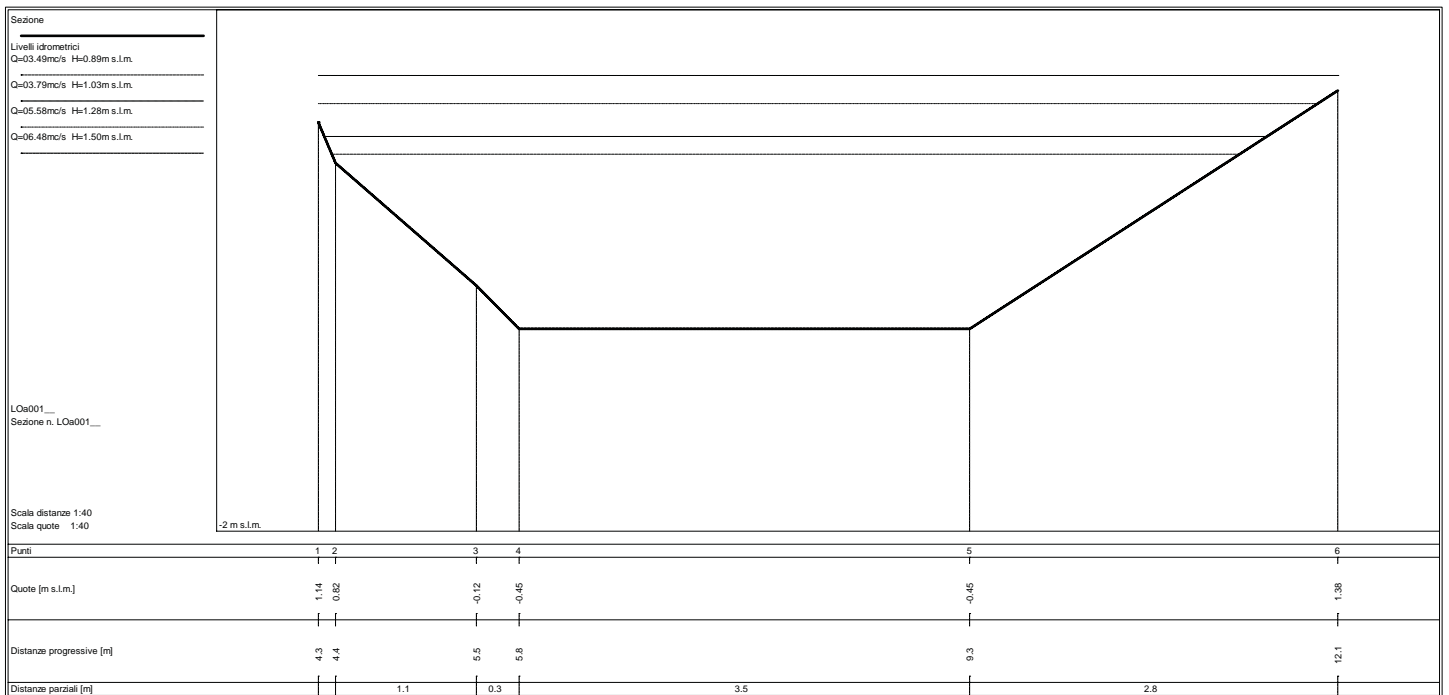
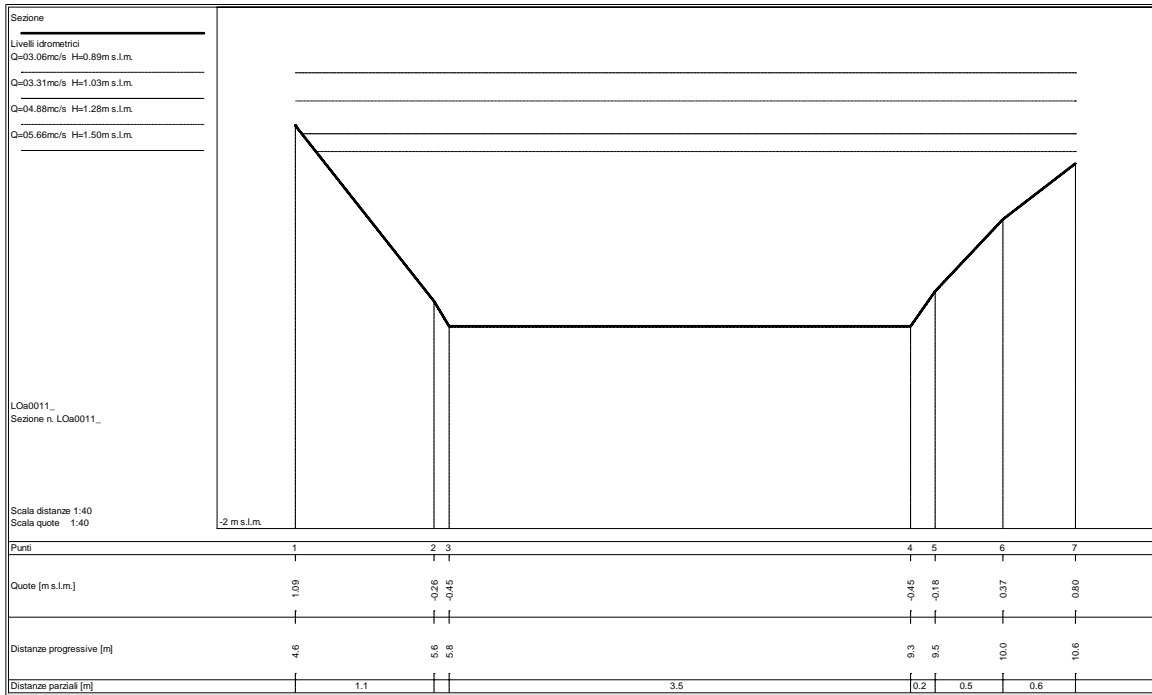

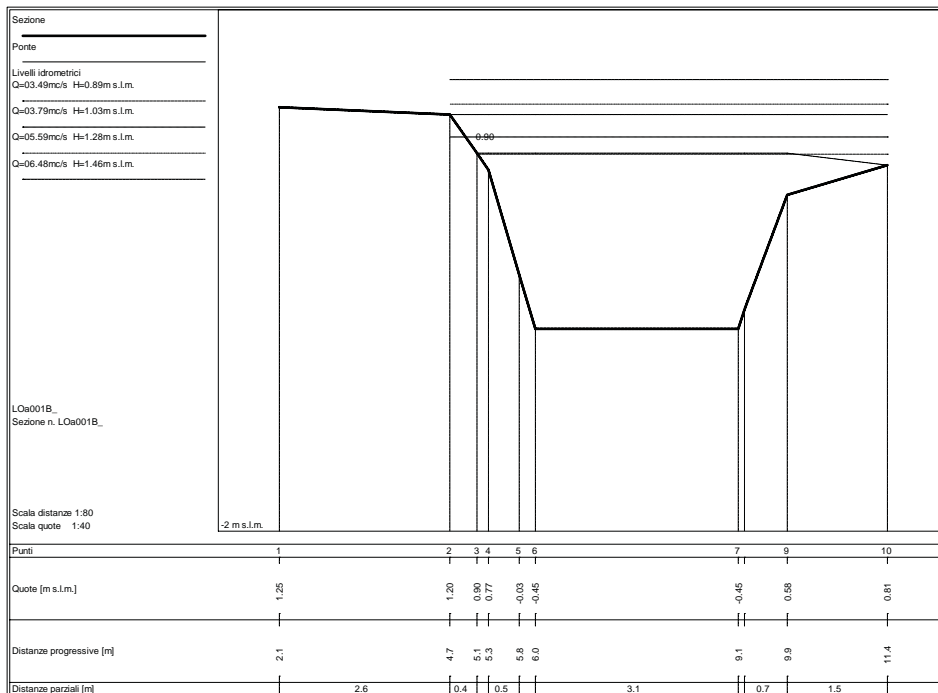
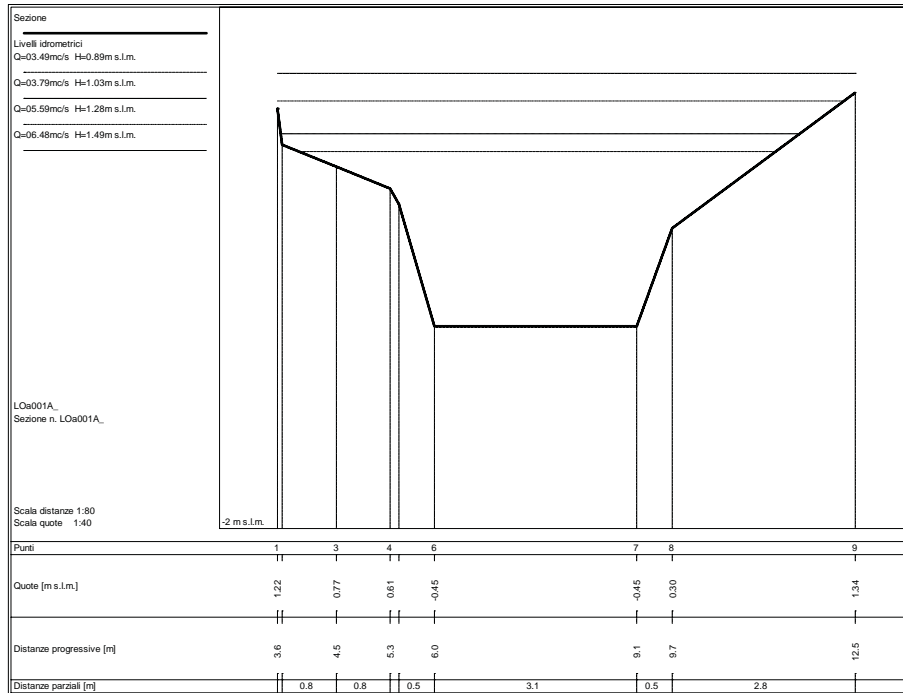

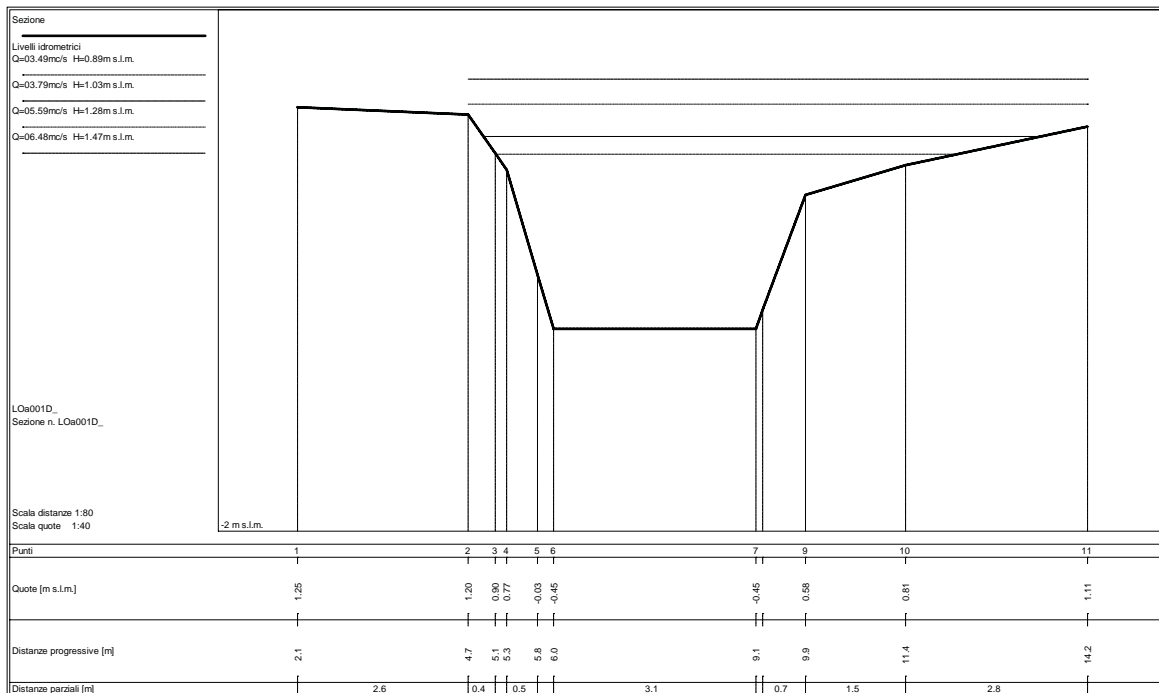
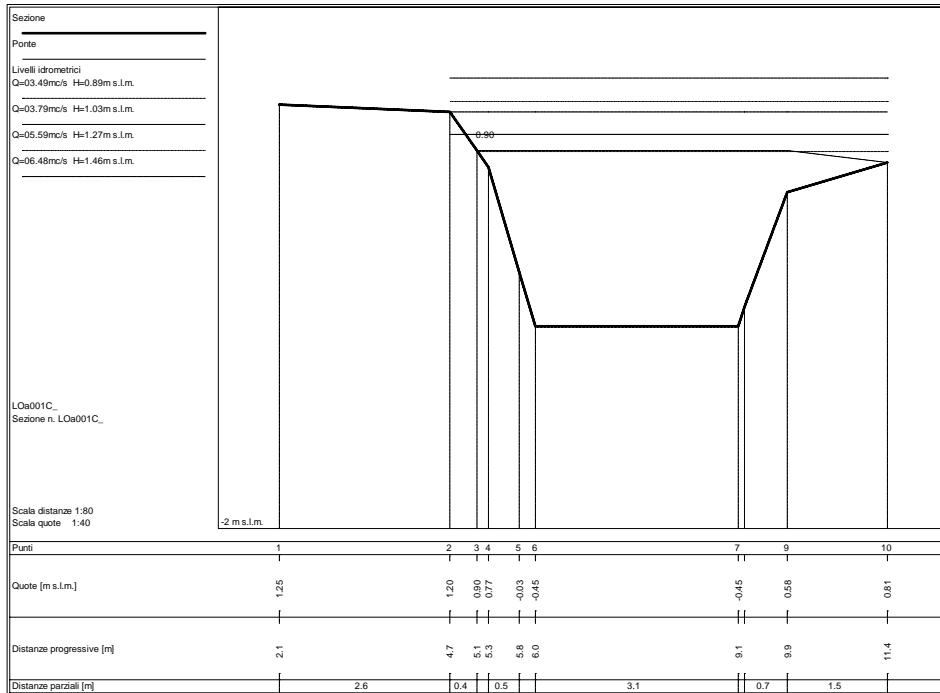

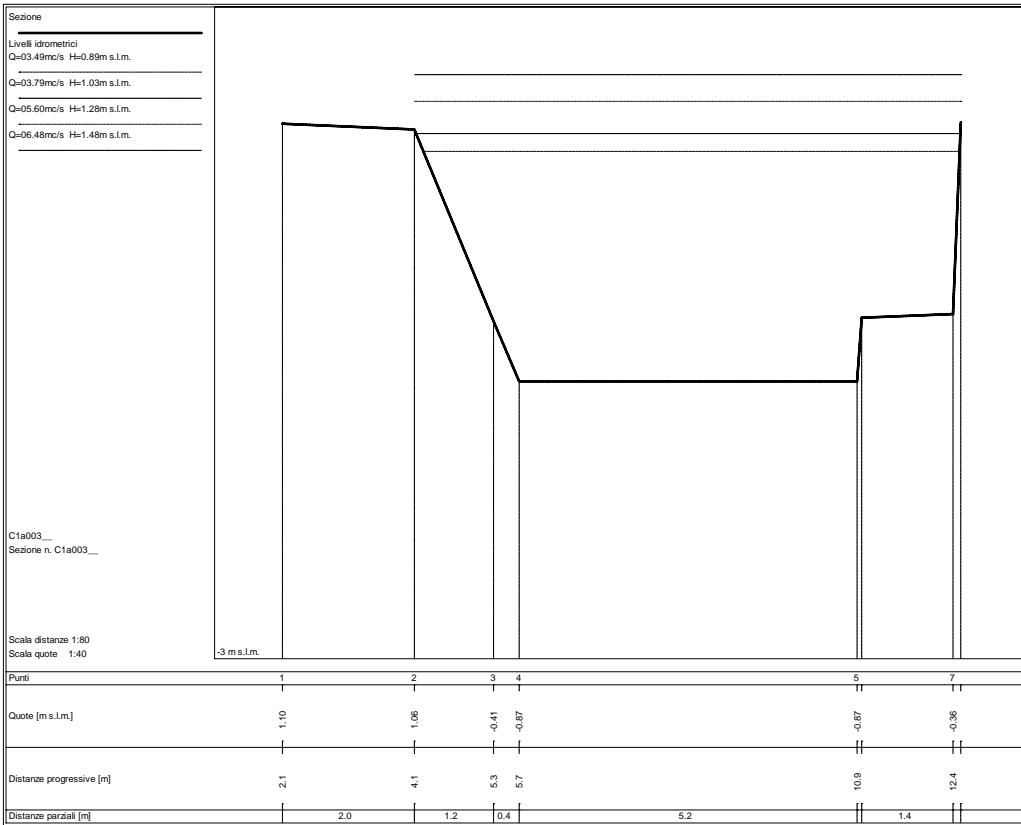

STATO ATTUALE

Sezioni fluviali fosso di Mezzo – ME_a_P

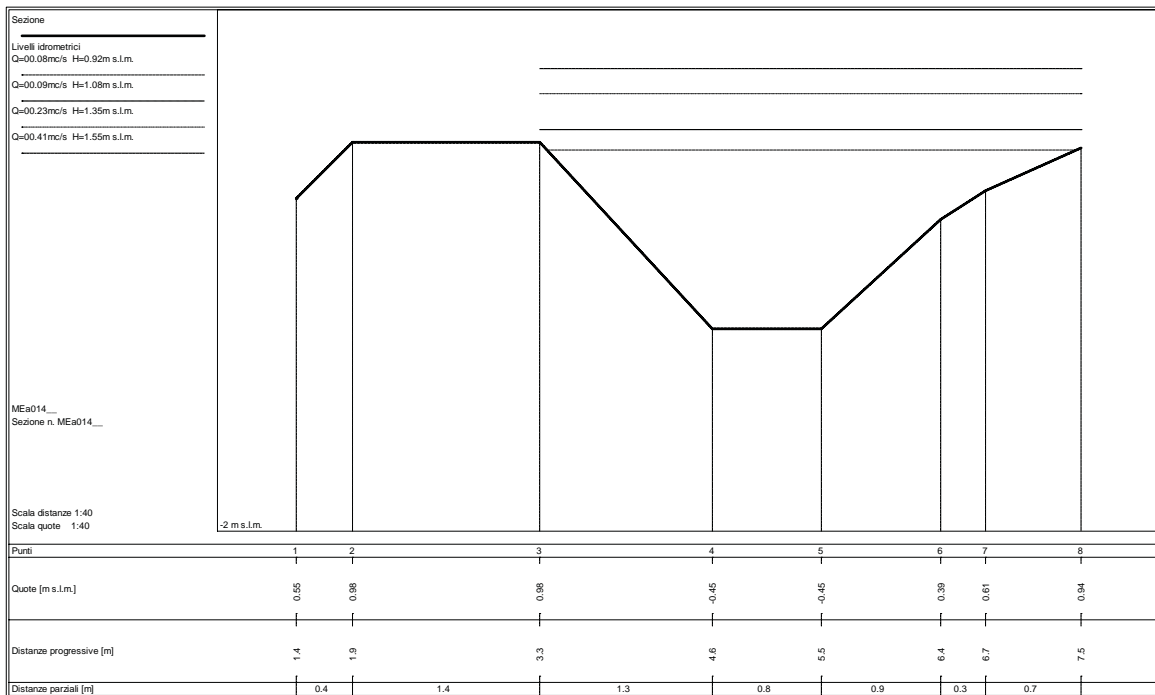
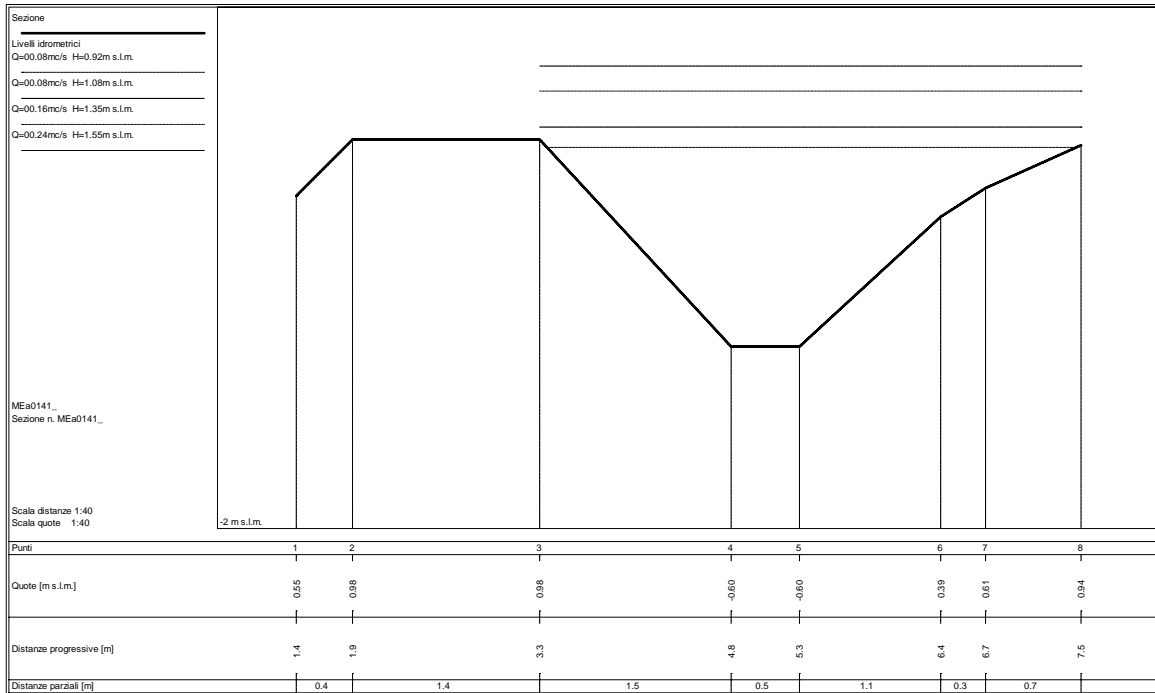

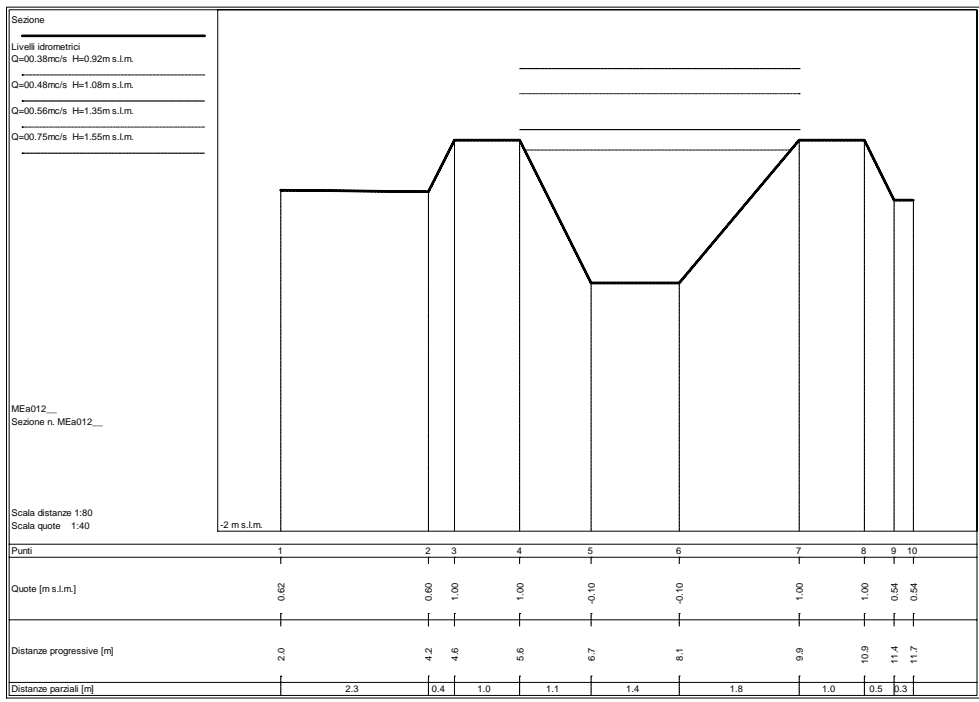
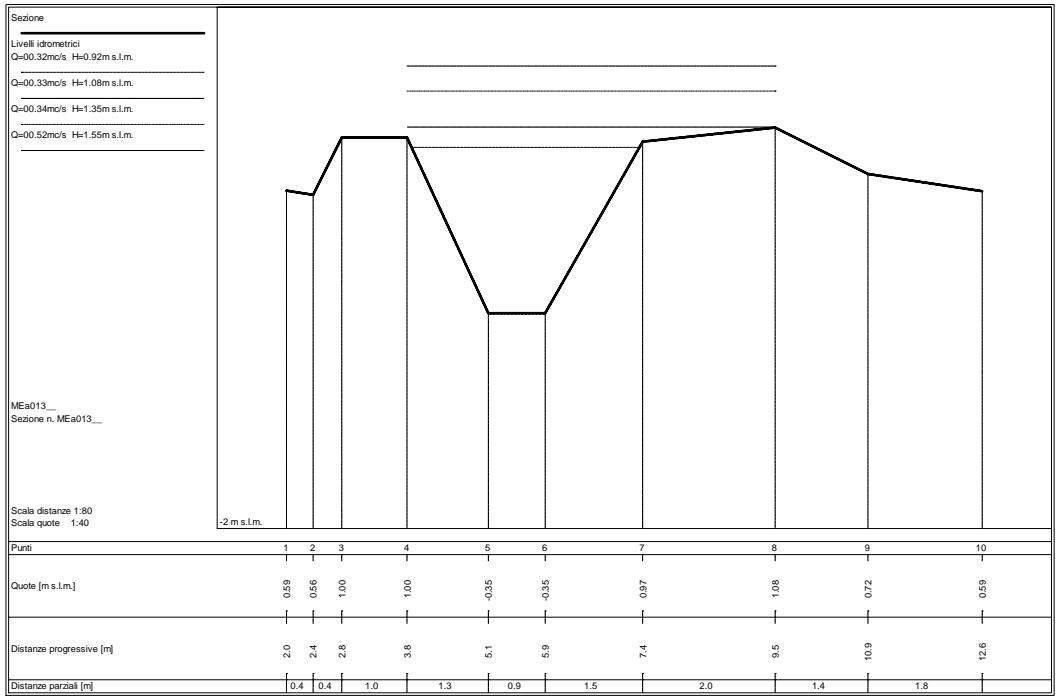

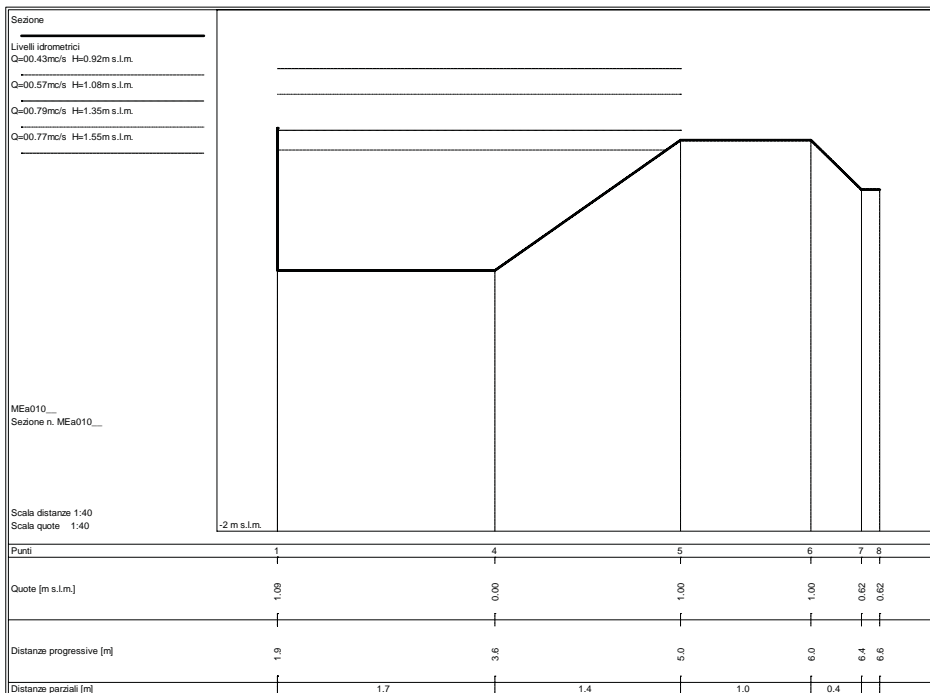
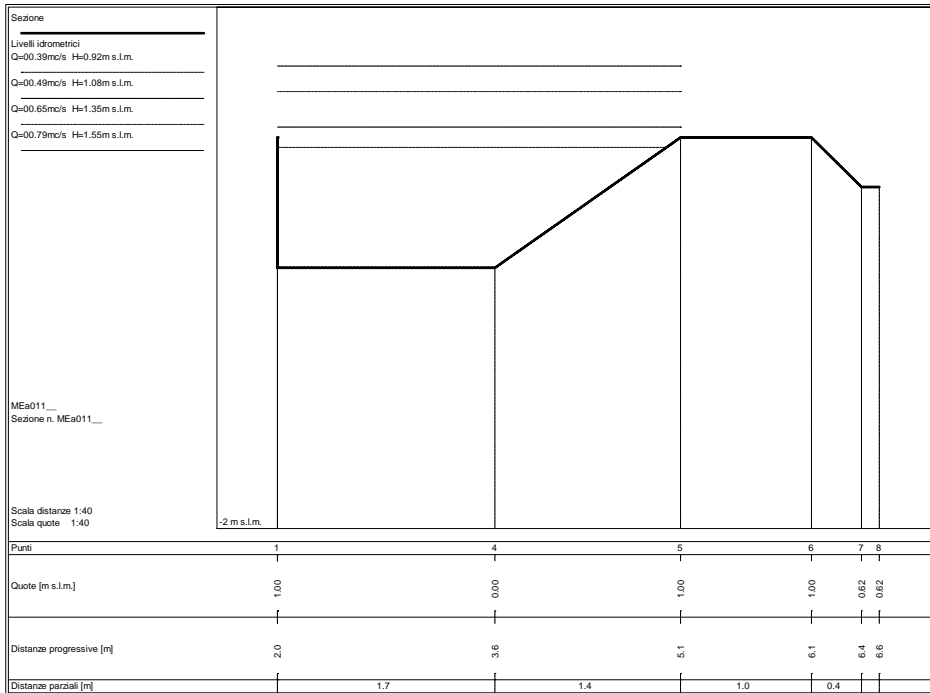

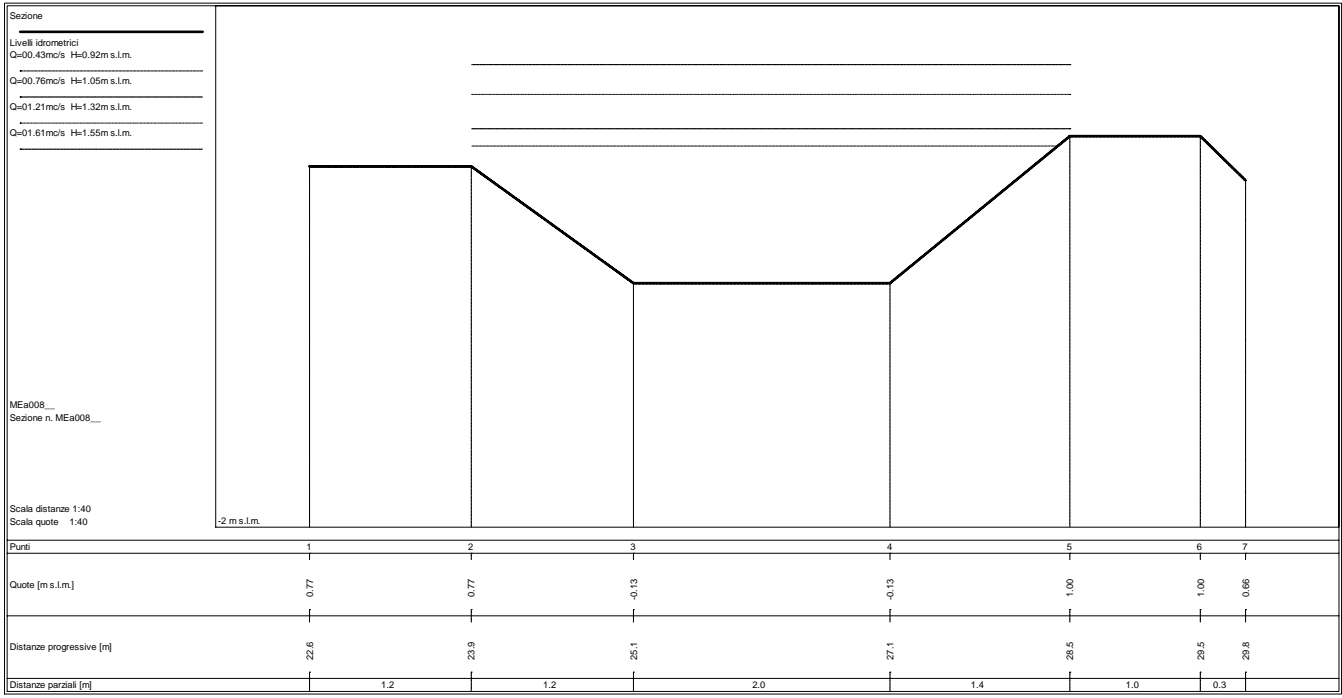
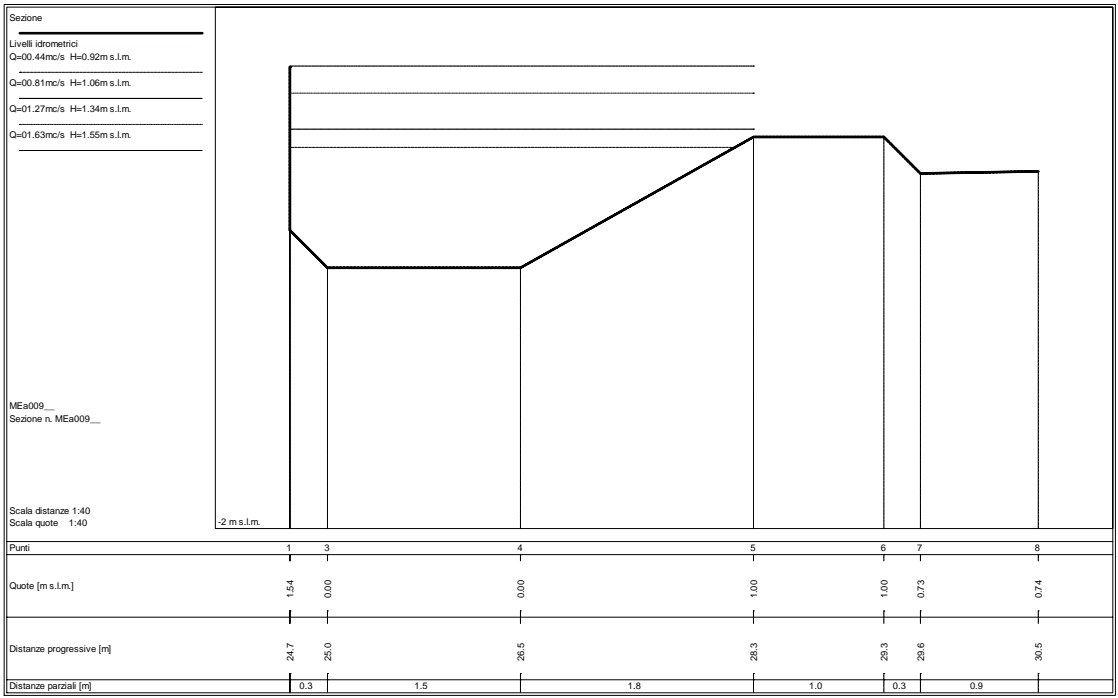

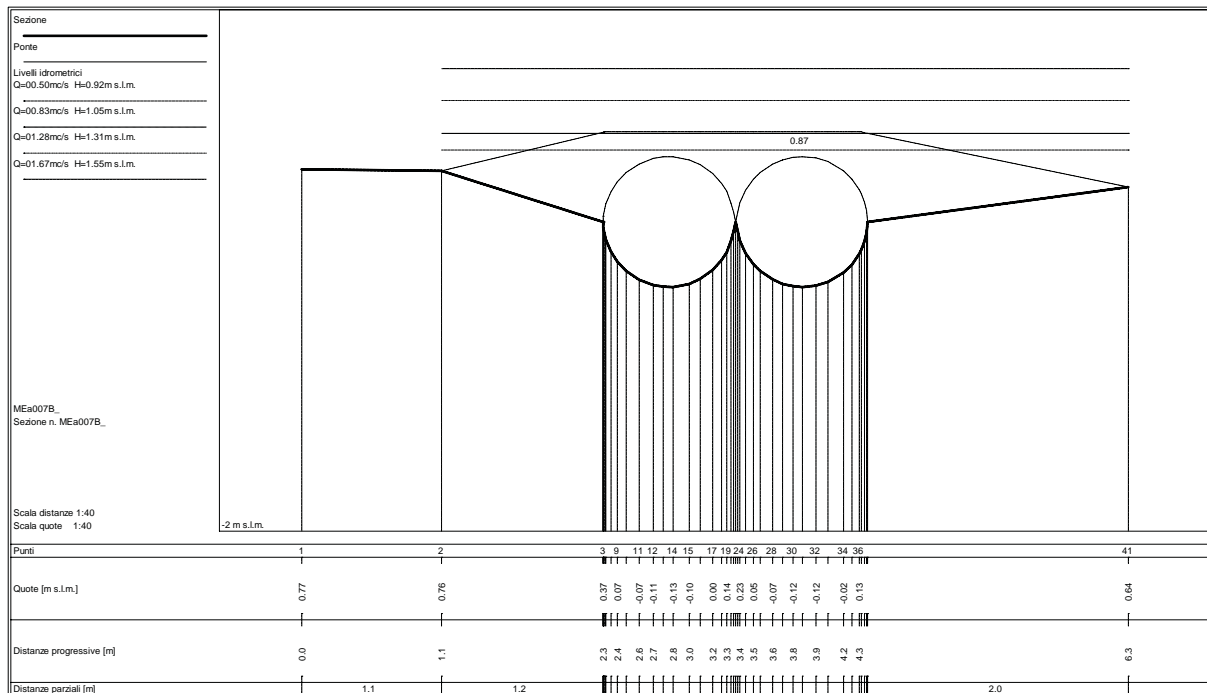
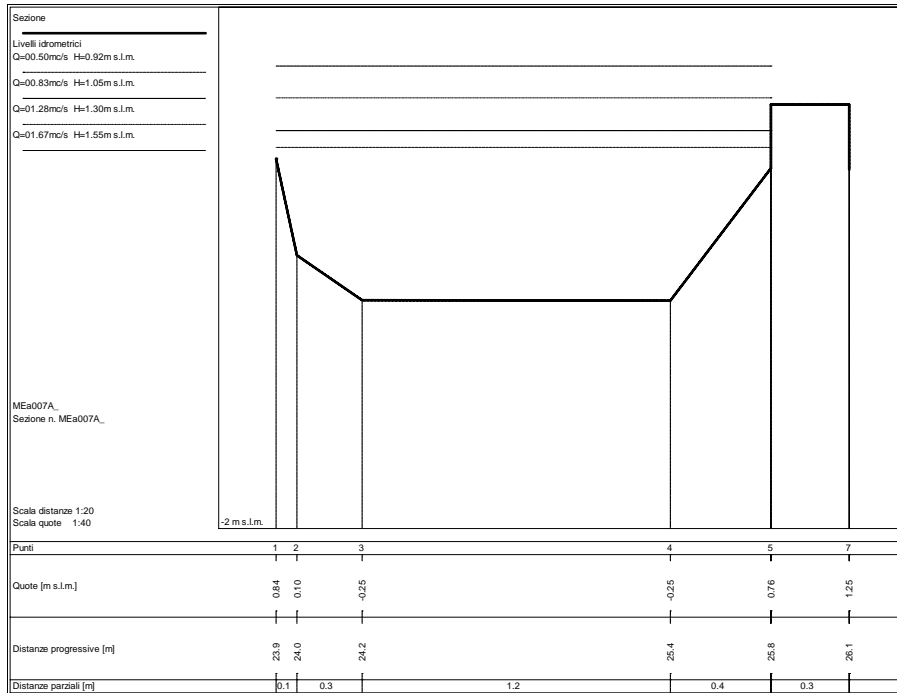

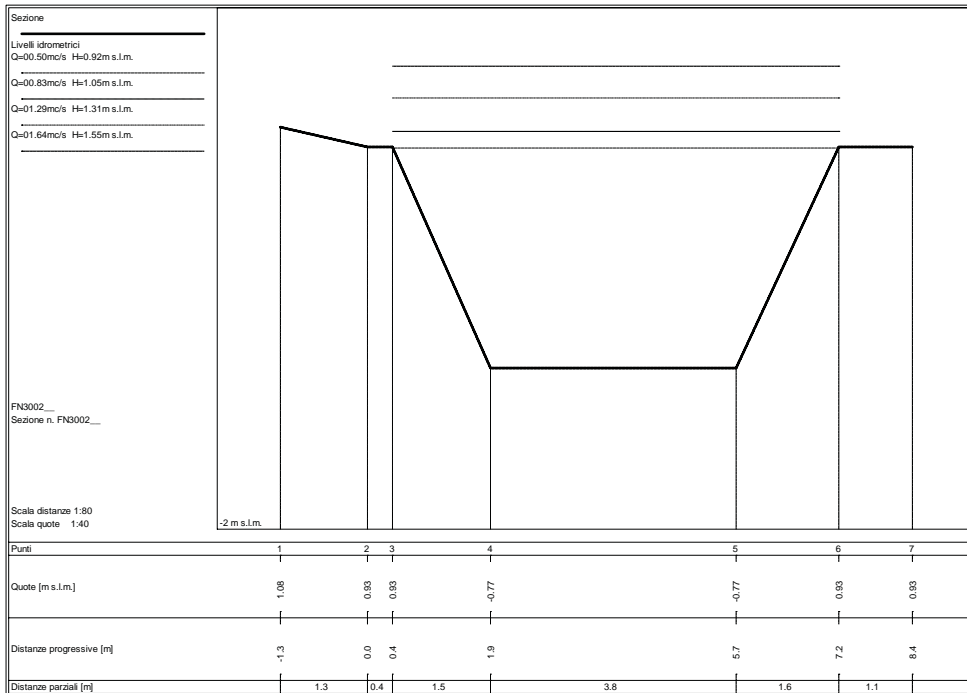
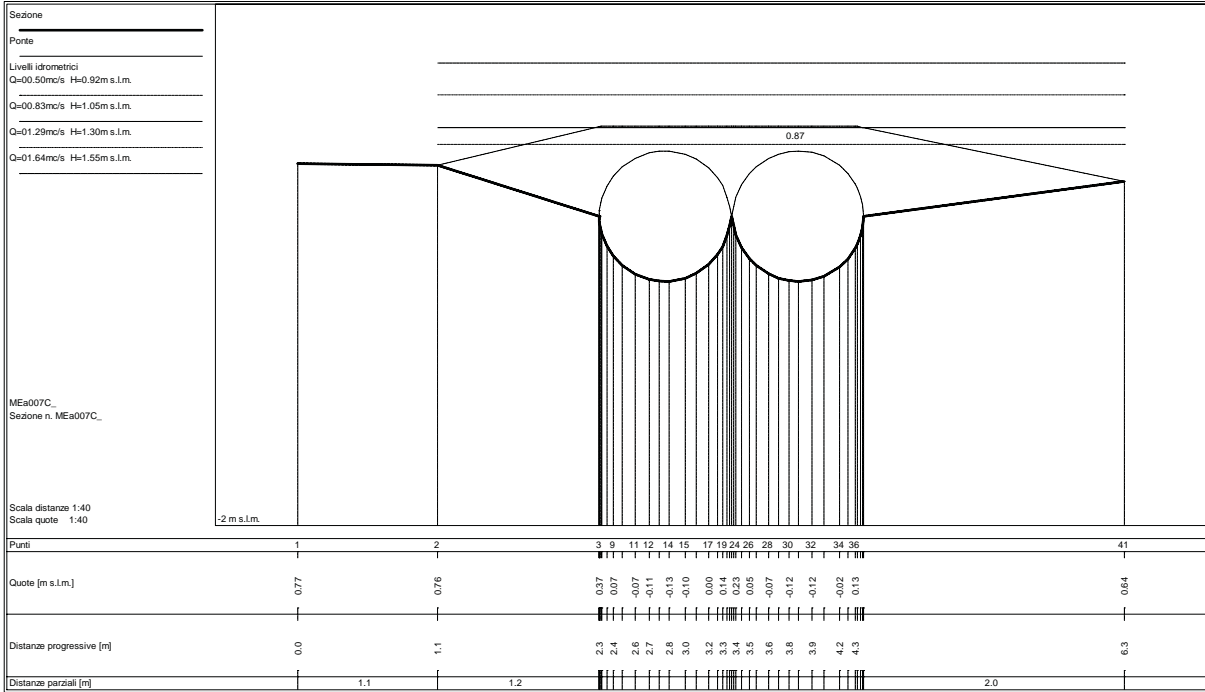

STATO ATTUALE

Sezioni fluviali fosso di Mezzo – ME_b_P

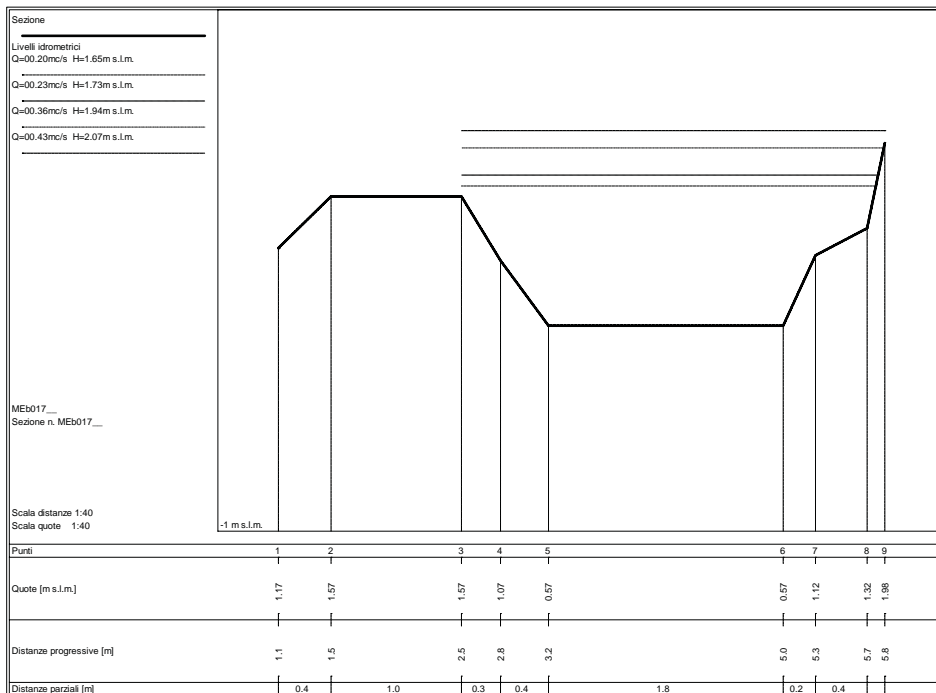
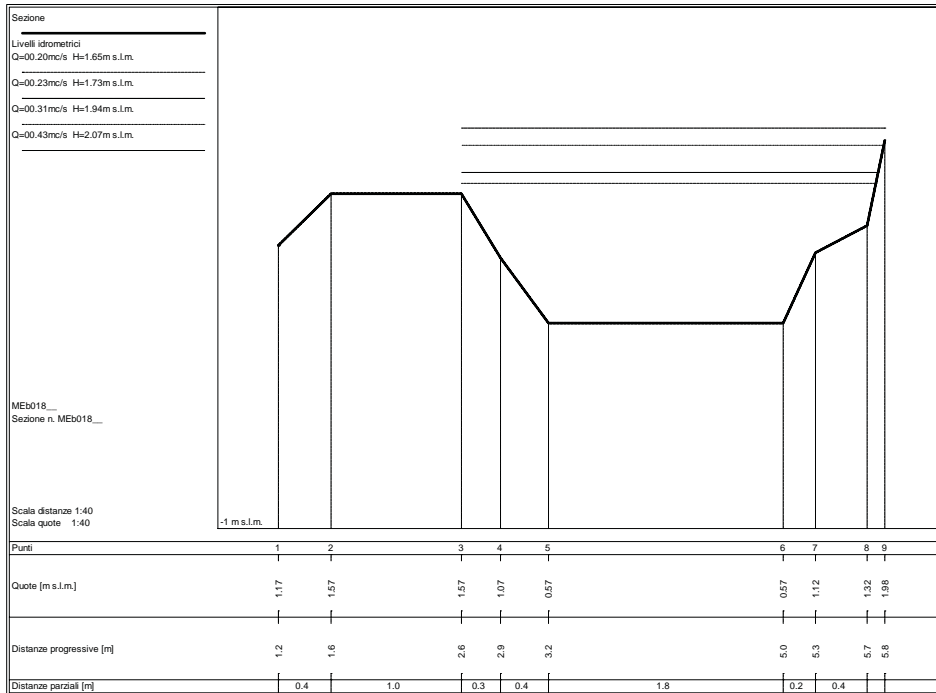

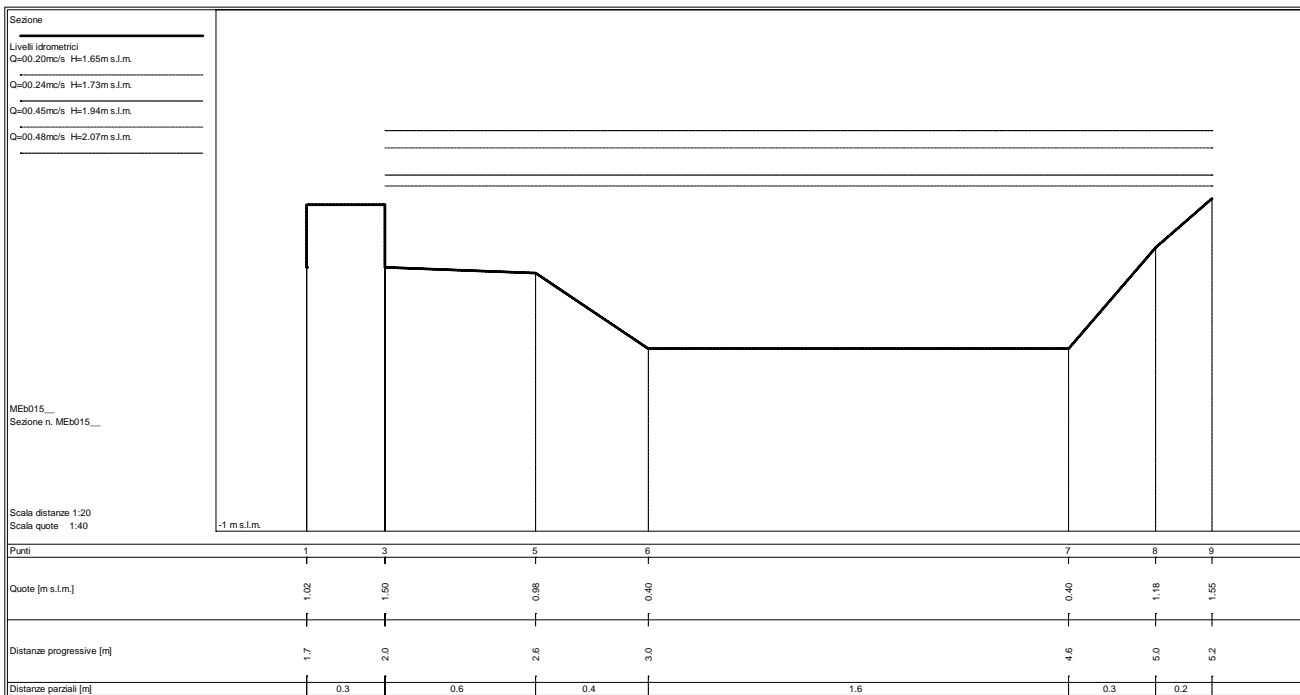
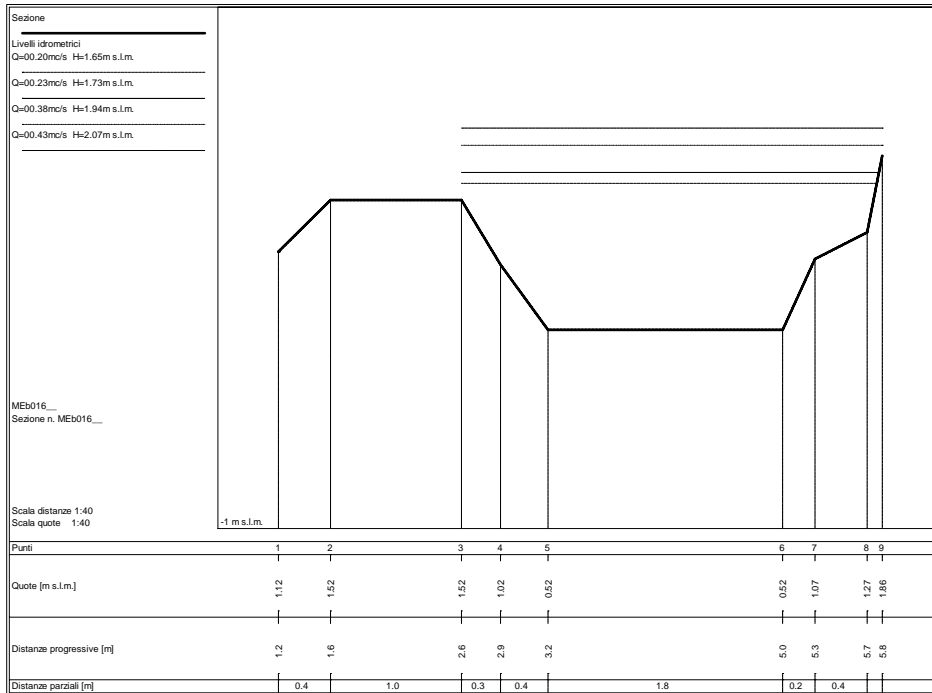

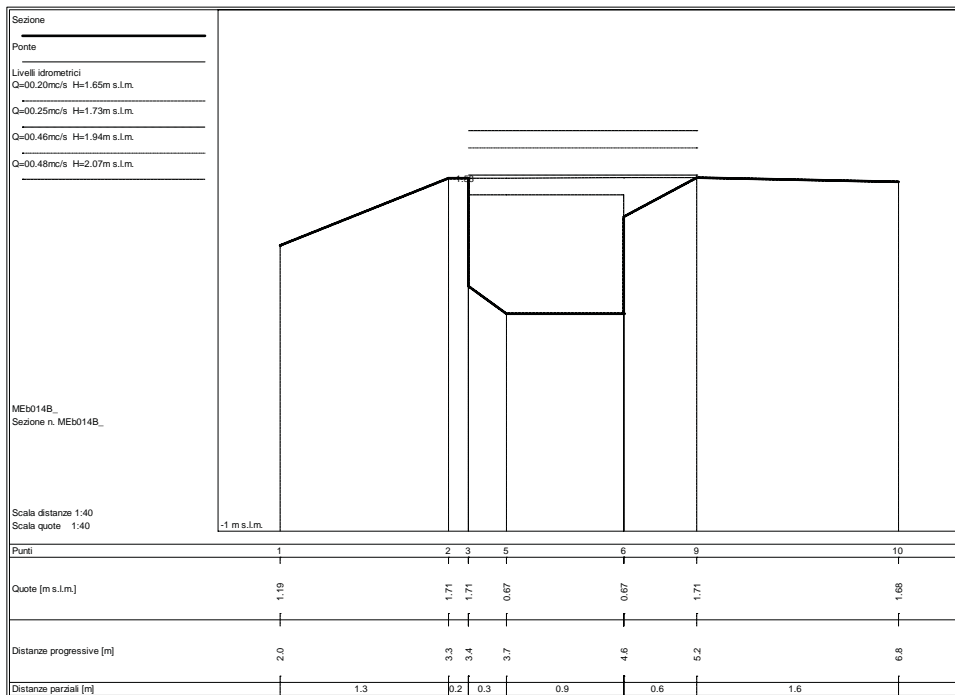
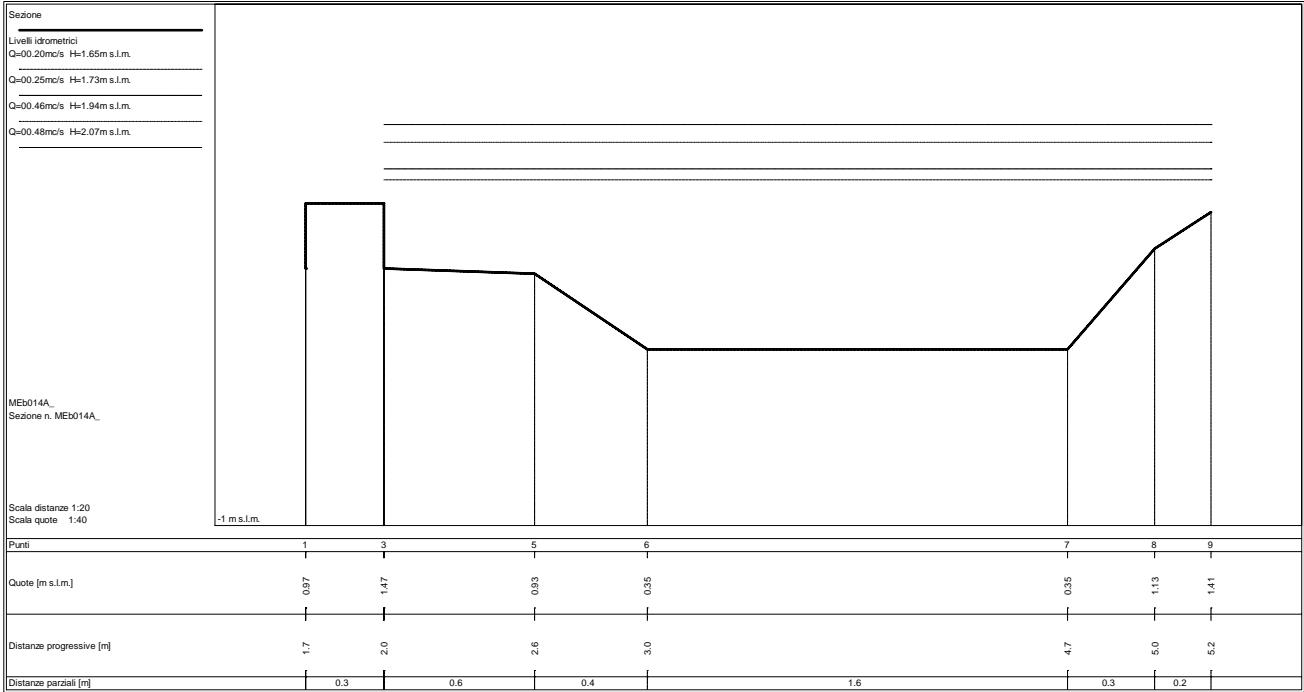

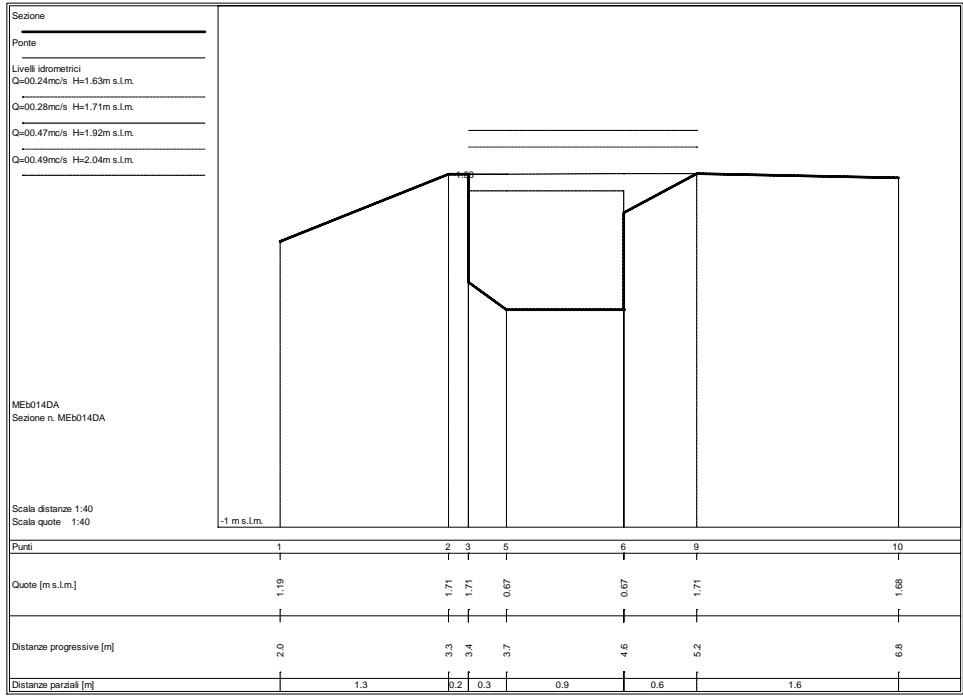
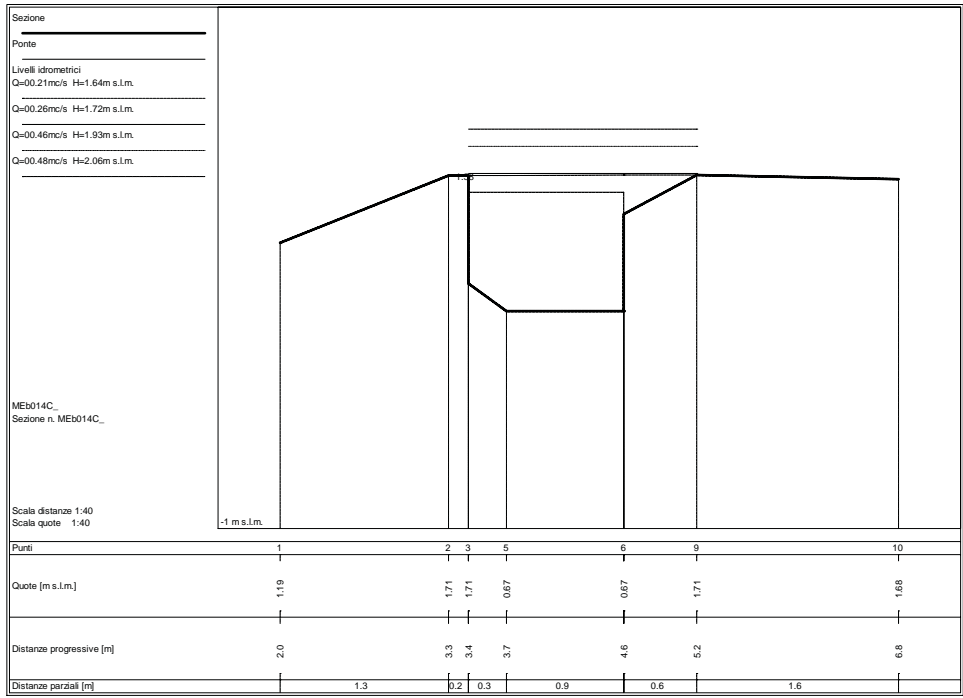

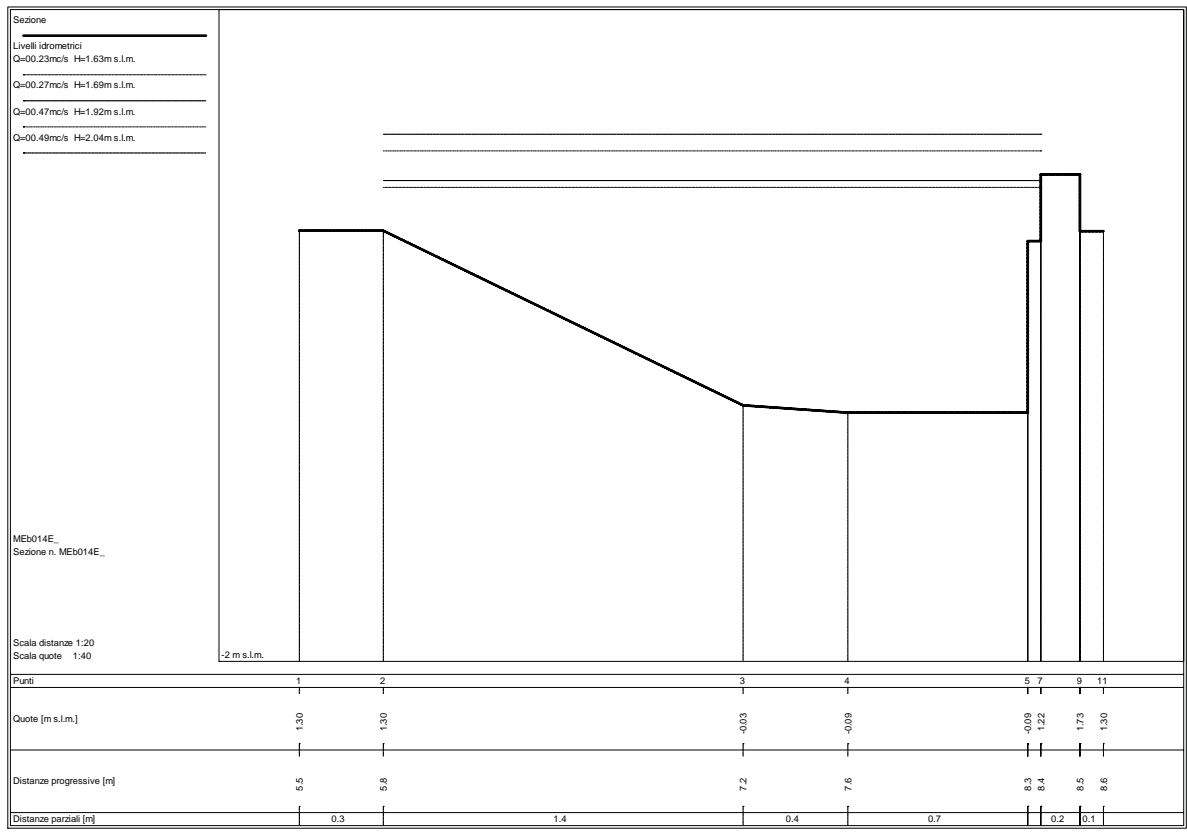
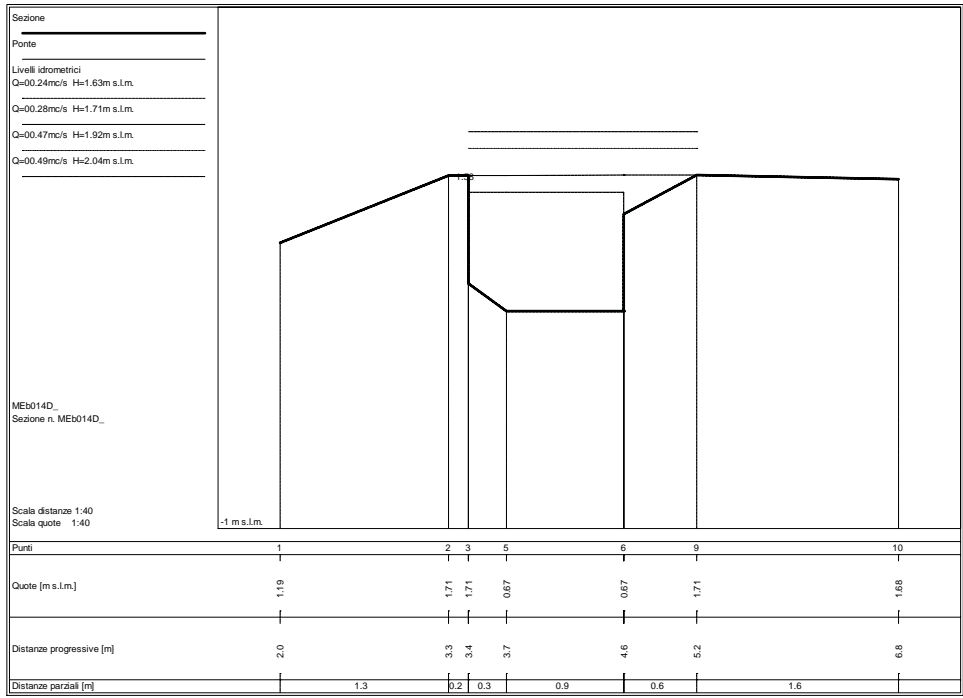

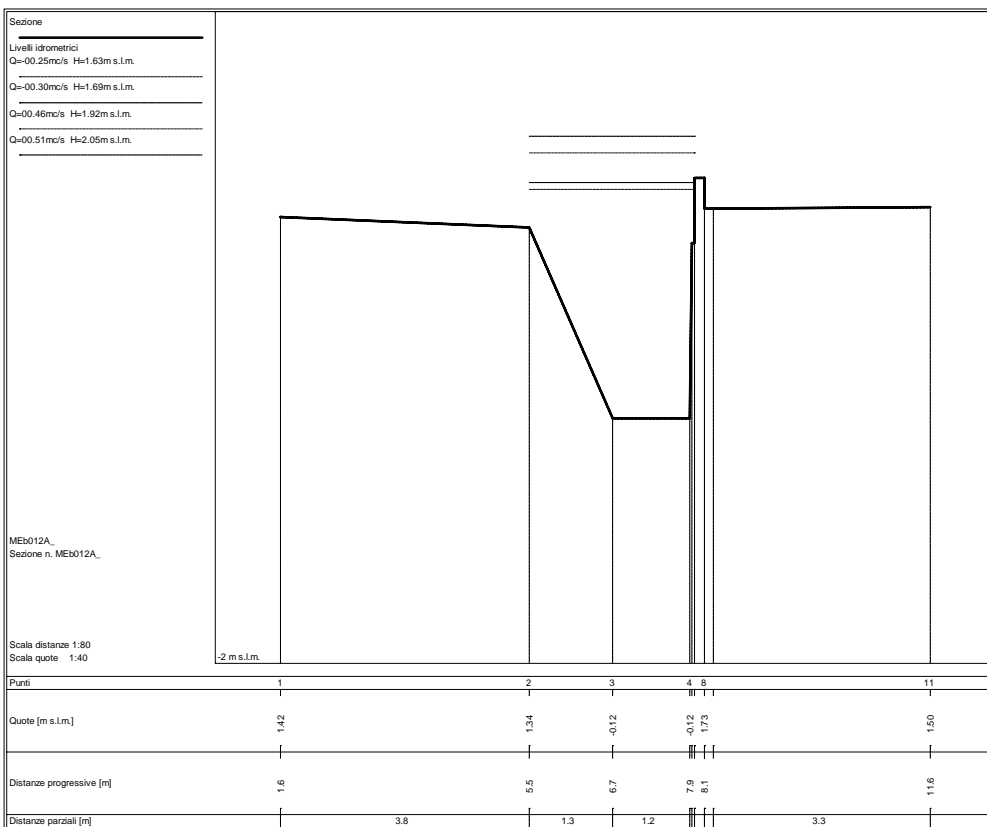
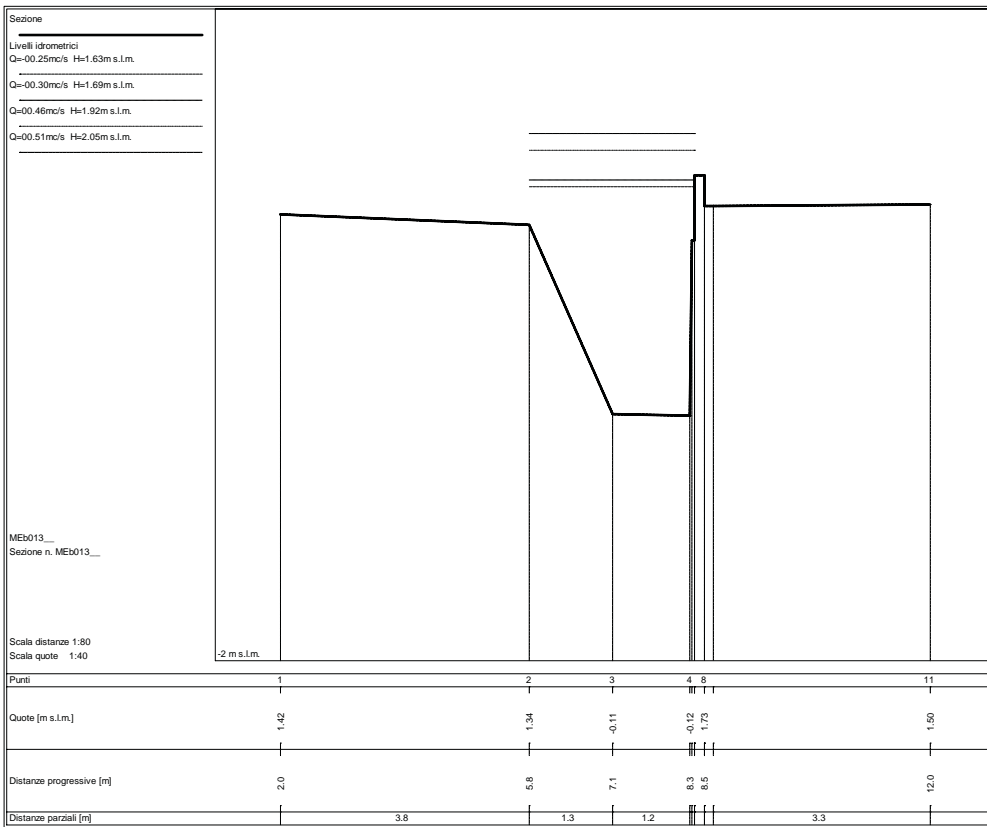

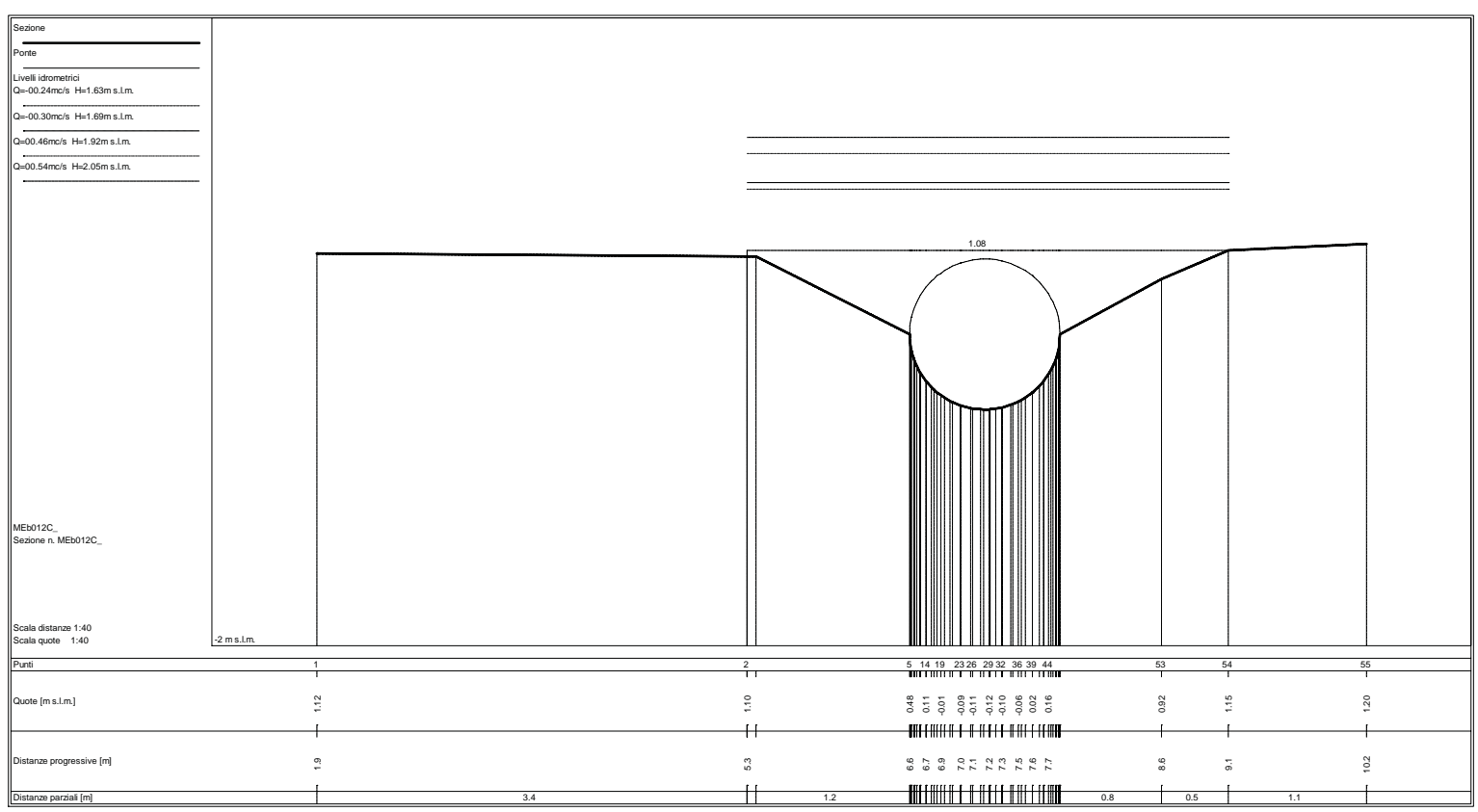
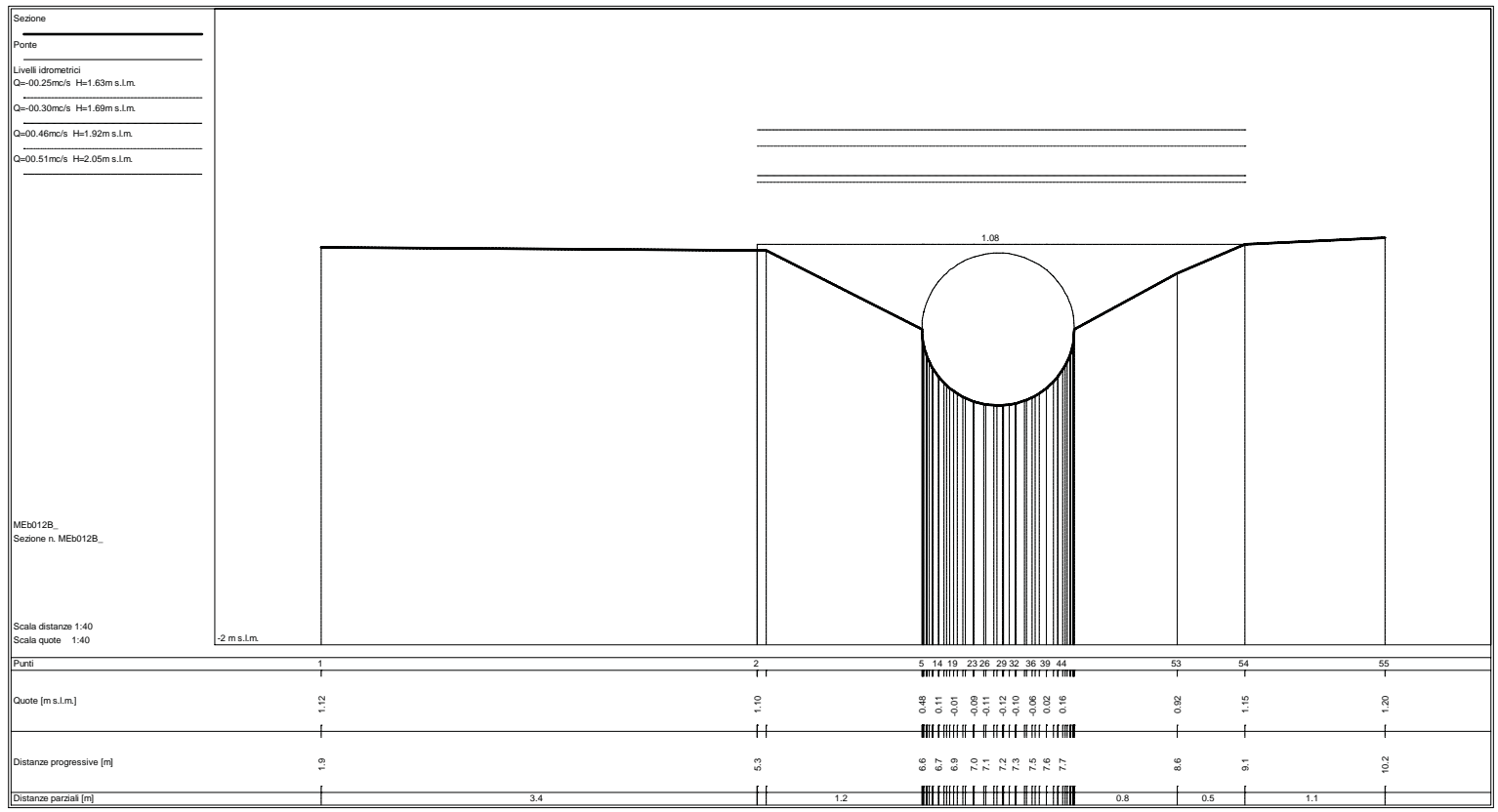

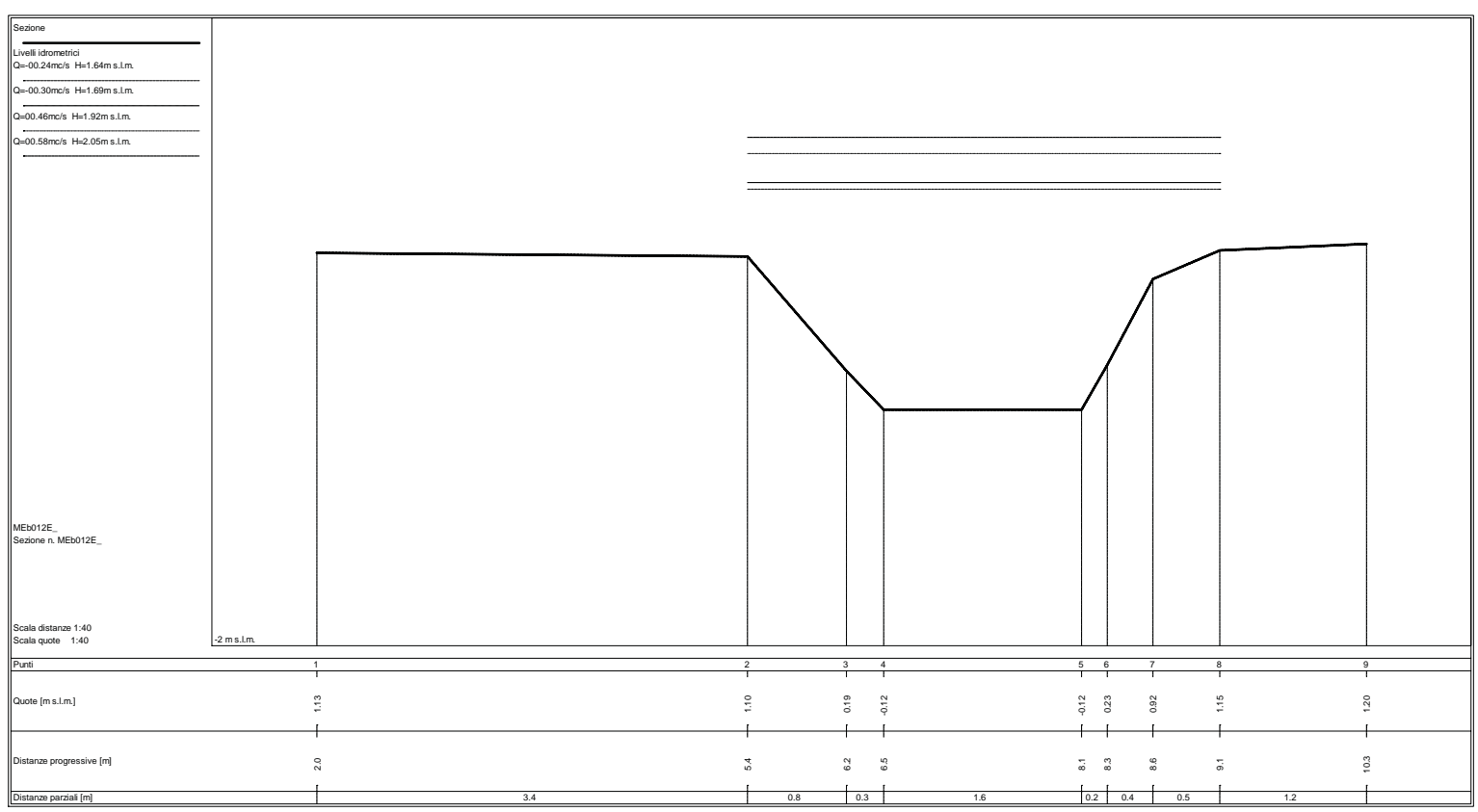
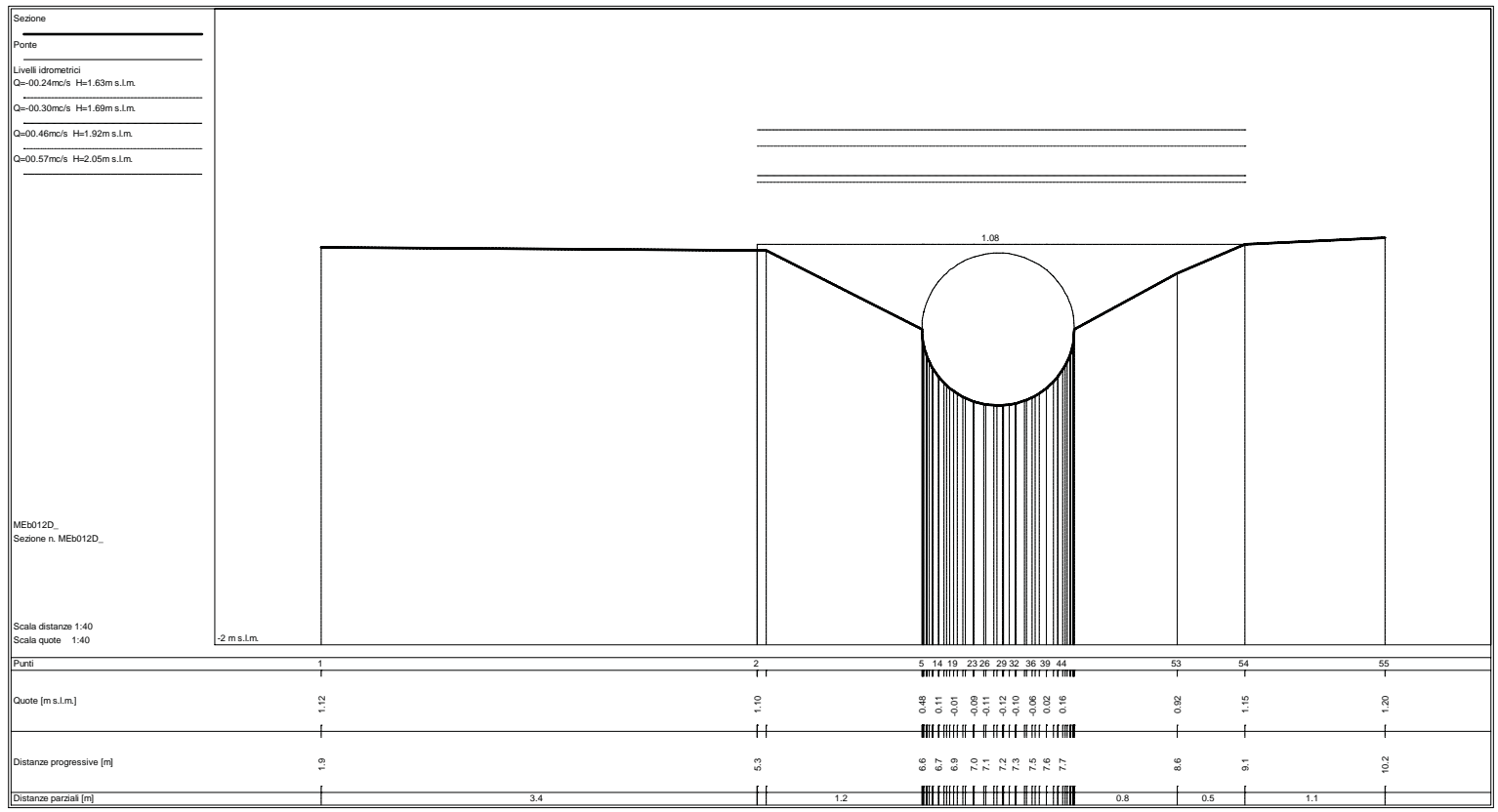

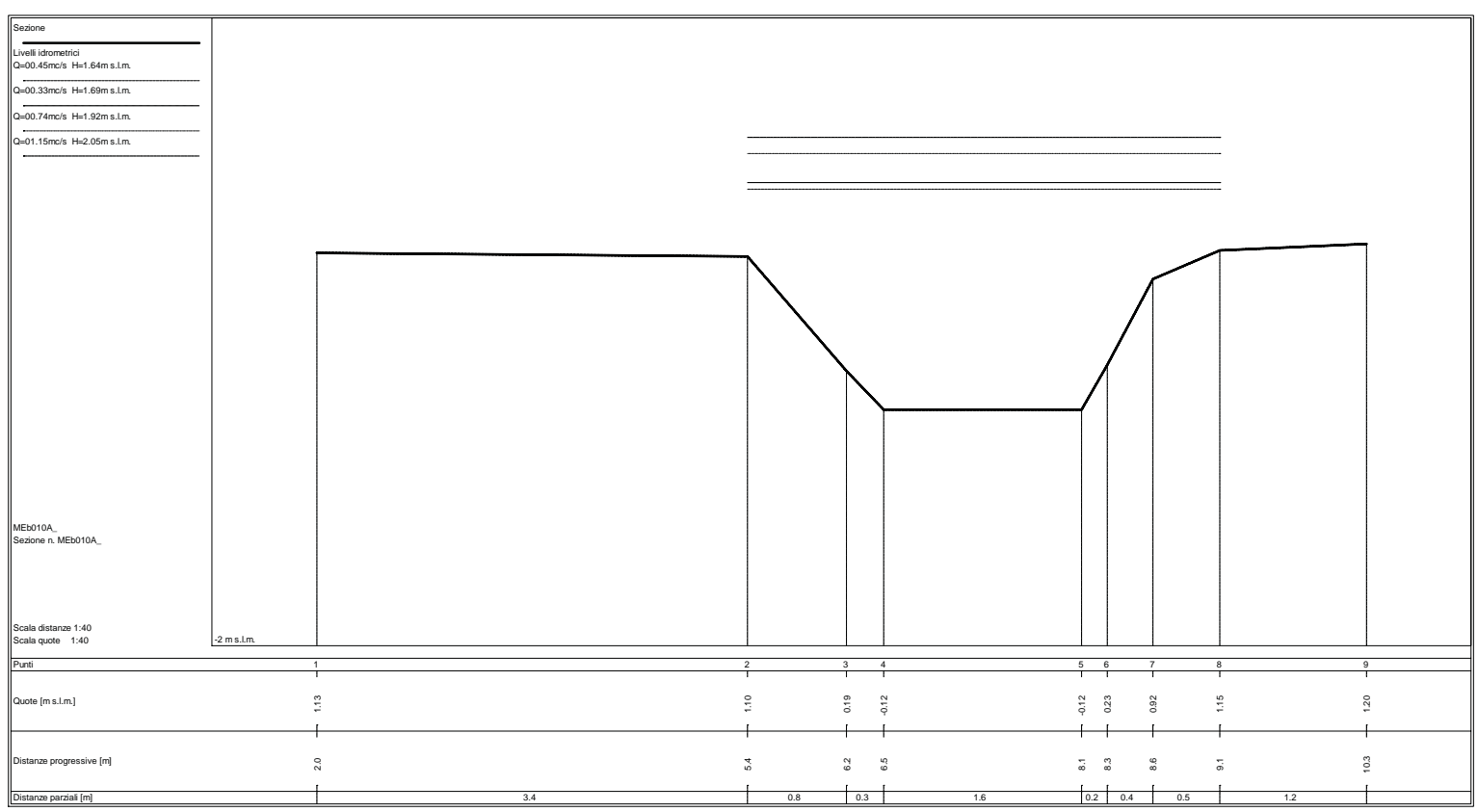
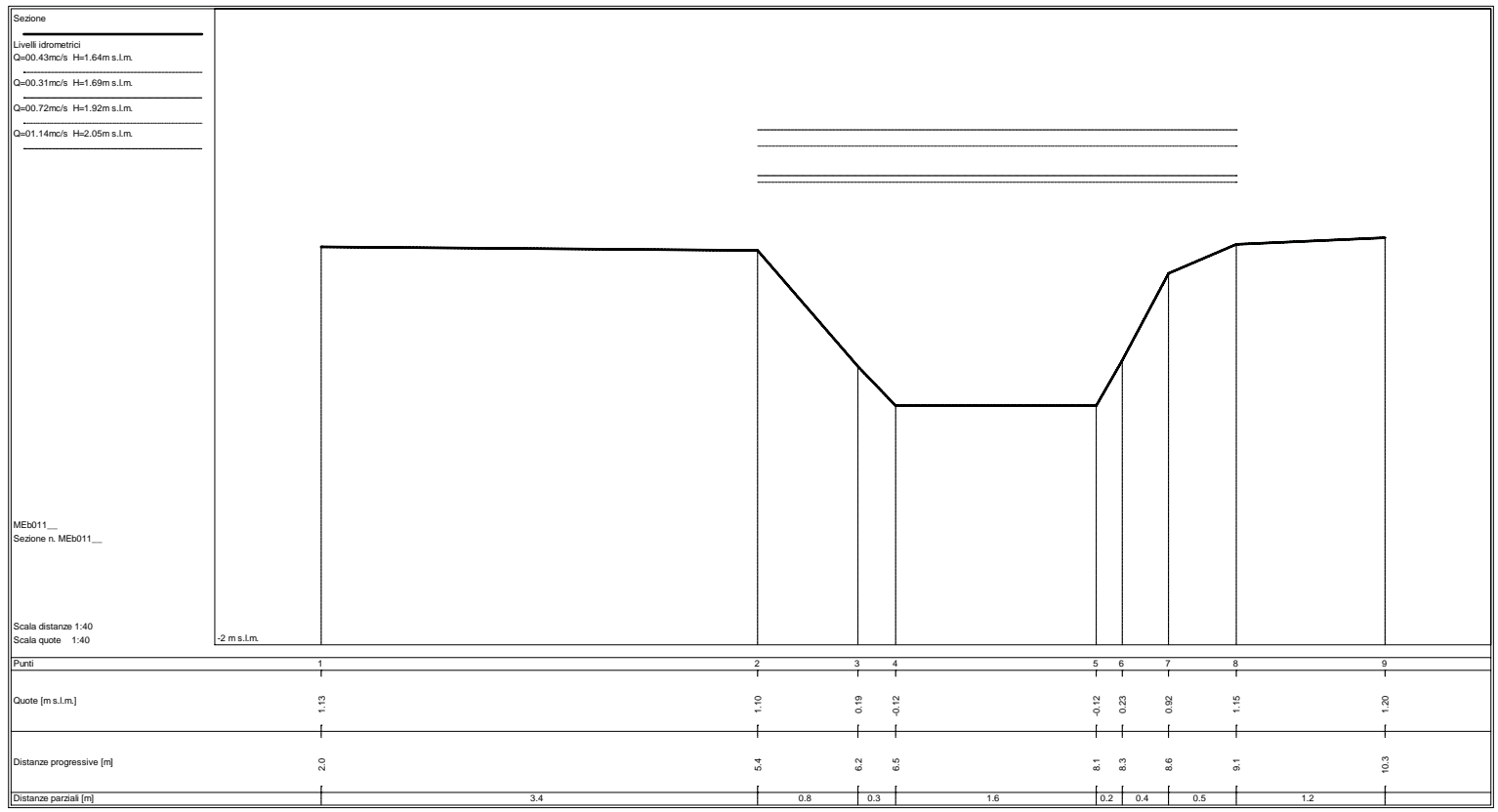

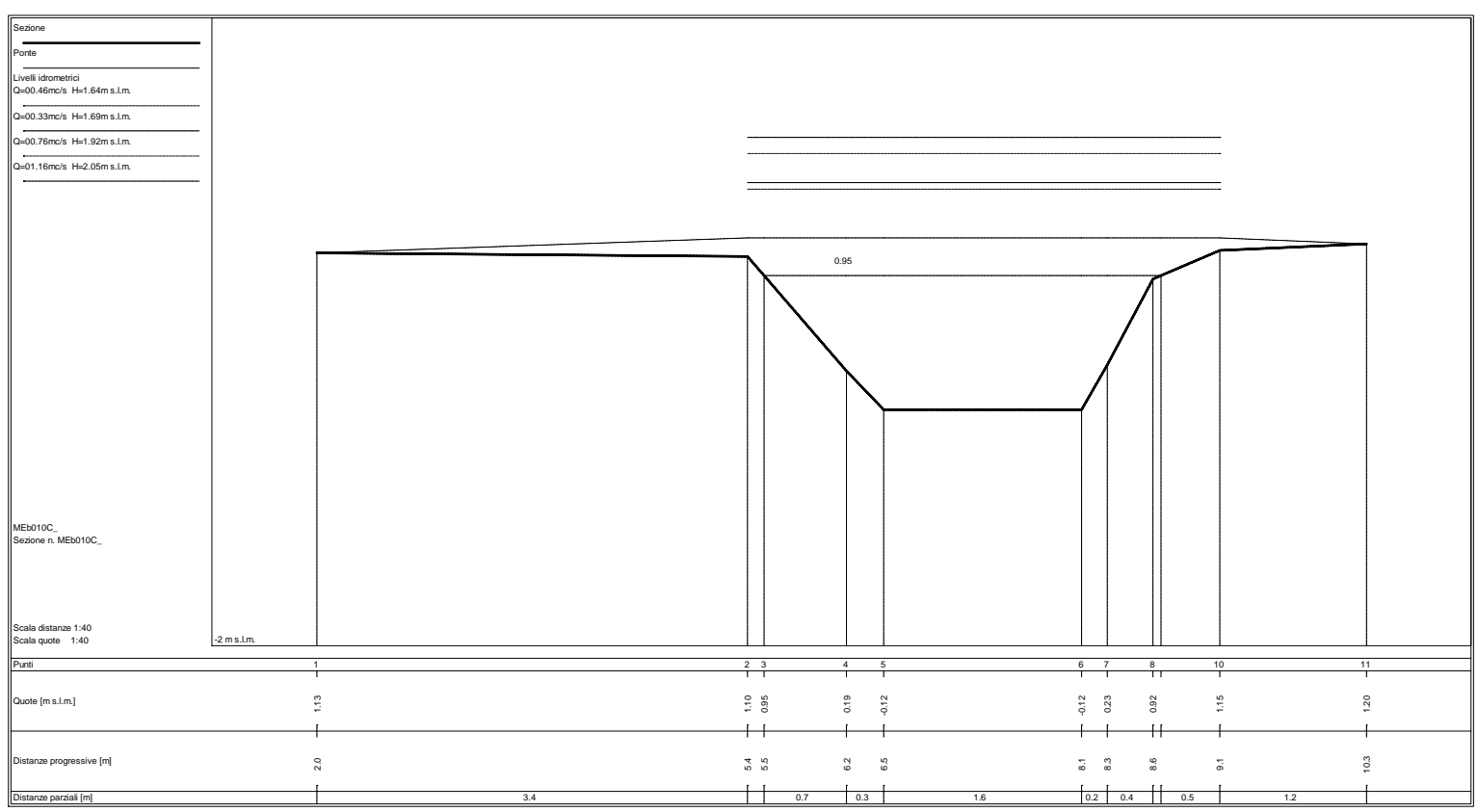
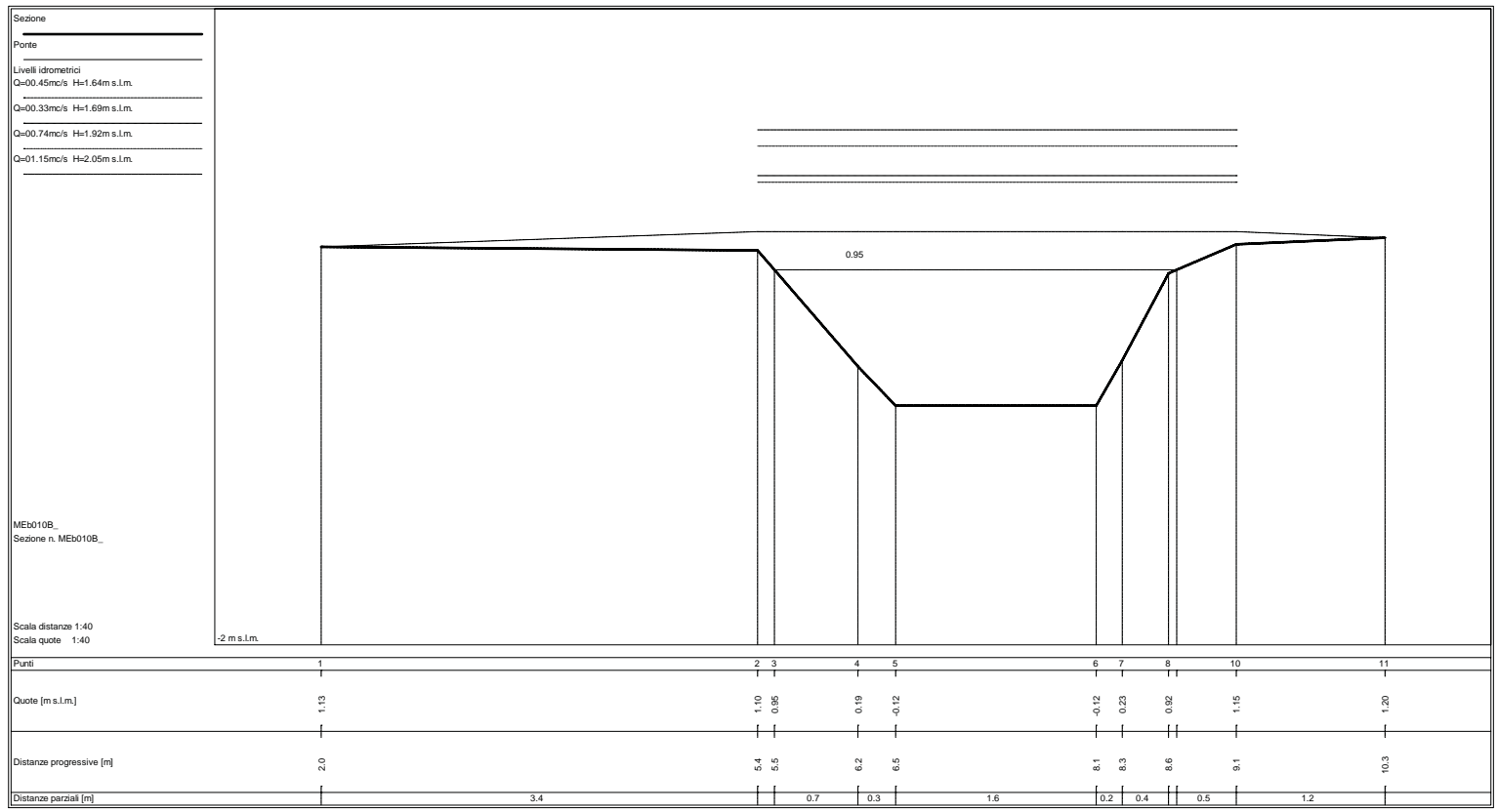

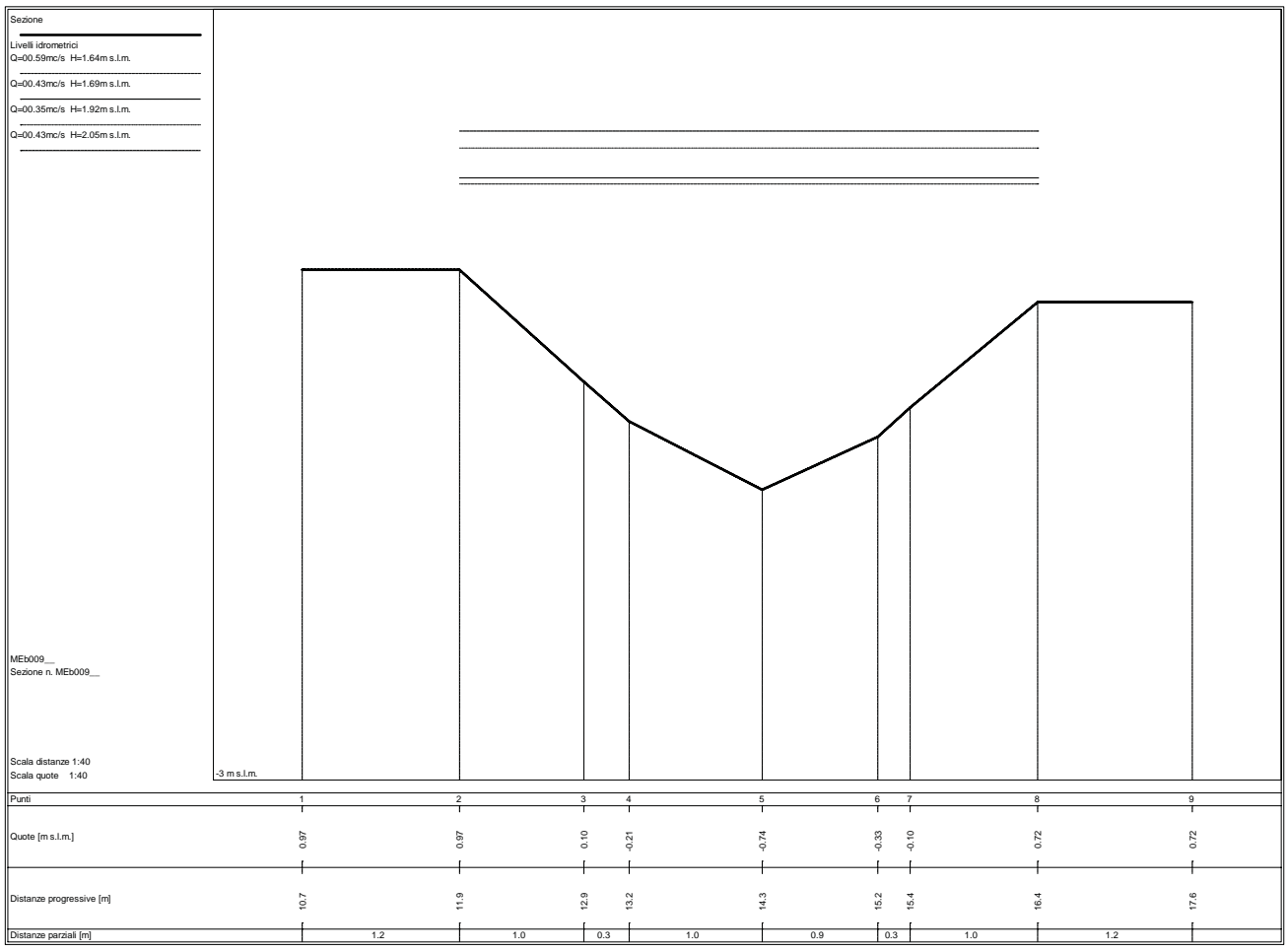
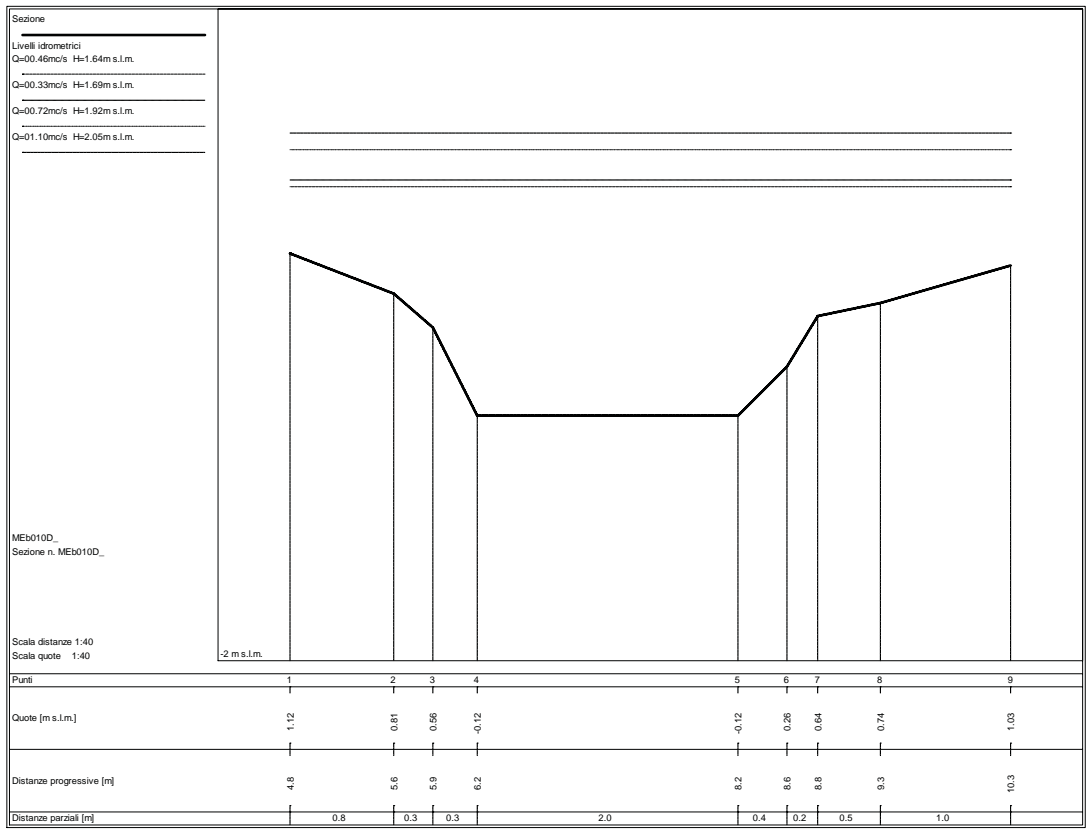

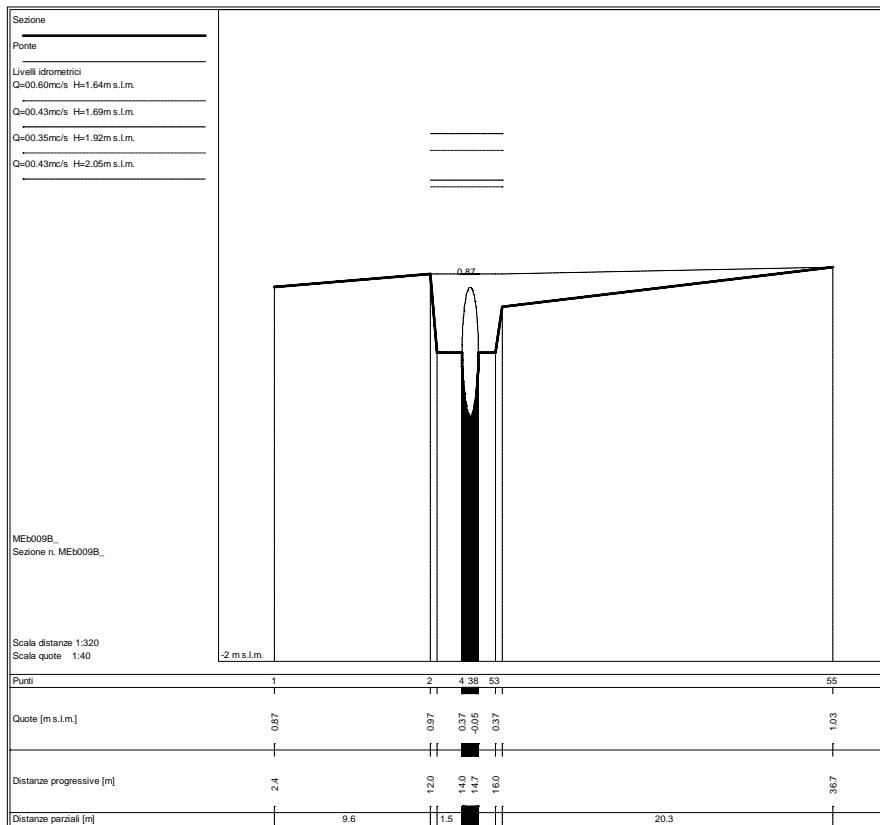
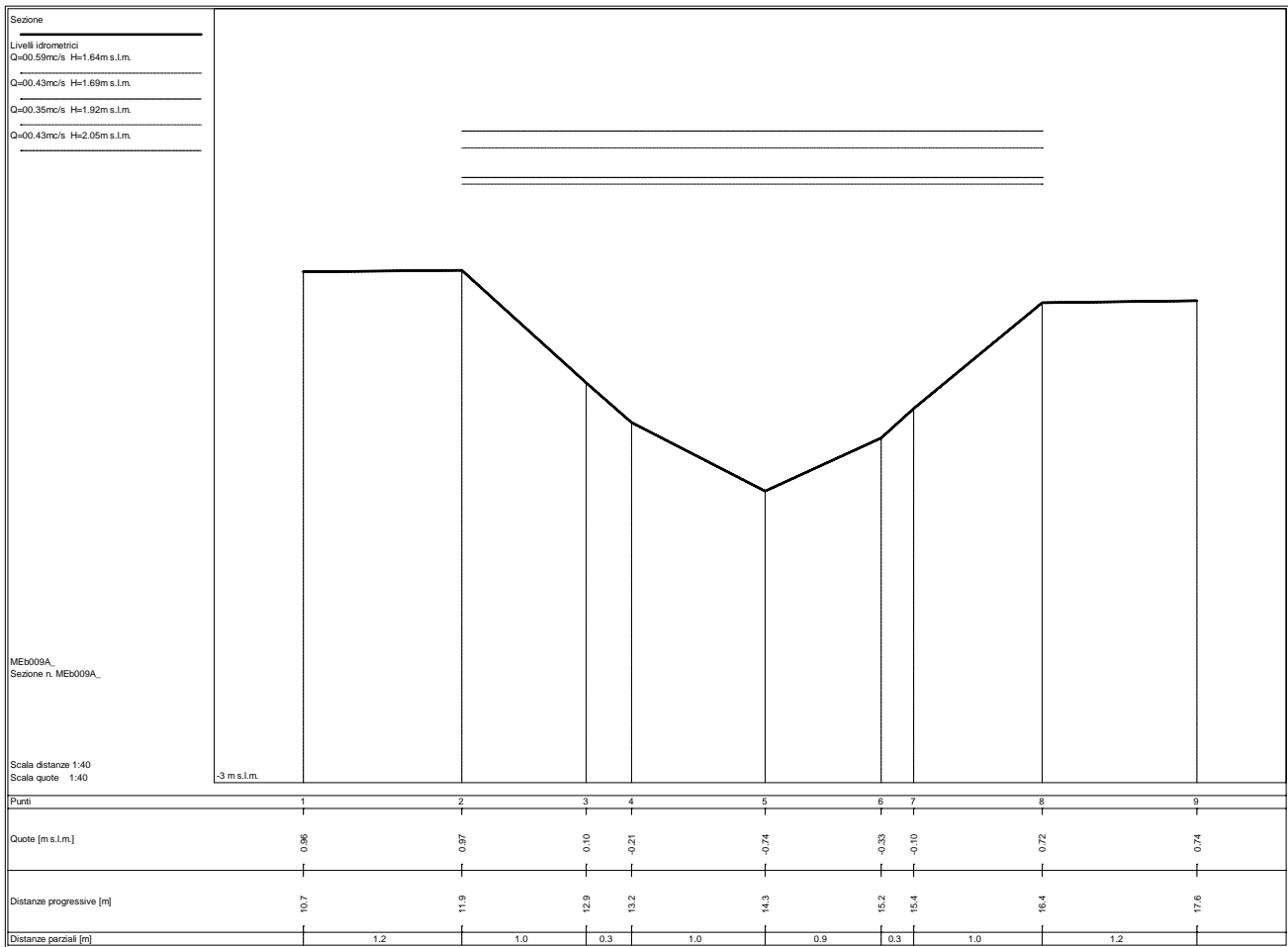

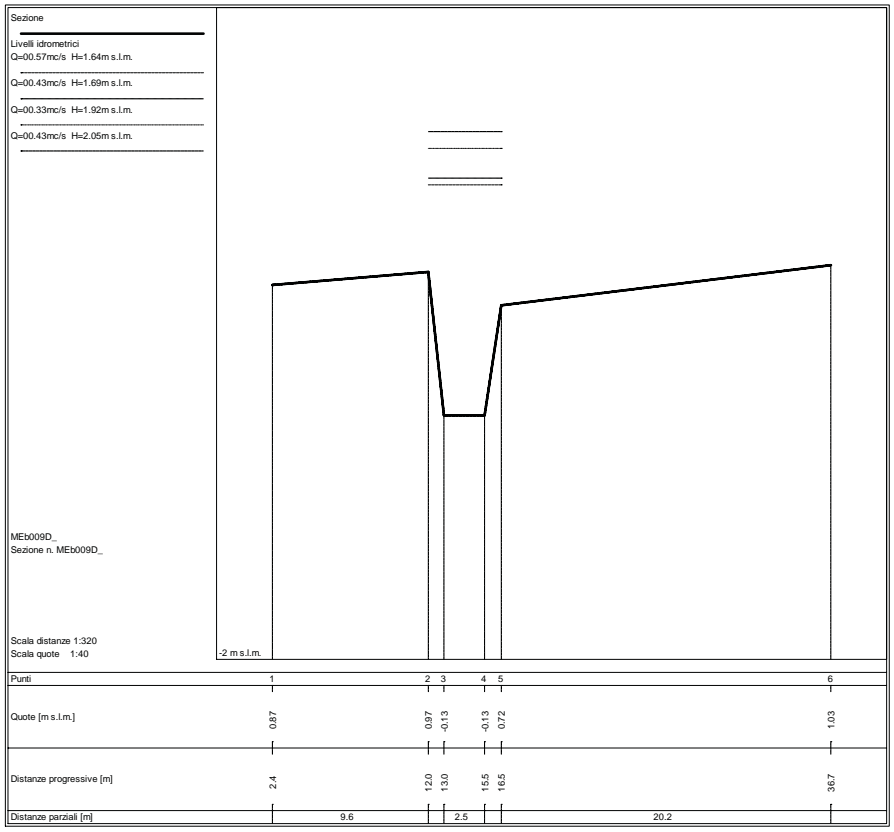
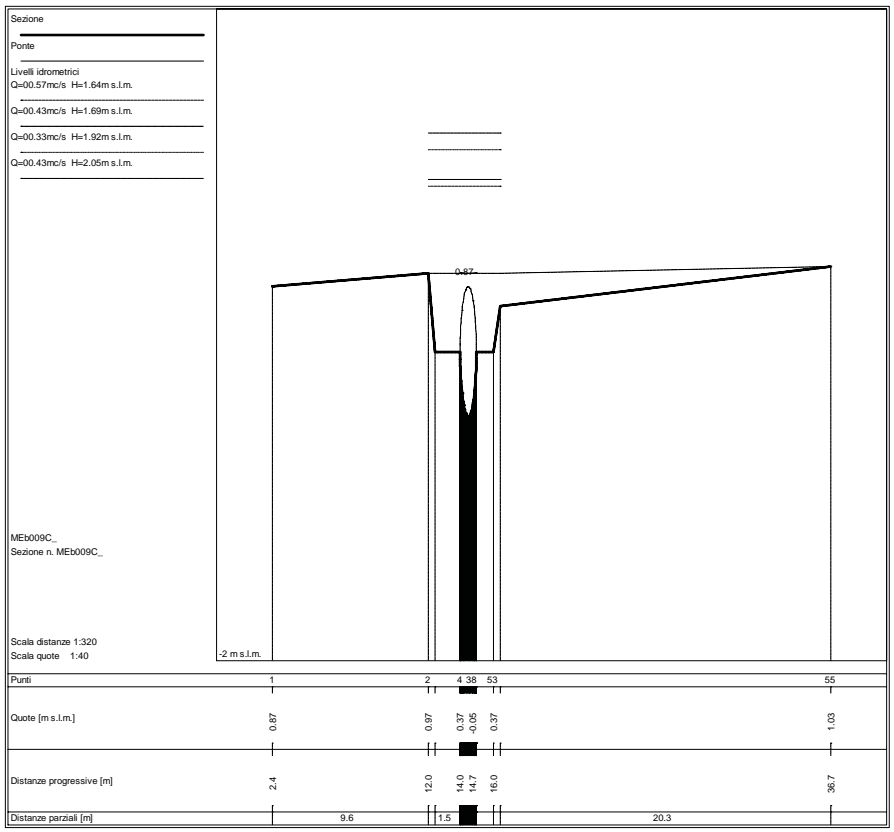

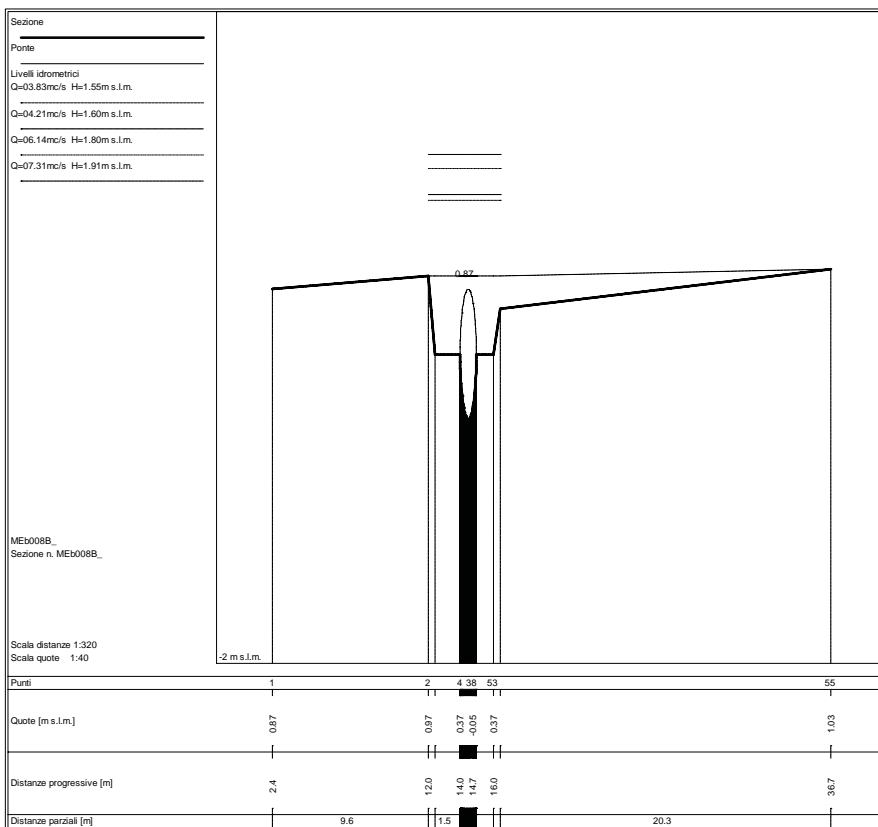
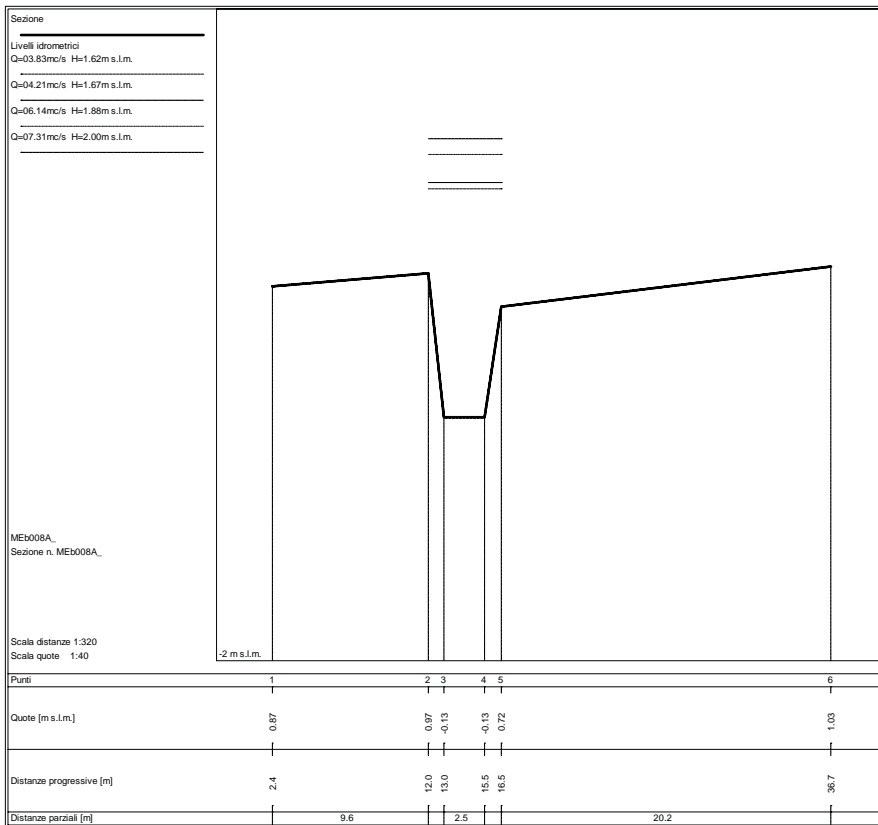

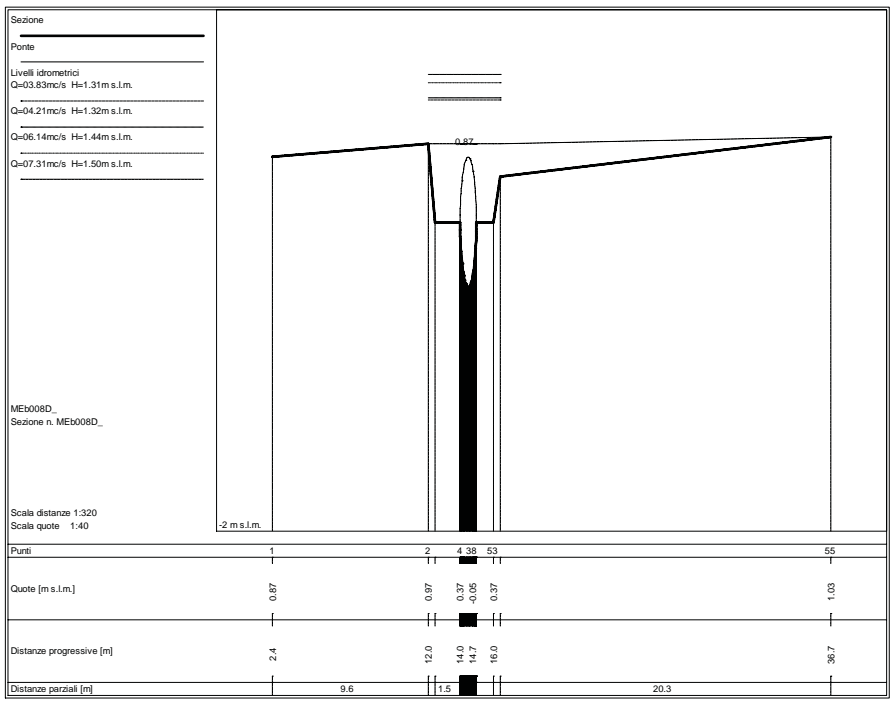
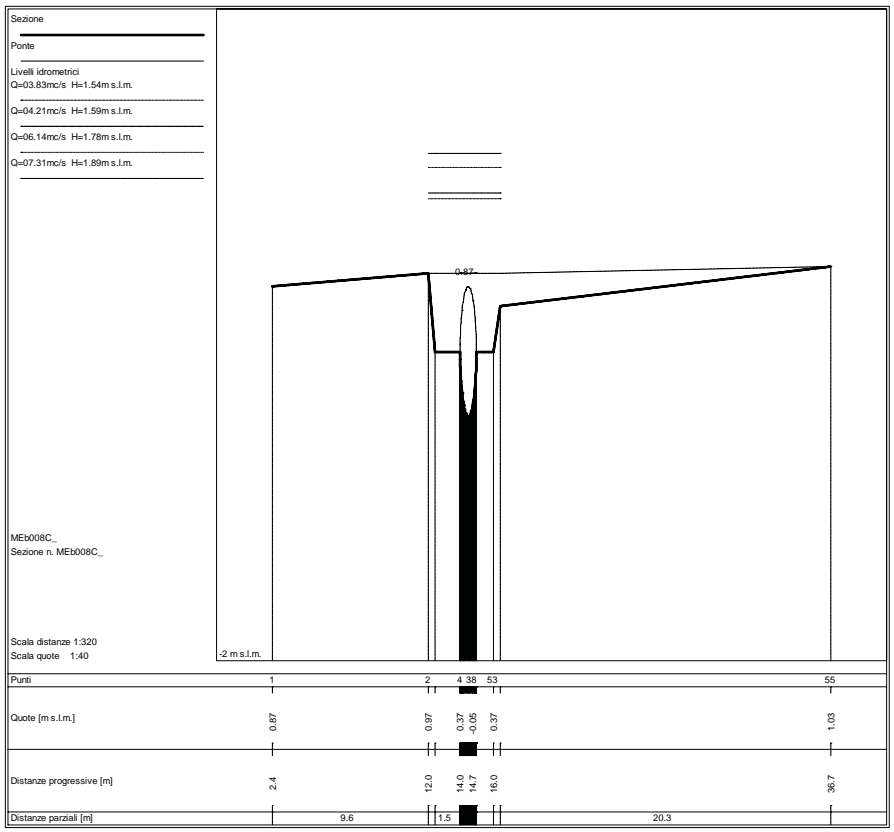

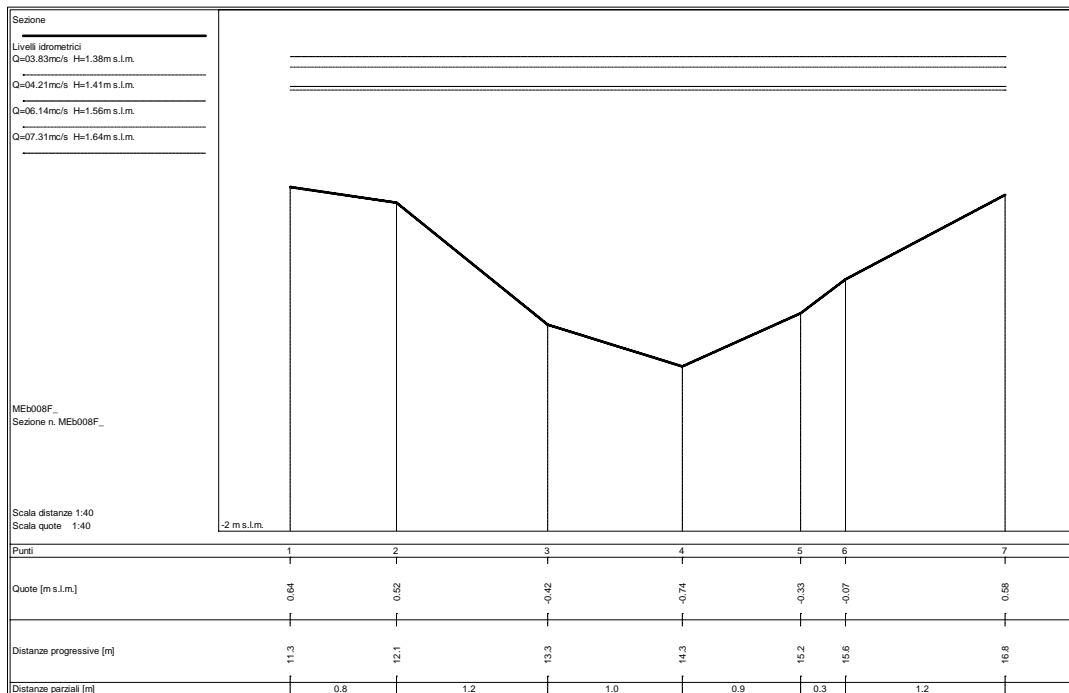
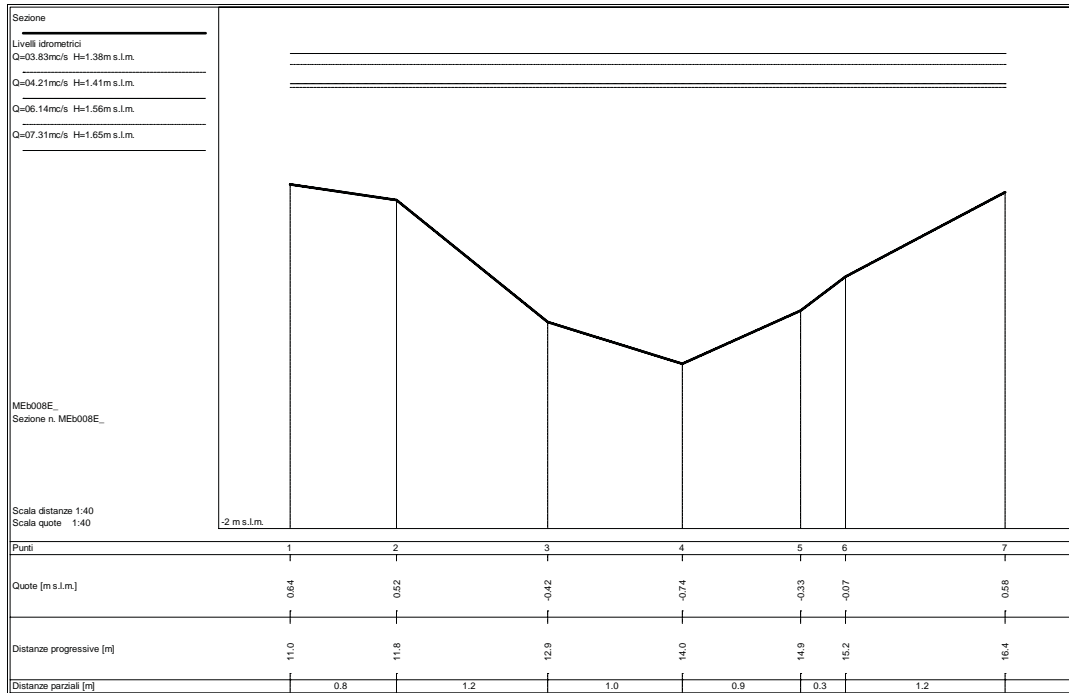

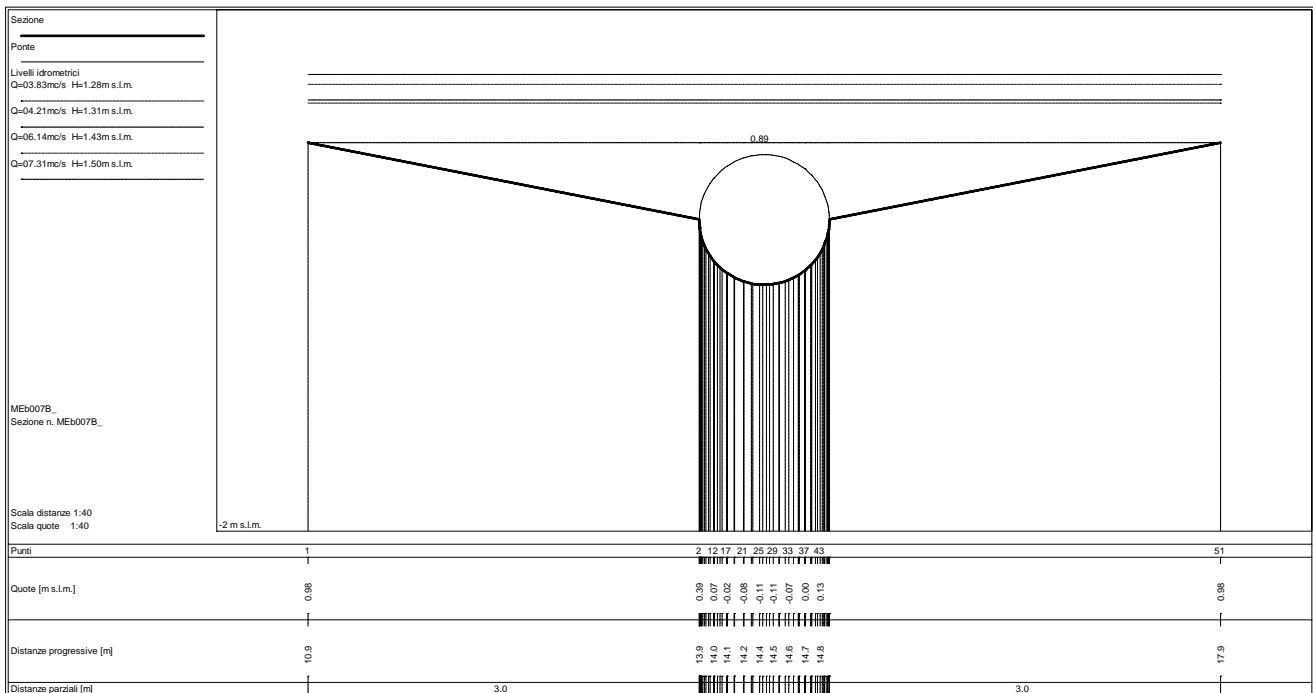
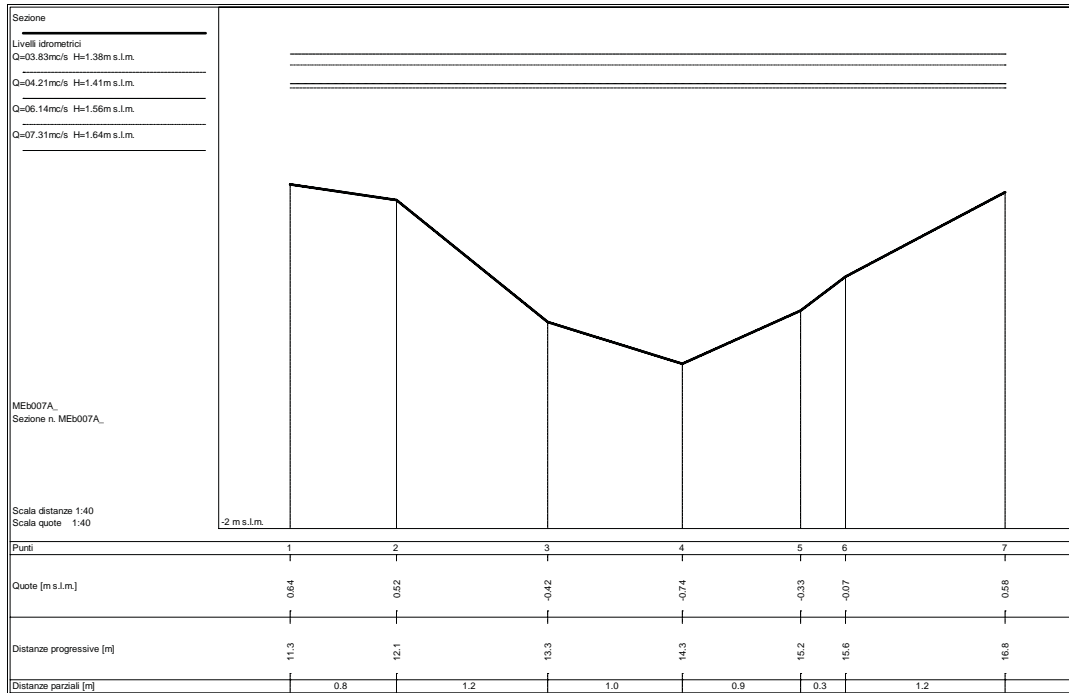

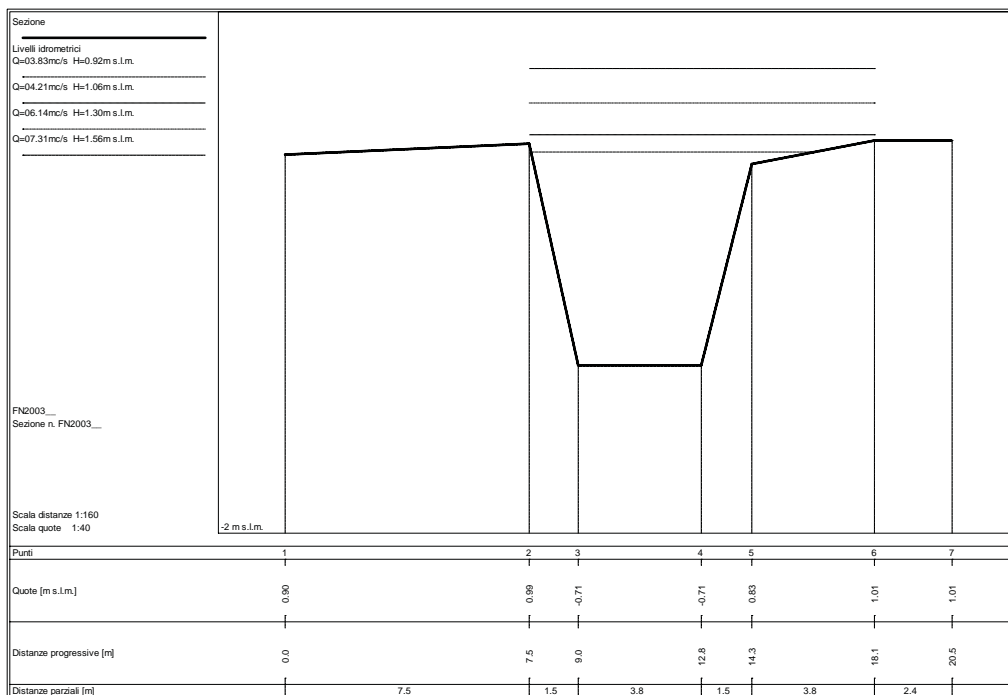
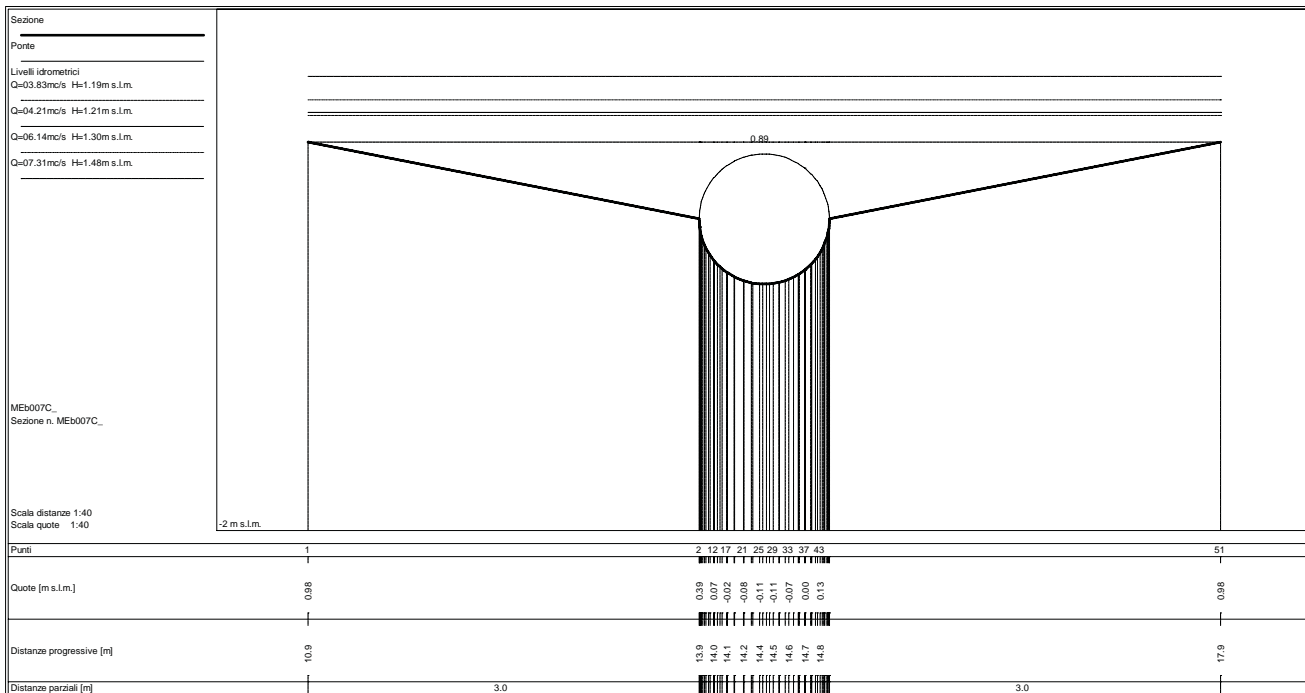

STATO ATTUALE

Sezioni fluviali fosso di Mezzo – ME_c_P

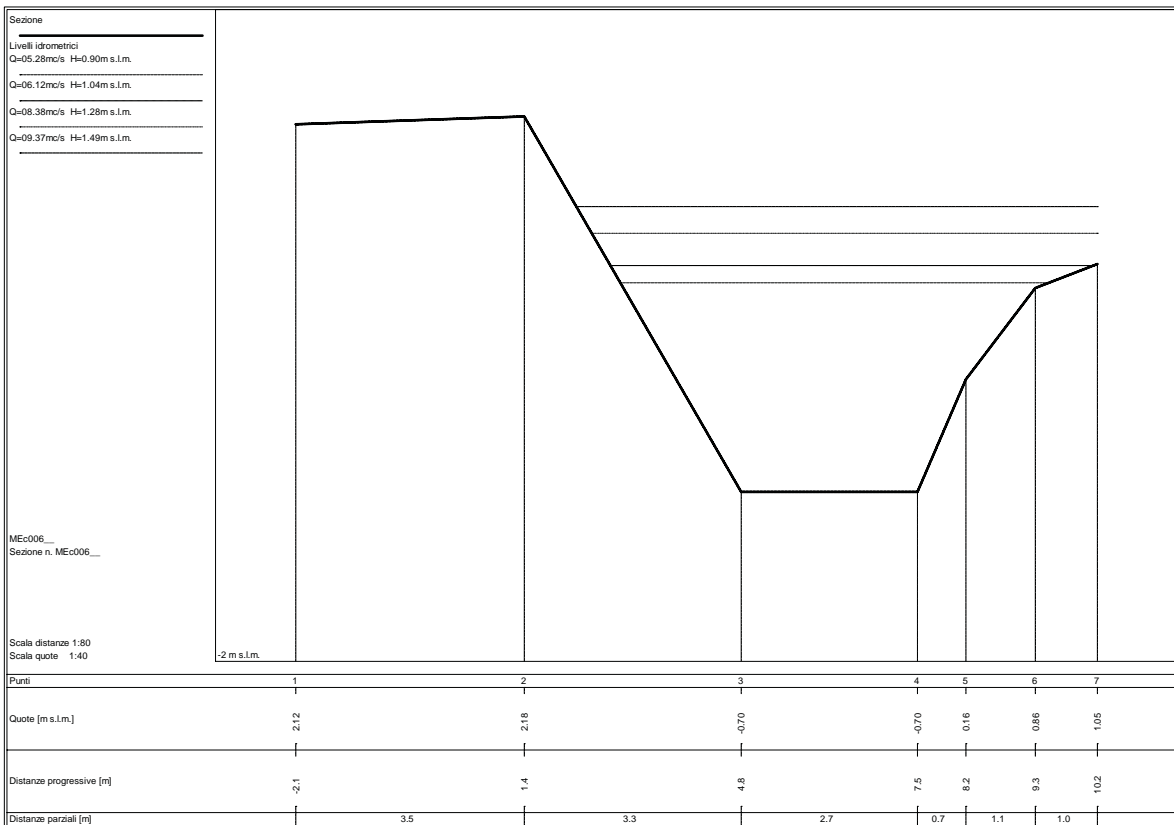
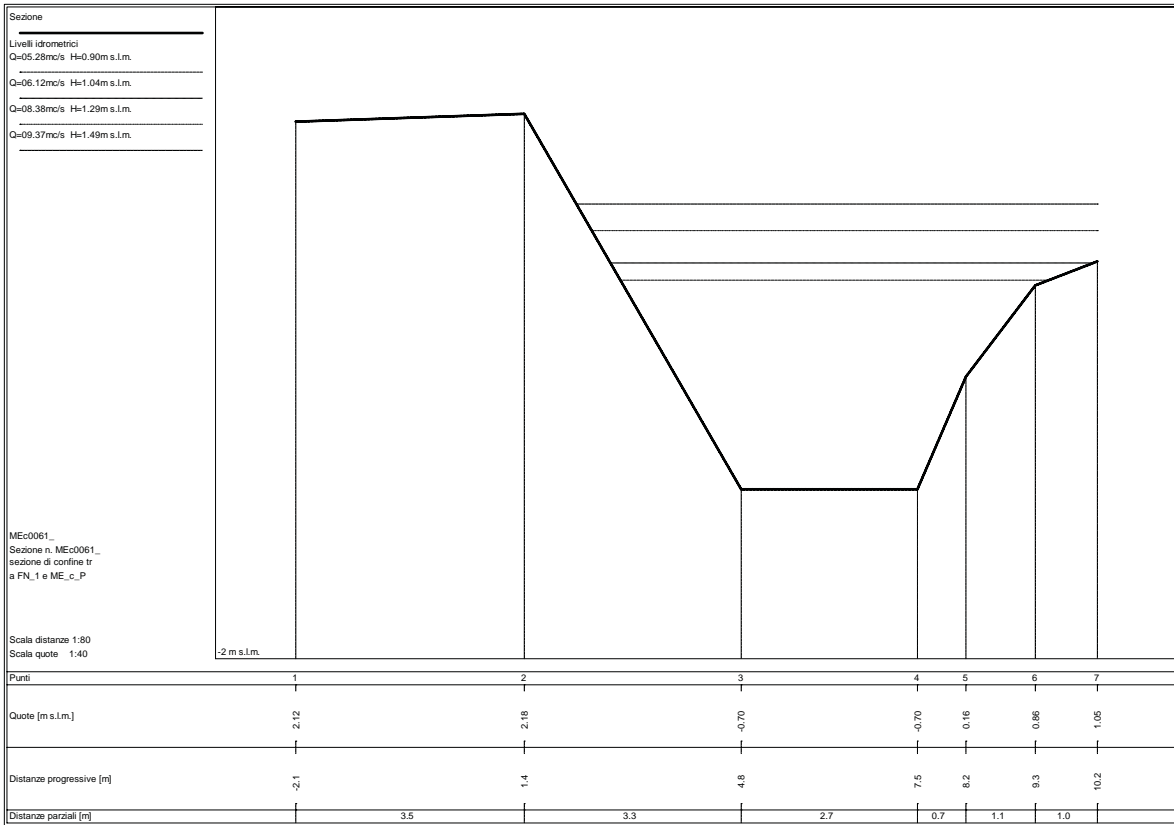

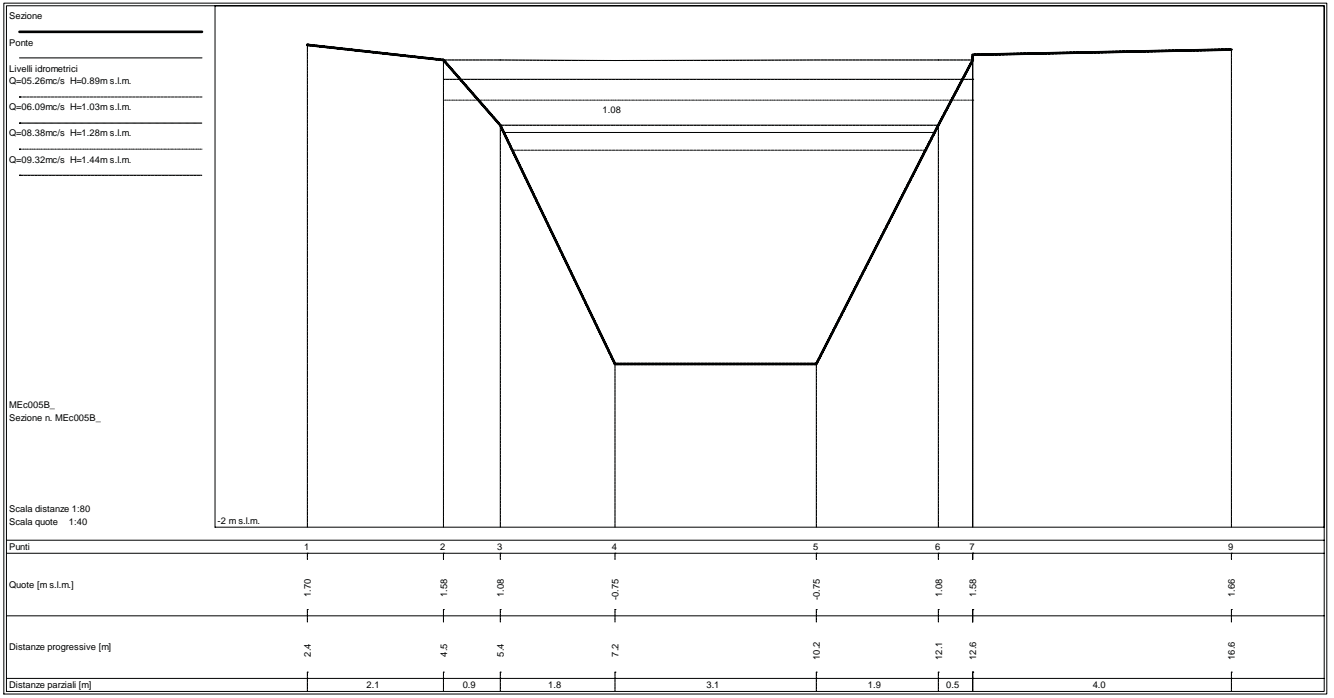
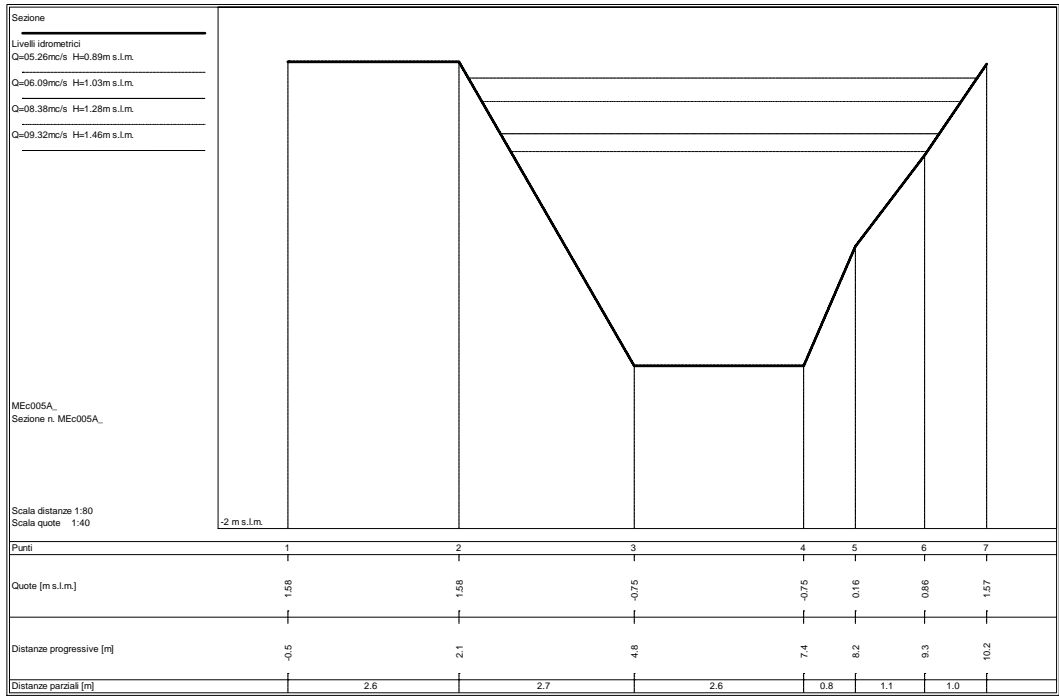

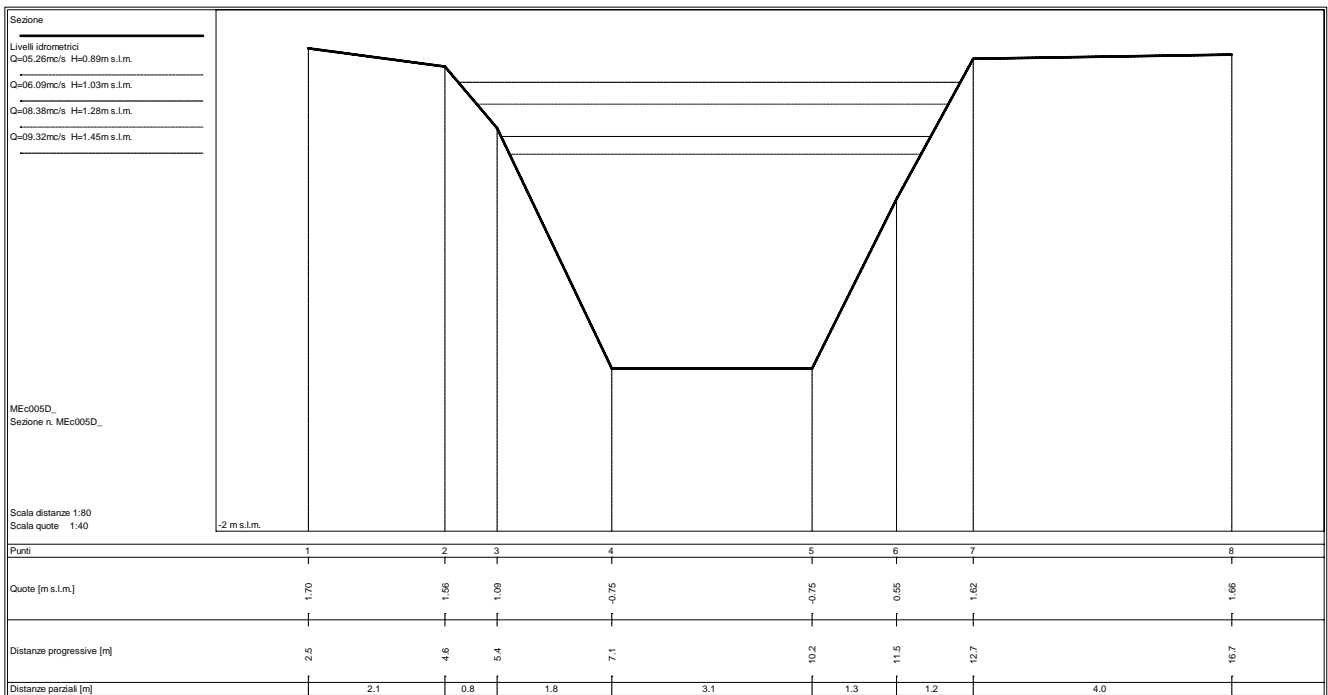
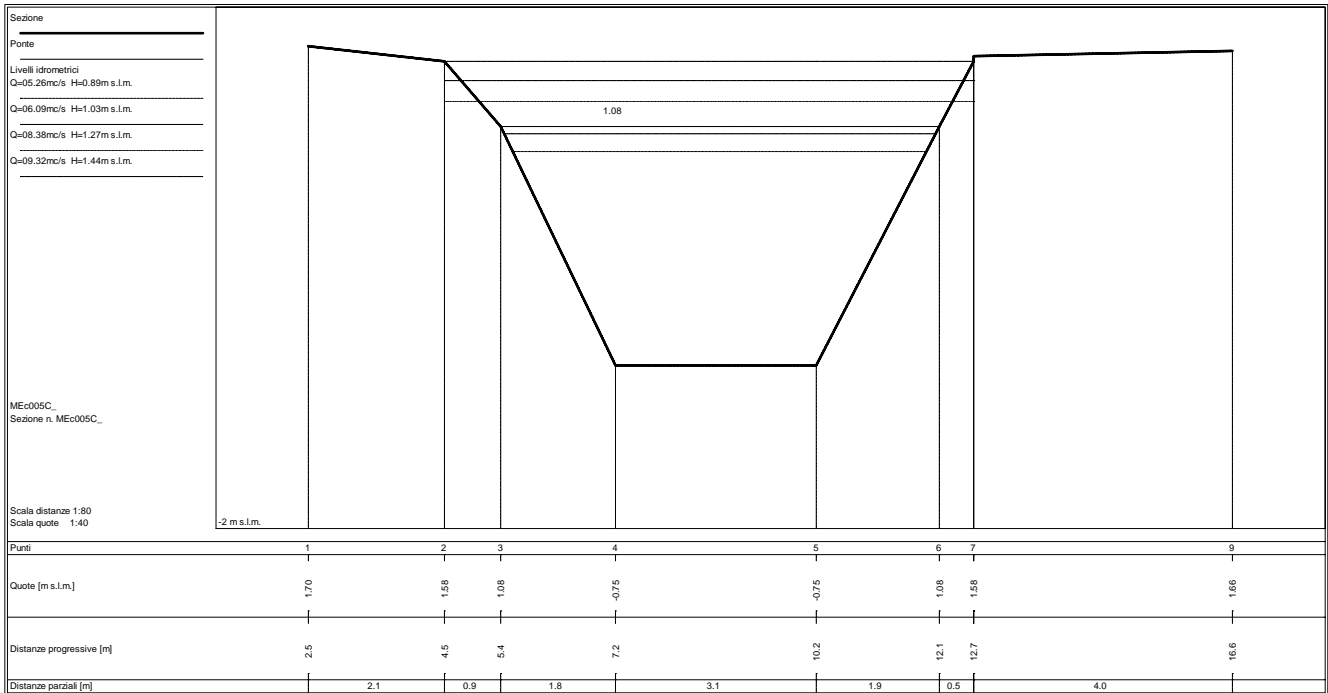

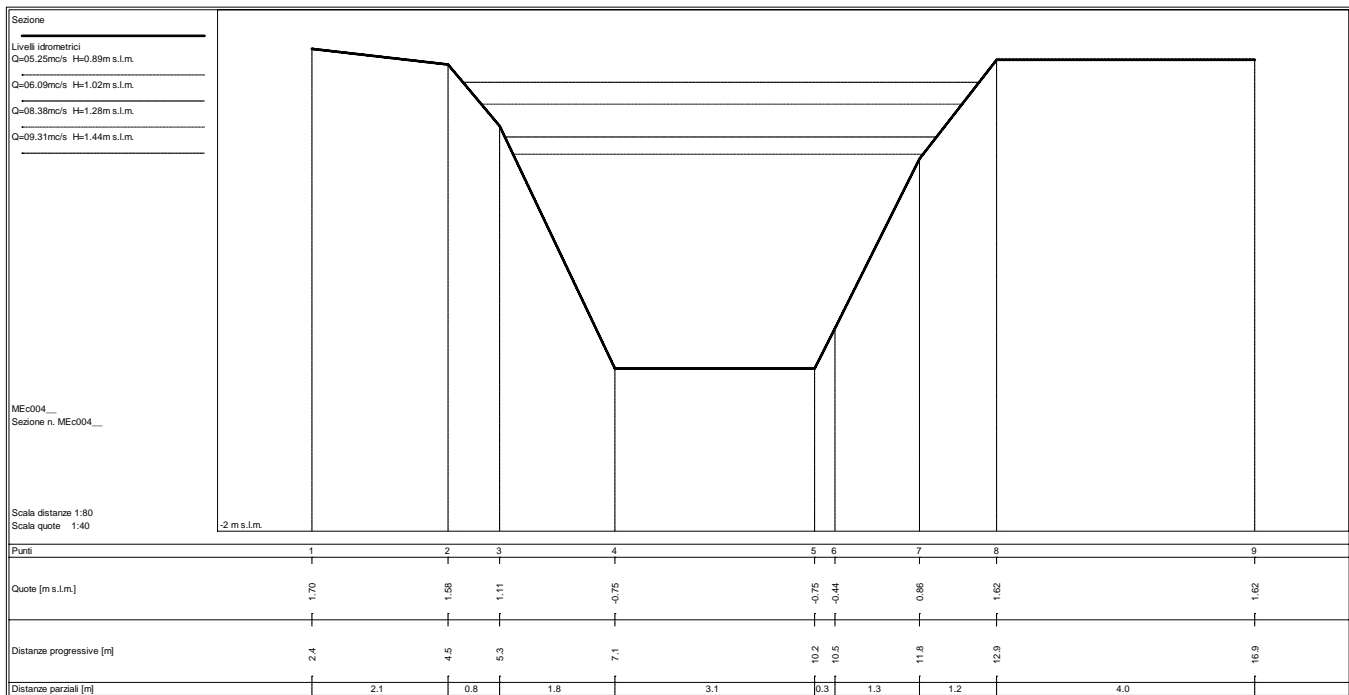
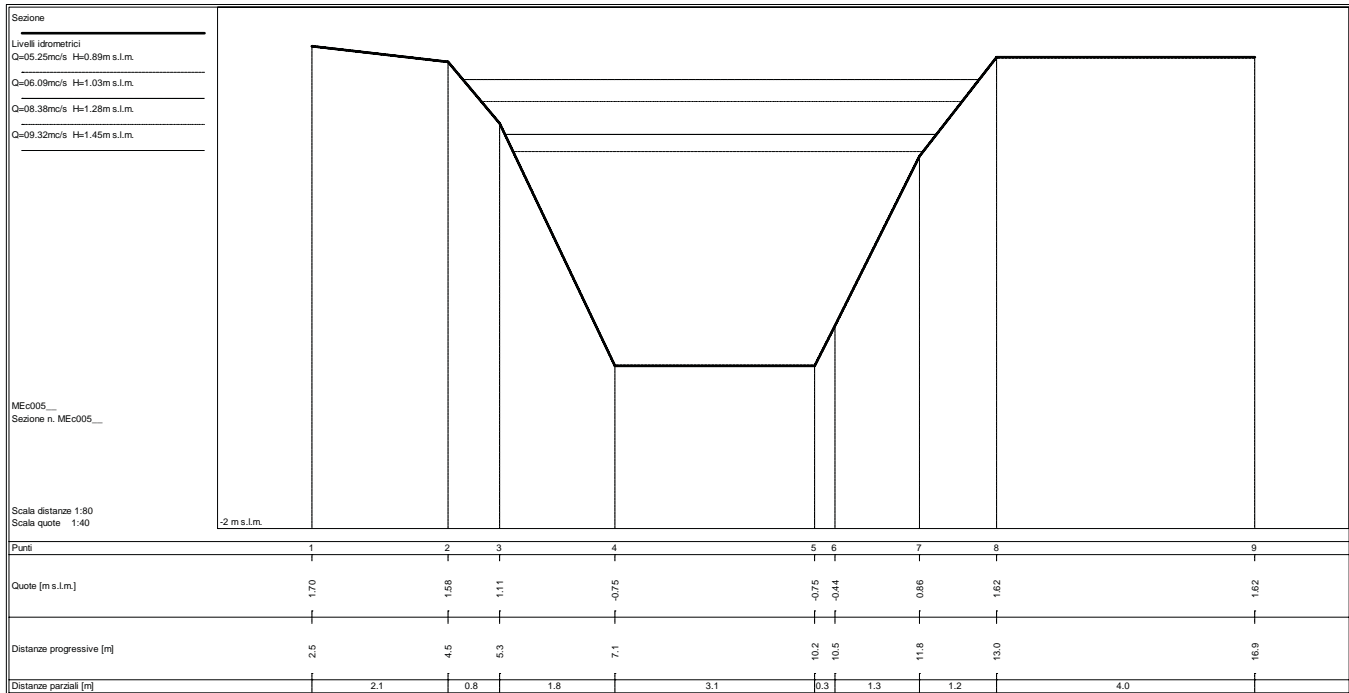

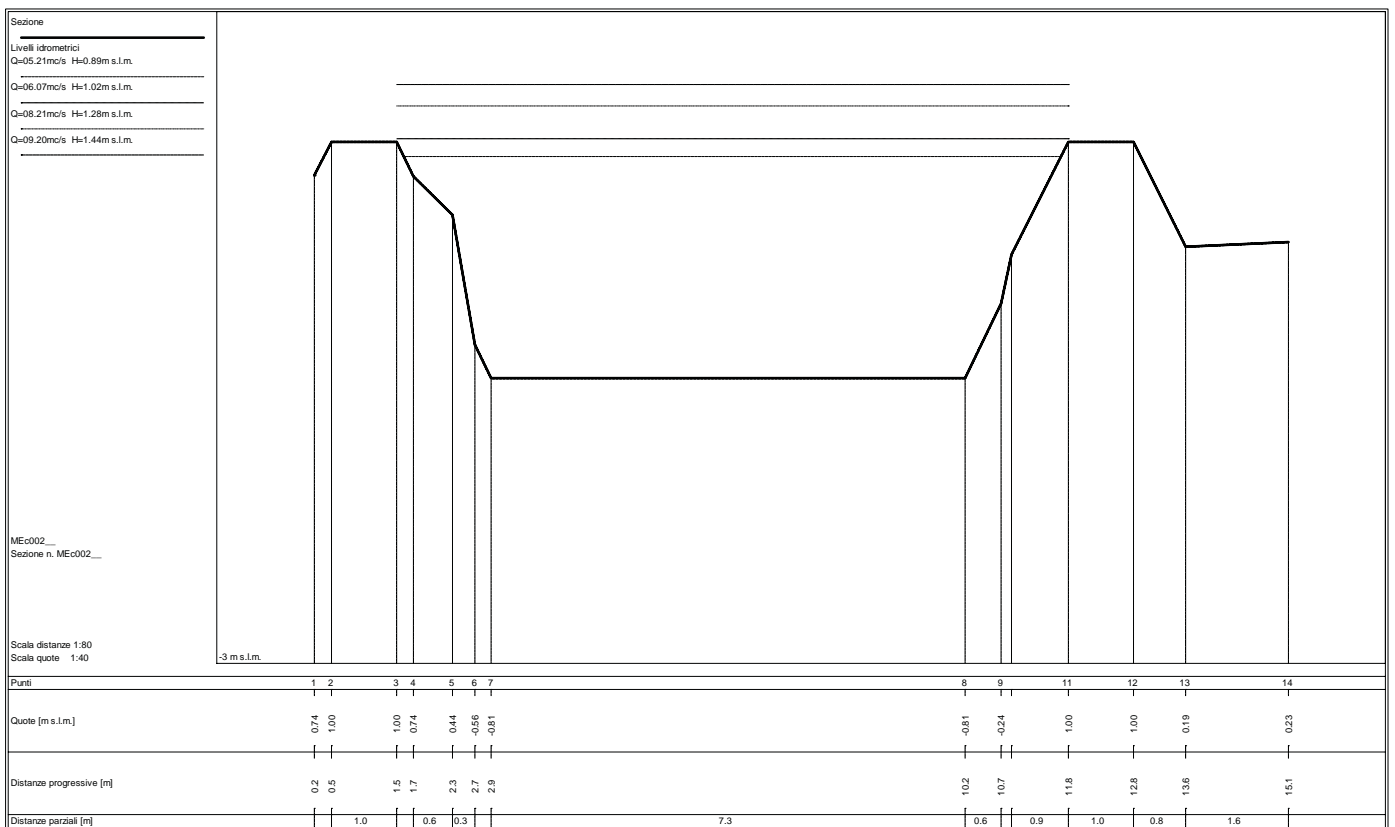
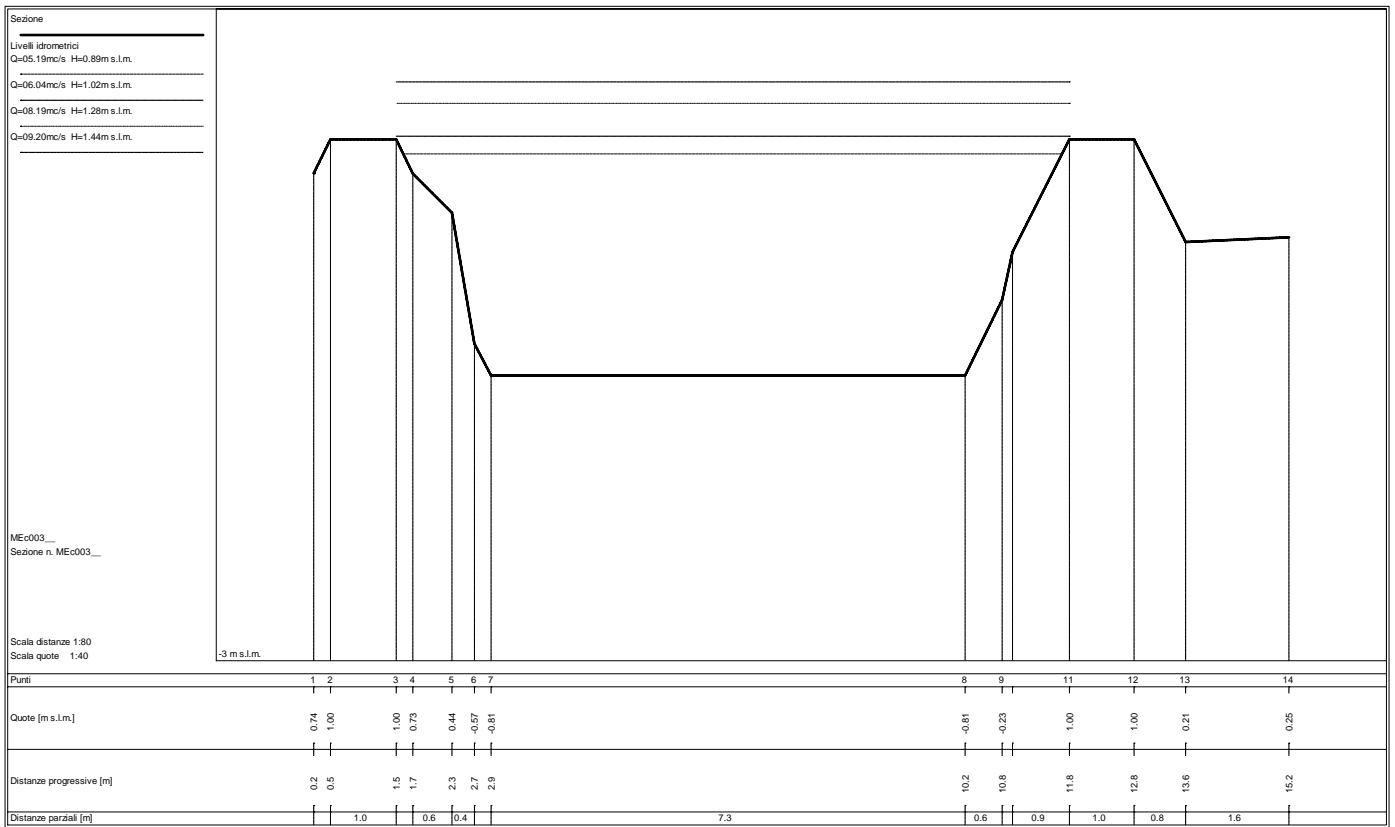

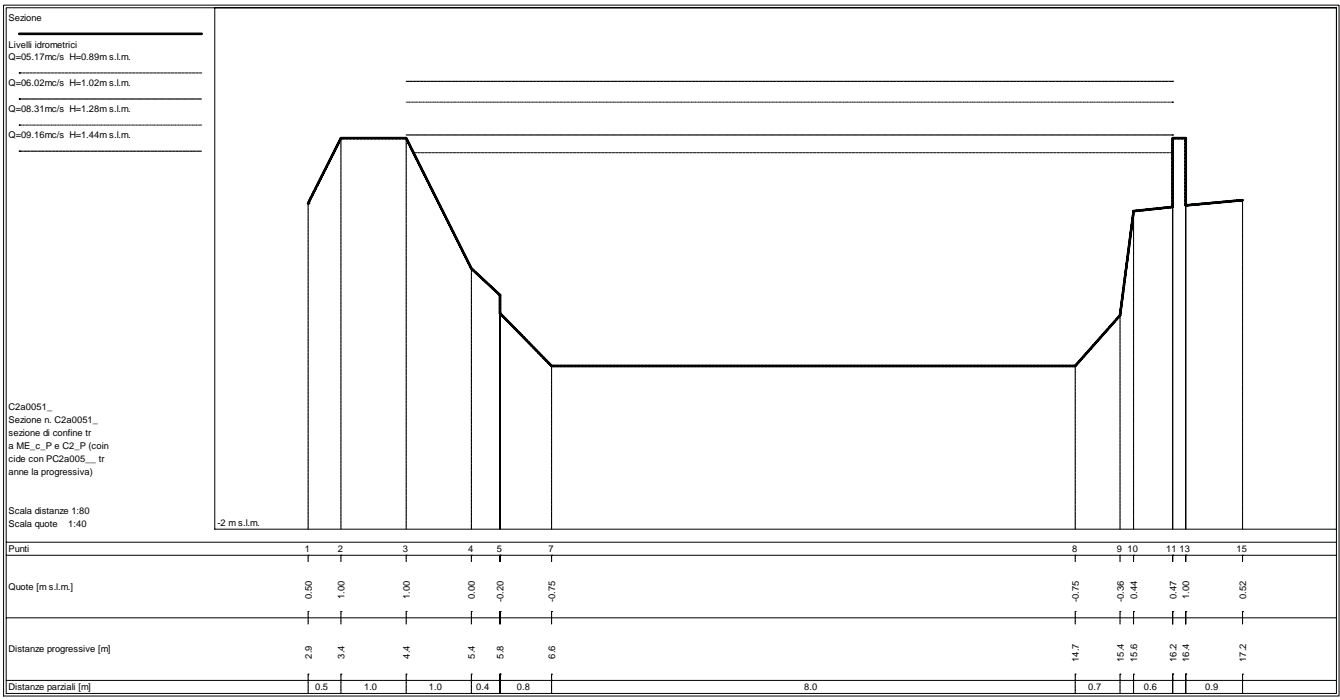
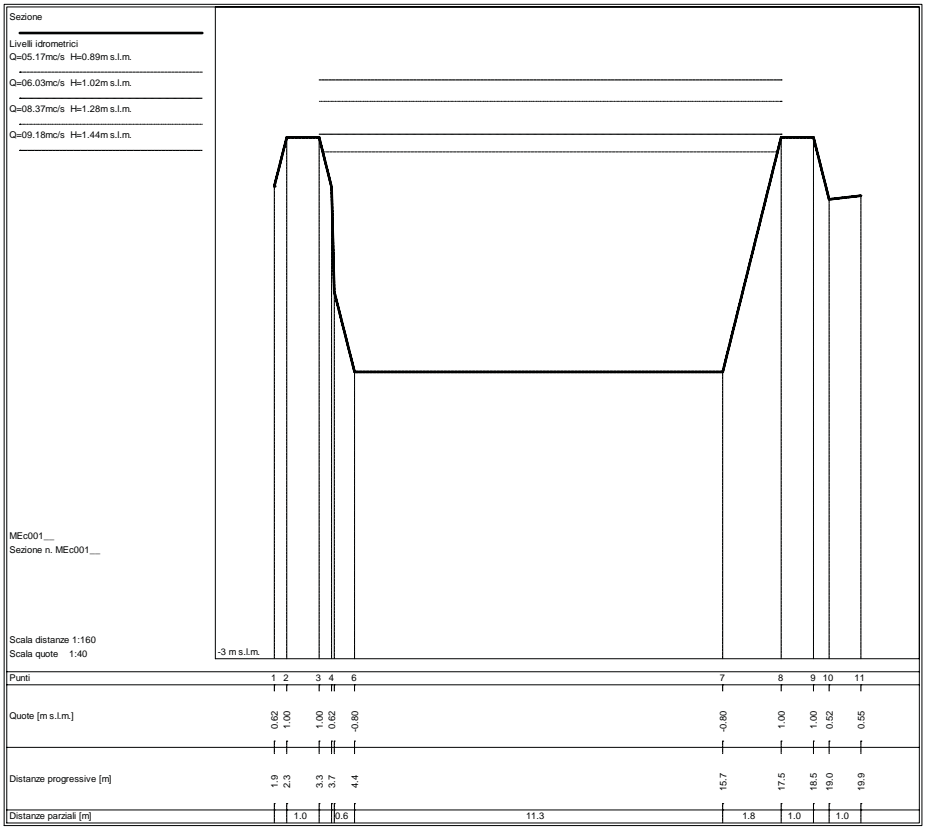

STATO ATTUALE

Sezioni fluviali fosso Silcia – SI_a_P

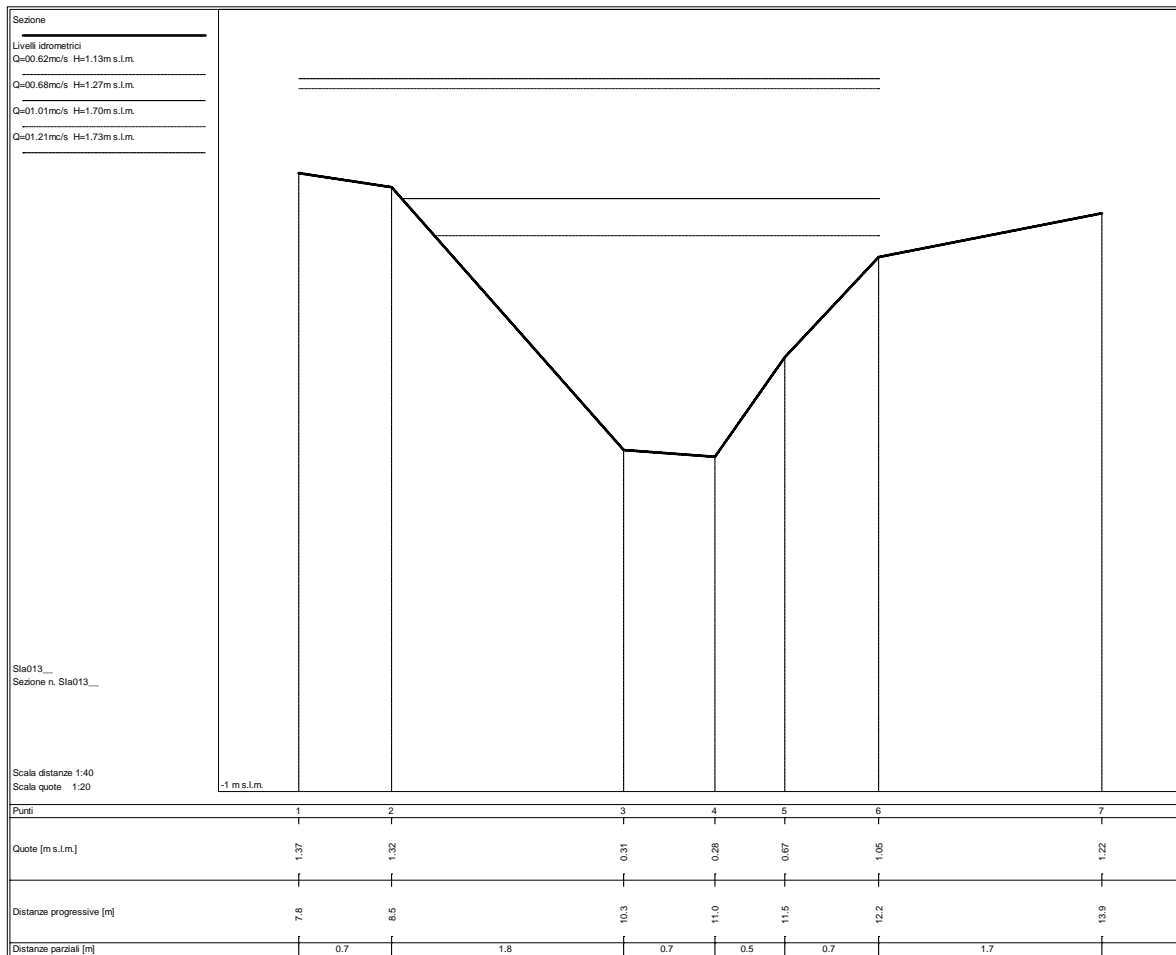
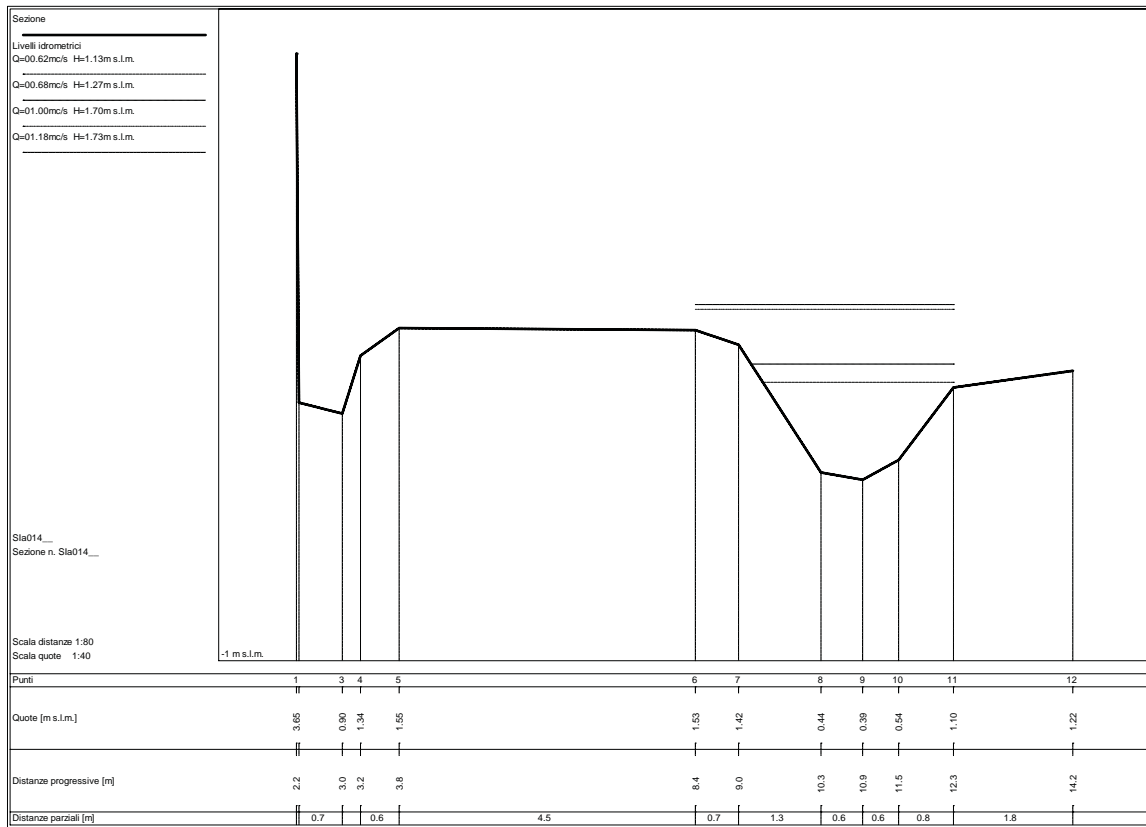

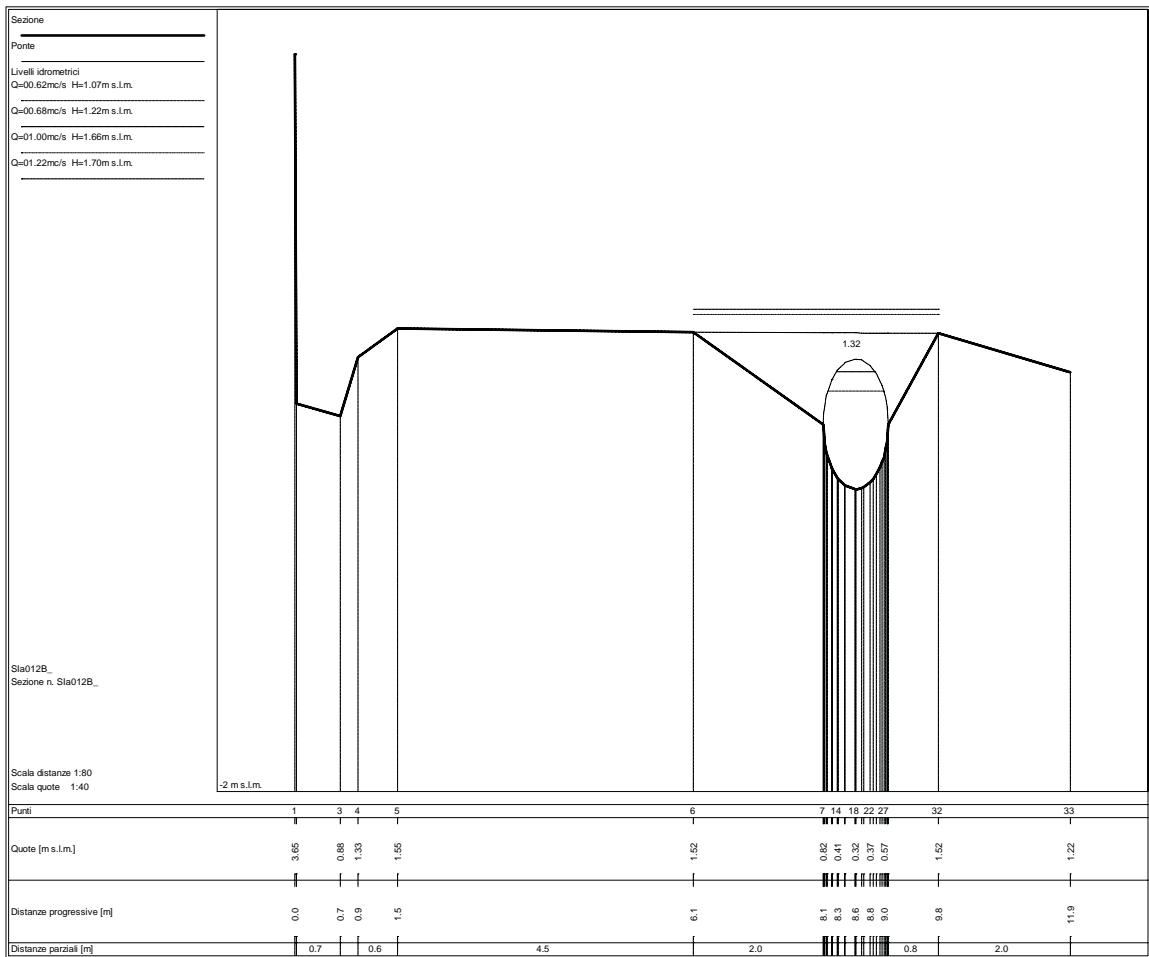
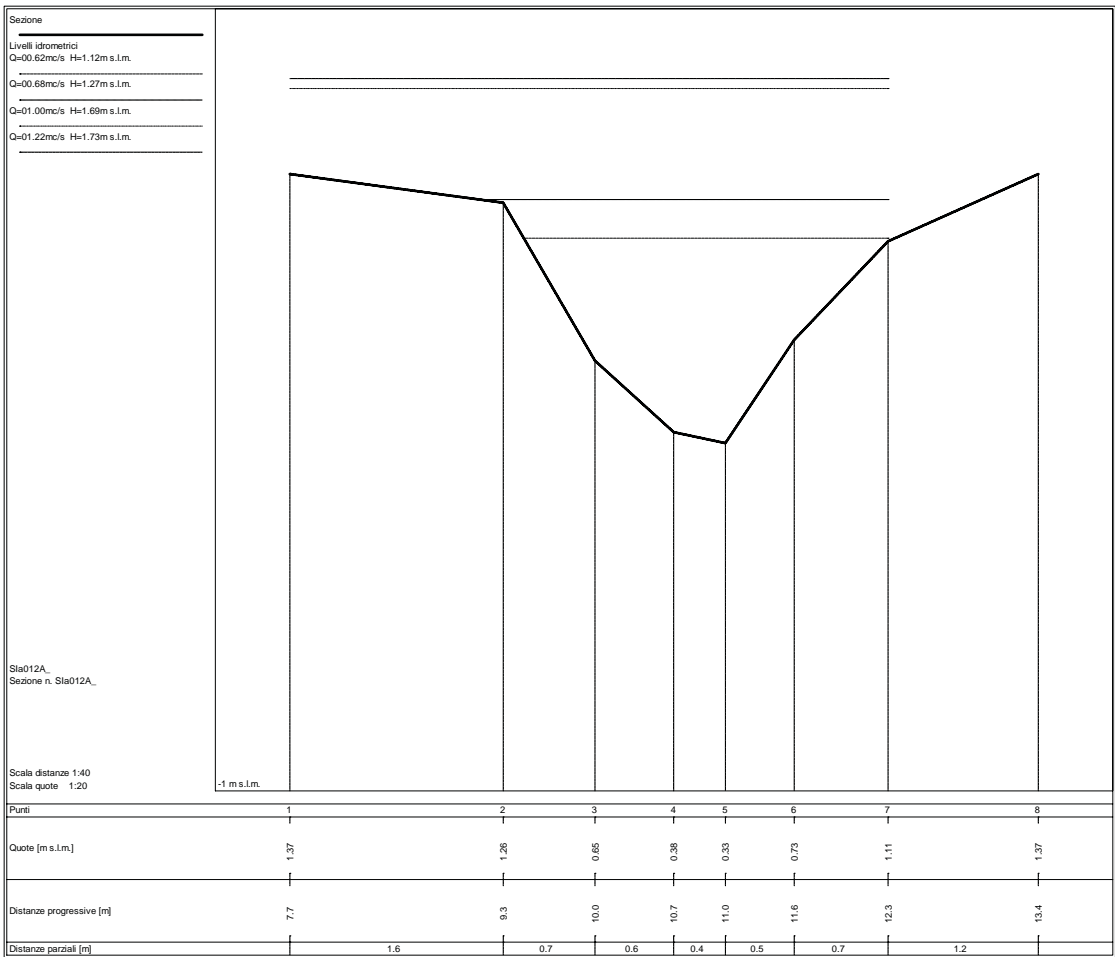

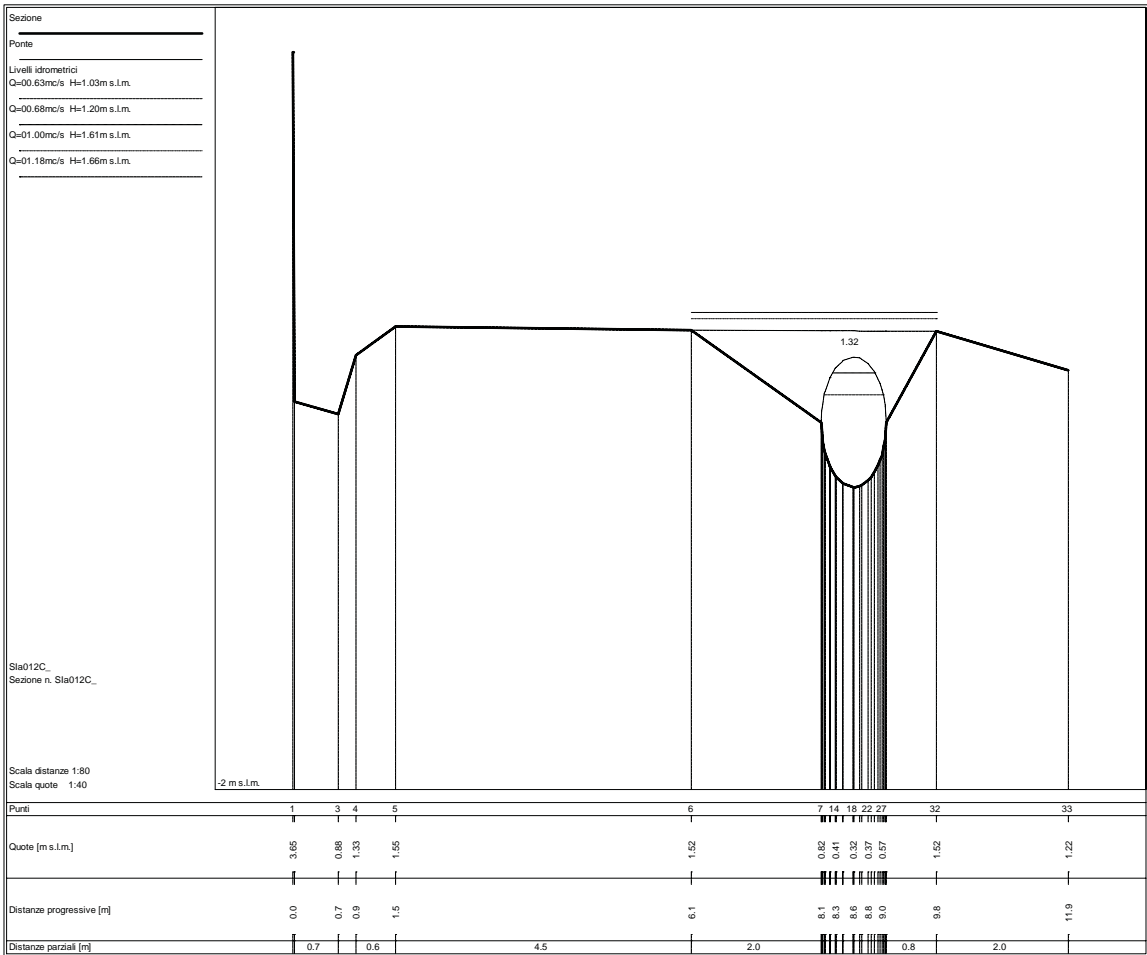
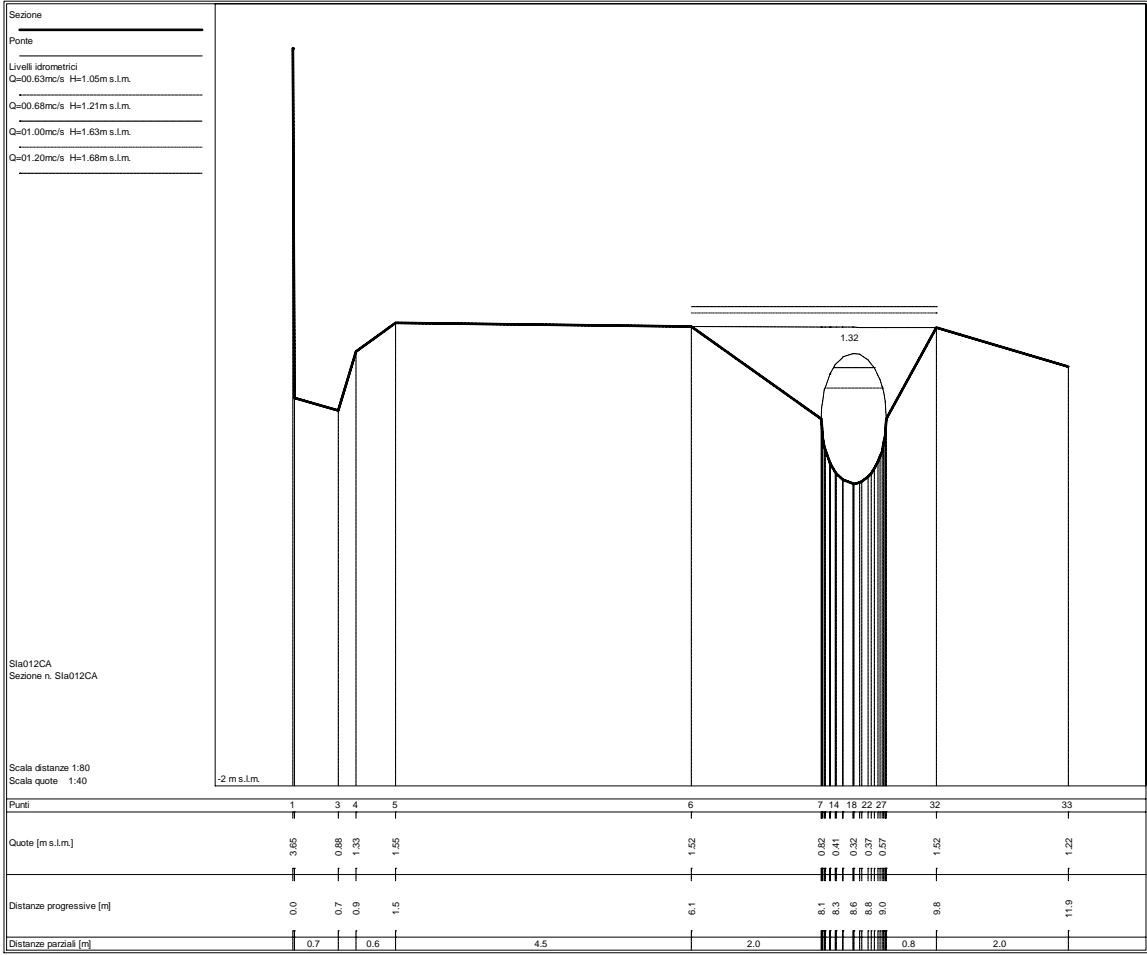

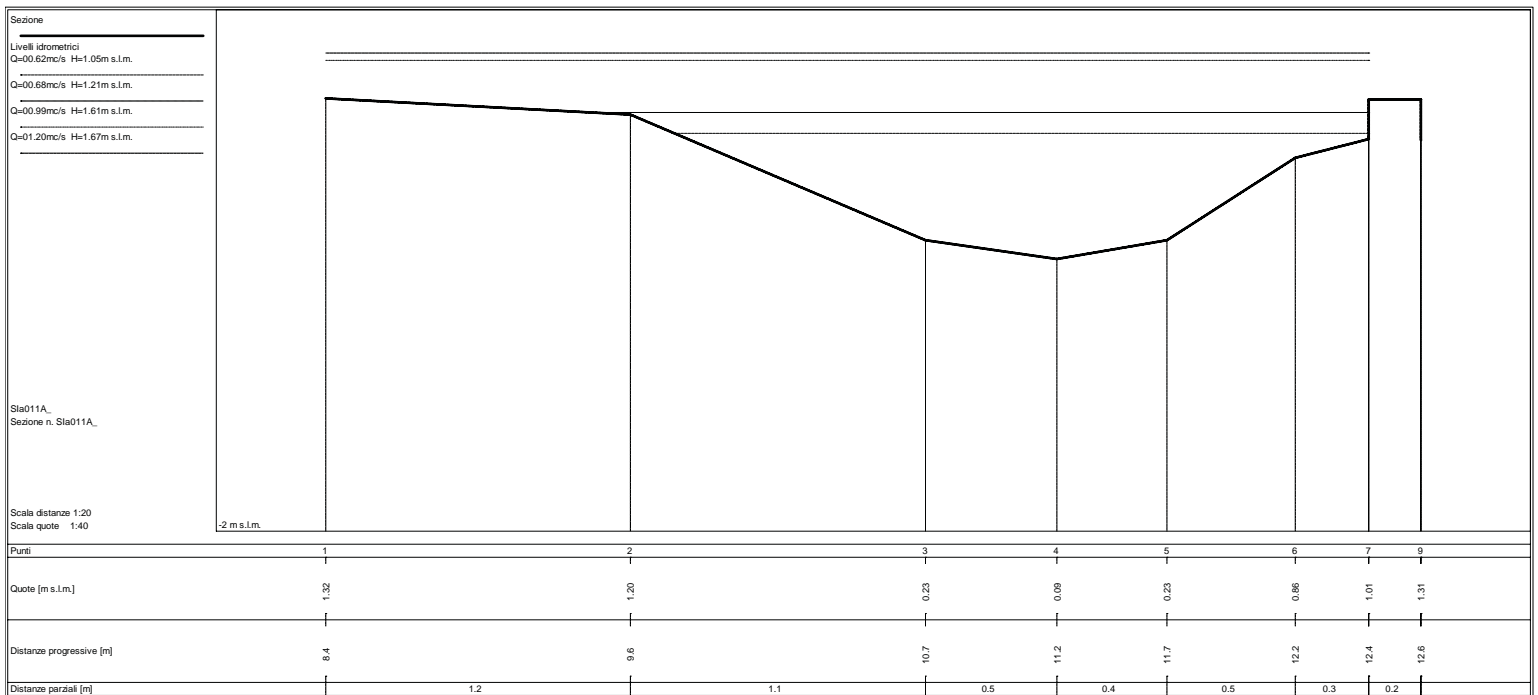
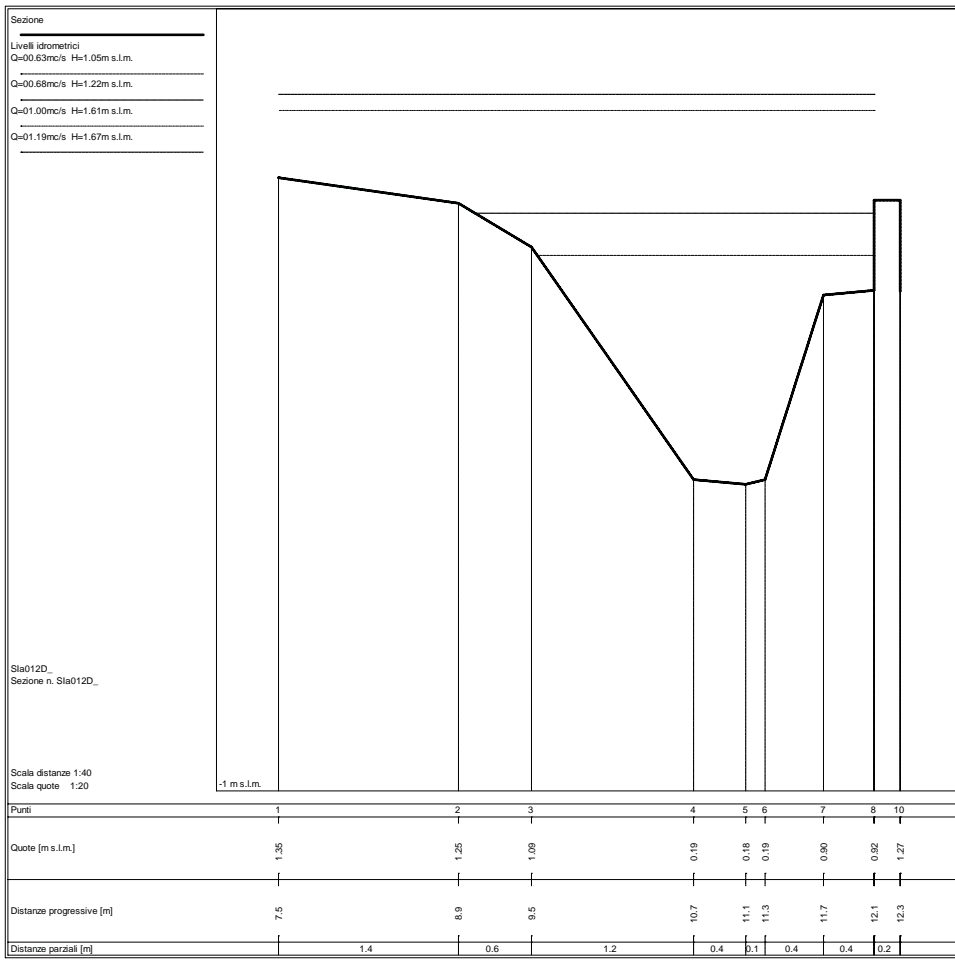

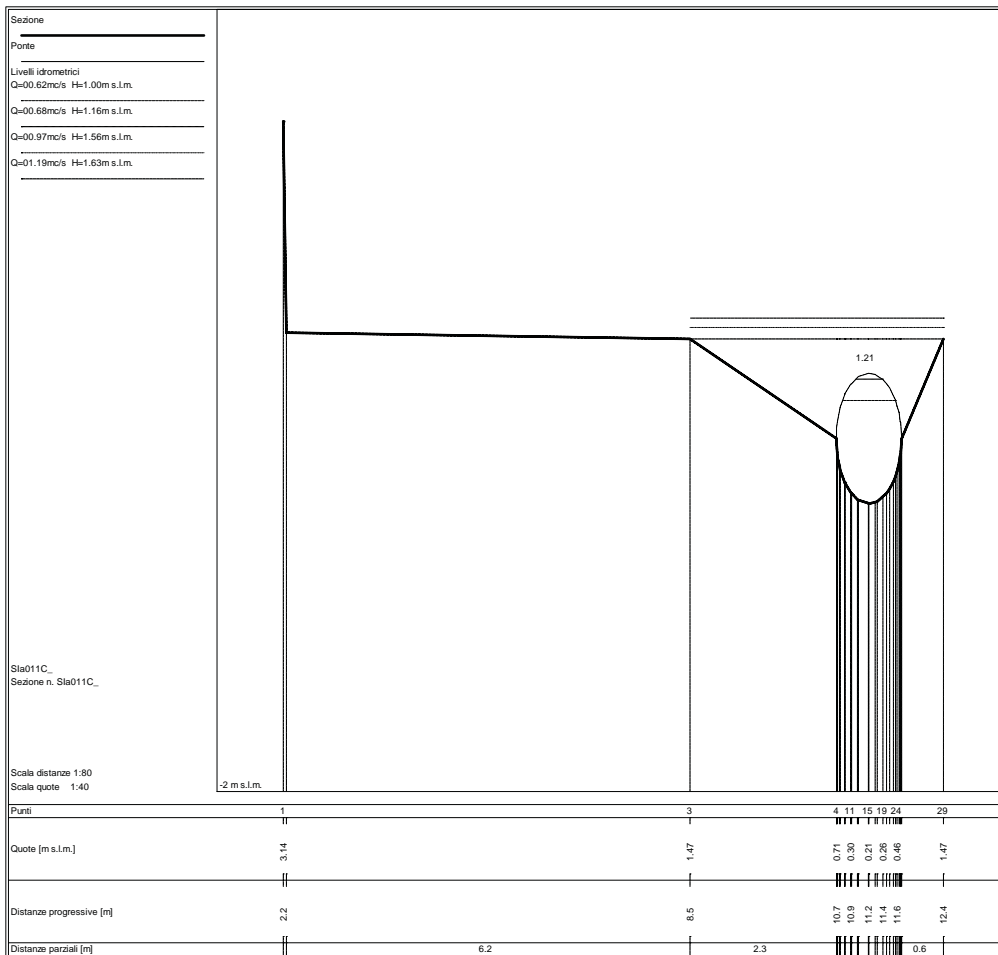
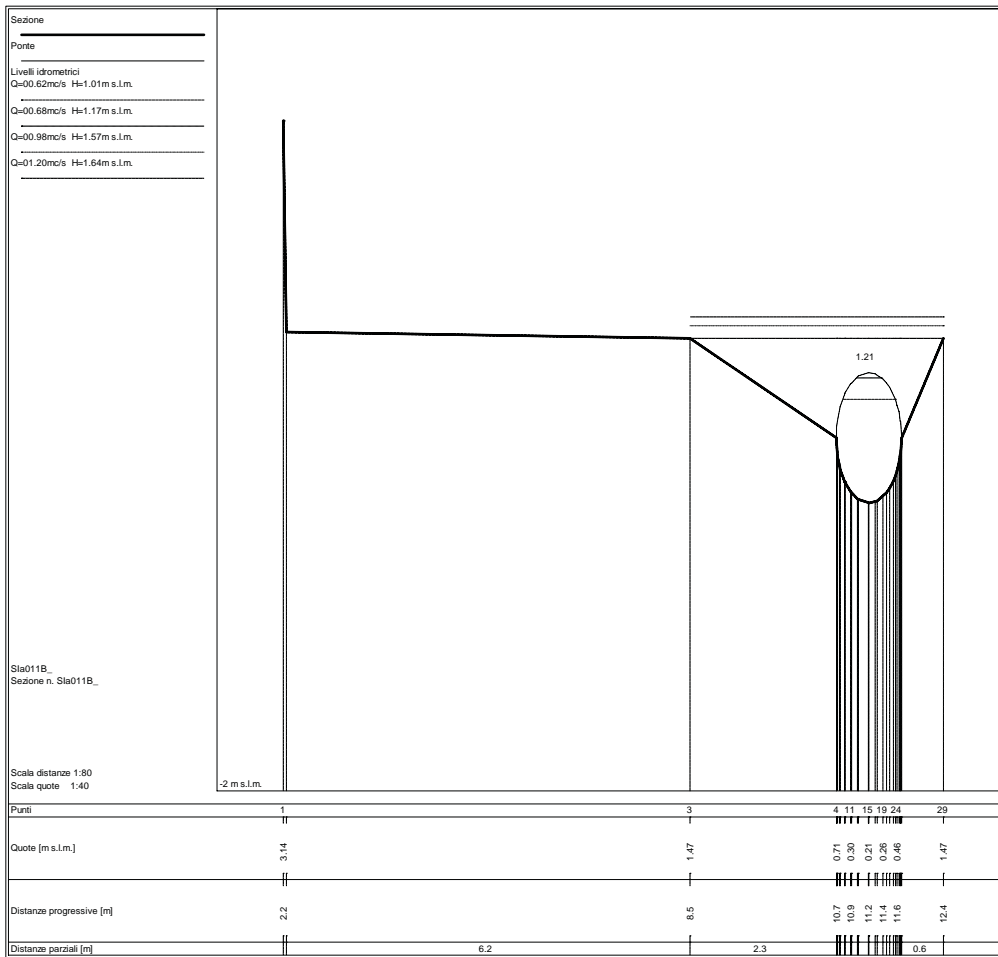

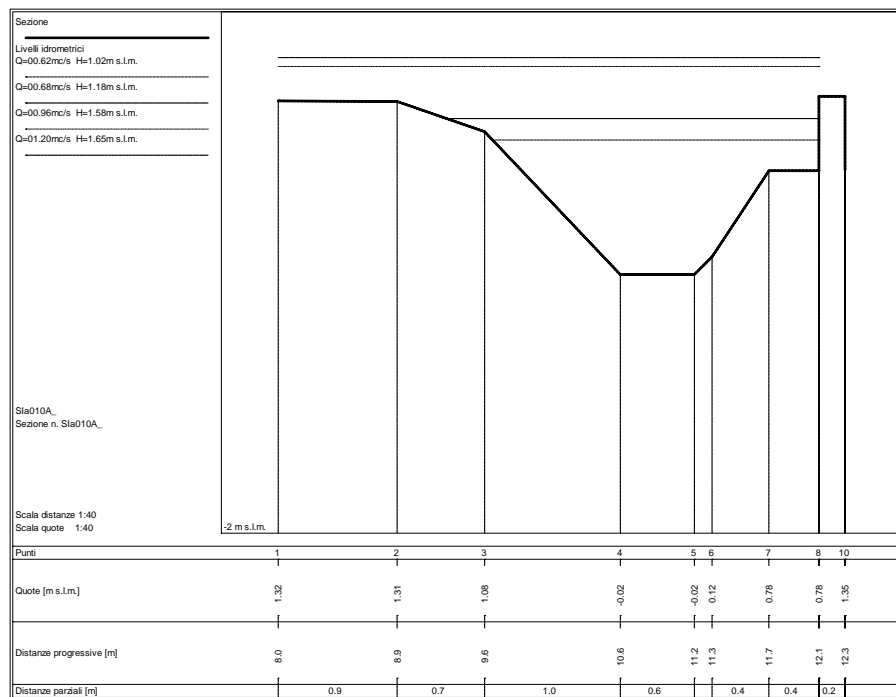
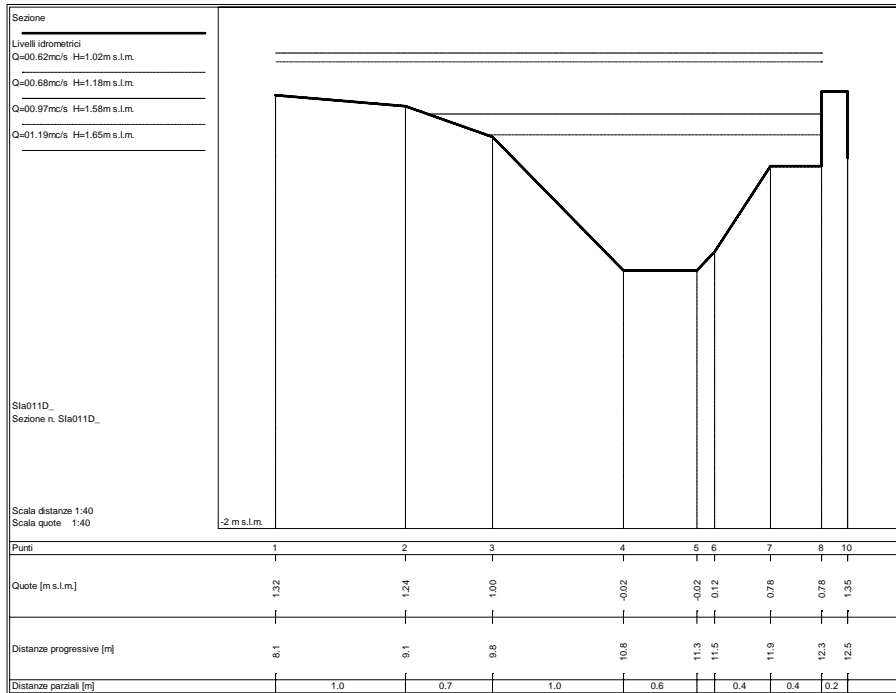

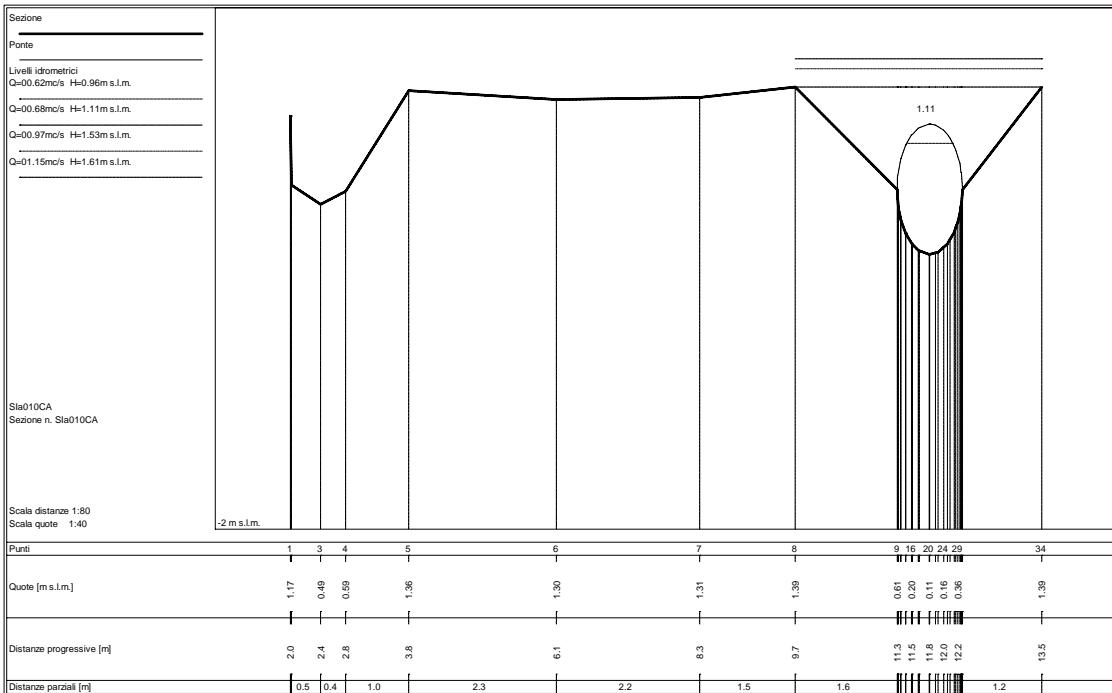
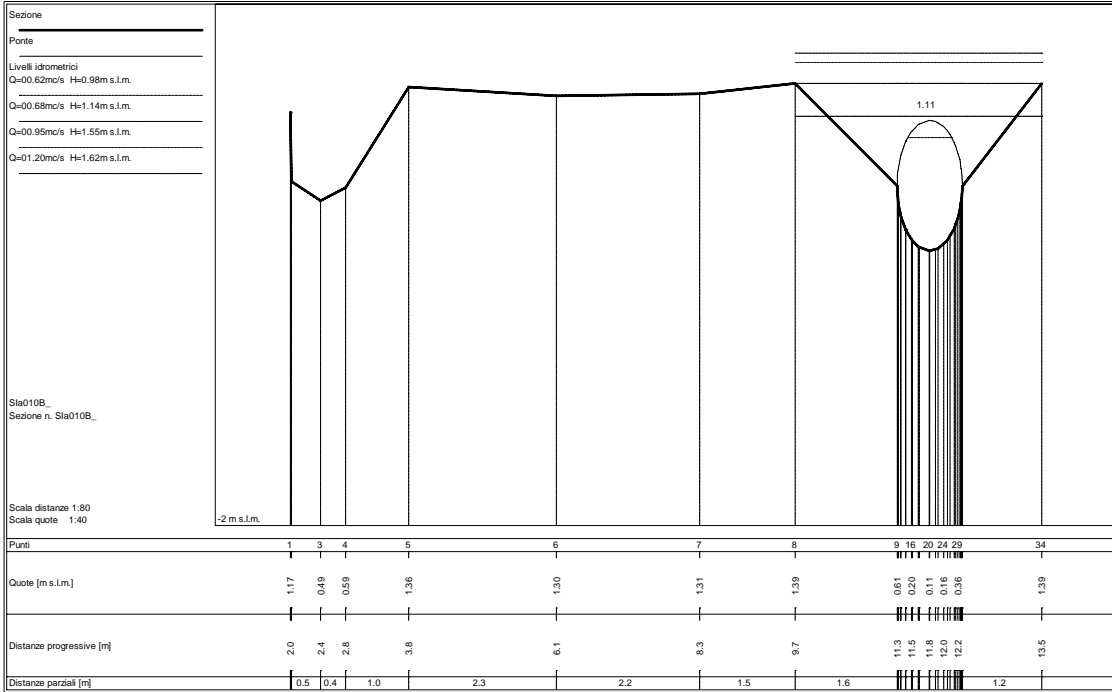

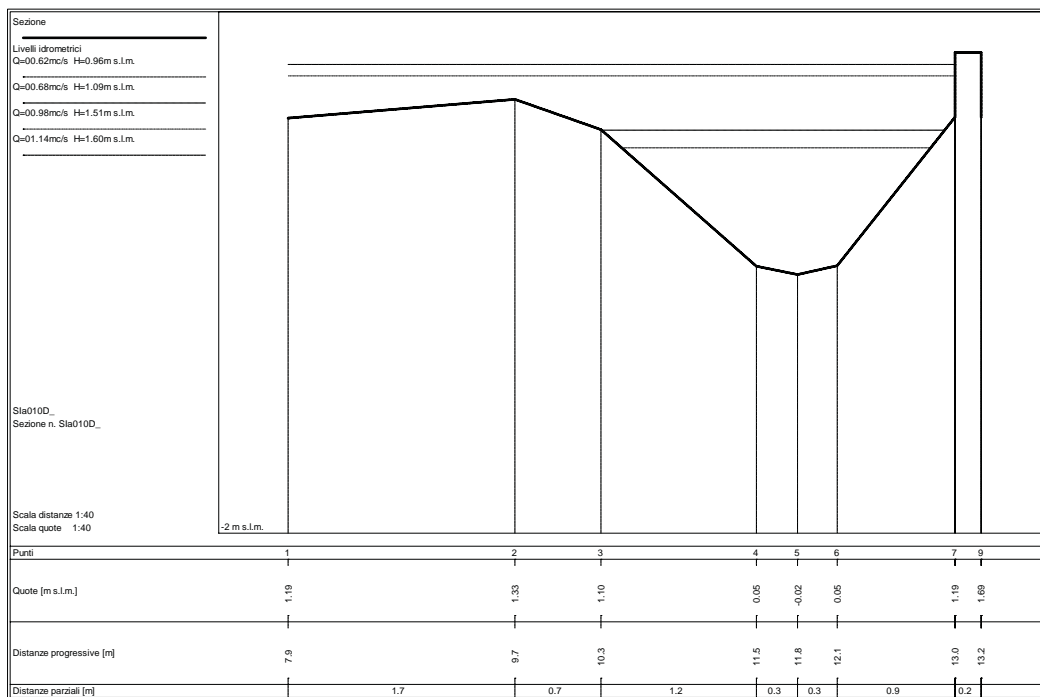
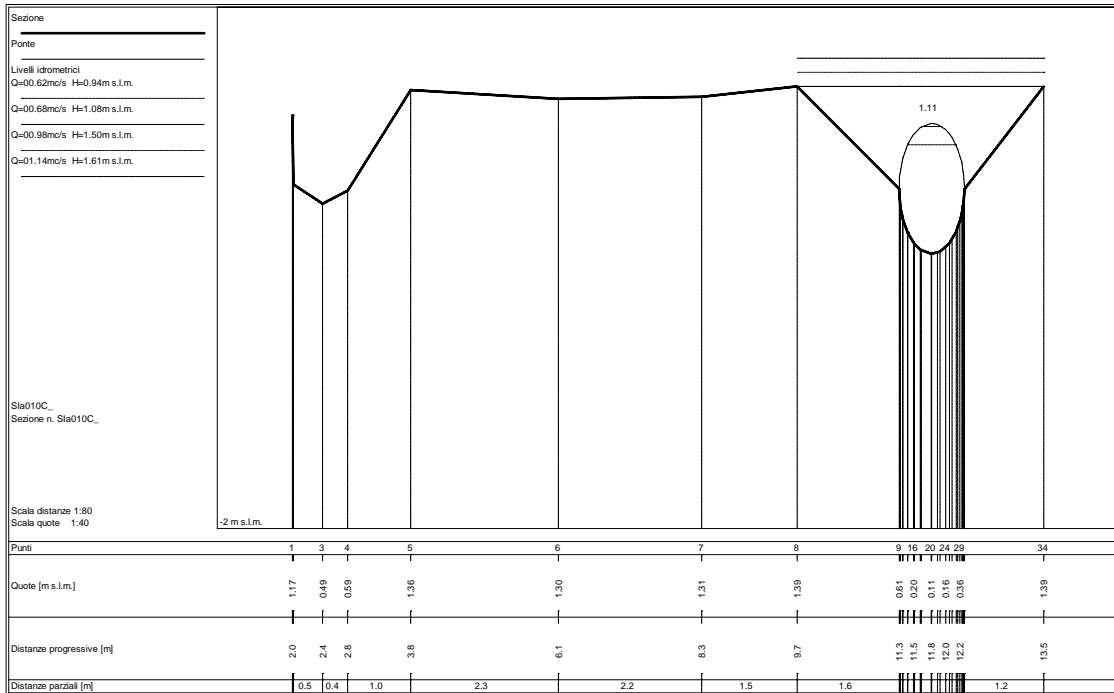

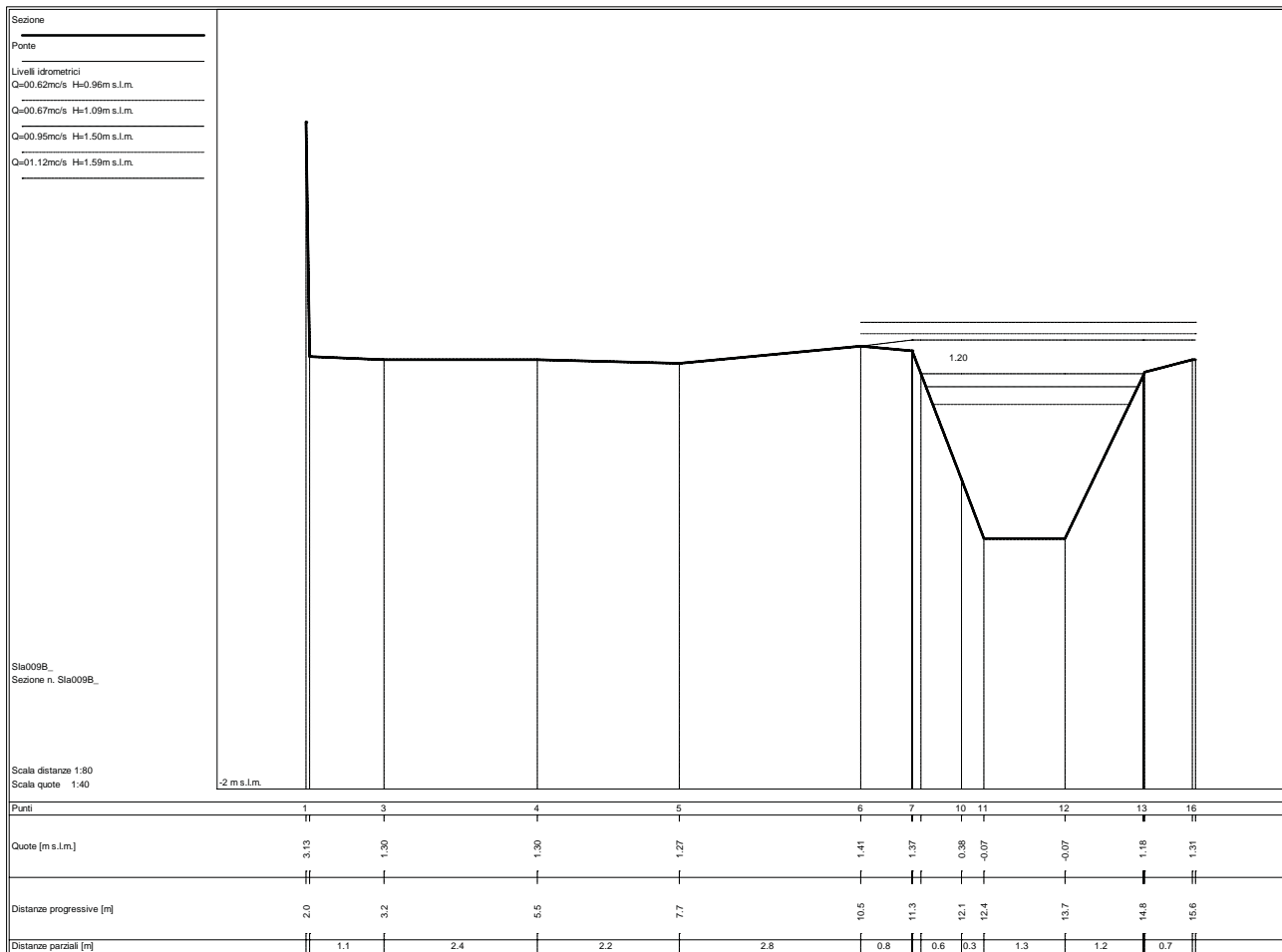
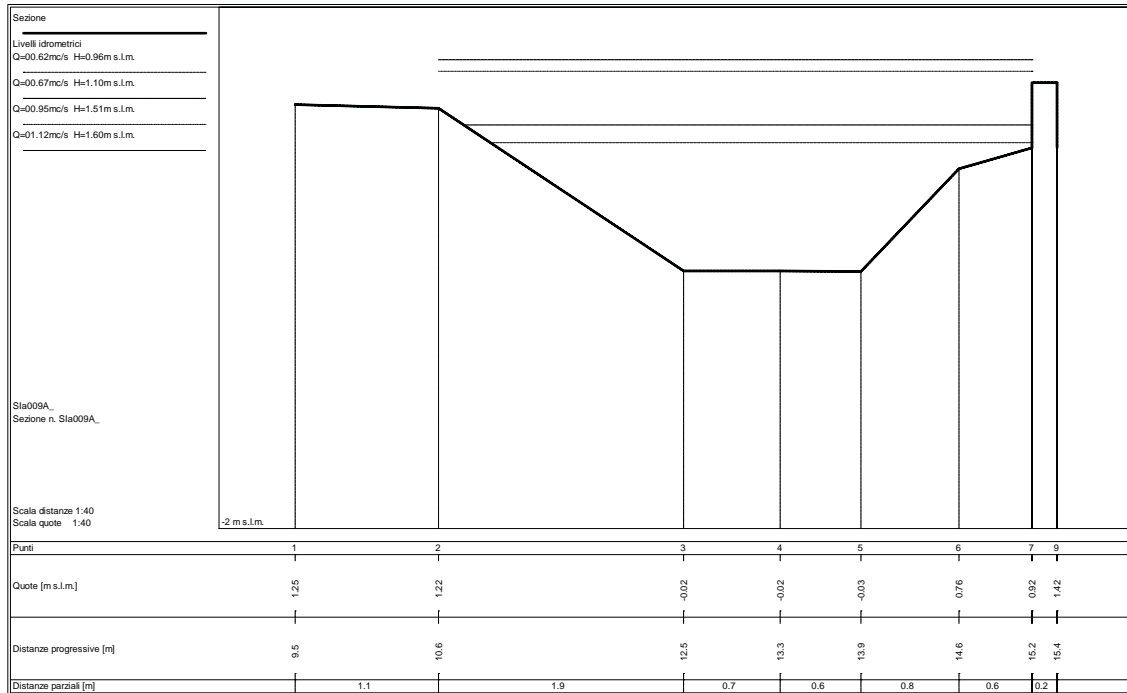

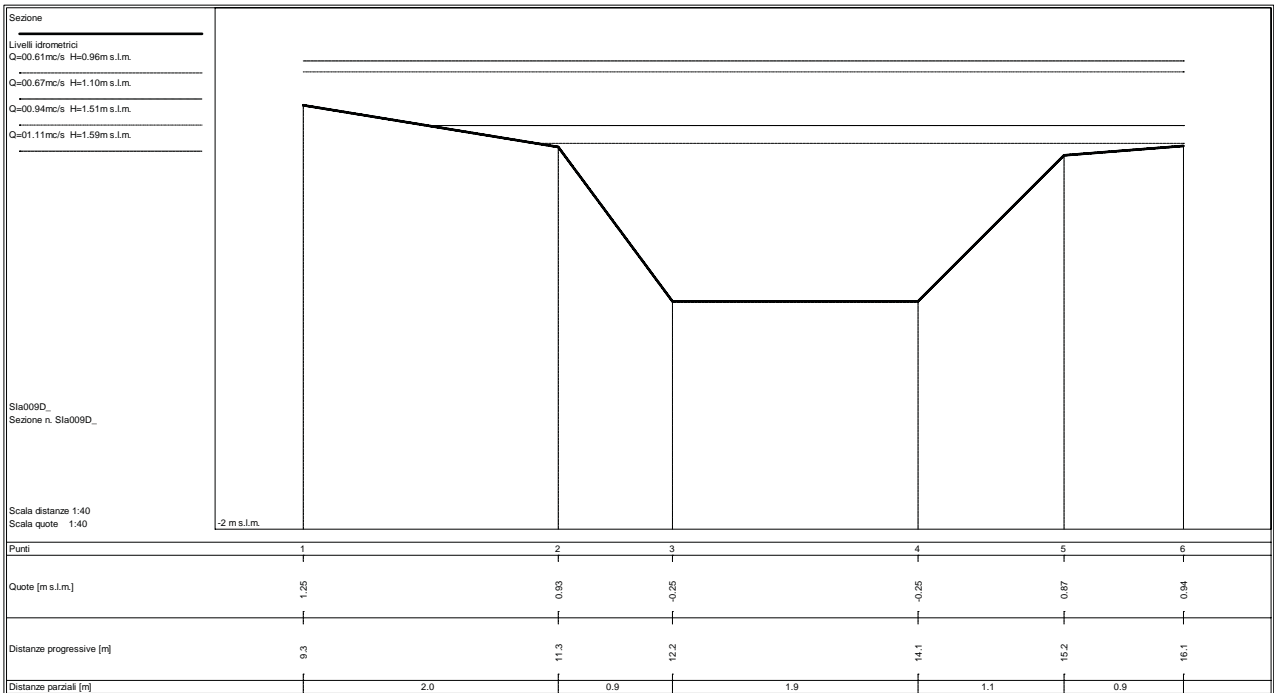
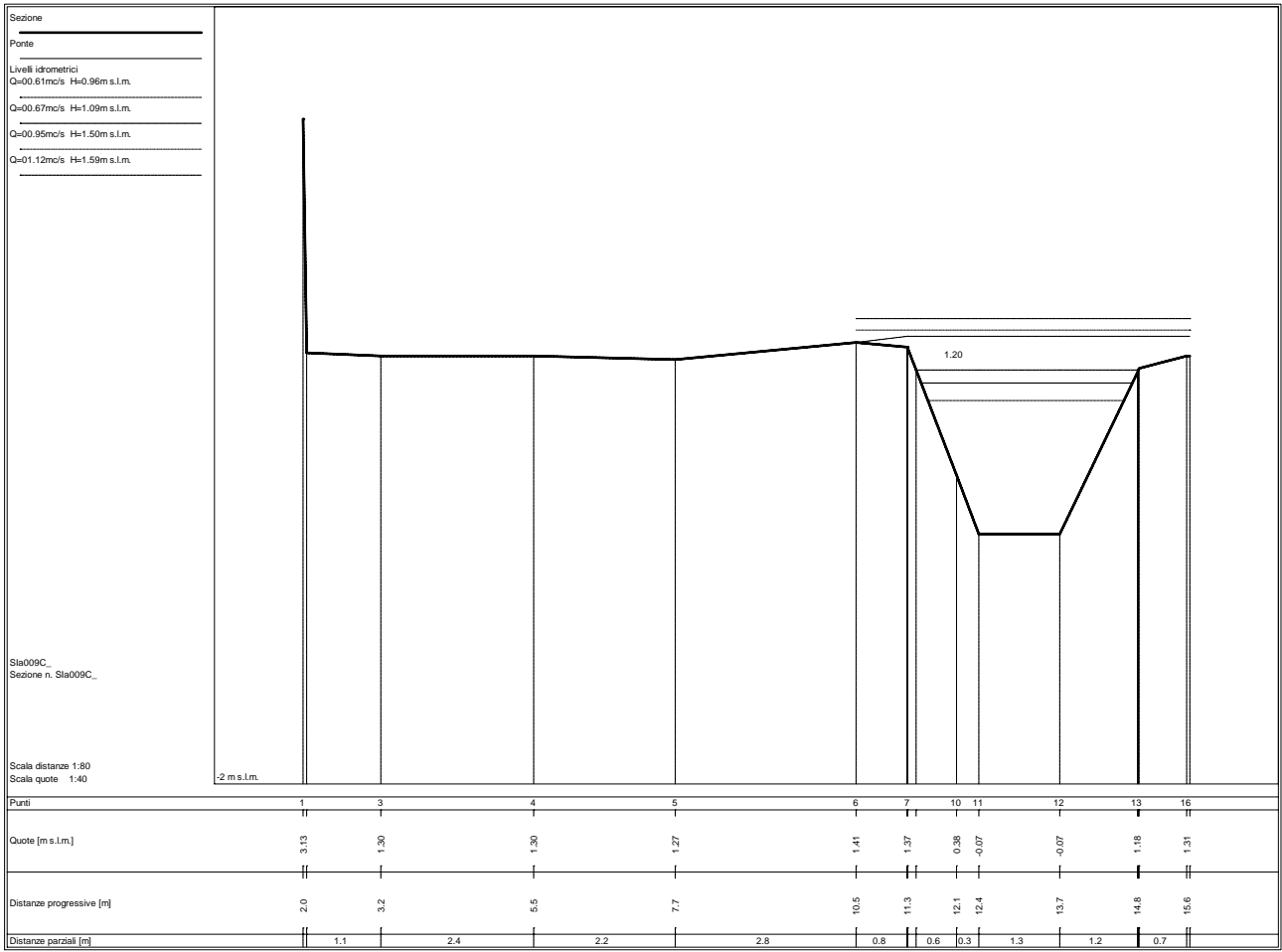

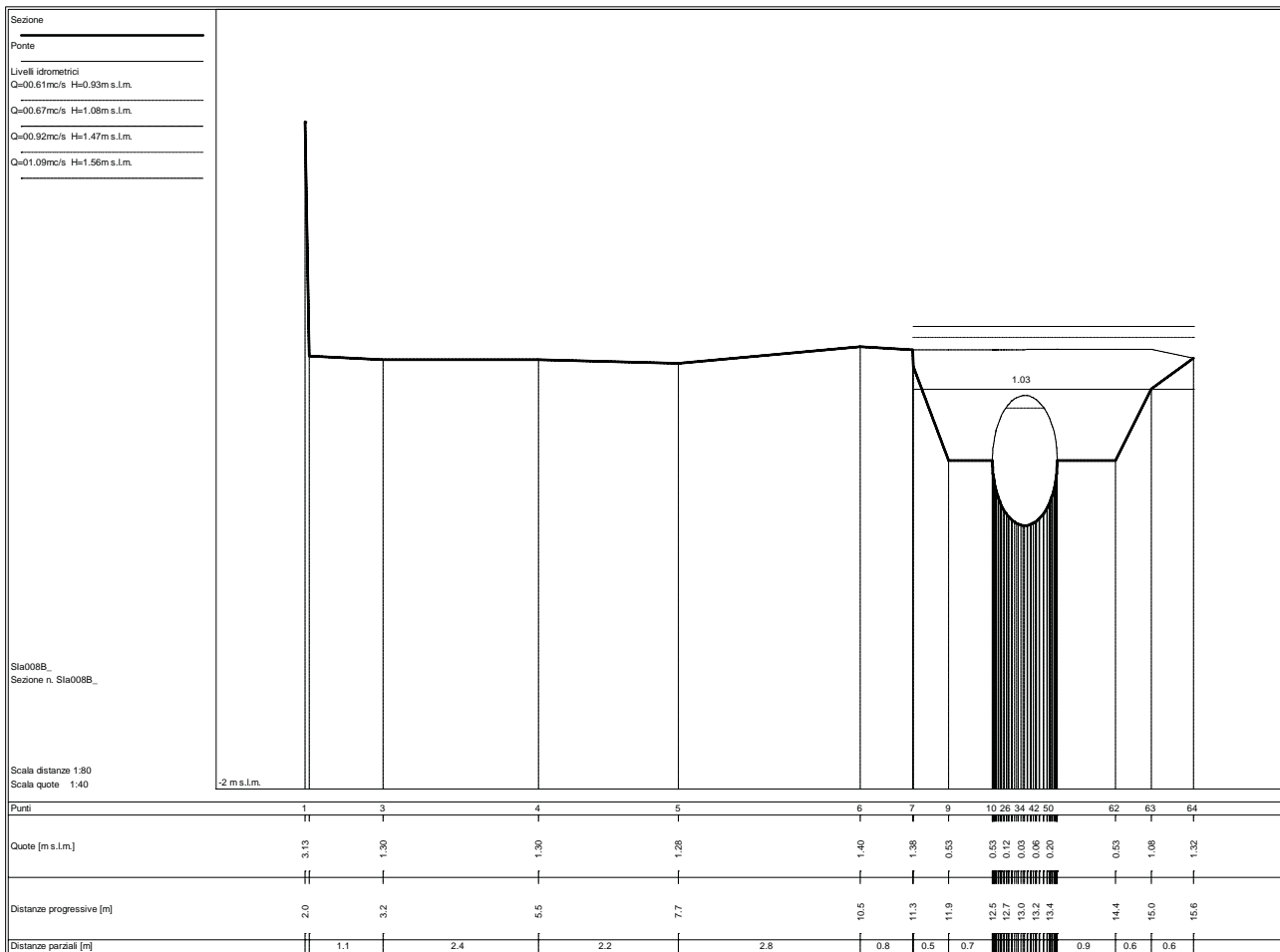
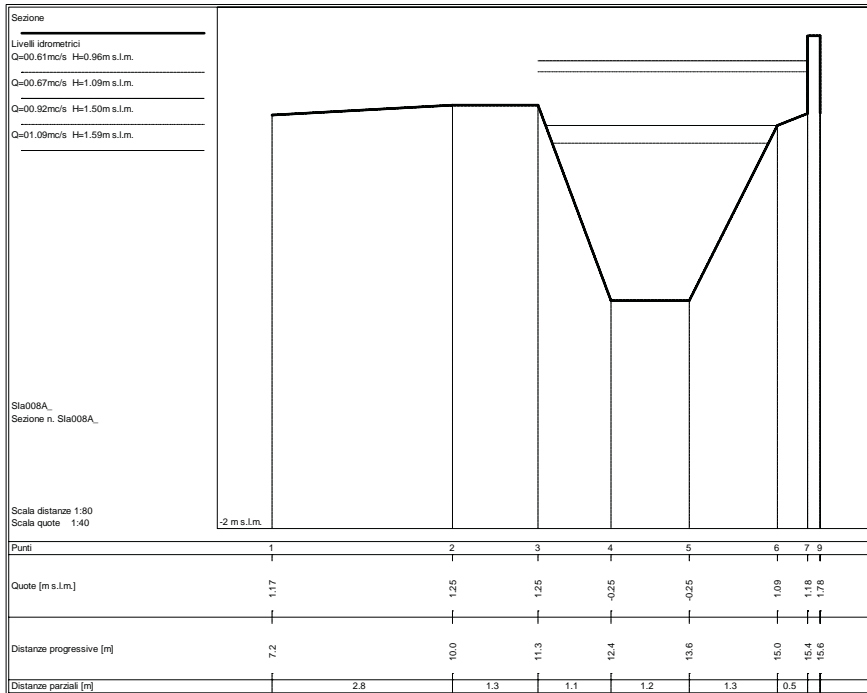

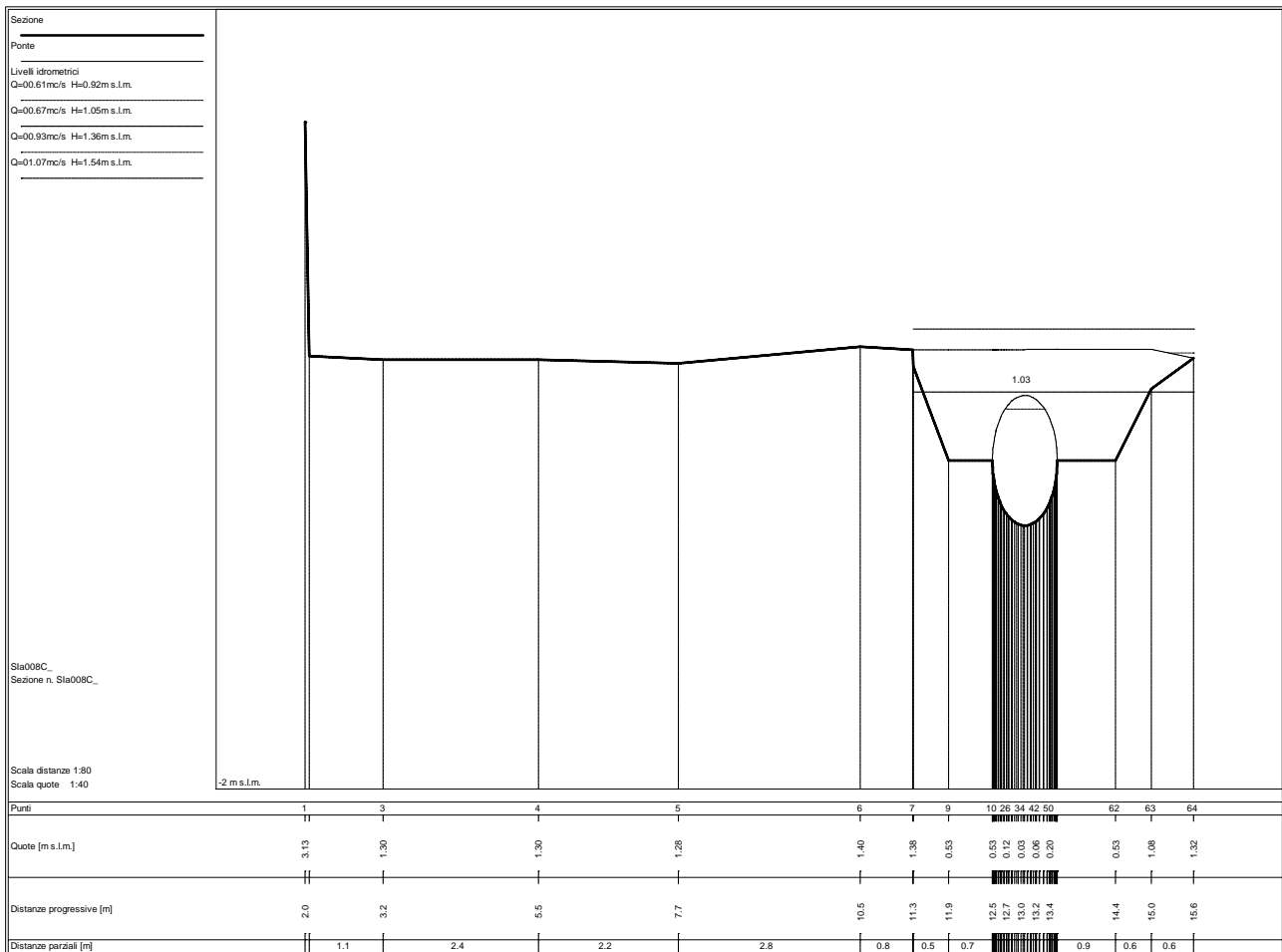
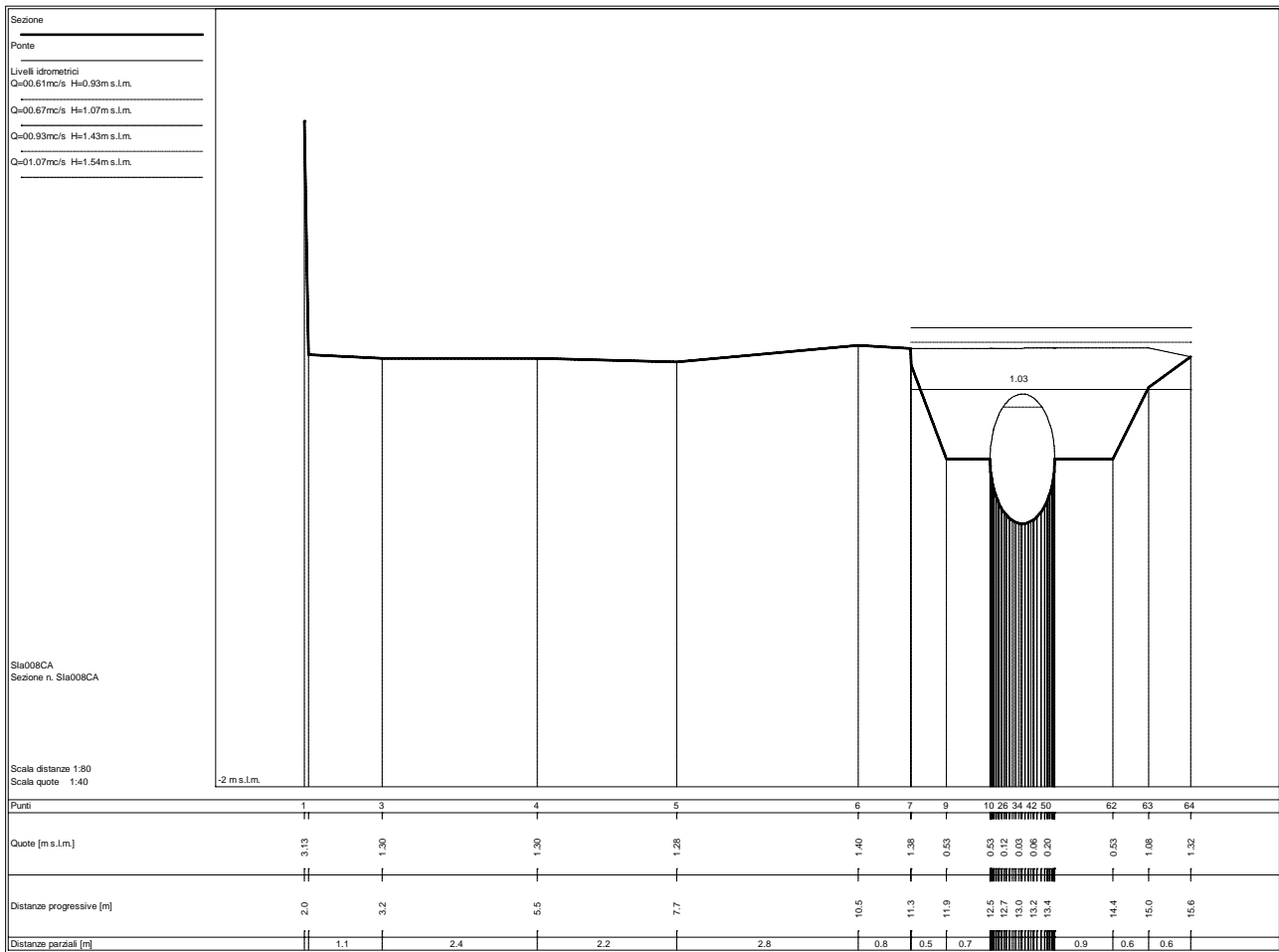

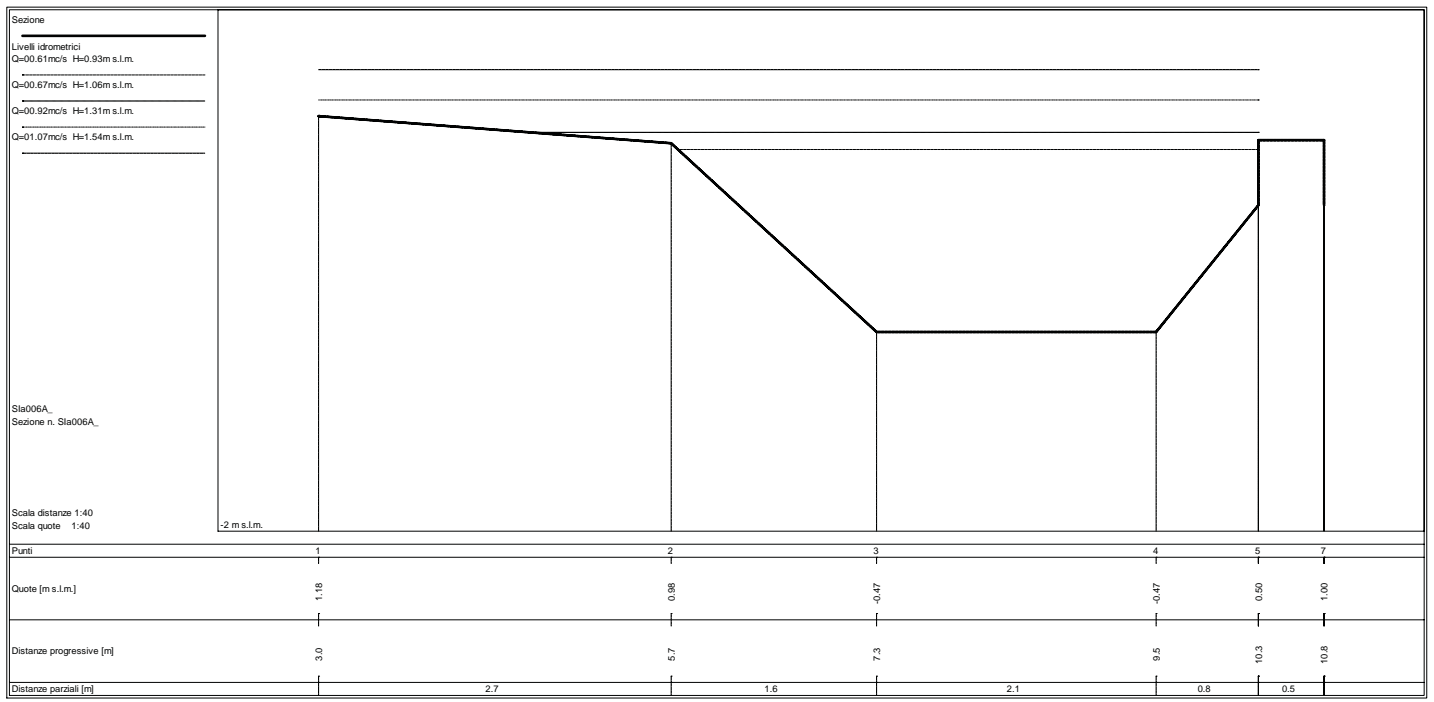
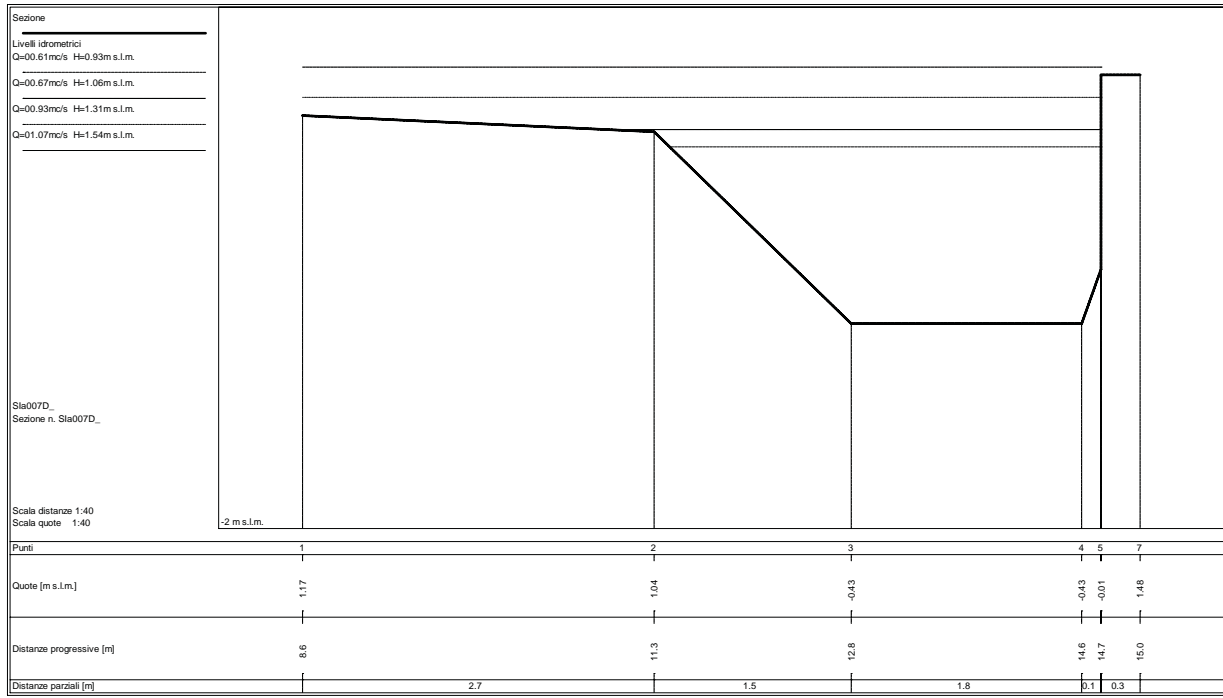

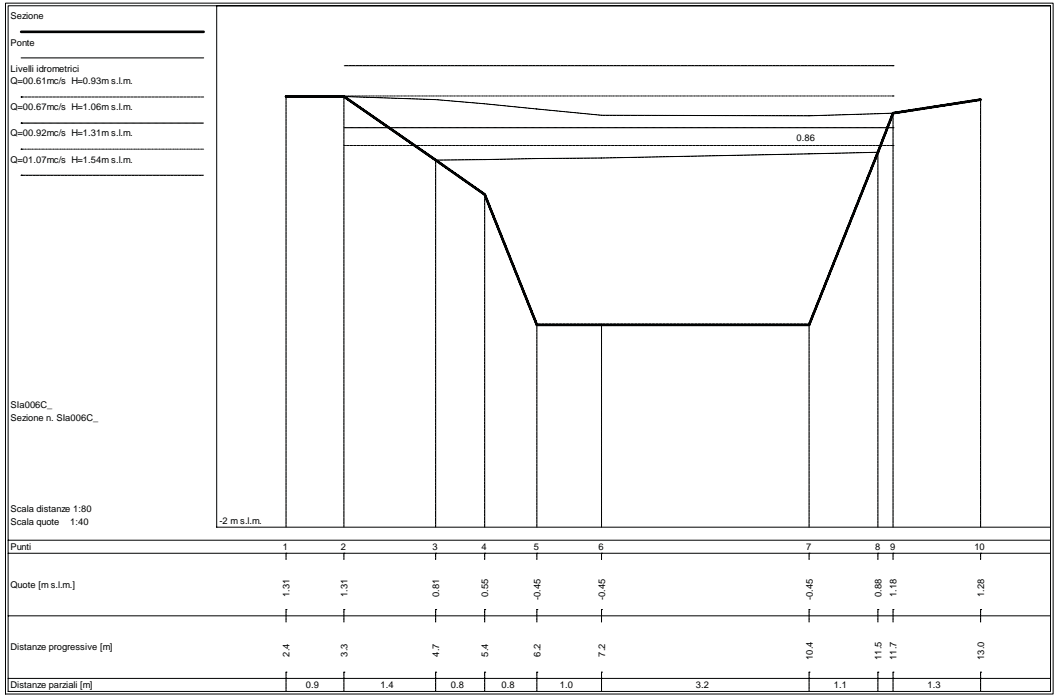
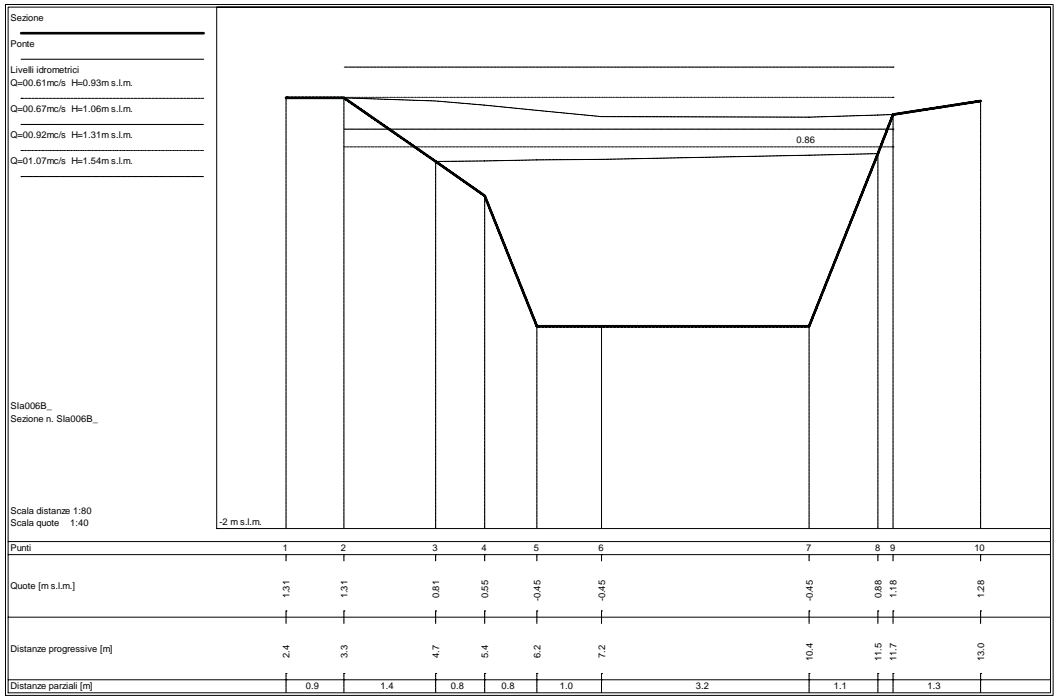

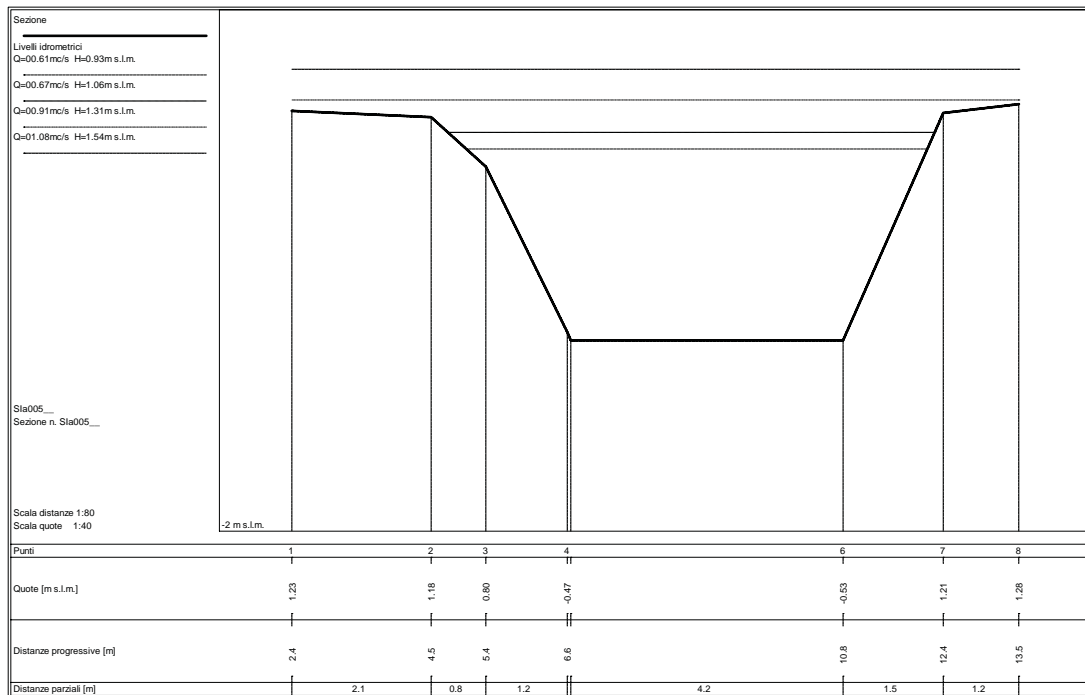
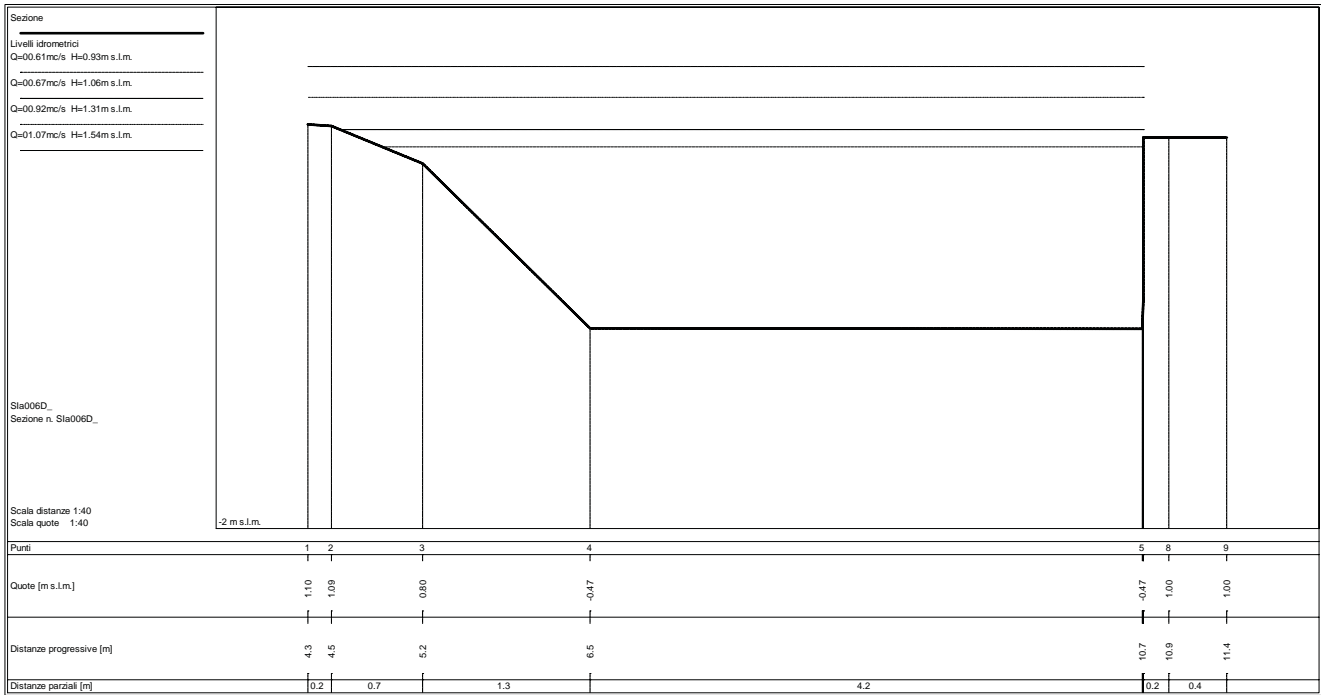

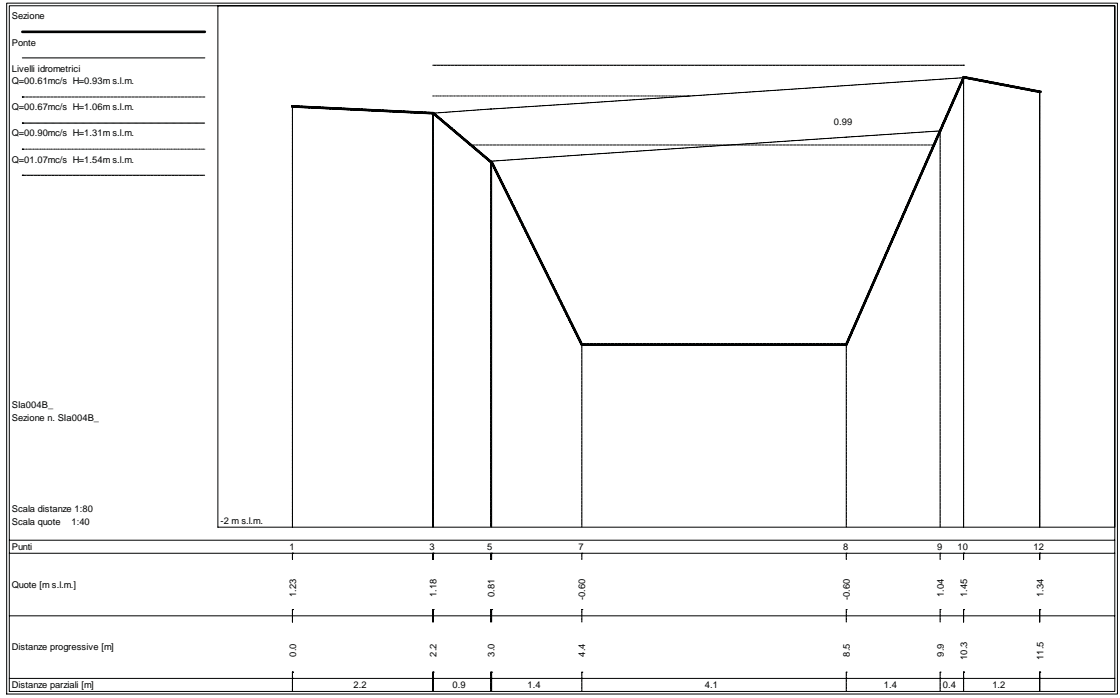
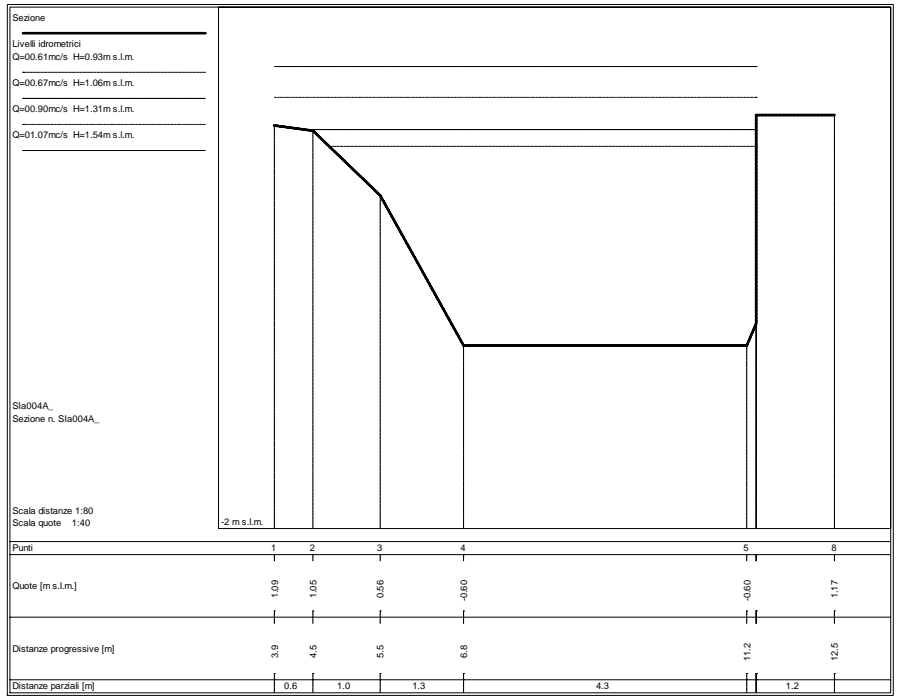

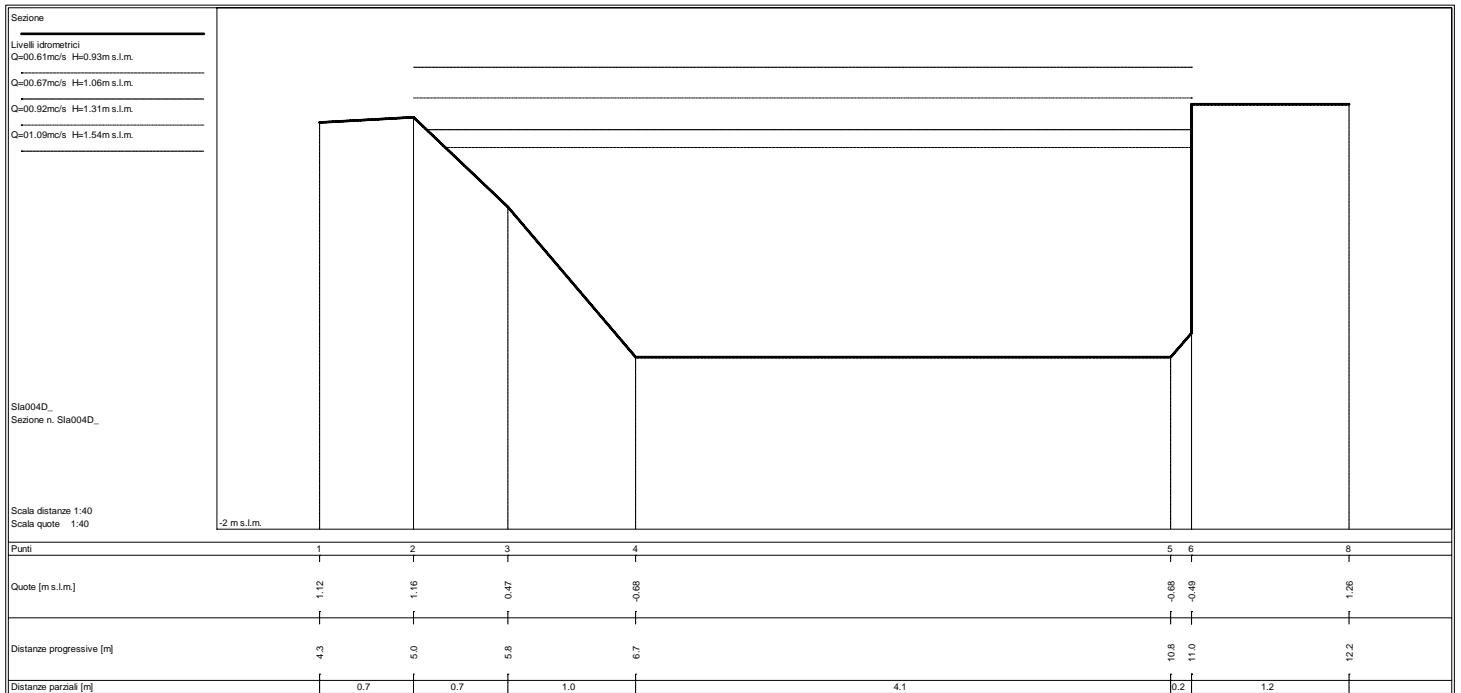
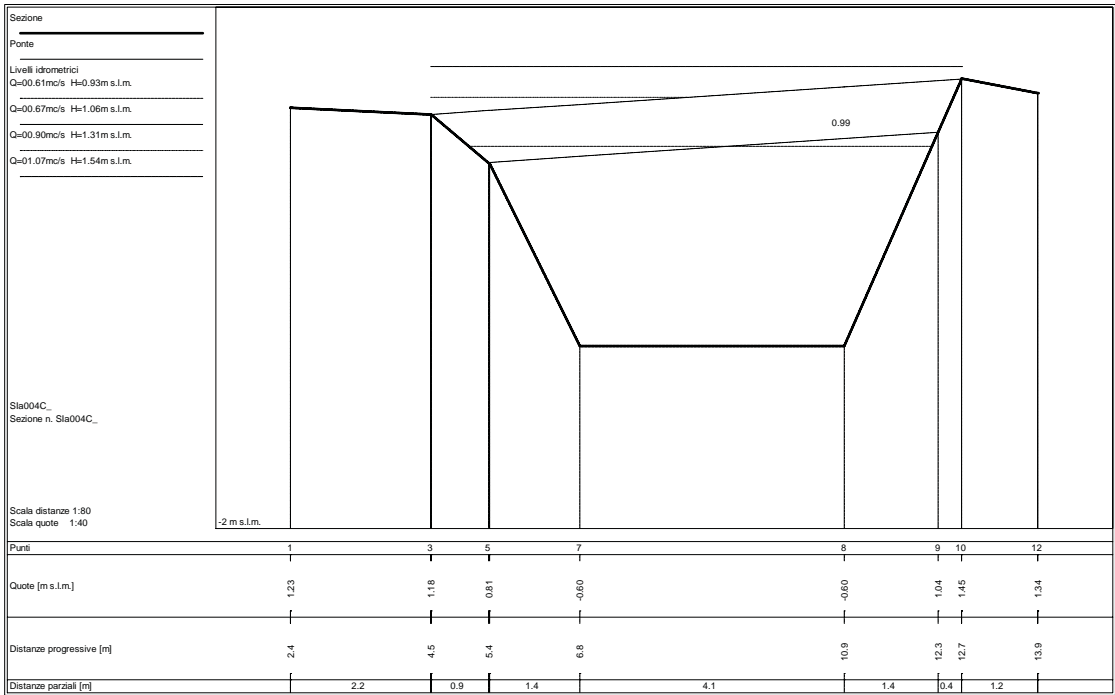

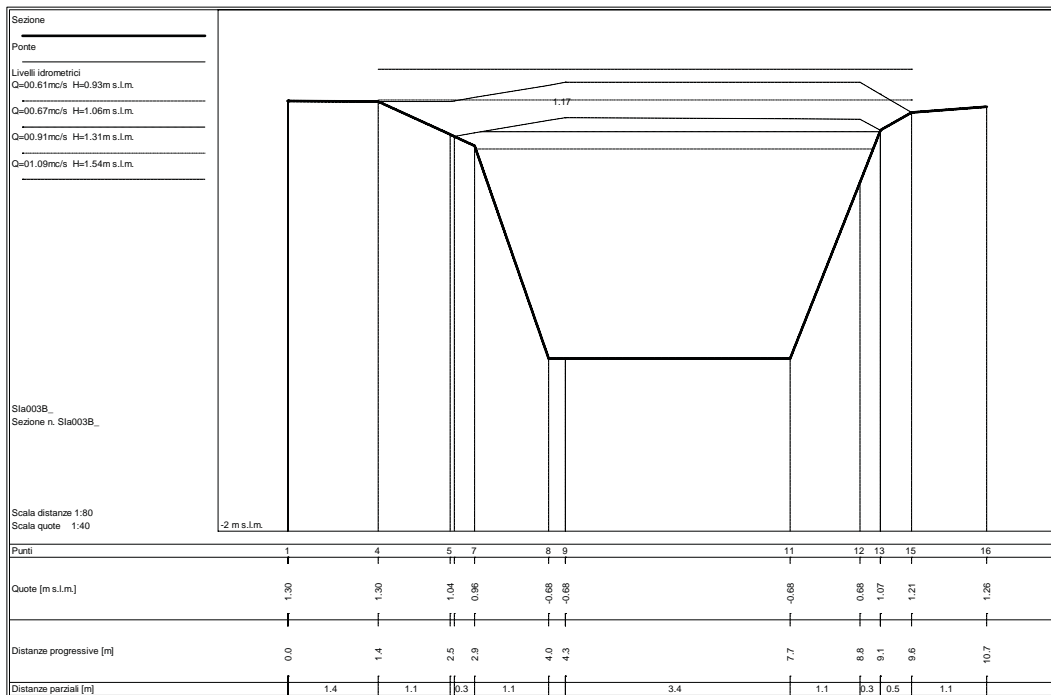
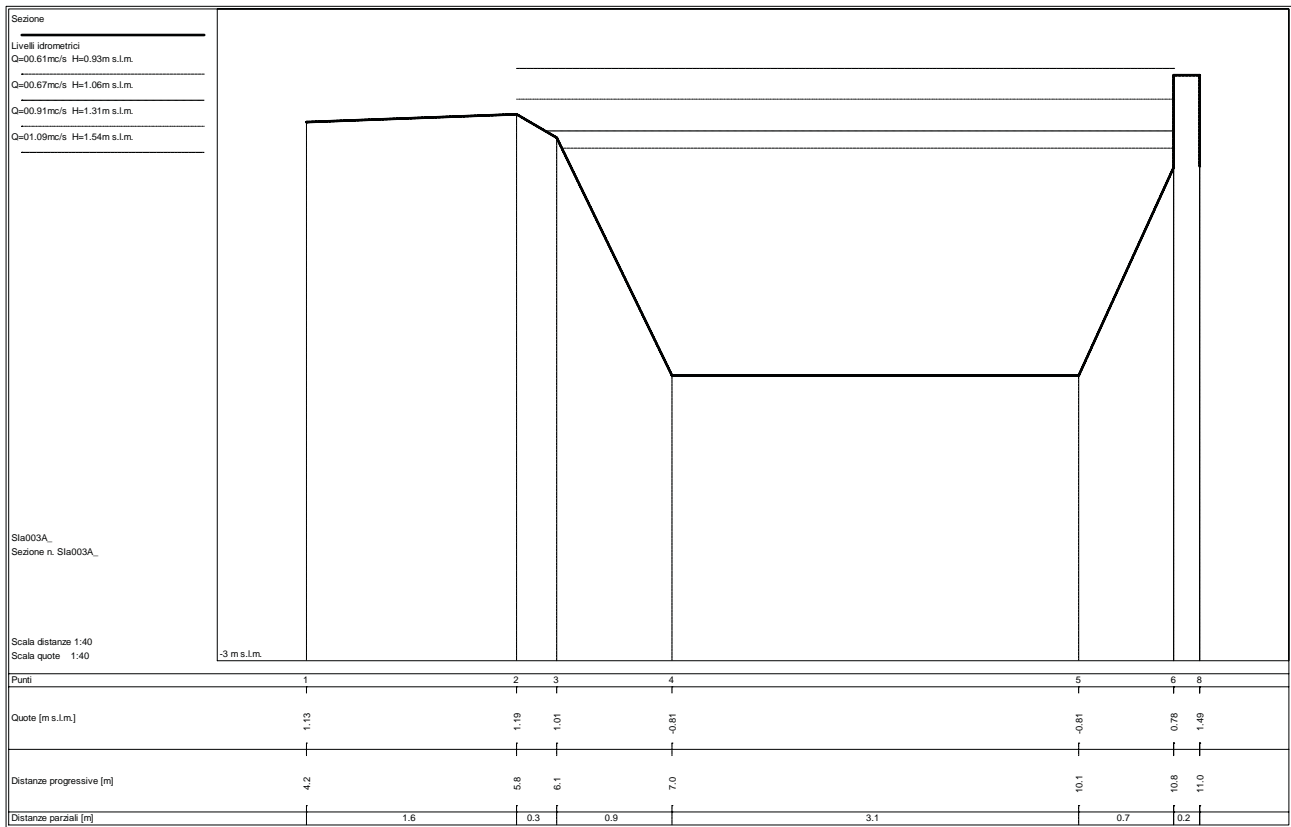

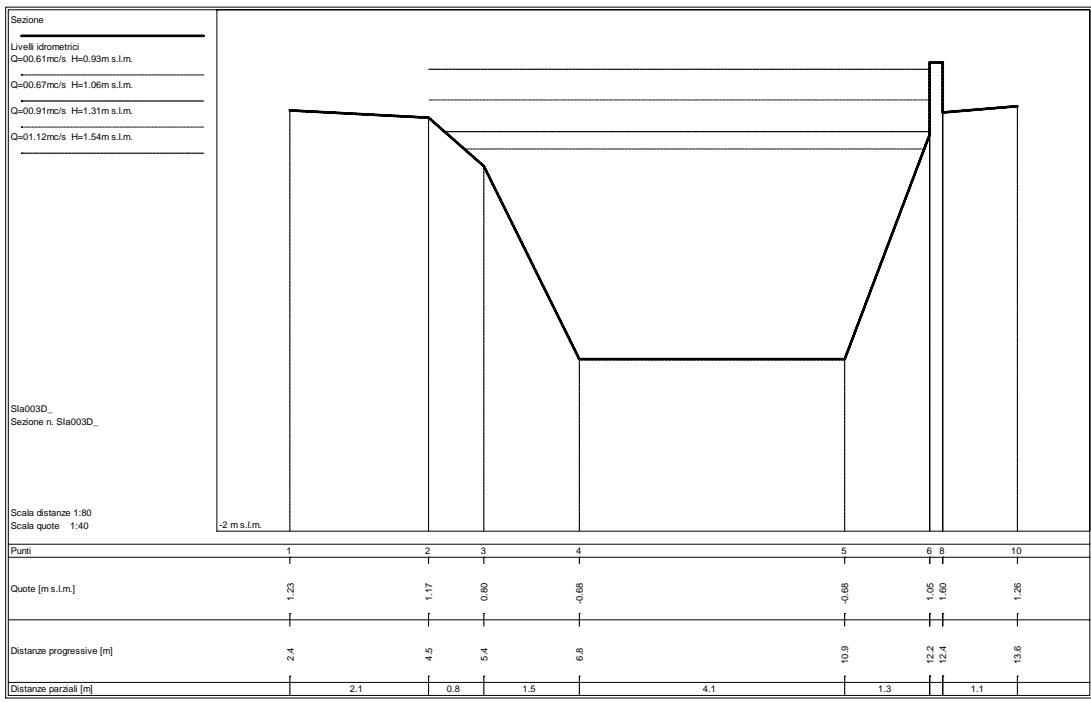
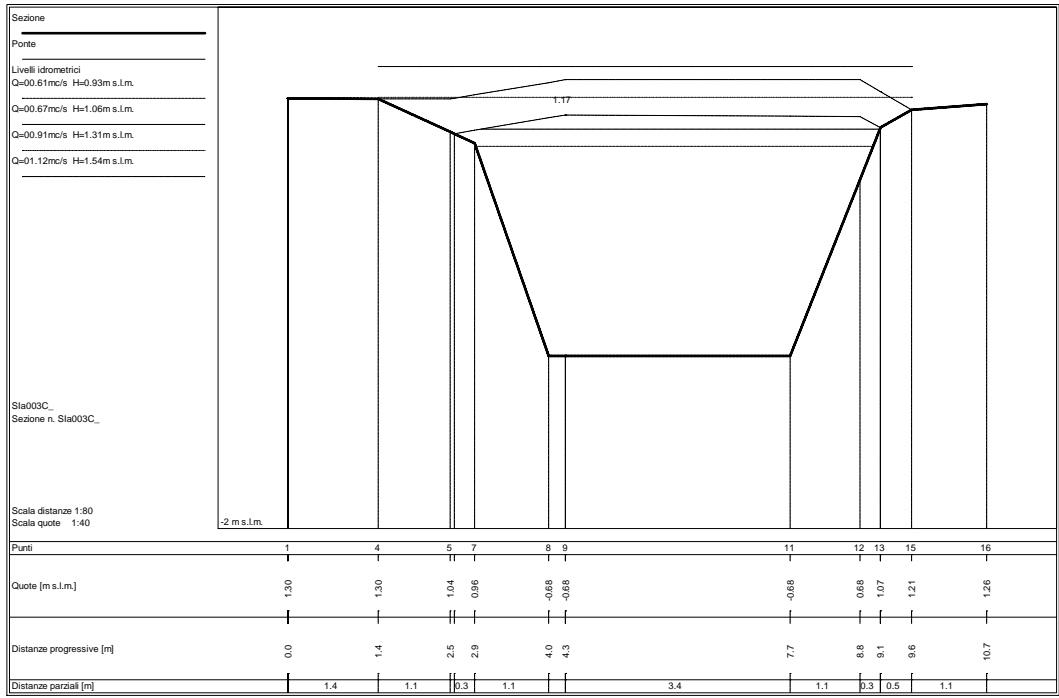

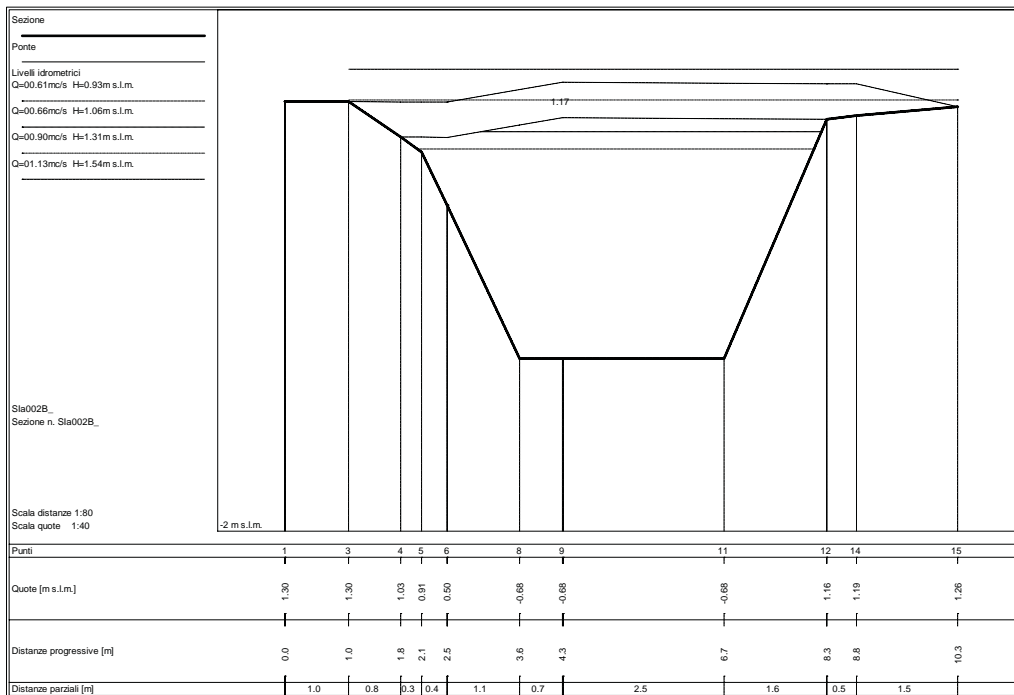
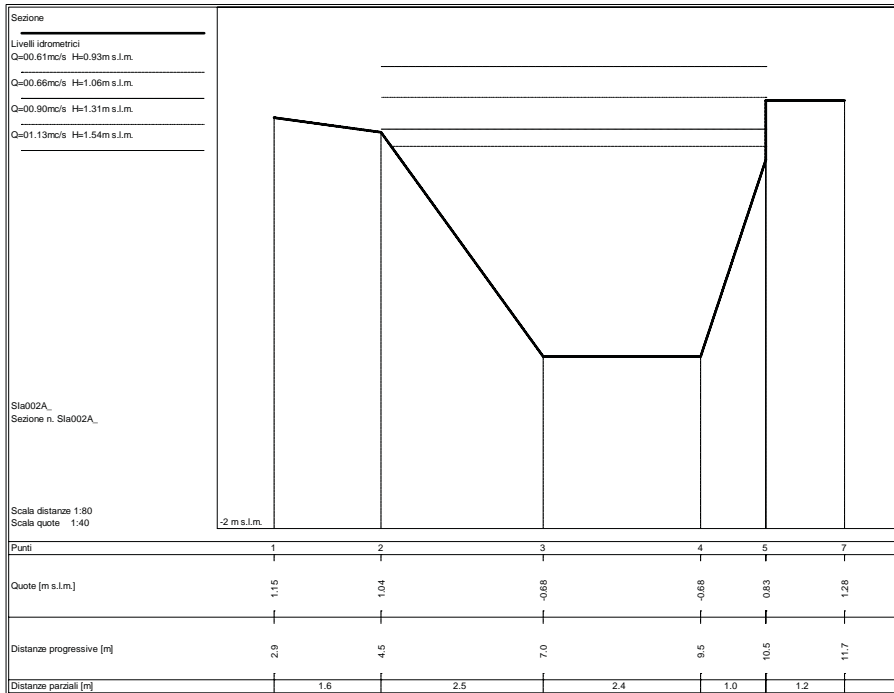

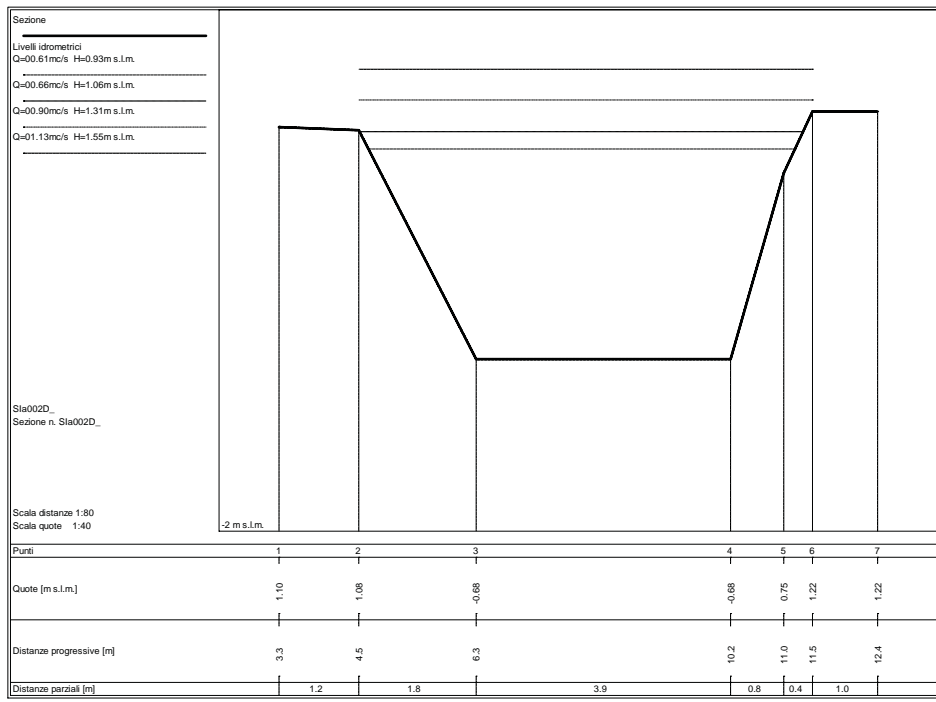
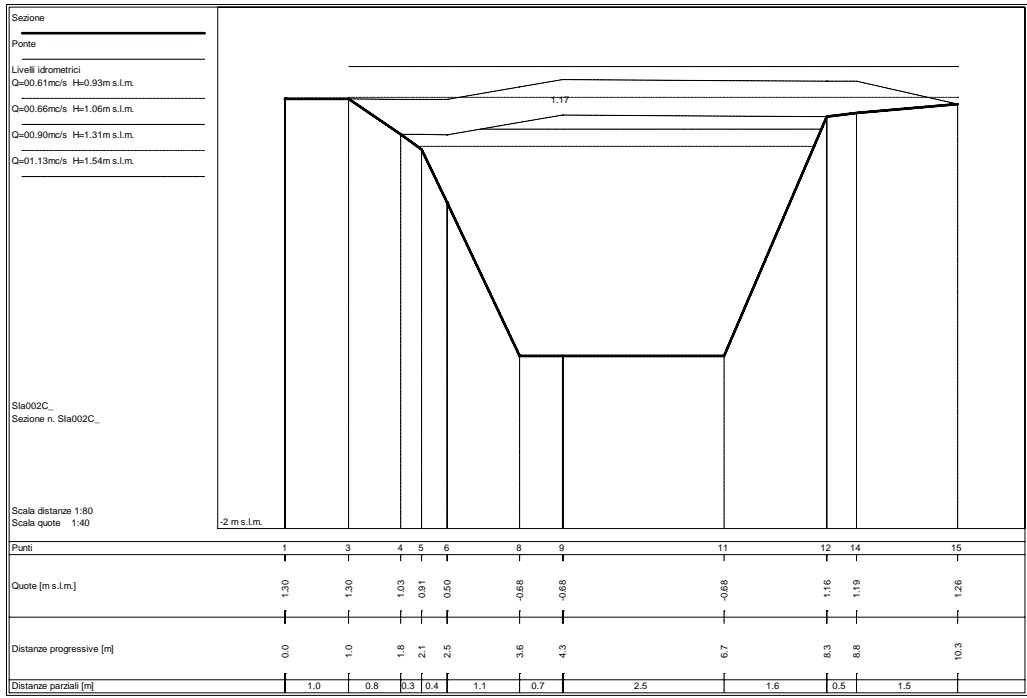

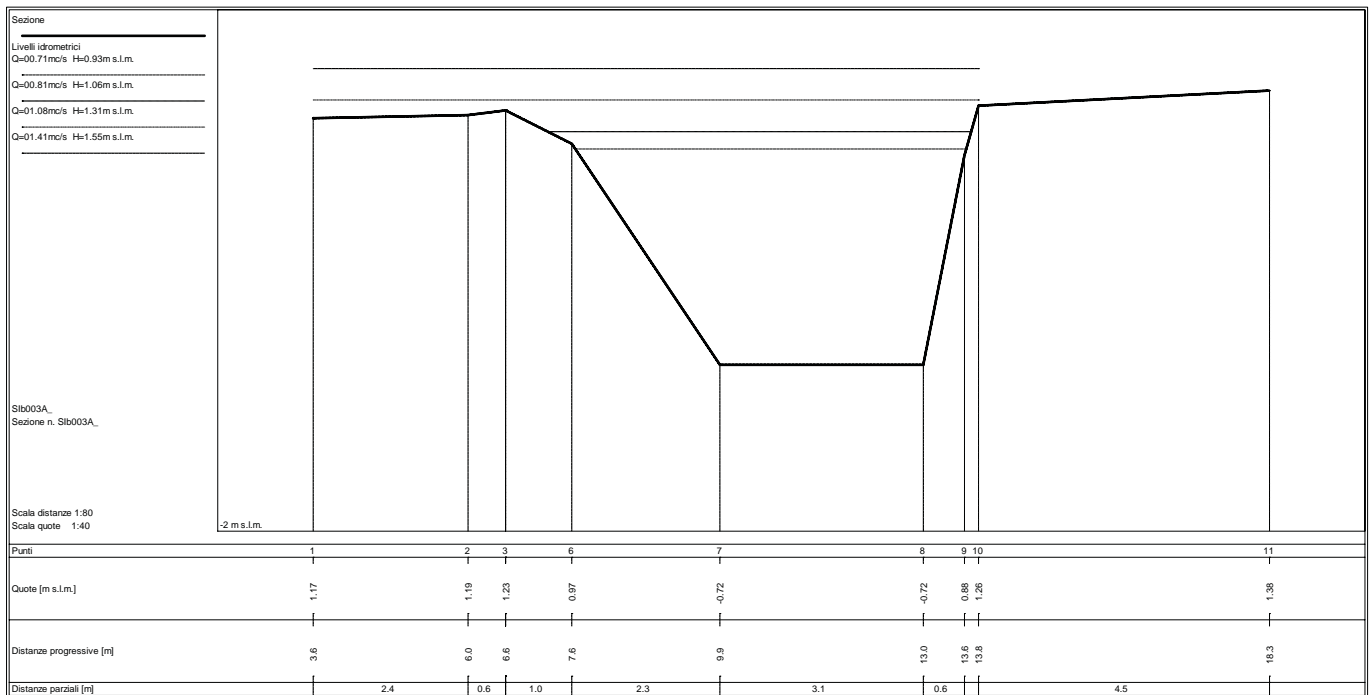
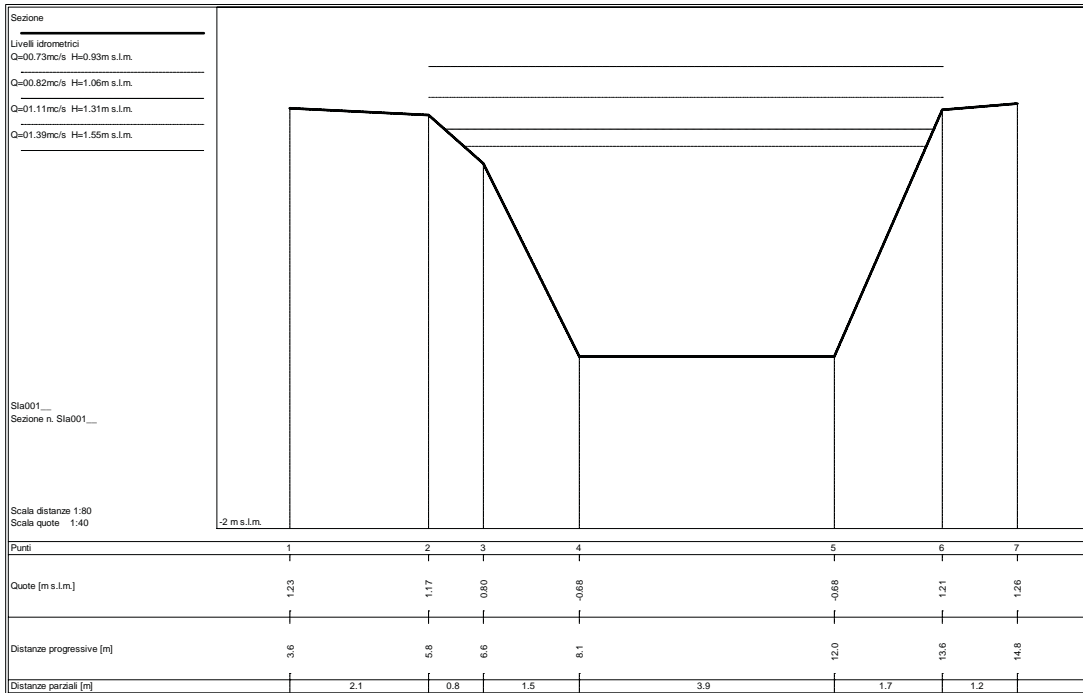

STATO ATTUALE

Sezioni fluviali fosso Silcia – SI_b_P

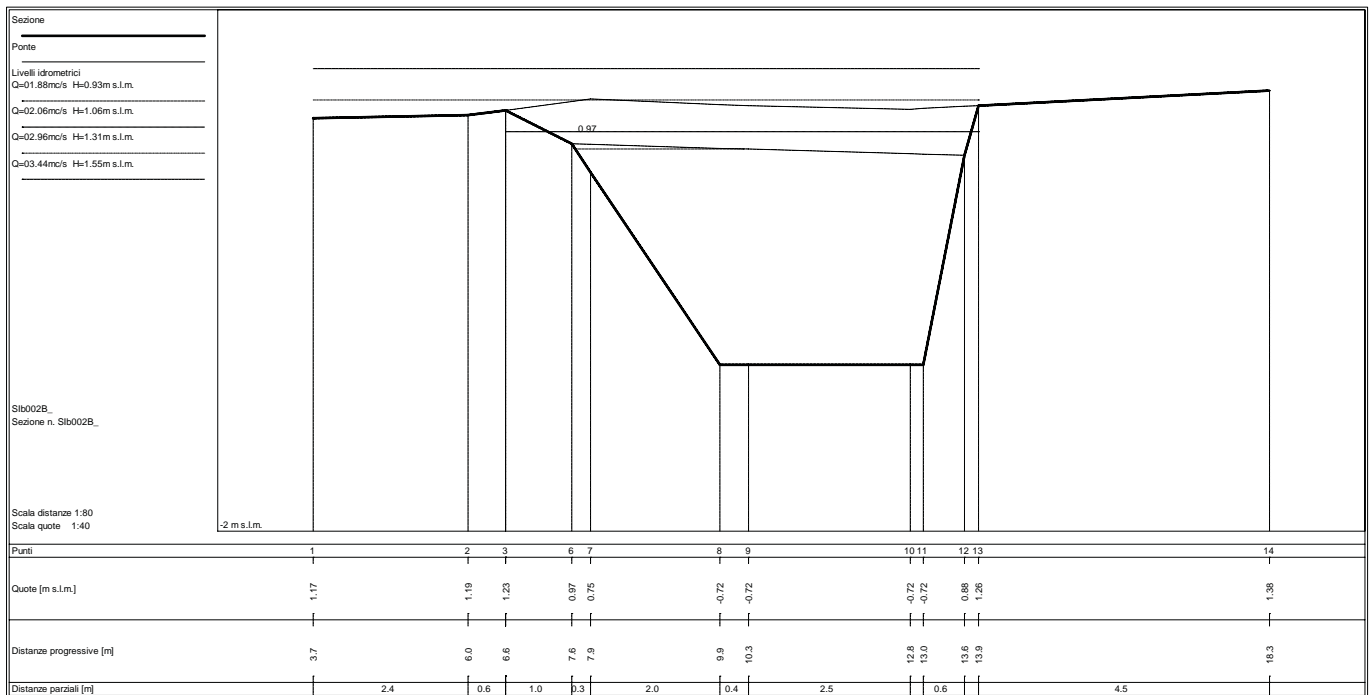
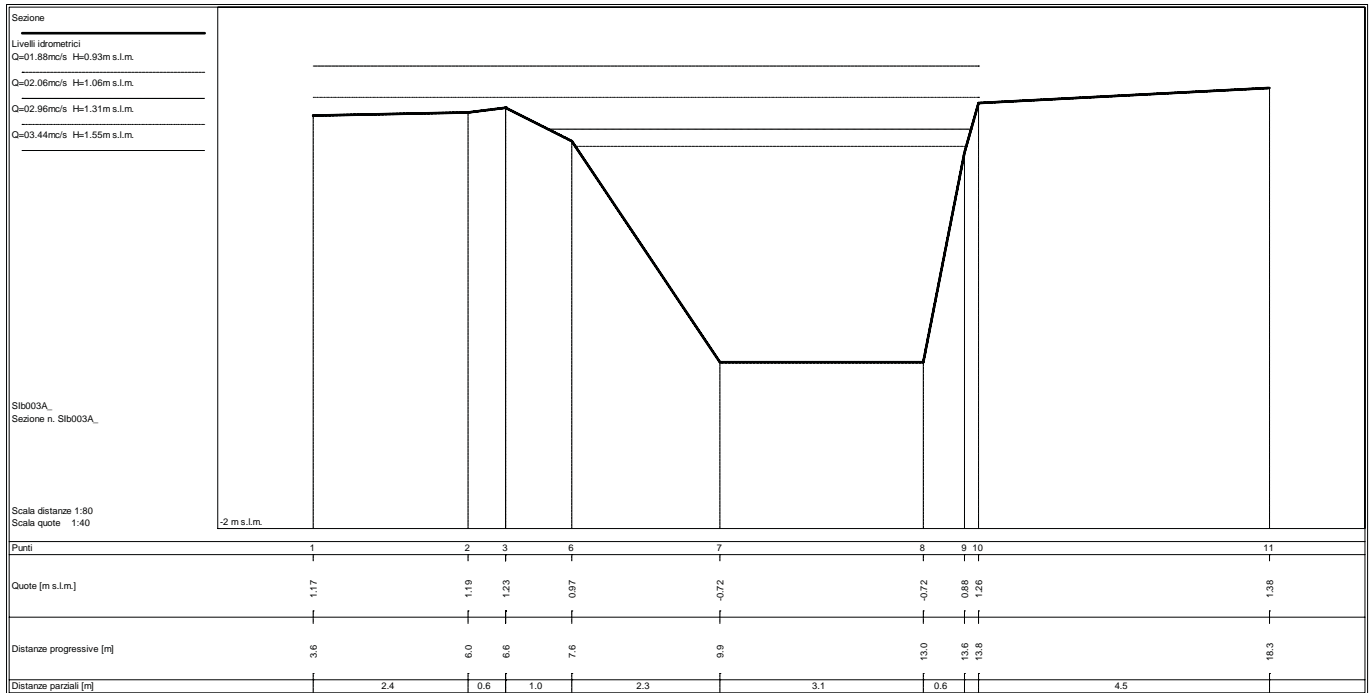

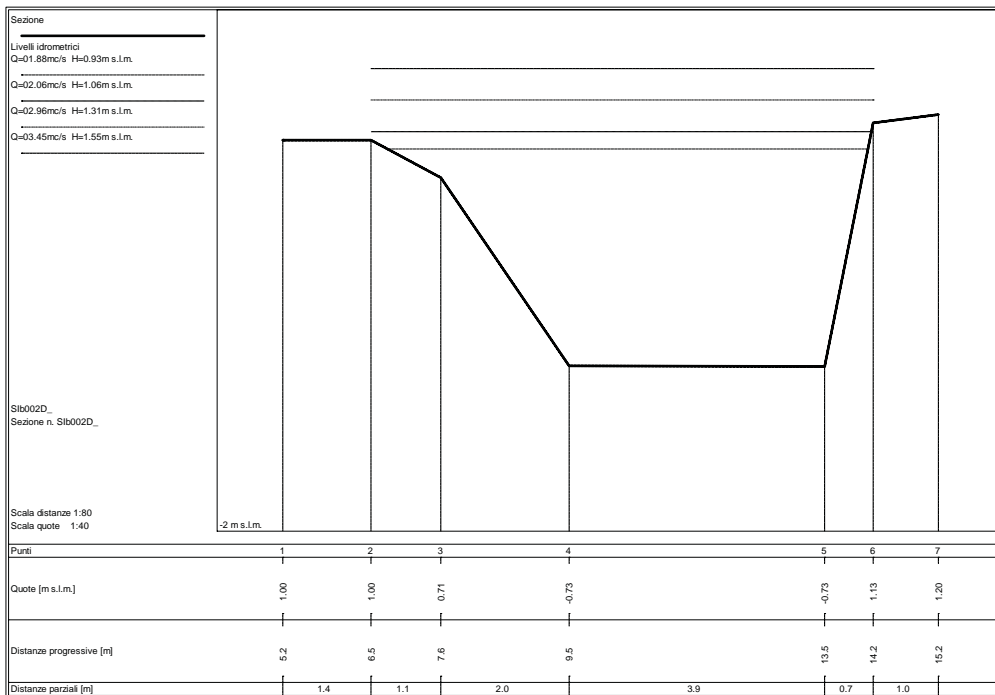
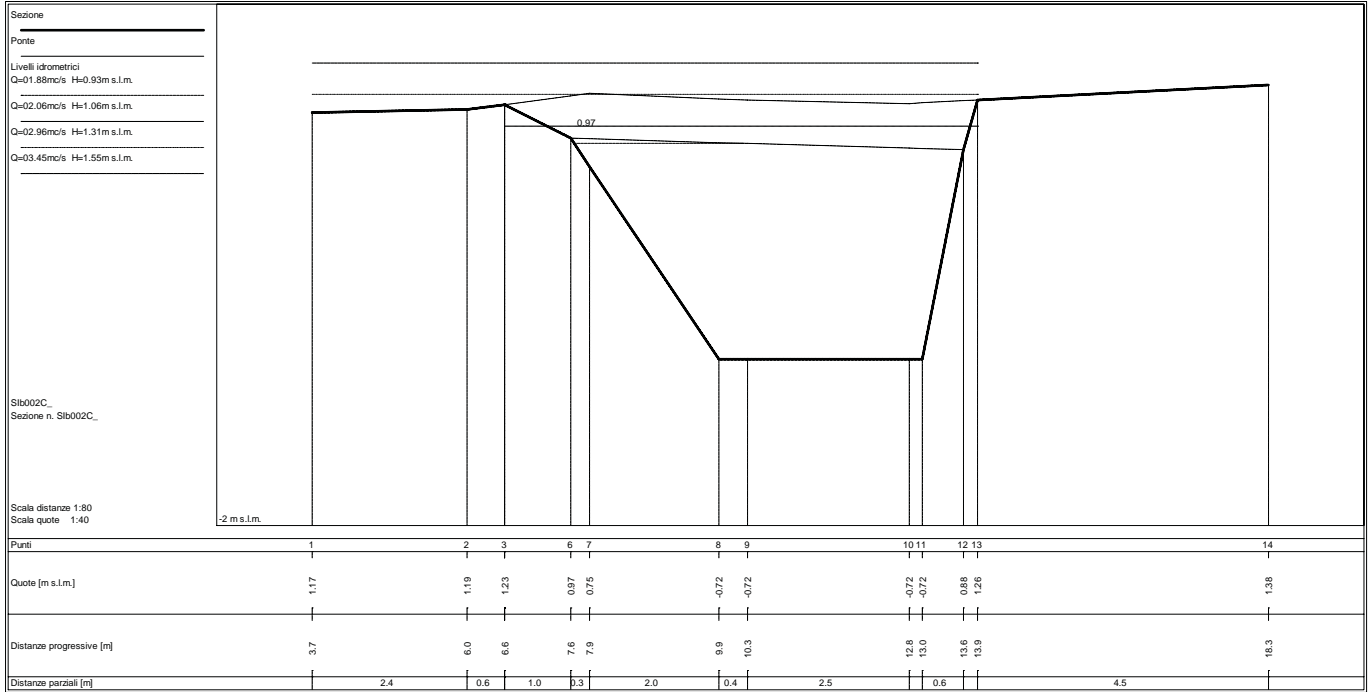

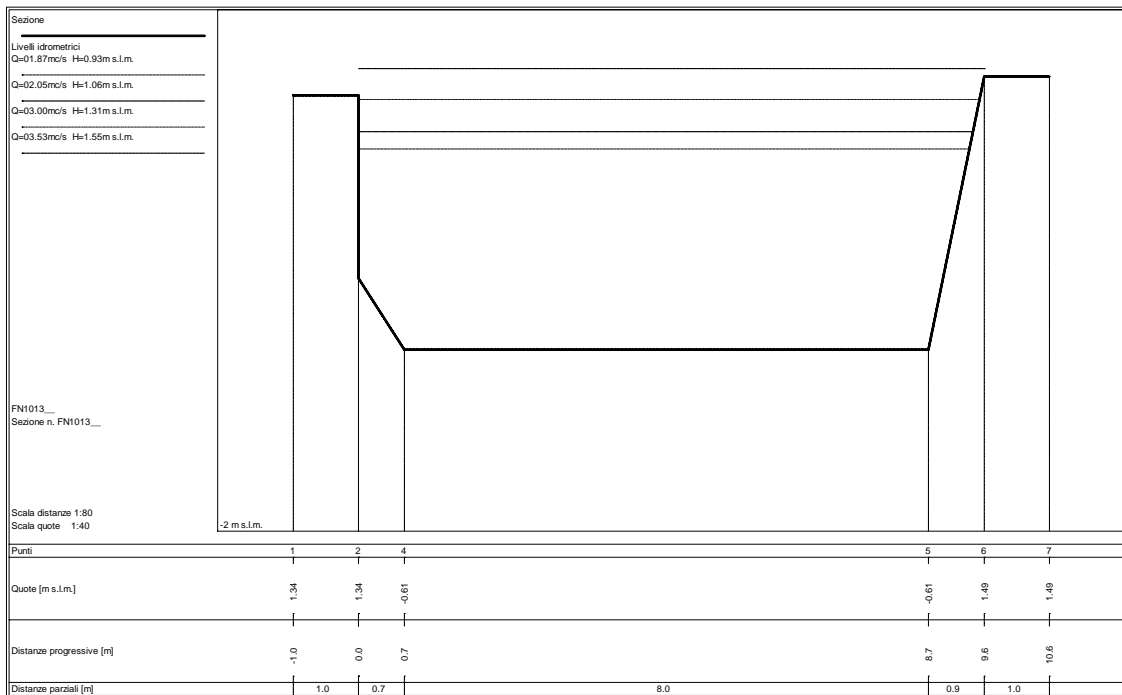
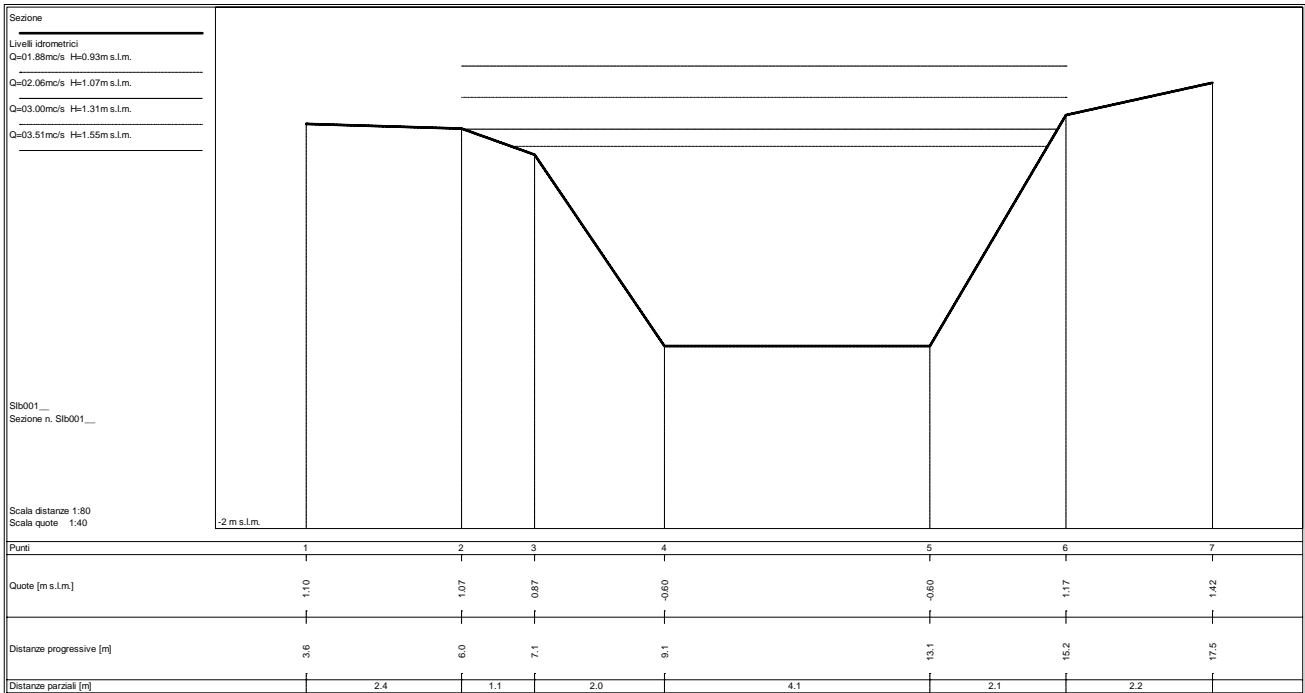

STATO ATTUALE

Sezioni fluviali fosso Silcia – SI_c_P

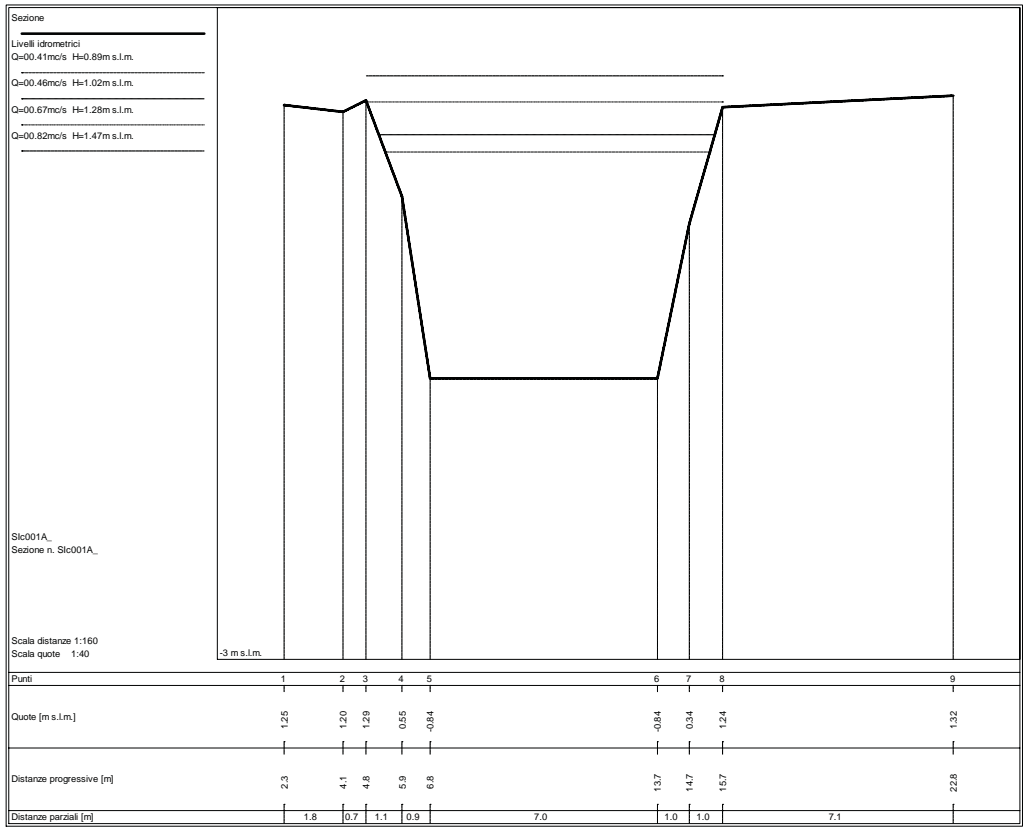
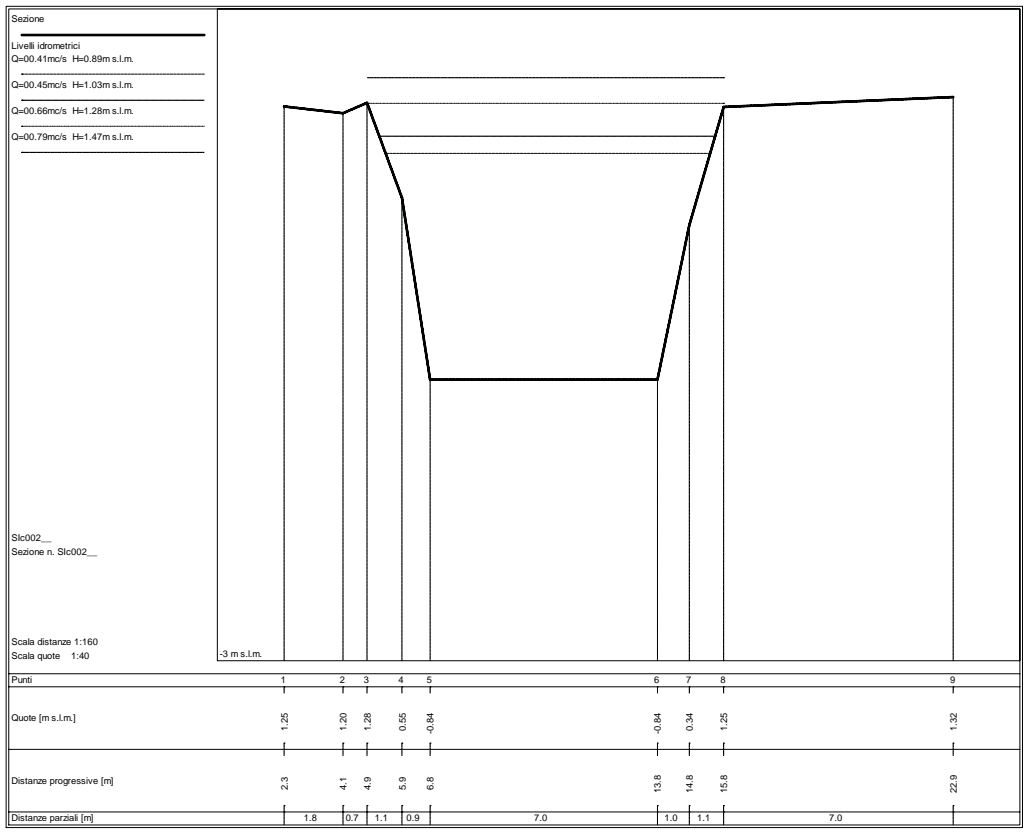

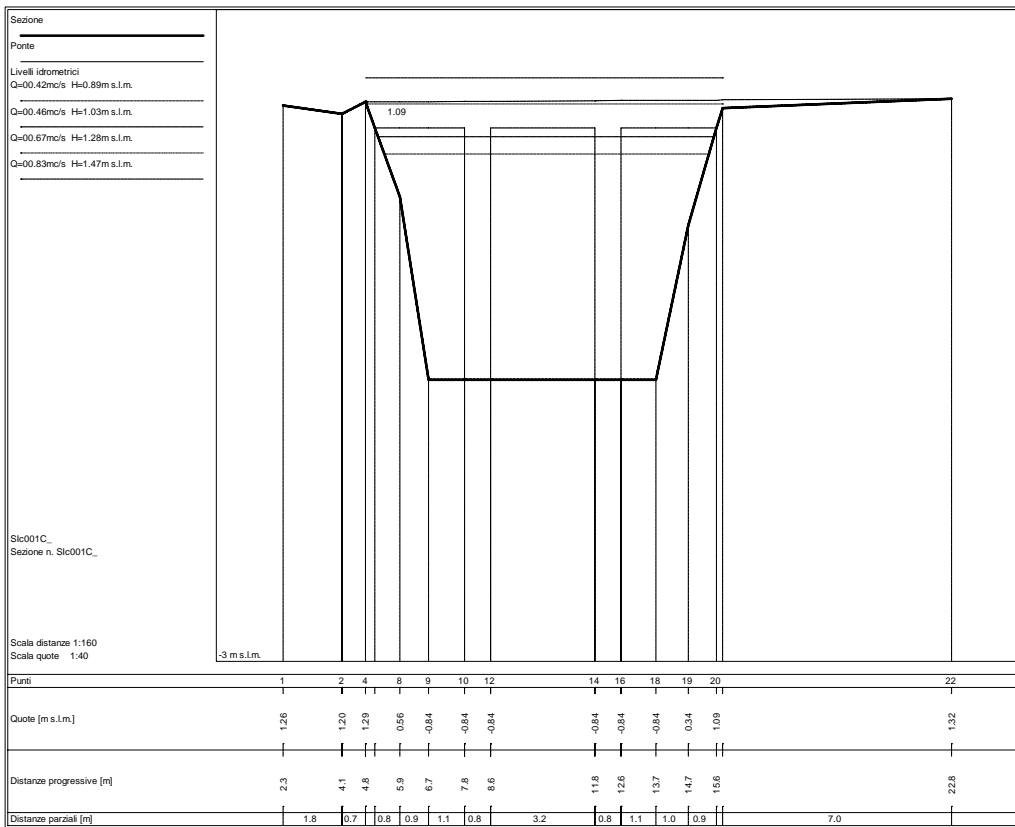
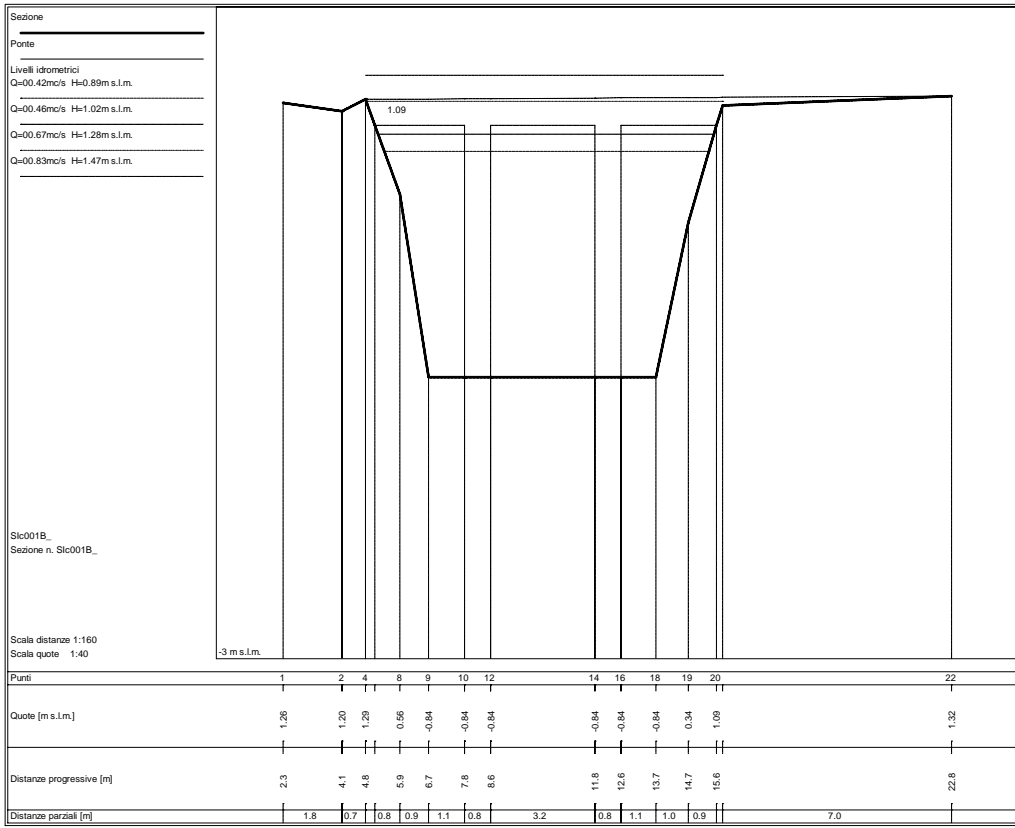

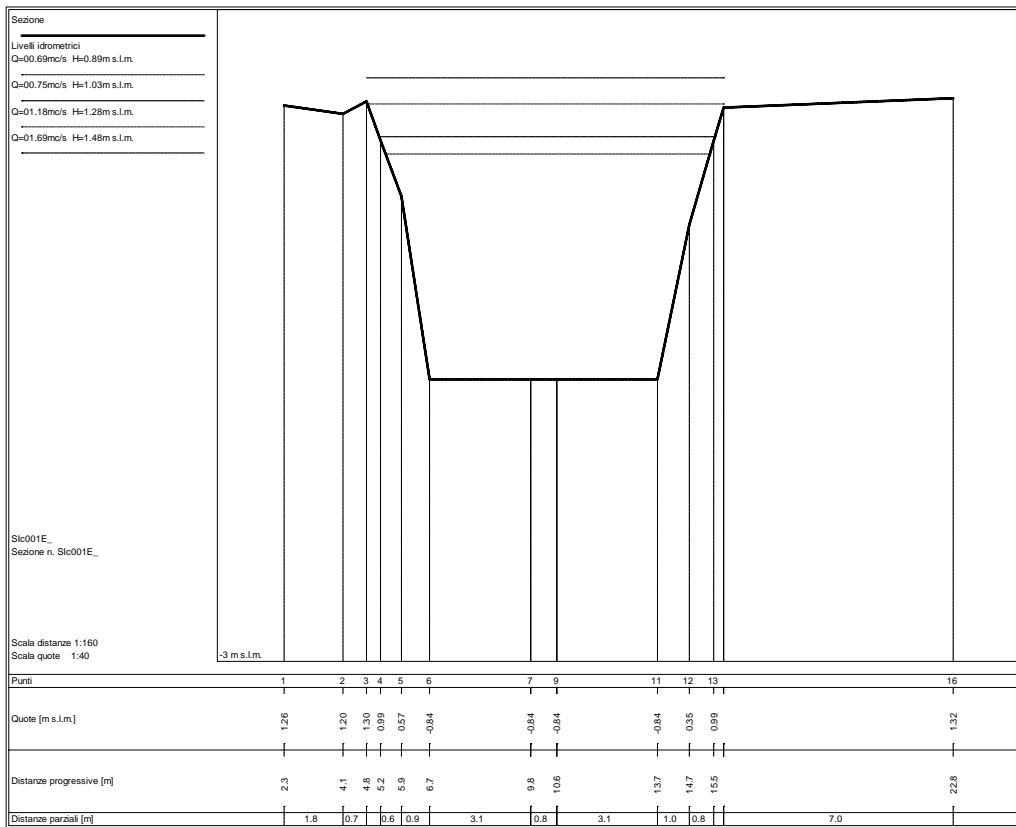
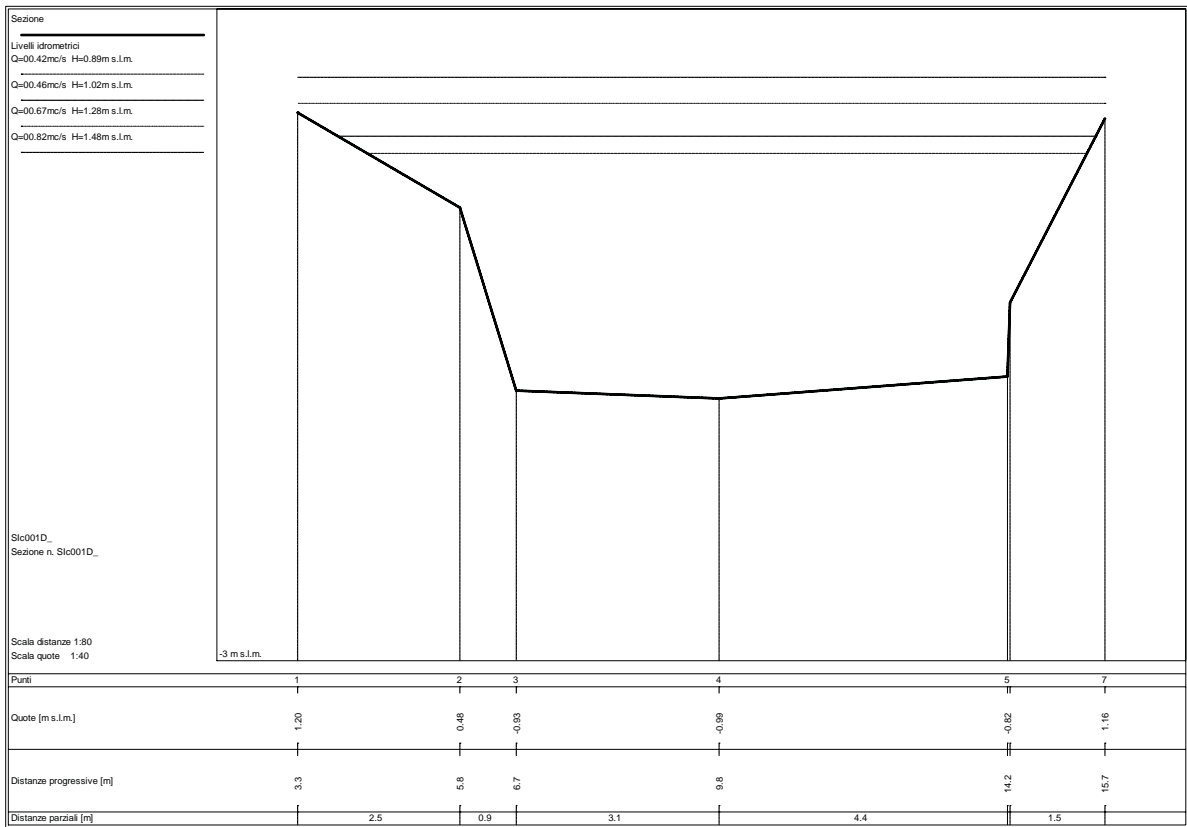

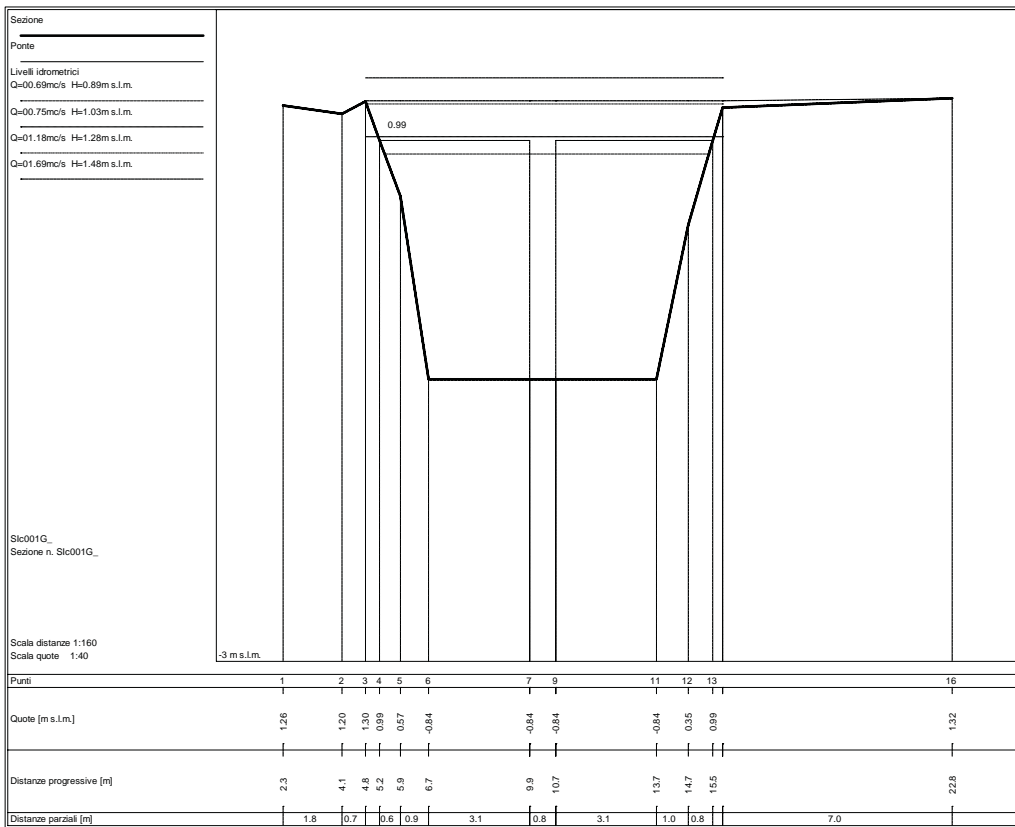
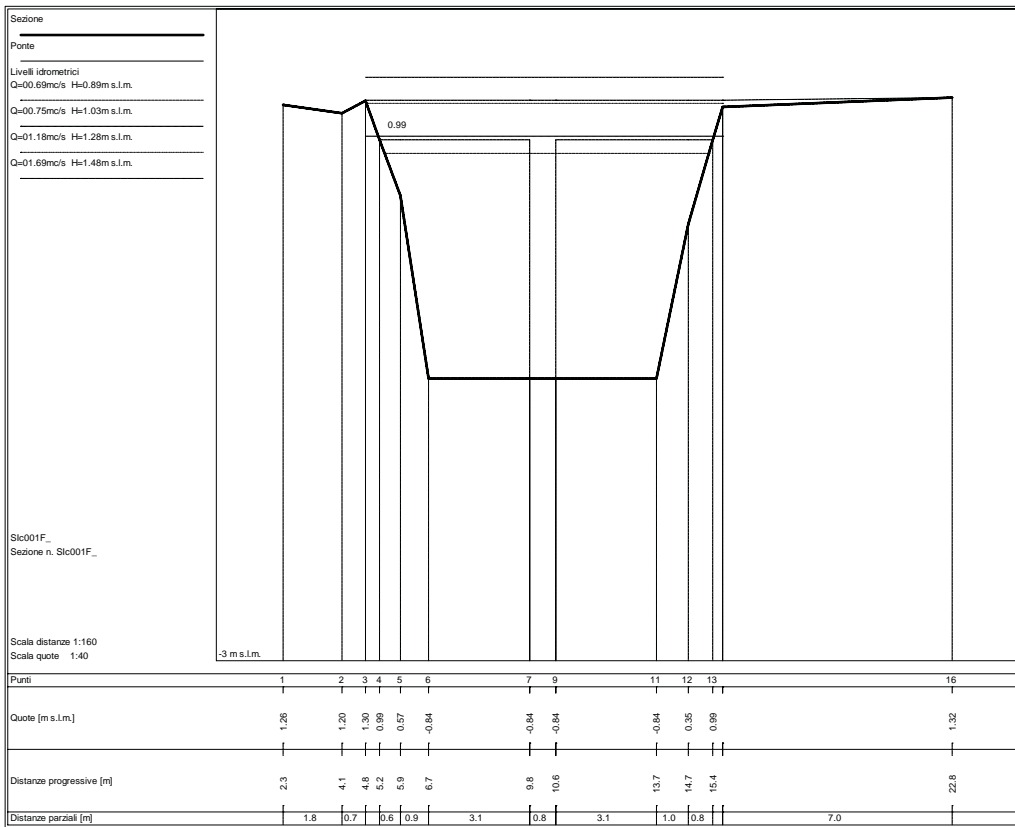

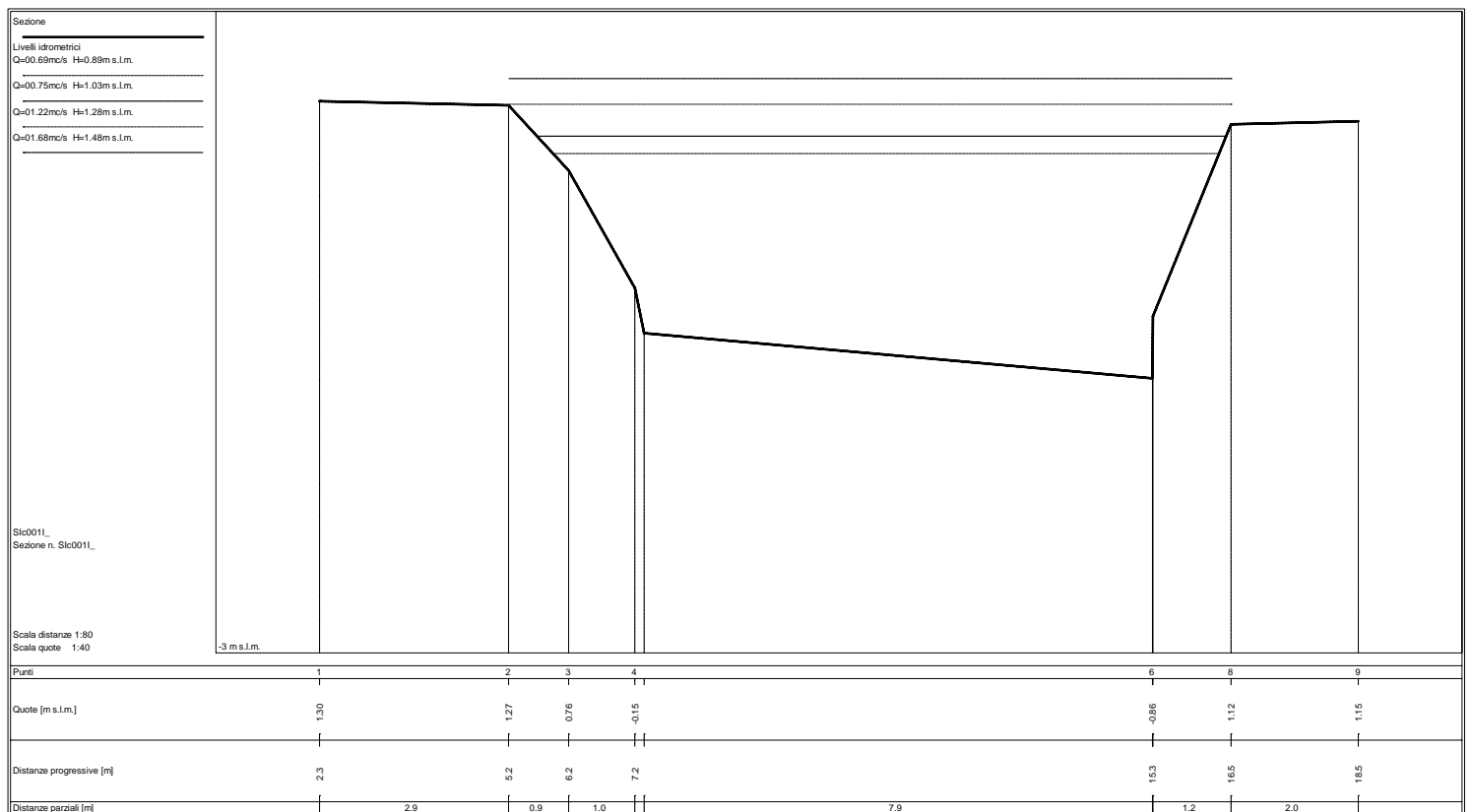
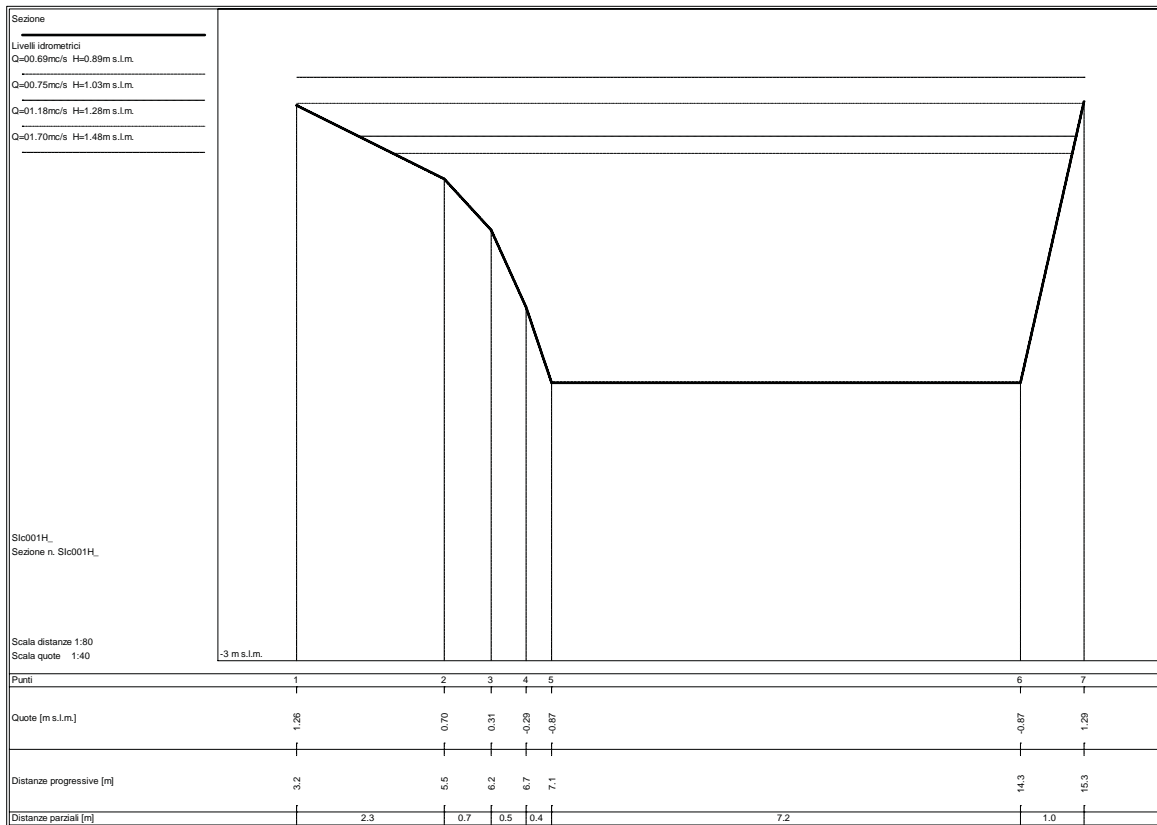

Sezione
 Ponte
 Livelli idrometrici
 Q=00.69mc/s H=0.89m s.l.m.
 Q=00.75mc/s H=1.03m s.l.m.
 Q=01.22mc/s H=1.28m s.l.m.
 Q=01.68mc/s H=1.48m s.l.m.

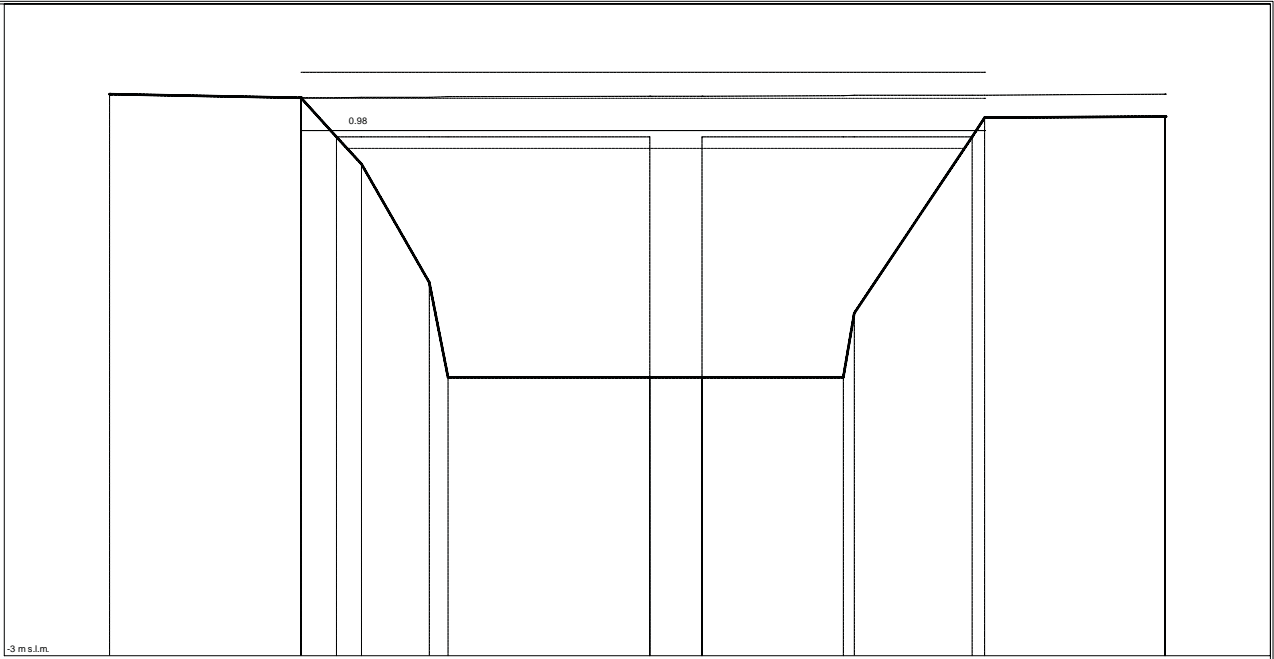

Slc001L_
 Sezione n. Slc001L_
 Scala distanz 1:80
 Scala quote 1:40

Punti	1	2	4	5	6	7	8	10	12	14	15	16
Quote [m s.l.m.]	1.31	1.28	0.98	0.77	-0.14	-0.86	-0.86	-0.86	-0.86	0.98	1.13	1.14
Distanze progressive [m]	2.7	5.7	6.2	6.6	7.6	7.9	11.0	11.8	14.0	16.0	16.2	18.9
Distanze parziali [m]		2.9	0.5	0.4	1.0		3.1	0.8	2.2		1.8	2.8

Sezione
 Ponte
 Livelli idrometrici
 Q=00.70mc/s H=0.89m s.l.m.
 Q=00.76mc/s H=1.03m s.l.m.
 Q=01.22mc/s H=1.28m s.l.m.
 Q=01.66mc/s H=1.48m s.l.m.

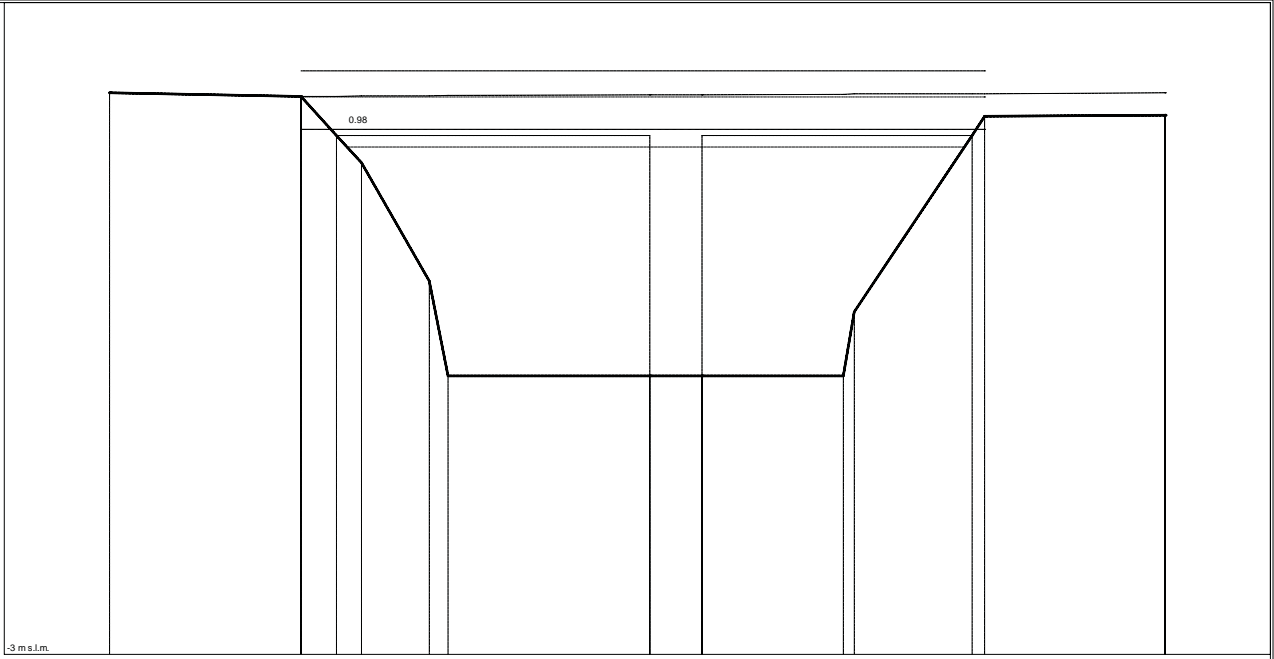

Slc001M_
 Sezione n. Slc001M_
 Scala distanz 1:80
 Scala quote 1:40

Punti	1	2	4	5	6	7	8	10	12	14	15	16
Quote [m s.l.m.]	1.31	1.28	0.98	0.77	-0.14	-0.86	-0.86	-0.86	-0.86	0.98	1.13	1.14
Distanze progressive [m]	2.9	5.8	6.3	6.7	7.8	8.1	11.2	12.0	14.1	16.1	16.3	19.1
Distanze parziali [m]		2.9	0.5	0.4	1.0		3.1	0.8	2.2		1.8	2.8

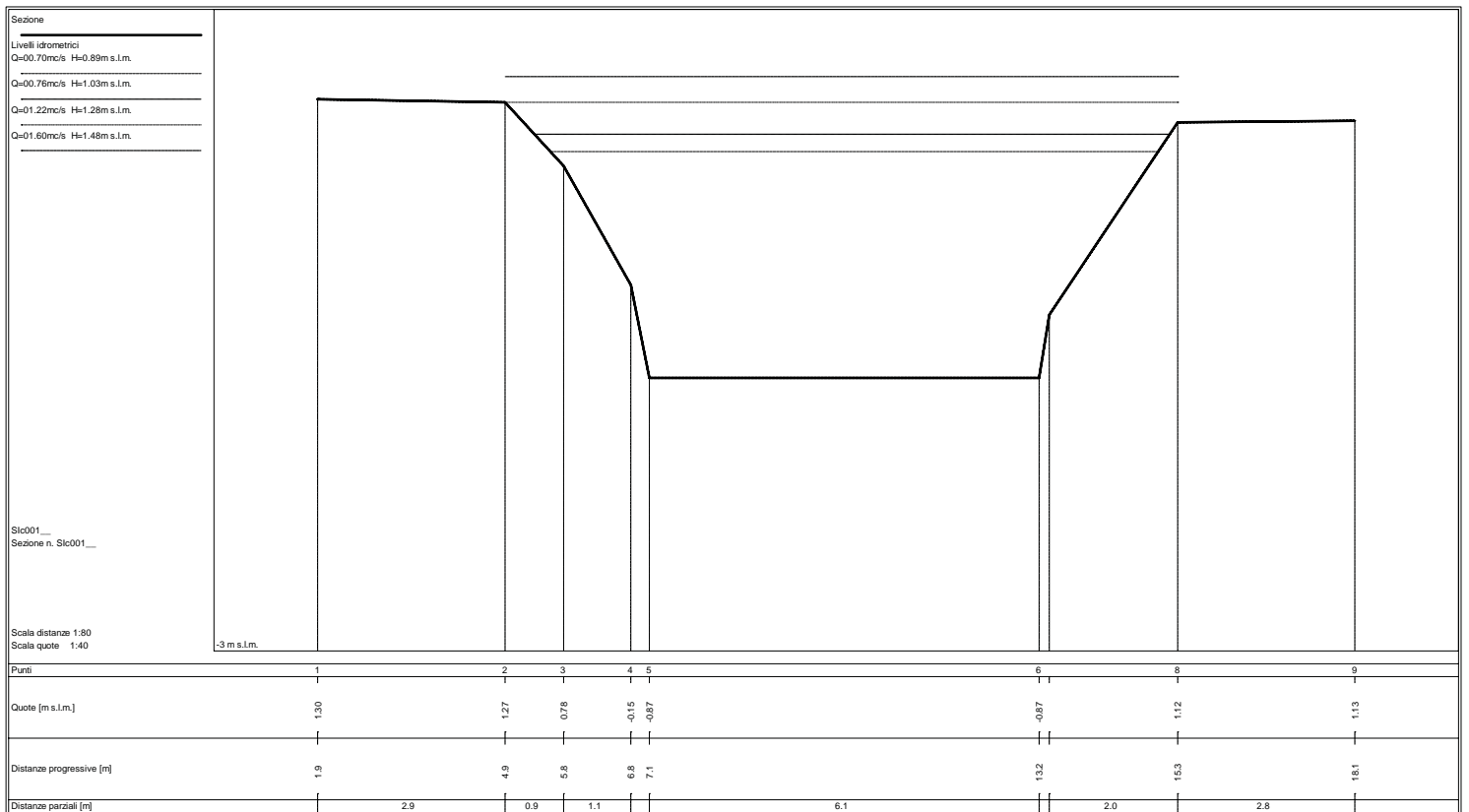
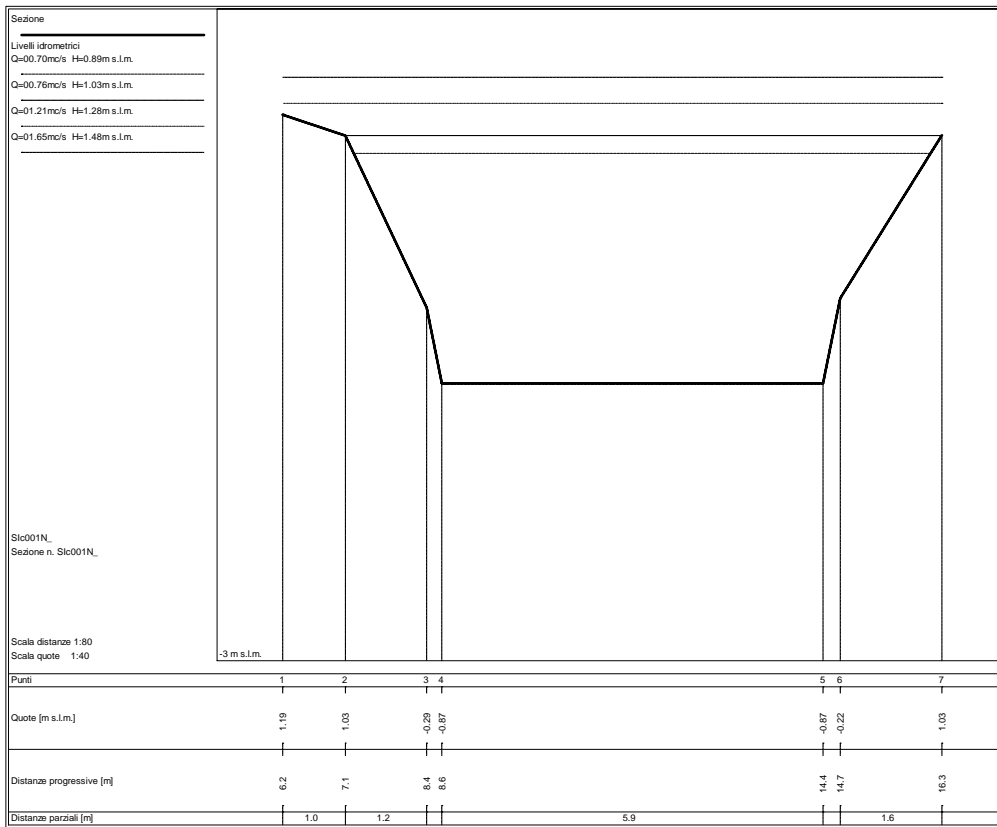

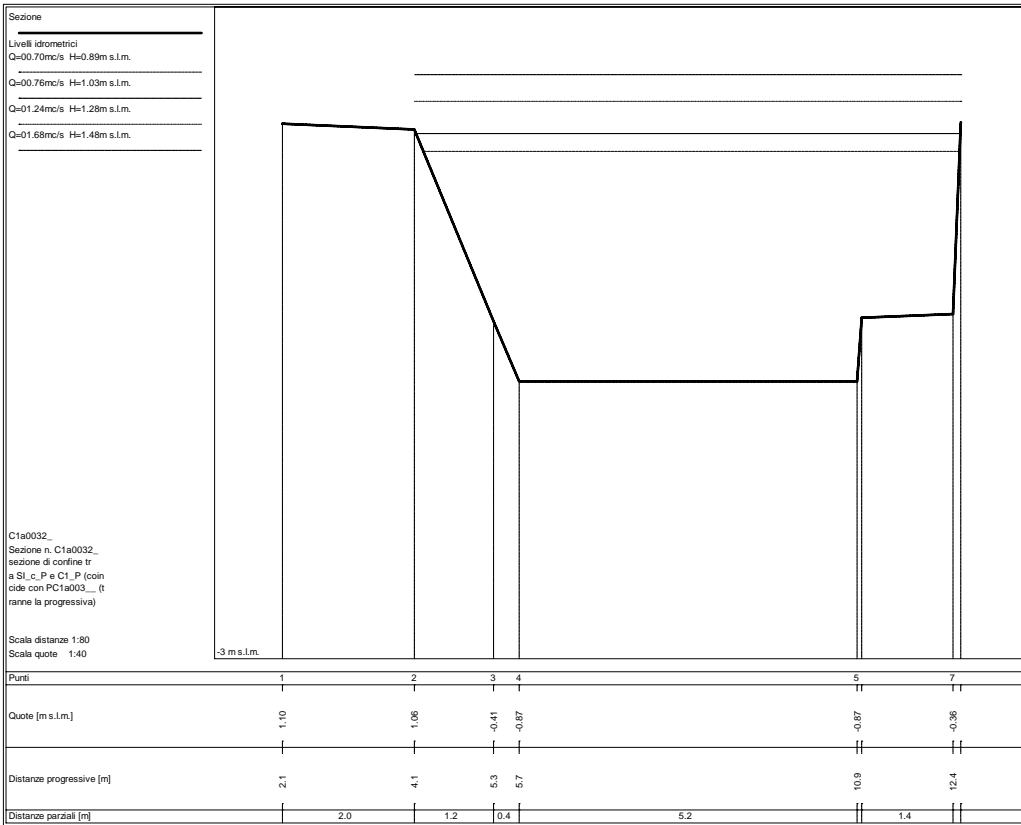

STATO ATTUALE

Sezioni fluviali fosso Tornabuoni

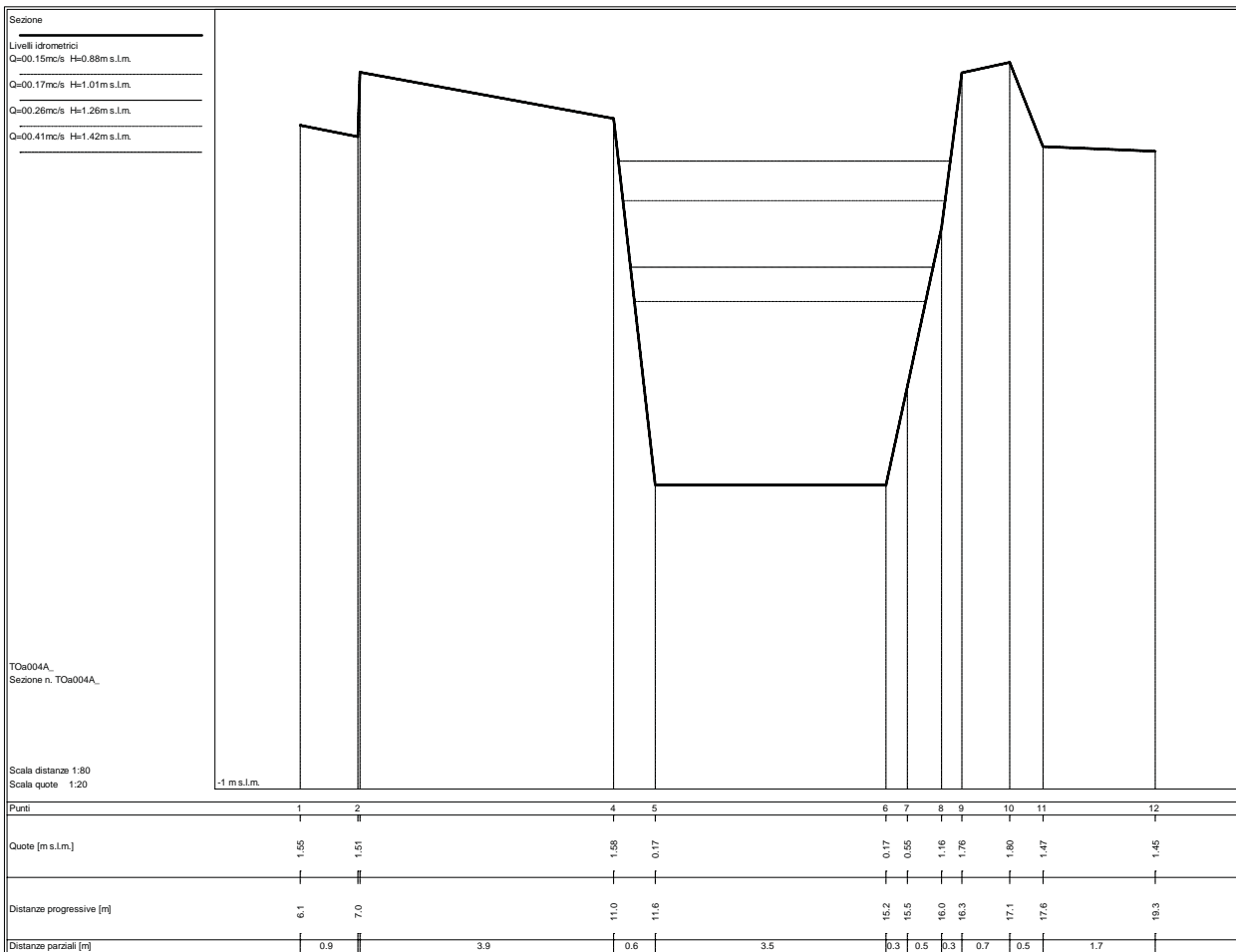
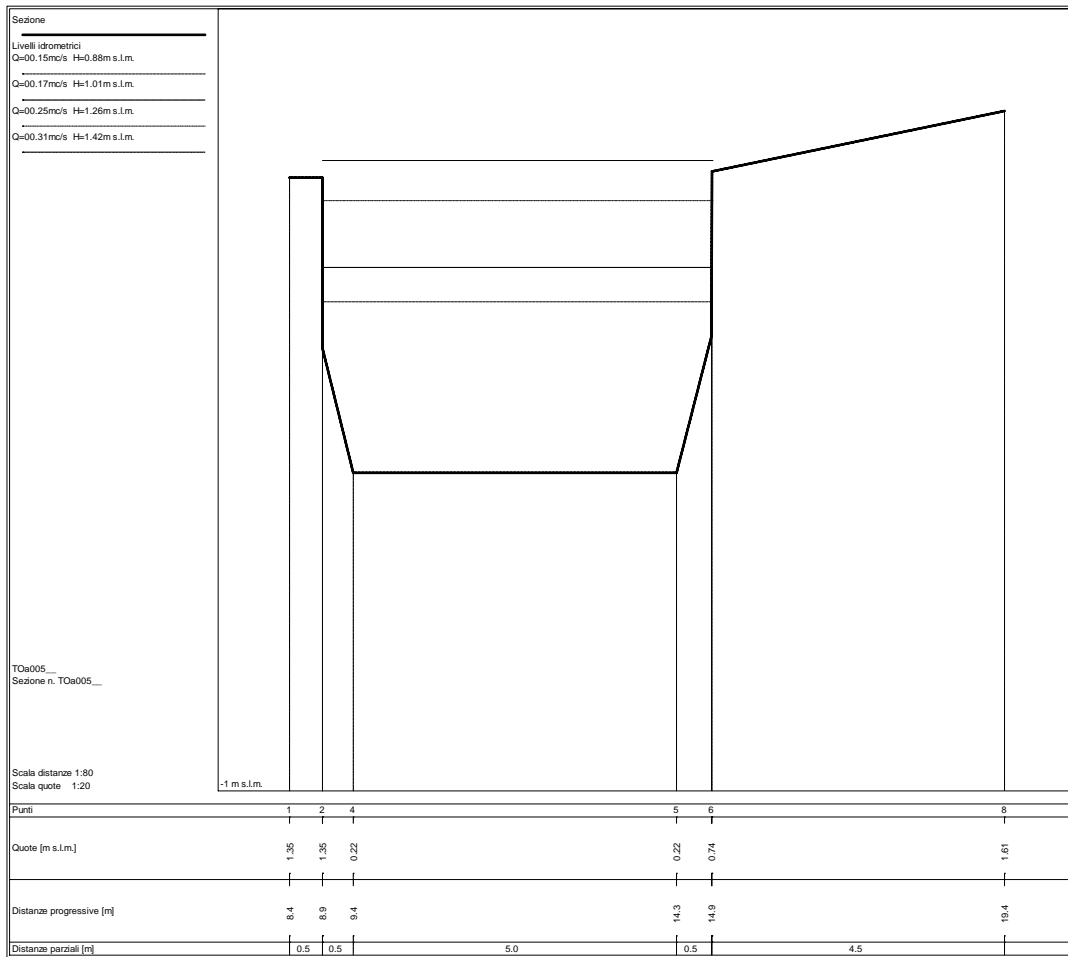

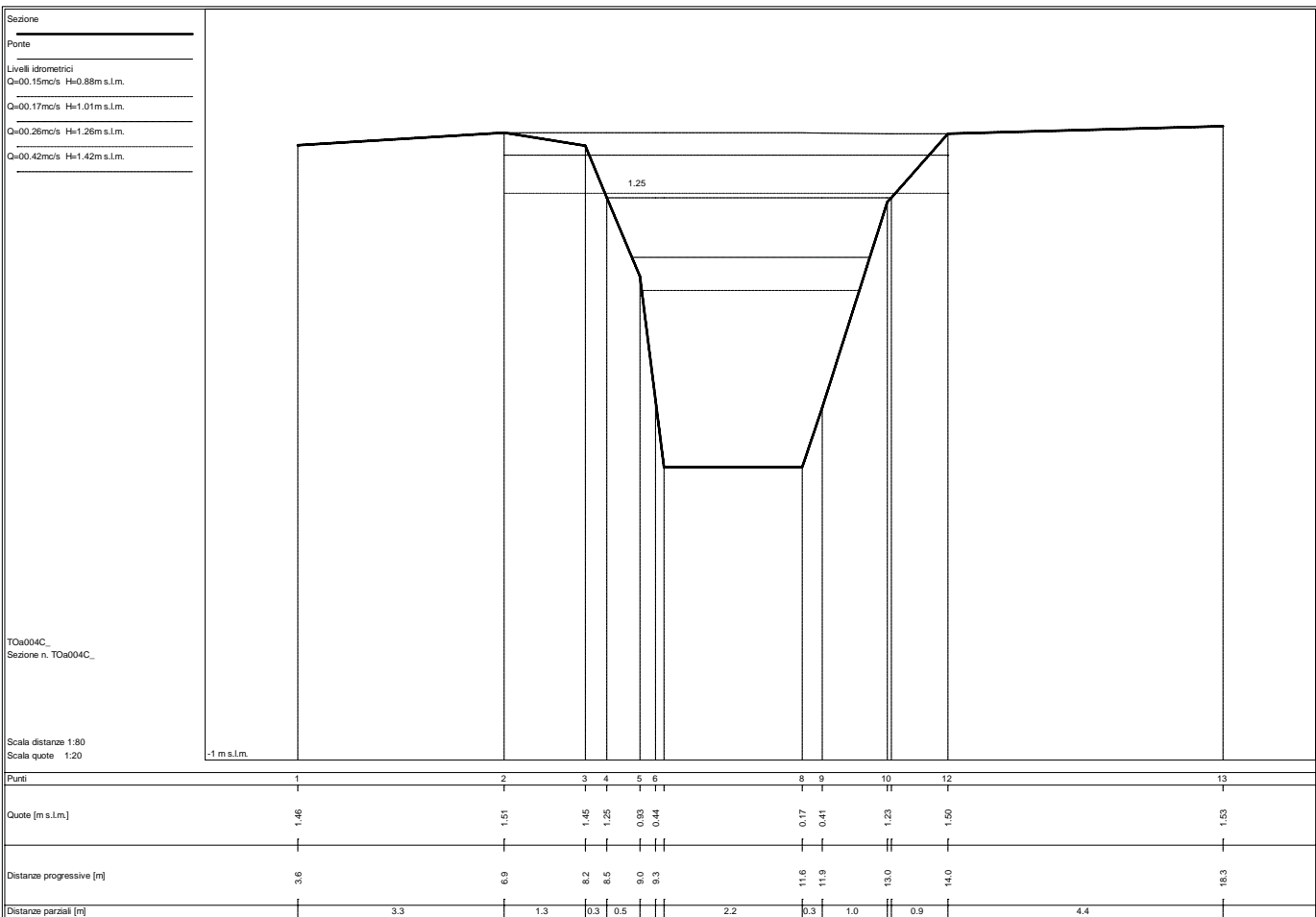
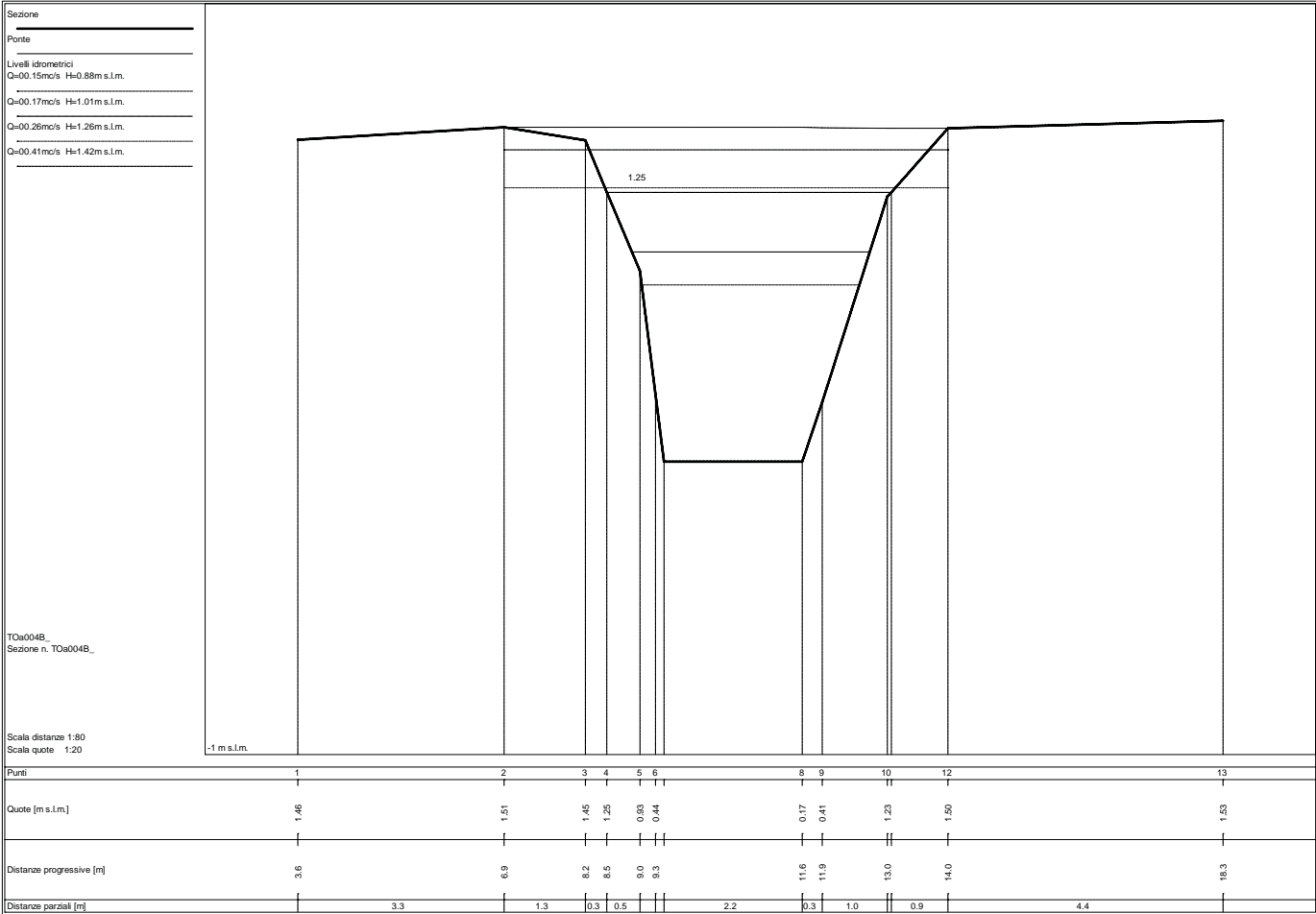

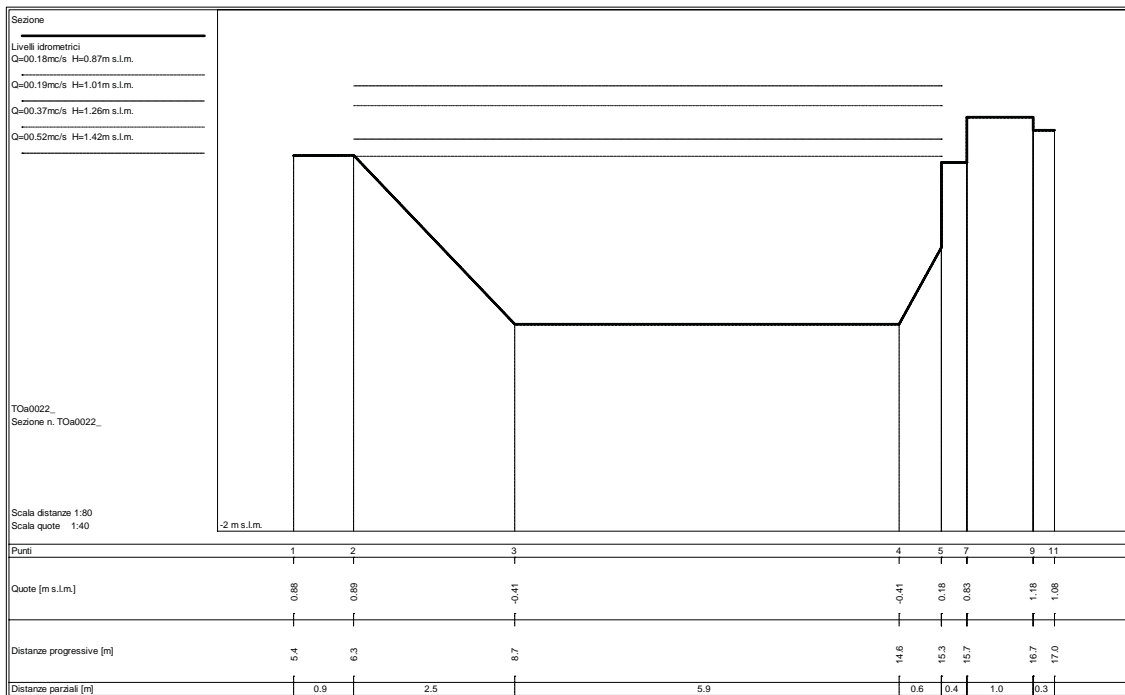
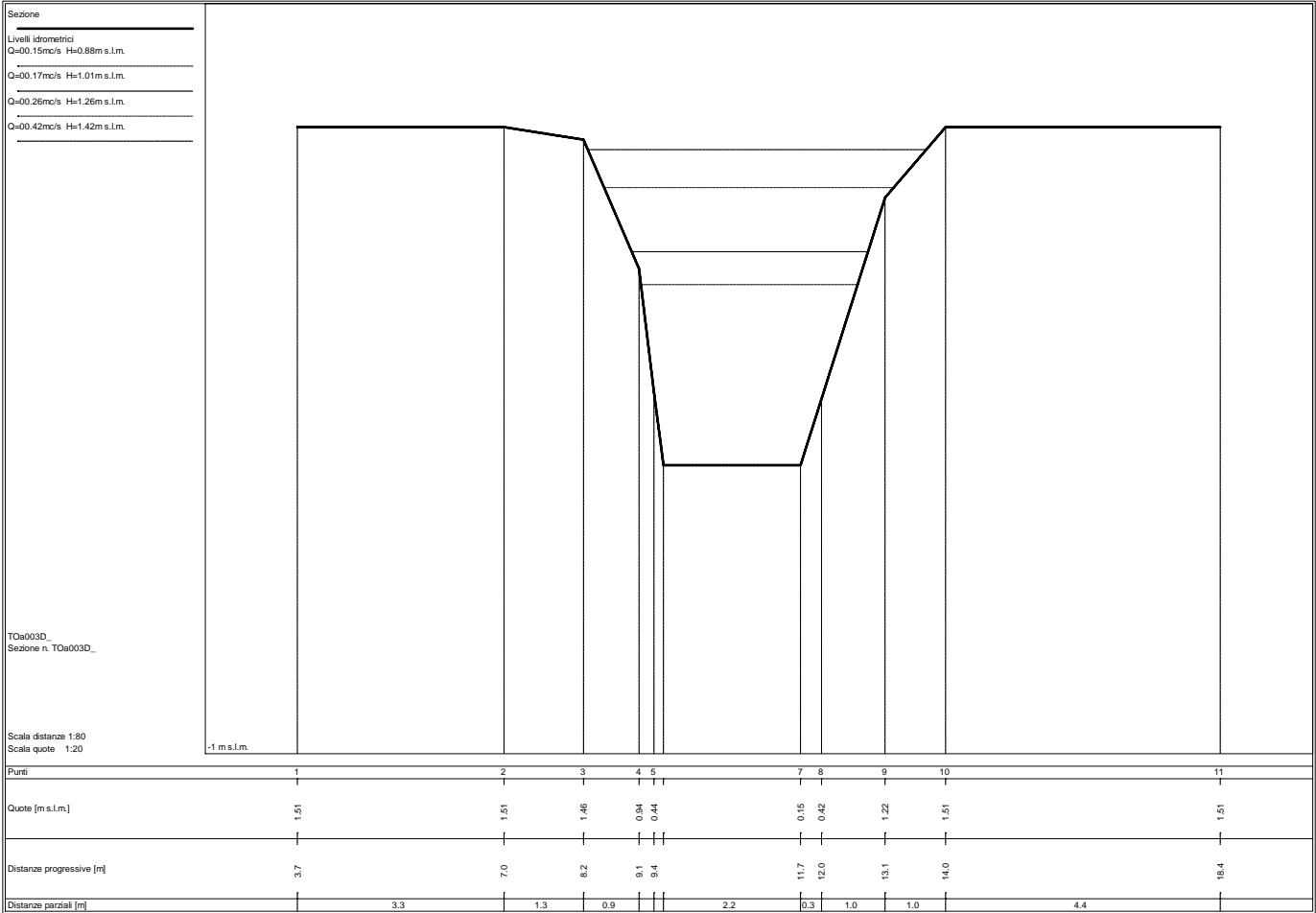

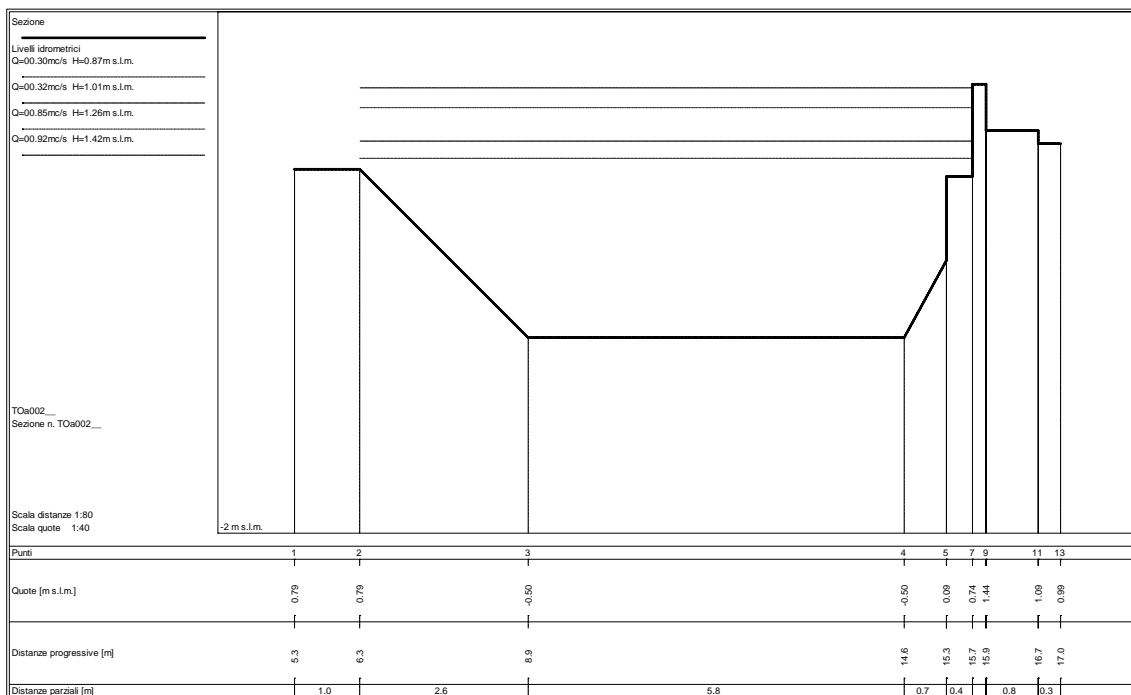
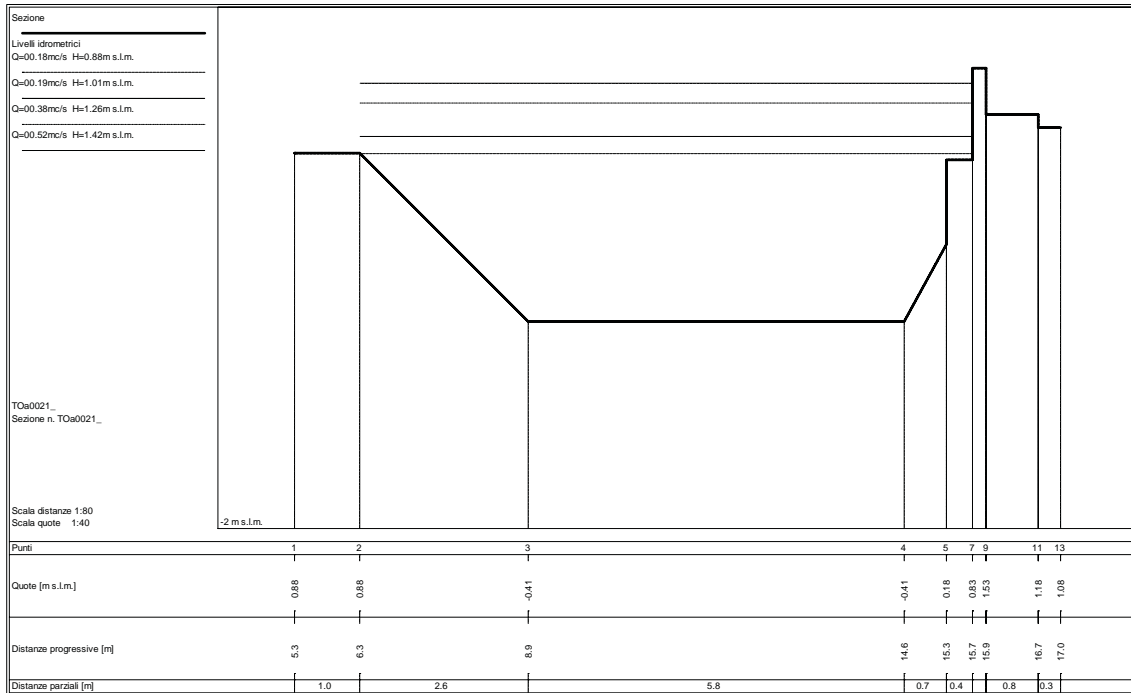

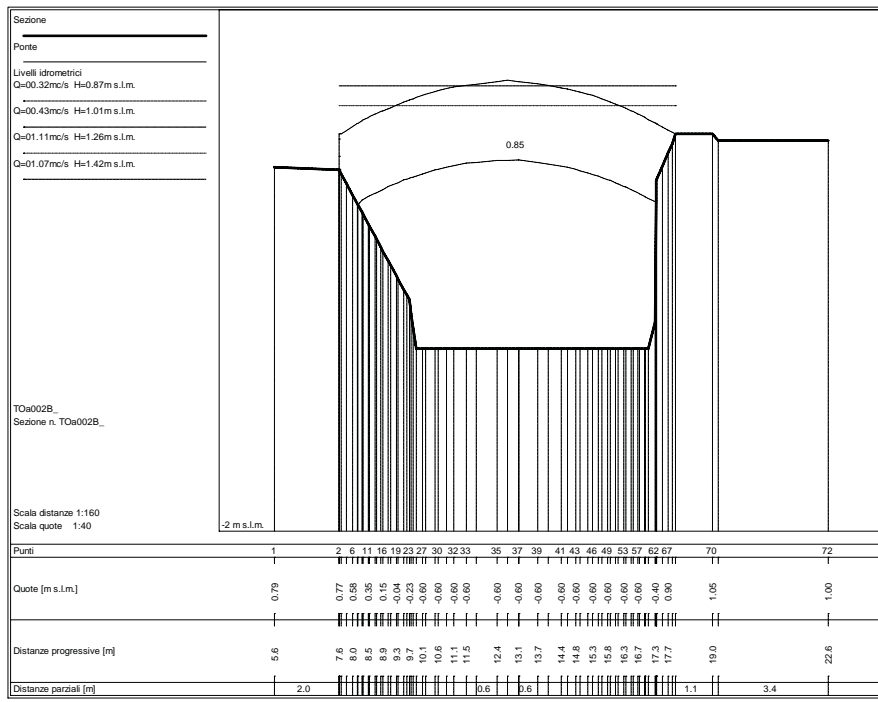
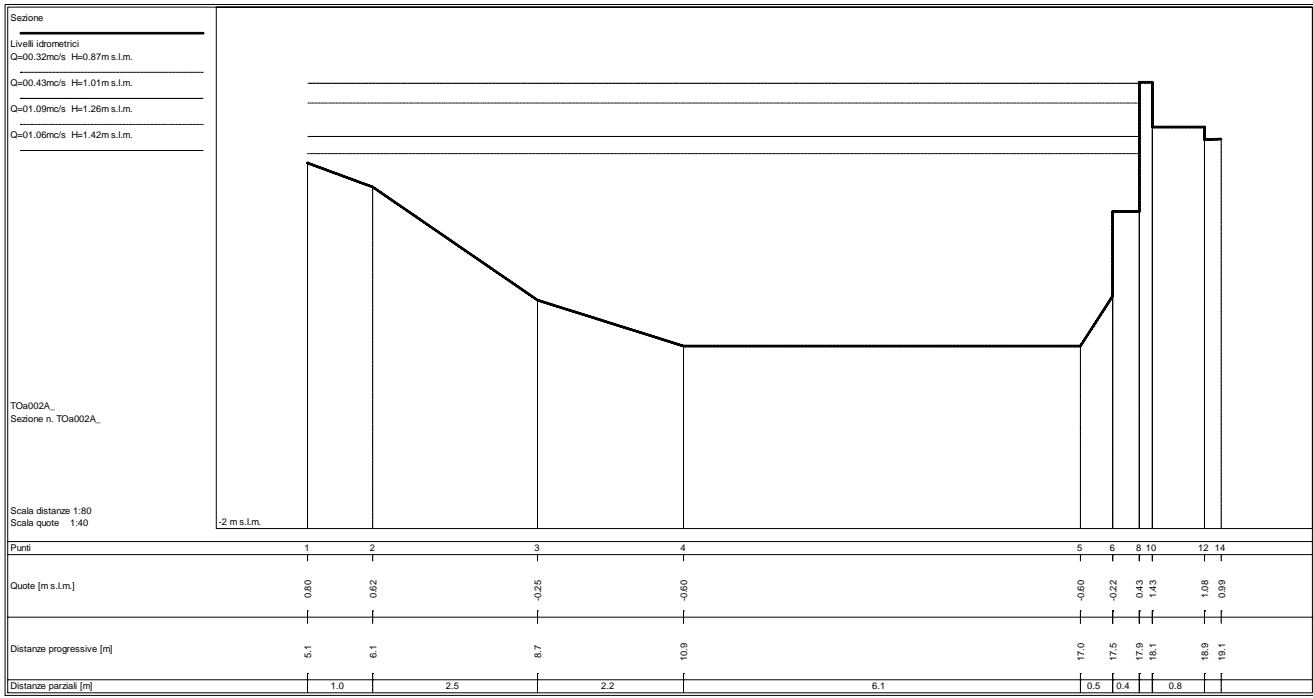

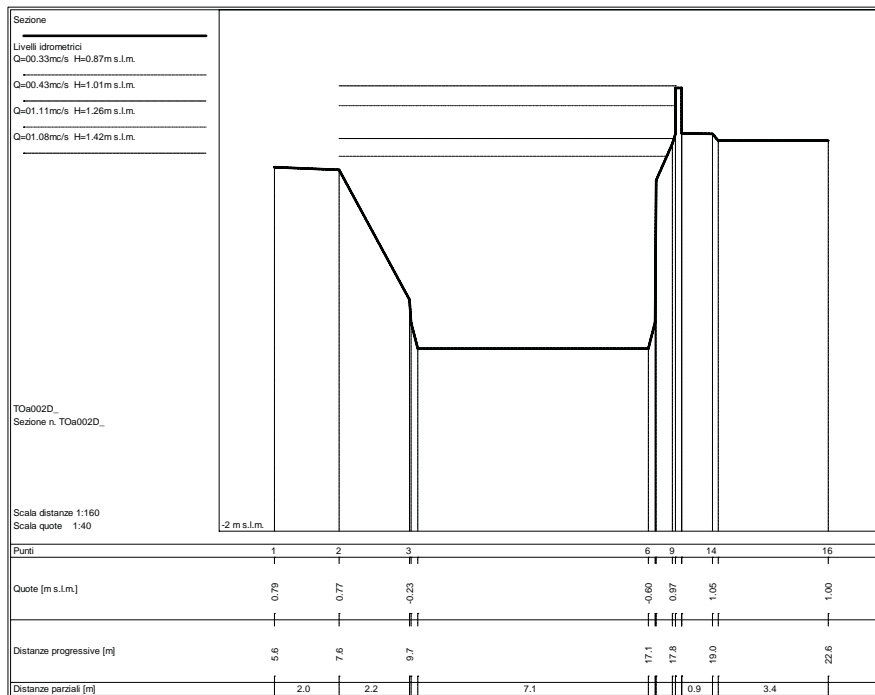
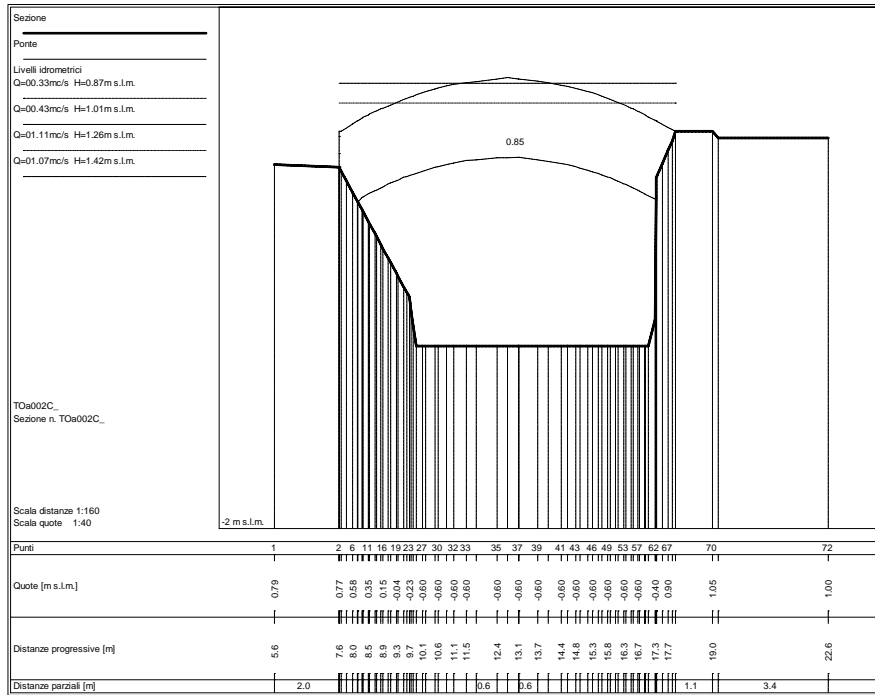

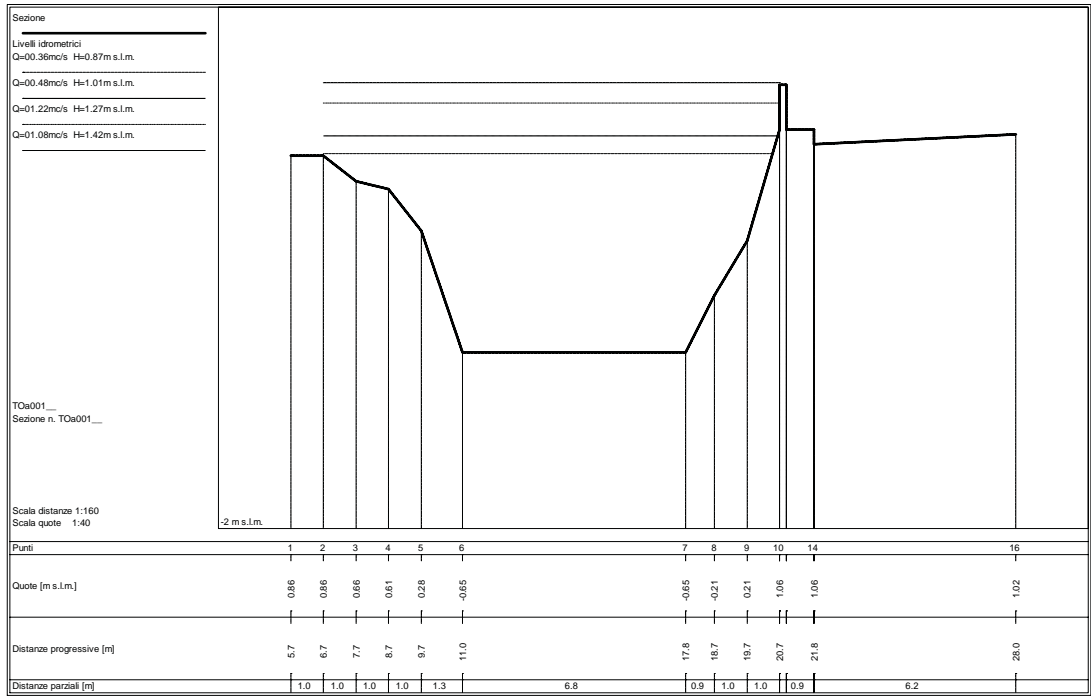

STATO ATTUALE

Sezioni fluviali fiume Frigido – FR_01

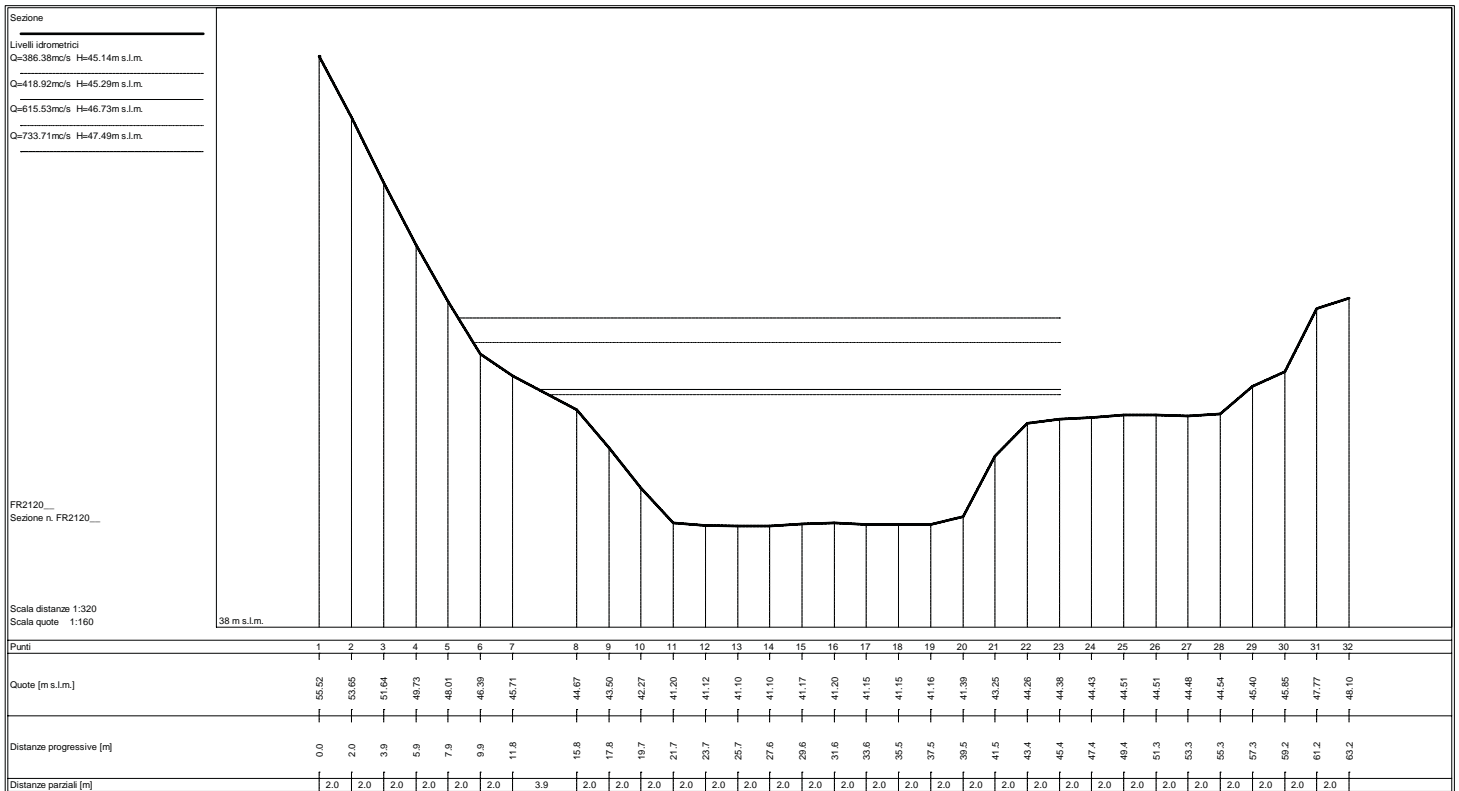
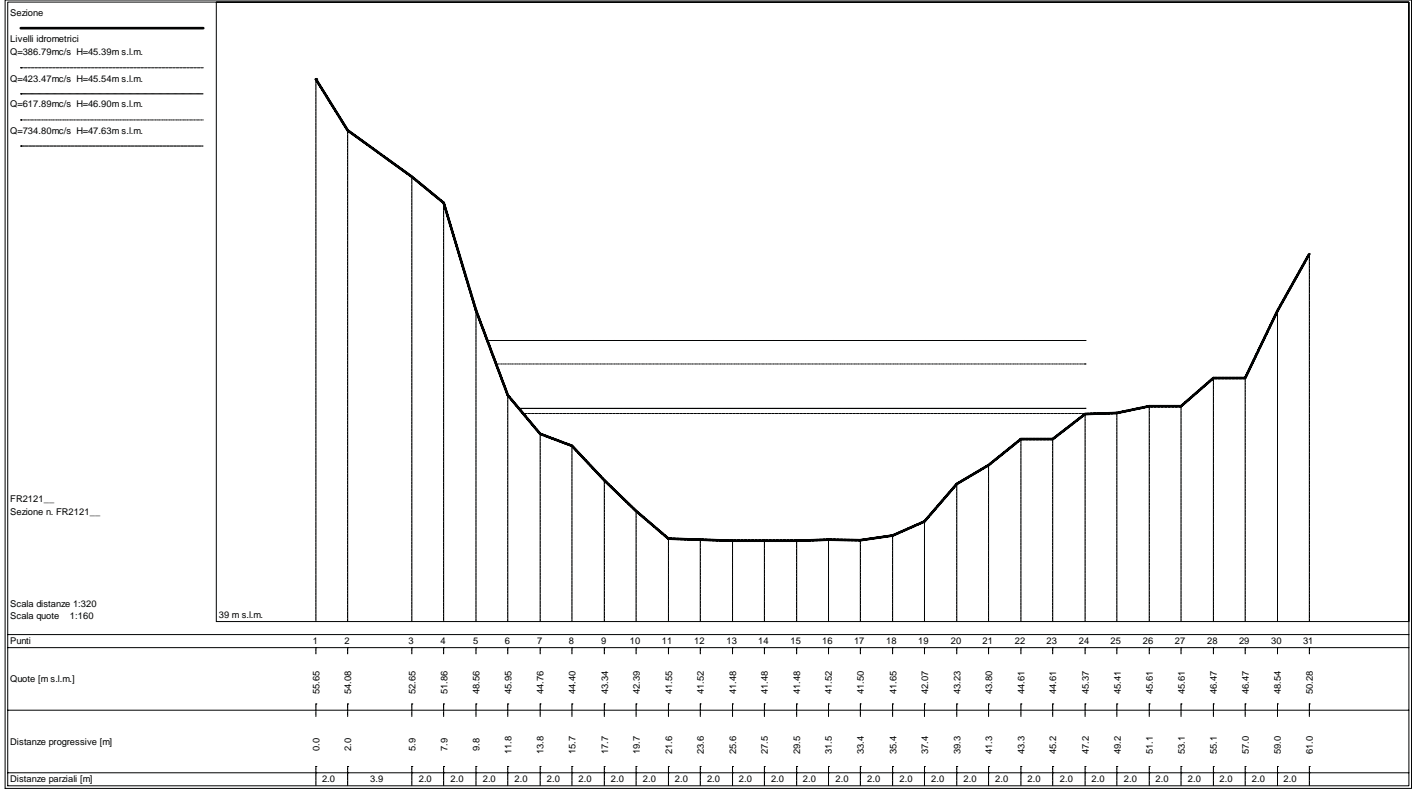

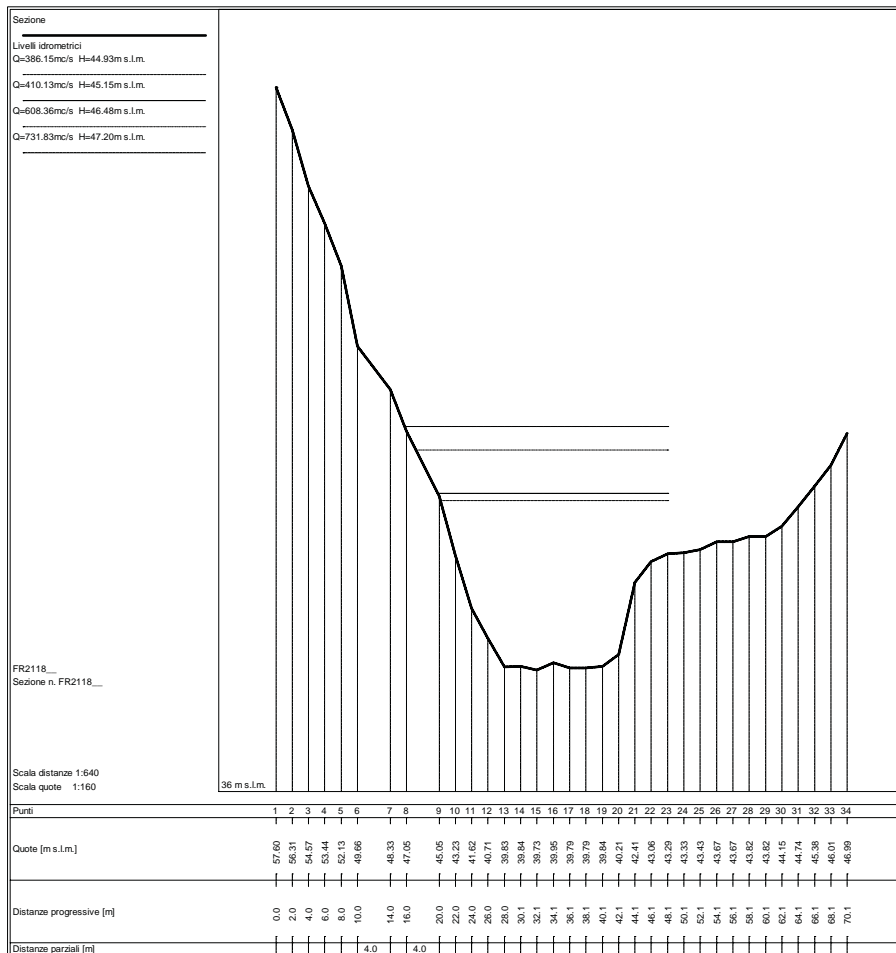
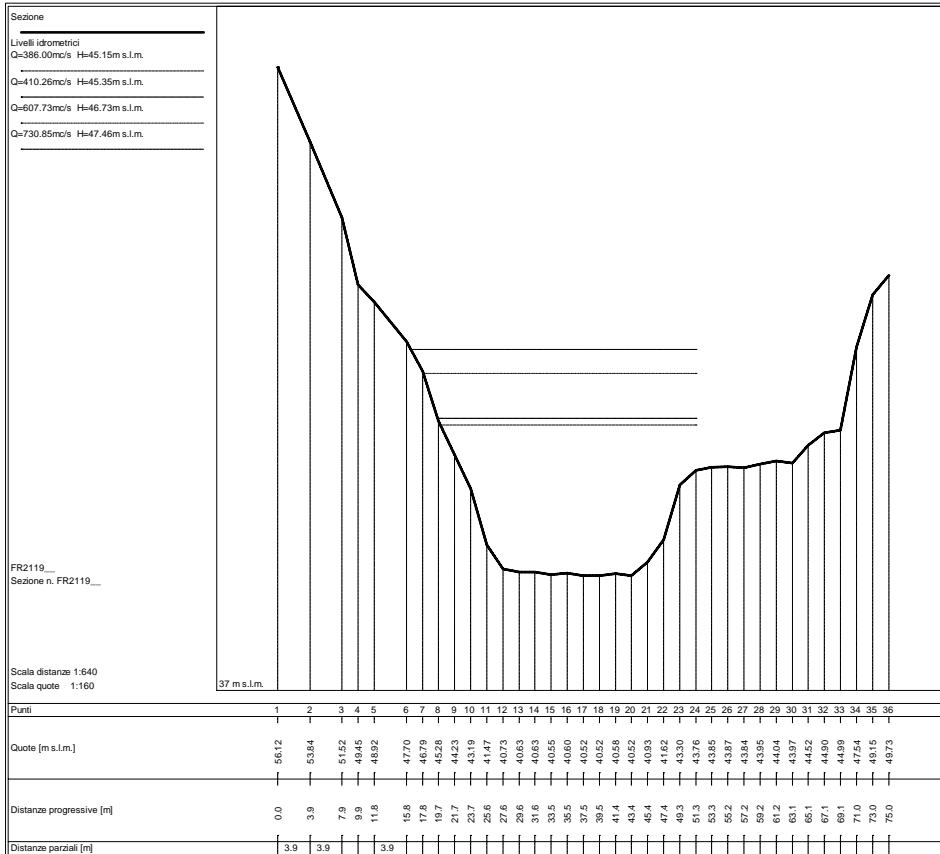

STATO ATTUALE

Sezioni fluviali fiume Frigido – FR_02

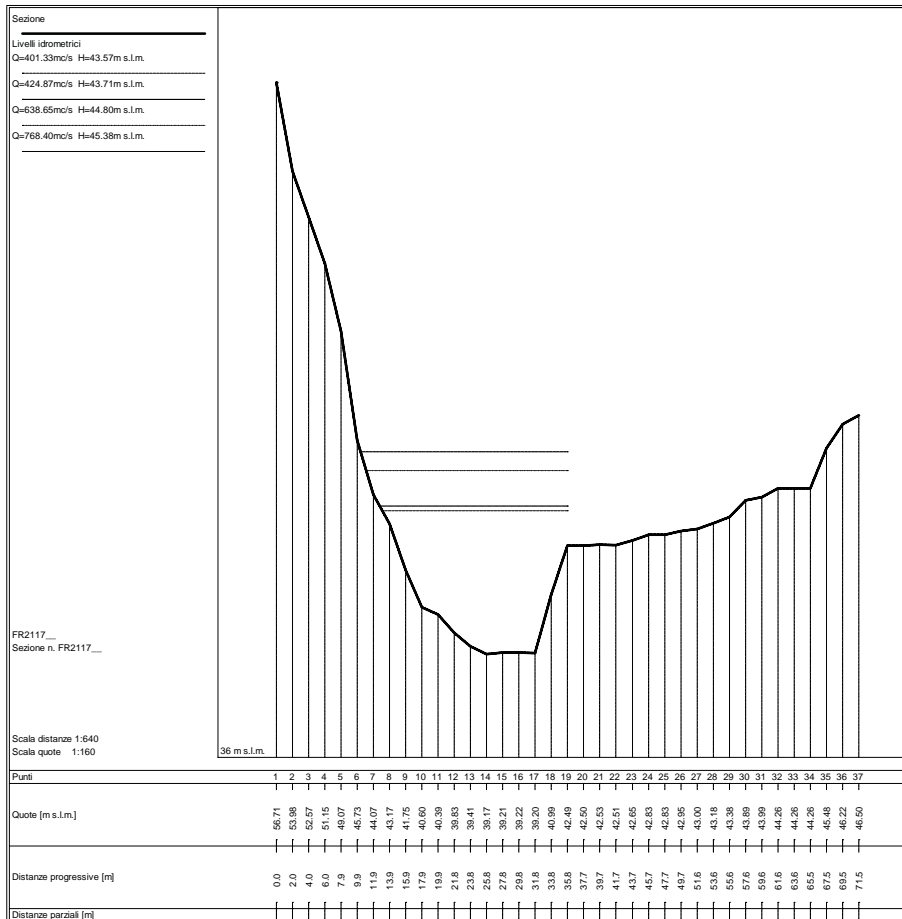
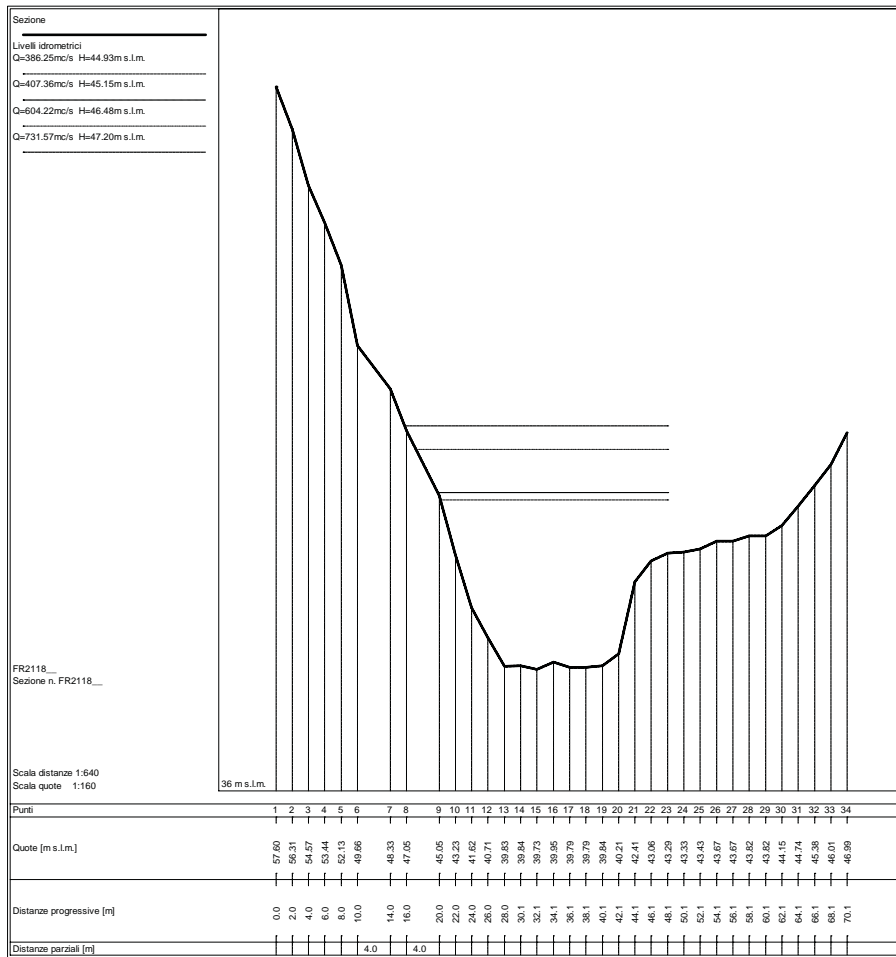

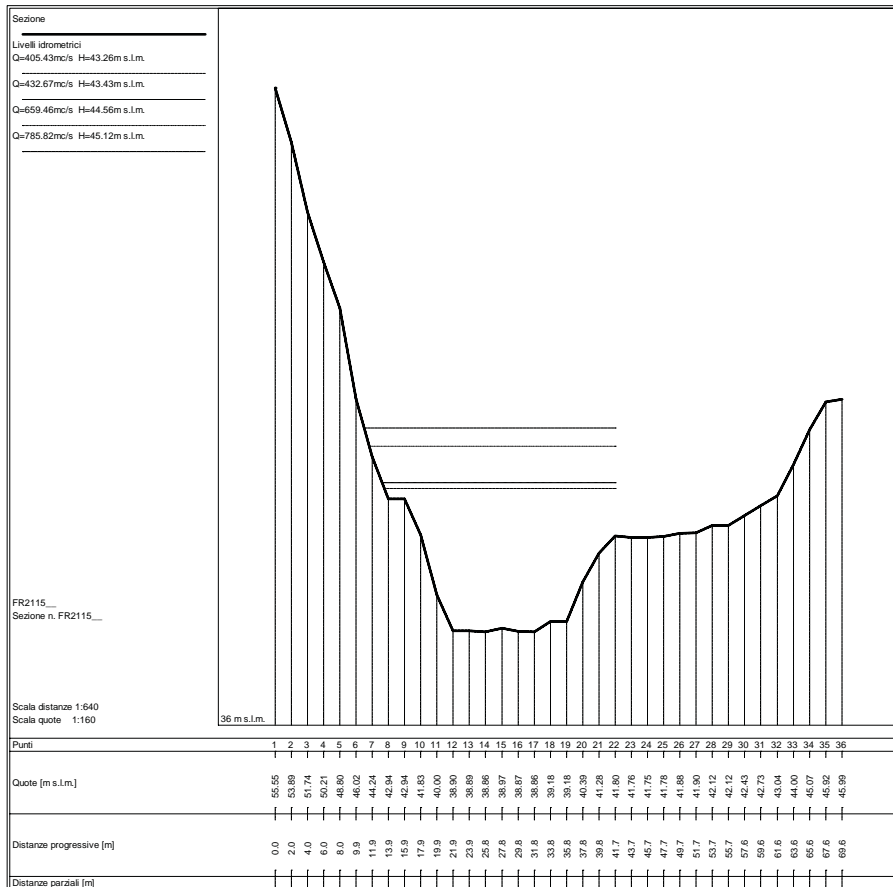
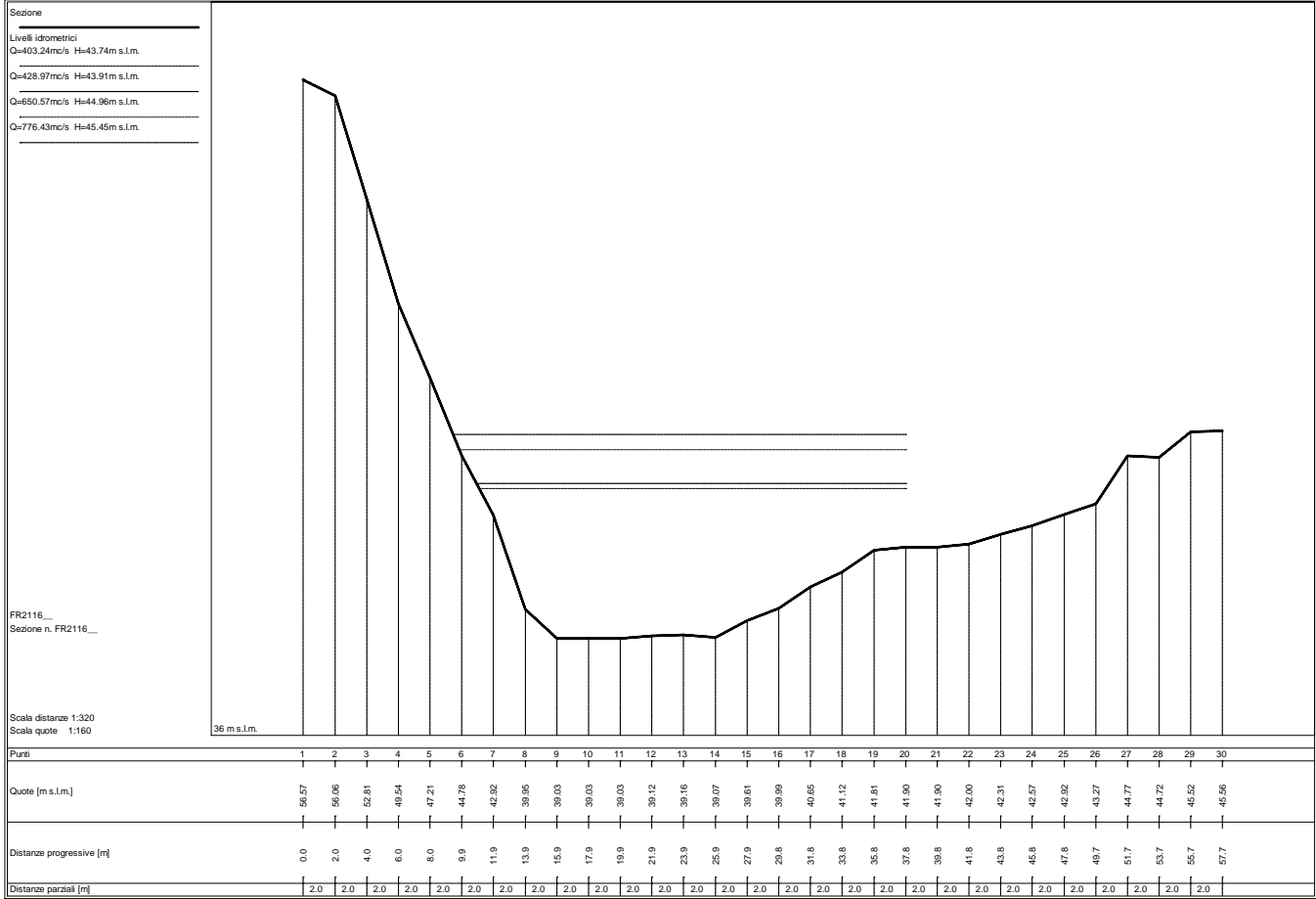

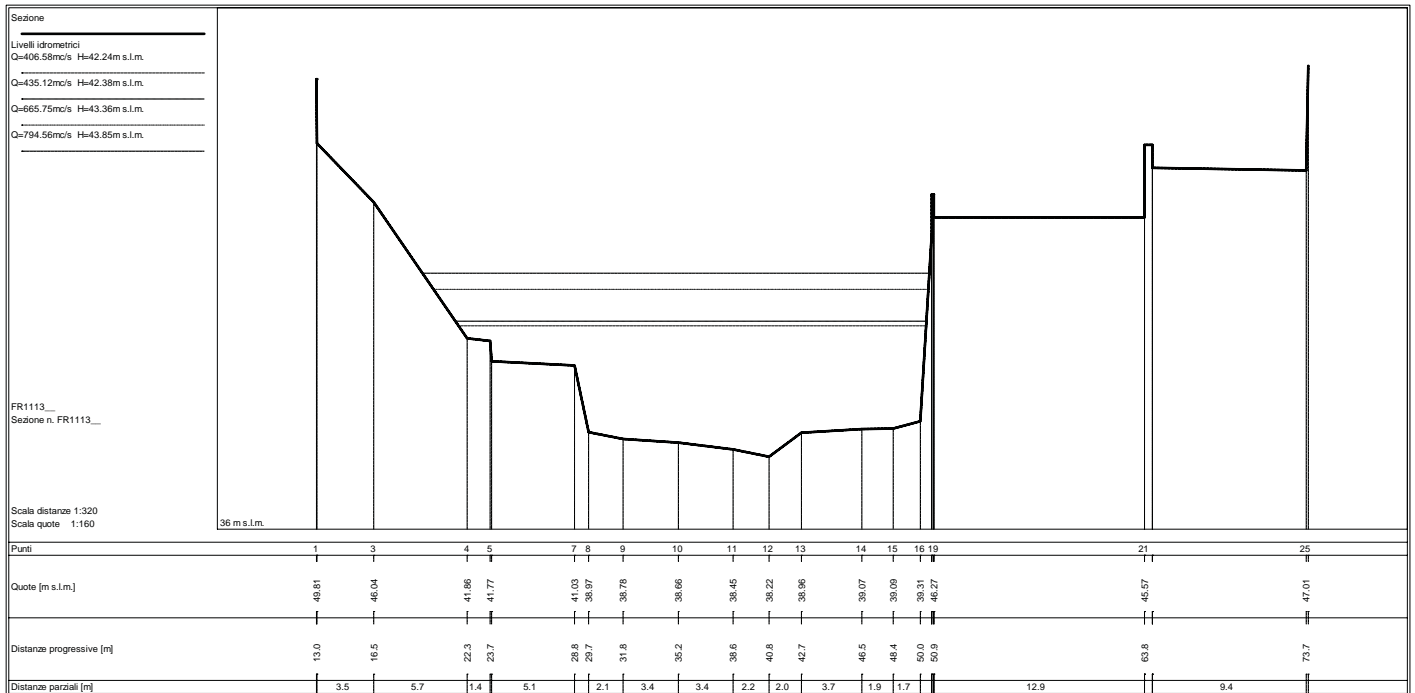
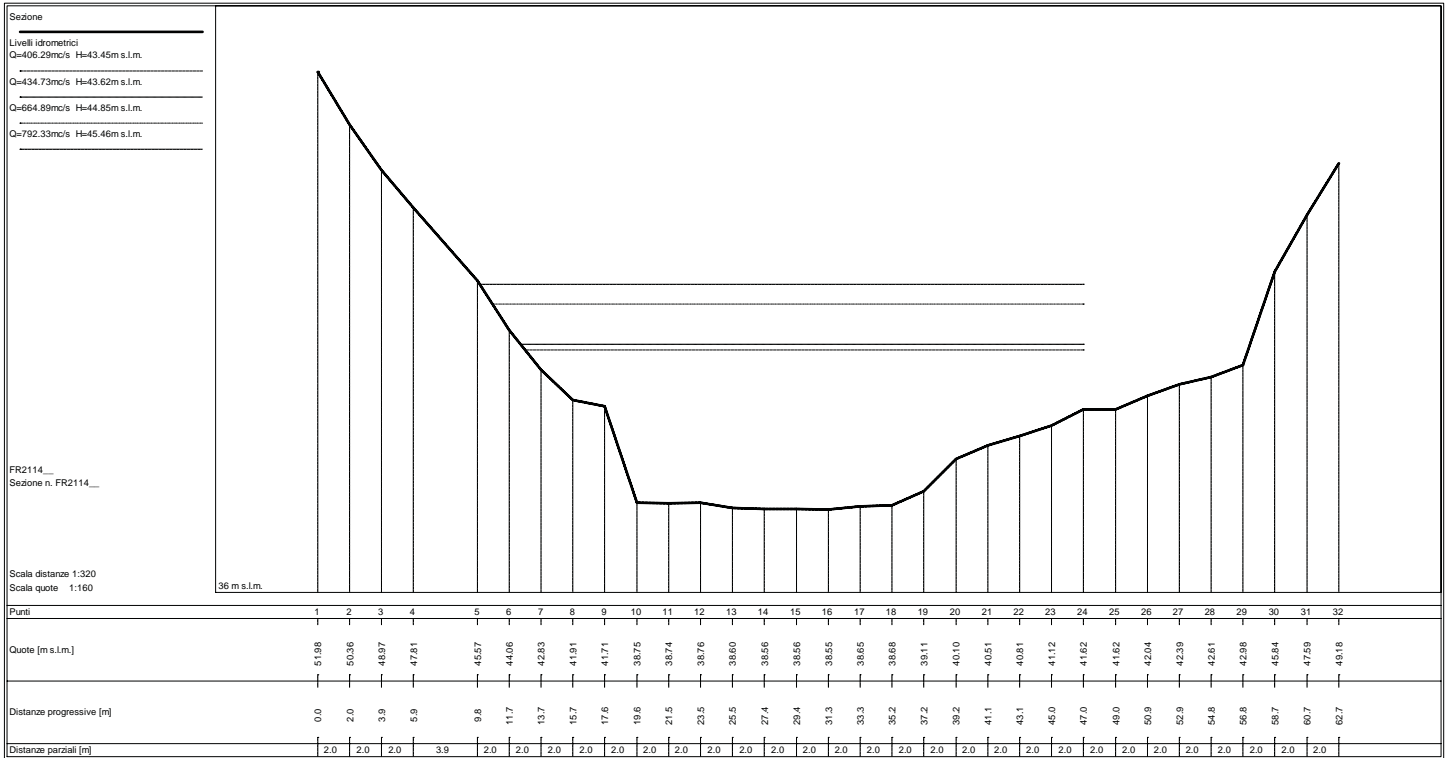

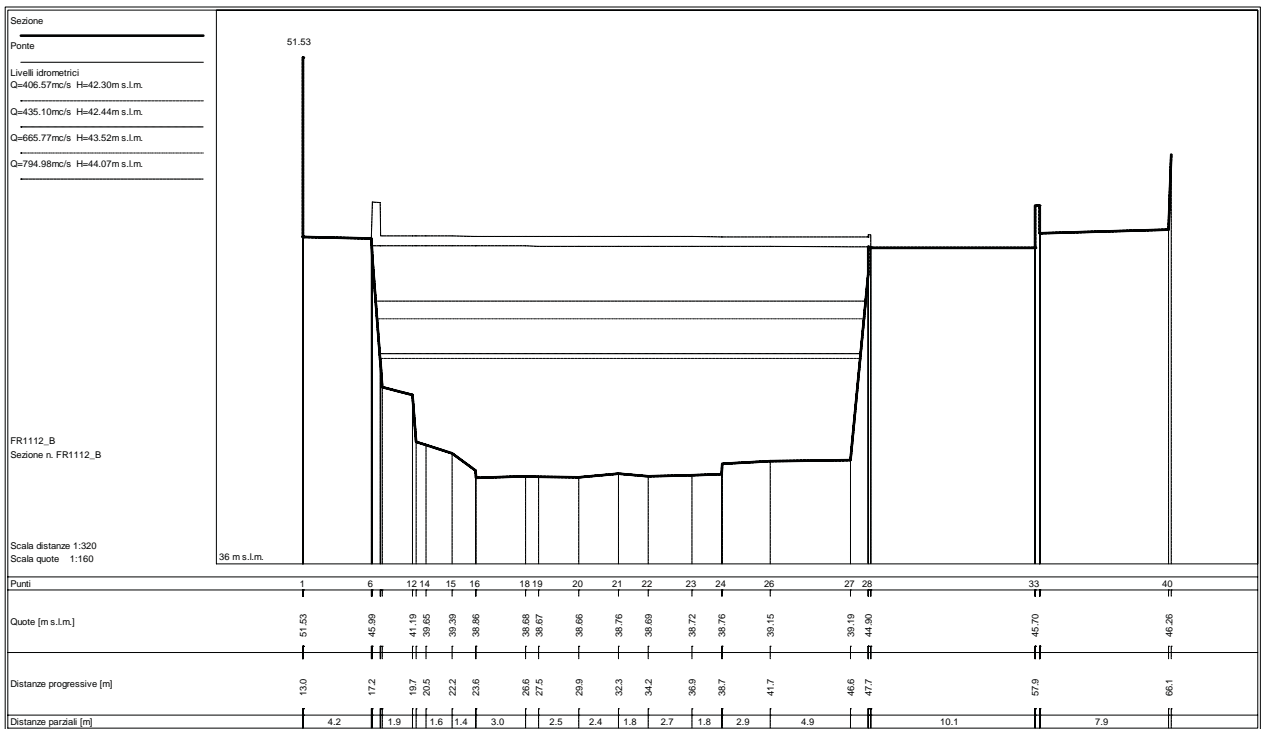
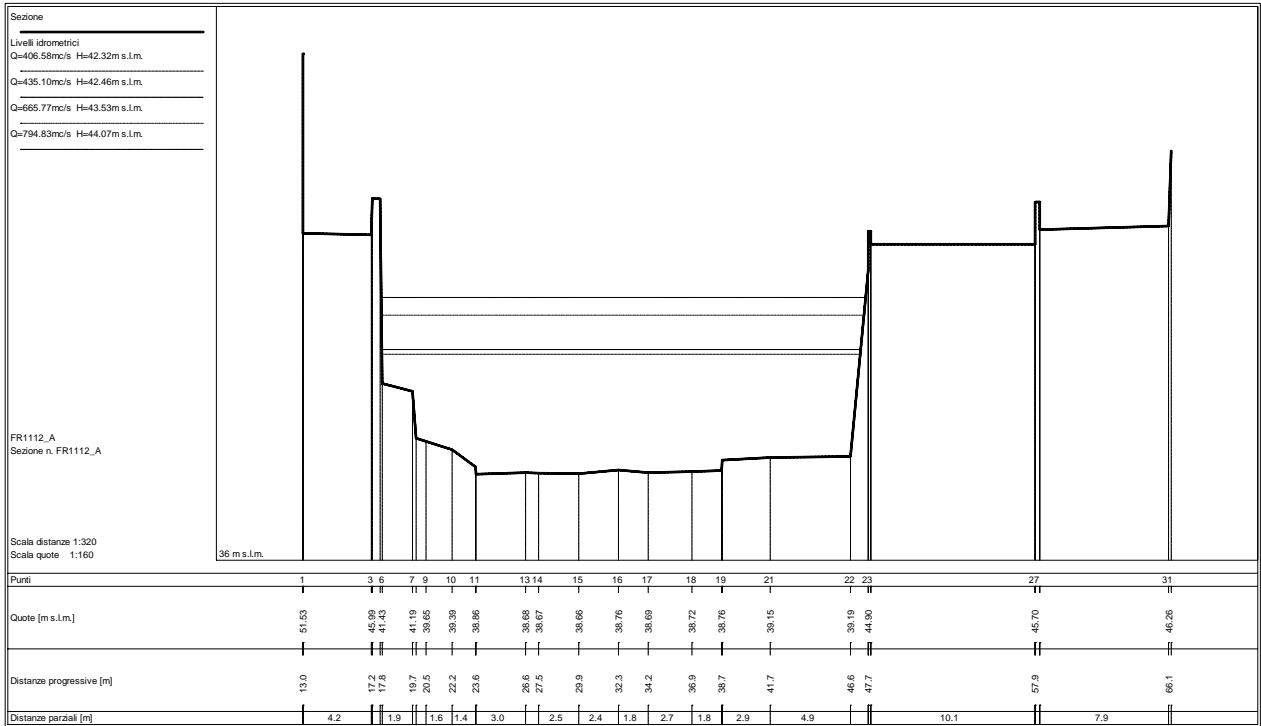

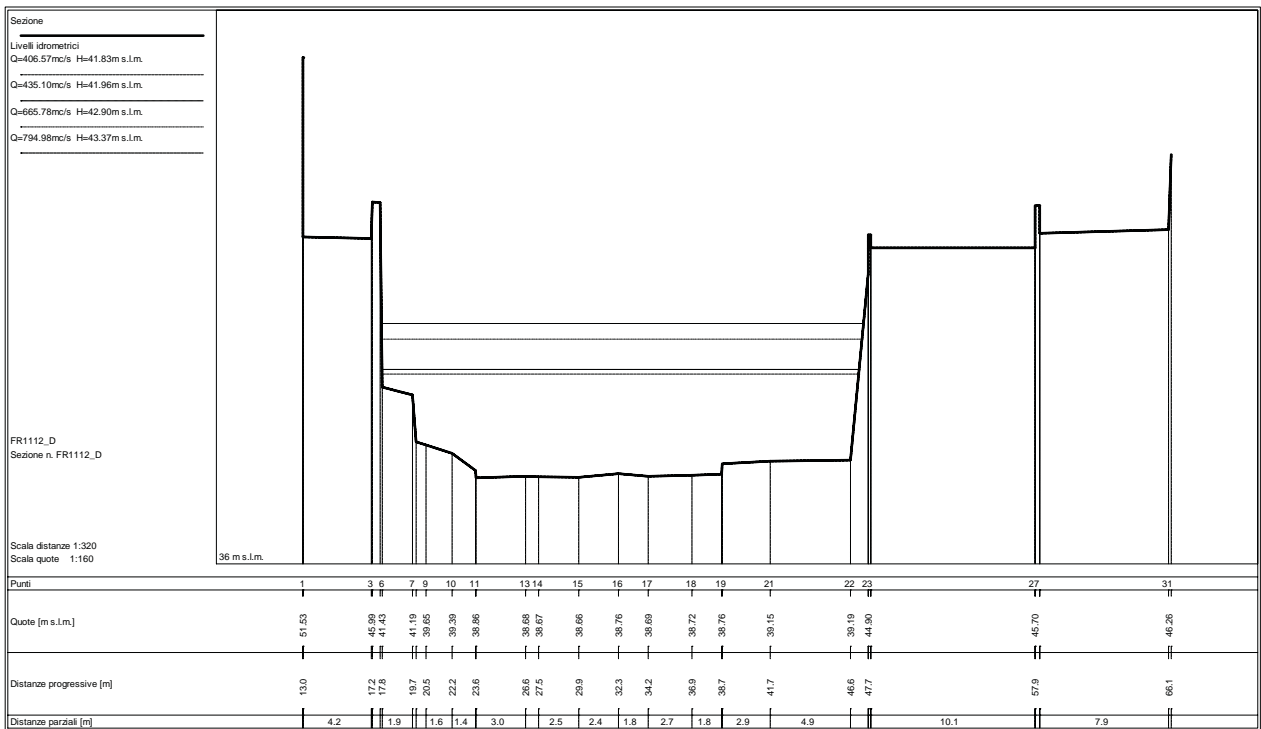
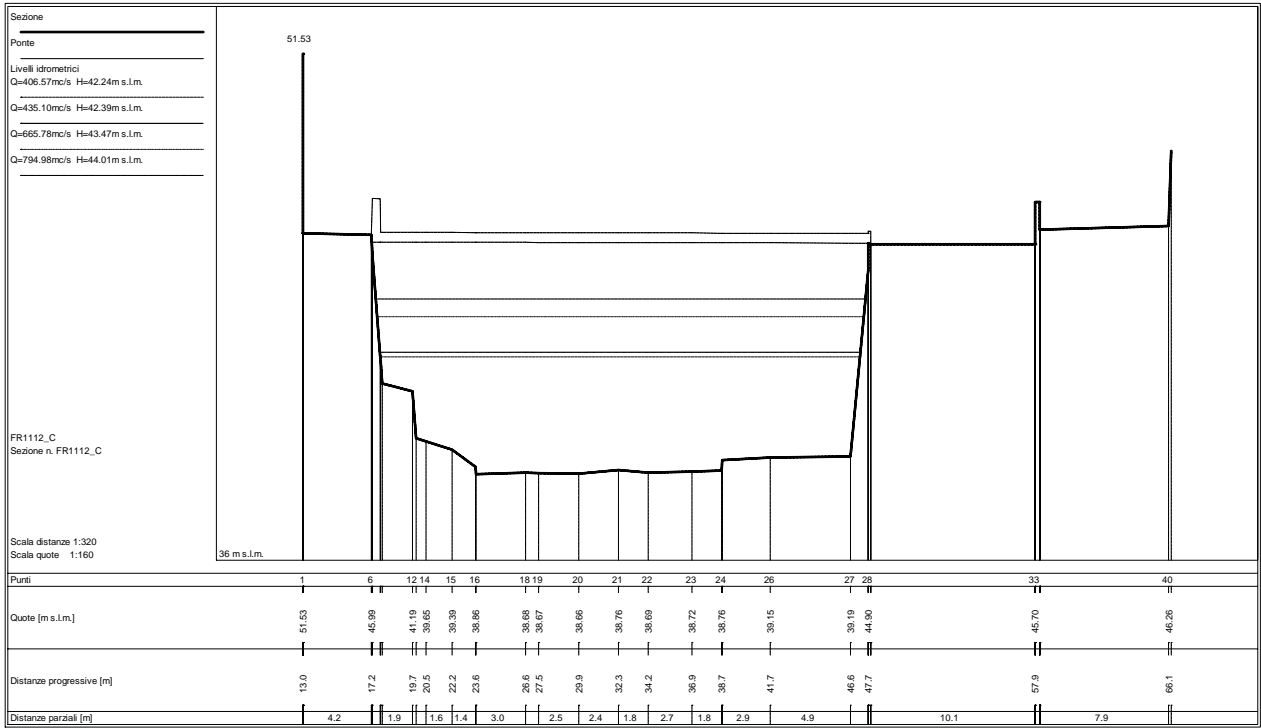

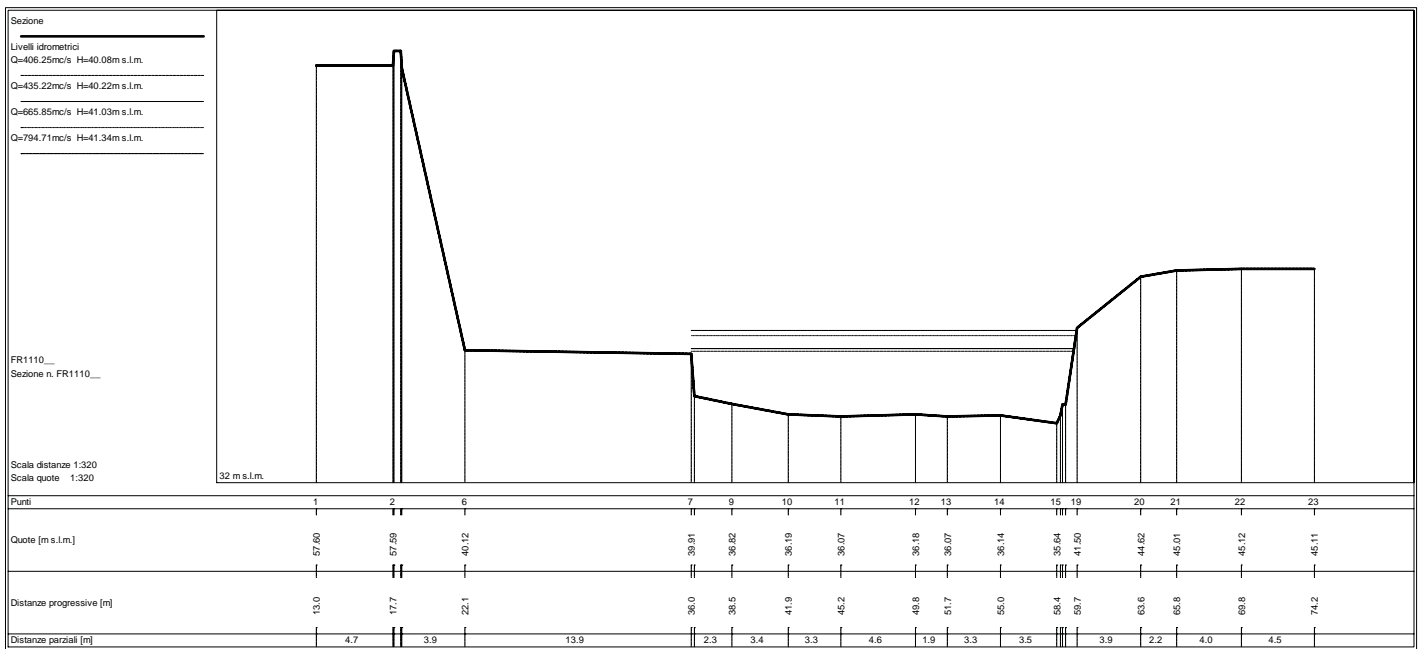
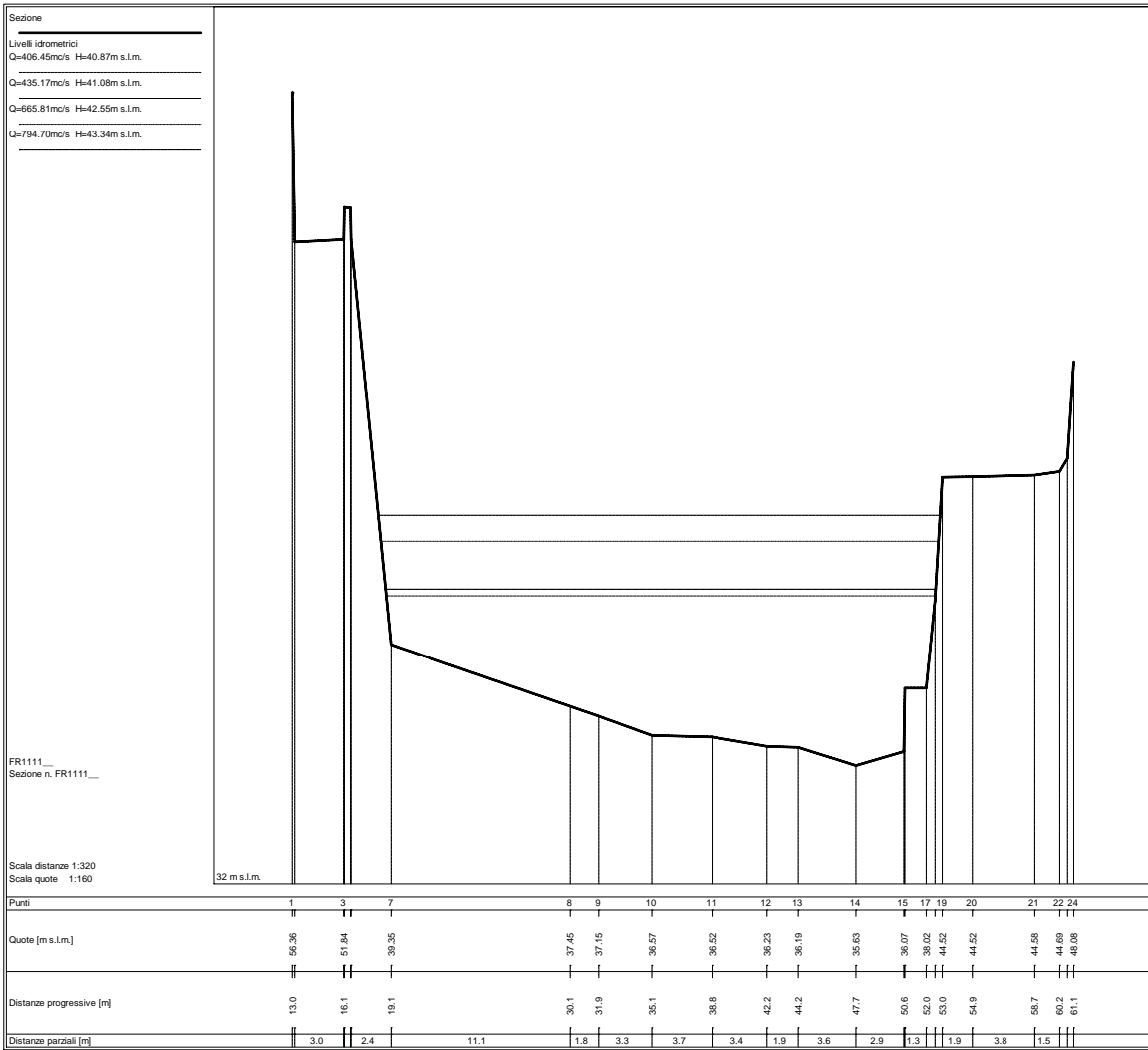

STATO ATTUALE

Sezioni fluviali fiume Frigido – FR_03

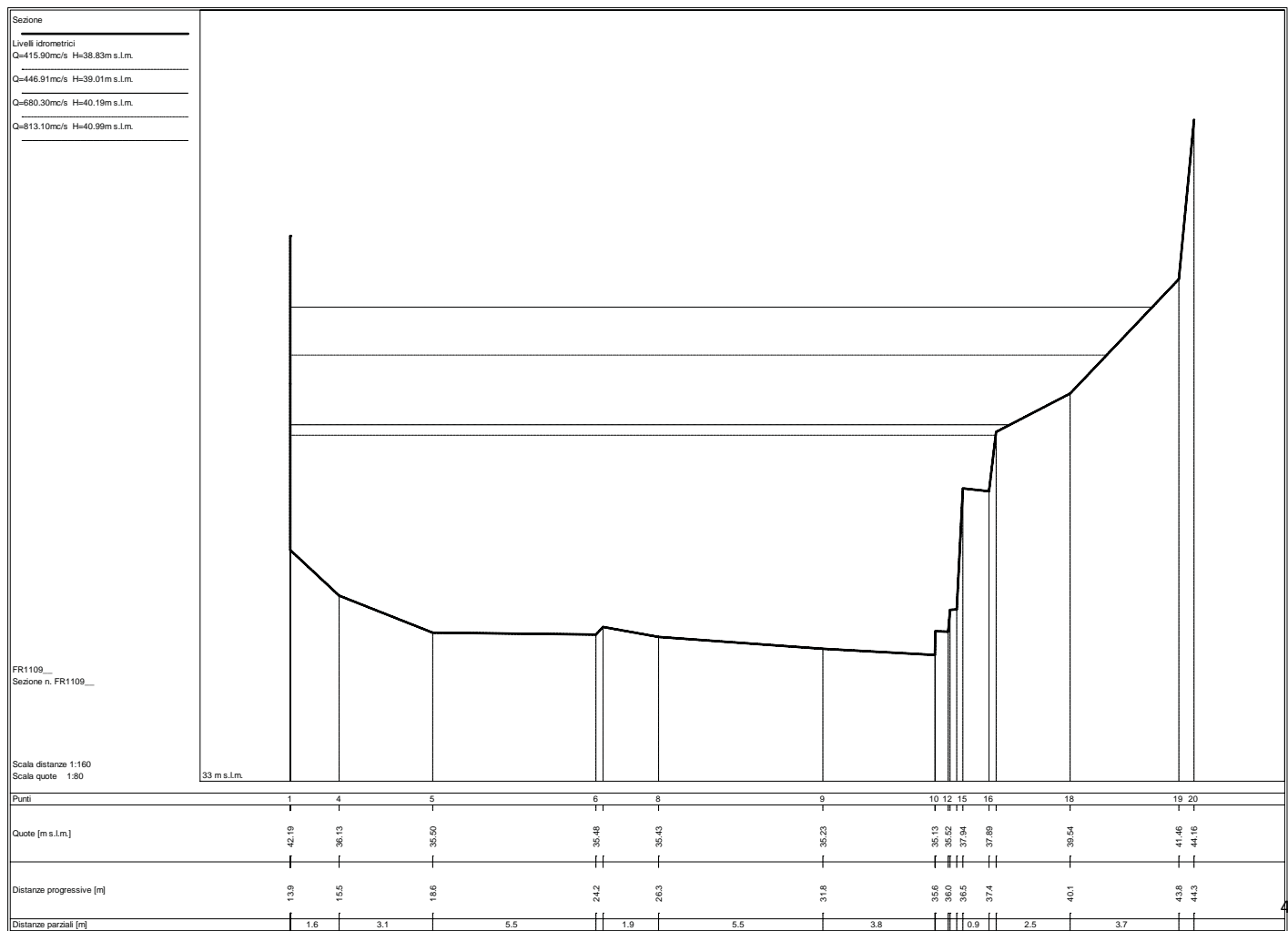
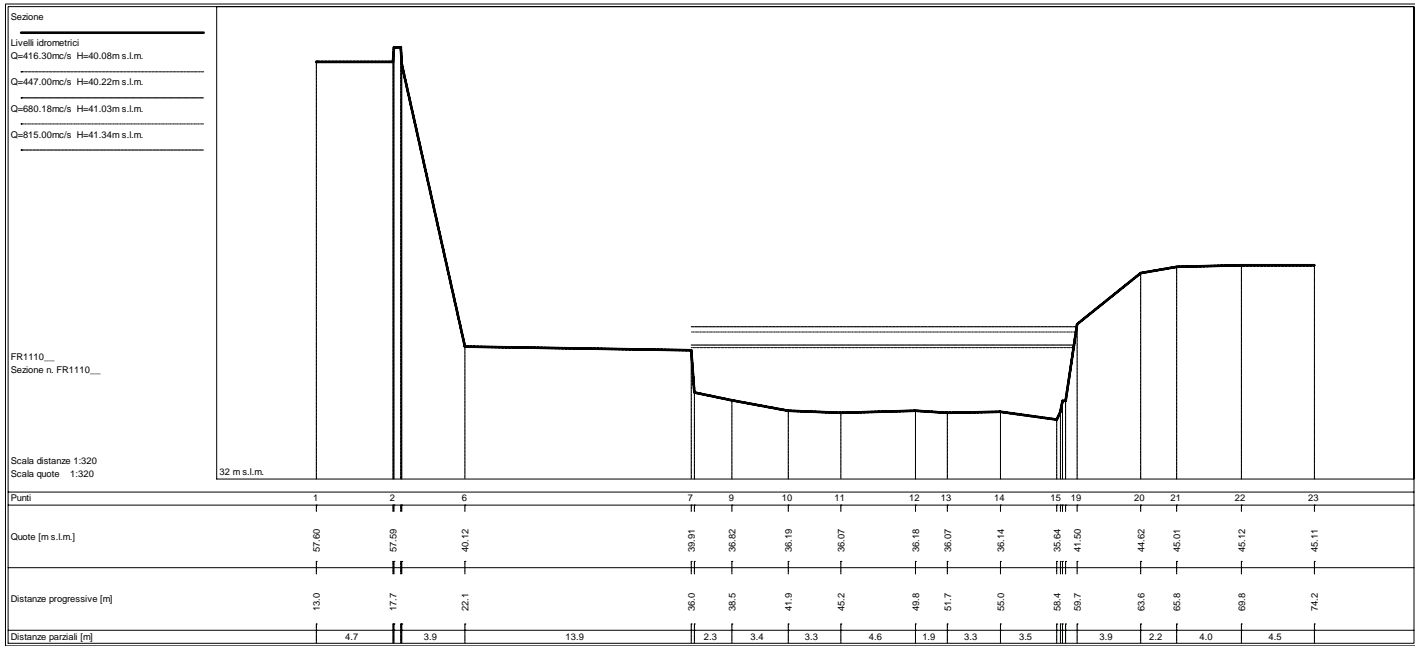

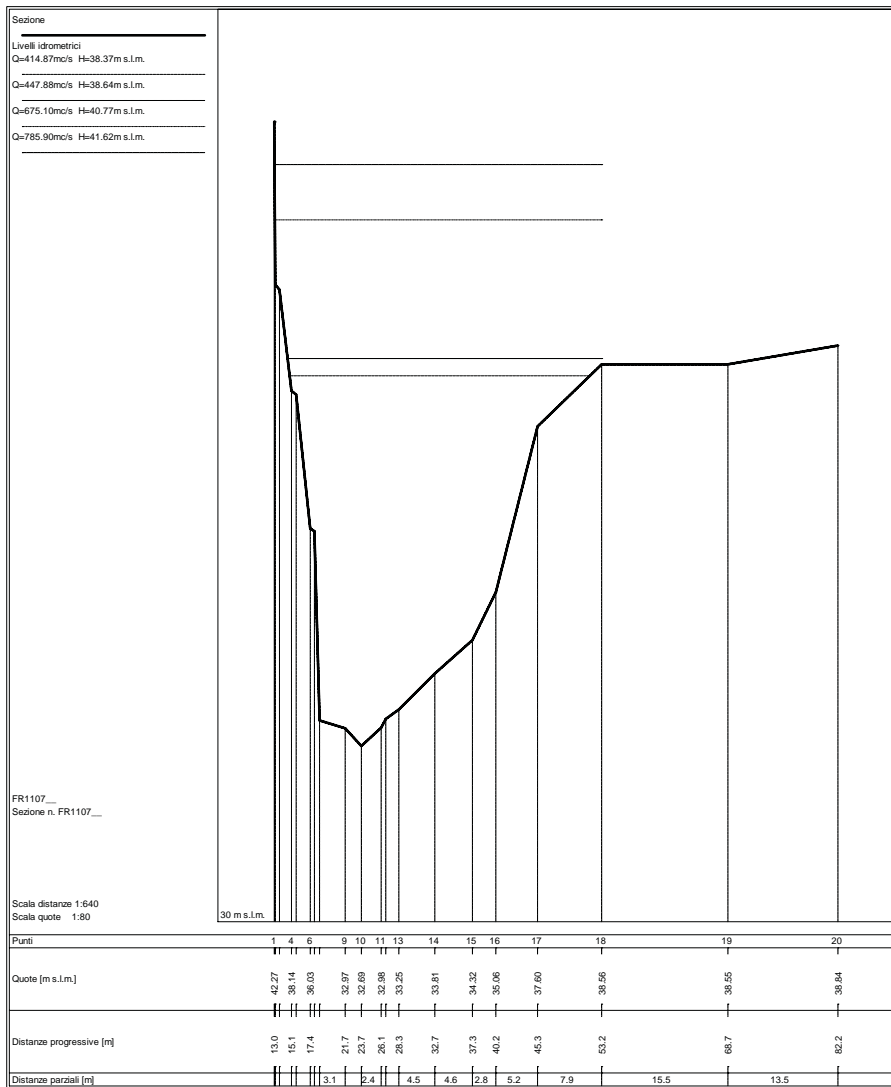
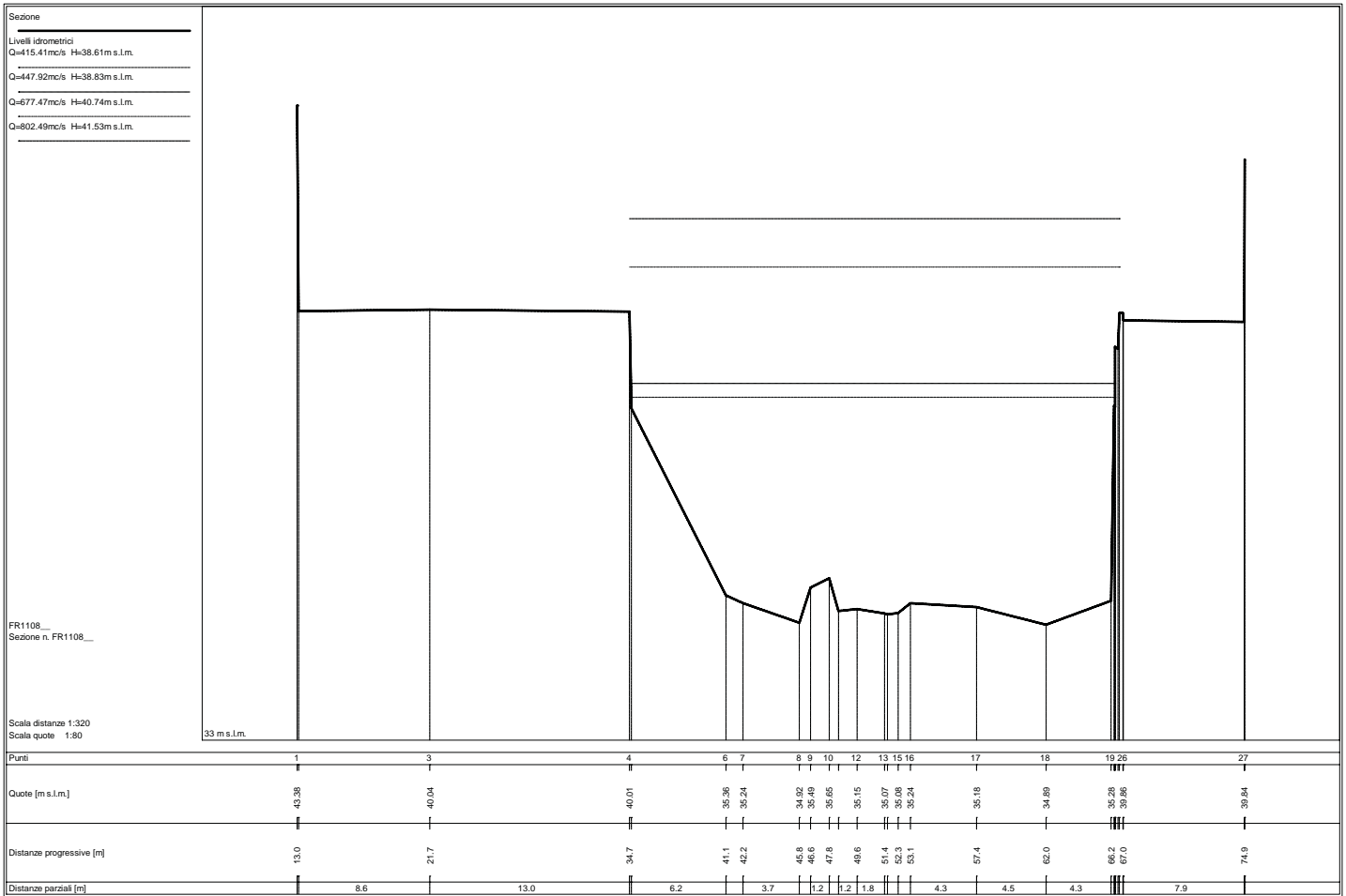

Sezione
 Livelli idrometrici
 Q=411.53m³/s H=38.30m s.l.m.
 Q=443.25m³/s H=38.56m s.l.m.
 Q=673.49m³/s H=40.66m s.l.m.
 Q=780.17m³/s H=41.52m s.l.m.

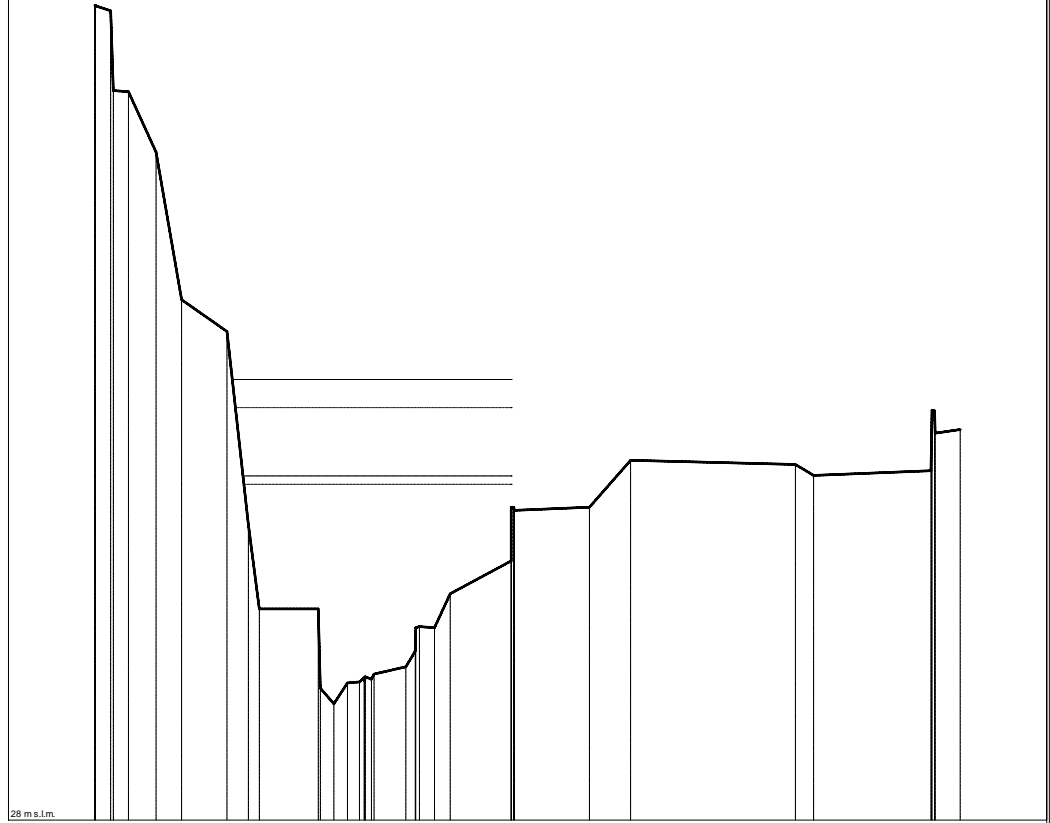

FR1106_A
 Sezione n. FR1106_A

Scala distanze 1:640
 Scala quote 1:160

Punti	1	3	5	6	7	8	9	11	13	14	16	21	24	25	26	27	31	32	33	34	35	39
Quote [m s.l.m.]	52.99	52.83	50.35	48.49	43.96	43.00	37.08	34.49	31.57	32.21	32.37	32.70	33.94	33.90	34.94	35.96	37.61	39.04	38.91	38.57	38.72	39.98
Distanze progressive [m]	13.0	14.9	17.1	20.5	23.6	29.2	31.8	40.4	42.3	44.0	46.0	51.1	52.8	54.7	56.6	64.1	73.7	78.7	98.0	107.2	115.6	119.2
Distanze parziali [m]		3.4	3.1	5.6	2.6	7.2					3.9			7.5		9.2	5.1		20.2		14.4	3.0

Sezione
 Ponte
 Livelli idrometrici
 Q=411.50m³/s H=37.75m s.l.m.
 Q=443.25m³/s H=38.13m s.l.m.
 Q=673.49m³/s H=40.54m s.l.m.
 Q=780.16m³/s H=41.44m s.l.m.

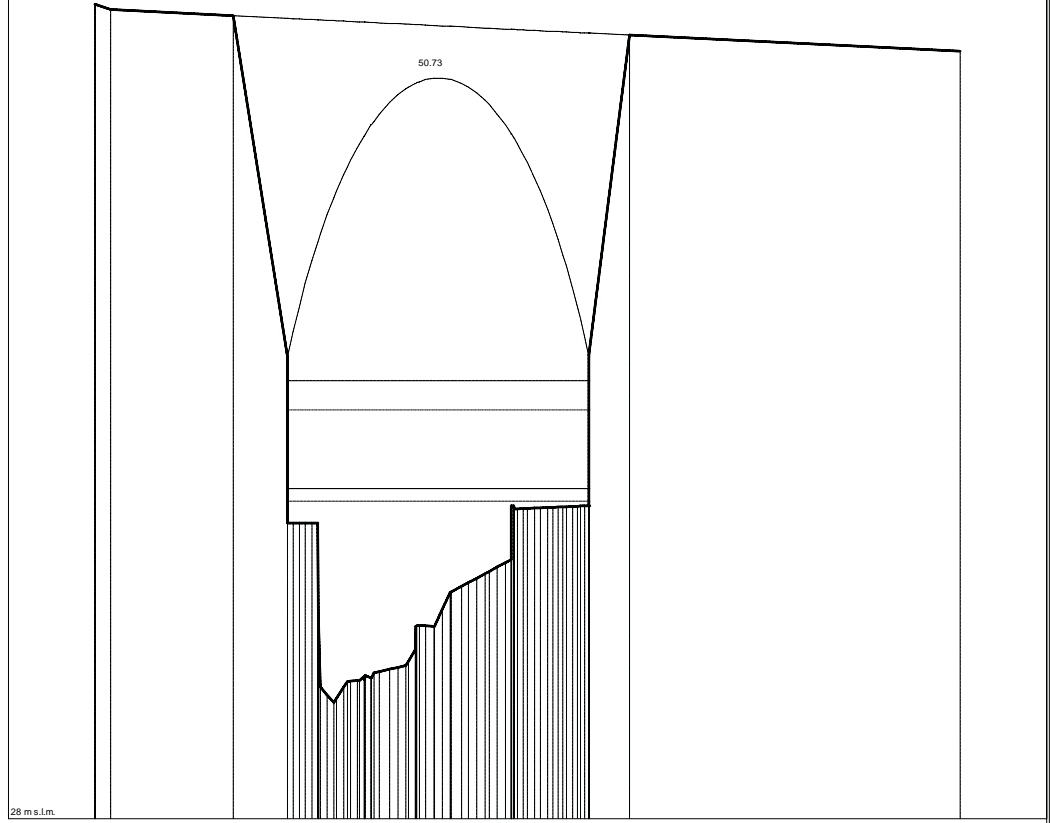

FR1106_B
 Sezione n. FR1106_B

Scala distanze 1:640
 Scala quote 1:160

Punti	1	3	4	5	8	10	15	18	21	26	30	32	37	39	42	45	47	50	57	60	62	65	68	73	74	
Quote [m s.l.m.]	52.99	52.83	52.64	42.17	37.08	37.08	31.80	32.05	32.23	32.32	32.59	32.70	33.94	33.90	34.94	35.24	35.52	35.86	37.52	37.54	37.56	37.58	37.59	52.04	51.95	
Distanze progressive [m]	13.0	14.9	30.0	36.6	38.1	38.6	41.5	43.5	45.2	46.9	49.1	51.1	52.8	54.6	56.6	58.8	60.9	63.4	65.6	67.6	69.2	70.8	72.6	78.6	119.2	
Distanze parziali [m]			15.0	6.7																				5.0	40.6	

Sezione

Porte

Livelli idrometrici

Q=411.24m³/s H=37.52m s.l.m.

Q=443.22m³/s H=38.07m s.l.m.

Q=673.47m³/s H=40.53m s.l.m.

Q=780.11m³/s H=41.43m s.l.m.



FR1106_C
Sezione n. FR1106_C

Scala distanze 1:640
Scala quote 1:160

Punti	1	3	4	5	8	10	15	18	21	26	30	32	37	39	42	45	47	50	57	60	62	65	68	73	74	
Quote [m s.l.m.]	52.99	52.83	52.64	42.17	37.08	37.08	31.80	32.05	32.23	32.32	32.59	32.70	33.94	33.90	34.94	35.24	35.52	35.86	37.52	37.54	37.56	37.58	37.59	52.04	51.55	
Distanze progressive [m]	13.0	14.9	30.0	36.6	38.1	39.6	41.5	43.5	45.2	46.9	48.1	51.1	52.8	54.6	56.6	58.8	60.9	63.4	65.6	67.6	69.2	70.8	72.6	76.6	119.2	
Distanze parziali [m]		15.0	6.7																					5.0	40.6	

Sezione

Livelli idrometrici

Q=411.37m³/s H=37.55m s.l.m.

Q=443.51m³/s H=37.94m s.l.m.

Q=673.99m³/s H=39.91m s.l.m.

Q=780.15m³/s H=40.70m s.l.m.

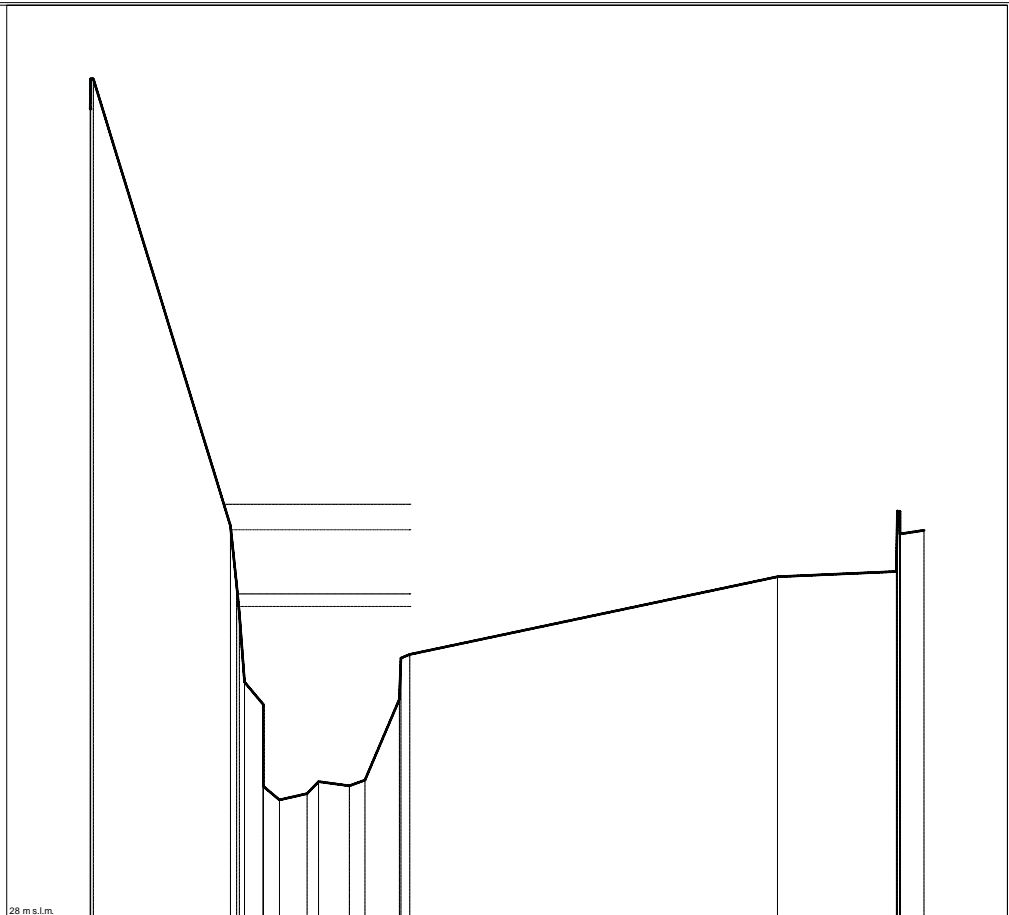

FR1106_D
Sezione n. FR1106_D

Scala distanze 1:640
Scala quote 1:160

Punti	1	4	7	8	11	12	14	15	16	19	20	24
Quote [m s.l.m.]	52.81	40.04	35.24	34.55	31.61	31.80	32.05	32.23	34.71	38.47	38.62	39.88
Distanze progressive [m]	13.0	30.2	31.9	34.2	36.2	38.6	44.8	46.7	51.0	97.3	111.9	115.4
Distanze parziali [m]		16.8			3.4	3.7		4.2		45.1	14.6	3.0

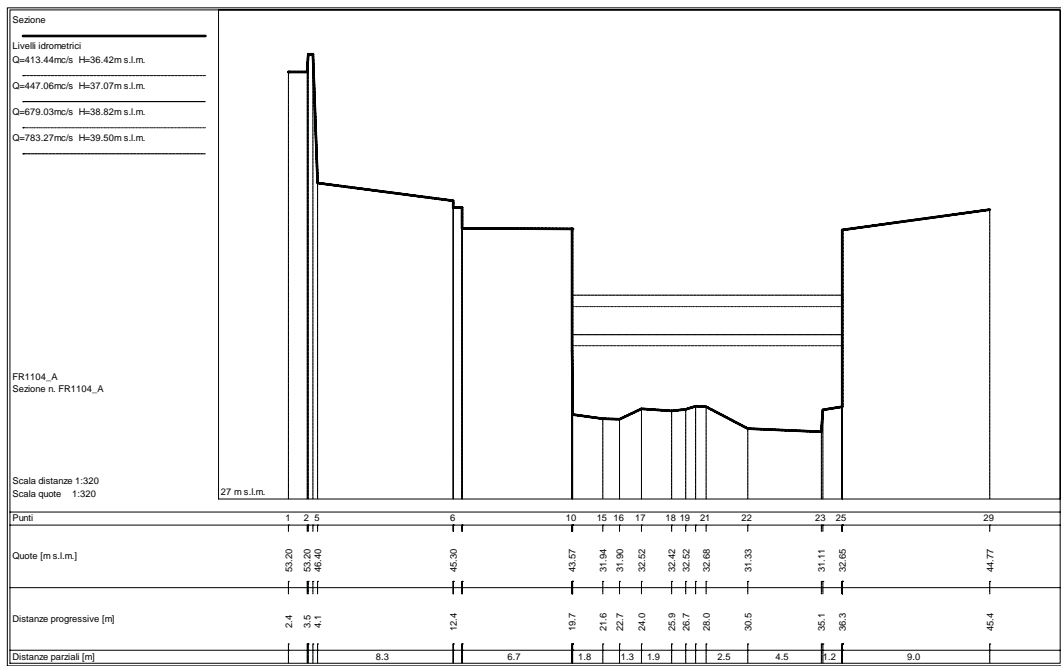
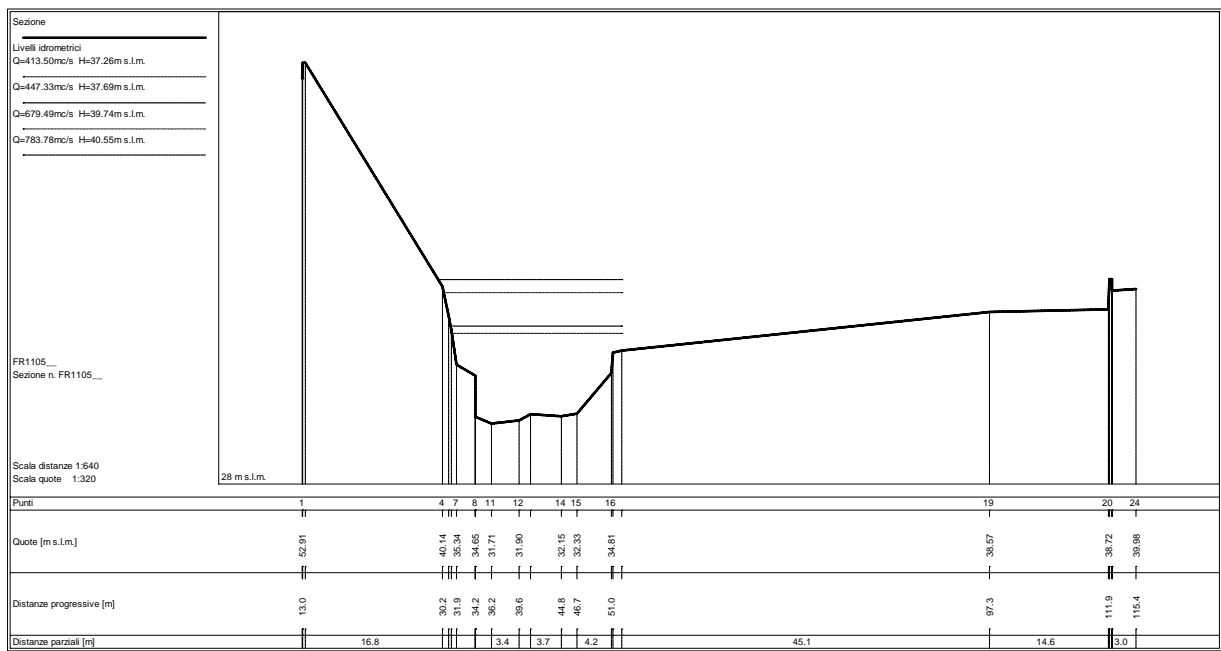

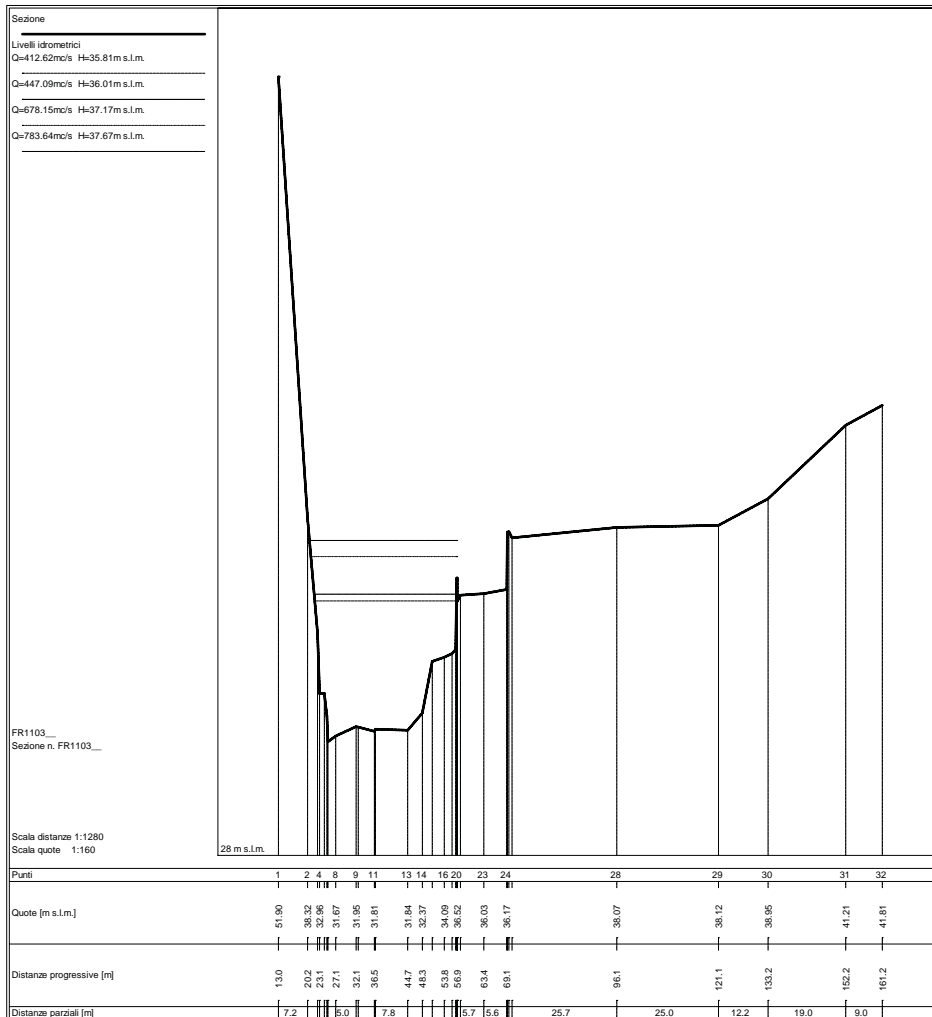
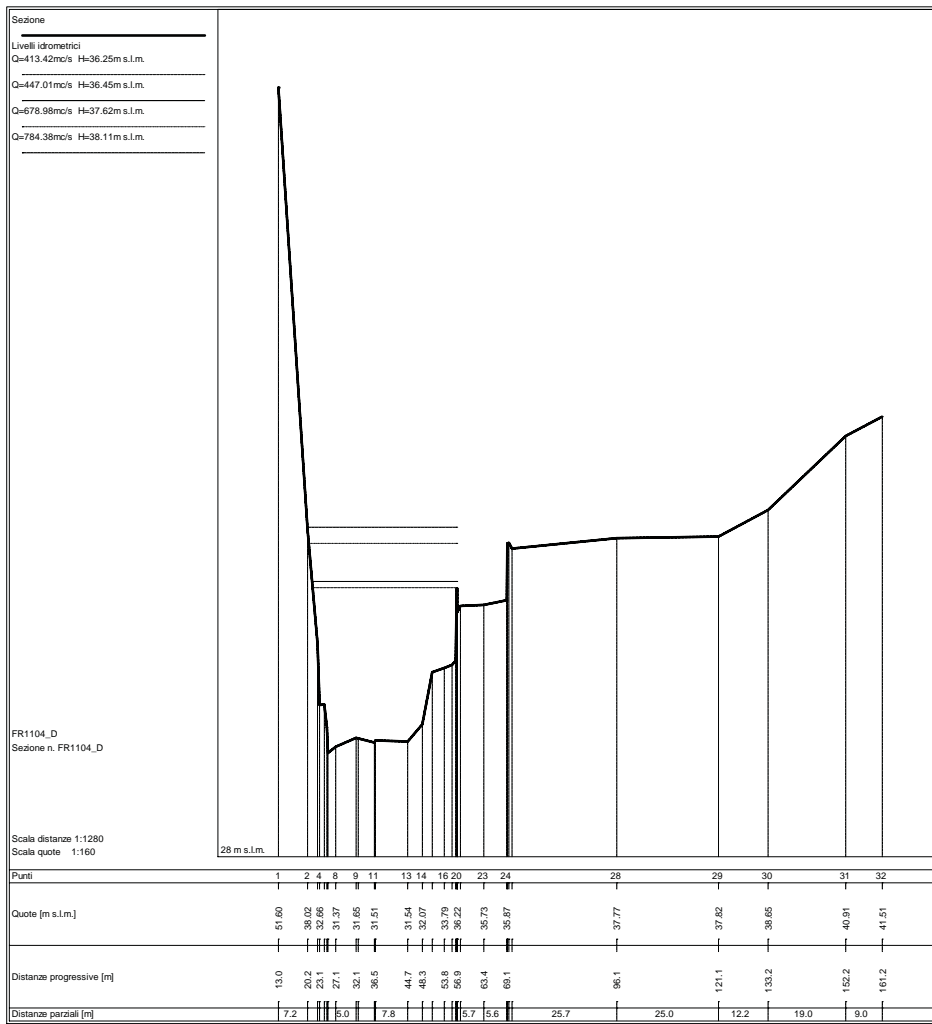

STATO ATTUALE

Sezioni fluviali fiume Frigido – FR_04

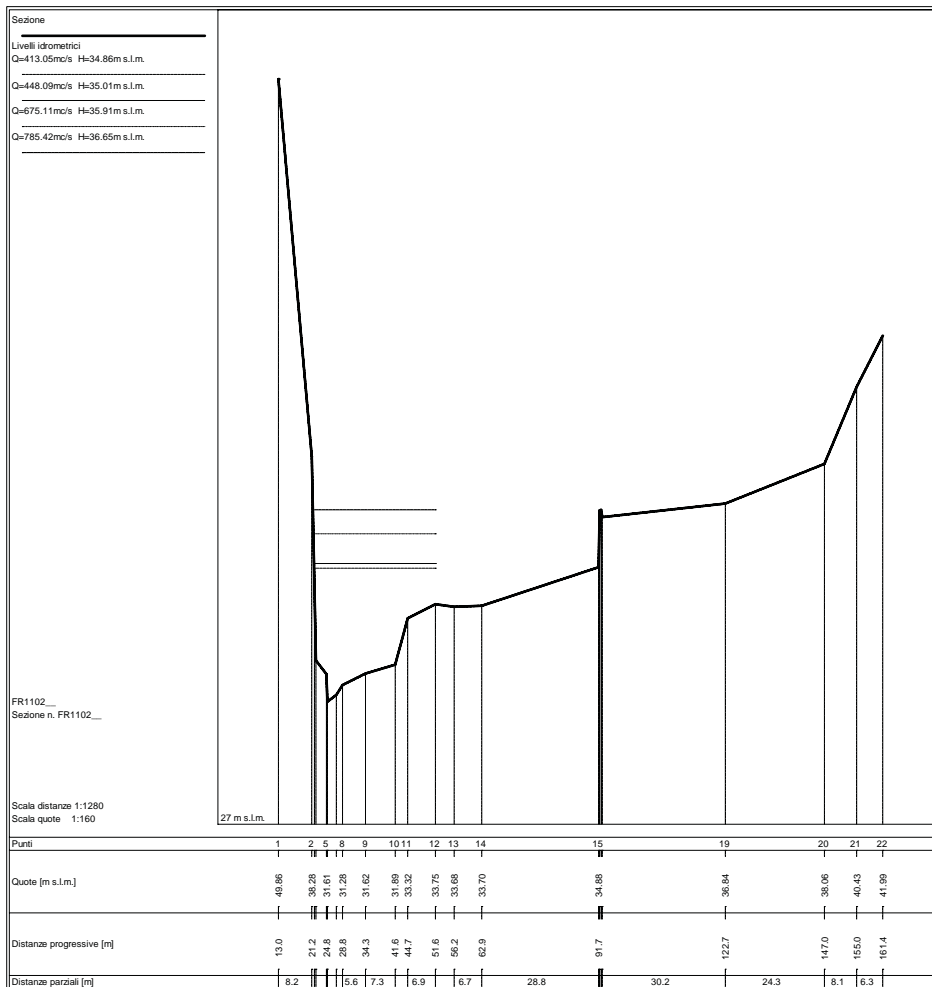
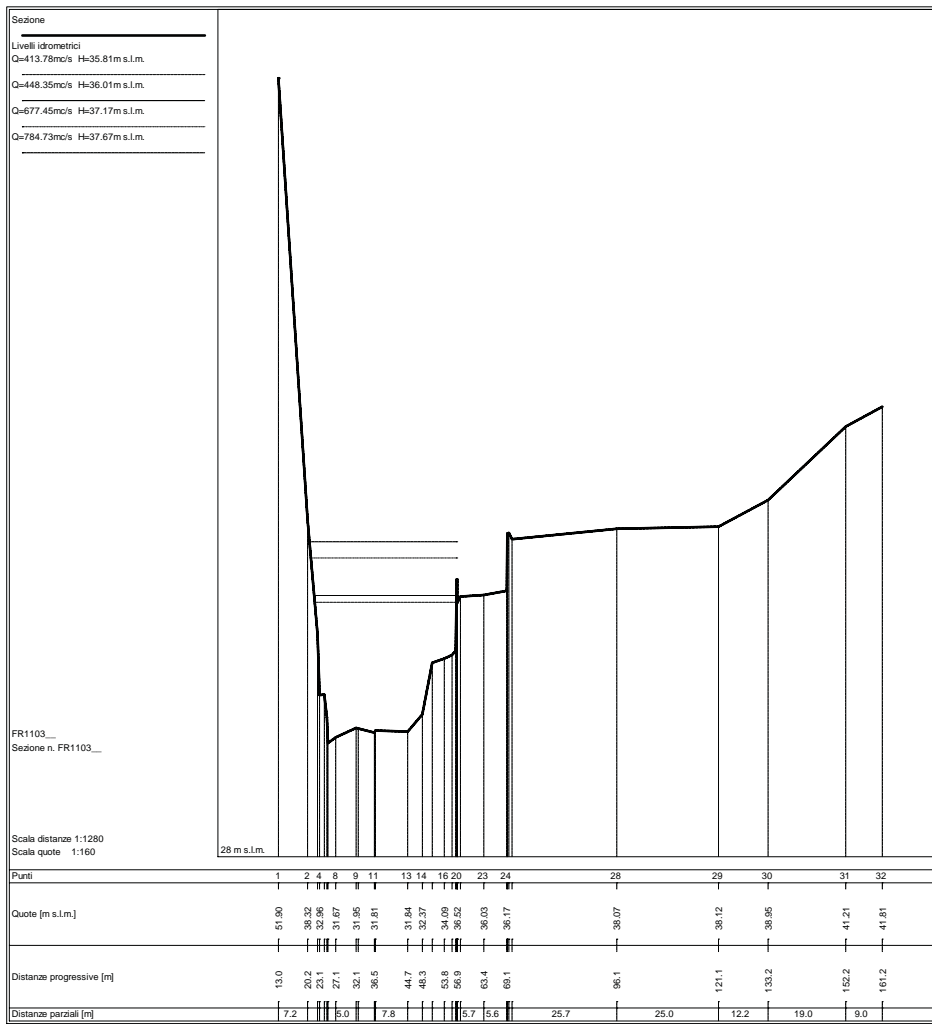

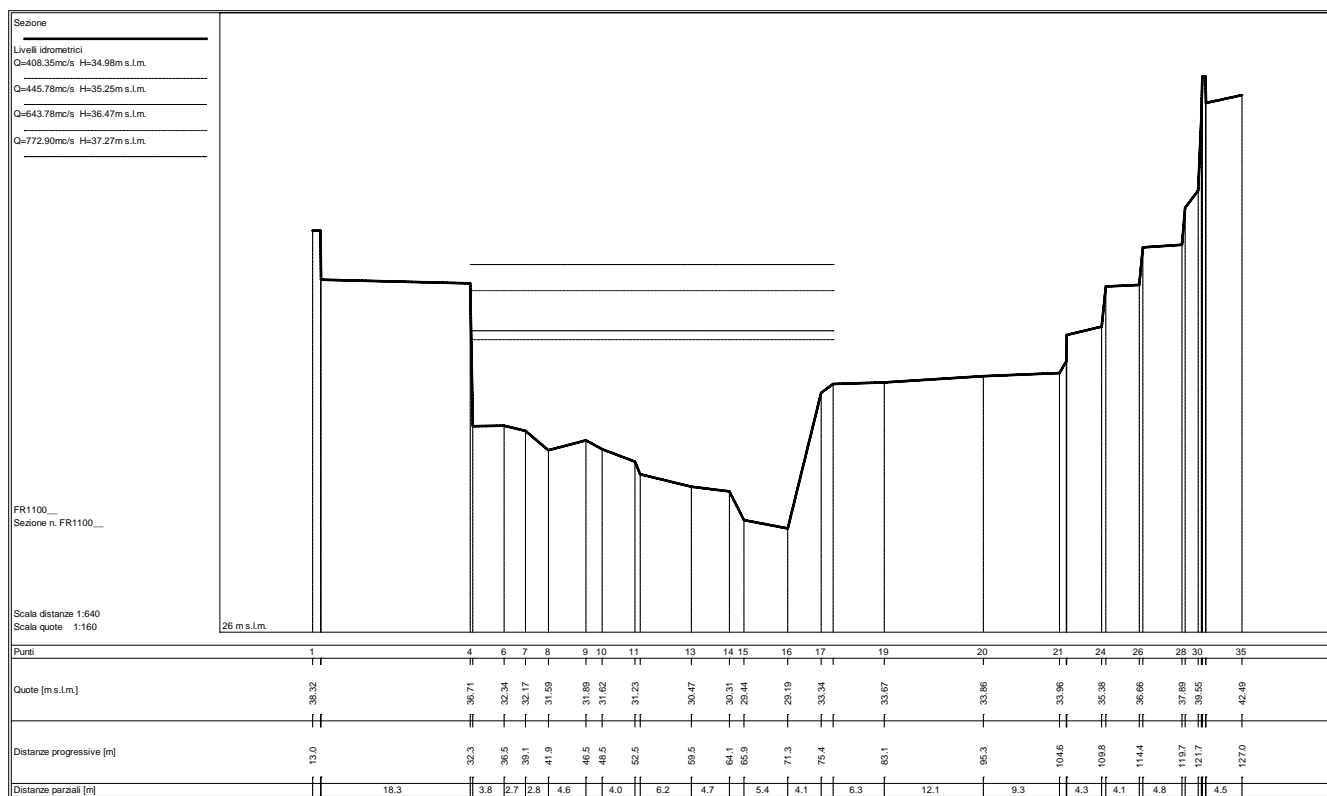
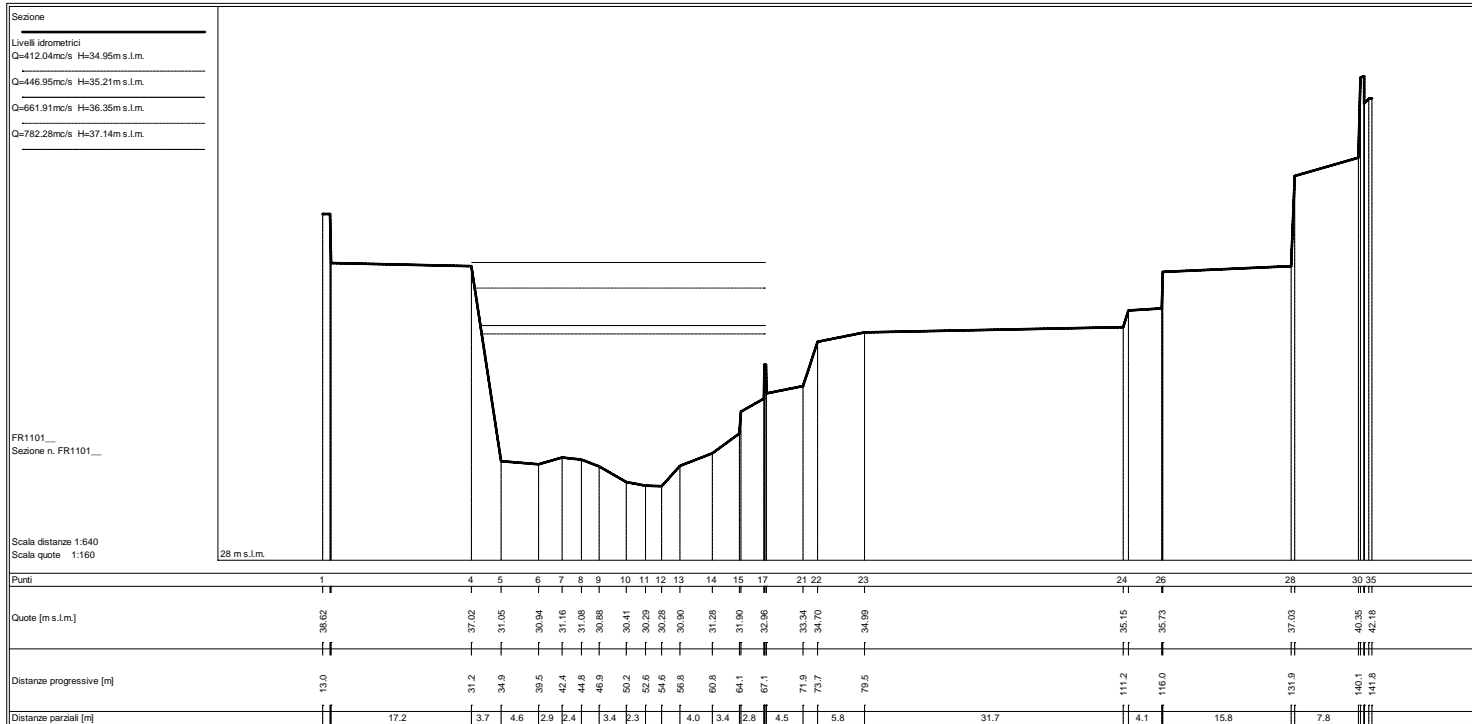

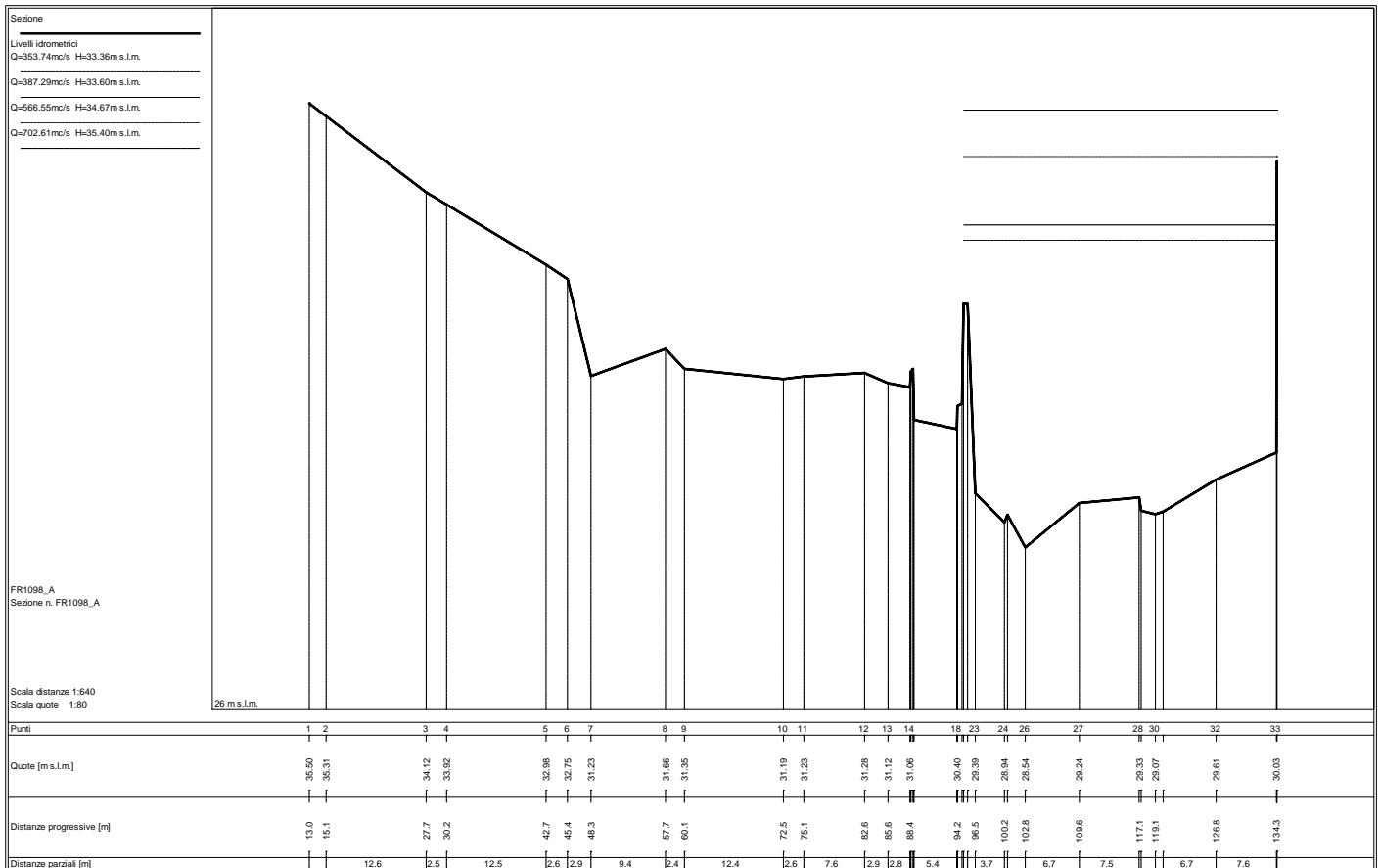
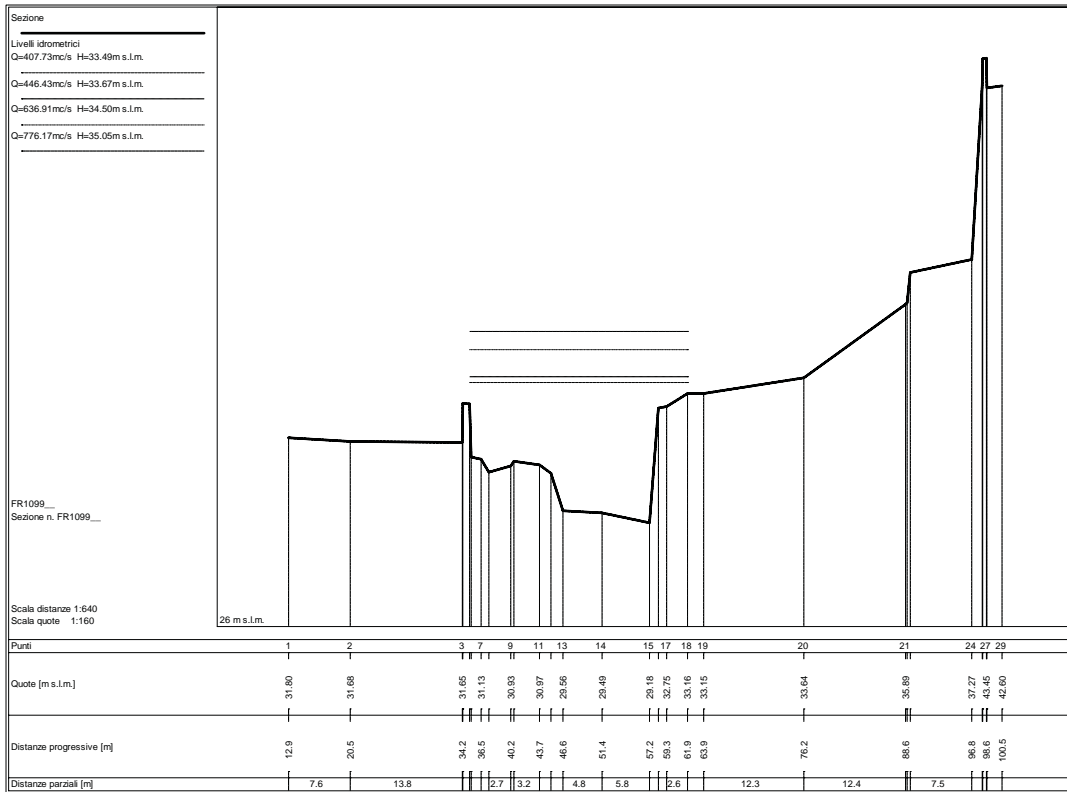

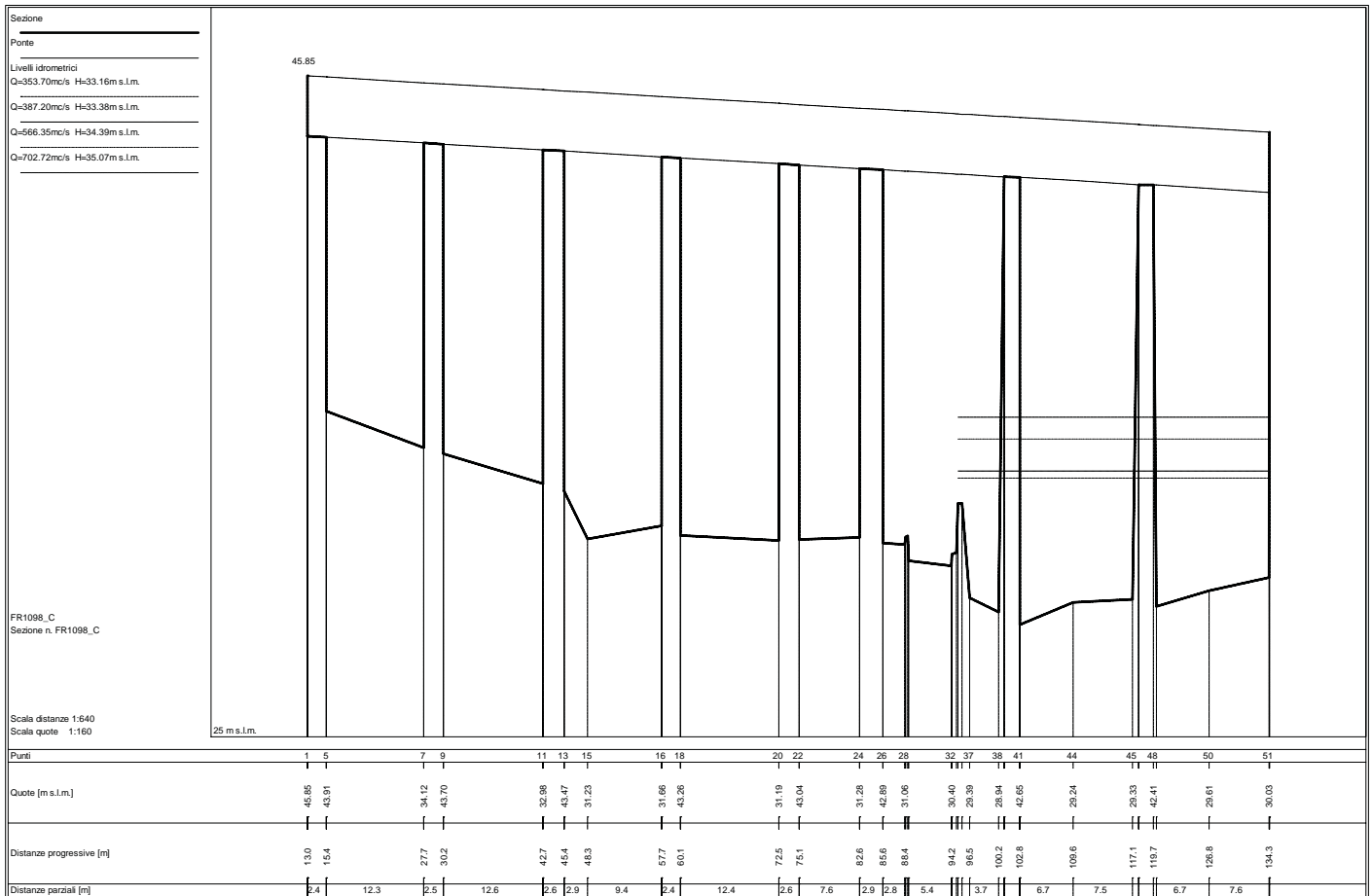
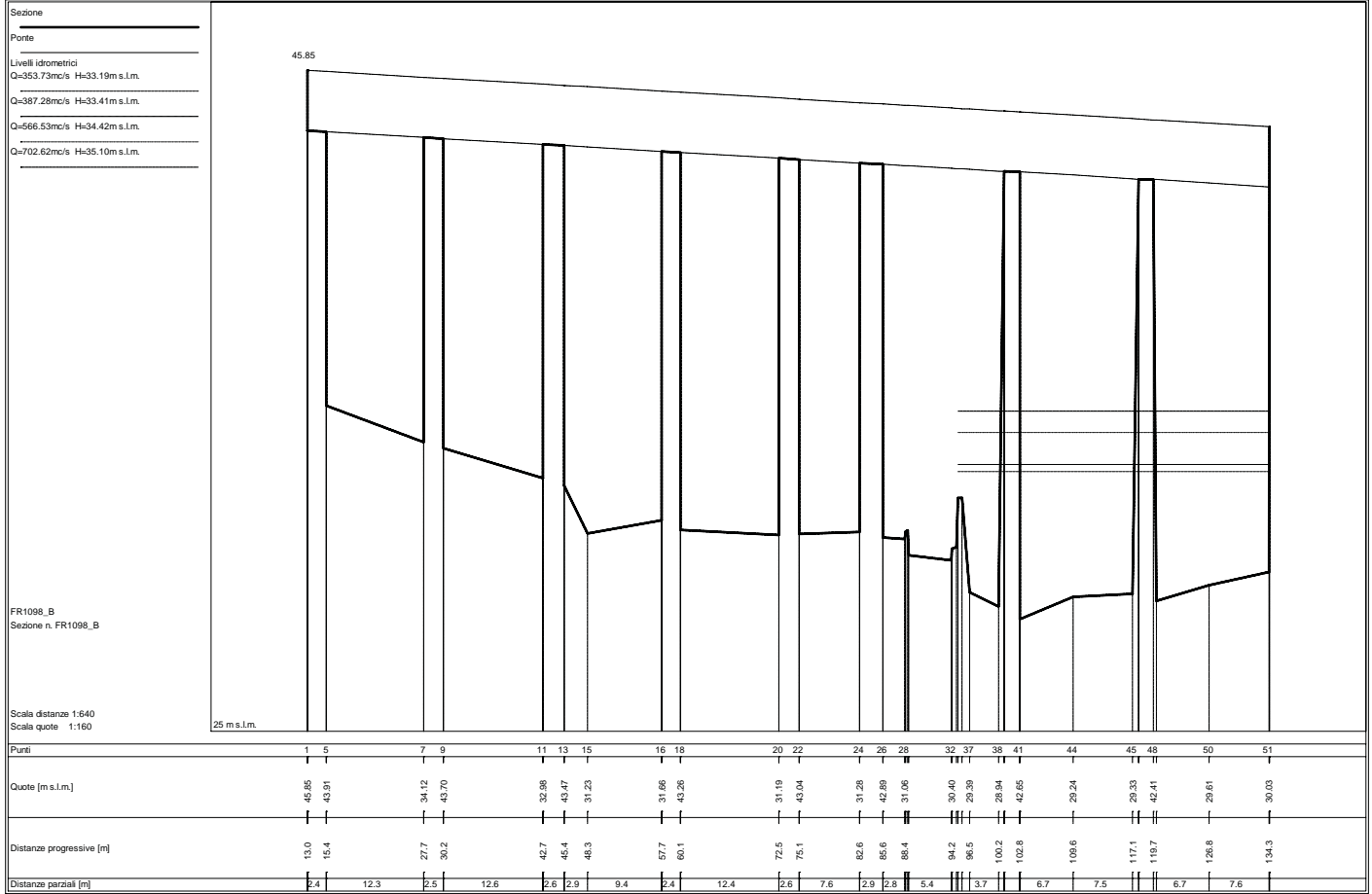

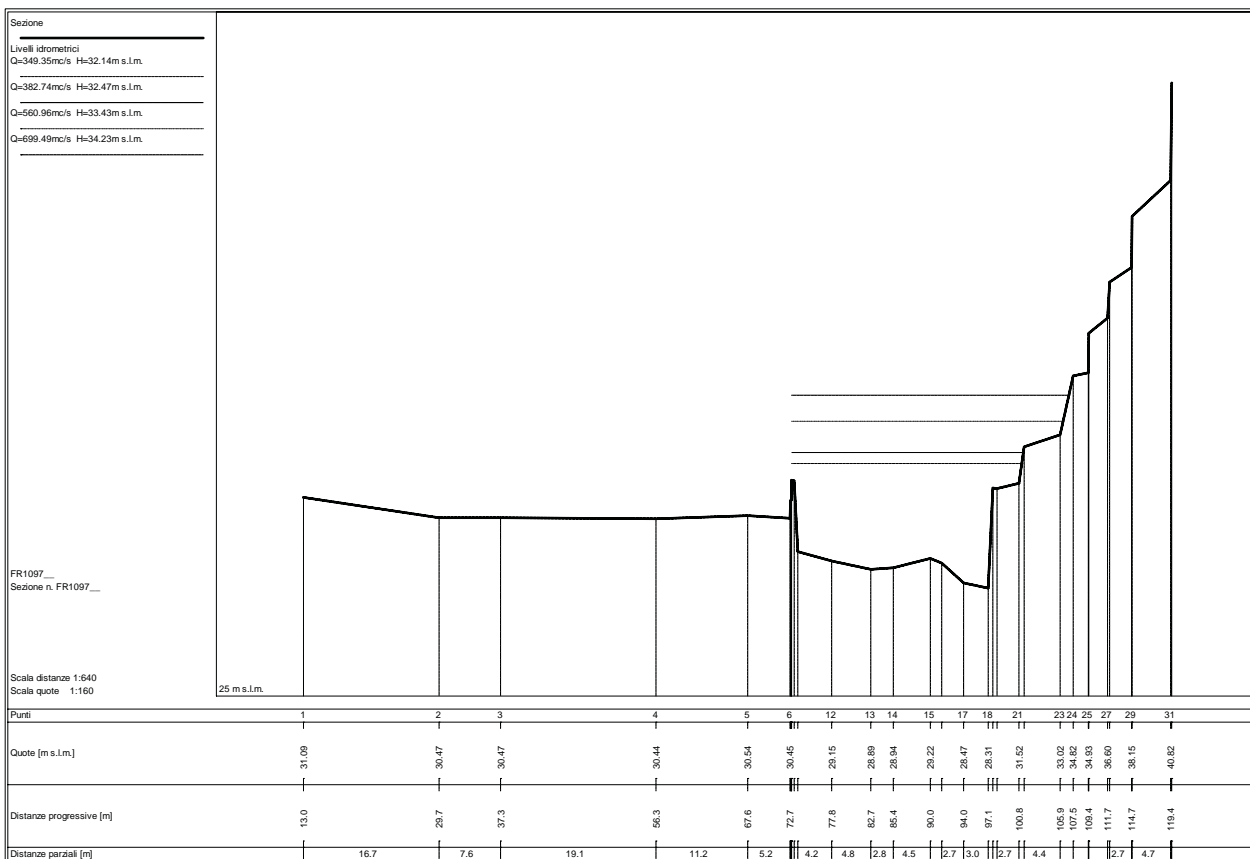
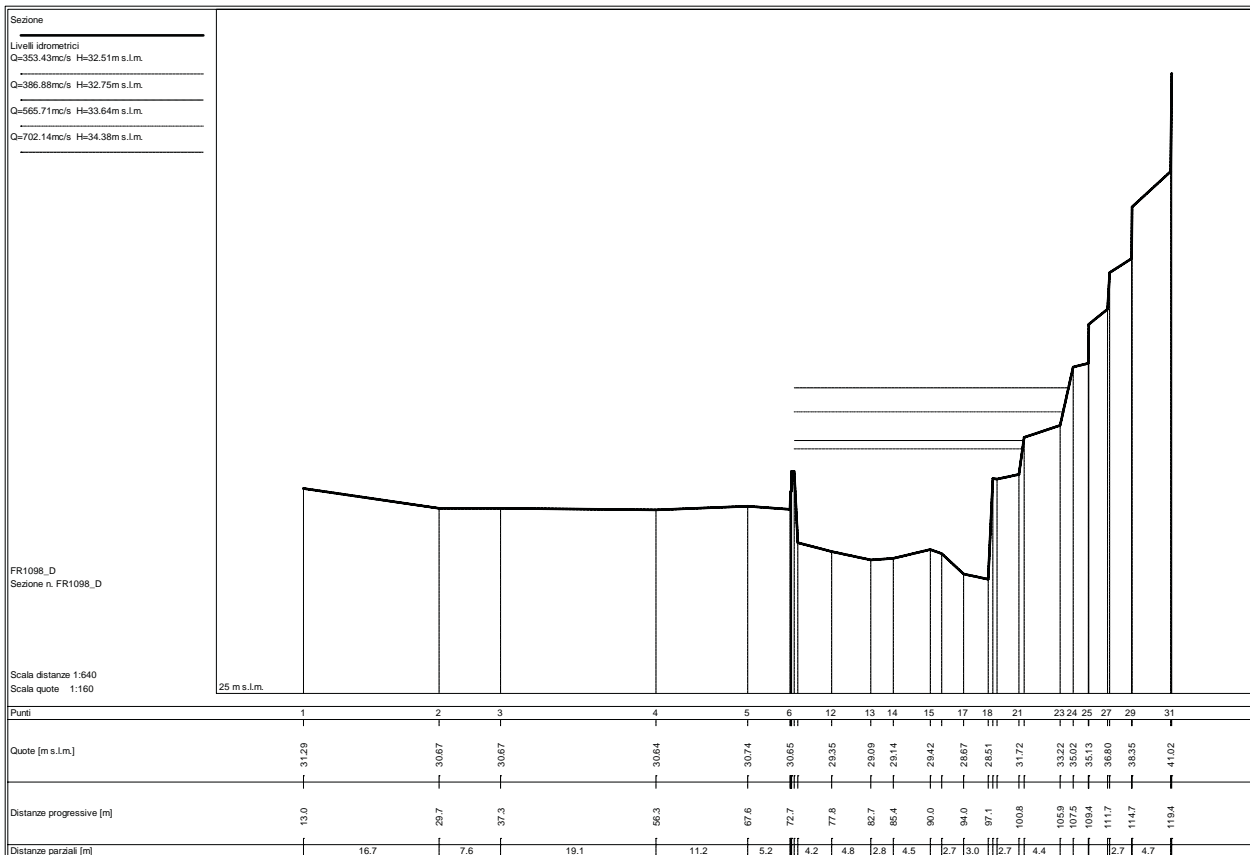

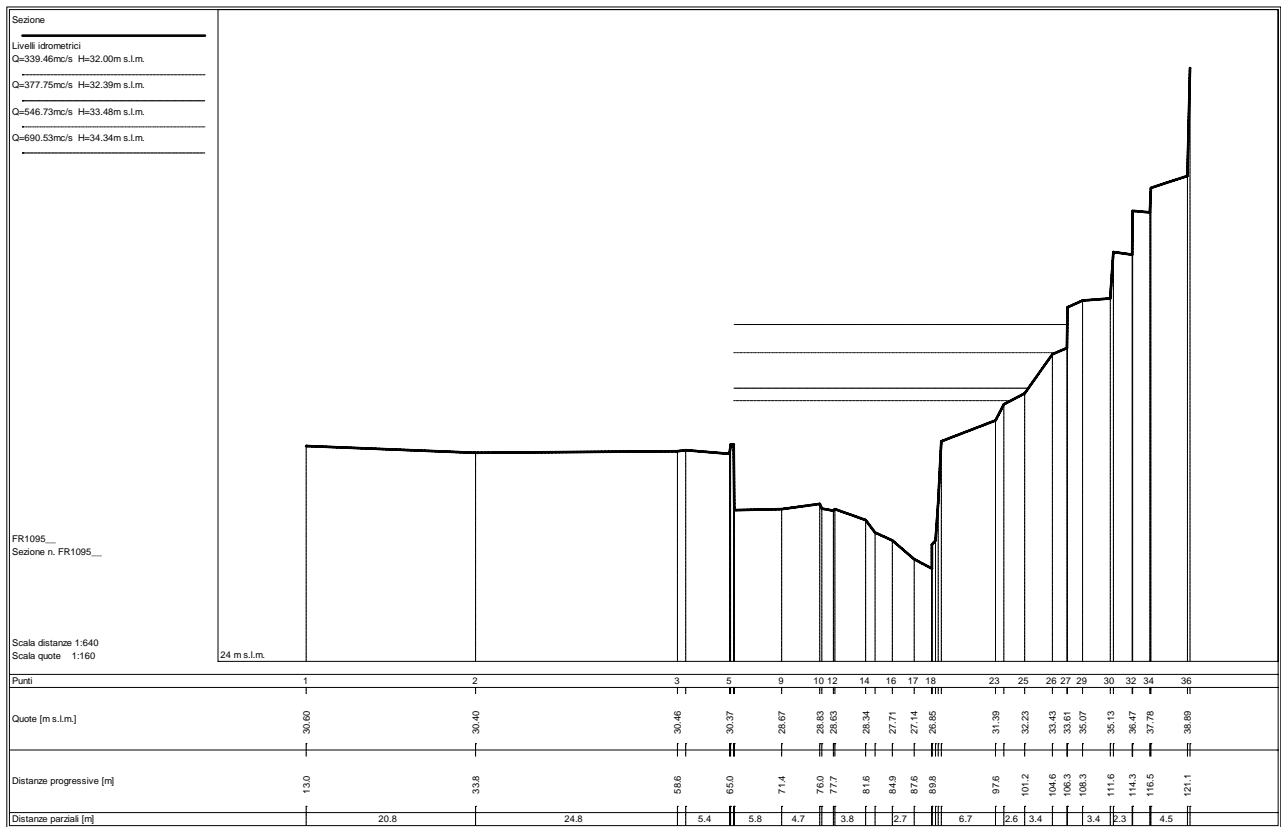
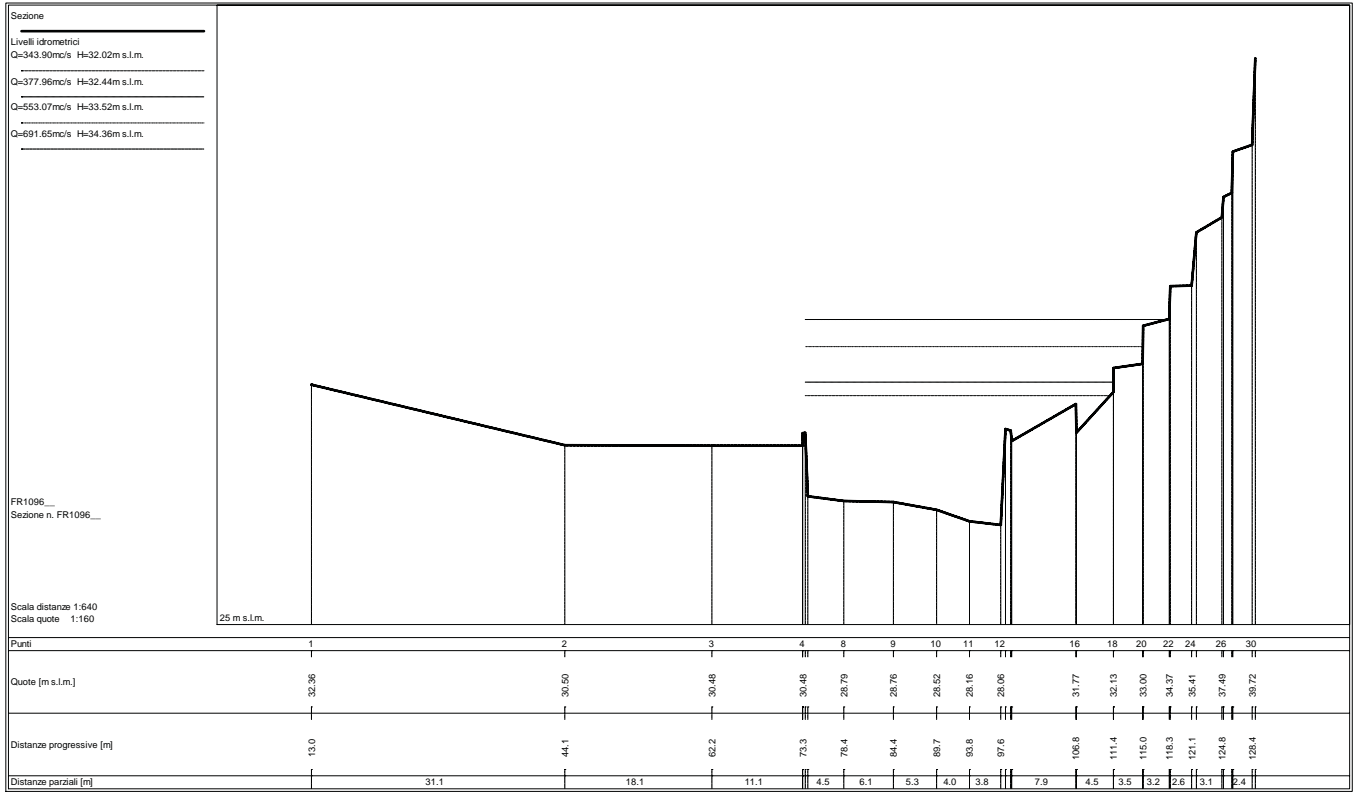

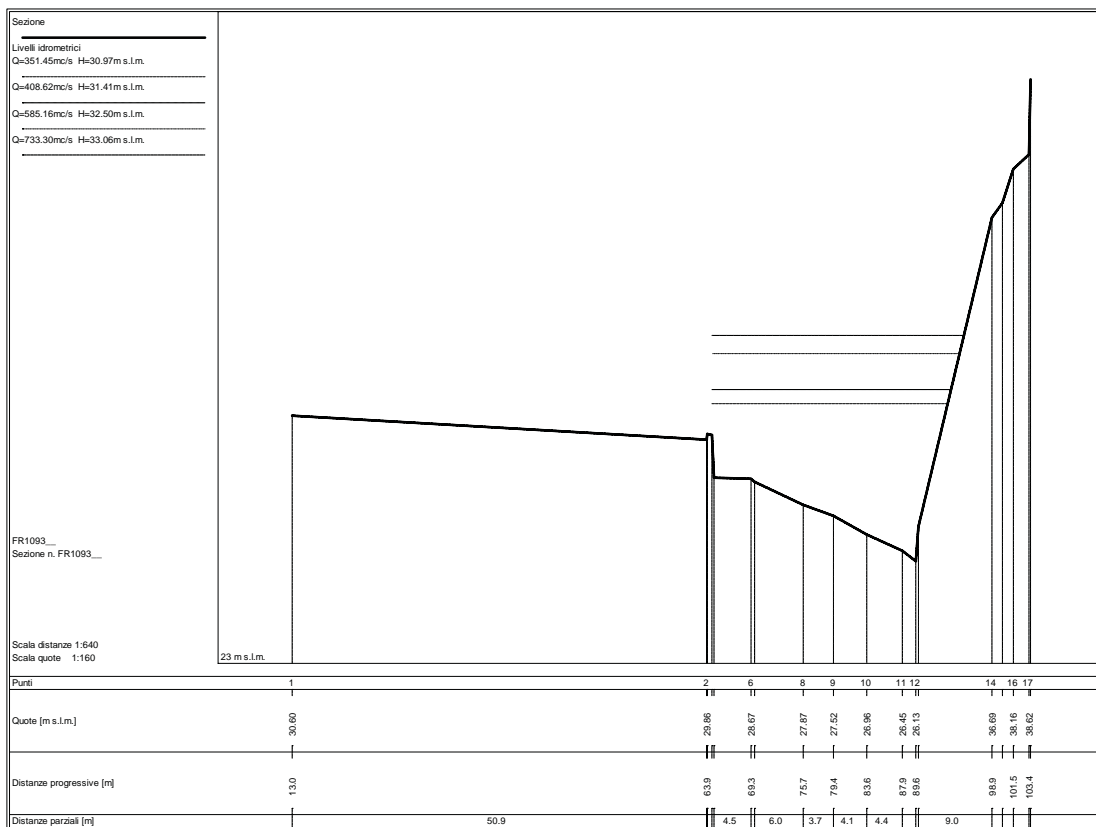
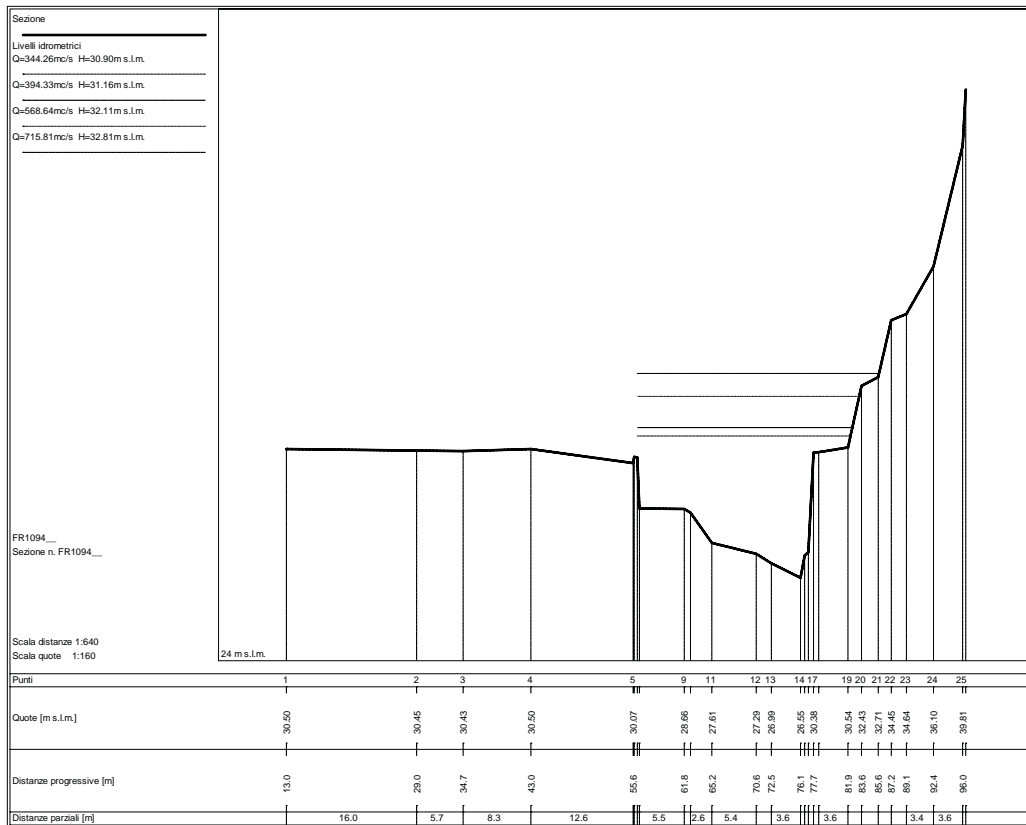

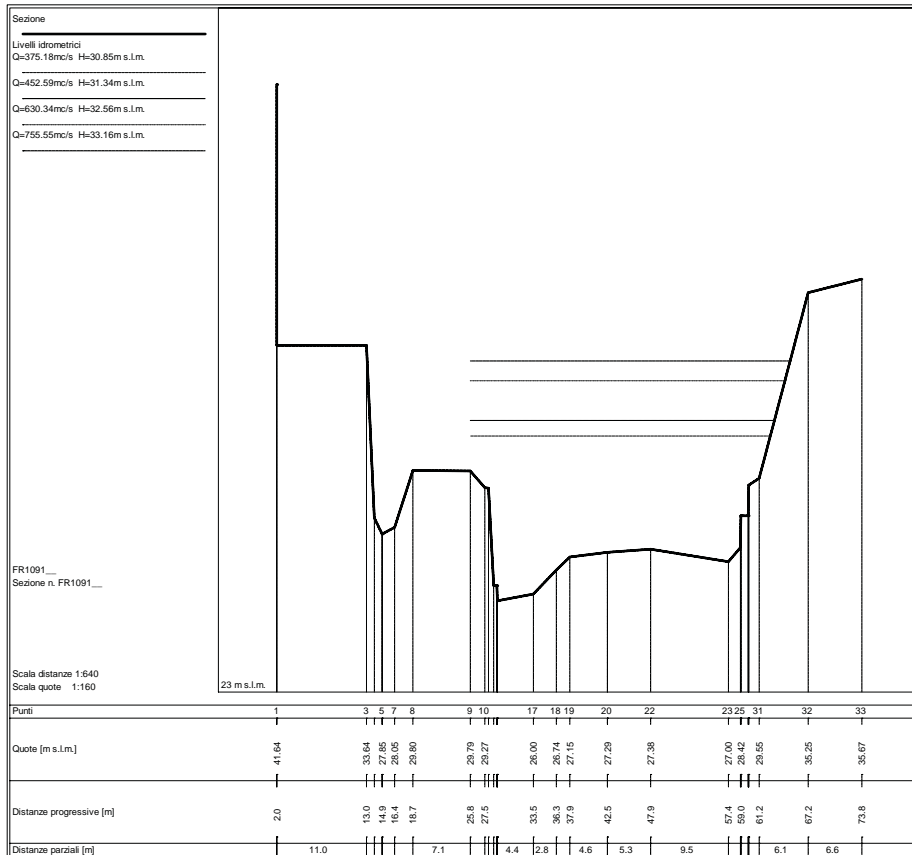
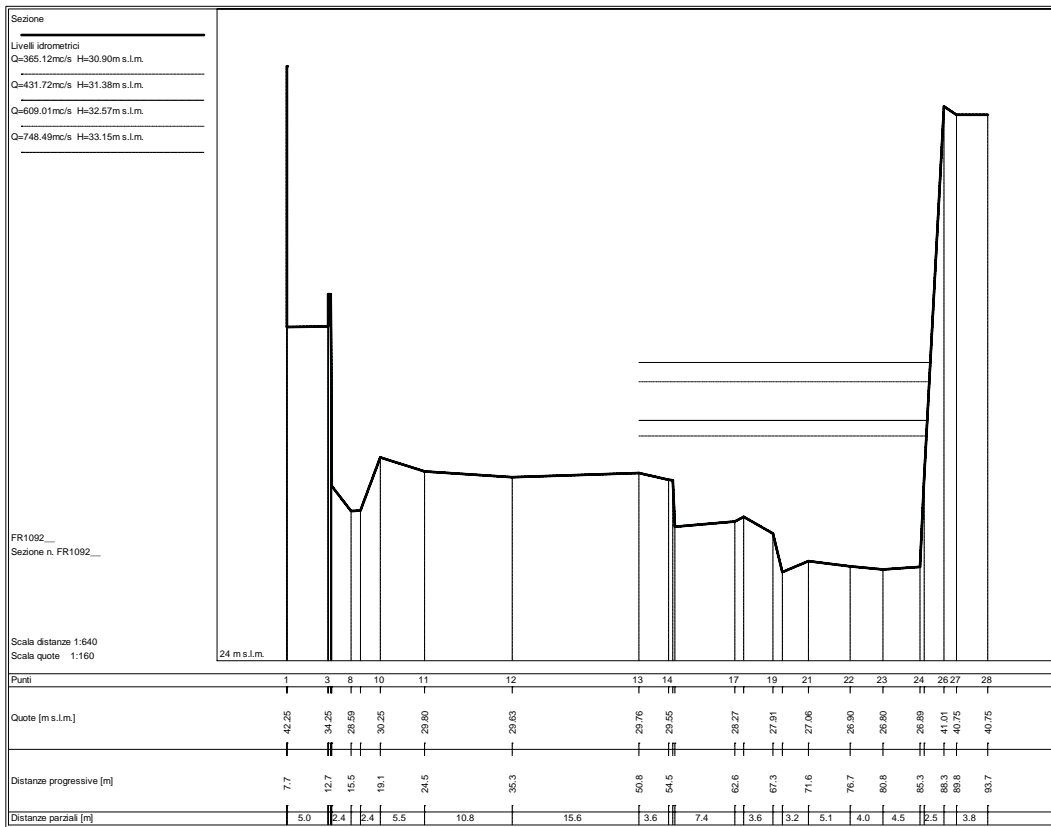

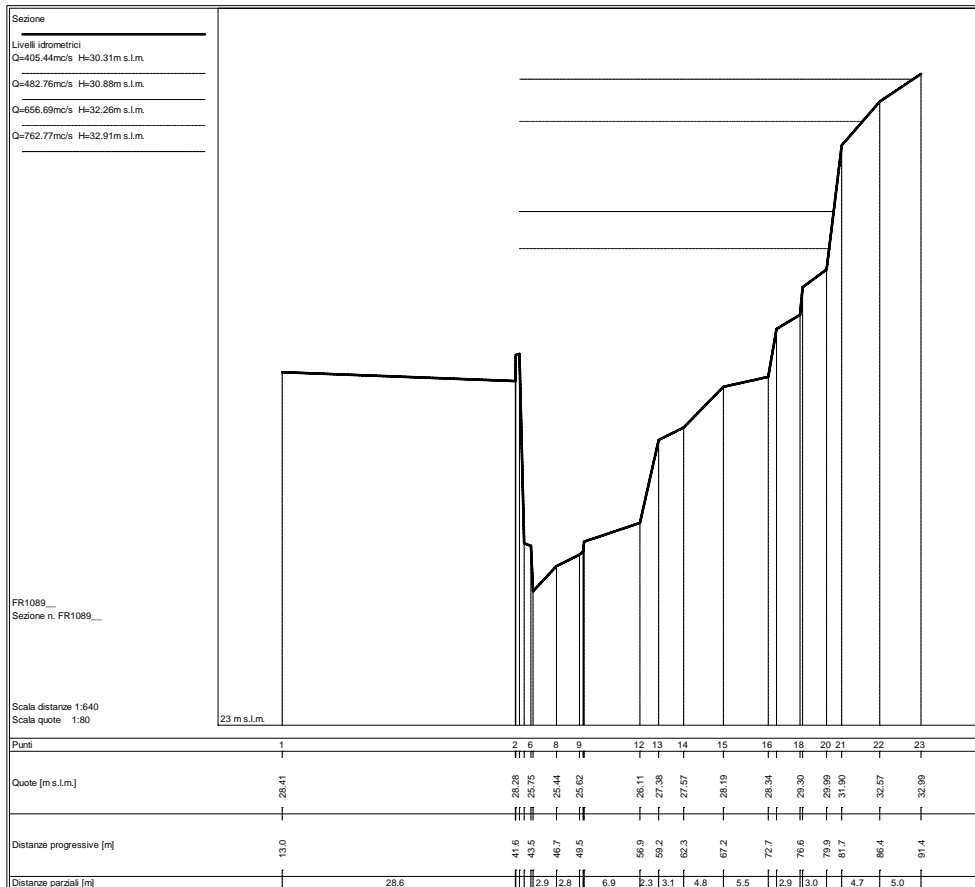
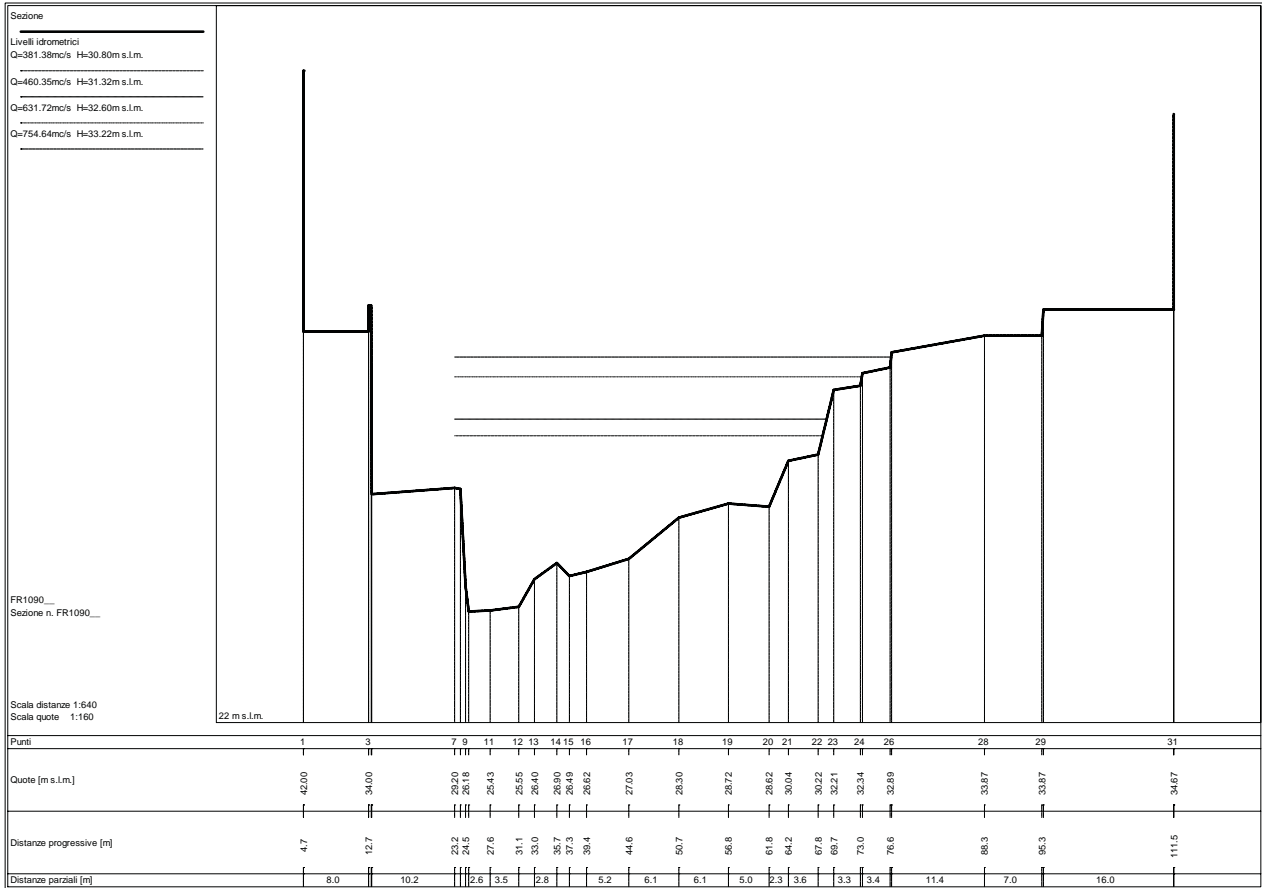

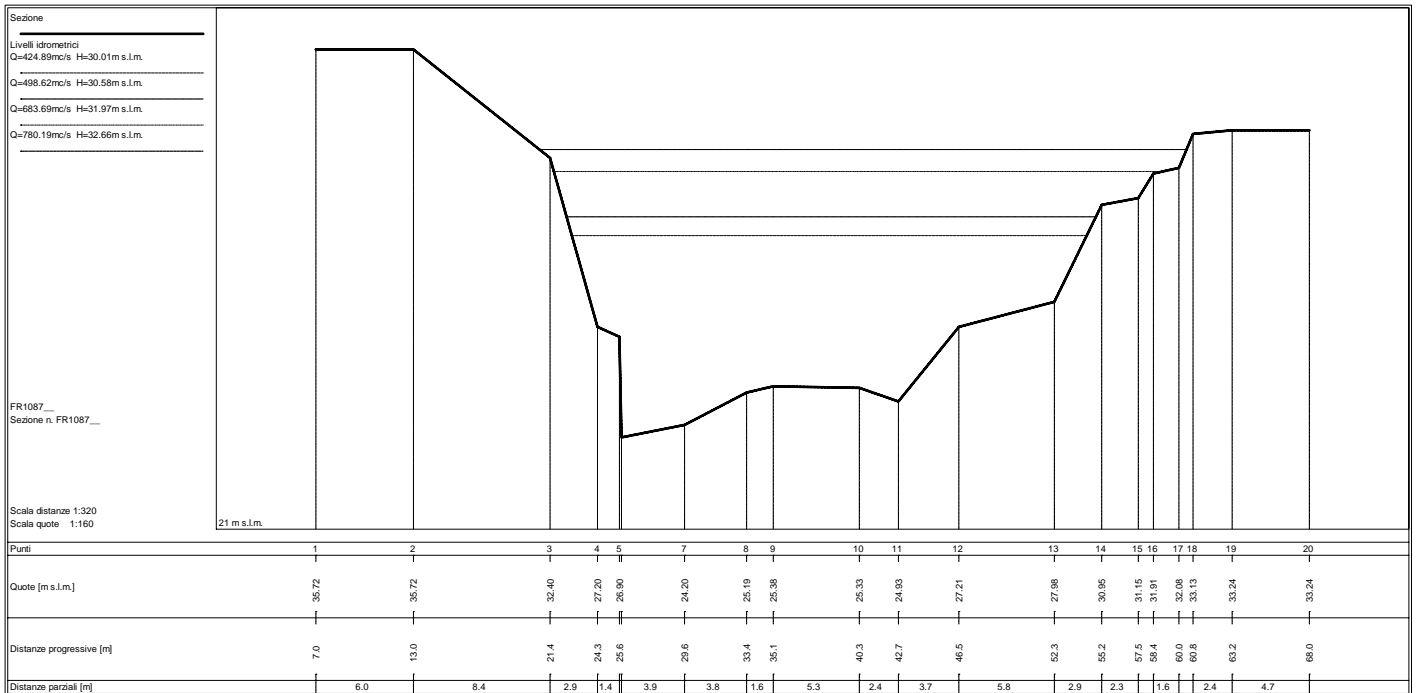
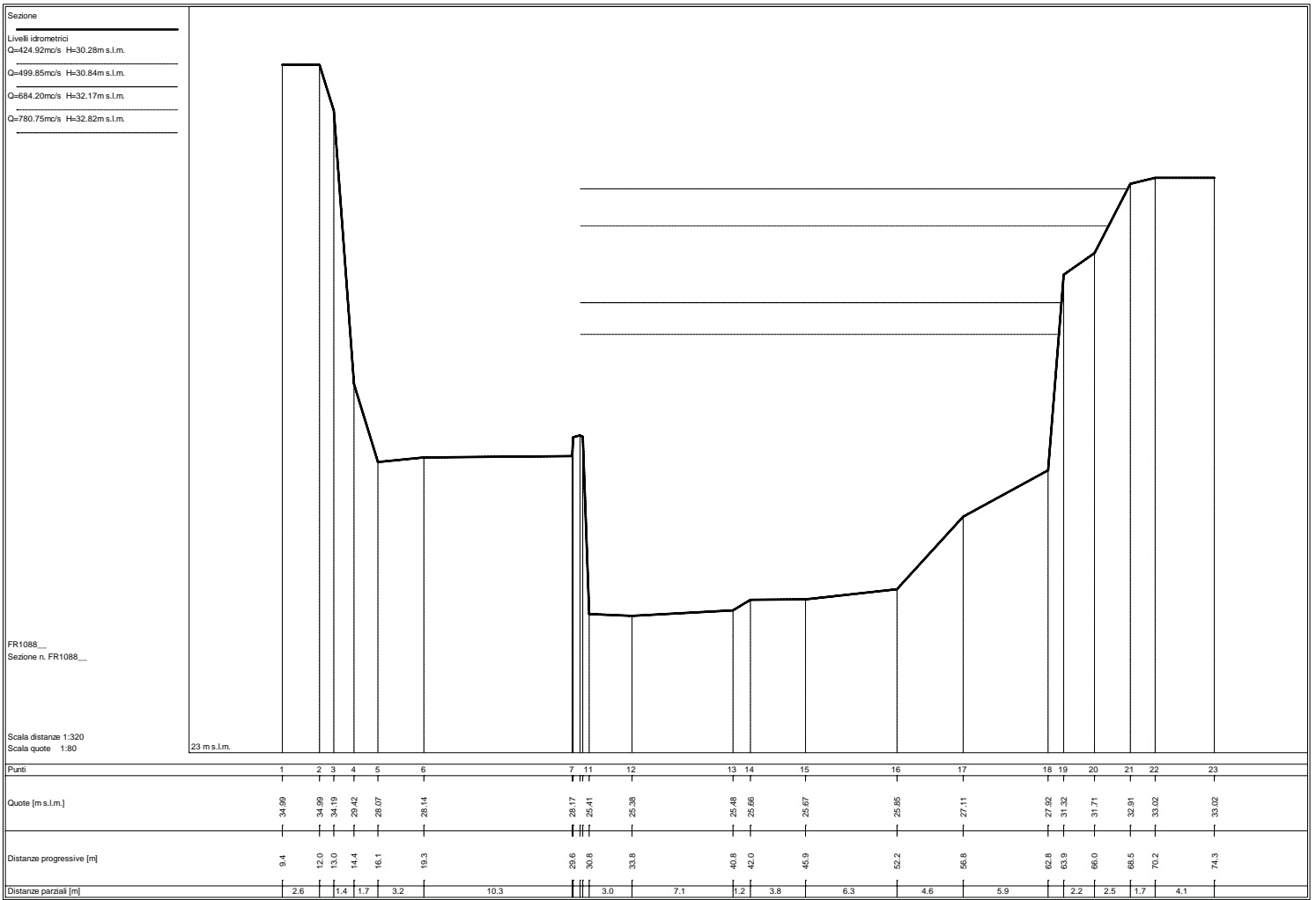

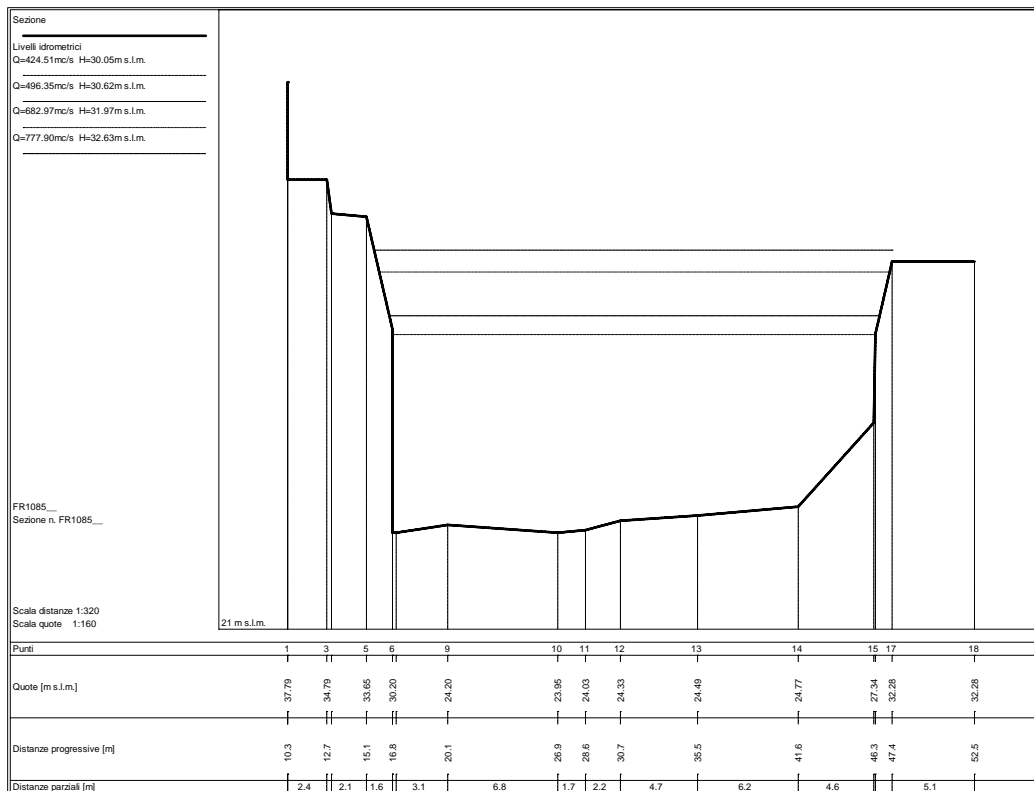
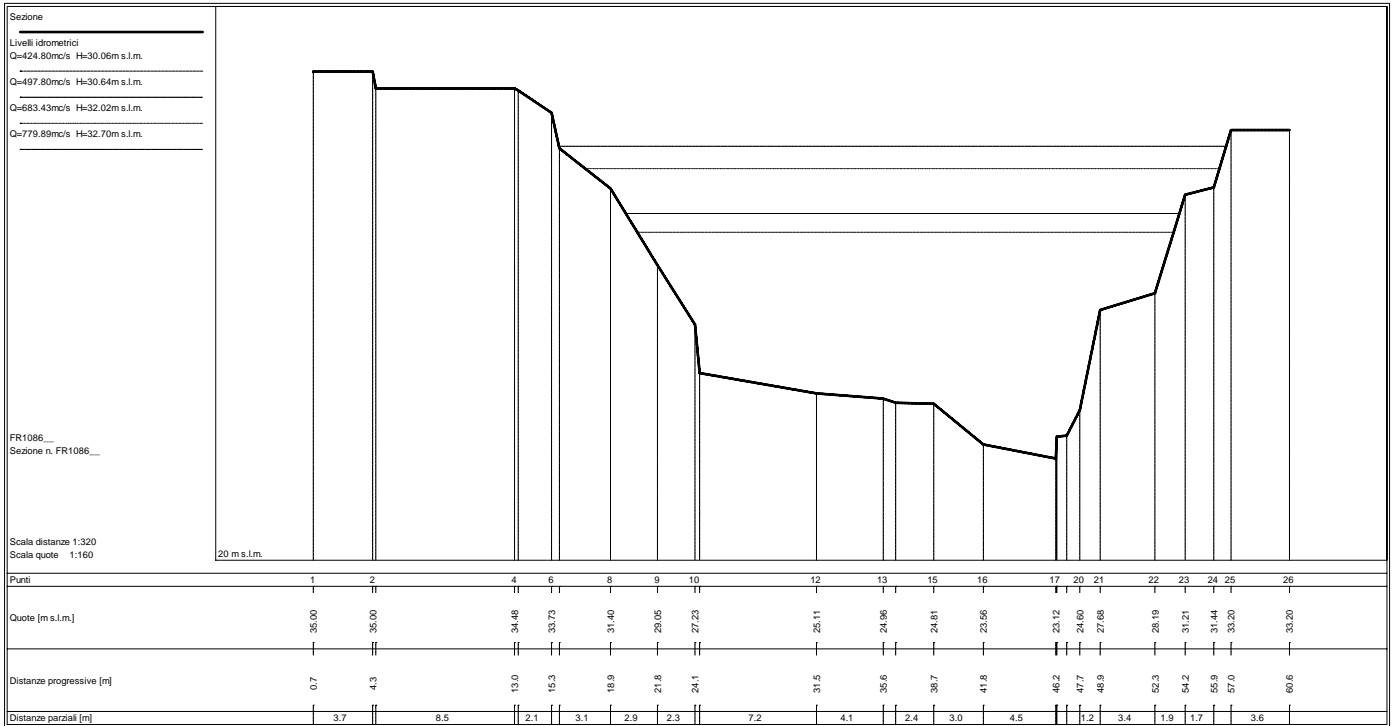

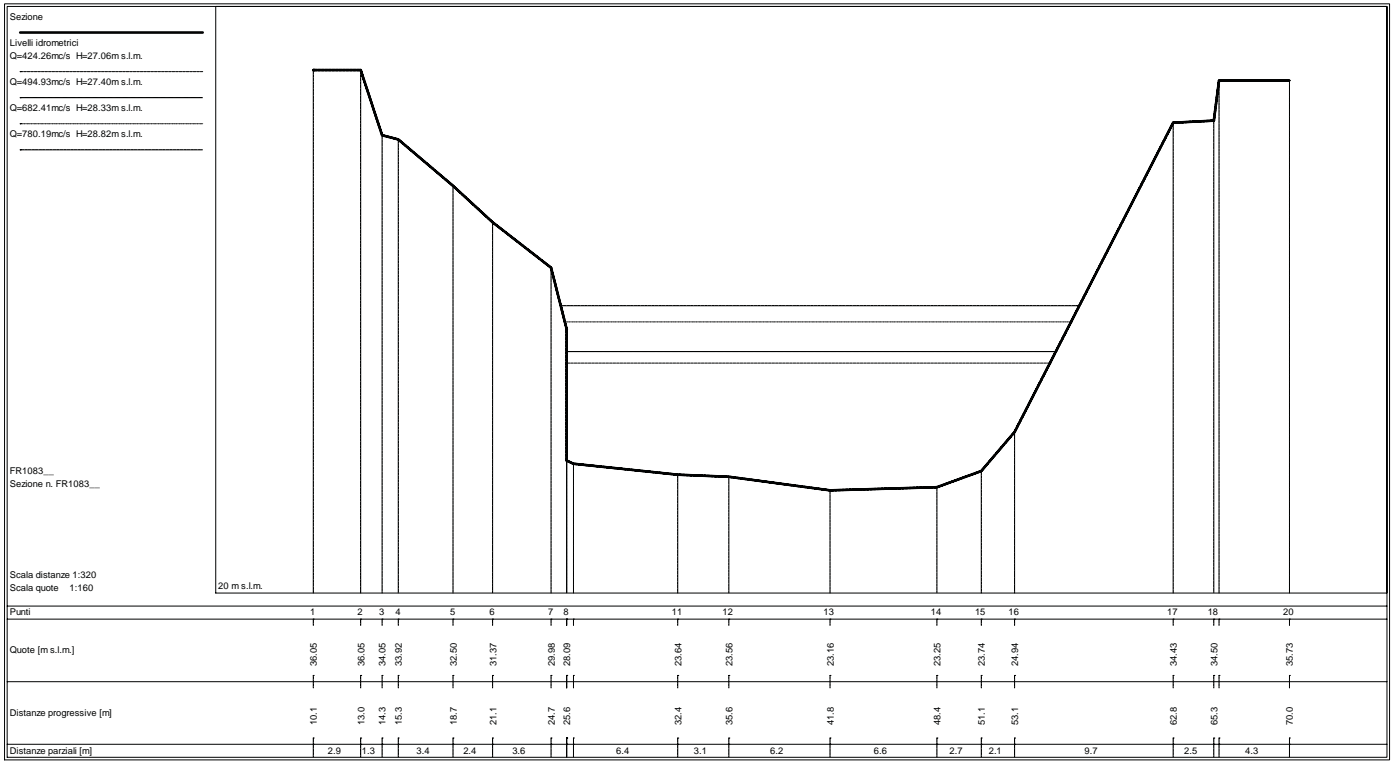
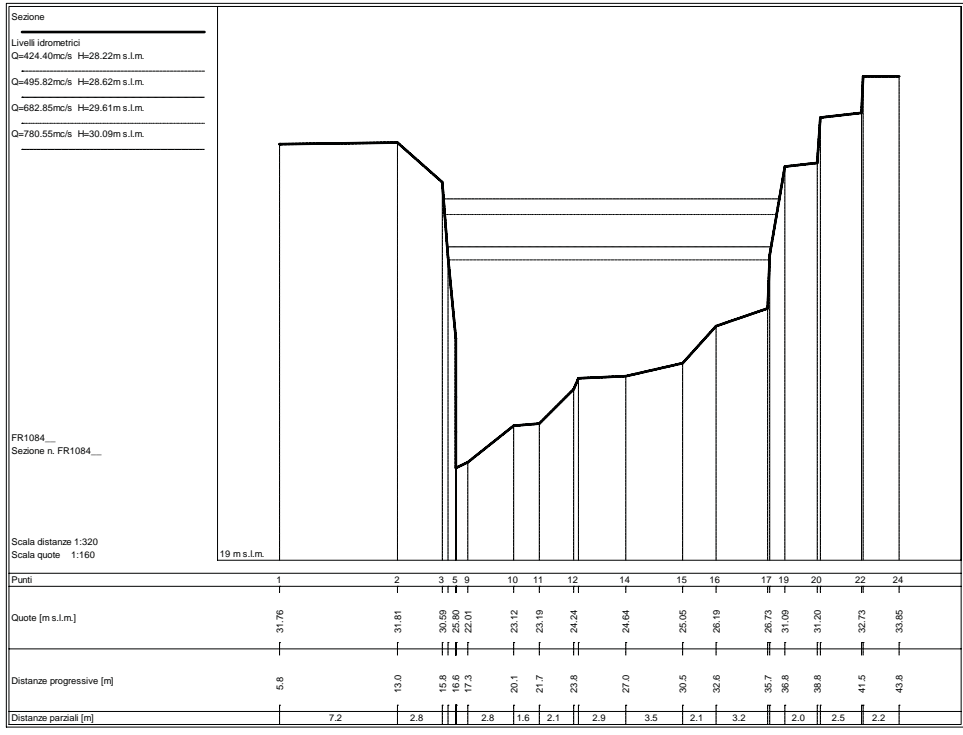

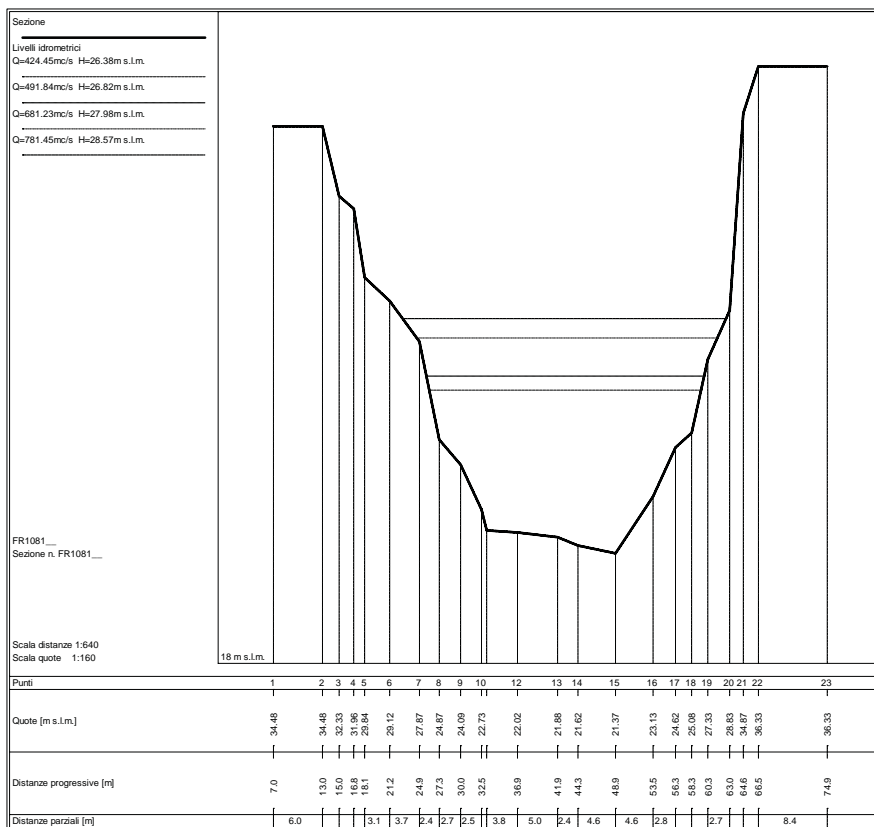
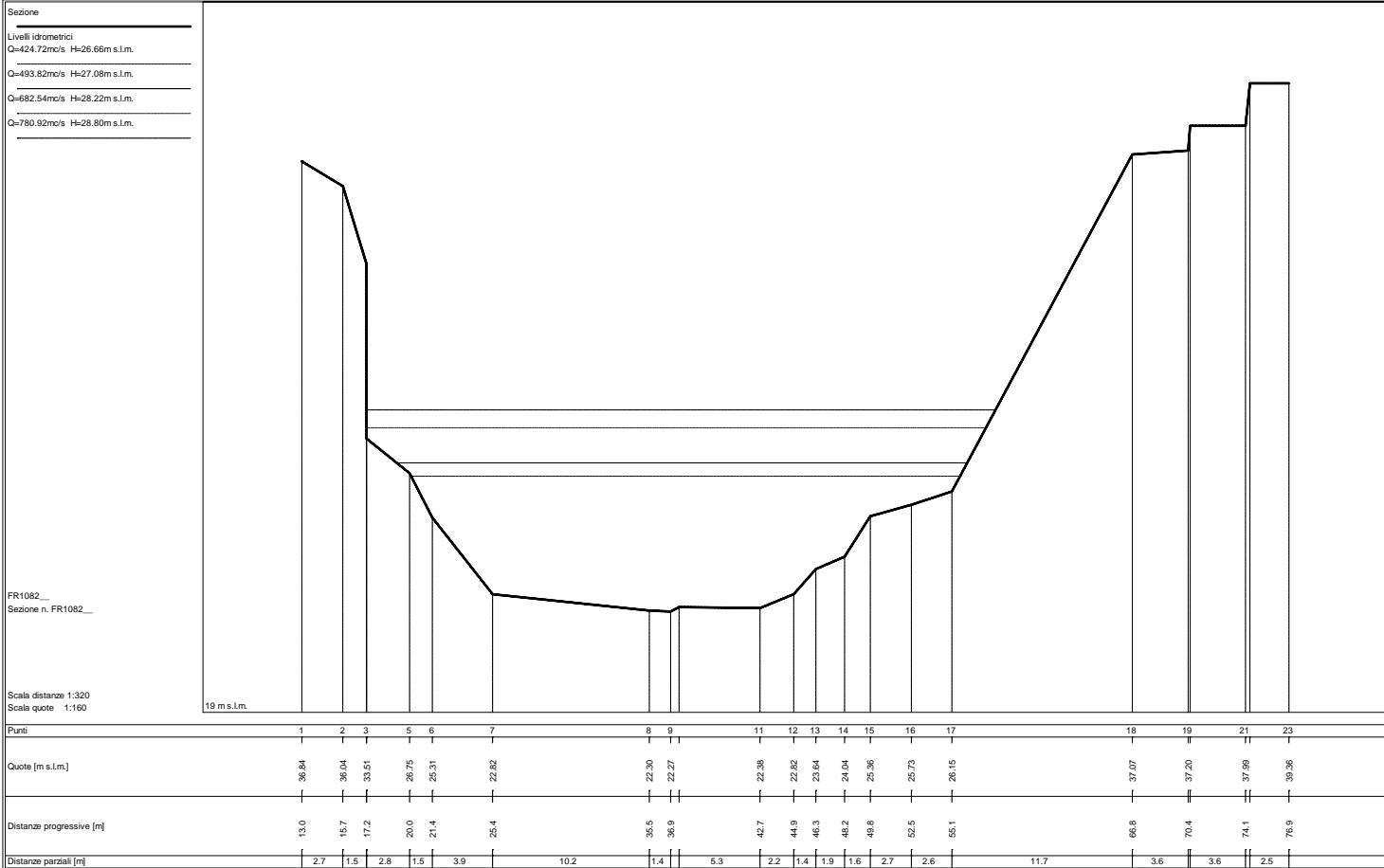

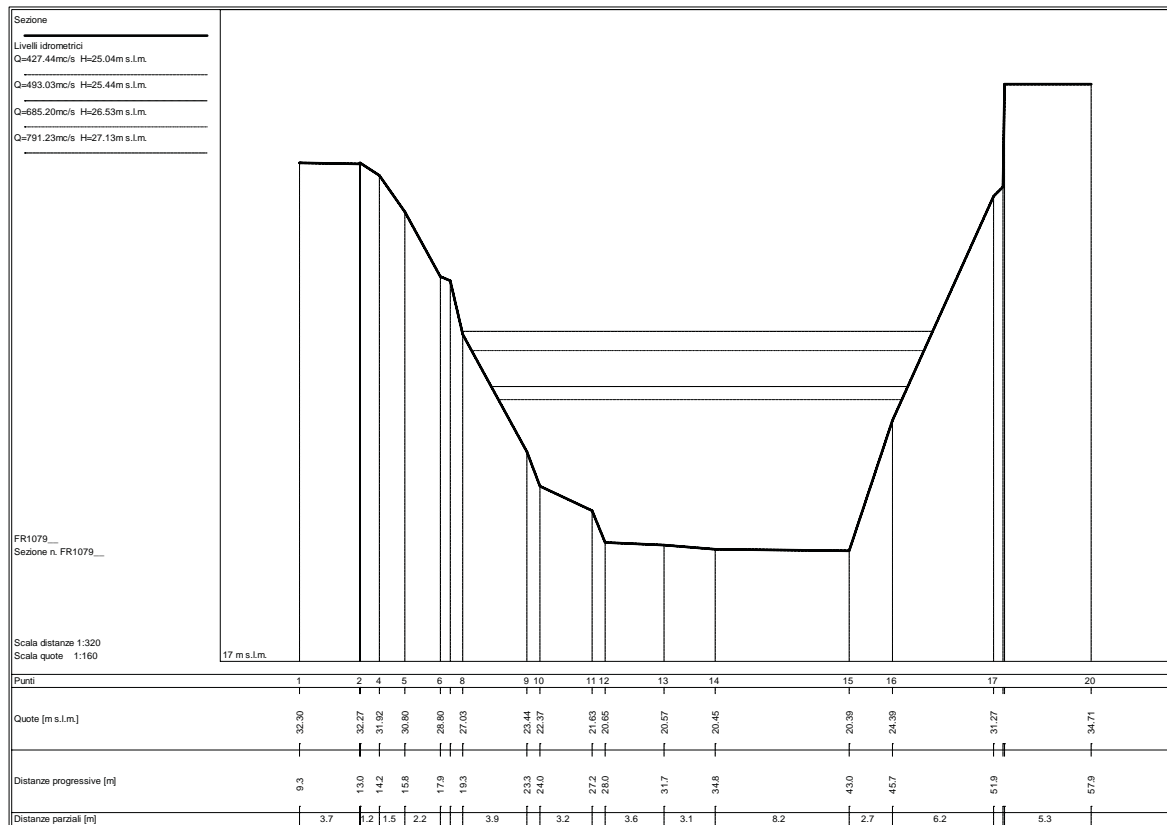
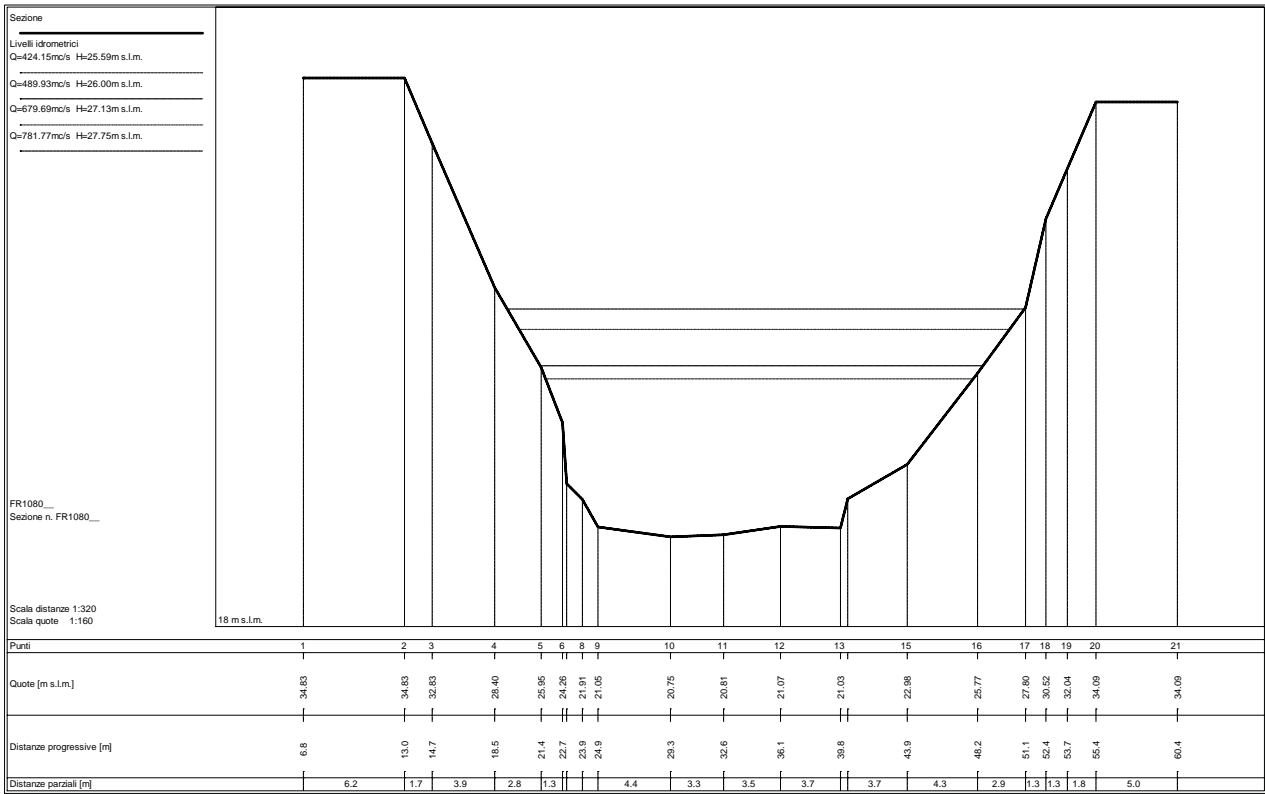

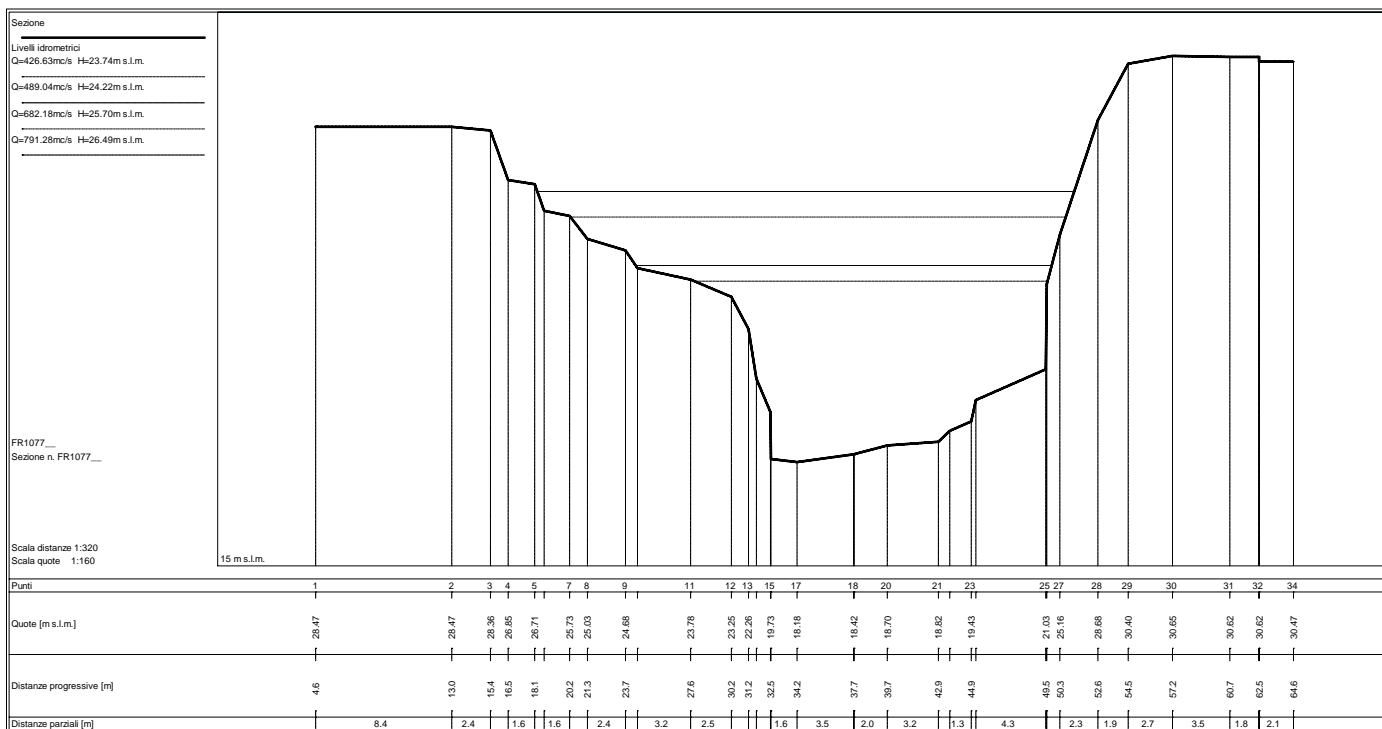
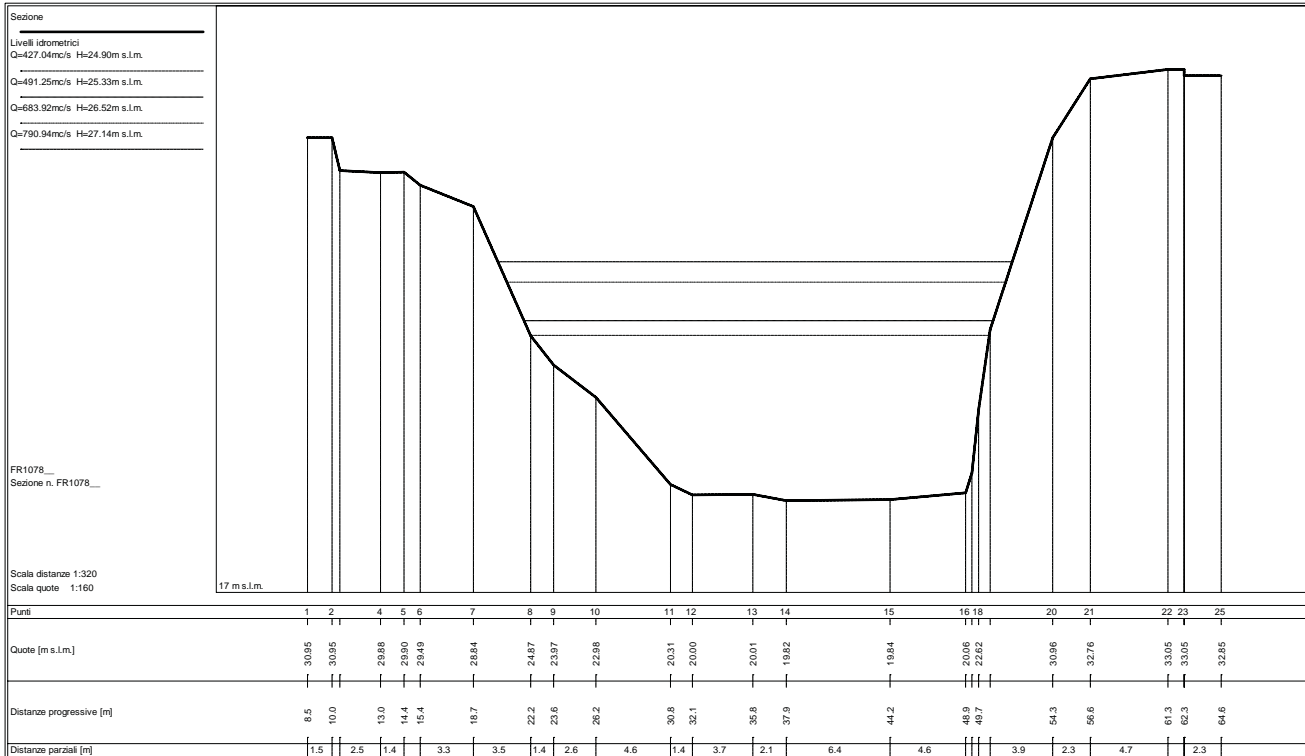

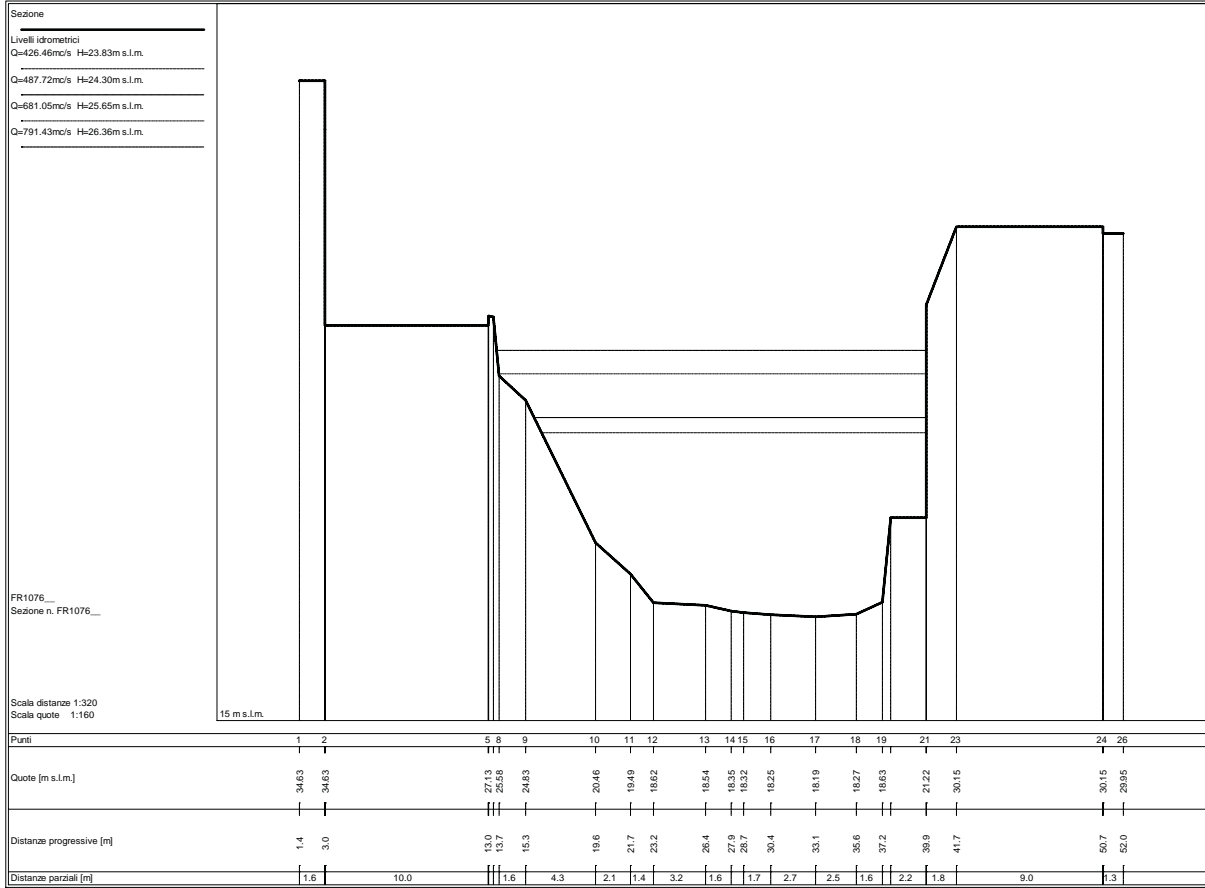

STATO ATTUALE

Sezioni fluviali fiume Frigido – FR_05

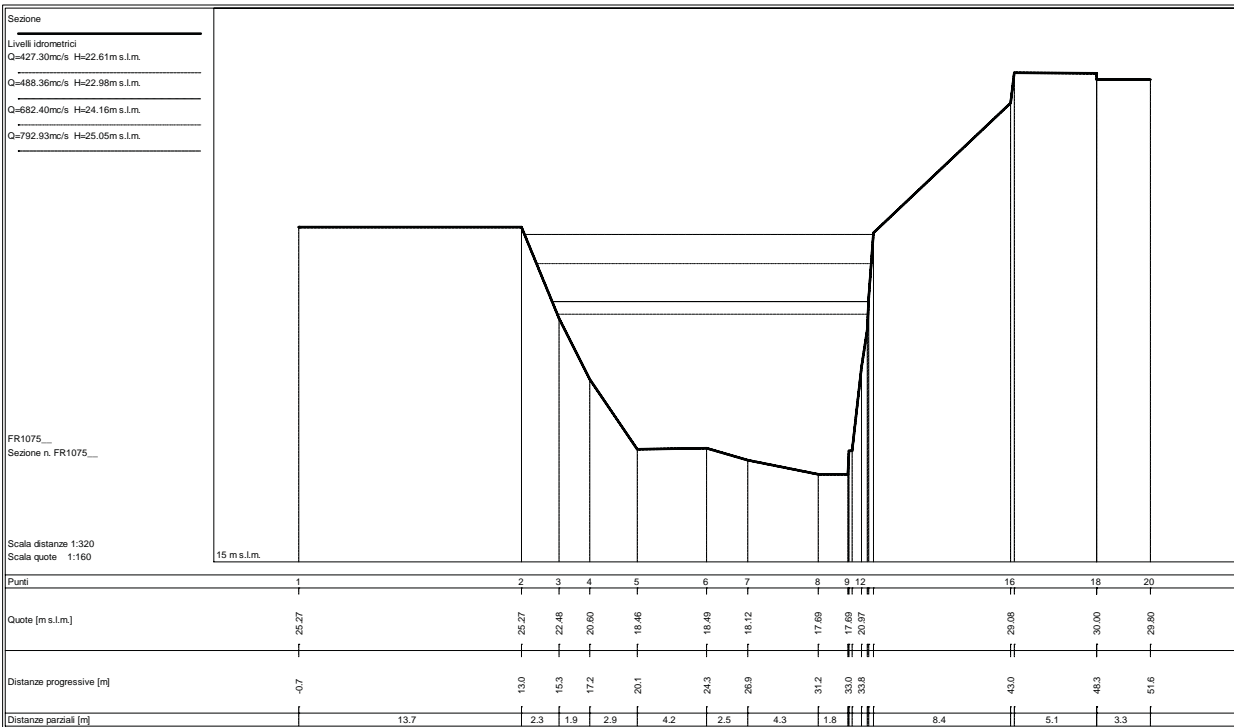
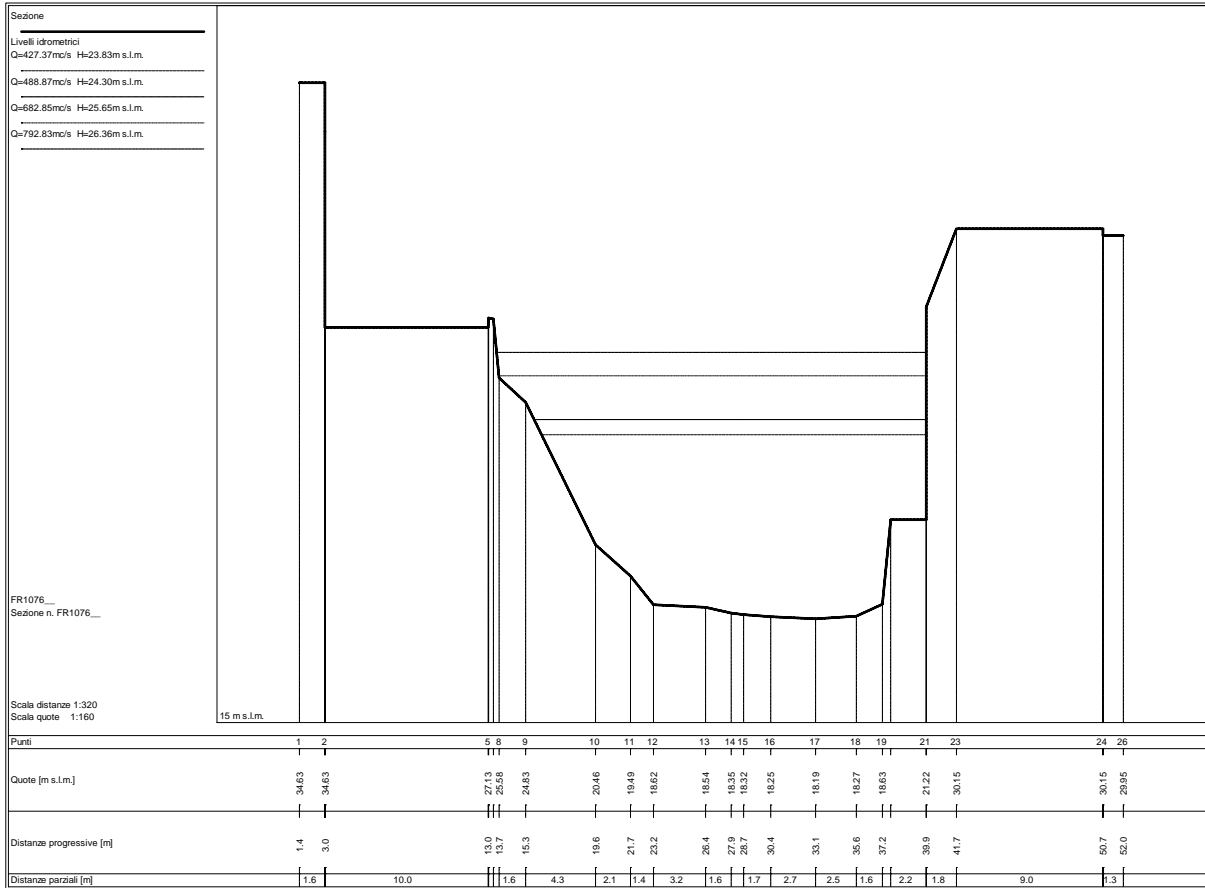

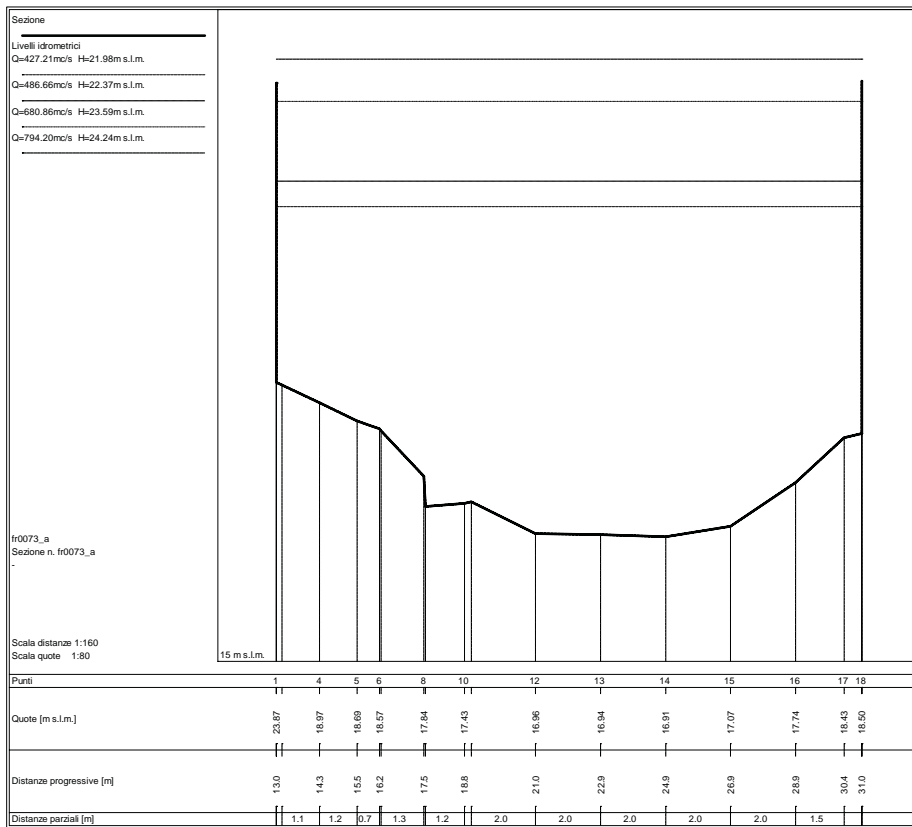
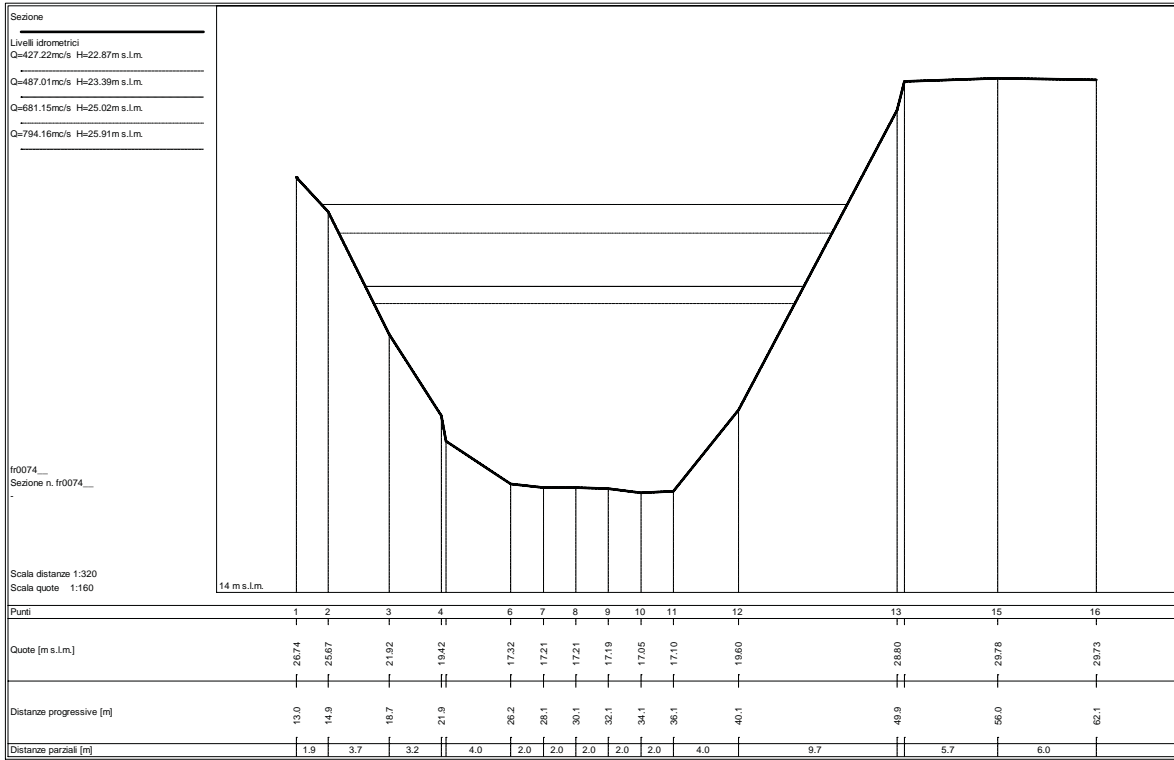

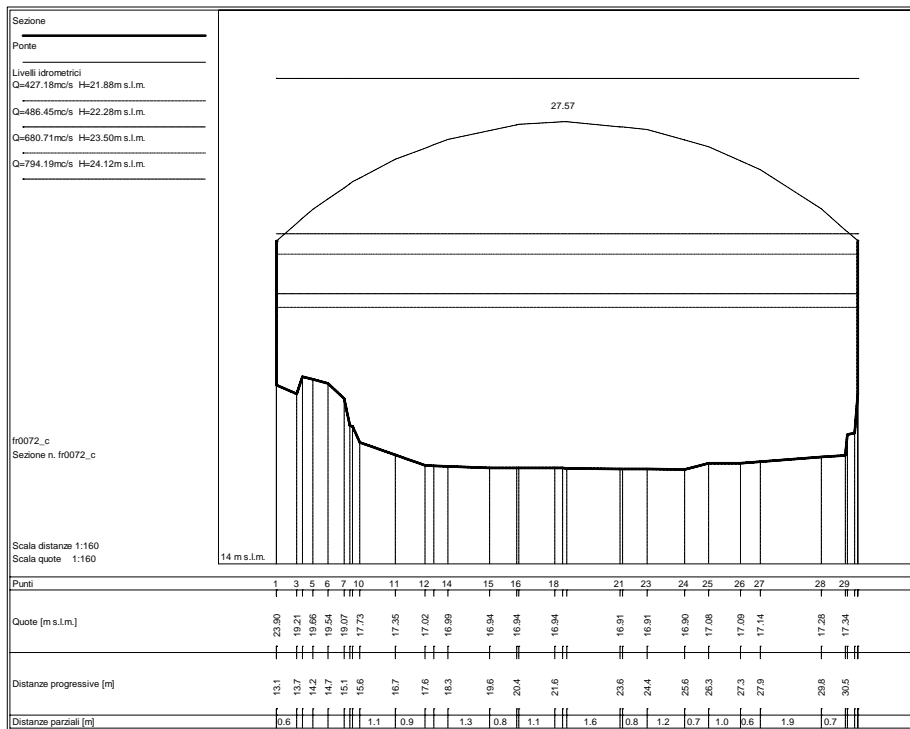
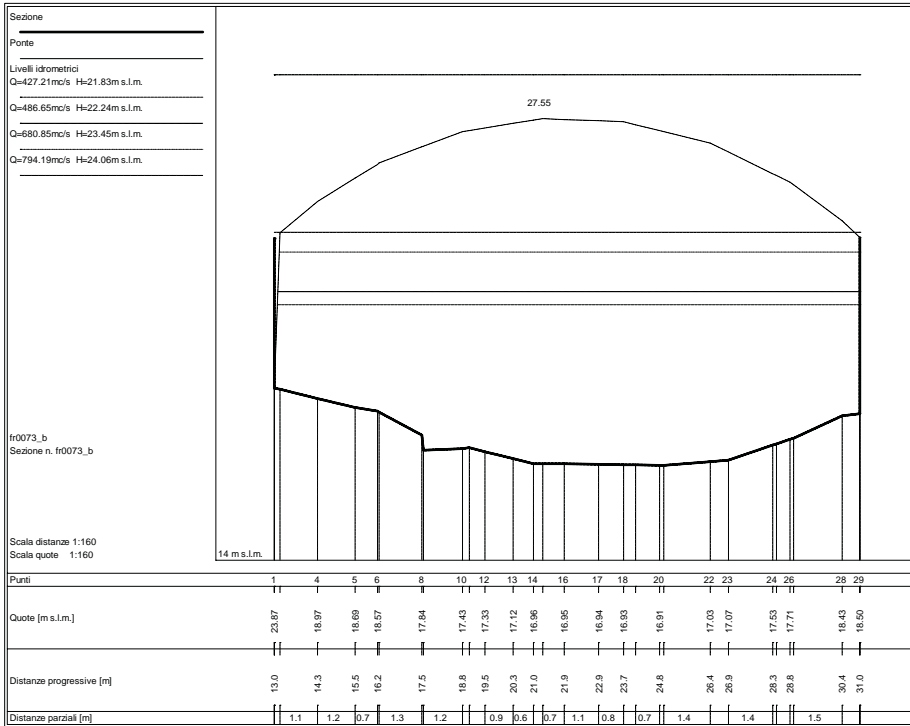

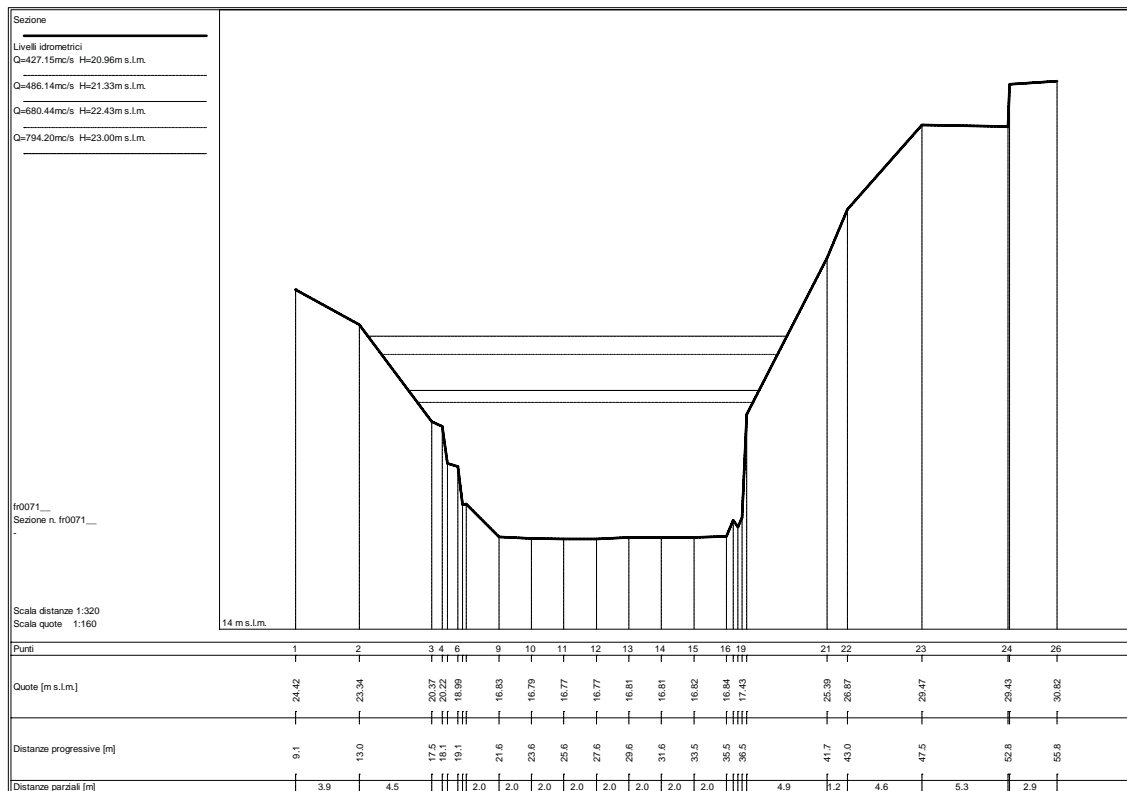
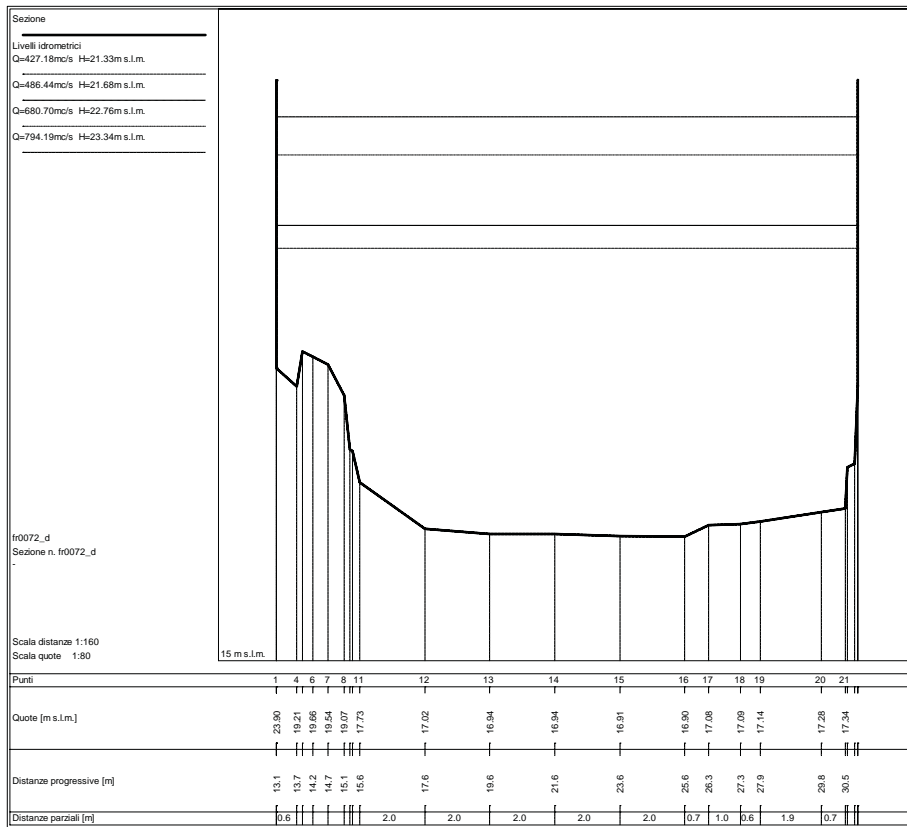

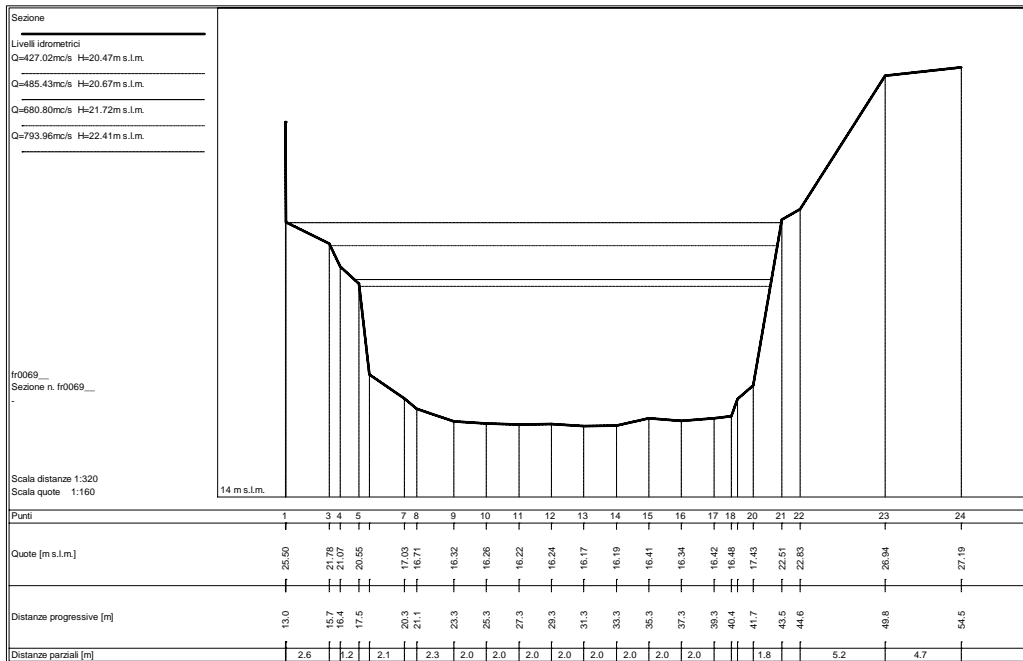
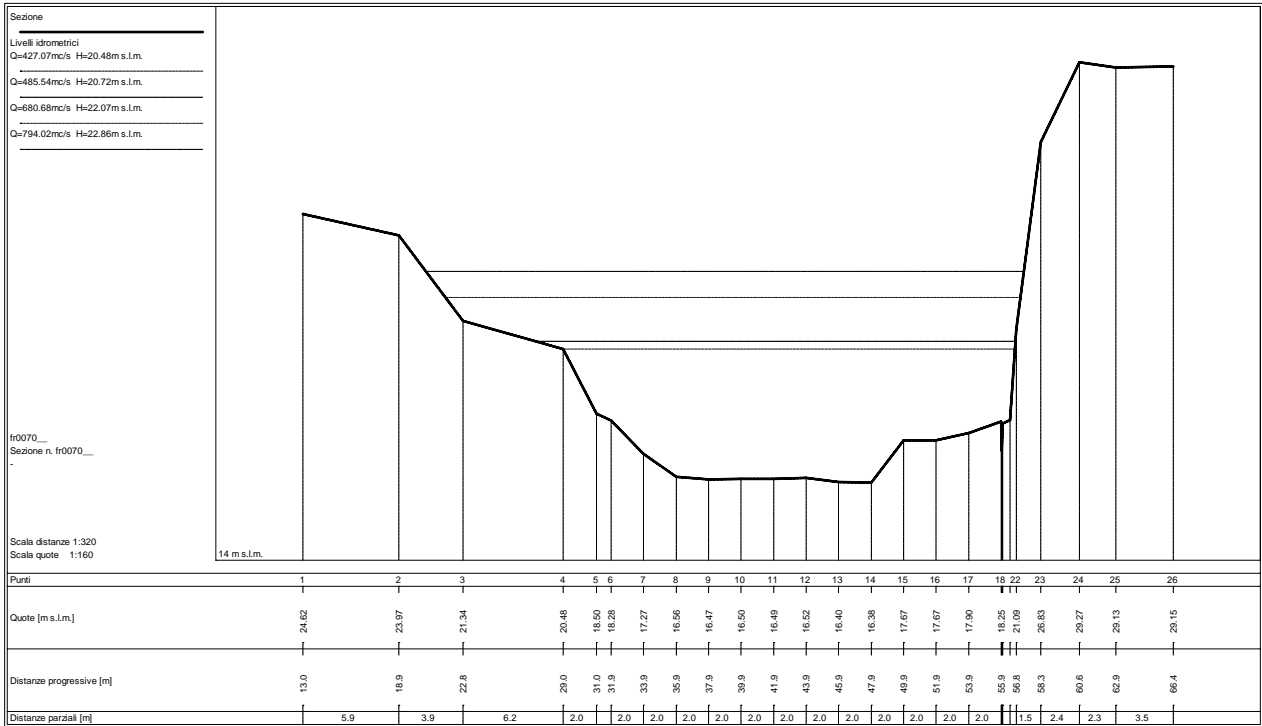

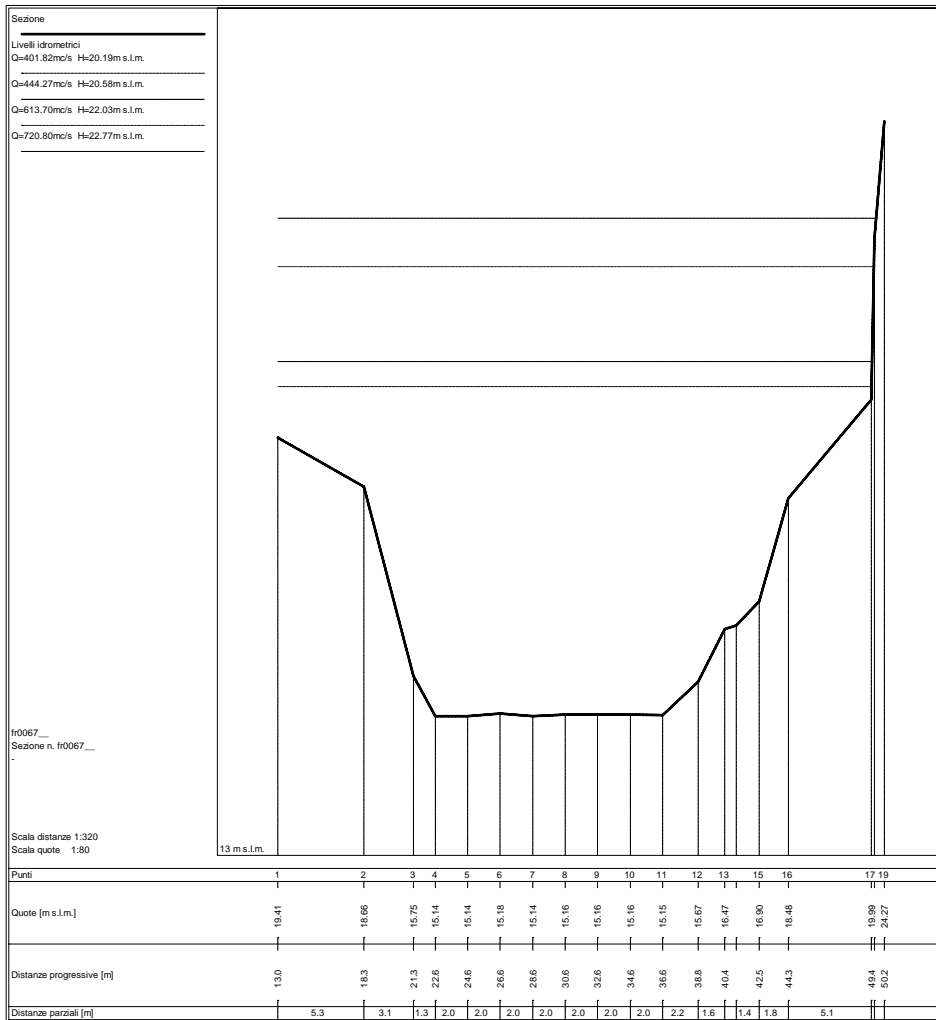
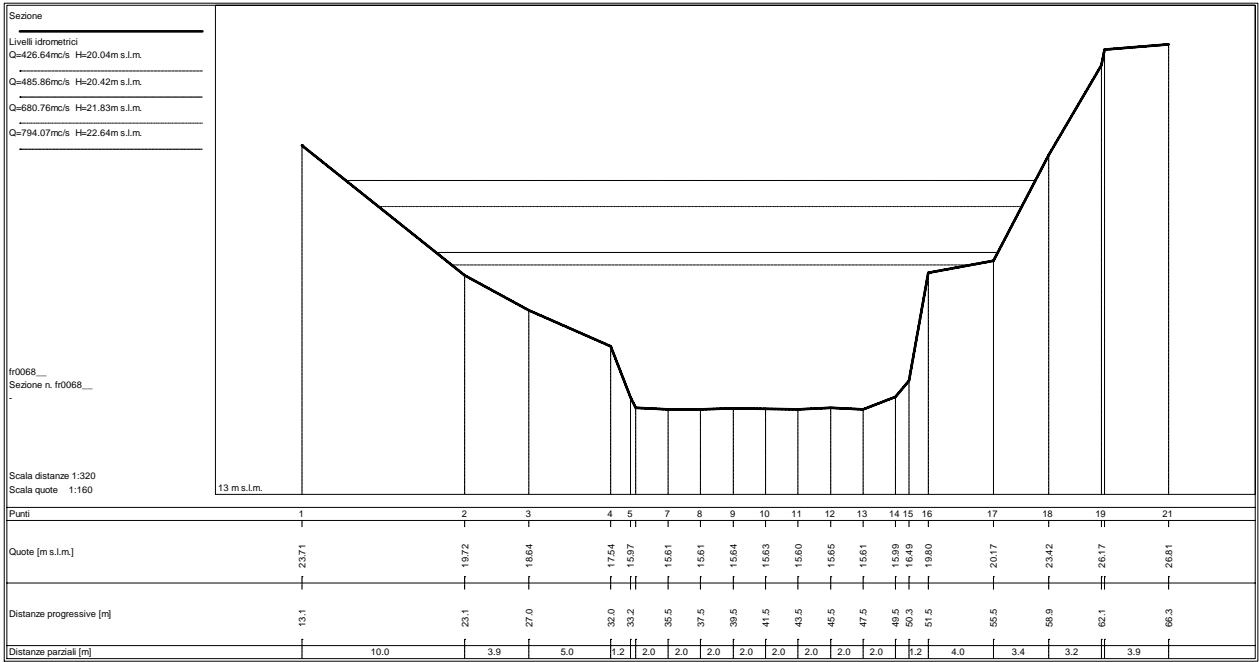

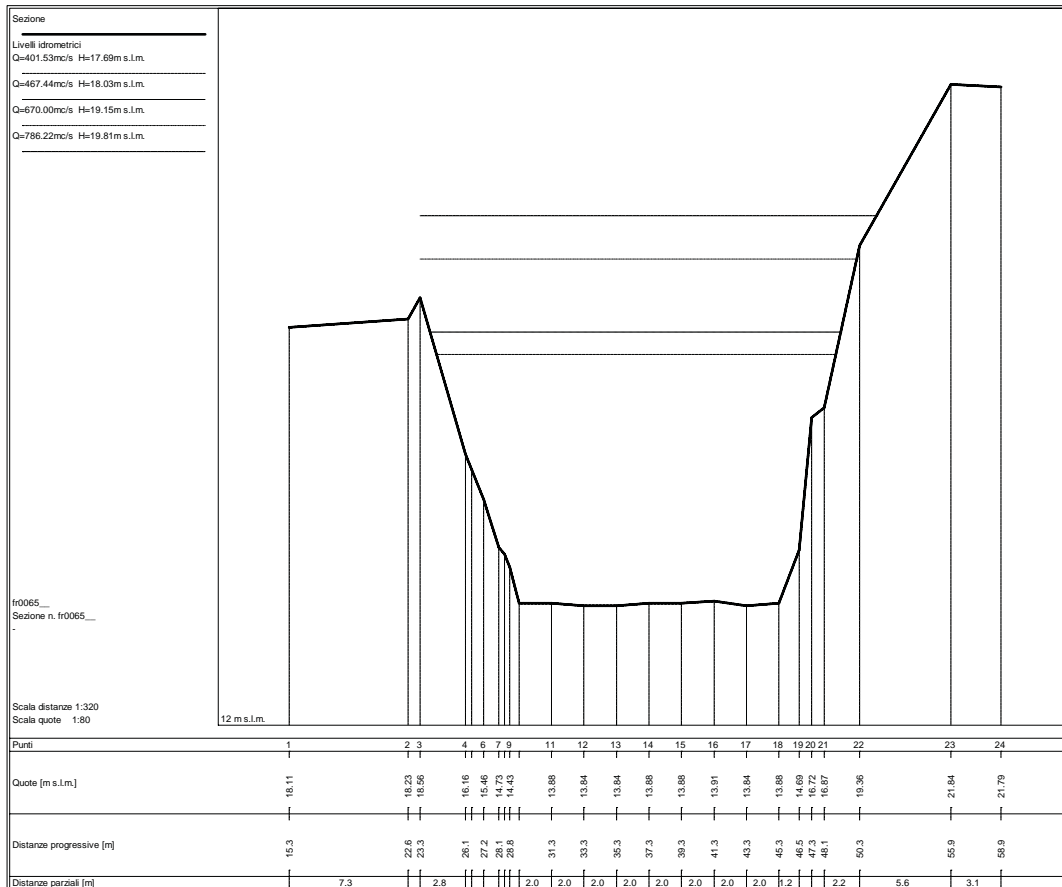
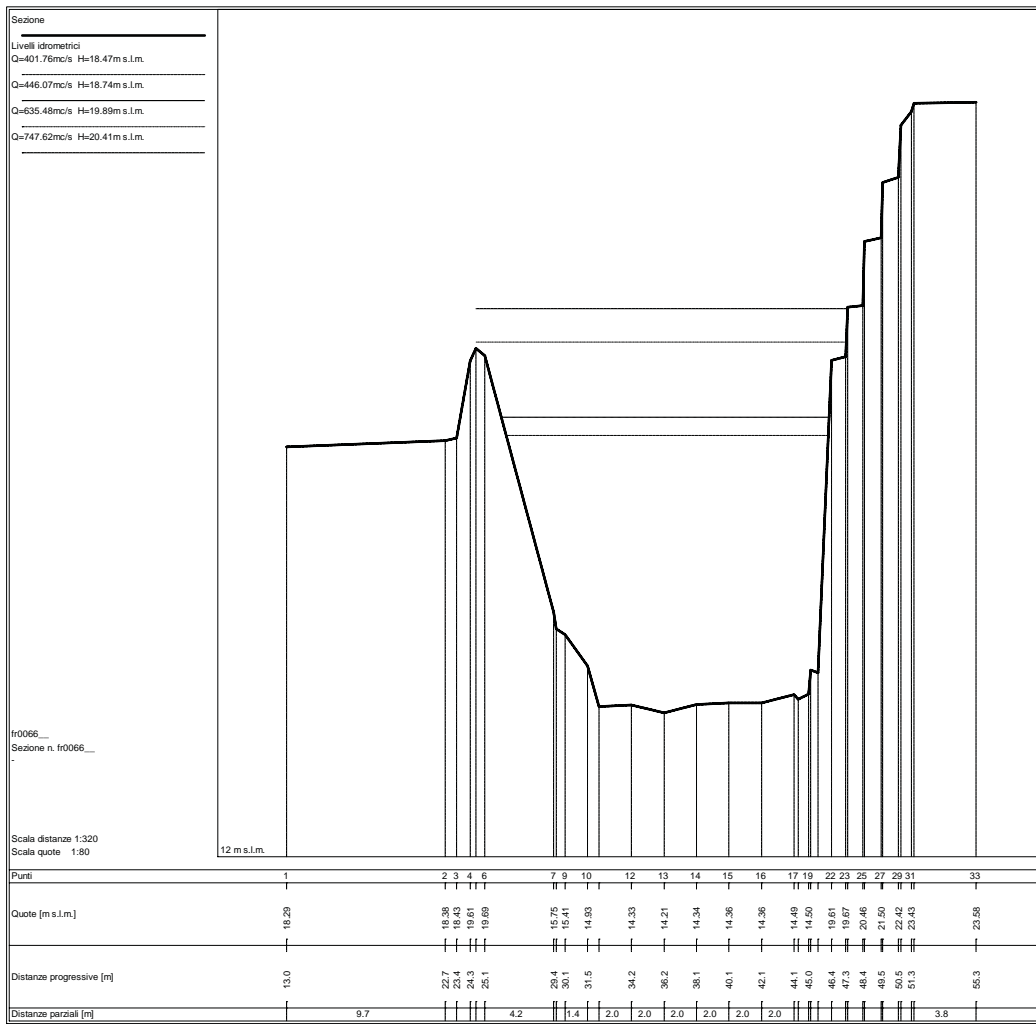

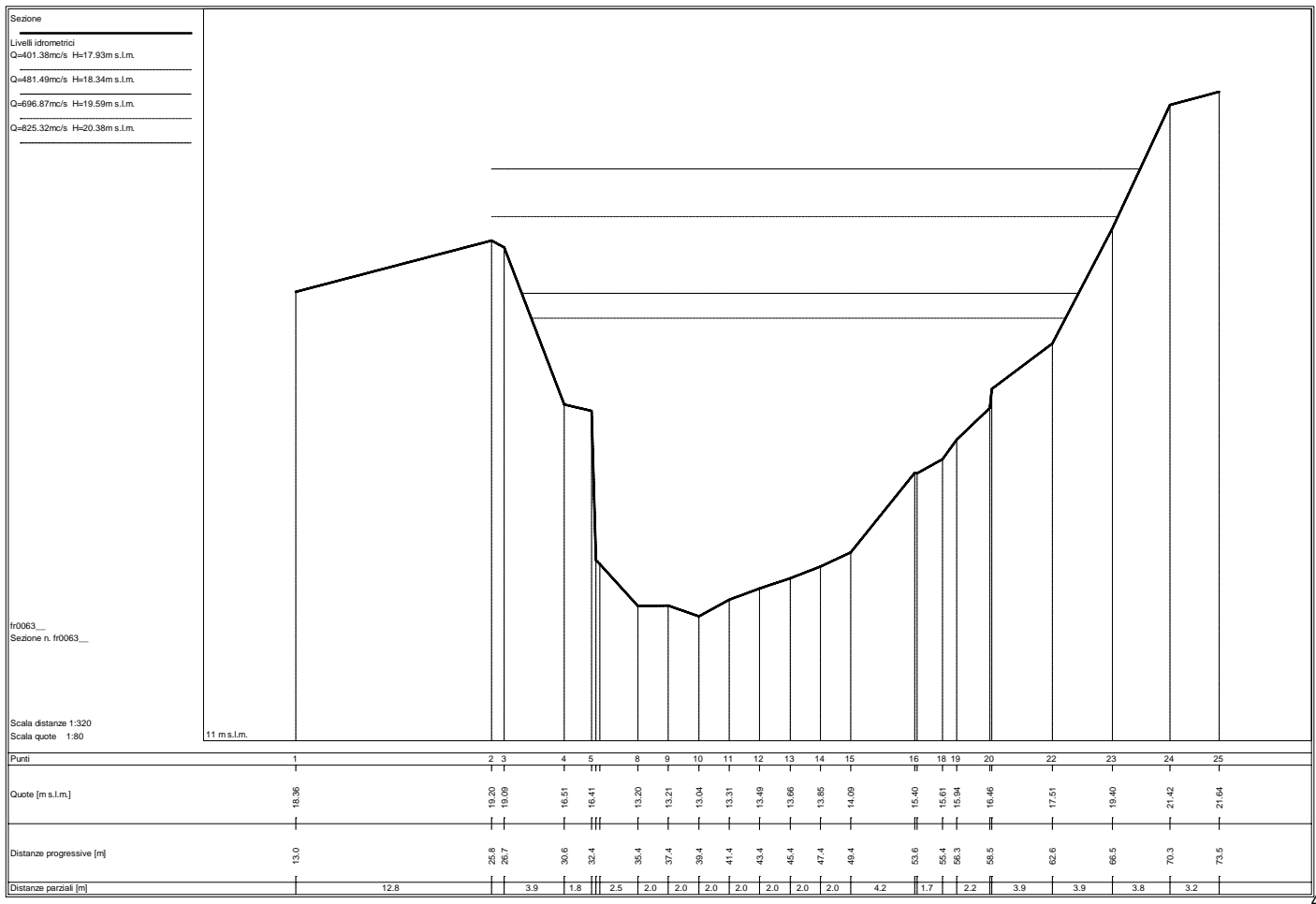
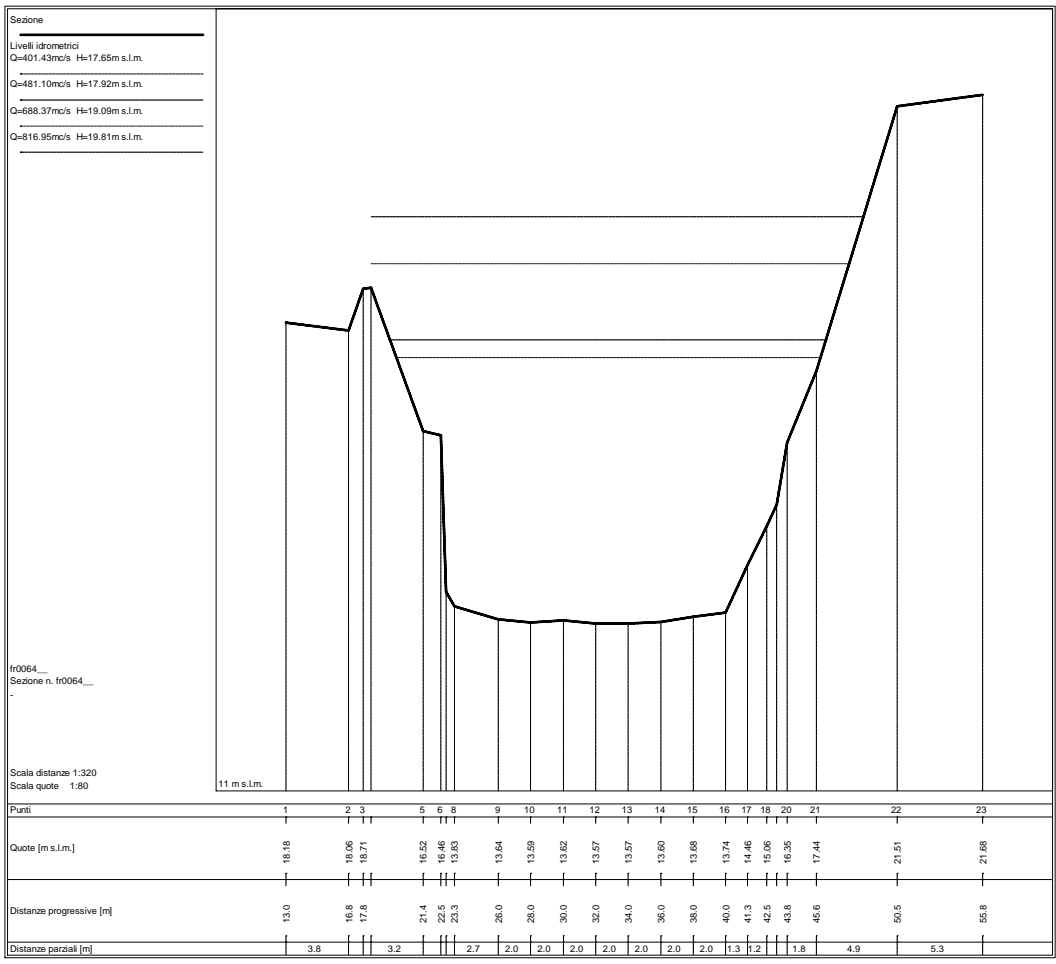

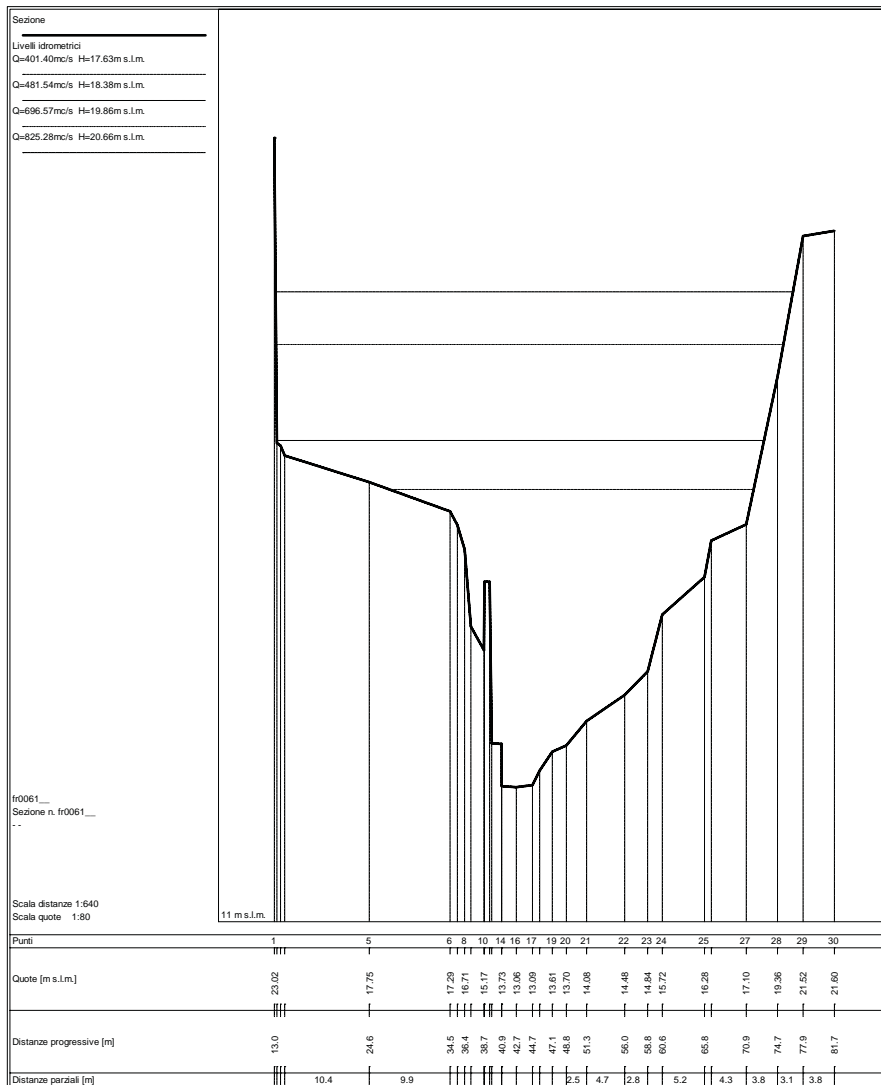
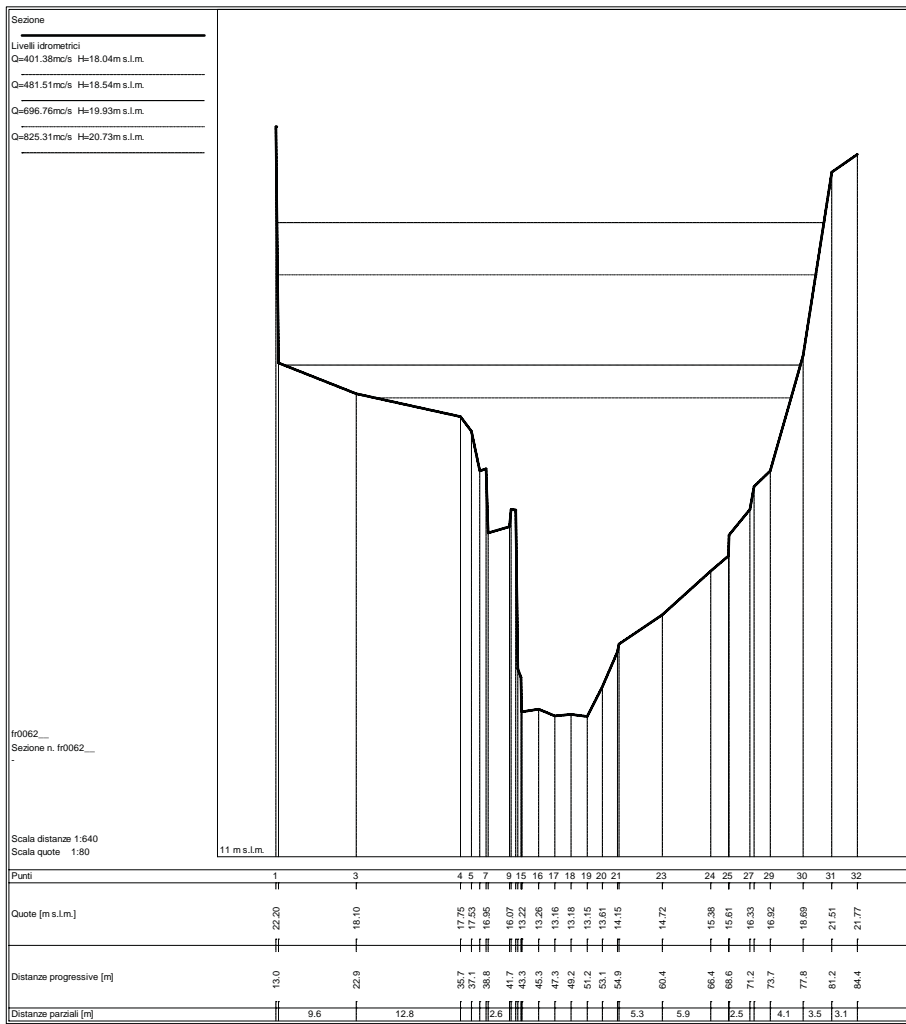

Sezione
 Livelli idrometrici
 Q=401,26mc/s H=17,94m s.l.m.
 Q=481,59mc/s H=18,51m s.l.m.
 Q=695,93mc/s H=19,82m s.l.m.
 Q=825,16mc/s H=20,59m s.l.m.

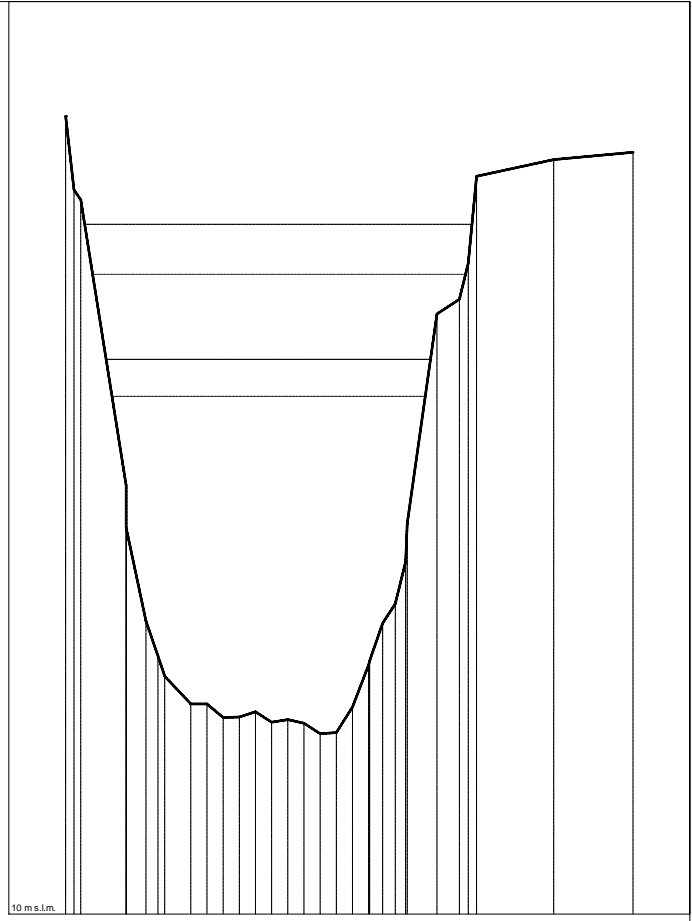

fr0060
 Sezione n. fr0060

Scala distanze 1:640
 Scala quote 1:80

Punti	1	3	4	6	7	9	10	11	12	13	14	15	16	17	18	19	20	22	23	26	27	29	30	31		
Quote [m s.l.m.]	22,24	20,96	16,57	14,59	13,96	13,23	13,23	13,62	13,65	13,93	13,11	12,85	12,89	12,85	12,77	12,79	13,18	13,83	14,05	14,76	19,21	19,43	21,32	21,58	21,69	
Distanze progressive [m]	-0,4	1,5	7,1	9,5	11,0	15,0	17,0	19,0	20,9	22,9	24,9	26,9	28,9	30,9	32,8	34,8	36,8	38,8	40,8	40,1	45,2	48,0	50,1	59,5	69,3	
Distanze parziali [m]		5,6	2,4		3,2																3,6	2,8		9,5	9,8	

Sezione
 Livelli idrometrici
 Q=401,03mc/s H=17,73m s.l.m.
 Q=481,74mc/s H=18,24m s.l.m.
 Q=695,36mc/s H=19,42m s.l.m.
 Q=825,12mc/s H=20,11m s.l.m.

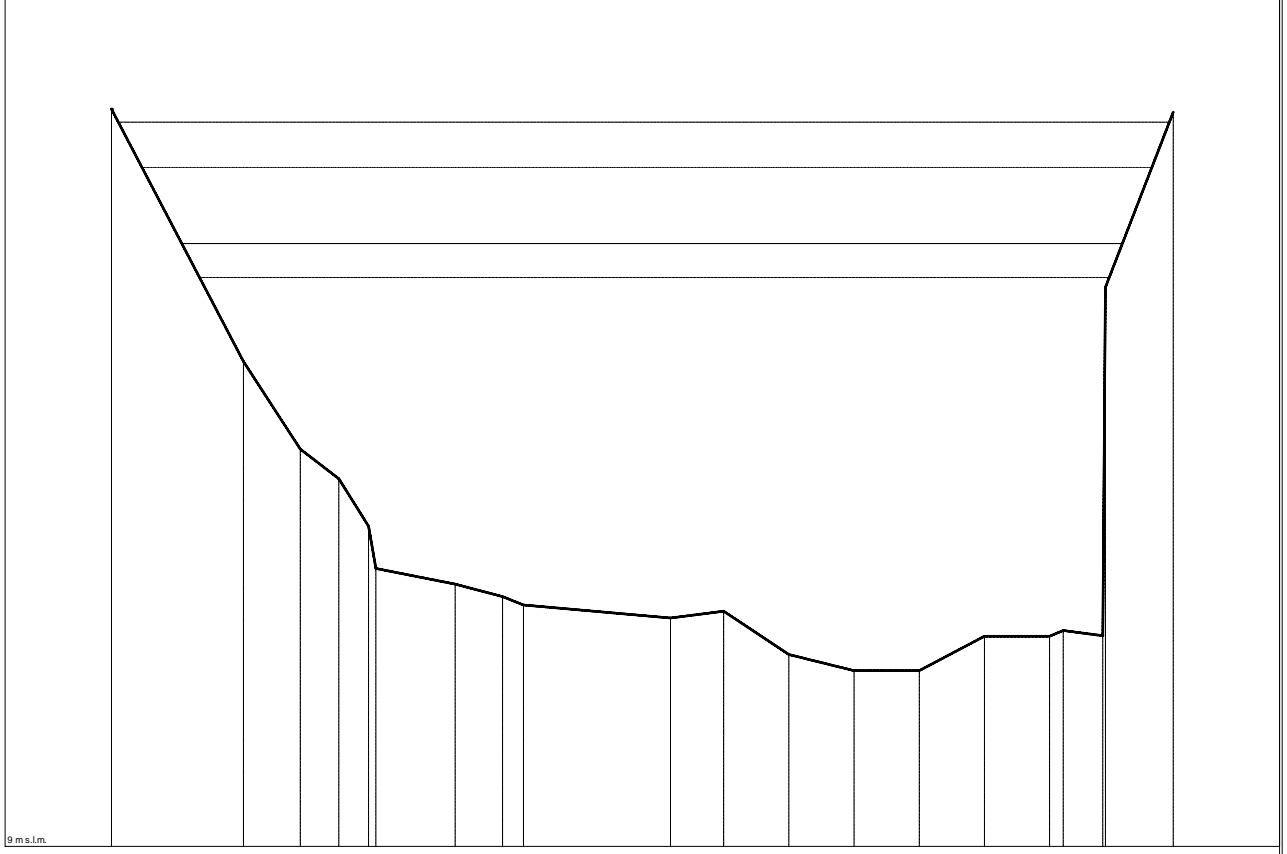

fr0059
 Sezione n. fr0059

Scala distanze 1:160
 Scala quote 1:80

Punti	1	2	3	4	5	7	8	9	10	11	12	13	14	15	16	17	18	20
Quote [m s.l.m.]	20,32	18,44	15,10	14,64	13,91	13,03	12,83	12,71	12,51	12,61	11,95	11,70	11,70	12,23	12,23	12,31	12,23	20,27
Distanze progressive [m]	11,7	15,7	17,5	18,7	19,6	22,2	23,7	24,3	28,8	30,5	32,5	34,5	36,5	38,5	40,5	40,9	42,1	44,3
Distanze parziali [m]		4,1	1,7	1,2	0,9	2,4	1,5	0,6	4,5	1,6	2,0	2,0	2,0	2,0	2,0	1,2	2,1	

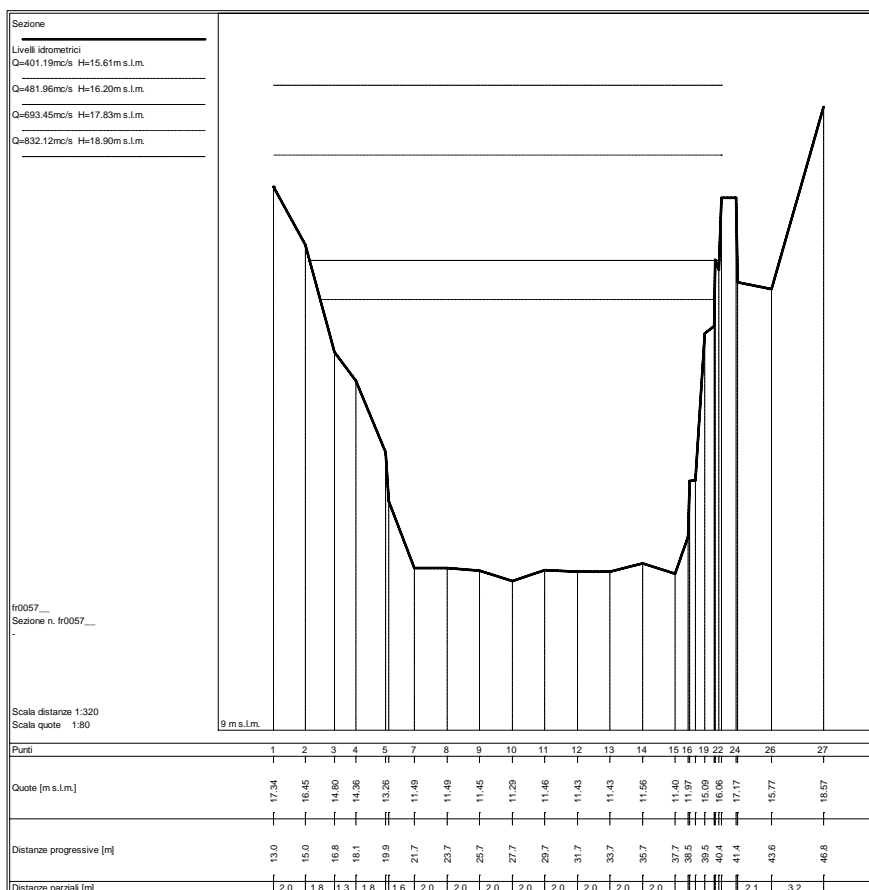
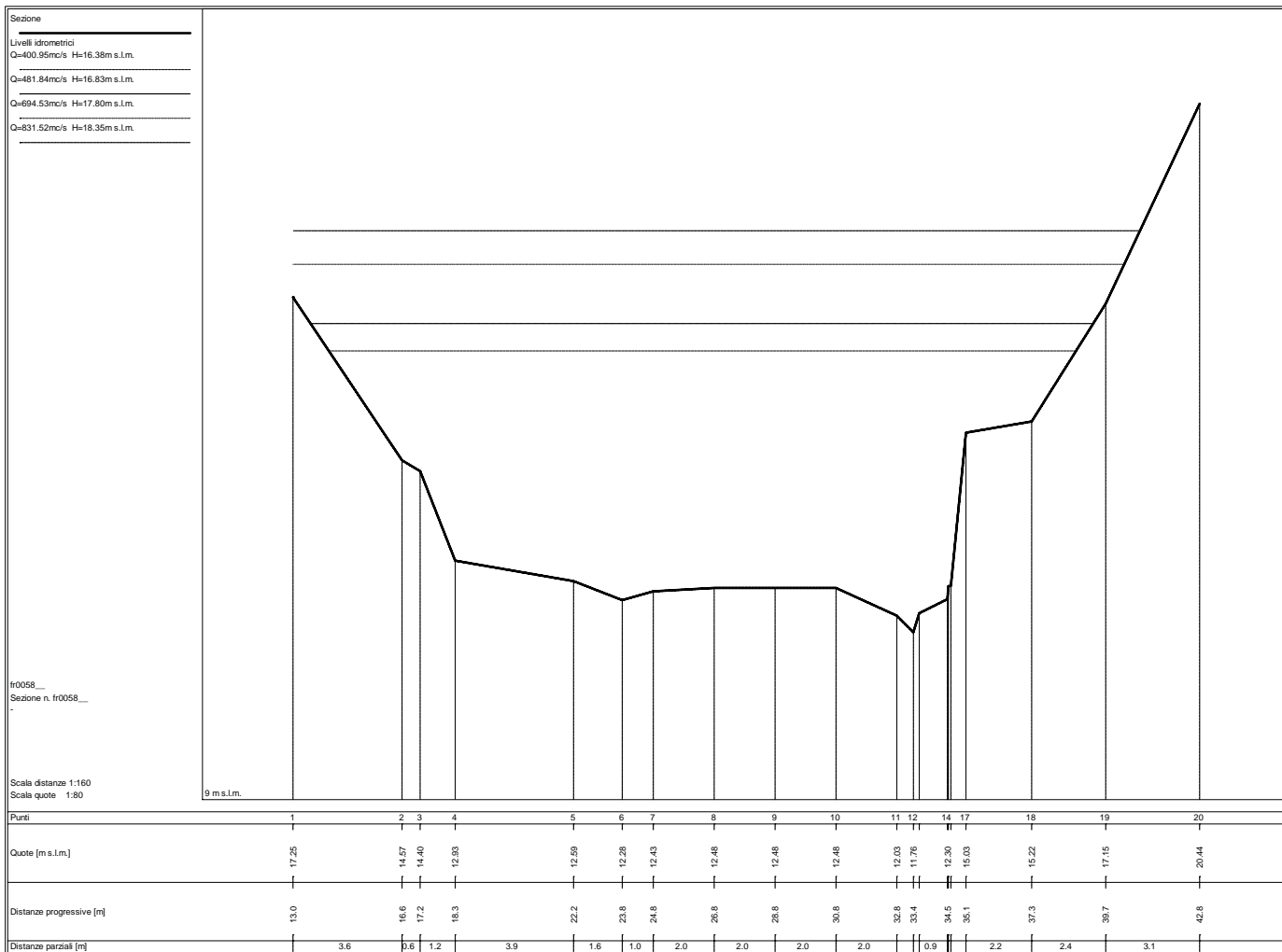

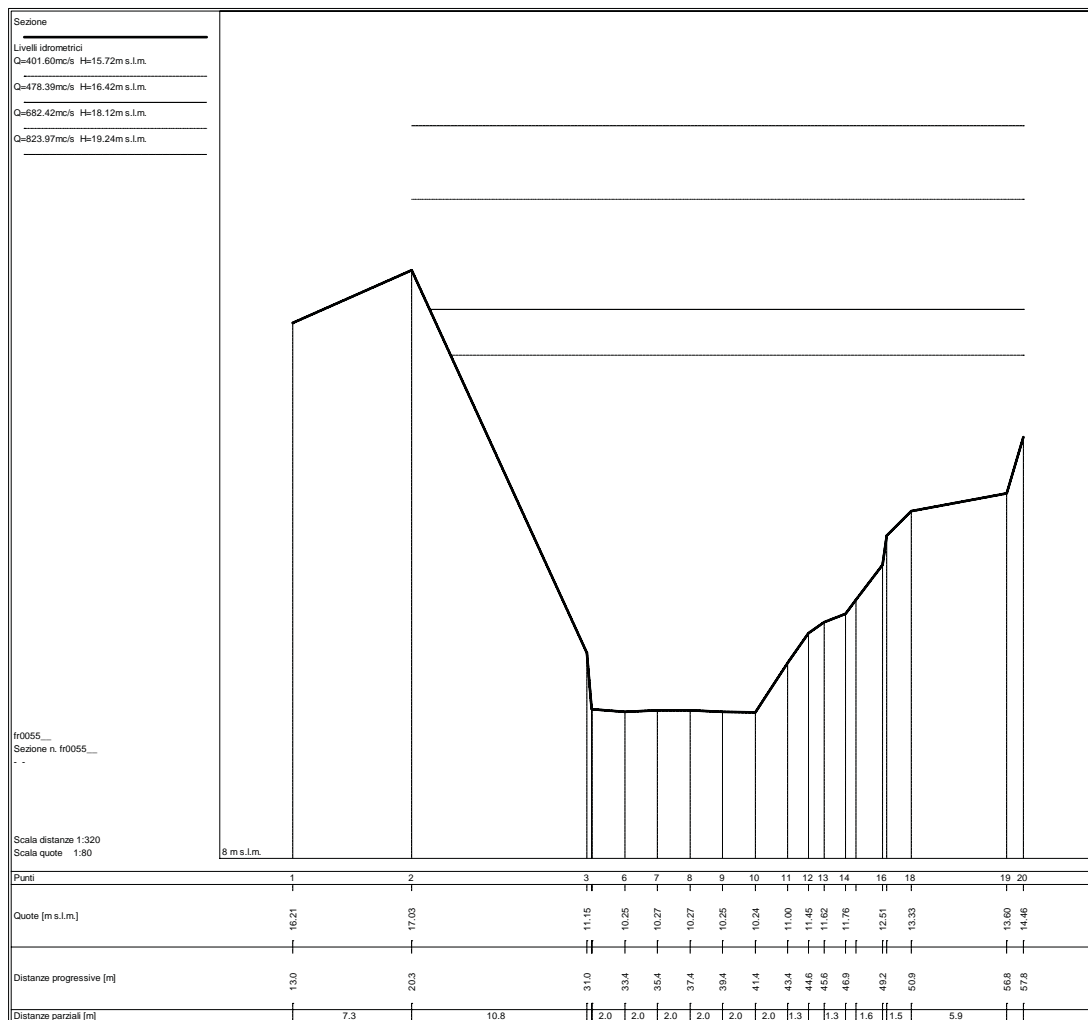
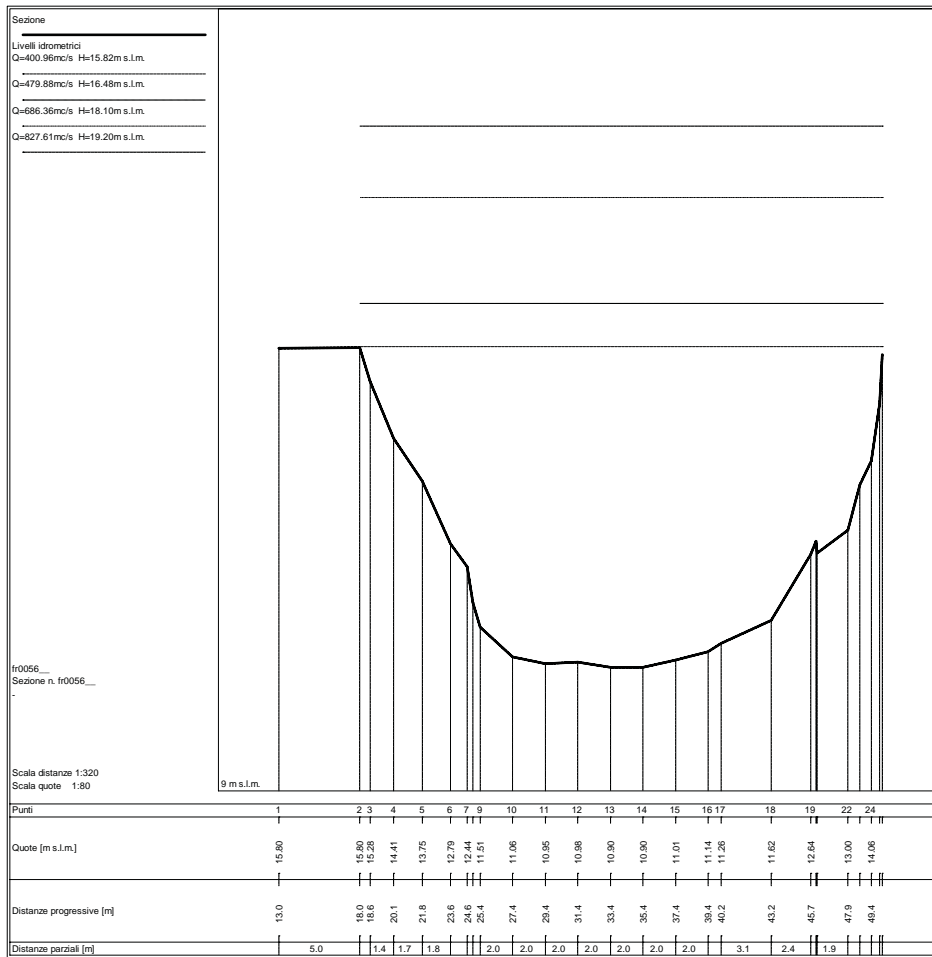

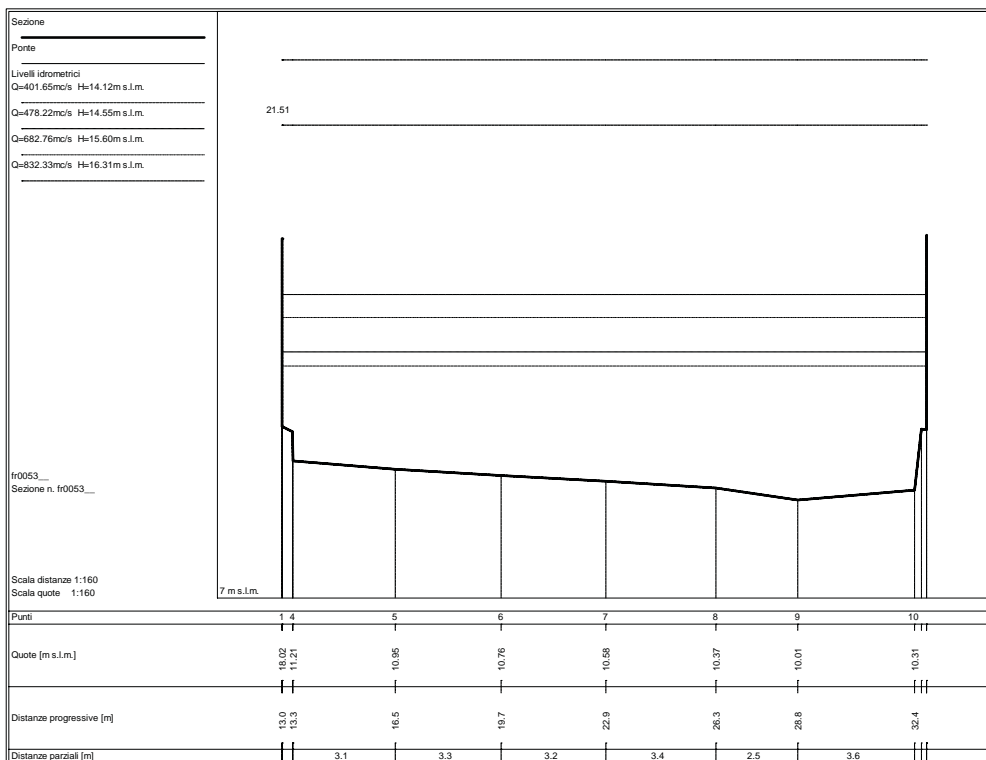
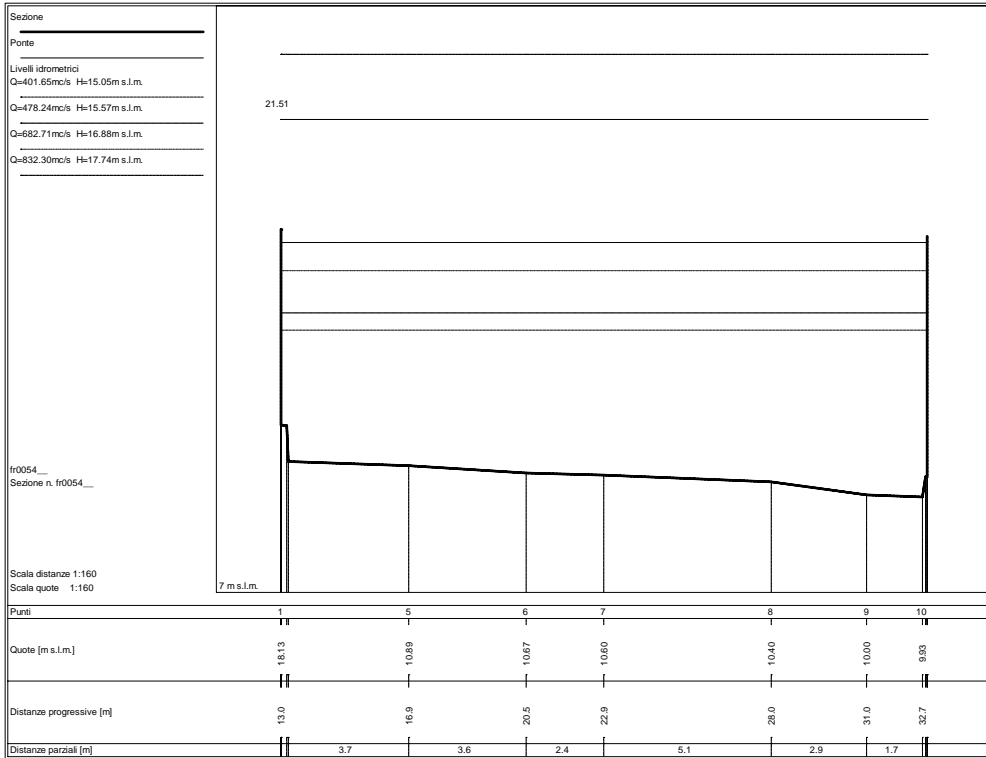

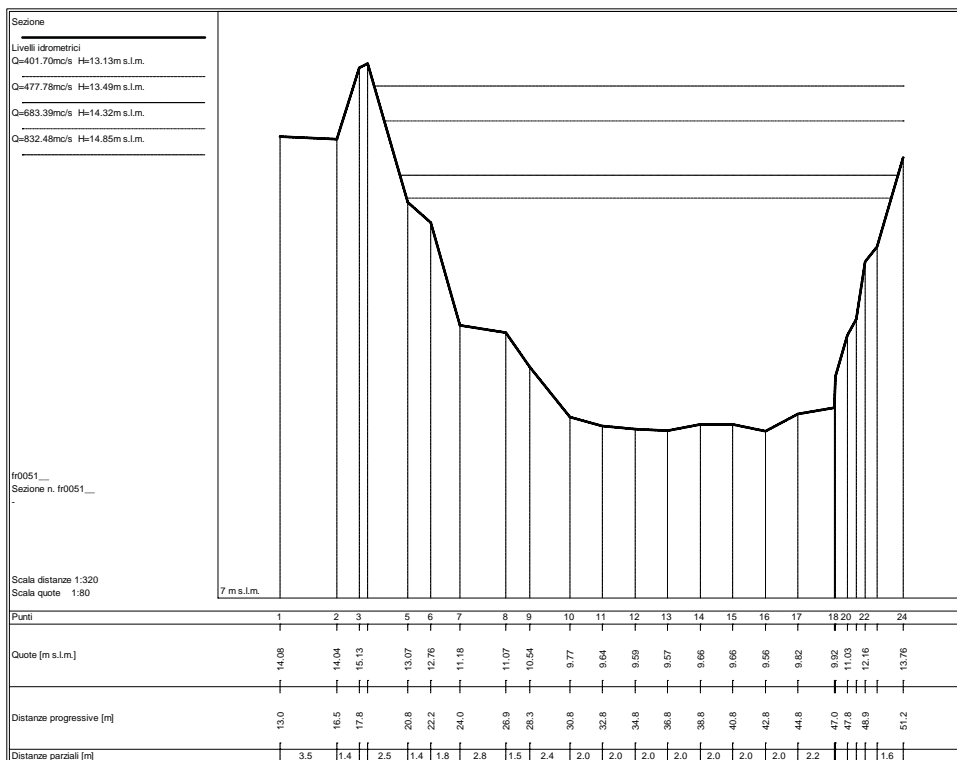
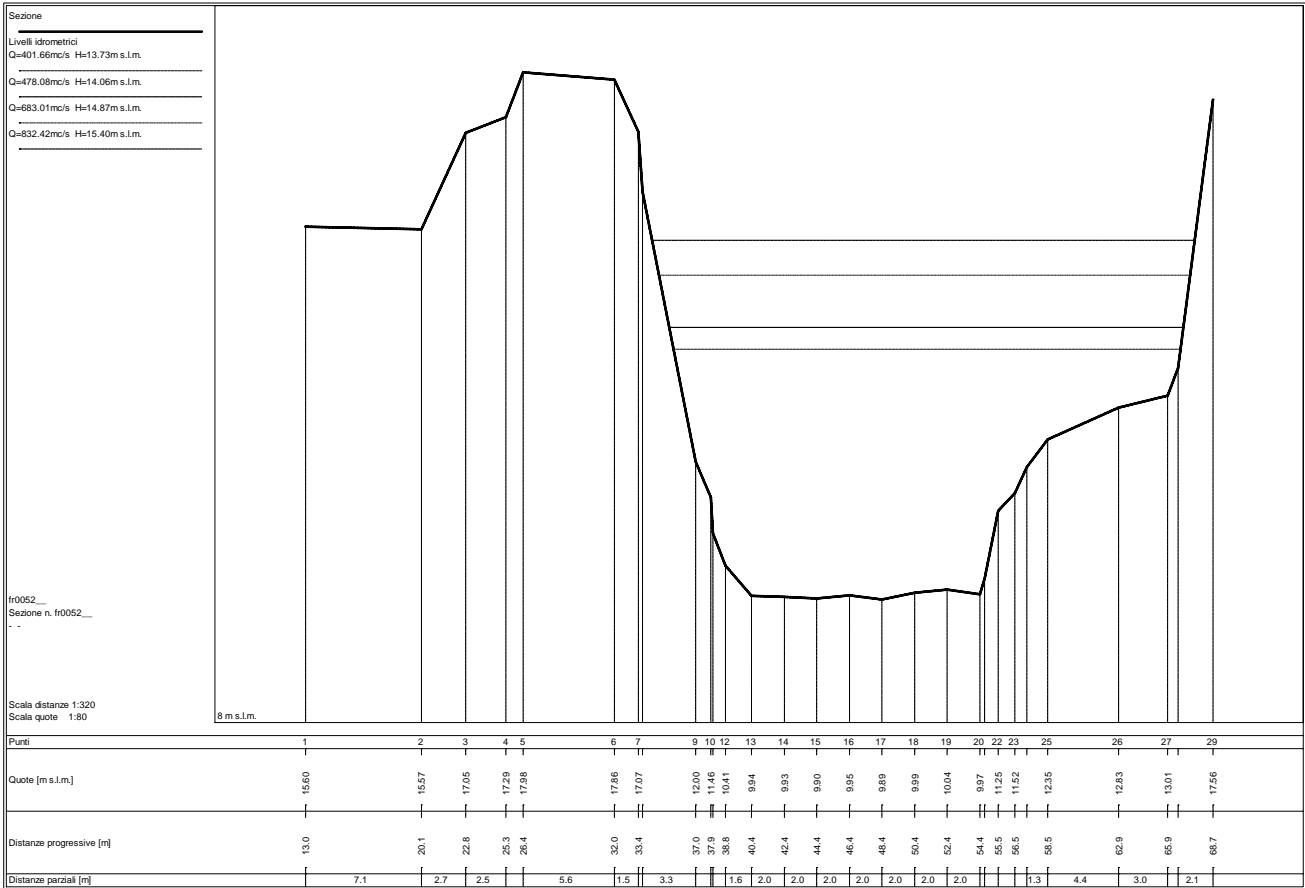

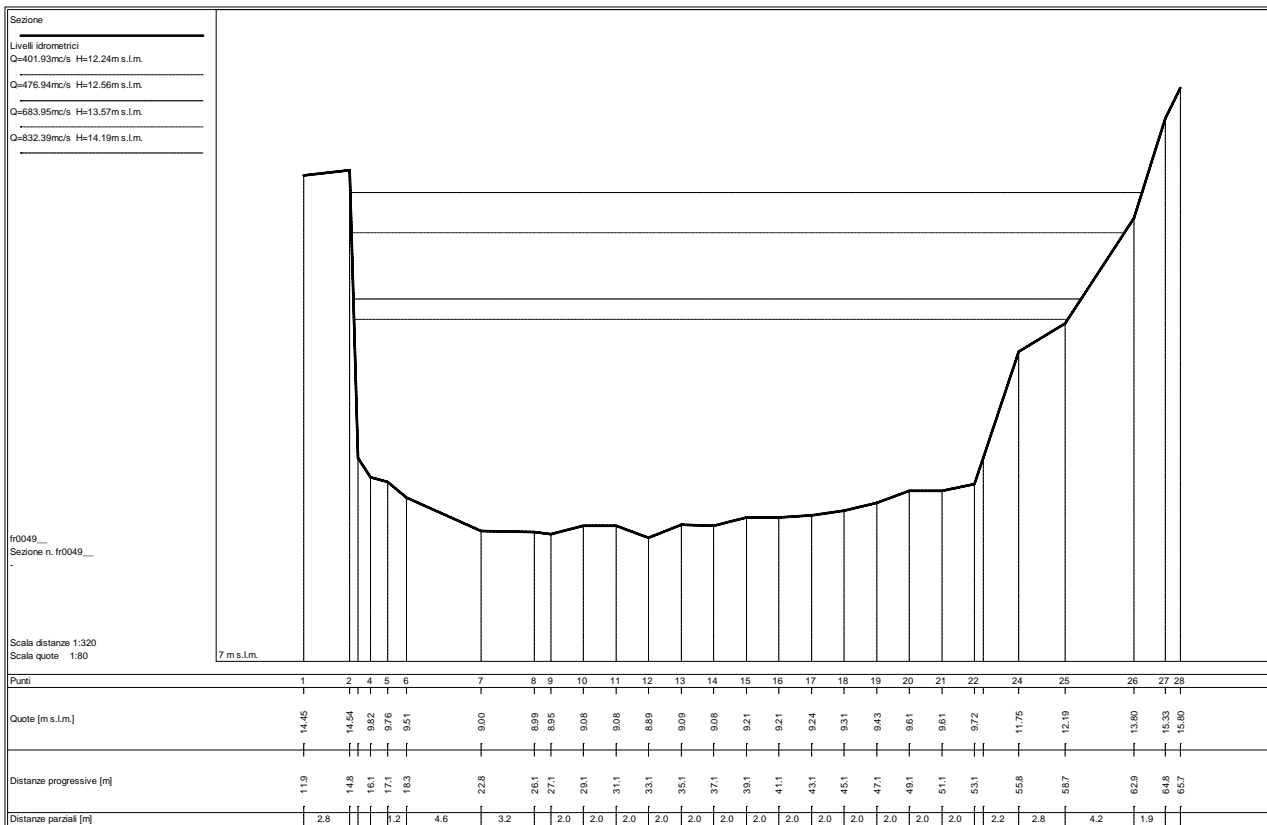
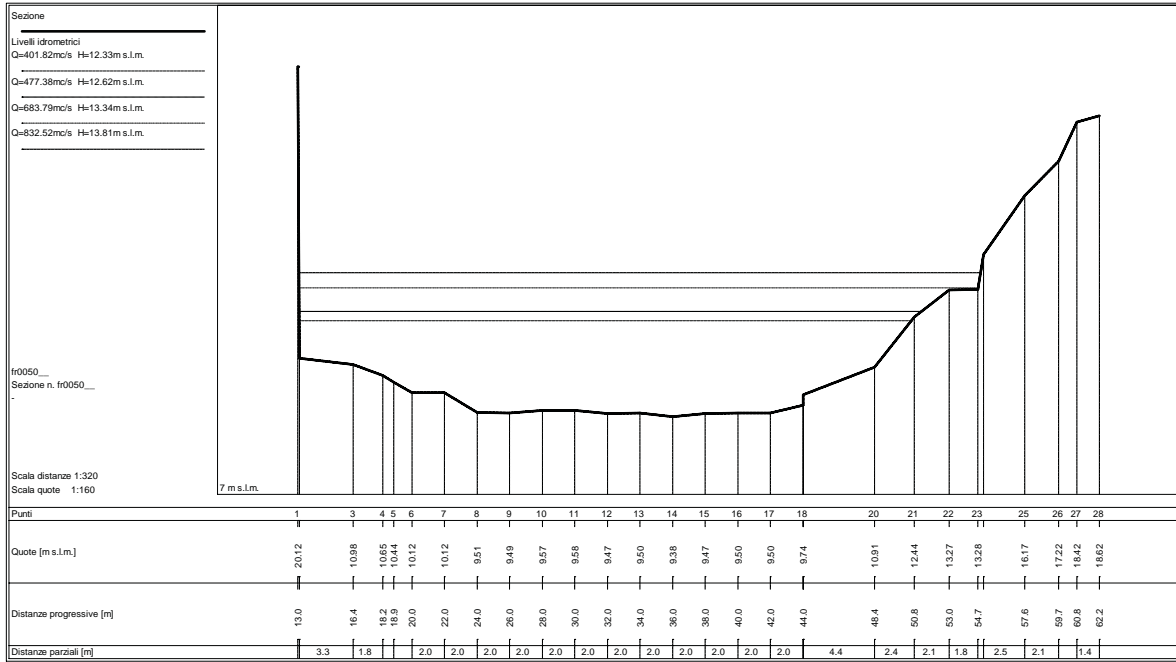

Sezione
 Livelli idrometrici
 Q=401.99mc/s H=11.80m s.l.m.
 Q=476.16mc/s H=12.24m s.l.m.
 Q=684.01mc/s H=13.42m s.l.m.
 Q=832.02mc/s H=14.06m s.l.m.

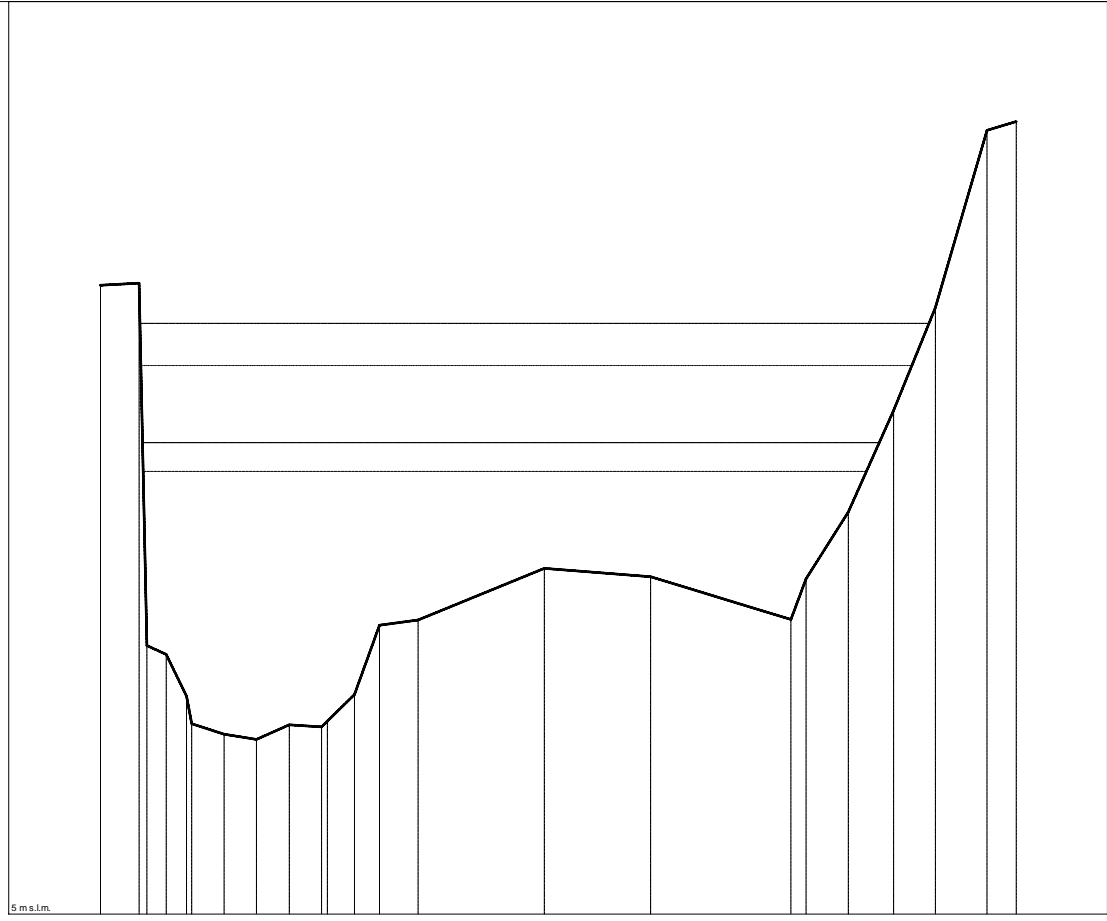

fr0048
 Sezione n. fr0048

Scala distanze 1:320
 Scala quote 1:80

5 m s.l.m.

Punti	1	2	4	5	7	8	9	10	12	13	14	15	16	17	18	19	20	21	22	23
Quote [m s.l.m.]	14.65	14.68	8.98	8.34	7.76	7.68	7.90	7.67	8.37	9.43	9.51	10.30	10.18	9.52	10.14	11.17	12.73	14.31	17.02	17.16
Distanze progressive [m]	12.4	14.8	16.4	17.7	20.0	22.0	24.0	26.0	28.0	29.5	31.9	38.6	46.2	54.8	55.7	58.3	61.1	63.6	66.8	68.6
Distanze parziali [m]	2.4	1.2	1.2	2.0	2.0	2.0	2.0	1.7	1.5	2.4	7.7	6.5	8.6	2.6	2.8	2.5	3.2	1.8		

Sezione
 Livelli idrometrici
 Q=401.94mc/s H=11.69m s.l.m.
 Q=475.16mc/s H=12.10m s.l.m.
 Q=684.00mc/s H=13.23m s.l.m.
 Q=831.47mc/s H=13.79m s.l.m.

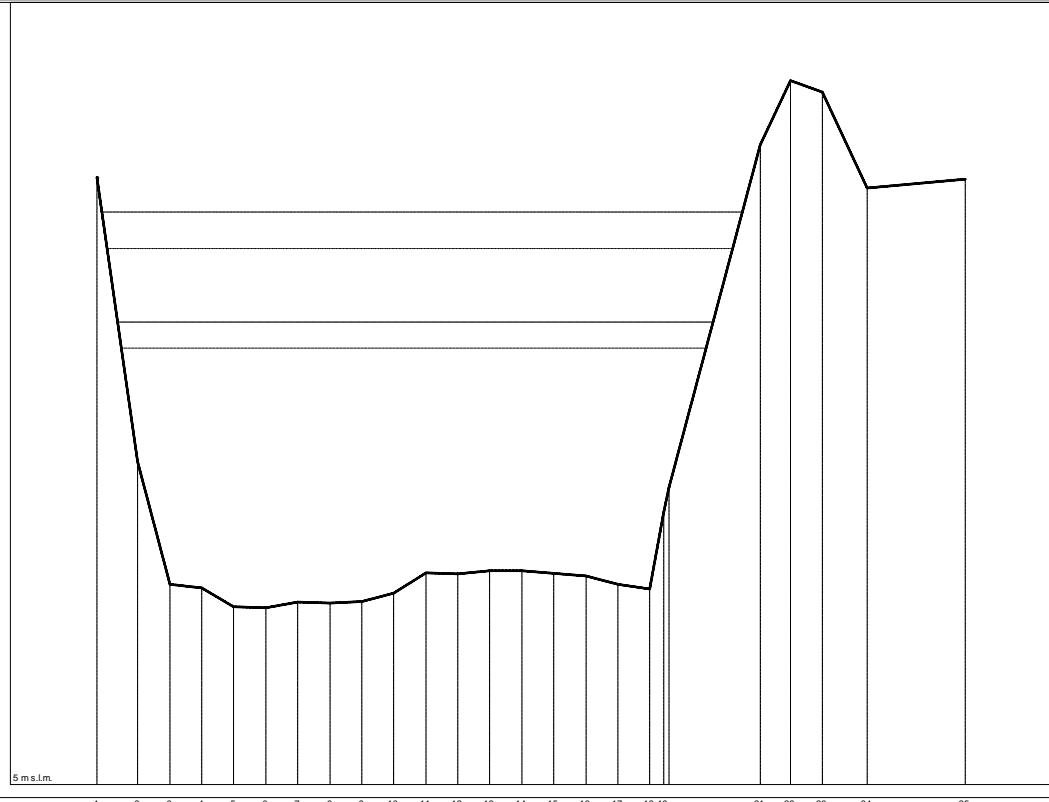

fr0047
 Sezione n. fr0047

Scala distanze 1:320
 Scala quote 1:80

5 m s.l.m.

Punti	1	2	3	4	5	6	7	8	9	10	11	12	13	14	15	16	17	18	19	21	22	23	24	25
Quote [m s.l.m.]	14.31	9.95	8.07	8.01	7.73	7.71	7.80	7.78	7.81	7.93	8.25	8.23	8.28	8.28	8.24	8.20	8.07	8.00	9.19	14.82	15.80	15.62	14.16	14.29
Distanze progressive [m]	12.4	14.9	16.9	18.8	20.8	22.7	24.7	26.7	28.6	30.6	32.6	34.5	36.5	38.5	40.4	42.4	44.4	46.3	47.2	53.1	55.0	56.9	58.6	65.7
Distanze parziali [m]	2.5	2.0	2.0	2.0	2.0	2.0	2.0	2.0	2.0	2.0	2.0	2.0	2.0	2.0	2.0	2.0	2.0	2.0	2.0	5.6	1.9	1.9	2.8	6.0

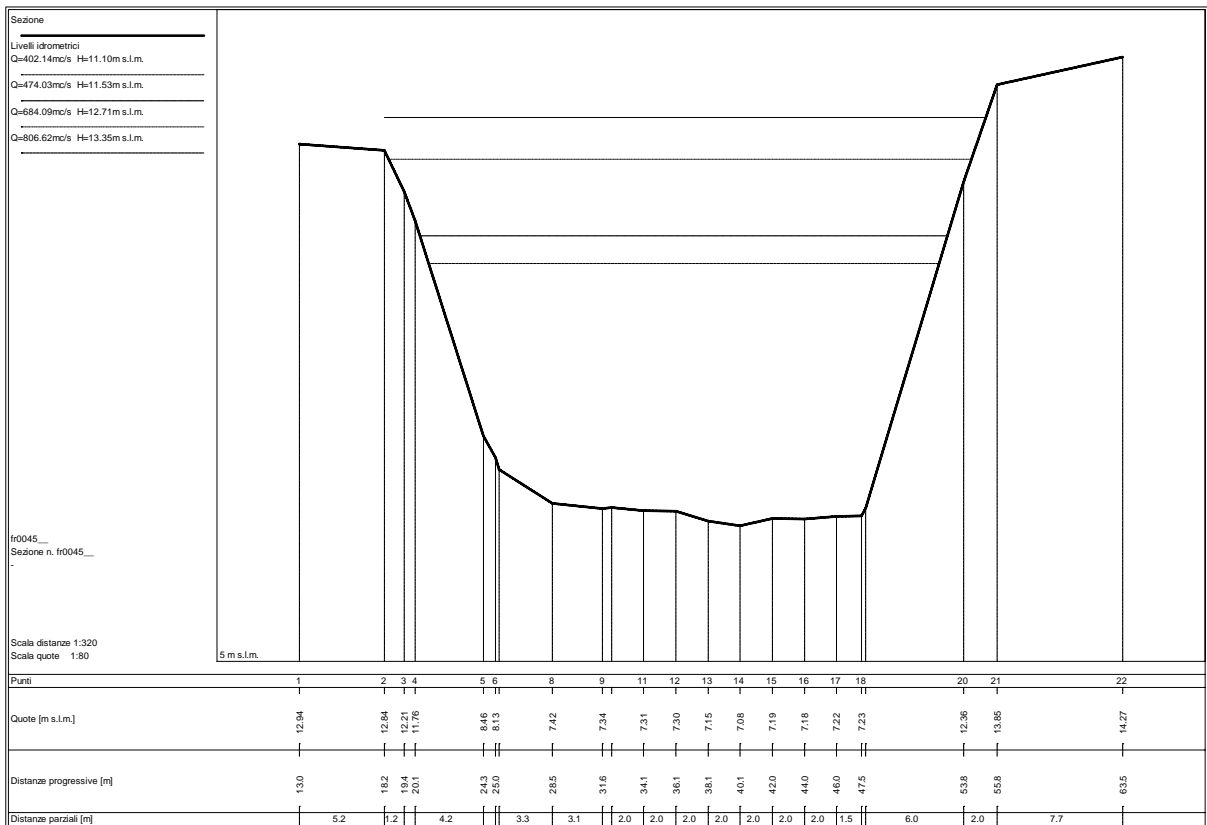
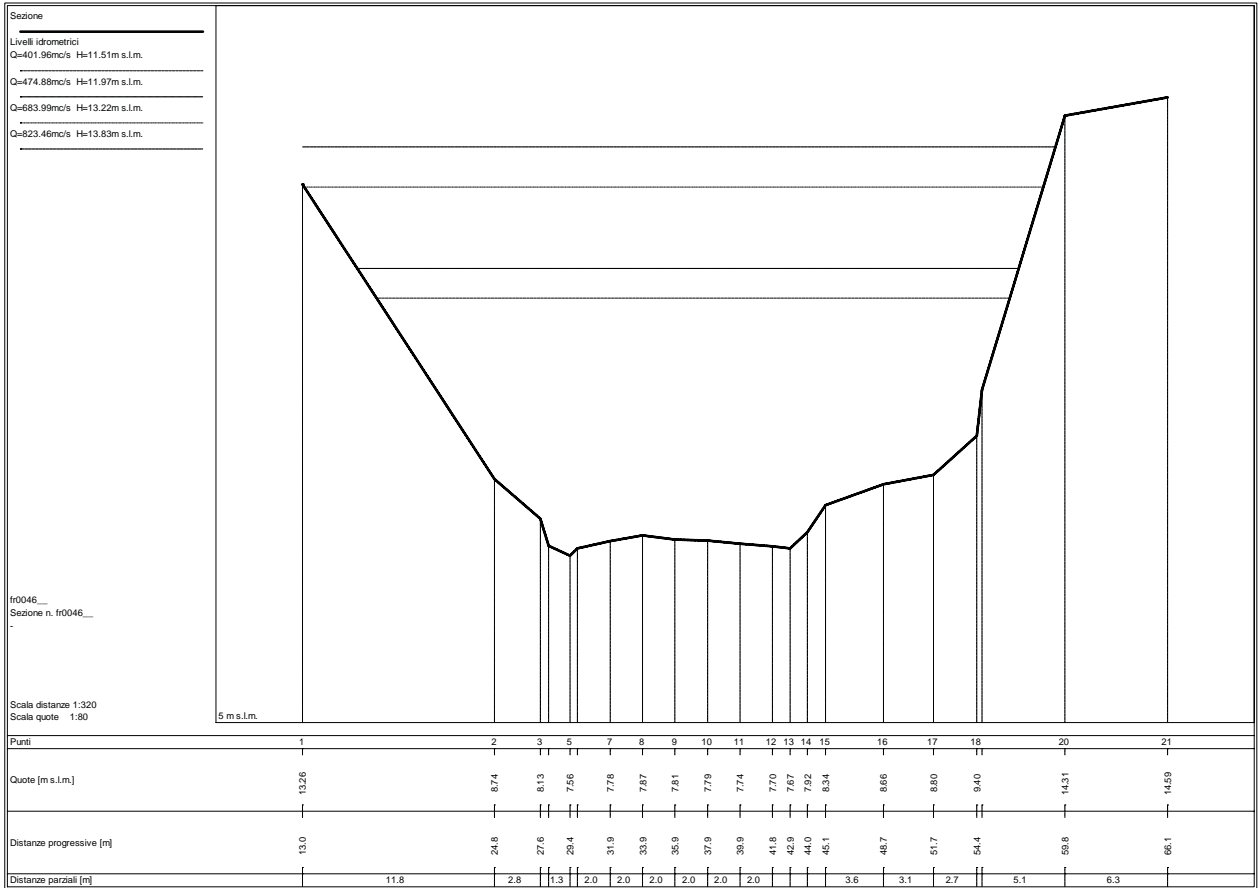

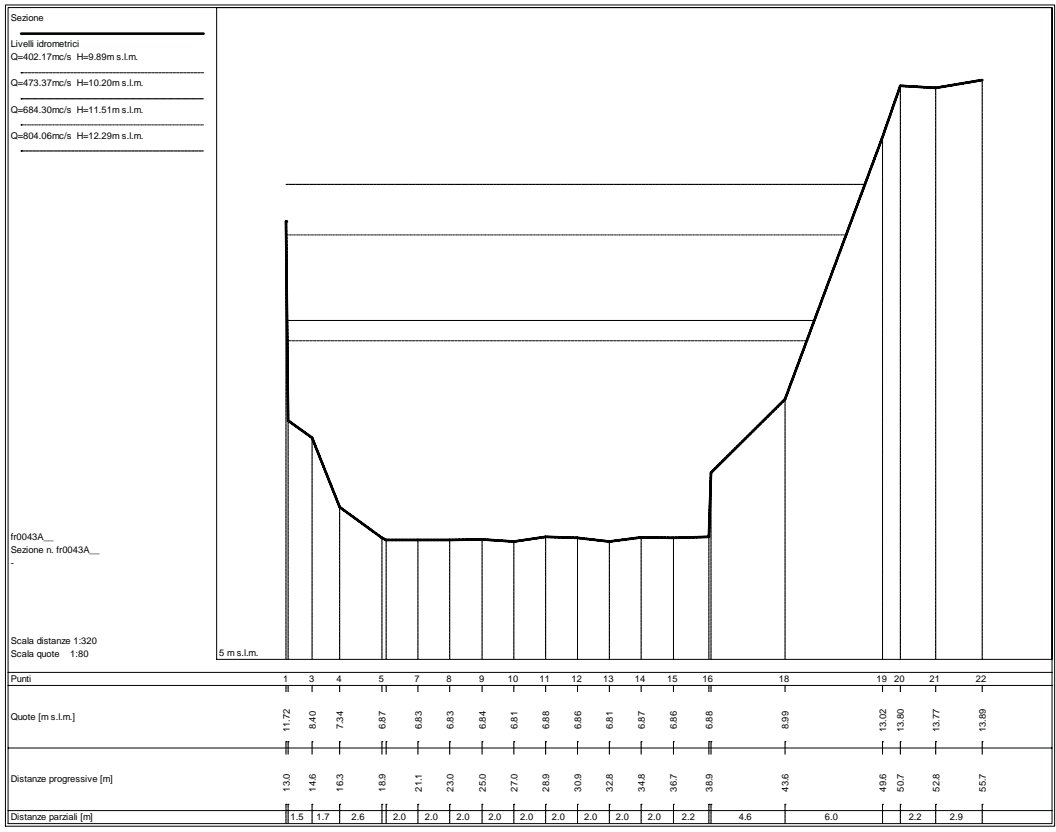
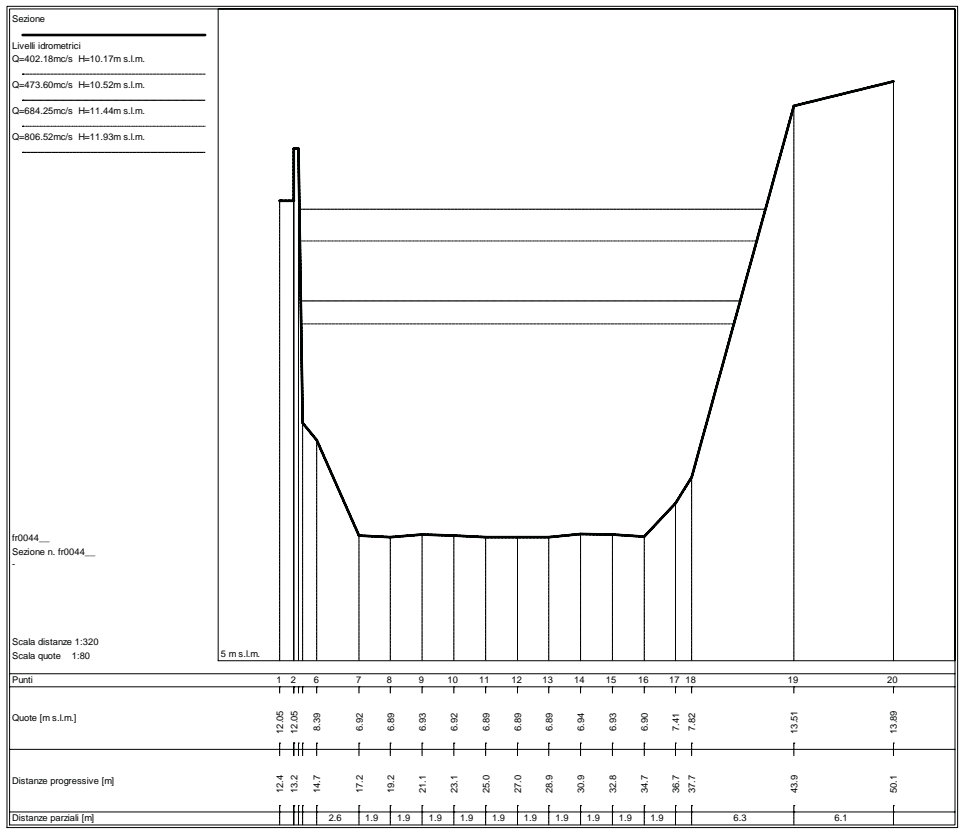

Sezione

Livelli idrometrici

Q=402.17mc/s H=9.95m s.l.m.

Q=473.10mc/s H=10.38m s.l.m.

Q=684.26mc/s H=11.73m s.l.m.

Q=797.39mc/s H=12.46m s.l.m.

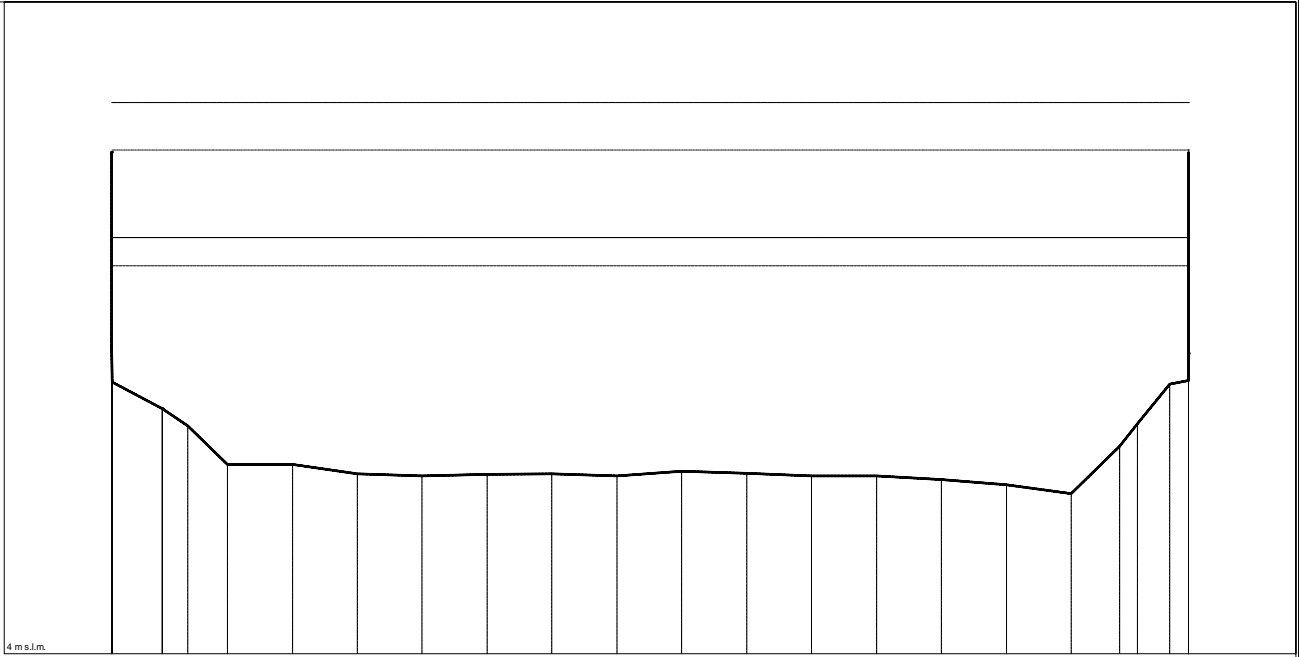

fr0042A_a

Sezione n. fr0042A_a

Scale distanze 1:160

Scala quote 1:80

Punti	1	4	6	7	8	9	10	11	12	13	14	15	16	17	18	19	20	21	22	23	24
Quote [m s.l.m.]	11.70	7.76	7.49	6.90	6.90	6.76	6.73	6.75	6.76	6.73	6.80	6.77	6.73	6.73	6.67	6.59	6.45	7.19	7.53	8.14	8.20
Distanze progressive [m]	13.6	15.2	16.0	17.2	19.2	21.2	23.2	25.1	27.1	29.1	31.1	33.1	35.1	37.1	38.1	41.1	43.1	44.5	45.1	46.1	46.7
Distanze parziali [m]	1.5	0.8	1.2	2.0	2.0	2.0	2.0	2.0	2.0	2.0	2.0	2.0	2.0	2.0	2.0	2.0	1.5	1.0	1.0	1.0	0.6

Sezione

Porte

Livelli idrometrici

Q=402.16mc/s H=9.36m s.l.m.

Q=473.09mc/s H=9.64m s.l.m.

Q=684.26mc/s H=10.39m s.l.m.

Q=797.38mc/s H=10.77m s.l.m.

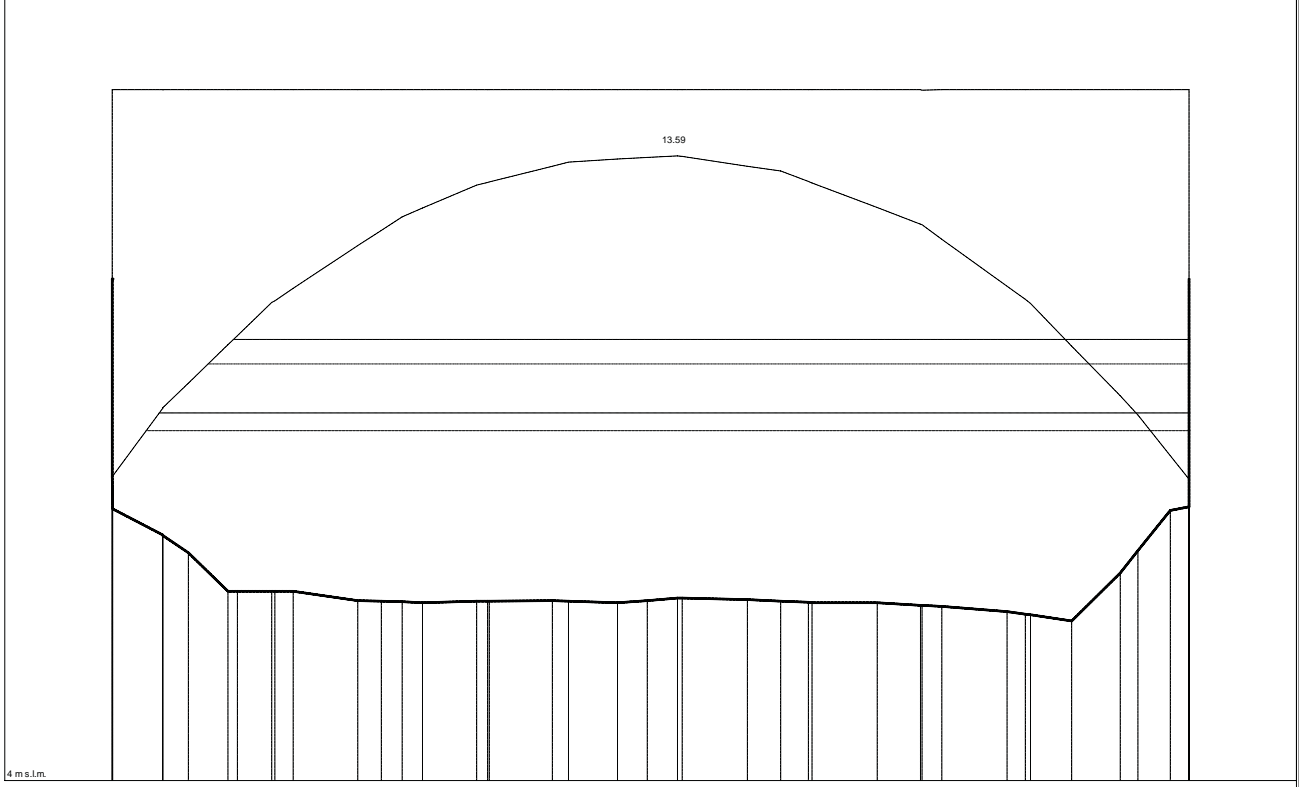

fr0042A_b

Sezione n. fr0042A_b

Scale distanze 1:160

Scala quote 1:80

Punti	1	4	6	7	9	11	12	13	14	15	16	19	20	21	22	23	25	26	27	29	30	32	33	34	36	37	38	39	40
Quote [m s.l.m.]	11.70	7.76	7.50	6.90	6.90	6.90	6.76	6.75	6.74	6.73	6.75	6.76	6.76	6.73	6.76	6.80	6.77	6.75	6.73	6.73	6.69	6.67	6.59	6.55	6.45	7.19	7.53	8.14	8.20
Distanze progressive [m]	13.0	14.5	15.3	16.5	17.9	18.5	20.5	21.2	21.9	22.5	24.2	26.5	27.0	28.5	29.4	30.3	32.5	33.5	34.3	36.5	37.8	38.5	40.4	41.0	42.4	43.9	44.5	45.5	46.0
Distanze parziali [m]	1.5	0.8	1.2	1.1	1.1	2.0	0.7	0.6	0.5	1.7	2.2	1.9	1.5	0.9	0.9	2.0	1.0	0.8	2.0	1.3	0.6	2.0	1.3	1.5	1.0	1.0	1.0	0.5	0.5

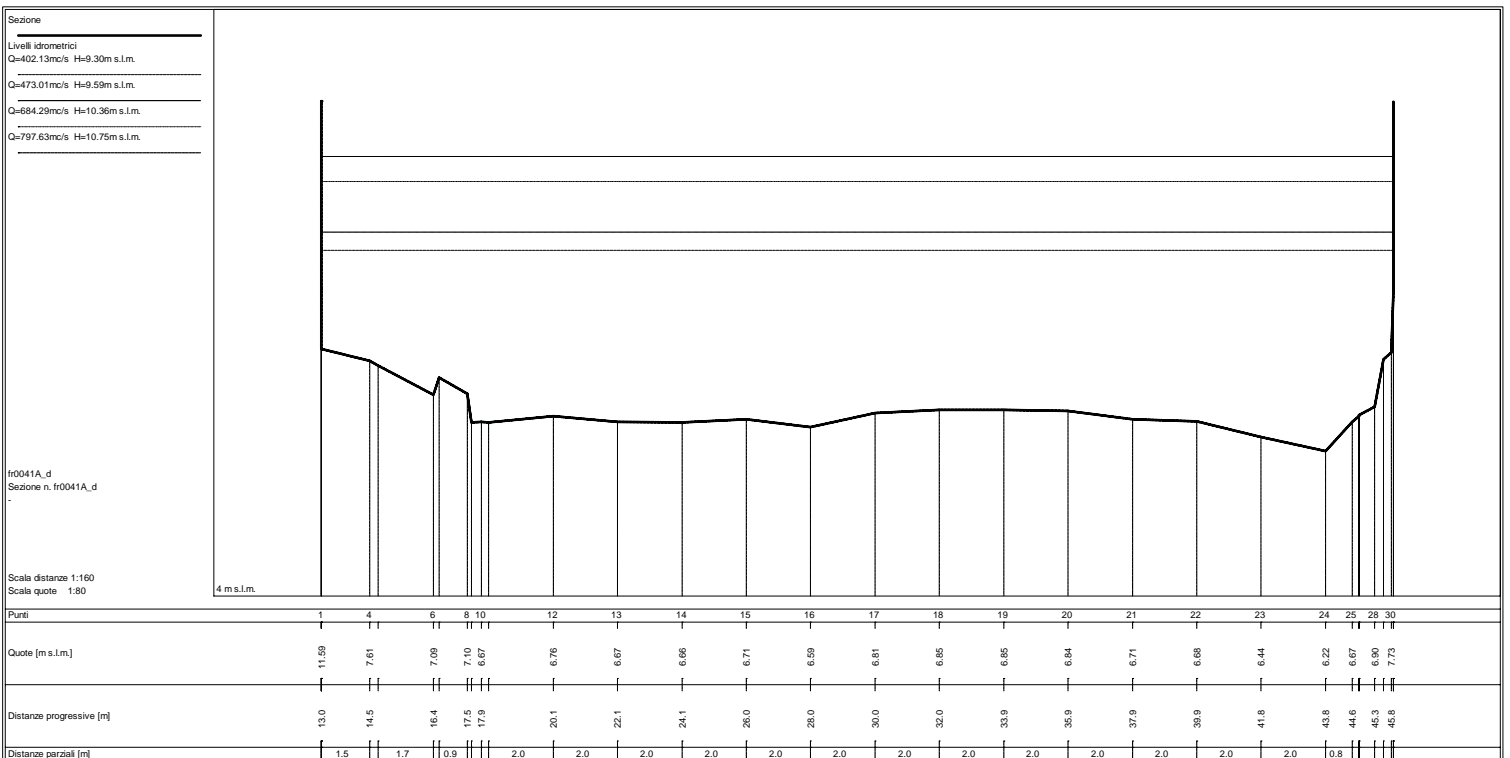
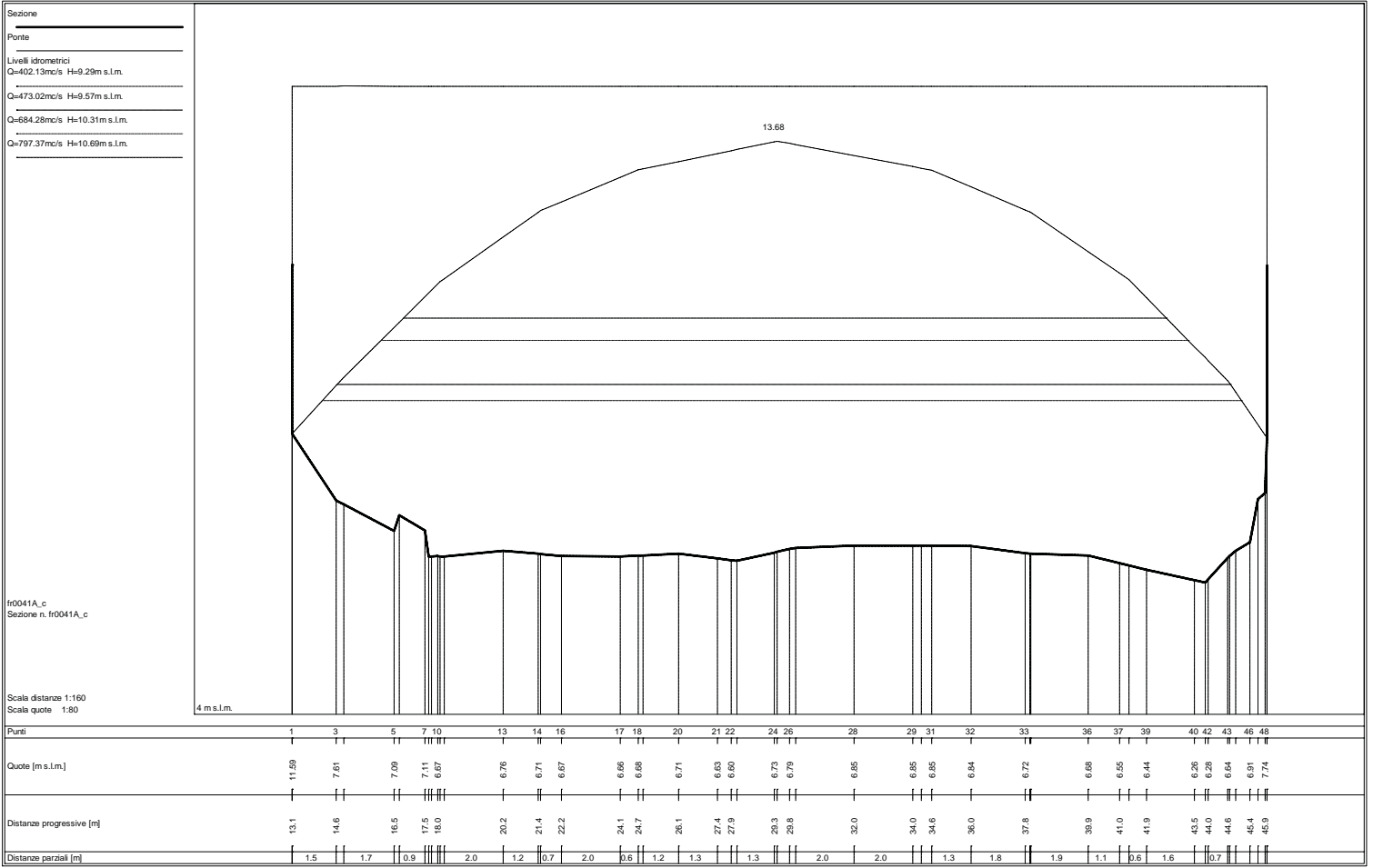

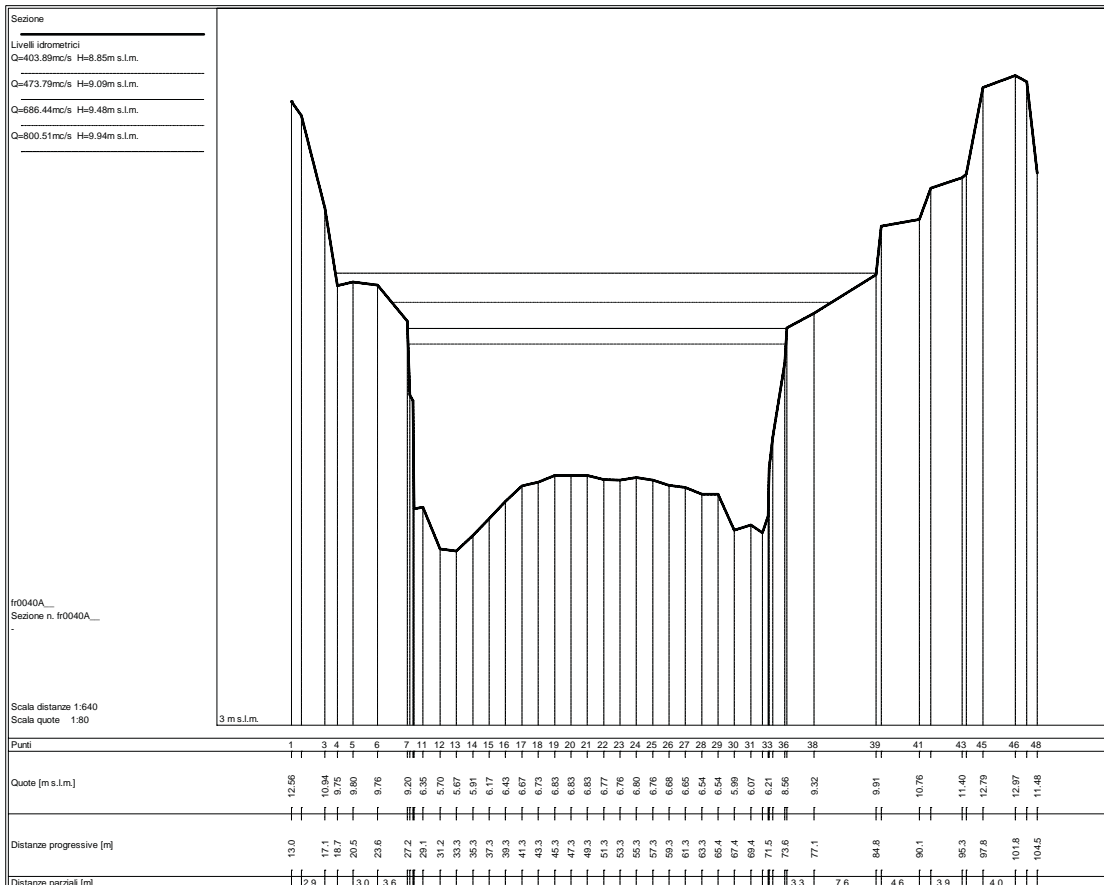
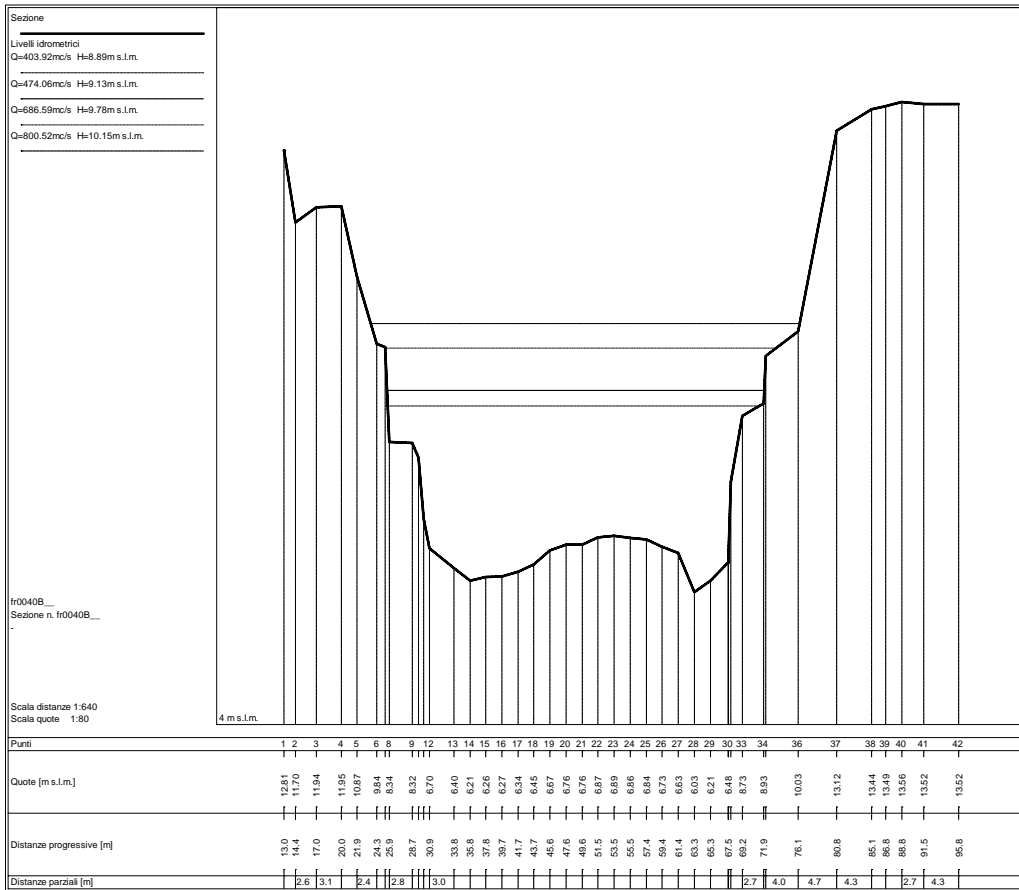

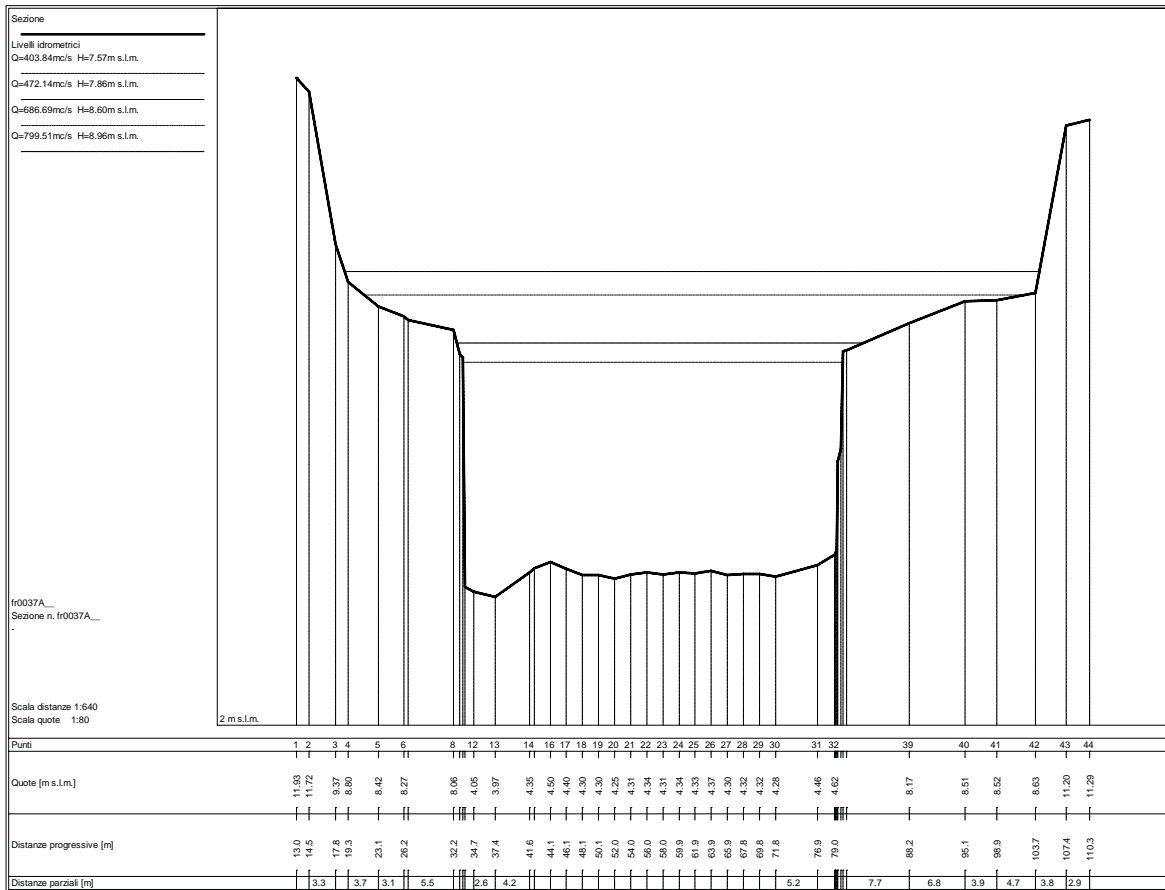
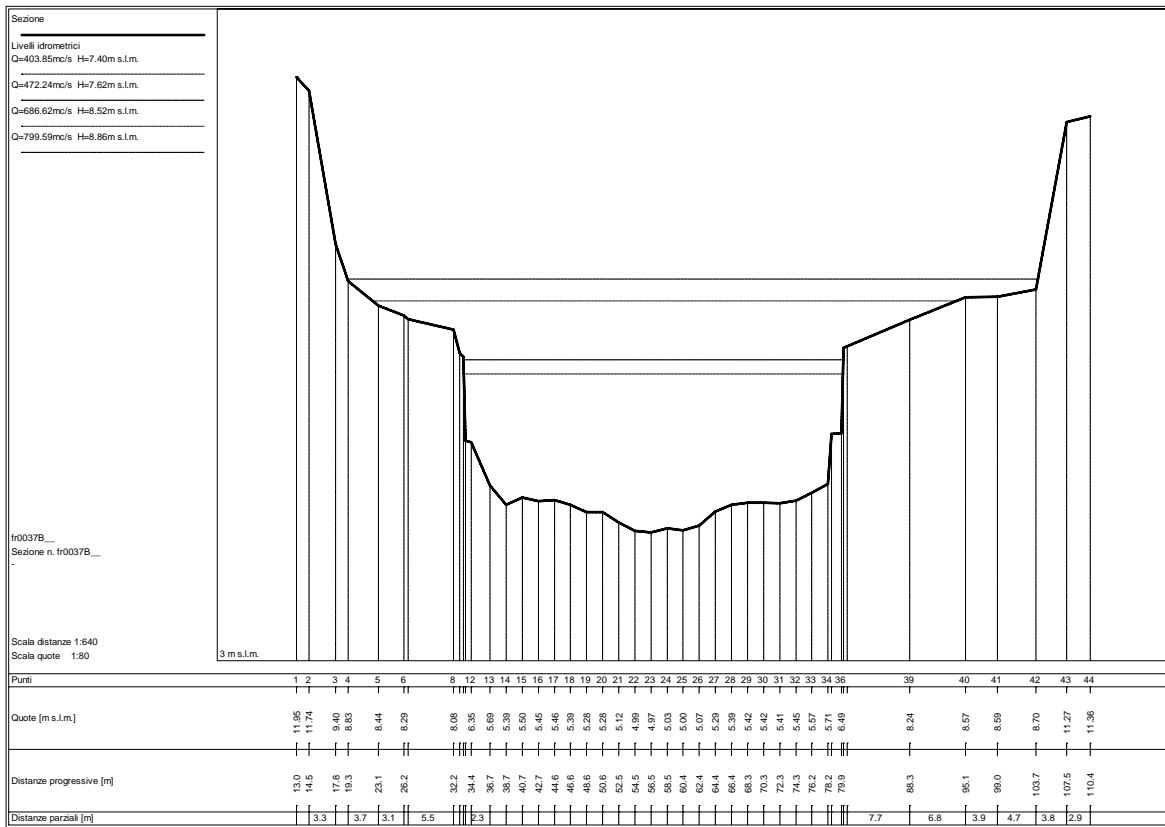

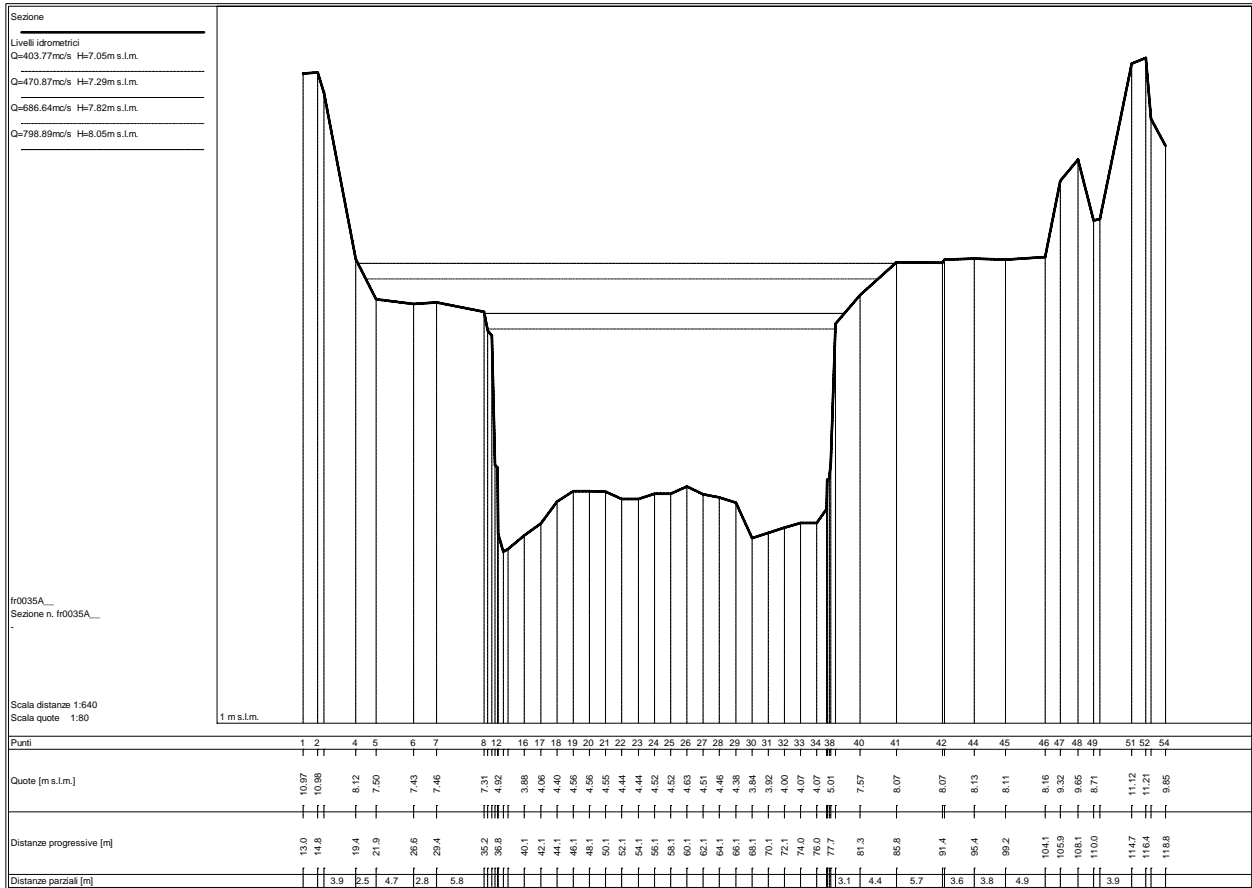
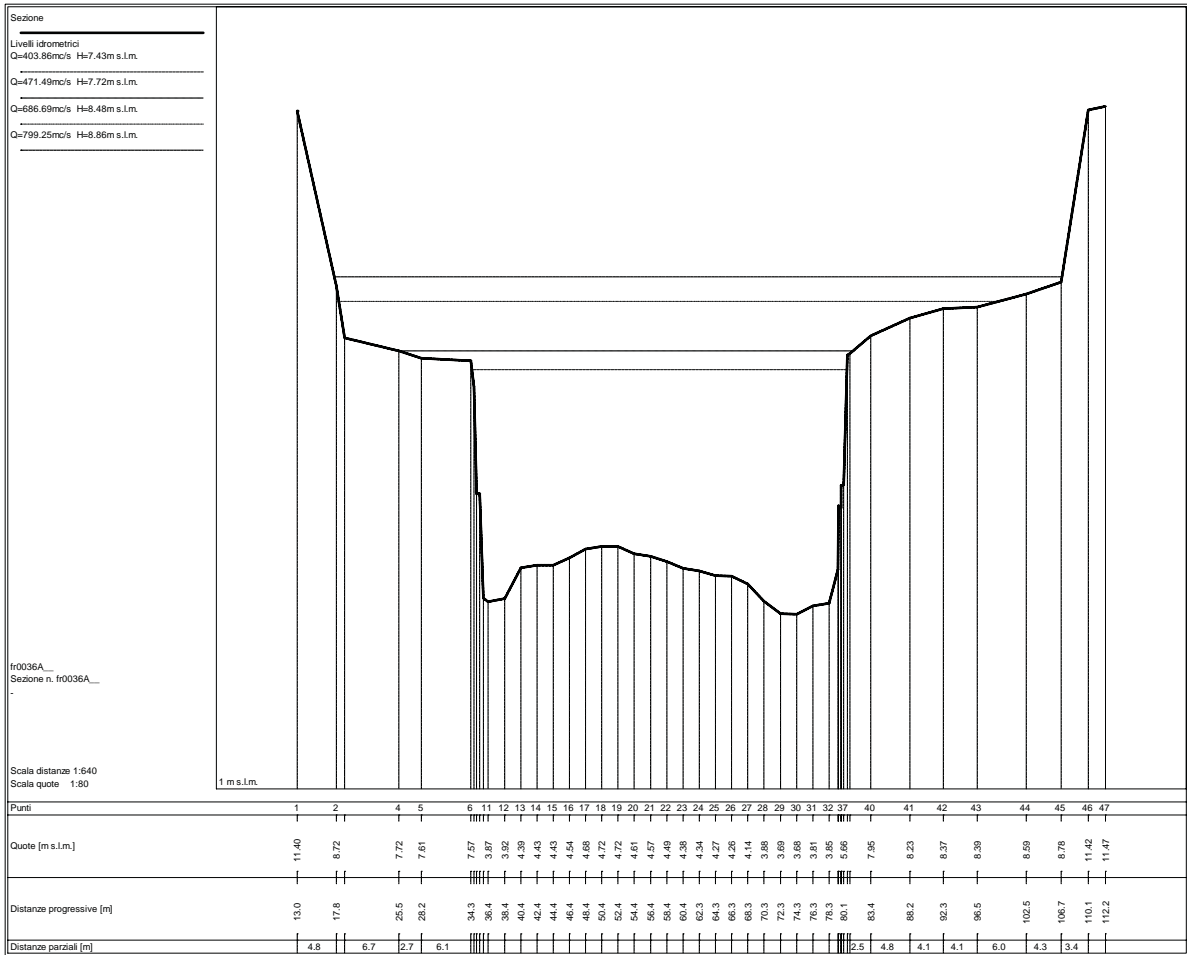

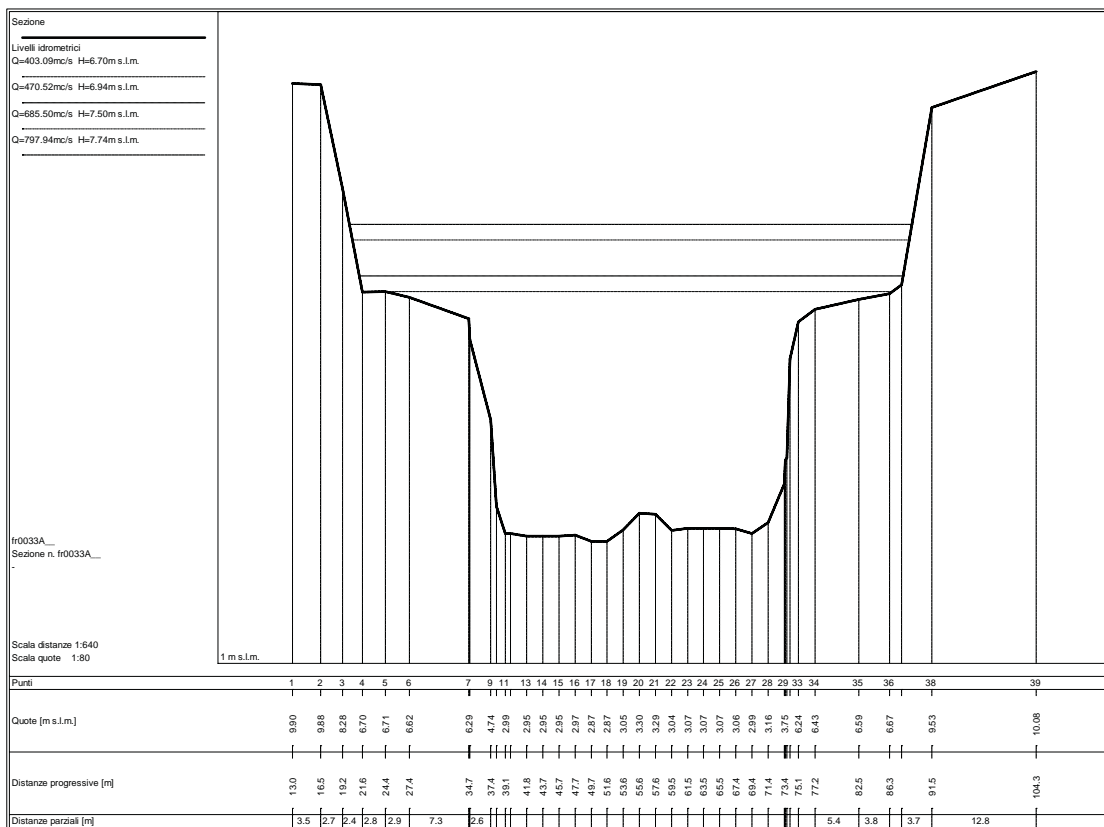
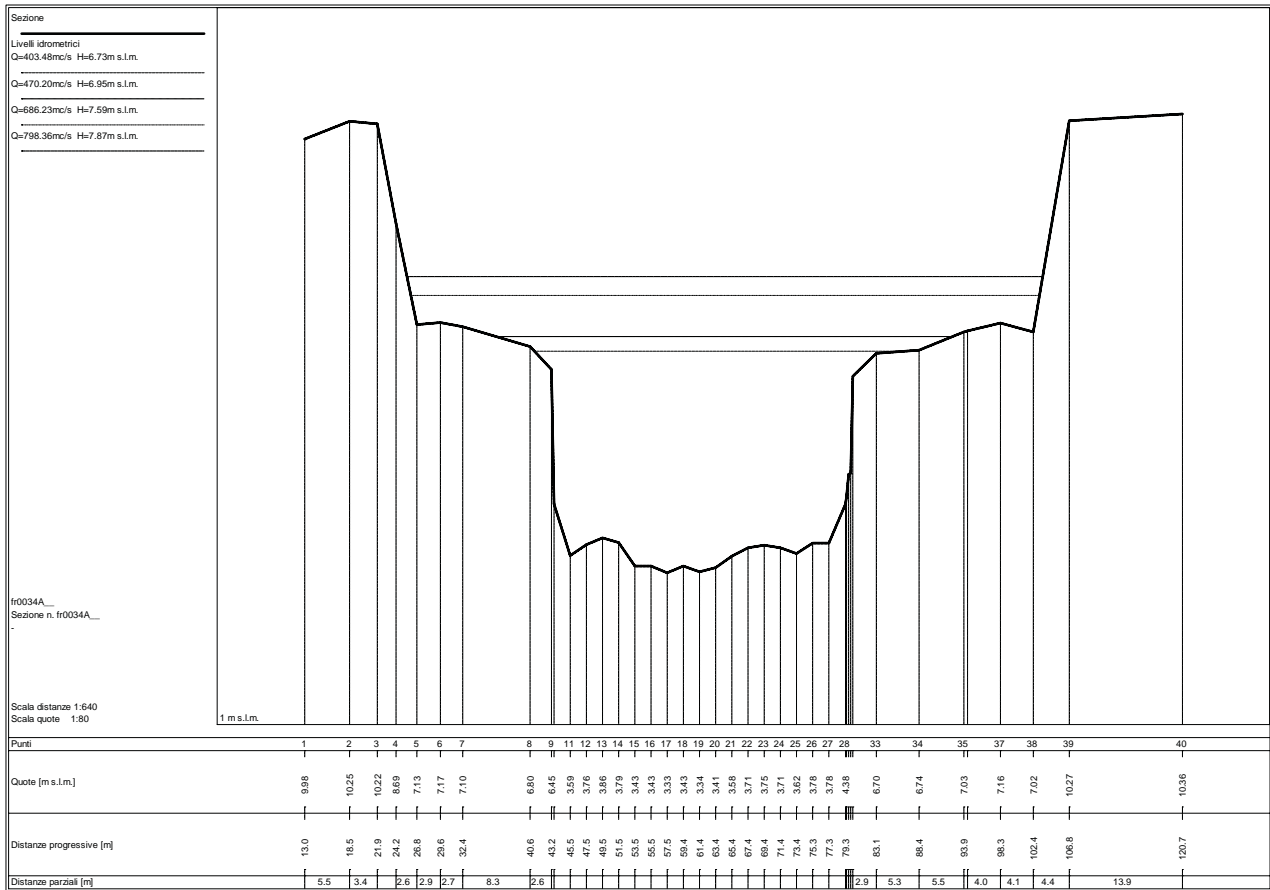

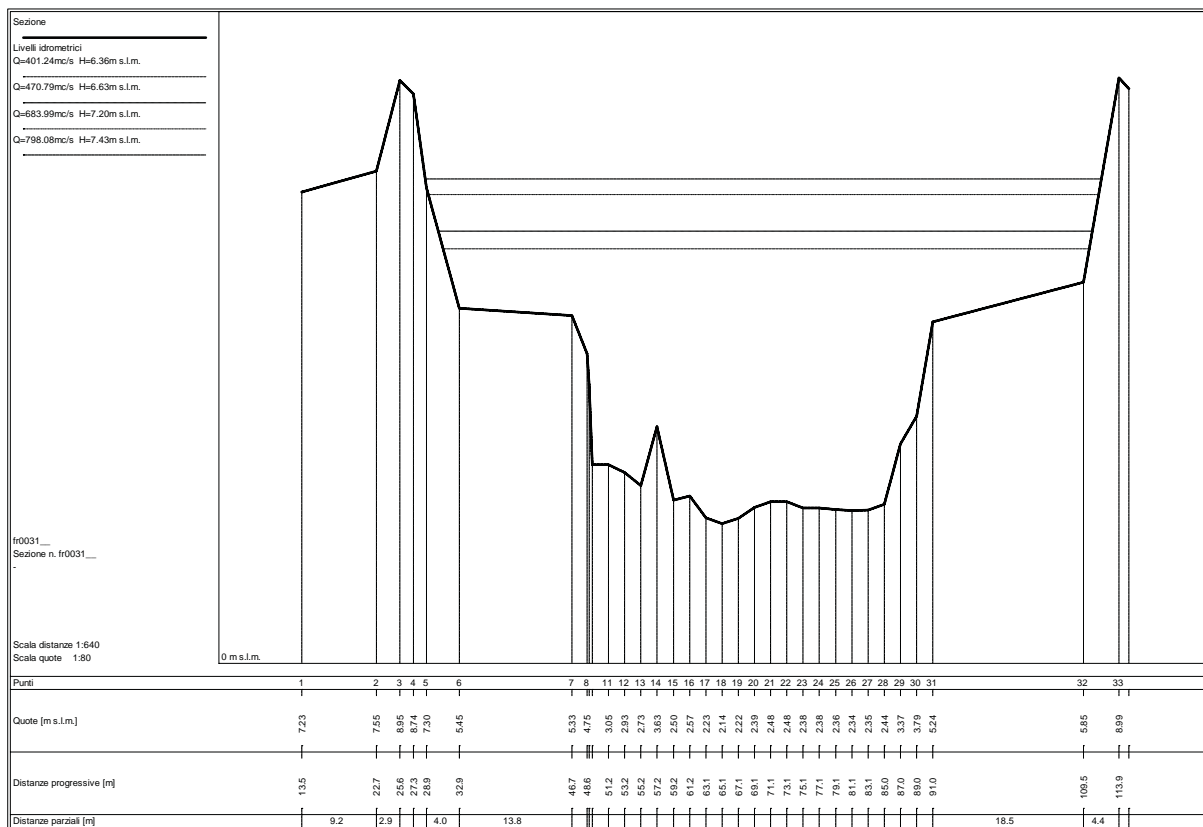
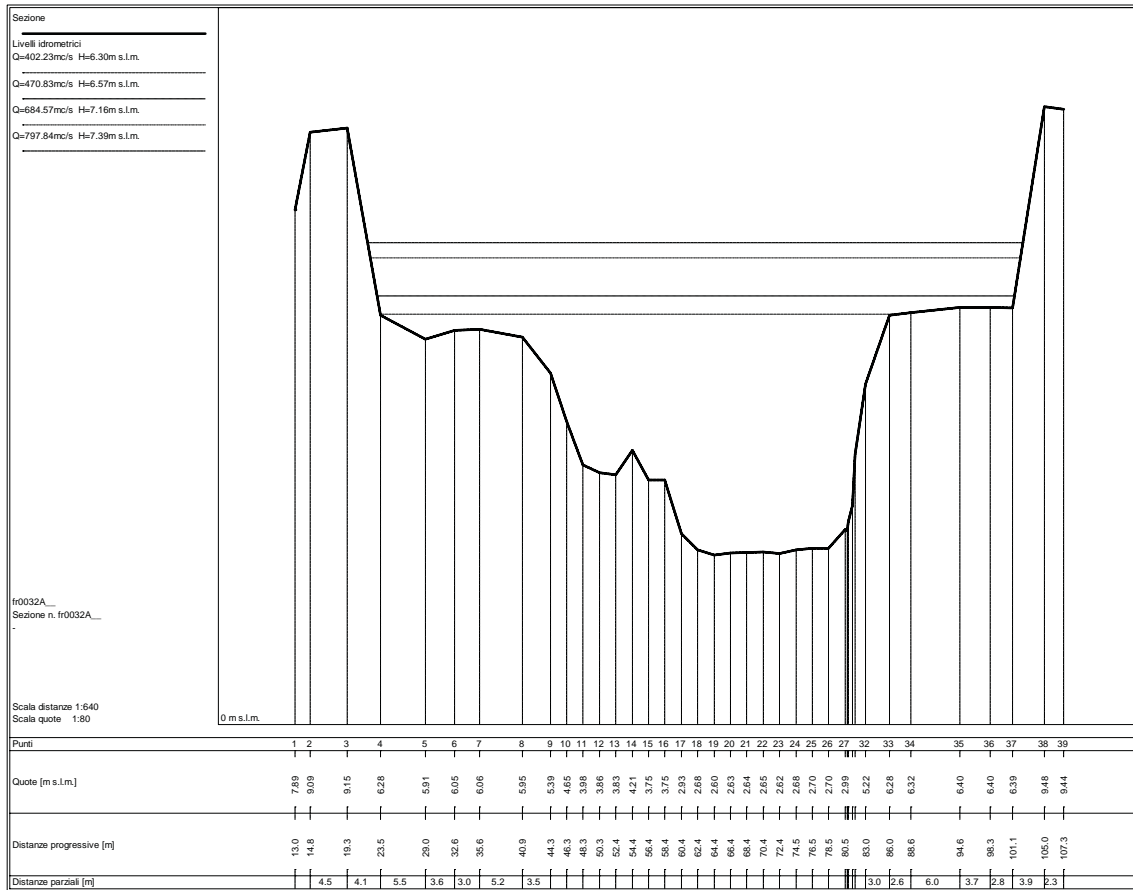

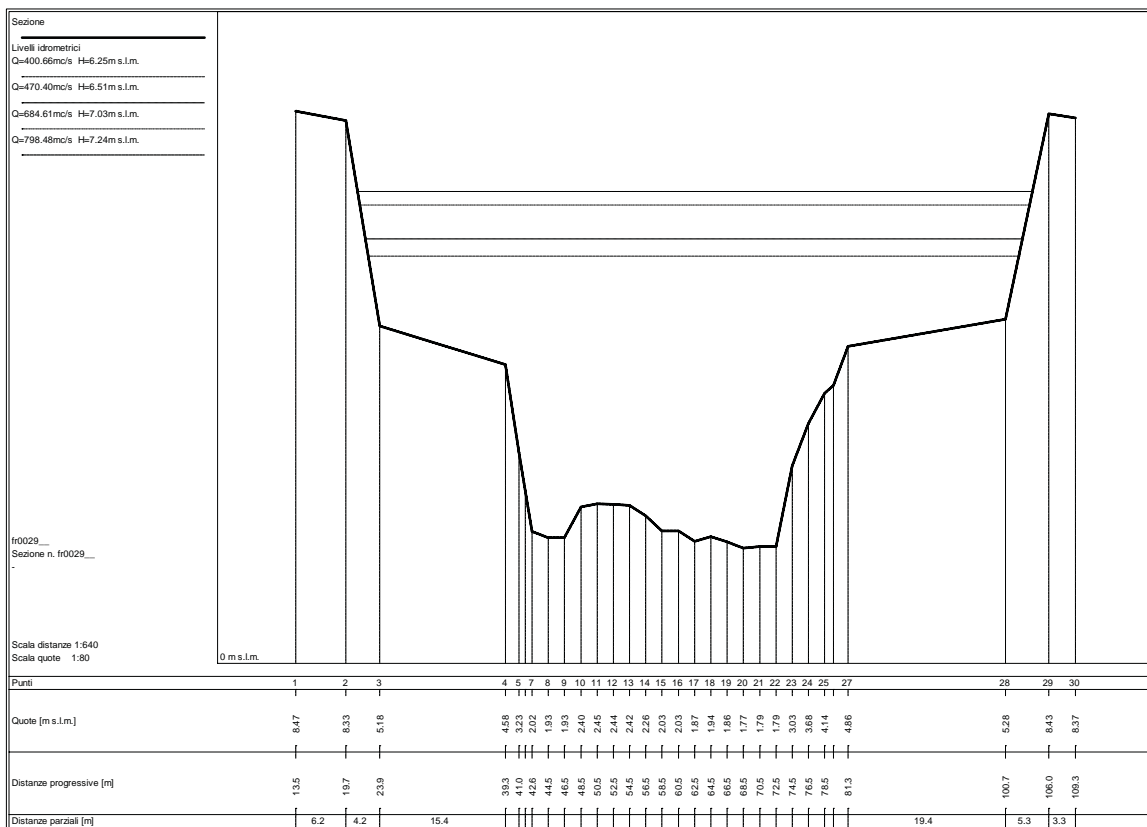
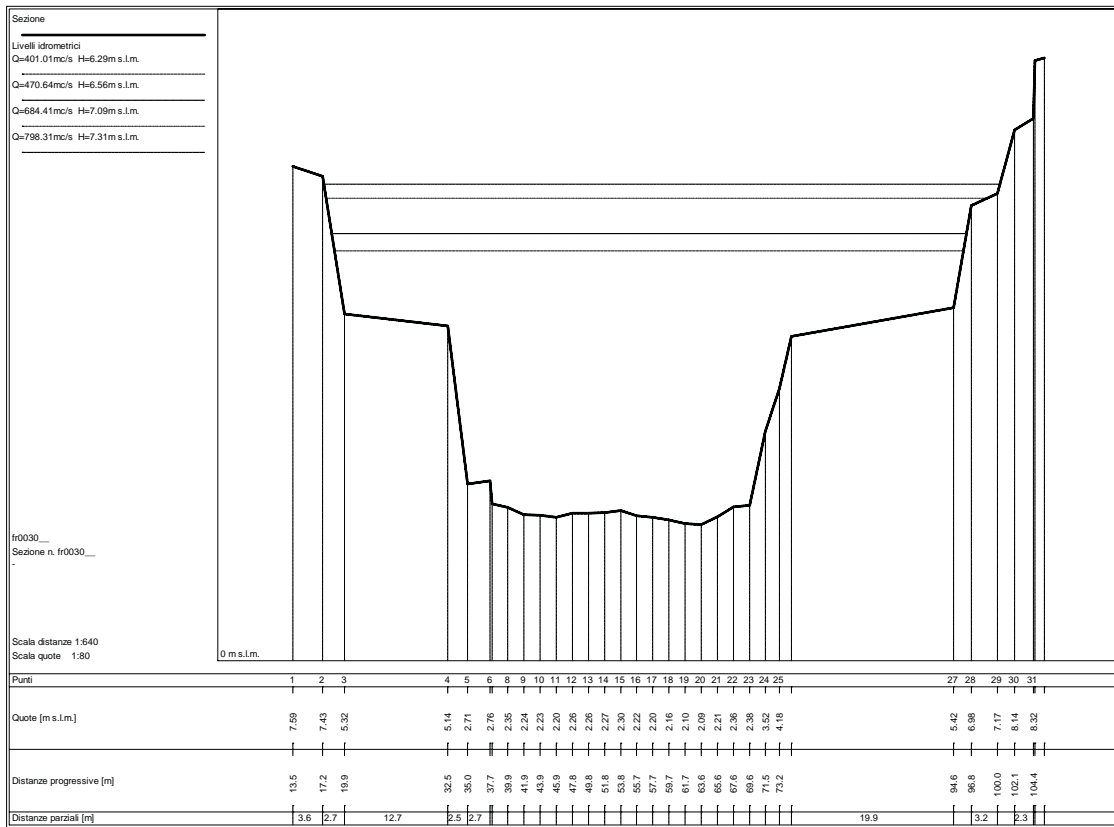

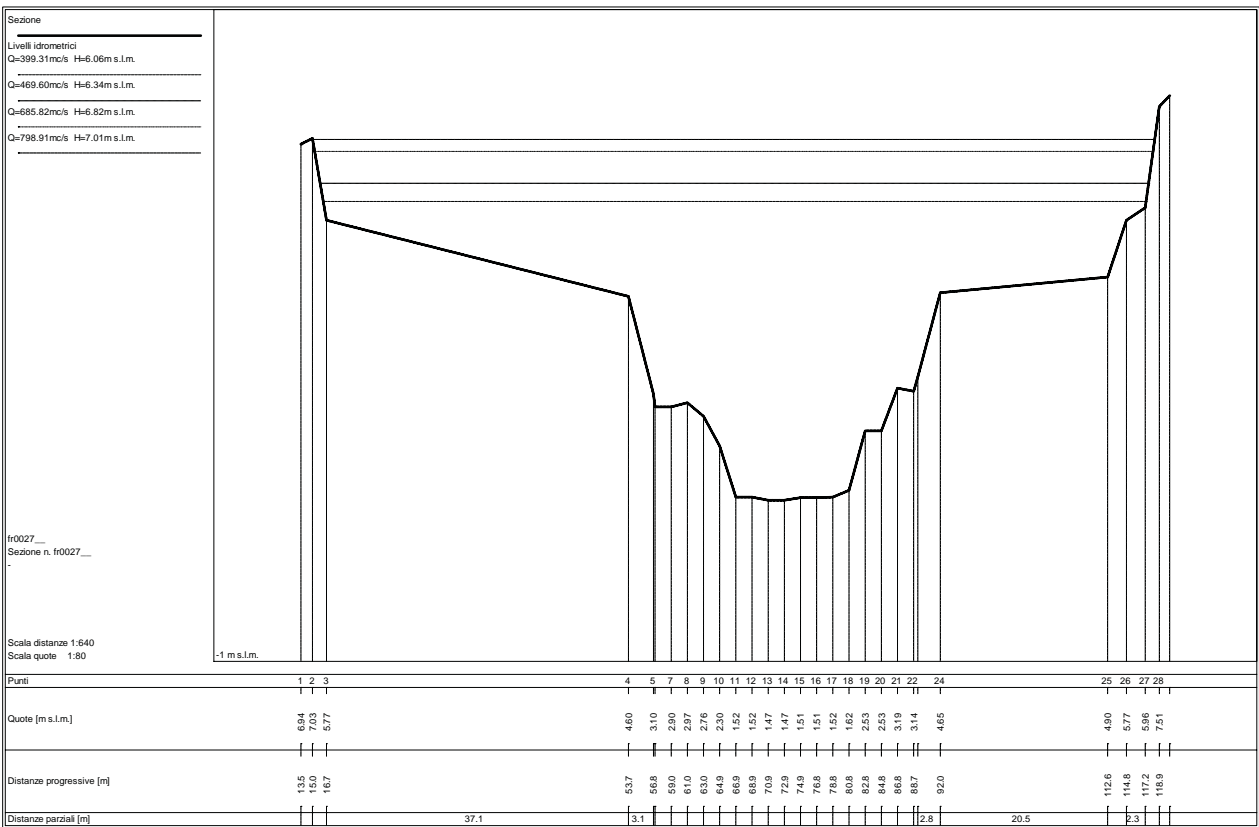
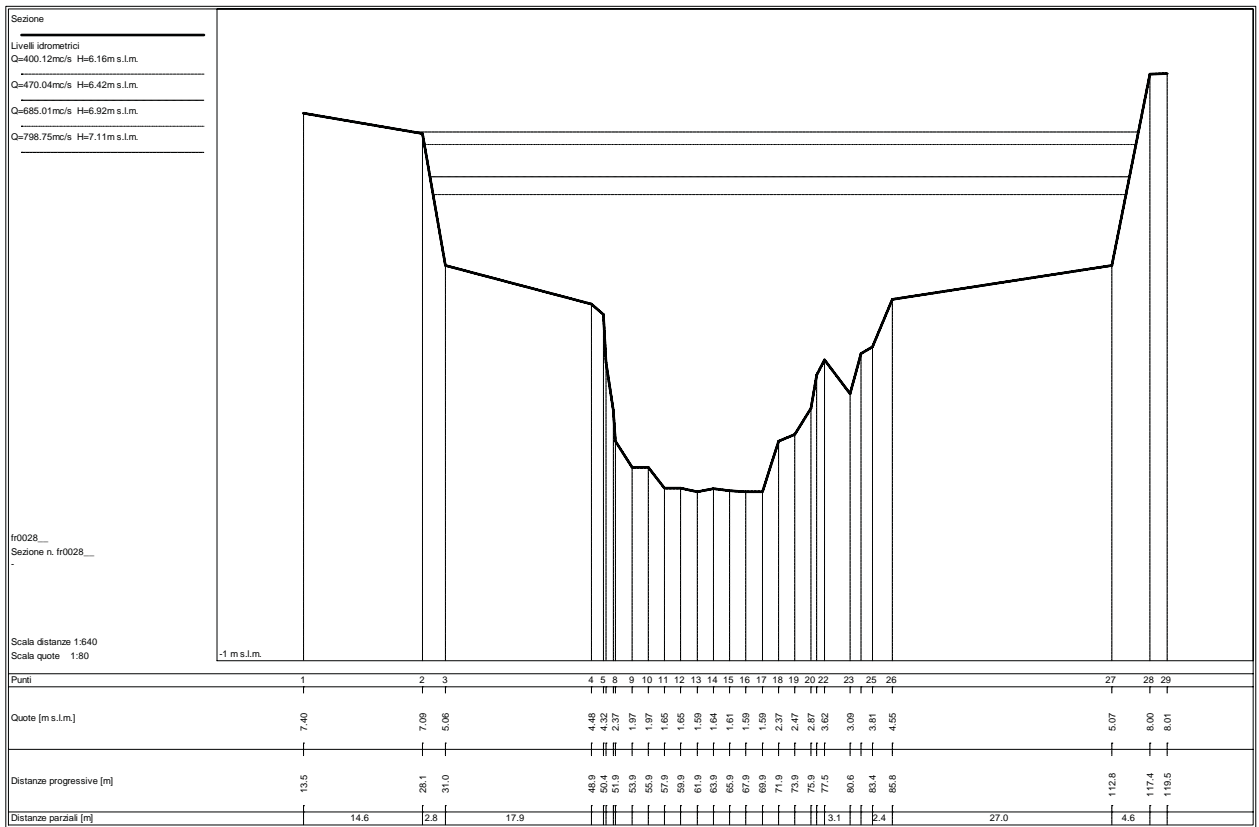

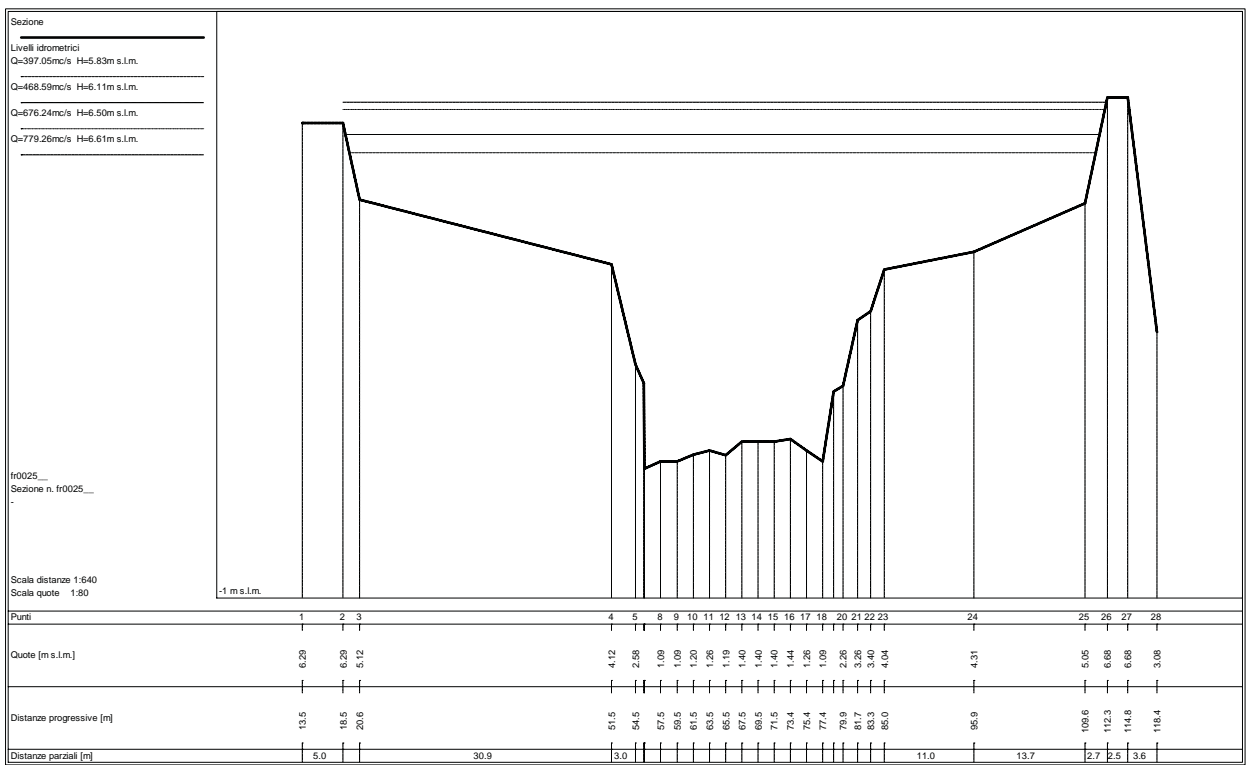
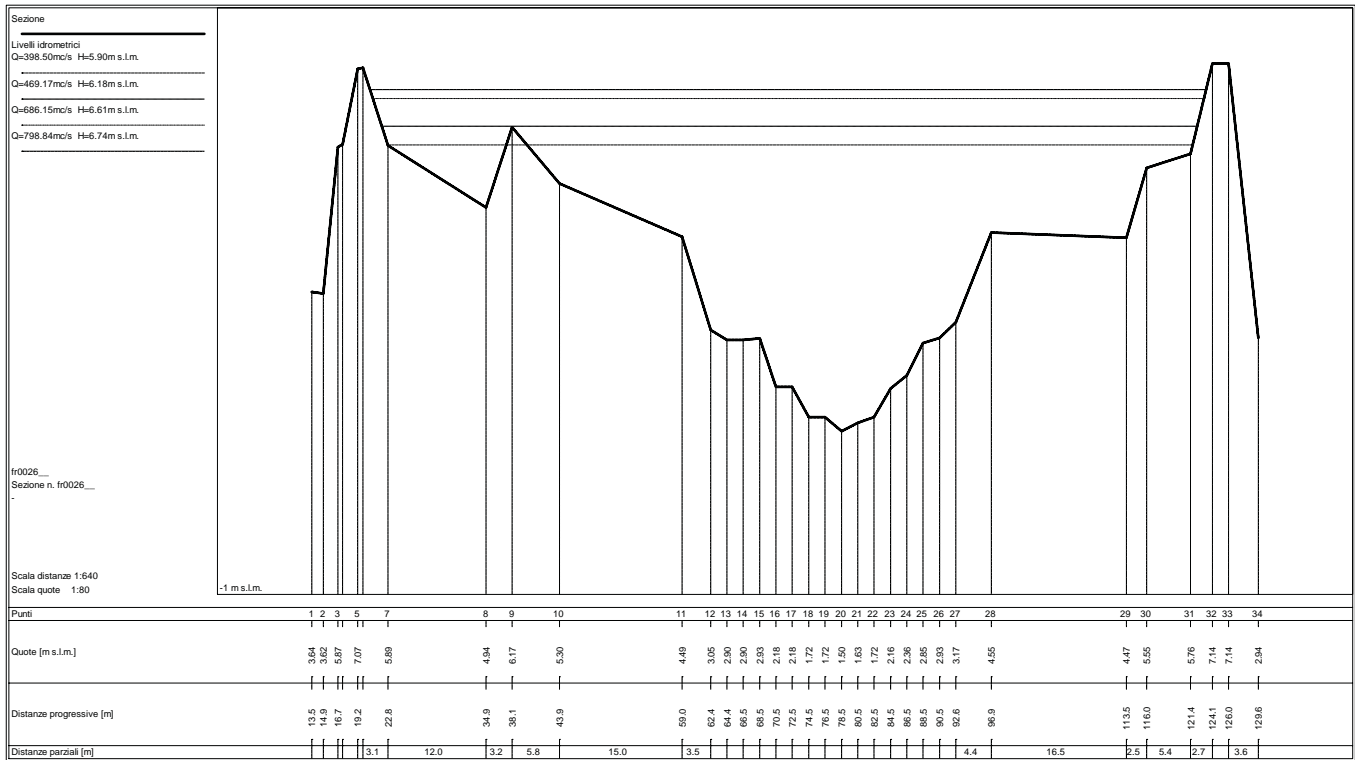

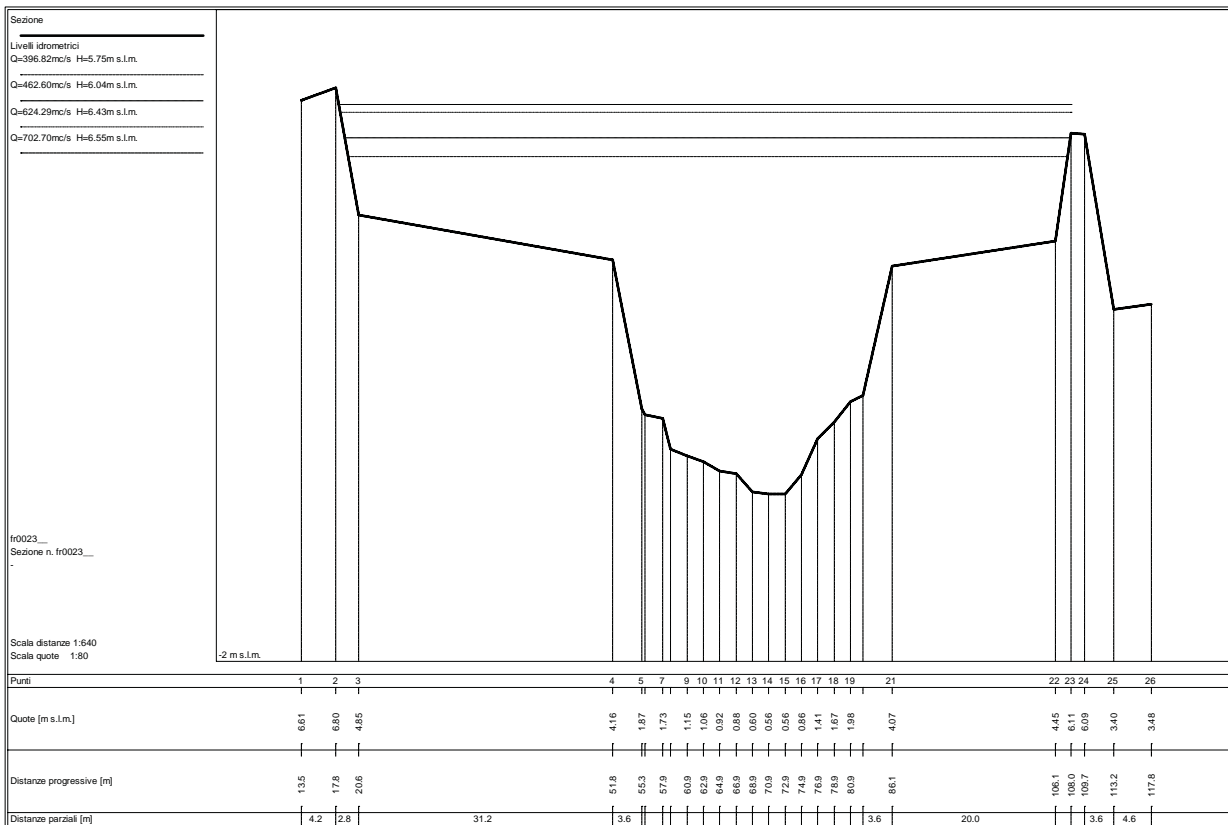
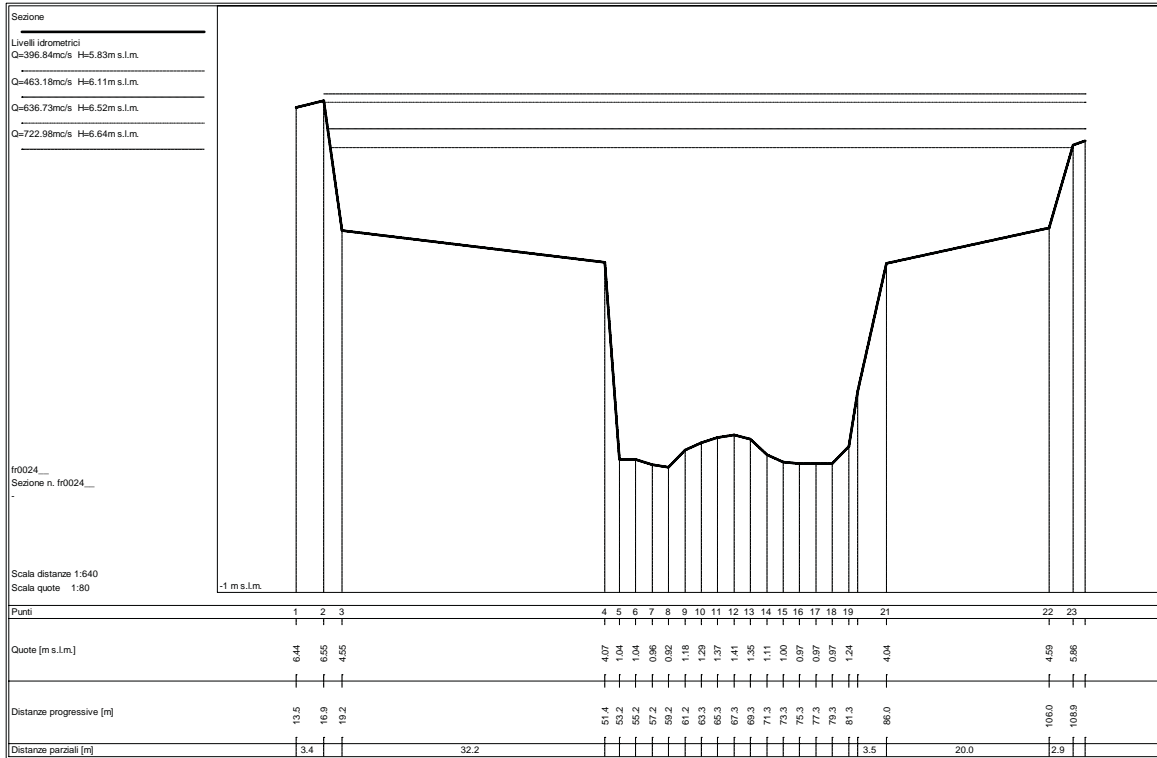

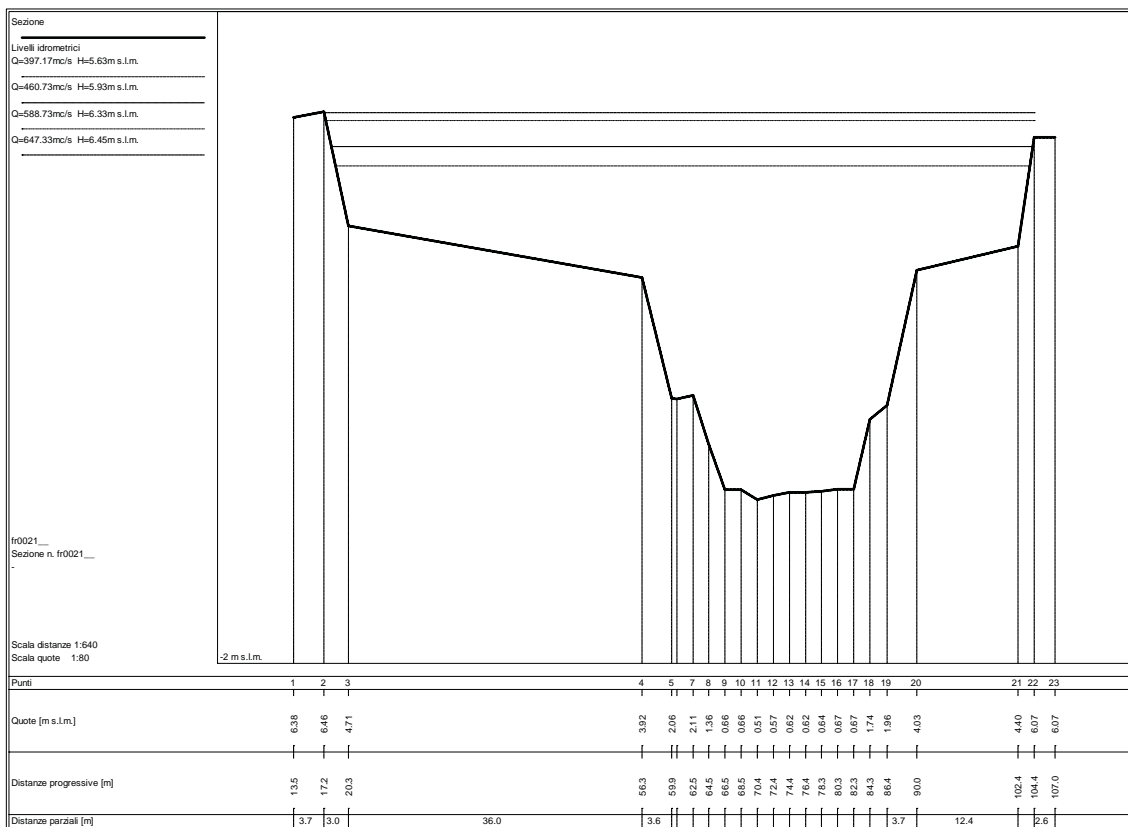
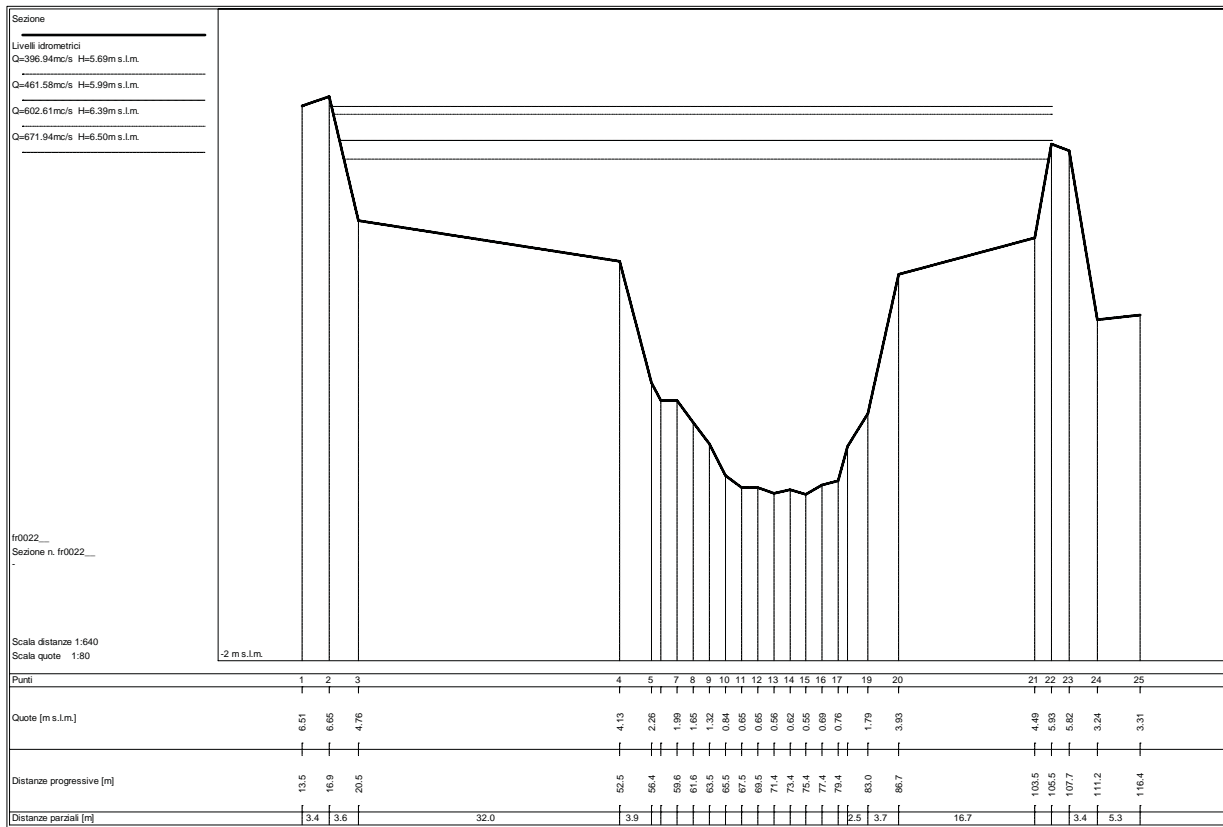

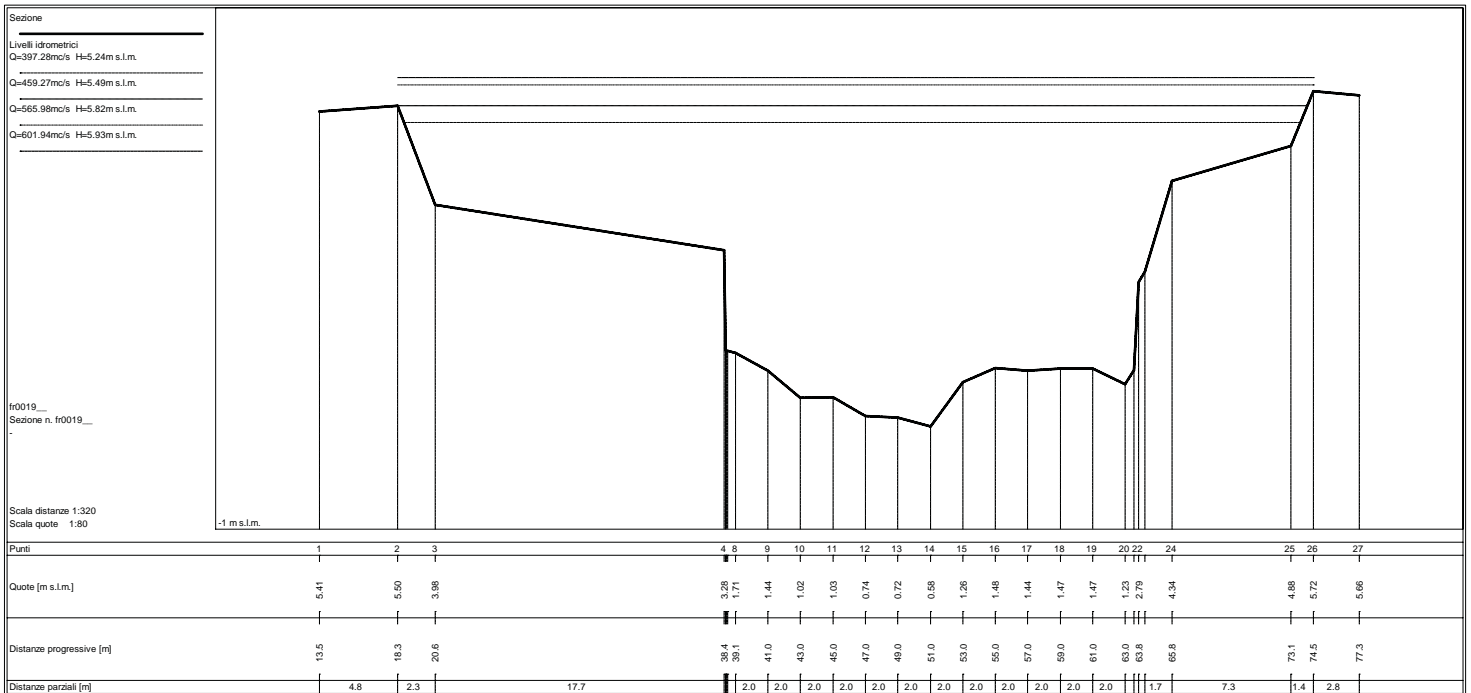
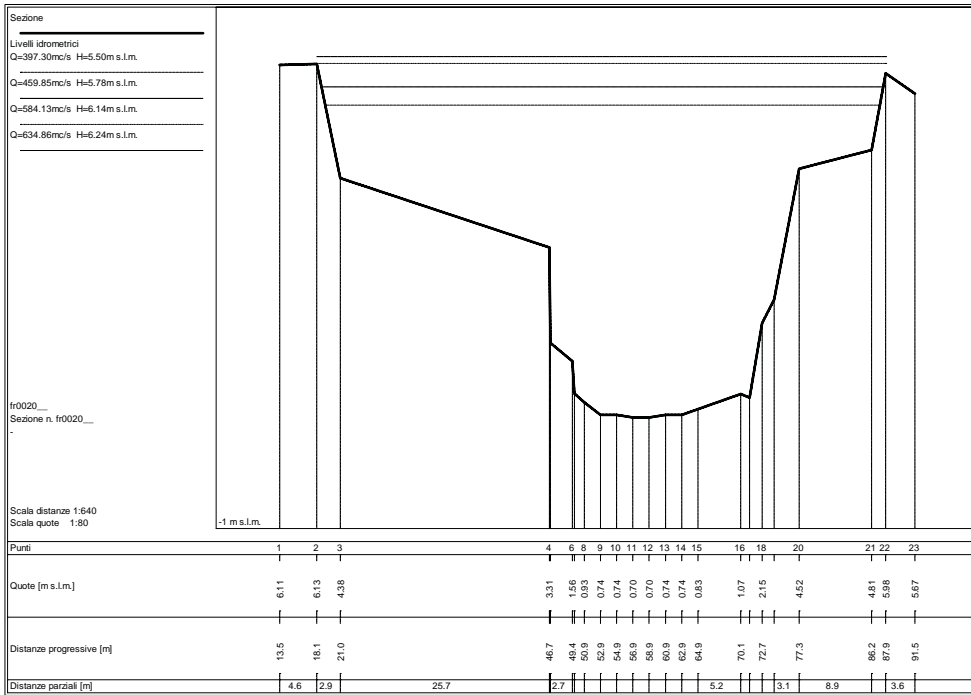

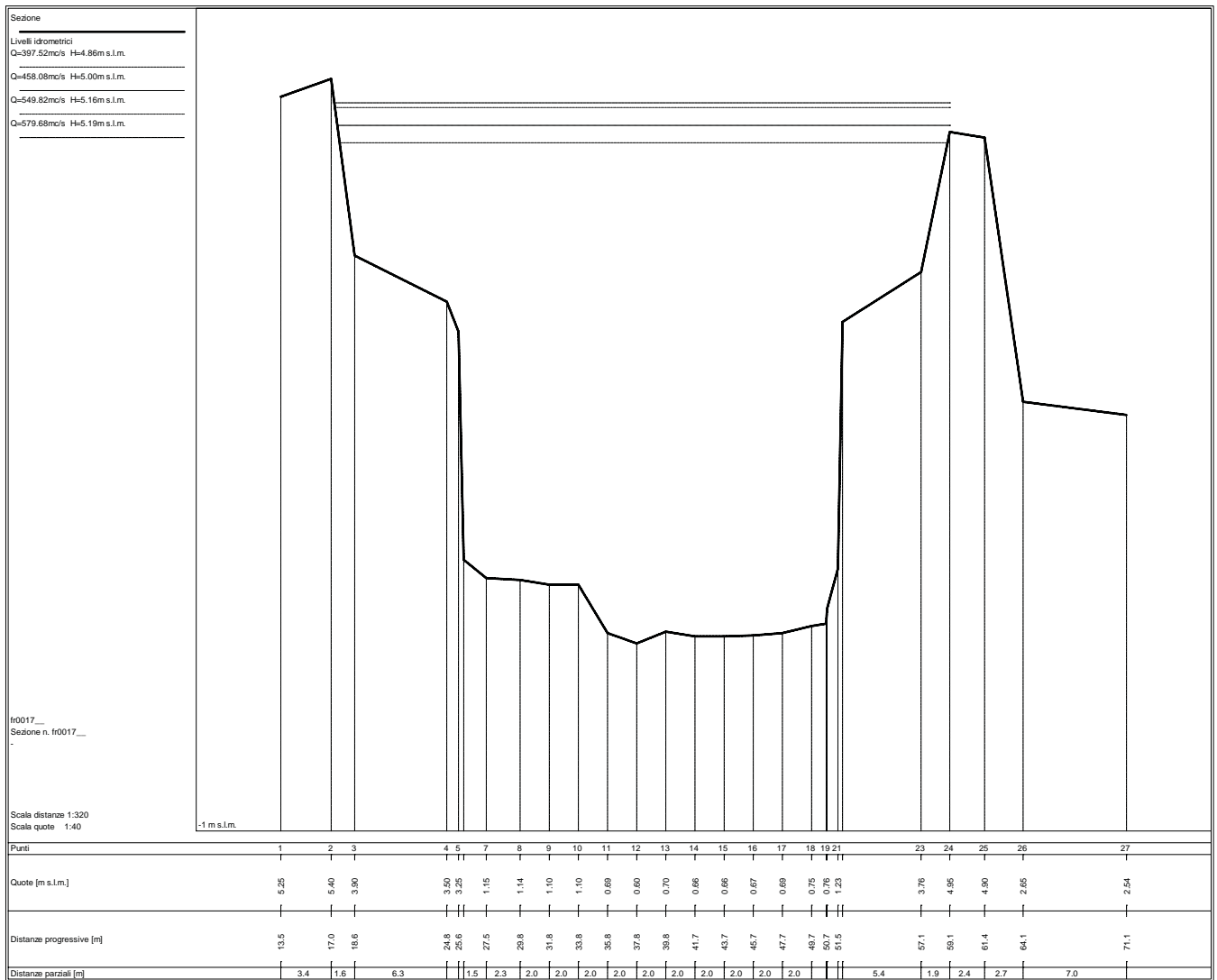
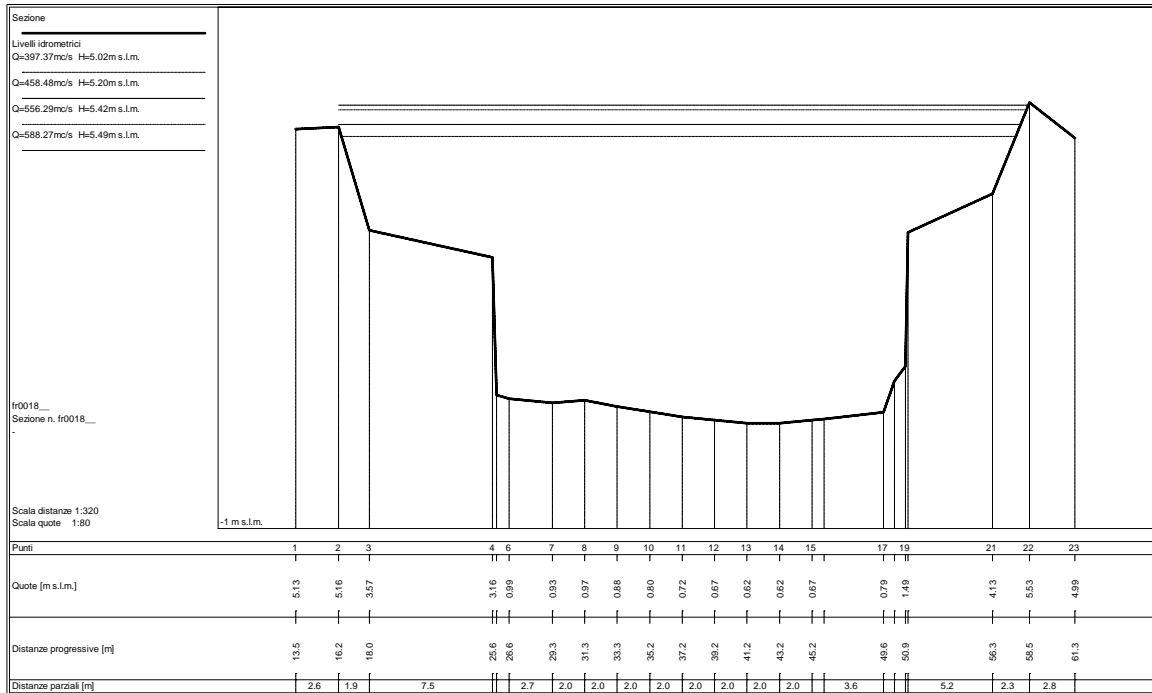

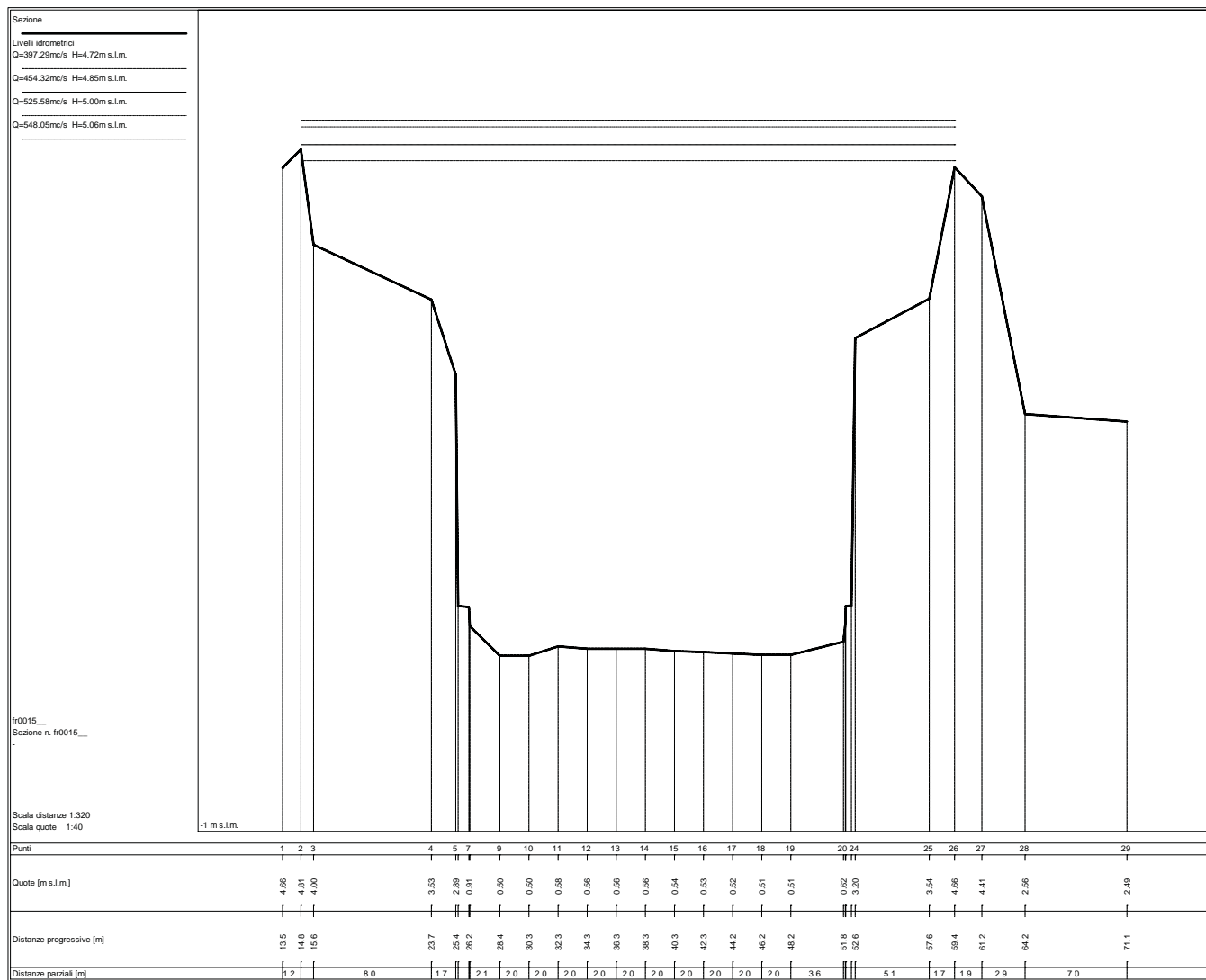
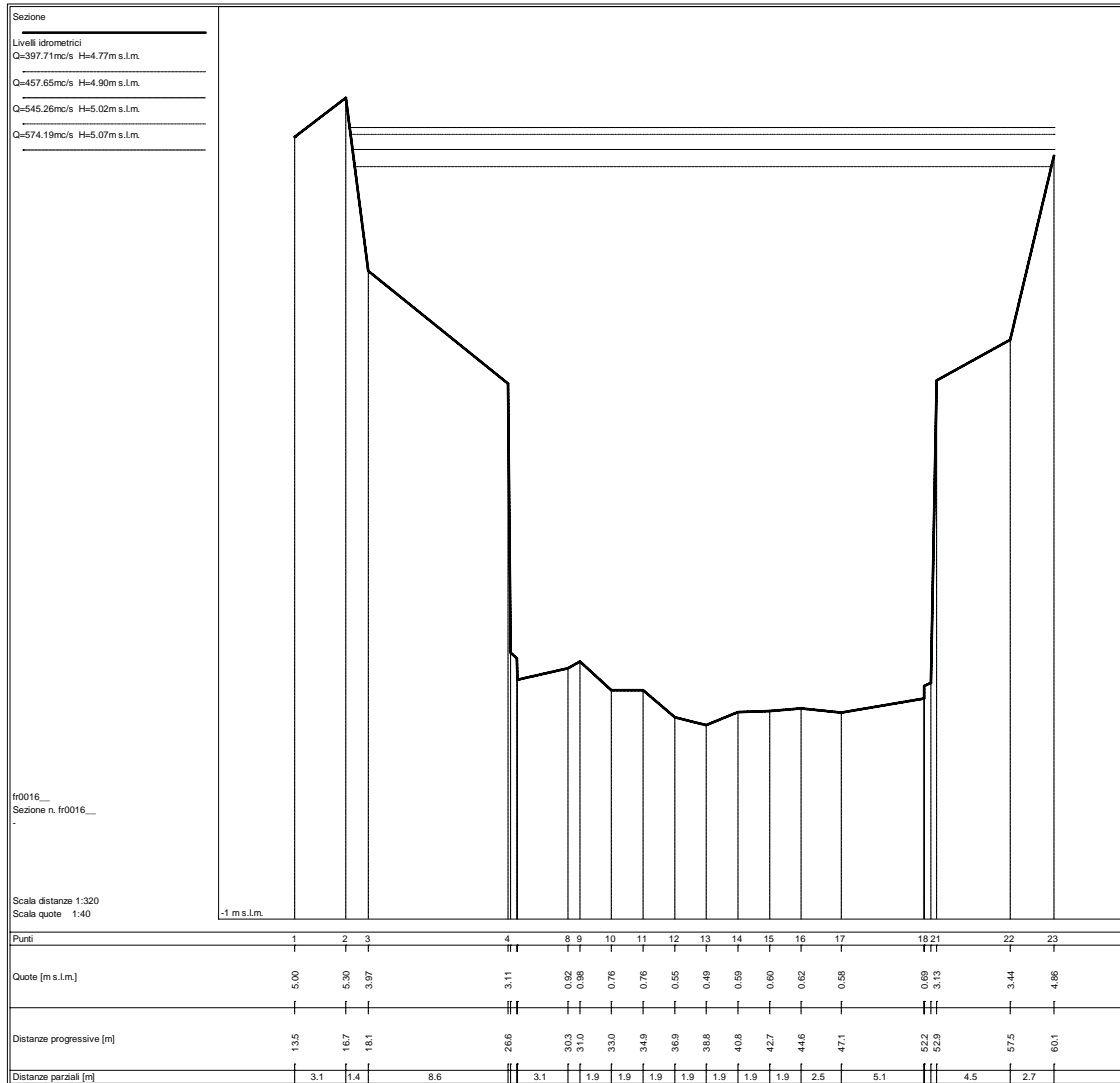

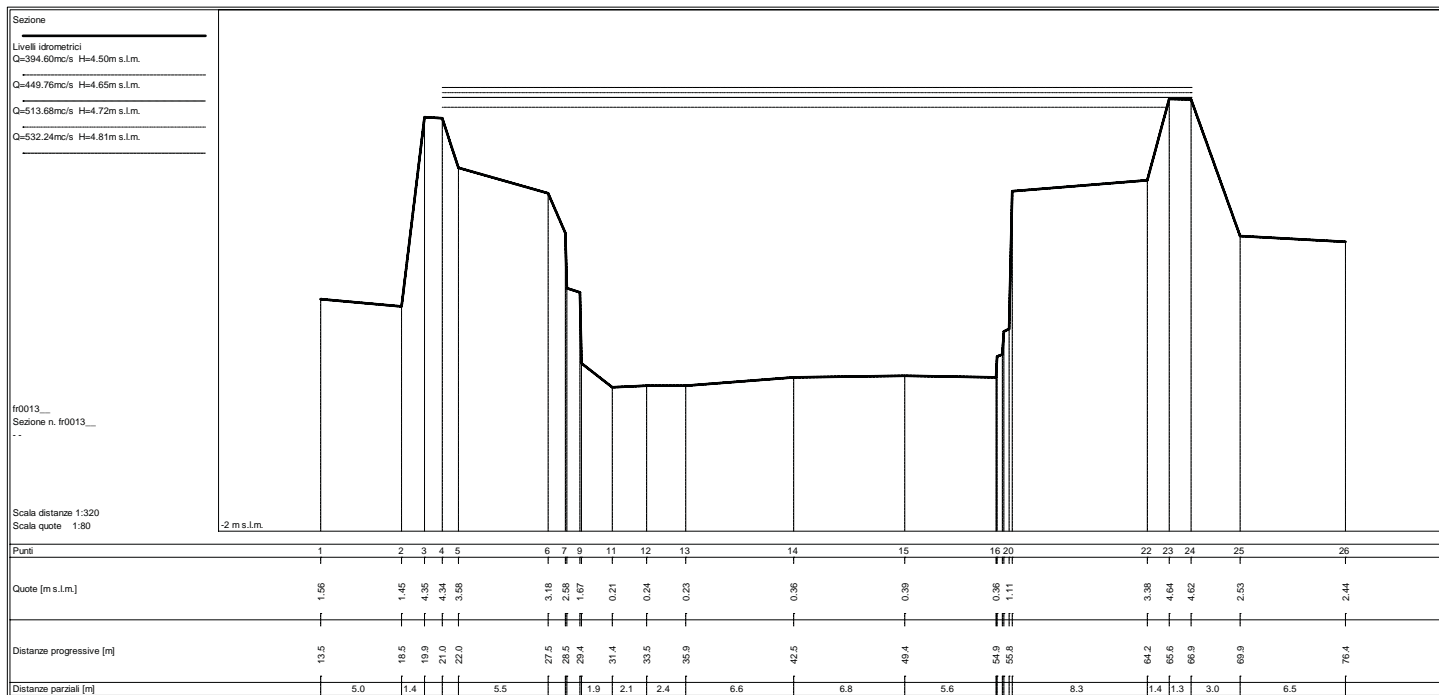
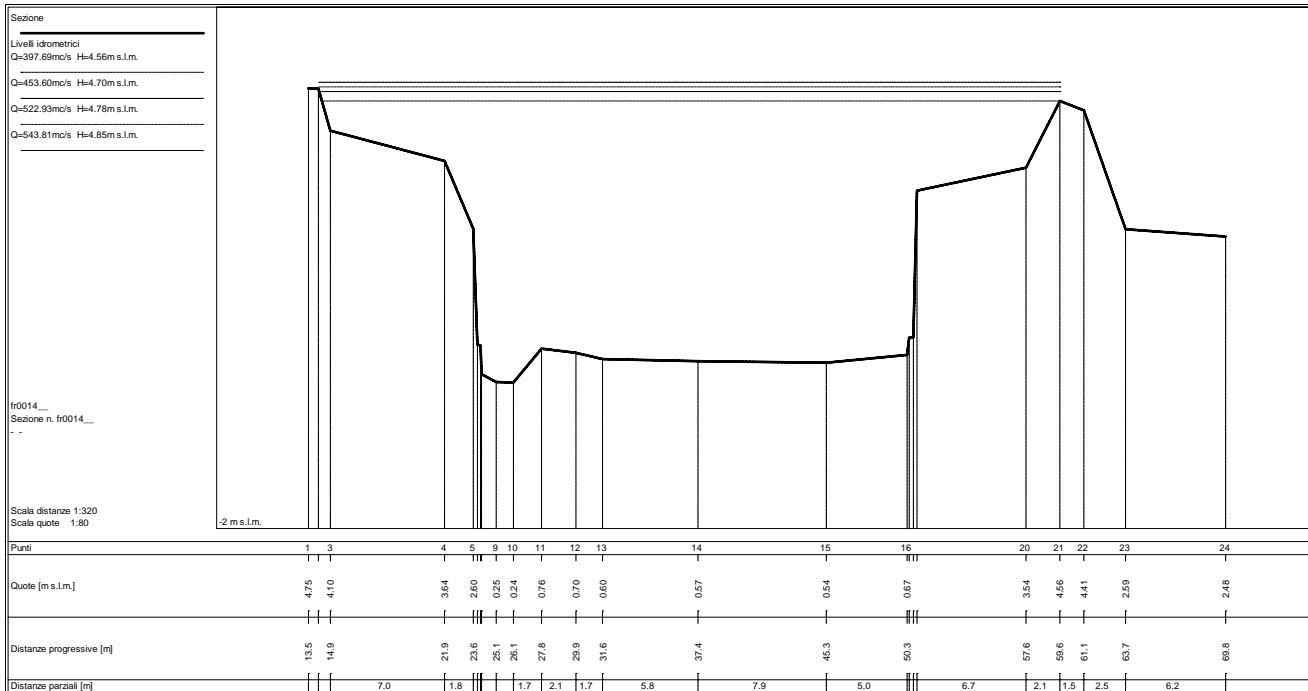

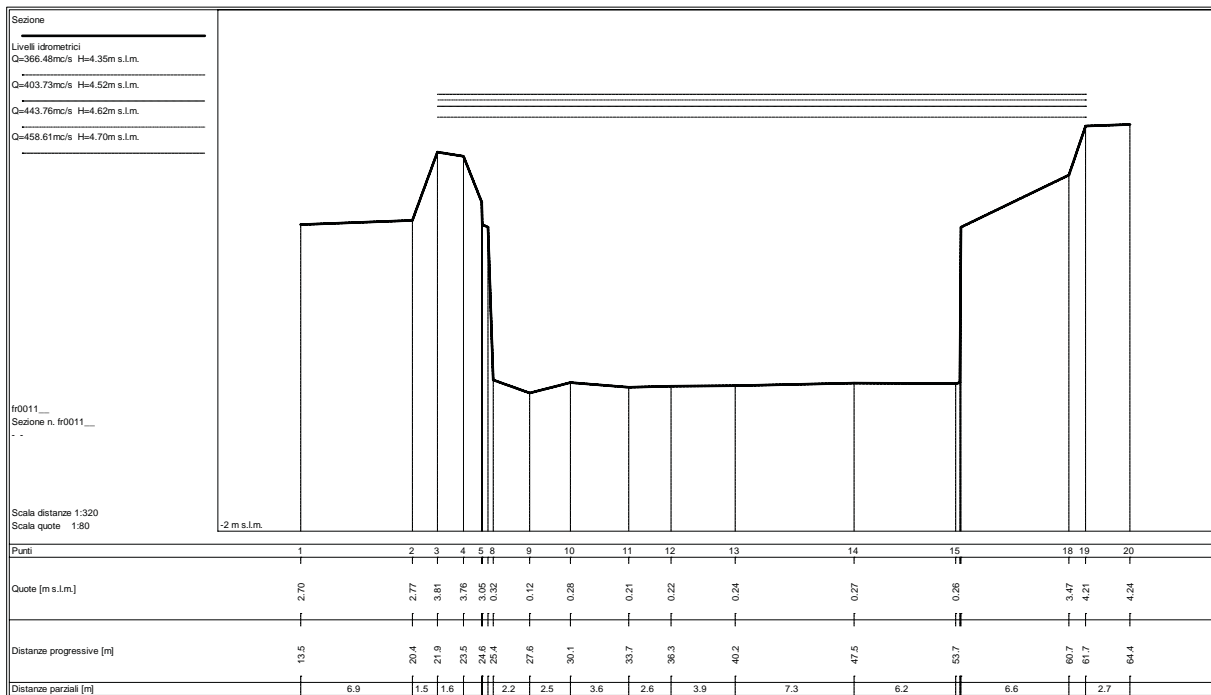
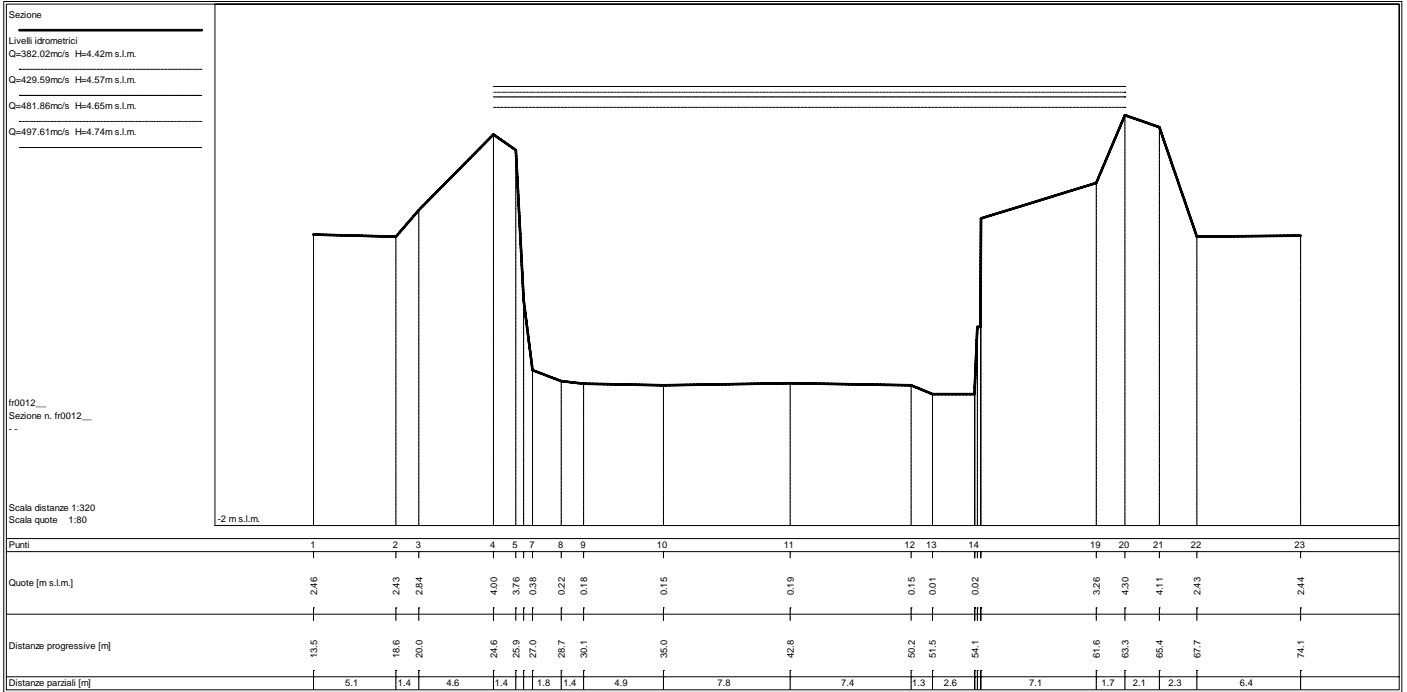

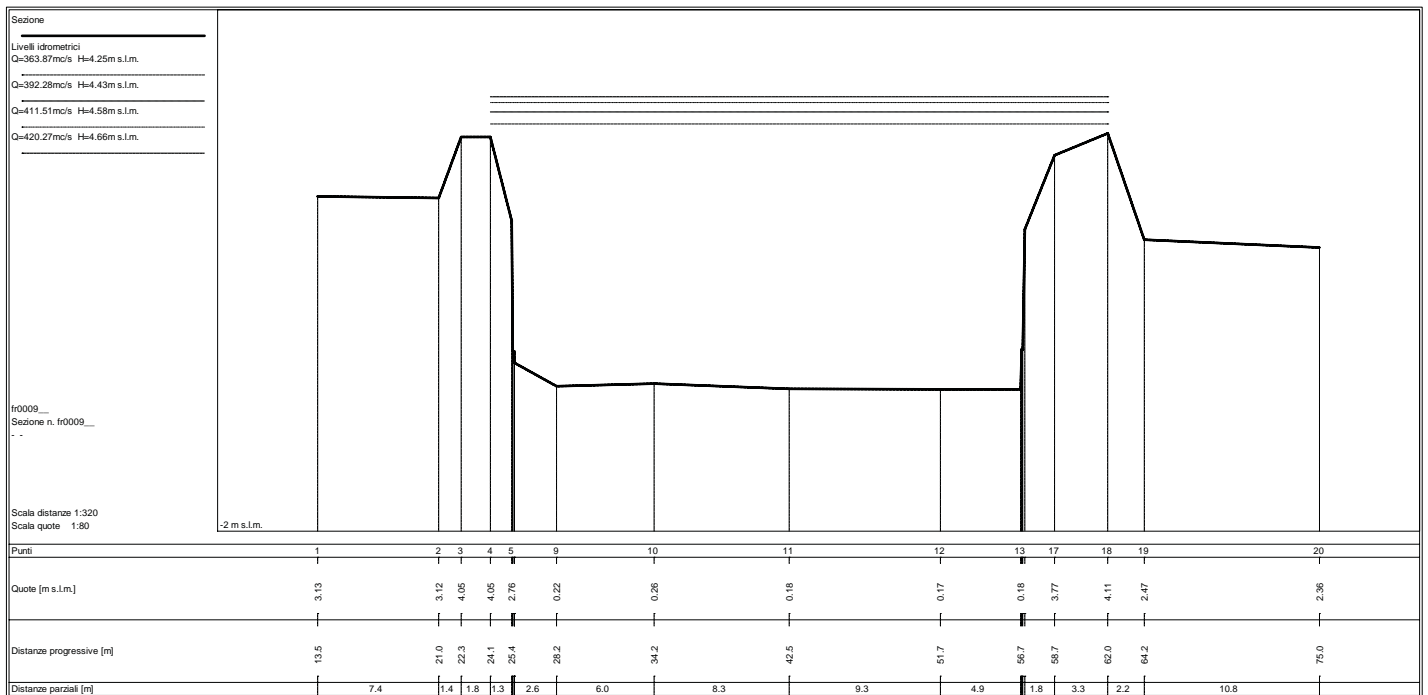
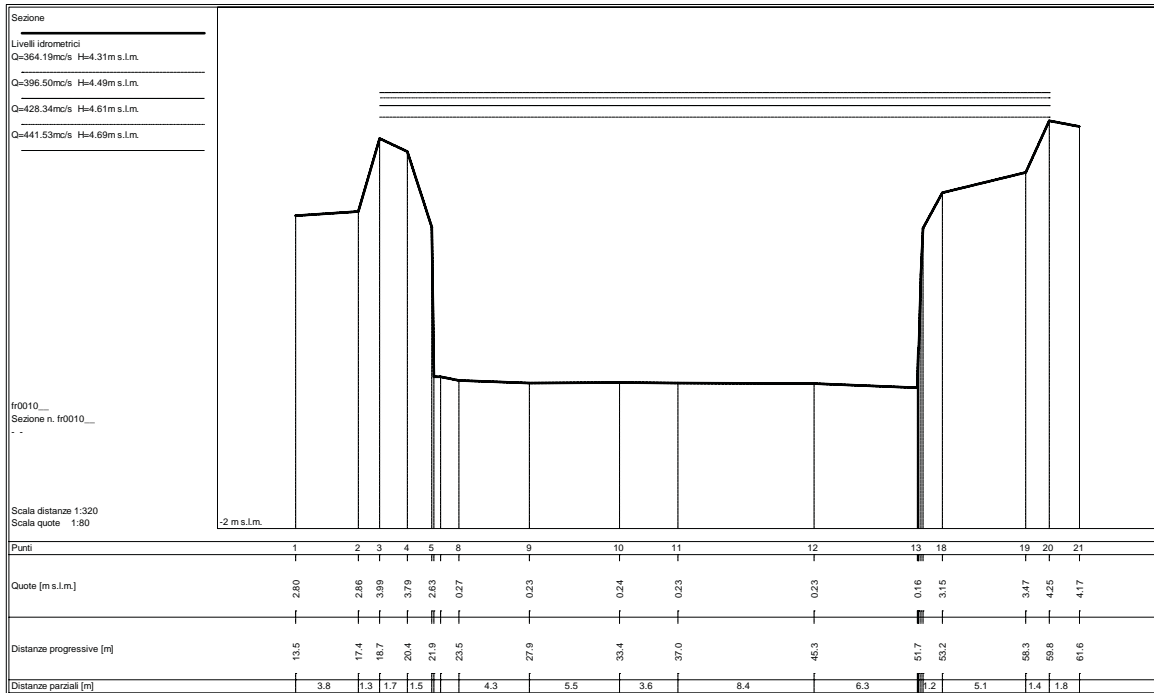

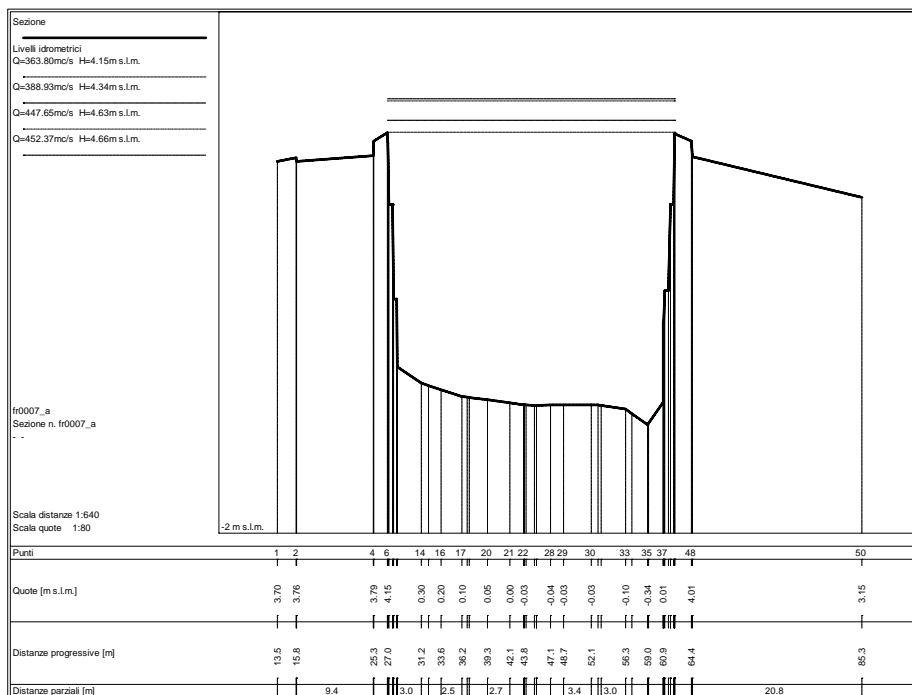
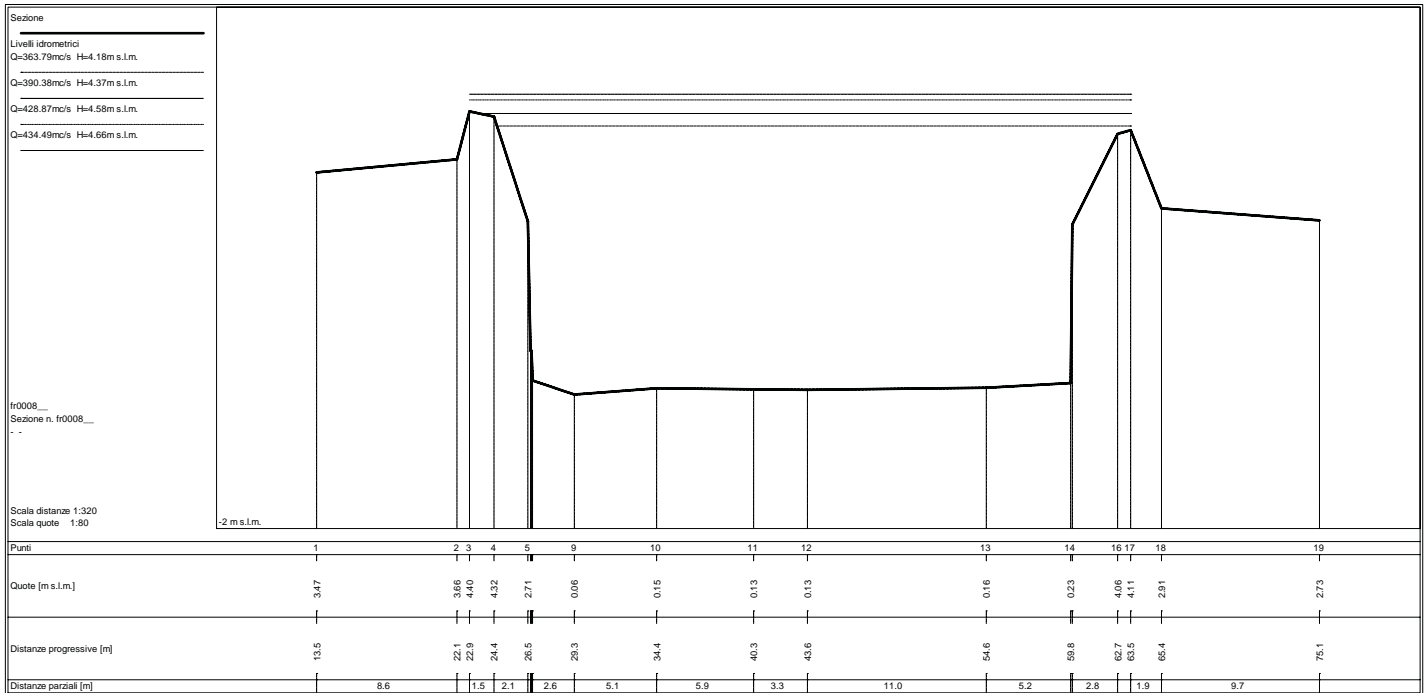

Sezione
 Ponte
 Livelli idrometrici
 Q=363.81mc/s H=3.80m s.l.m.
 Q=388.90mc/s H=3.94m s.l.m.
 Q=448.05mc/s H=4.17m s.l.m.
 Q=452.76mc/s H=4.19m s.l.m.

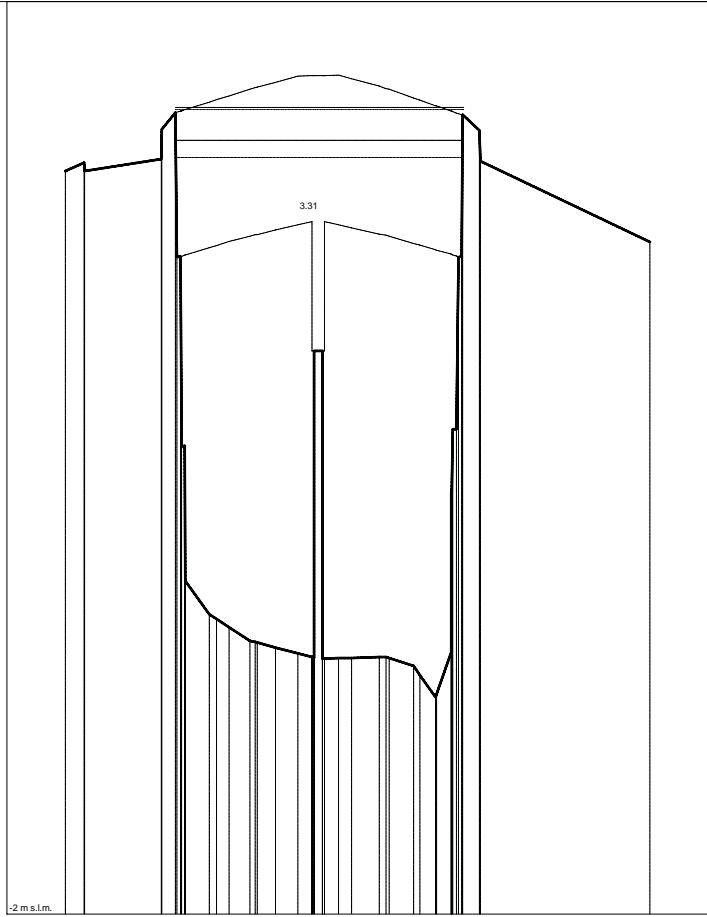

fr0007_b
 Sezione n. fr0007_b

Scala distanze 1:640
 Scala quote 1:40

Punti	1	2	4	6	13	15	16	19	20	21	29	30	31	34	36	38	46	48
Quote [m s.l.m.]	3.70	3.76	3.79	4.15	0.30	0.20	0.10	0.05	0.00	-0.03	-0.04	-0.03	-0.03	-0.10	-0.34	0.01	4.01	3.15
Distanze progressive [m]	13.5	15.8	25.3	27.0	31.2	33.6	36.2	39.3	42.1	43.8	47.1	48.7	52.1	56.3	59.0	60.9	64.4	85.3
Distanze parziali [m]			9.4	3.0	2.5	2.5	2.7	2.7	2.7	3.4	3.0	3.0	3.0	3.0	3.0	3.0	20.8	

Sezione
 Ponte
 Livelli idrometrici
 Q=363.81mc/s H=3.75m s.l.m.
 Q=388.90mc/s H=3.88m s.l.m.
 Q=448.05mc/s H=4.13m s.l.m.
 Q=452.77mc/s H=4.13m s.l.m.

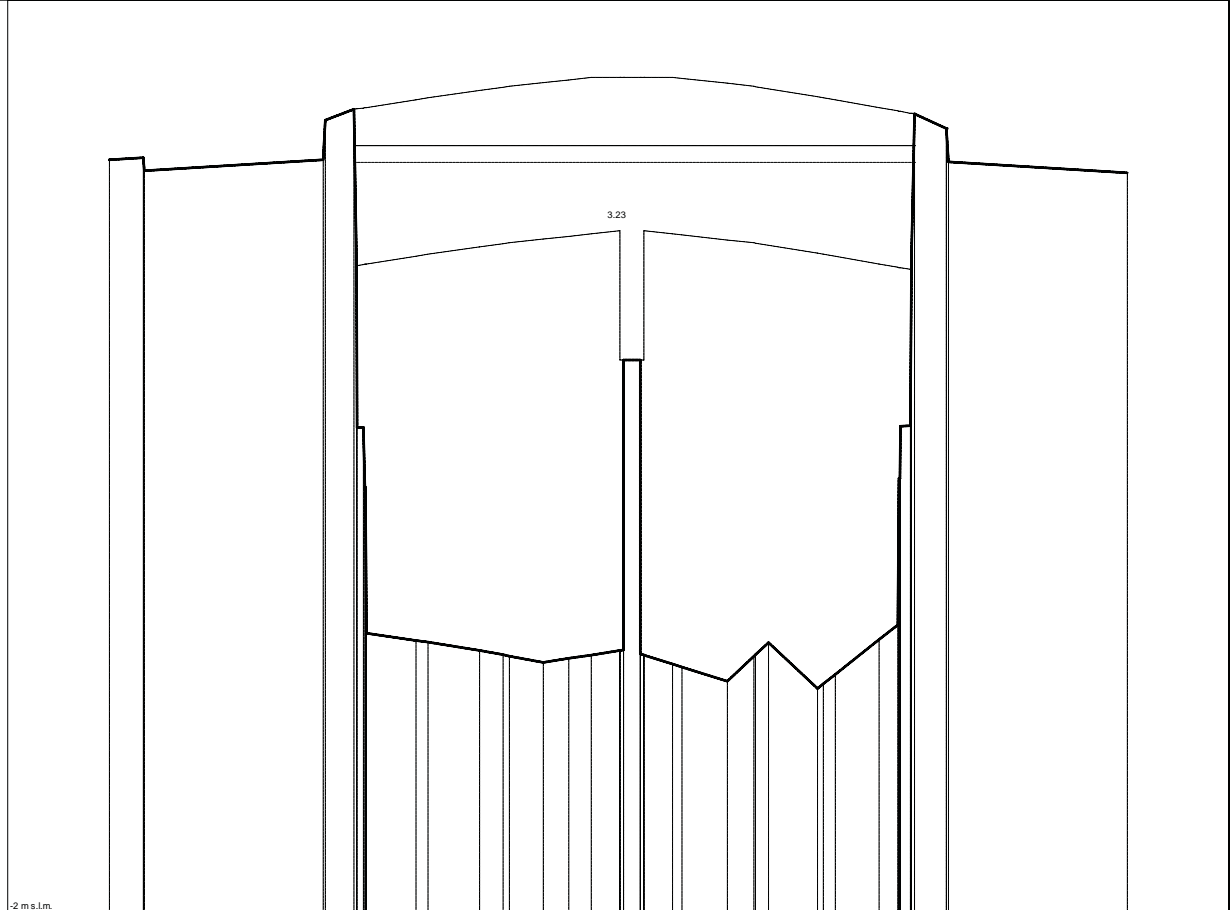

fr0006_c
 Sezione n. fr0006_c

Scala distanze 1:320
 Scala quote 1:40

Punti	1	2	4	6	13	15	16	18	19	20	21	25	29	31	32	34	35	37	38	39	43	47	50
Quote [m s.l.m.]	3.78	3.79	3.78	4.17	0.09	0.01	-0.02	-0.08	-0.05	-0.02	0.01	2.24	-0.09	-0.23	-0.03	0.07	-0.28	-0.17	0.10	0.21	1.73	4.02	3.88
Distanze progressive [m]	13.5	15.6	26.7	28.6	32.3	36.2	37.7	40.1	41.7	43.1	44.8	46.1	48.1	51.5	53.1	54.0	57.0	58.1	60.8	61.9	62.7	64.9	76.0
Distanze parziali [m]		2.1	11.0	1.8	3.1	3.2	1.4	2.1	1.6	1.4	1.8	1.7	2.8	1.6	3.0	3.0	2.7	2.7	60.8	0.21	2.0	11.0	

Sezione
 Livelli idrometrici
 Q=363.81mc/s H=3.88m s.l.m.
 Q=388.91mc/s H=3.95m s.l.m.
 Q=447.88mc/s H=4.10m s.l.m.
 Q=452.61mc/s H=4.16m s.l.m.

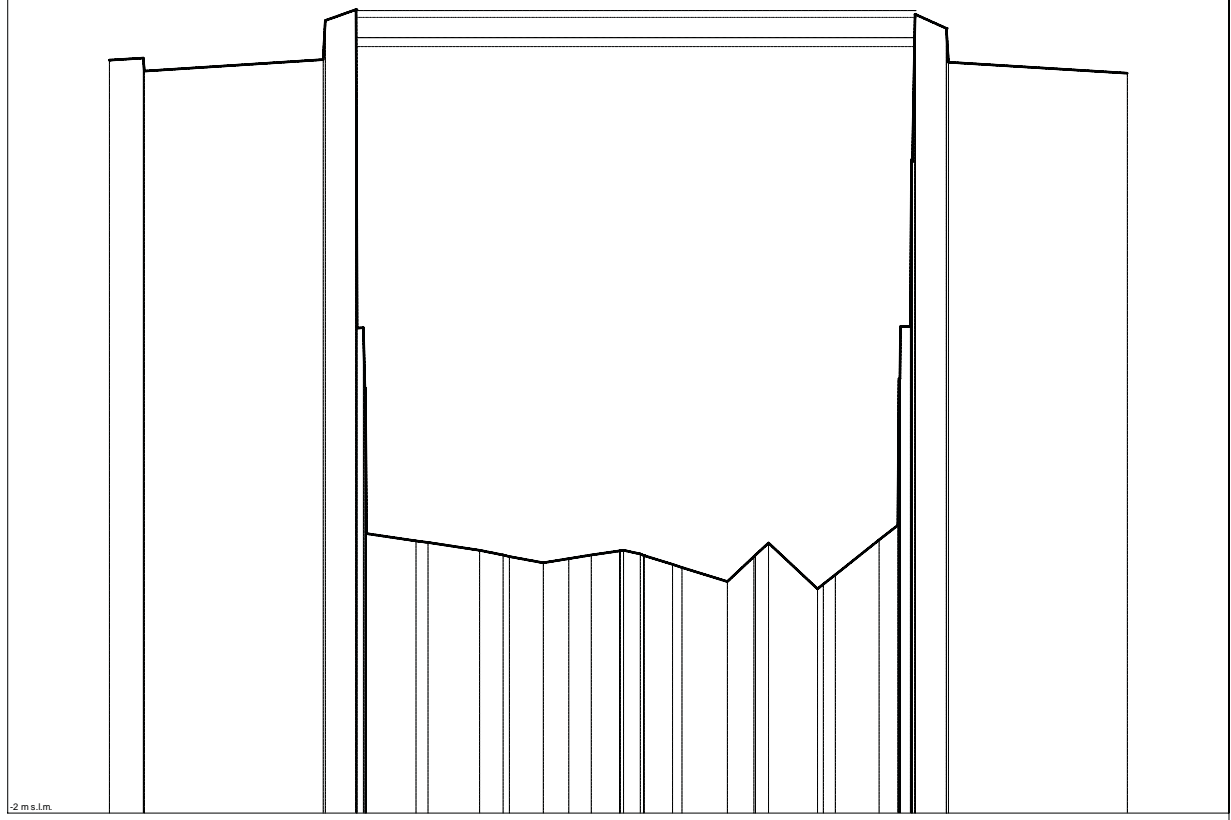

fr0006_d
 Sezione n. fr0006_d
 - -
 Scala distanze 1:320
 Scala quote 1:40

Punti	1	2	4	6	14	16	17	19	20	21	22	25	28	30	31	33	34	36	37	38	42	48	51
Quote [m s.l.m.]	3.78	3.79	3.78	4.17	0.09	0.01	-0.02	-0.08	-0.05	-0.02	0.01	-0.01	-0.09	-0.23	-0.03	0.07	-0.28	-0.17	0.10	0.21	1.73	4.02	3.68
Distanze progressive [m]	13.5	15.6	26.7	28.7	32.3	36.2	37.7	40.1	41.7	43.1	44.8	46.1	48.1	51.5	53.1	54.0	57.0	58.1	60.8	61.9	62.7	64.9	76.0
Distanze parziali [m]	2.1	11.0	1.9	3.1	3.2	1.4	2.1	1.6	1.4	1.8	1.7	2.8	1.6	3.0	2.7	1.9	11.0	76.0					

Sezione
 Livelli idrometrici
 Q=363.20mc/s H=3.87m s.l.m.
 Q=387.19mc/s H=3.95m s.l.m.
 Q=432.94mc/s H=4.11m s.l.m.
 Q=437.03mc/s H=4.17m s.l.m.

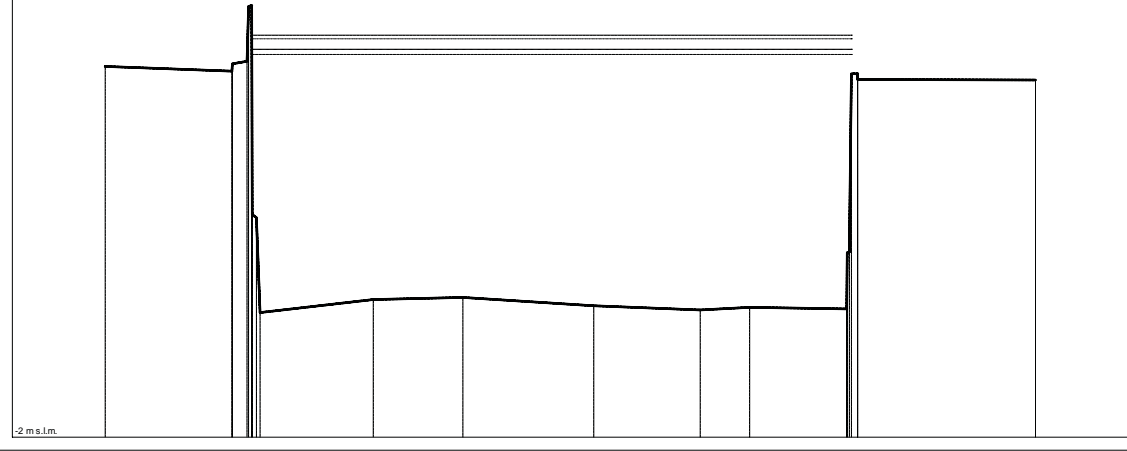

fr0005_
 Sezione n. fr0005_
 - -
 Scala distanze 1:320
 Scala quote 1:80

Punti	1	2	4	9	10	11	12	13	14	15	21
Quote [m s.l.m.]	3.69	3.62	3.77	-0.09	0.11	0.14	0.01	-0.05	-0.01	-0.04	3.48
Distanze progressive [m]	13.5	21.3	22.2	23.0	30.0	35.5	43.5	50.0	53.1	59.0	70.6
Distanze parziali [m]	7.8	6.9	5.5	8.1	6.5	3.0	5.9	10.9	70.6		

Sezione
 Livelli idrometrici
 Q=363.17mc/s H=3.81m s.l.m.
 Q=387.38mc/s H=3.89m s.l.m.
 Q=419.30mc/s H=4.07m s.l.m.
 Q=423.93mc/s H=4.13m s.l.m.

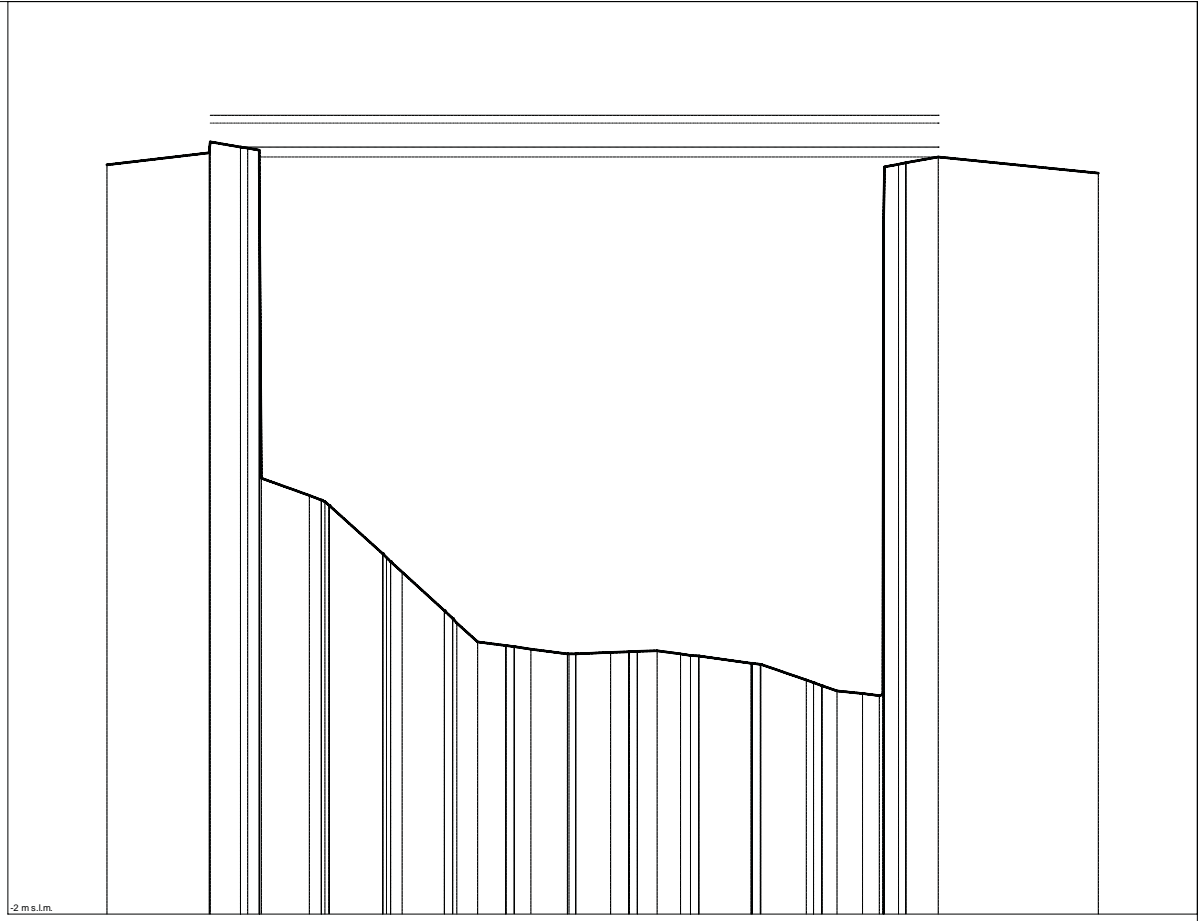

fr0004_a
 Sezione n. fr0004_a

Scala distanze 1:320
 Scala quote 1:40

-2 m.s.l.m.

Punti	1	2	4	7	11	14	17	22	23	27	28	29	33	34	39	40	44	45	48	50	56	59	61	62	63	69	72	73
Quote [m s.l.m.]	3.75	3.84	3.89	3.86	1.21	1.17	0.76	0.63	0.33	0.23	0.09	0.06	0.03	0.00	0.01	0.01	0.02	0.00	-0.02	-0.07	-0.21	-0.25	-0.29	-0.31	-0.32	3.75	3.81	3.88
Distanze progressive [m]	13.5	19.8	21.7	22.9	25.9	26.9	30.5	31.7	34.2	35.0	36.3	38.0	39.6	41.8	44.4	45.6	47.3	48.7	49.8	53.1	56.4	57.4	58.3	59.9	60.9	62.1	64.5	74.4
Distanze parziali [m]	6.3	1.9	2.9	3.3	2.6	1.3	1.7	2.2	2.1	1.2	1.4	1.8	2.2	2.1	1.2	1.4	1.4	1.8	3.2	2.8	1.6	1.6	1.6	1.6	2.0	9.8		

Sezione
 Ponte
 Livelli idrometrici
 Q=363.17mc/s H=3.54m s.l.m.
 Q=387.38mc/s H=3.58m s.l.m.
 Q=419.10mc/s H=3.68m s.l.m.
 Q=423.73mc/s H=3.69m s.l.m.

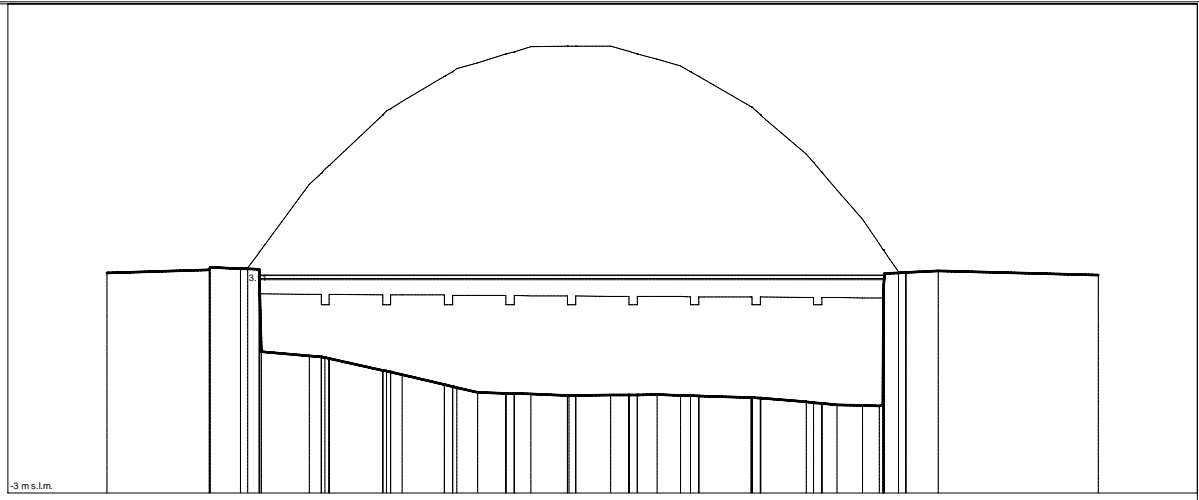

fr0004_b
 Sezione n. fr0004_b

Scala distanze 1:320
 Scala quote 1:160

-3 m.s.l.m.

Punti	1	2	4	7	11	14	17	22	23	27	28	29	33	34	39	40	44	45	48	50	56	59	61	62	63	69	72	73
Quote [m s.l.m.]	3.75	3.84	3.89	3.86	1.21	1.17	0.76	0.63	0.33	0.23	0.09	0.06	0.03	0.00	0.01	0.01	0.02	0.00	-0.02	-0.07	-0.20	-0.25	-0.29	-0.31	-0.32	3.75	3.81	3.88
Distanze progressive [m]	13.5	19.8	21.7	22.9	25.9	26.9	30.5	31.7	34.2	35.0	36.3	38.0	39.6	41.8	44.4	45.6	47.3	48.7	49.8	53.1	56.4	57.4	58.3	59.9	60.9	62.1	64.5	74.4
Distanze parziali [m]	6.3	1.9	2.9	3.3	2.6	1.3	1.7	2.2	2.1	1.2	1.4	1.8	2.2	2.1	1.2	1.4	1.4	1.8	3.2	2.8	1.6	1.6	1.6	1.6	2.0	9.8		

Sezione

Porte

Livelli idrometrici

Q=363.18m/s H=3.54m s.l.m.

Q=387.38m/s H=3.58m s.l.m.

Q=419.10m/s H=3.67m s.l.m.

Q=423.73m/s H=3.69m s.l.m.

fr0003_c
Sezione n. fr0003_c

Scala distanze 1:320
Scala quote 1:160

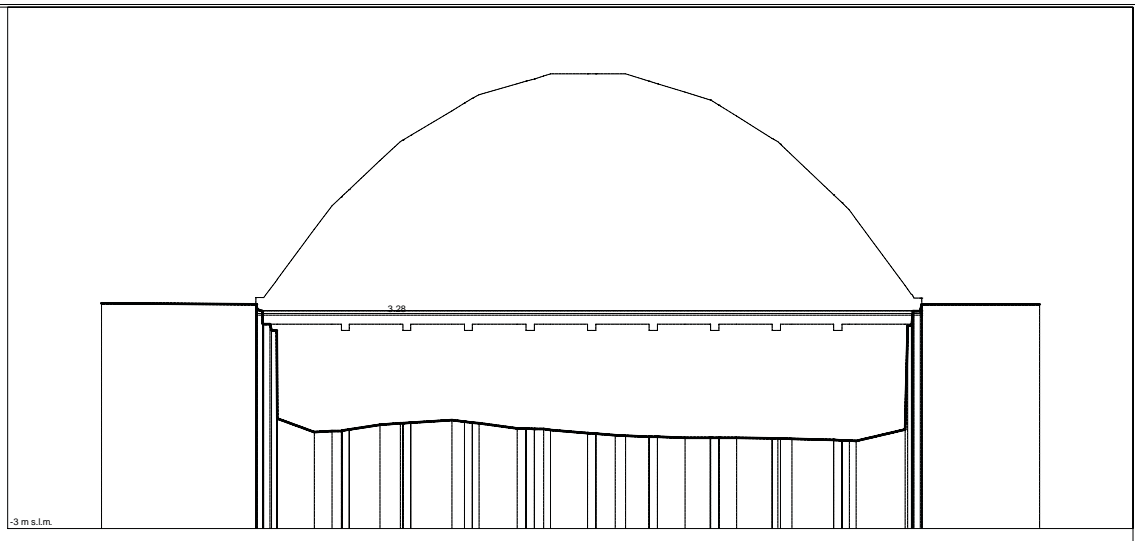

Punti	1	2	9	13	14	18	20	21	26	29	32	35	38	39	43	45	49	50	55	56	61	62	66	68	74	78
Quote [m s.l.m.]	3.91	3.88	3.27	-0.05	-0.02	0.03	0.19	0.23	0.34	0.25	0.07	0.06	0.03	-0.07	-0.14	-0.18	-0.22	-0.22	-0.22	-0.23	-0.24	-0.29	-0.30	0.03	3.88	3.88
Distanze progressive [m]	13.5	23.0	23.9	26.6	27.7	28.8	30.6	31.9	35.1	36.3	38.0	40.1	41.1	43.4	45.0	47.1	49.4	50.9	52.5	54.7	55.9	58.5	59.4	63.9	65.6	71.1
Distanze parziali [m]		9.5	2.3	2.3	1.9	1.3	1.3	2.5	2.3	2.3	2.3	2.3	1.2	1.5	1.7	1.5	1.5	2.2	2.2	2.2	2.6	2.6	3.0	3.0	7.2	

Sezione

Livelli idrometrici

Q=363.18m/s H=3.58m s.l.m.

Q=387.38m/s H=3.63m s.l.m.

Q=419.01m/s H=3.74m s.l.m.

Q=423.65m/s H=3.76m s.l.m.

fr0003_d
Sezione n. fr0003_d

Scala distanze 1:320
Scala quote 1:40

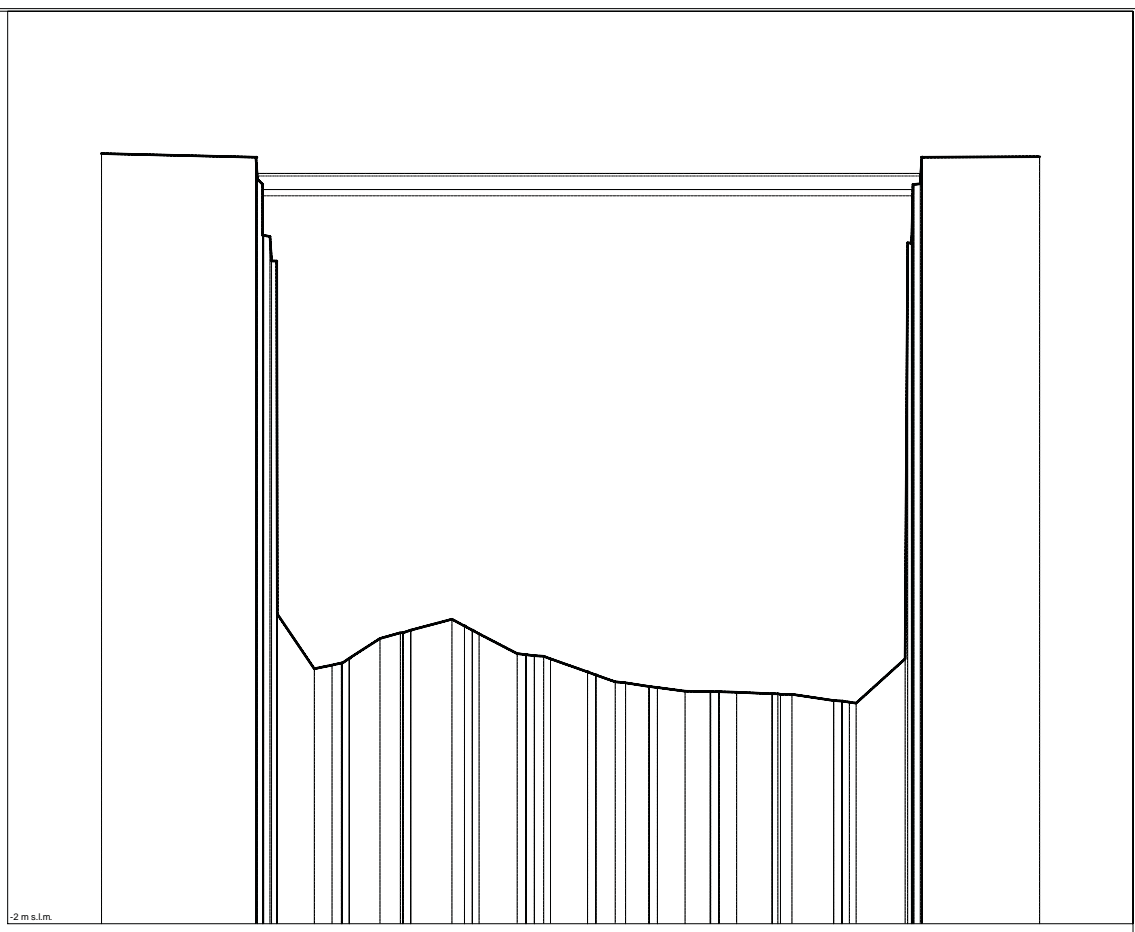

Punti	1	2	9	13	14	18	20	21	26	29	32	35	38	39	43	45	49	50	55	56	61	62	66	68	74	79
Quote [m s.l.m.]	3.91	3.88	3.27	-0.05	-0.02	0.04	0.19	0.23	0.34	0.25	0.07	0.06	0.03	-0.07	-0.14	-0.18	-0.22	-0.22	-0.22	-0.24	-0.24	-0.29	-0.30	0.03	3.88	3.88
Distanze progressive [m]	13.5	23.0	23.9	26.6	27.7	28.8	30.6	31.9	35.1	36.3	38.0	40.1	41.1	43.4	45.0	47.1	49.4	50.9	52.5	54.7	55.9	58.5	59.4	63.9	65.6	71.1
Distanze parziali [m]		9.5	2.3	2.3	1.9	1.3	1.3	2.5	2.3	2.3	2.3	2.3	1.2	1.5	1.7	1.5	1.5	2.2	2.2	2.2	2.6	2.6	3.0	3.0	7.2	

Sezione
 Livelli idrometrici
 Q=320.79mc/s H=3.59m s.l.m.
 Q=328.50mc/s H=3.65m s.l.m.
 Q=344.60mc/s H=3.76m s.l.m.
 Q=351.66mc/s H=3.78m s.l.m.

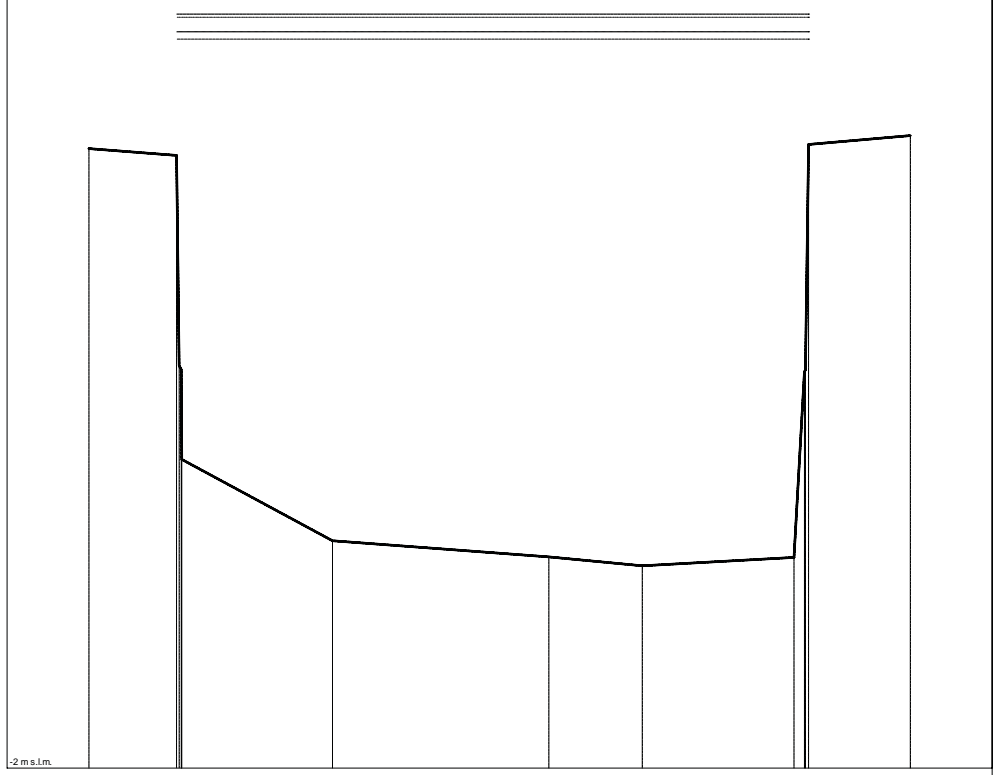

fr0002_
 Sezione n. fr0002_
 - -
 Scale distanze 1:320
 Scala quote 1:40

Punti	1	2	6	7	8	9	12	13
Quote [m s.l.m.]	2.75	2.70	-0.25	-0.38	-0.45	-0.38	2.78	2.85
Distanze progressive [m]	13.5	18.9	28.5	41.8	47.5	56.8	57.7	63.9
Distanze parziali [m]		5.4	9.3	13.3	5.7	9.3	6.2	

Sezione
 Livelli idrometrici
 Q=311.67mc/s H=2.14m s.l.m.
 Q=317.71mc/s H=2.17m s.l.m.
 Q=328.35mc/s H=2.24m s.l.m.
 Q=333.74mc/s H=2.27m s.l.m.

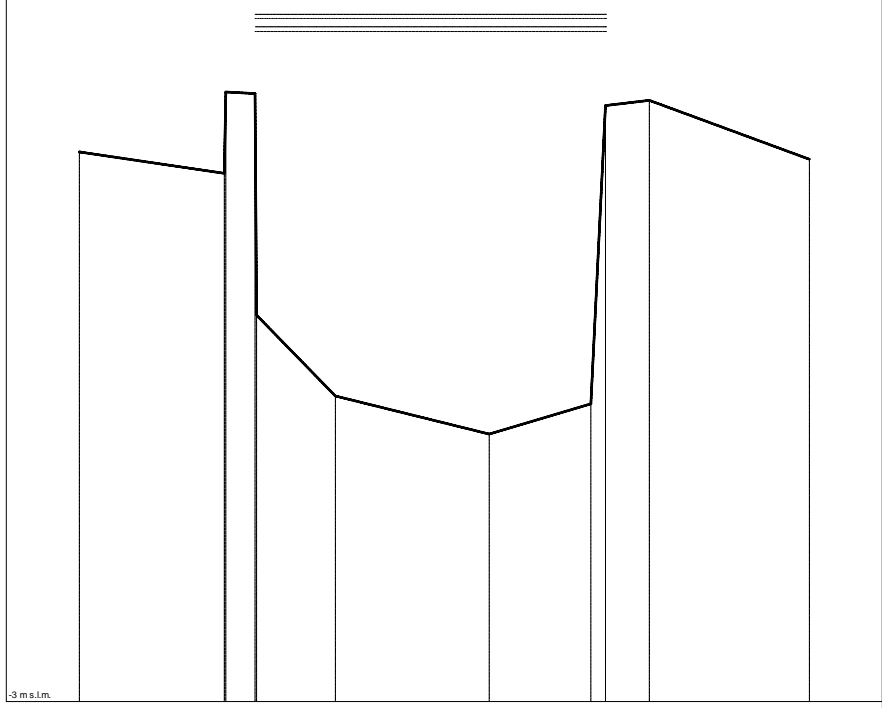

fr0001_
 Sezione n. fr0001_
 - -
 Scale distanze 1:320
 Scala quote 1:40

Punti	1	2	4	6	7	8	9	10	11
Quote [m s.l.m.]	1.22	1.05	1.86	-0.86	-0.95	-0.72	1.57	1.81	1.16
Distanze progressive [m]	13.5	22.4	24.3	29.2	38.7	44.9	45.8	48.5	58.3
Distanze parziali [m]		9.9	1.8	4.8	9.4	6.2	2.7	9.8	

STATO ATTUALE
Sezioni fluviali Fossa Grande

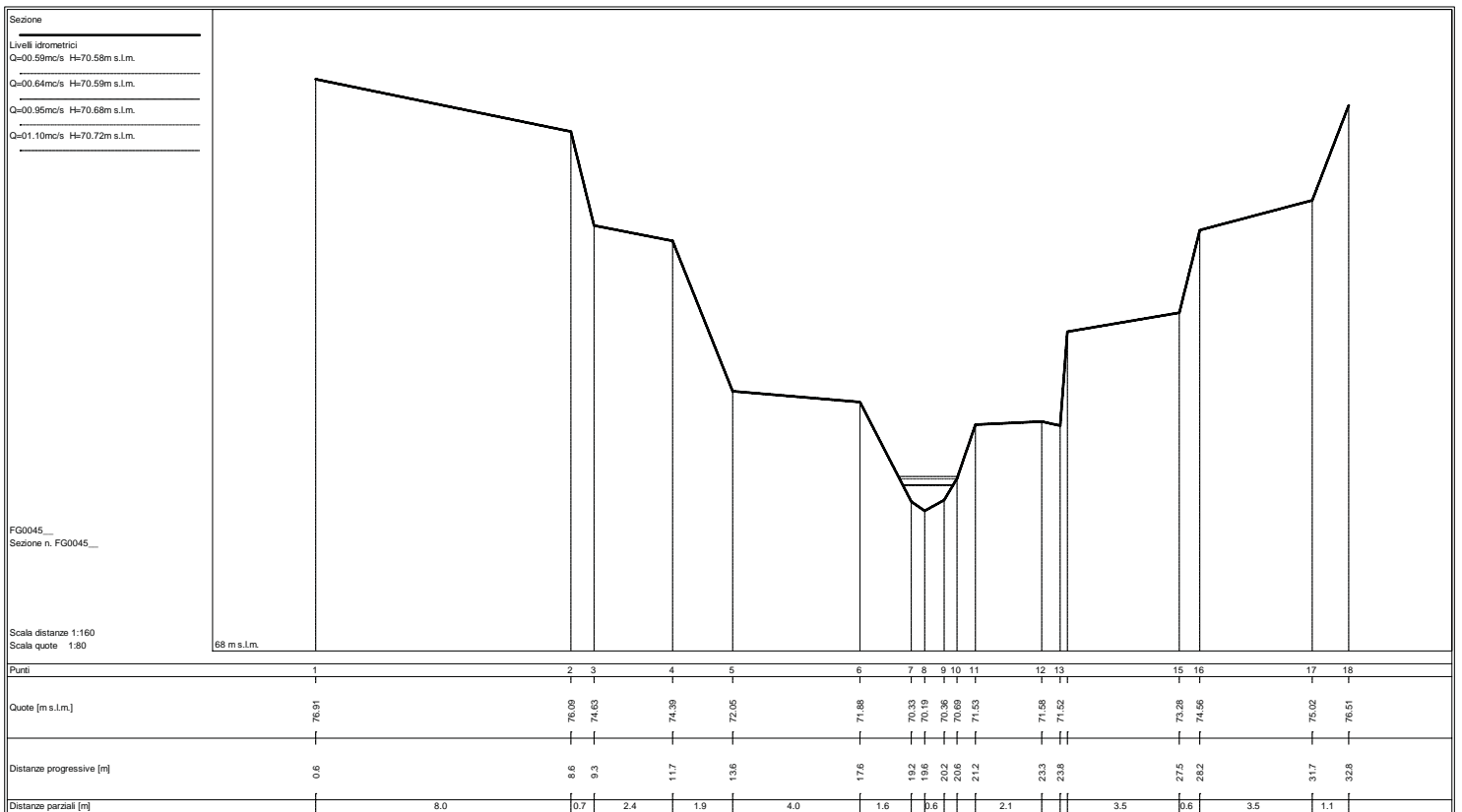
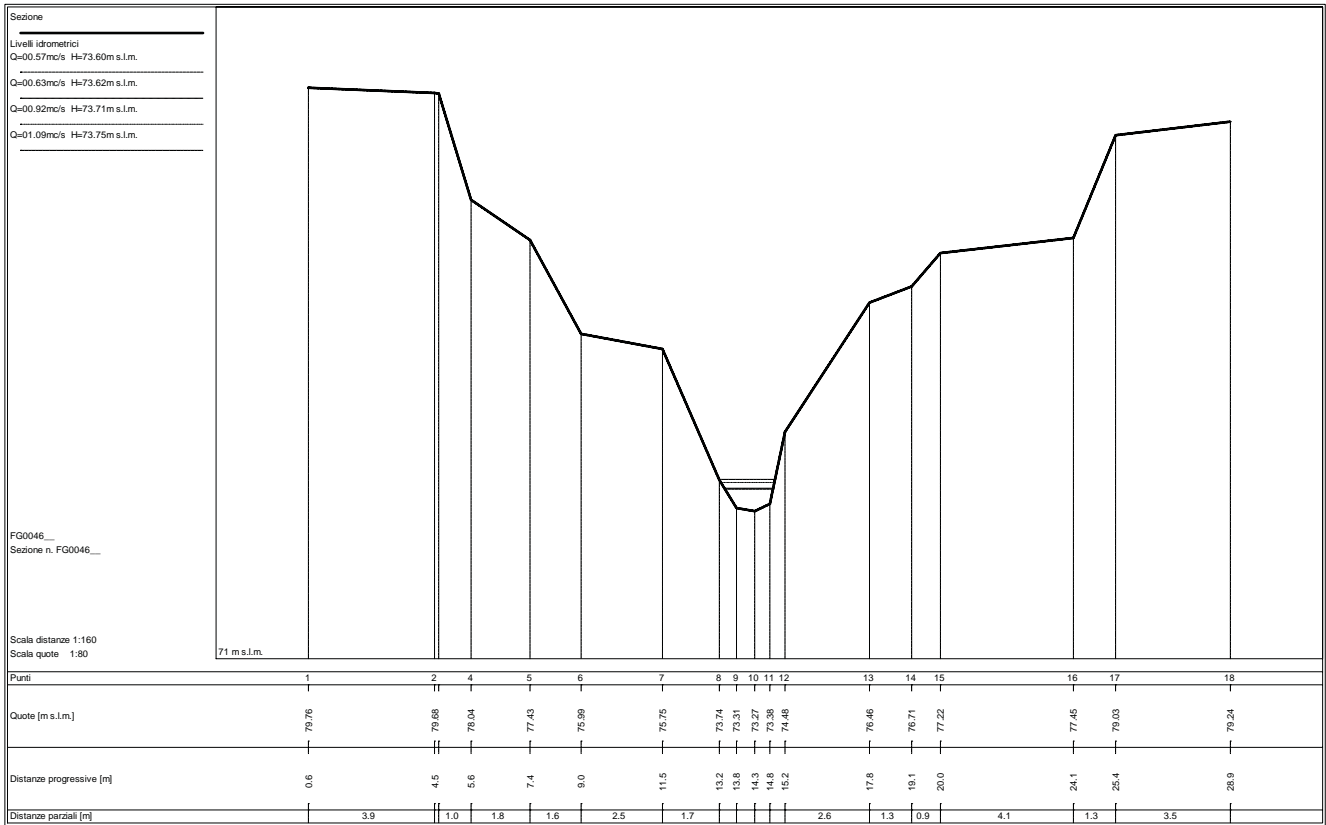

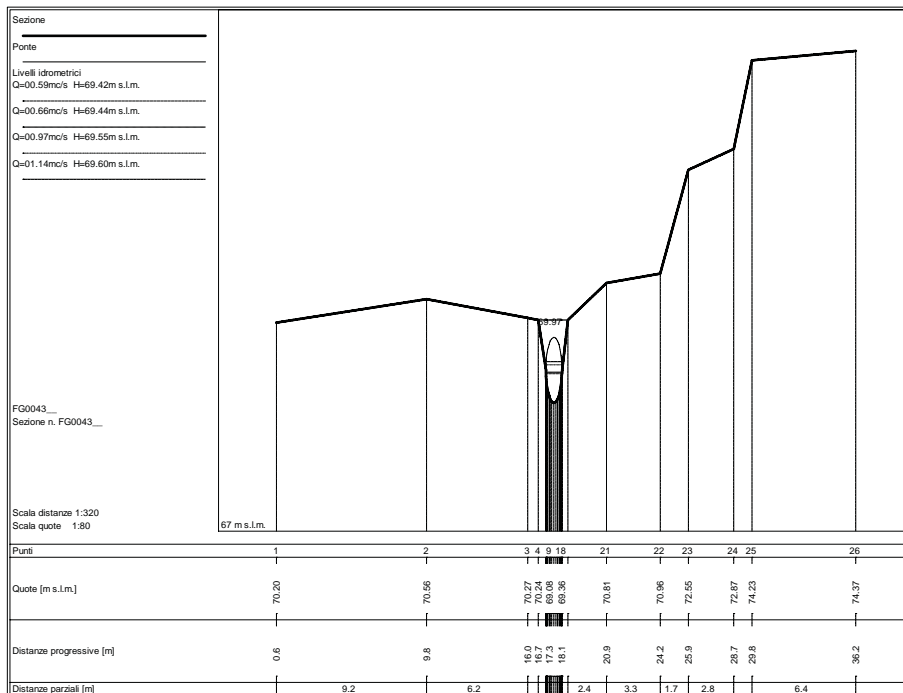
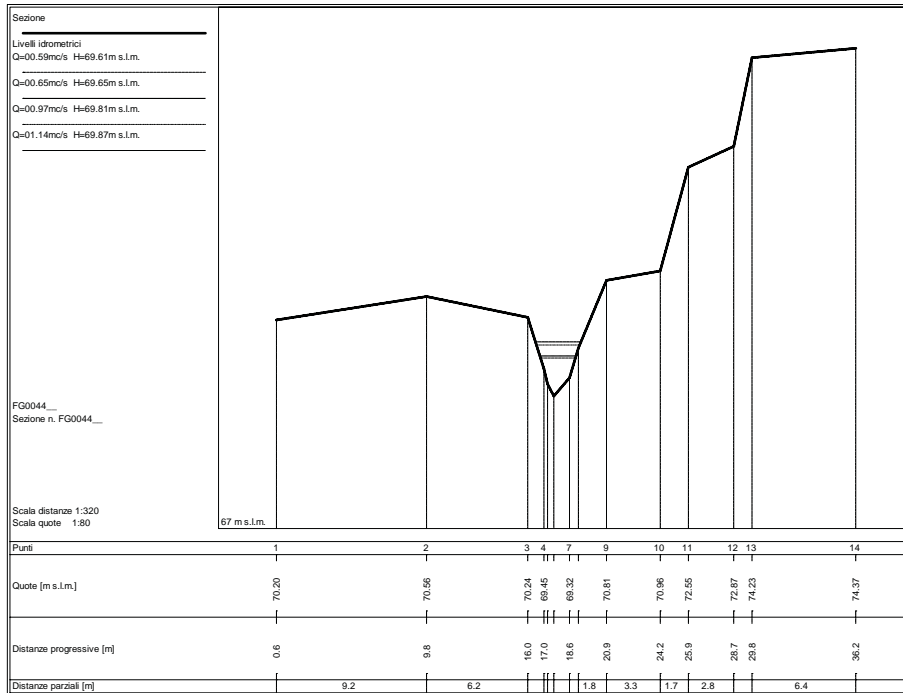

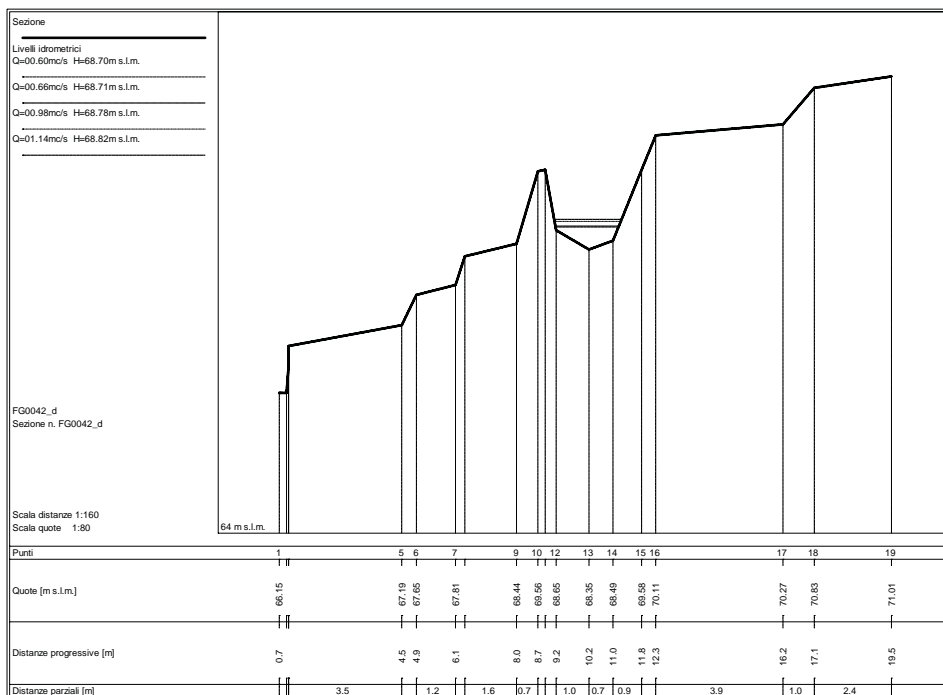
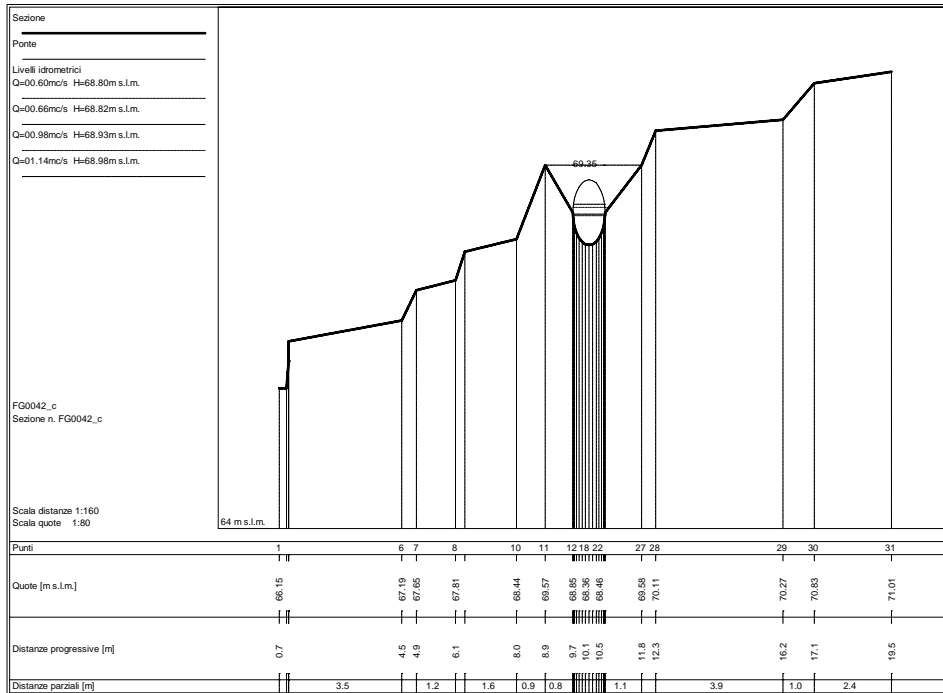

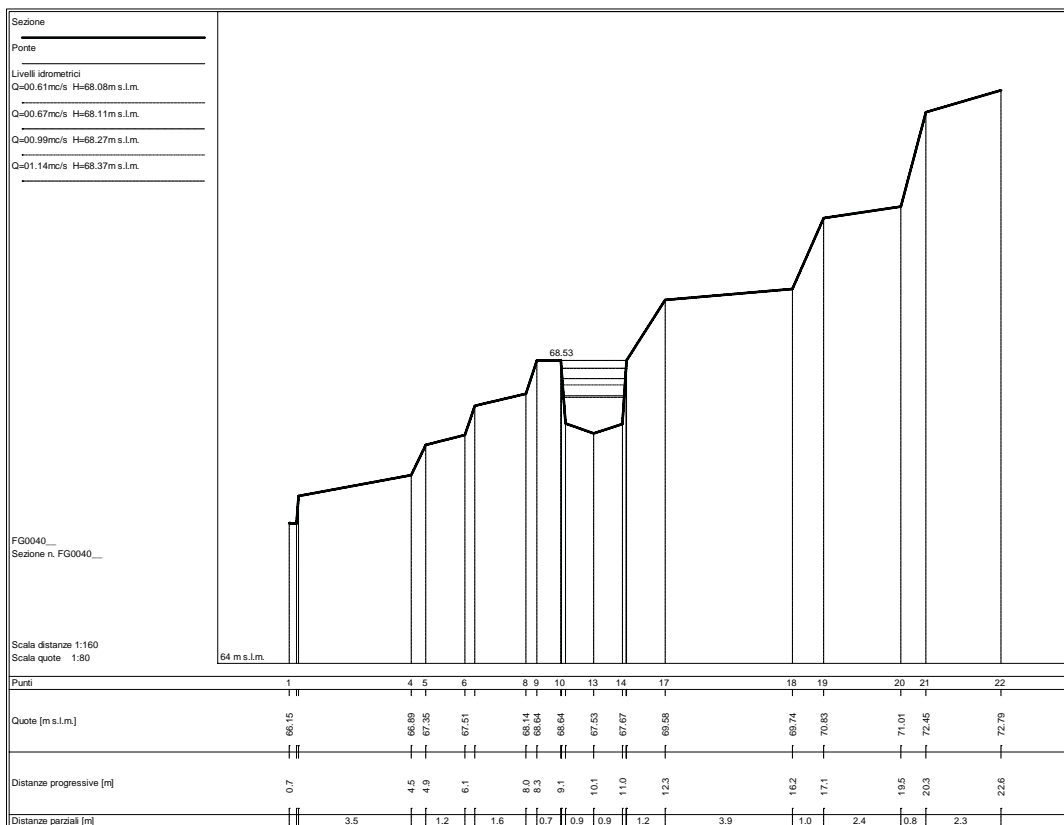
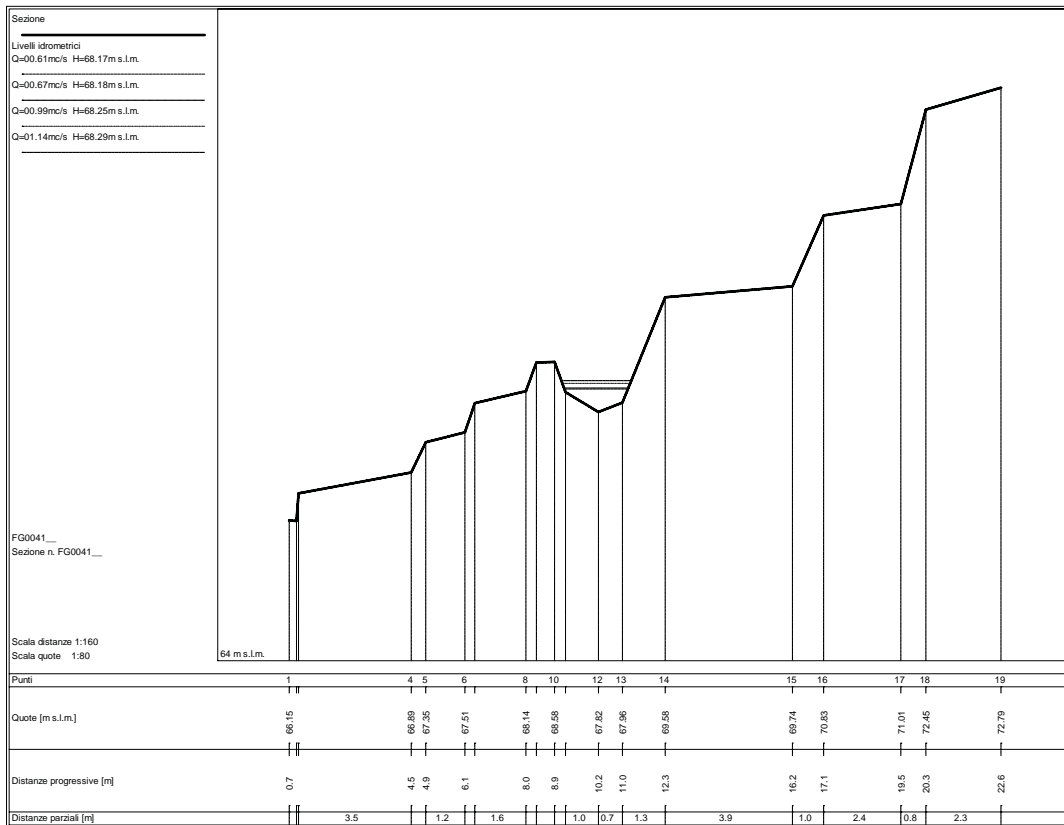

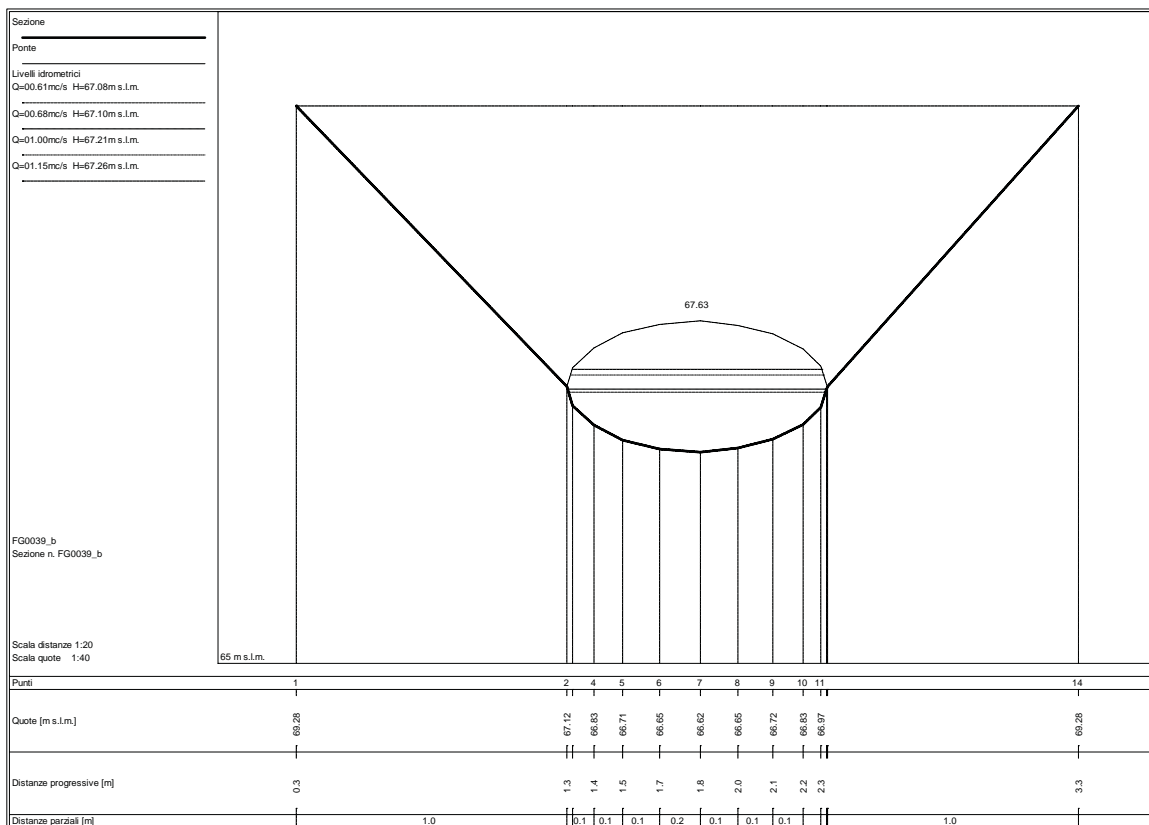
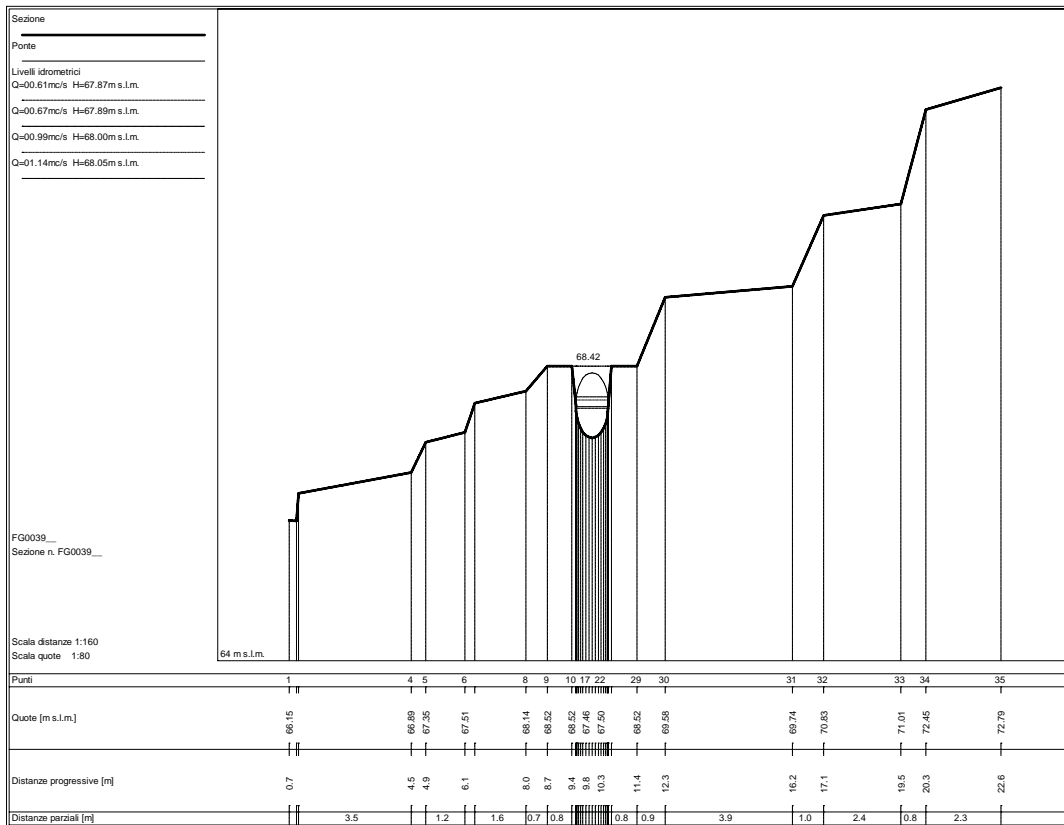

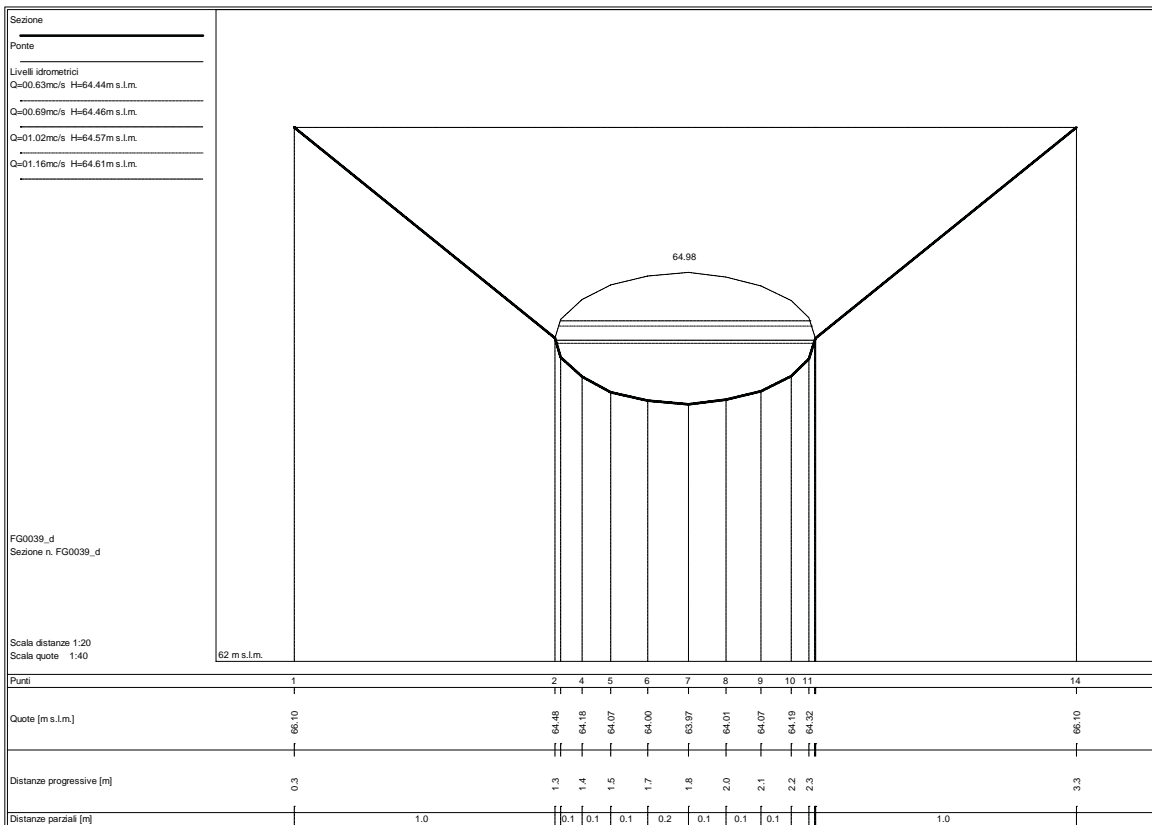
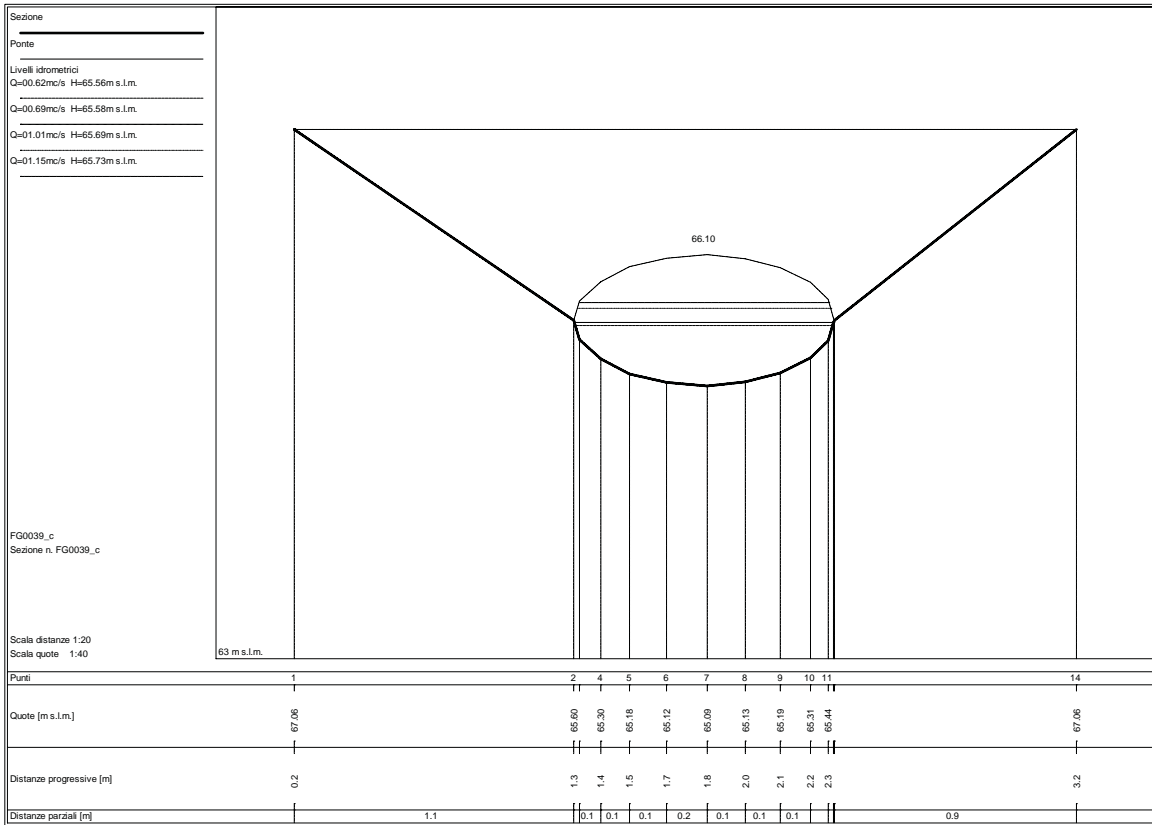

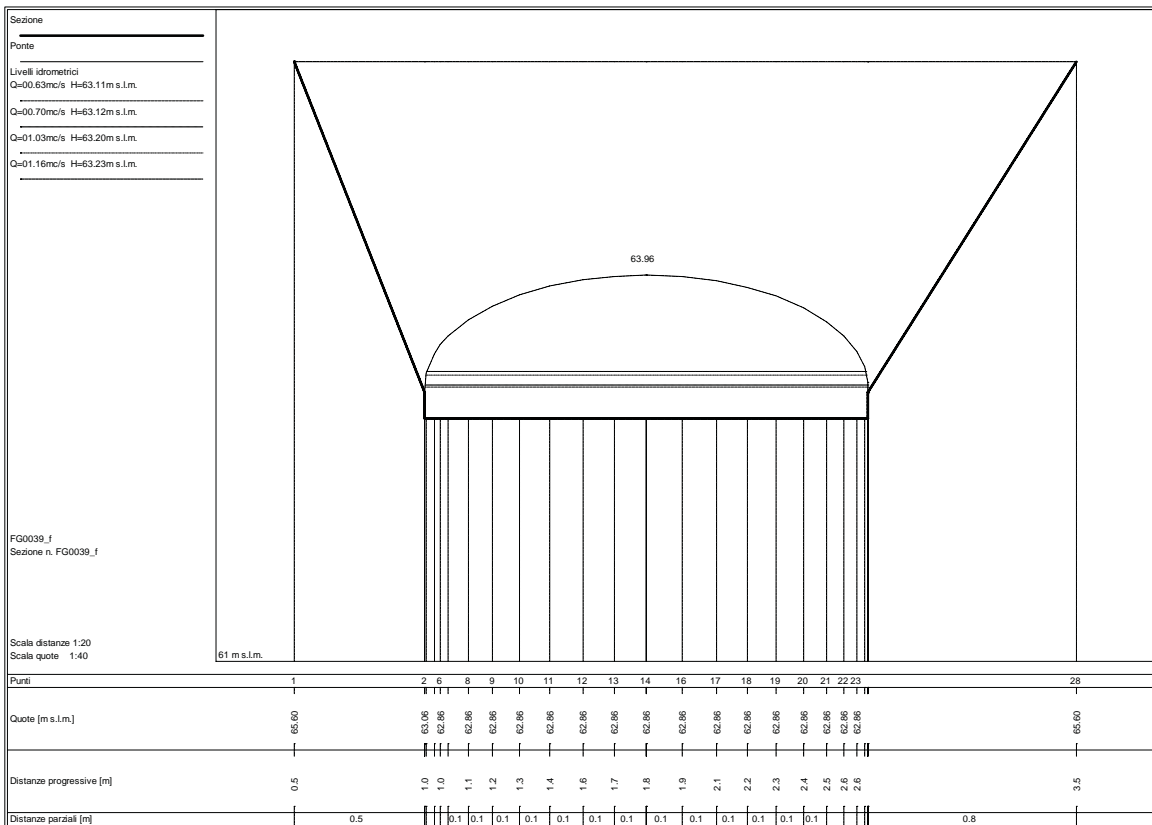
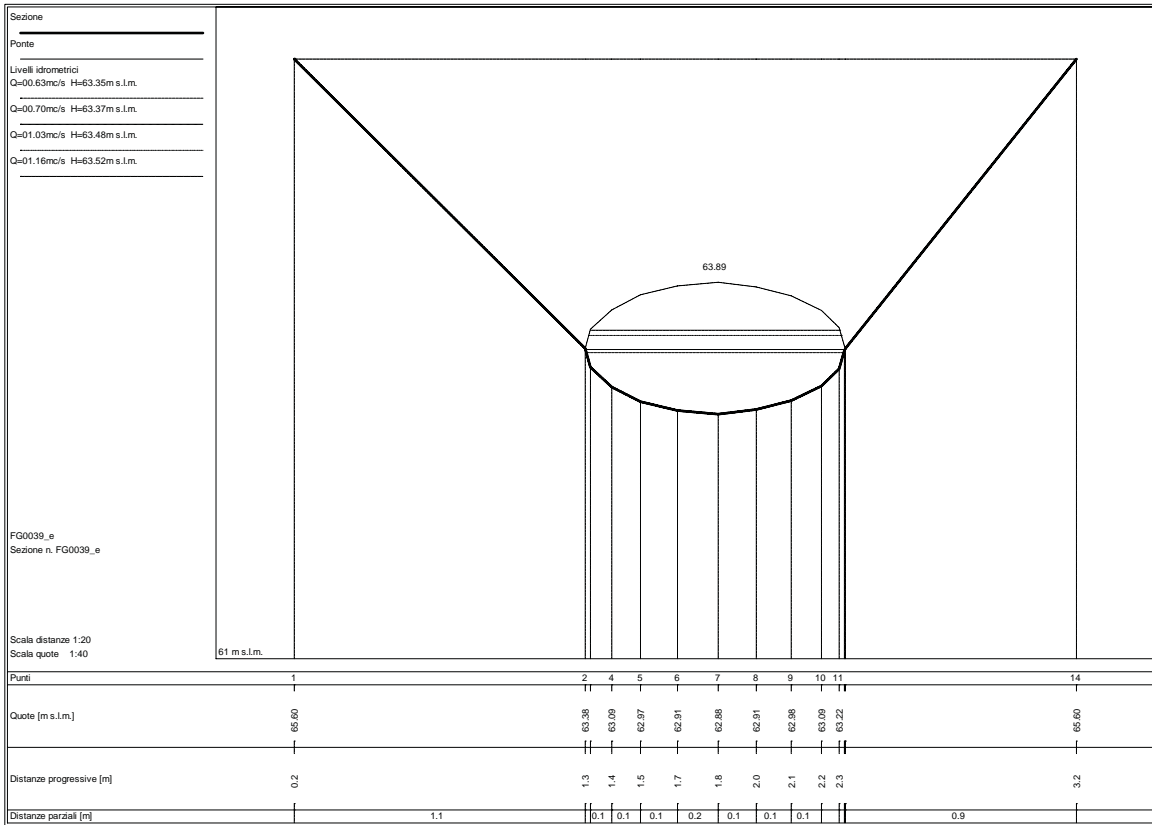

Sezione
 Ponte
 Livelli idrometrici
 Q=00.64mc/s H=62.54m s.l.m.
 Q=00.70mc/s H=62.56m s.l.m.
 Q=01.03mc/s H=62.67m s.l.m.
 Q=01.16mc/s H=62.71m s.l.m.

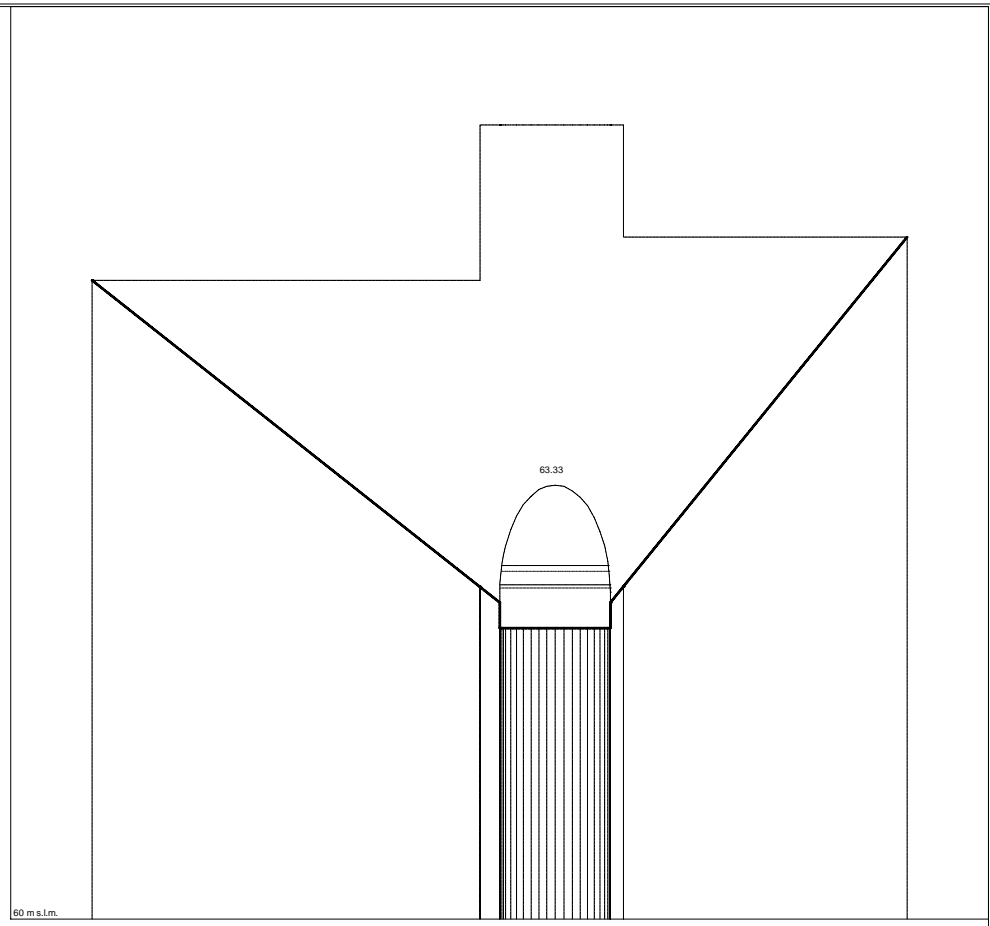

FG0038
 Sezione n. FG0038

Scala distanze 1:80
 Scala quote 1:40

Punti	1	2	4	11	13	15	17	19	21	24	29	31
Quote [m s.l.m.]	64.90	62.95	62.43	62.53	62.23	62.23	62.33	62.33	62.23	62.23	62.95	65.23
Distanze progressive [m]	0.6	6.6	6.9	7.1	7.4	7.6	7.9	8.1	8.3	8.5	8.8	13.1
Distanze parziali [m]		6.0	0.3								4.4	

Sezione
 Livelli idrometrici
 Q=00.64mc/s H=62.46m s.l.m.
 Q=00.70mc/s H=62.48m s.l.m.
 Q=01.03mc/s H=62.56m s.l.m.
 Q=01.16mc/s H=62.59m s.l.m.

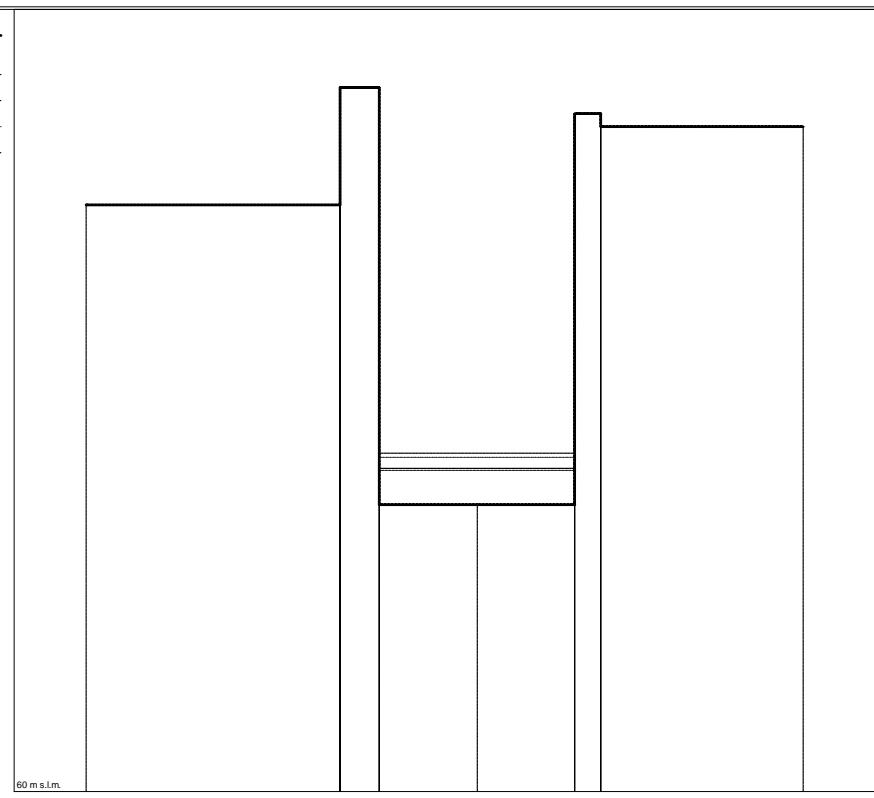

FG0037
 Sezione n. FG0037

Scala distanze 1:40
 Scala quote 1:40

Punti	1	2	4	6	7	9	11
Quote [m s.l.m.]	64.50	64.50	65.40	62.20	62.20	65.20	65.10
Distanze progressive [m]	4.6	6.6	6.9	7.6	8.4	8.6	10.1
Distanze parziali [m]		2.0	0.3	0.8	0.8	0.2	1.6

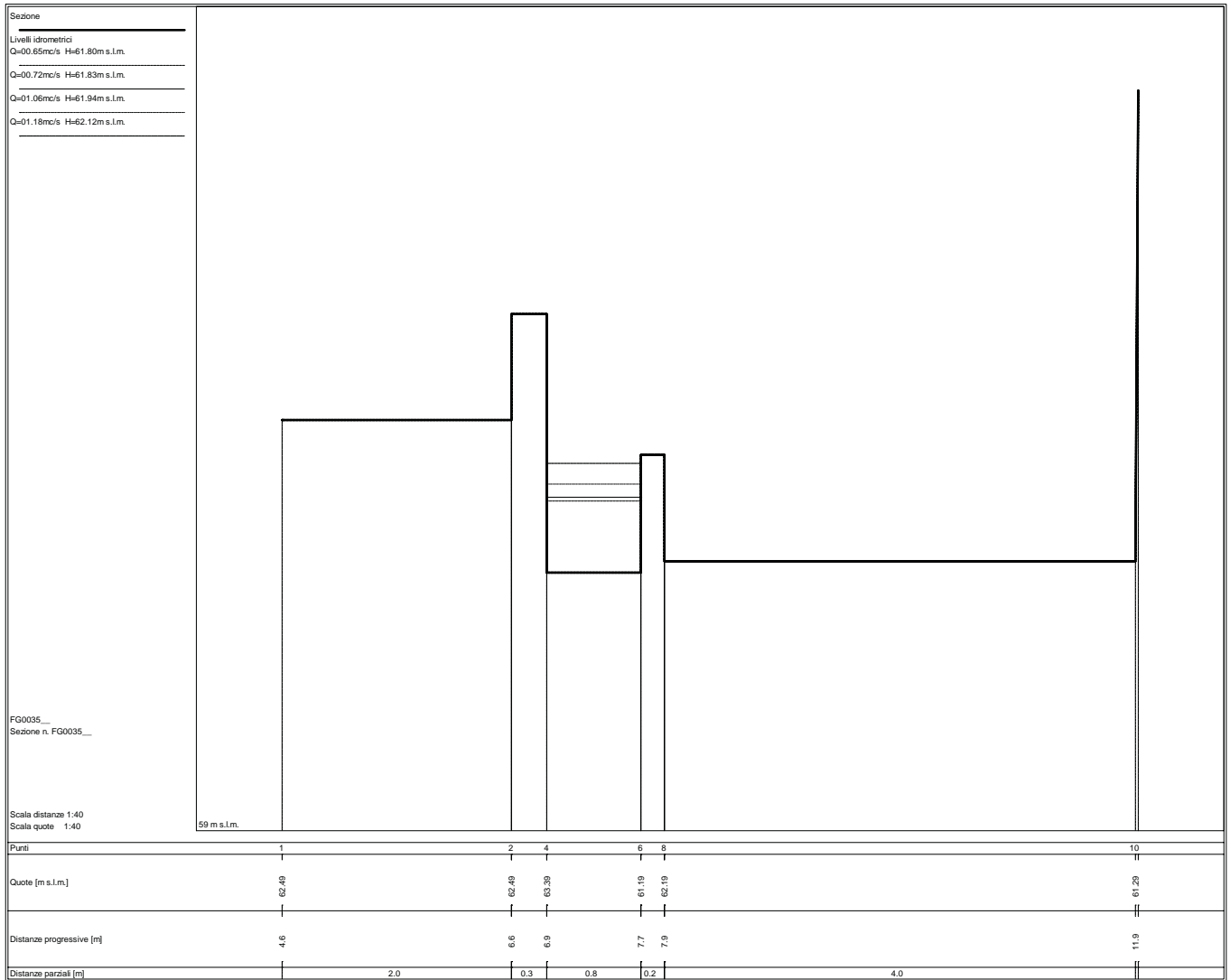

Sezione
 Livelli idrometrici
 Q=00.66mc/s H=61.17m s.l.m.
 Q=00.73mc/s H=61.20m s.l.m.
 Q=01.07mc/s H=61.40m s.l.m.
 Q=01.18mc/s H=61.55m s.l.m.

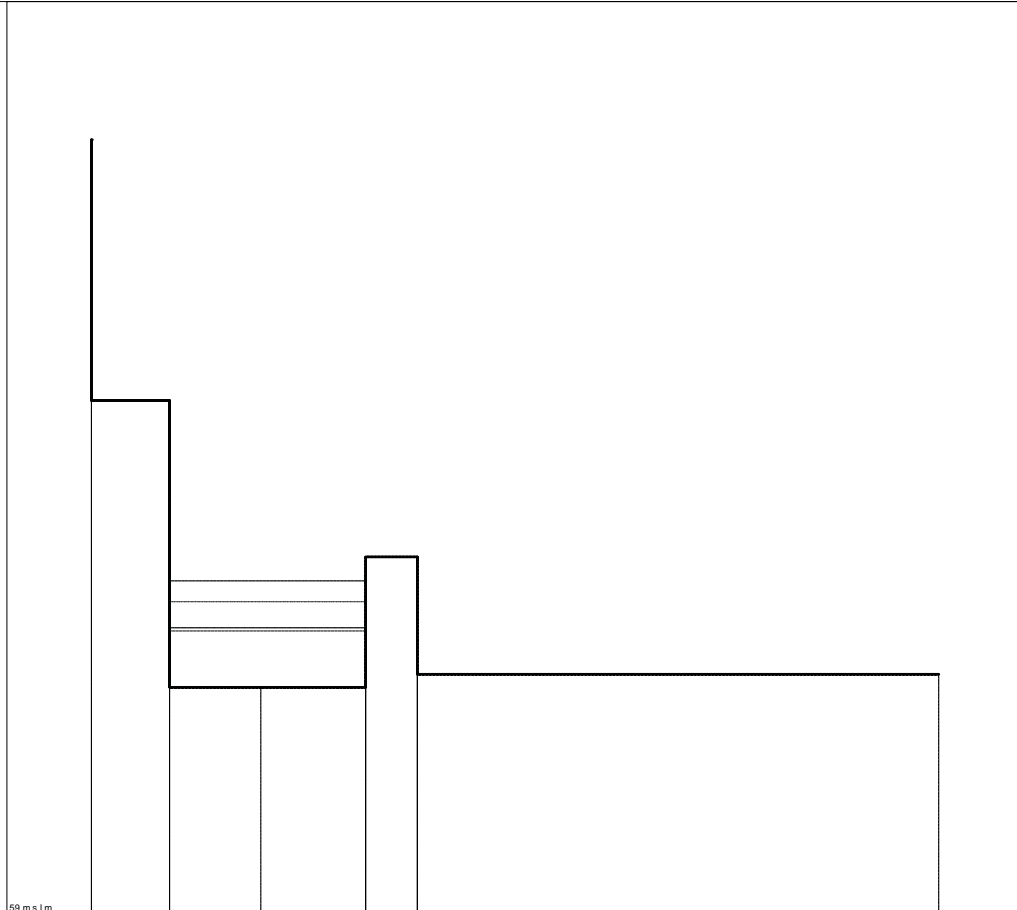

FG0034__
 Sezione n. FG0034__

Scala distanze 1:20
 Scala quote 1:40

59 m s.l.m.

Punti	1	3	5	6	8	10
Quote [m s.l.m.]	64.94	62.94	60.74	60.74	61.74	60.84
Distanze progressive [m]	6.6	6.9	7.2	7.6	7.8	9.8
Distanze parziali [m]		0.3	0.3	0.4	0.2	2.0

Sezione
 Livelli idrometrici
 Q=00.66mc/s H=60.71m s.l.m.
 Q=00.73mc/s H=60.76m s.l.m.
 Q=01.08mc/s H=60.82m s.l.m.
 Q=01.21mc/s H=60.87m s.l.m.

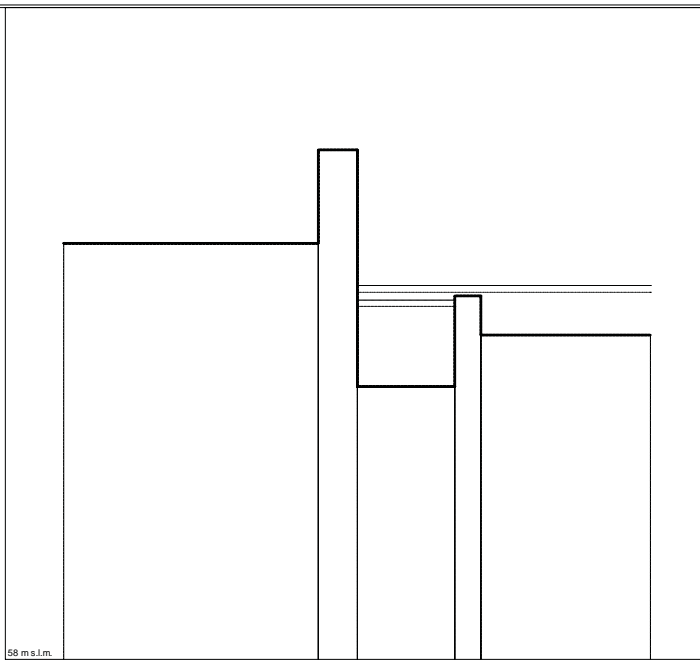

FG0033__
 Sezione n. FG0033__

Scala distanze 1:40
 Scala quote 1:40

58 m s.l.m.

Punti	1	2	4	6	8	10
Quote [m s.l.m.]	61.19	61.19	61.91	60.09	60.79	60.49
Distanze progressive [m]	4.6	6.6	6.9	7.6	7.8	9.1
Distanze parziali [m]		2.0	0.3	0.8	0.2	1.3

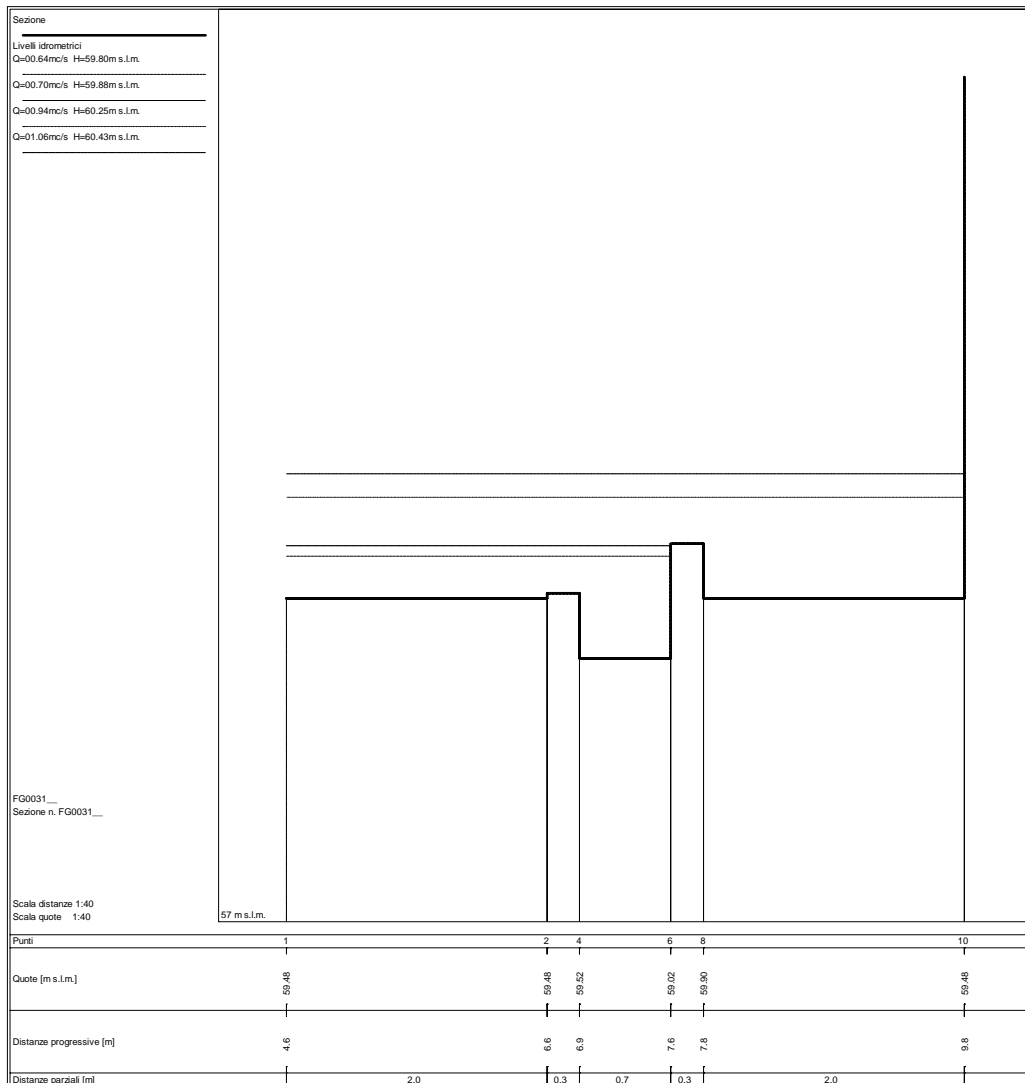
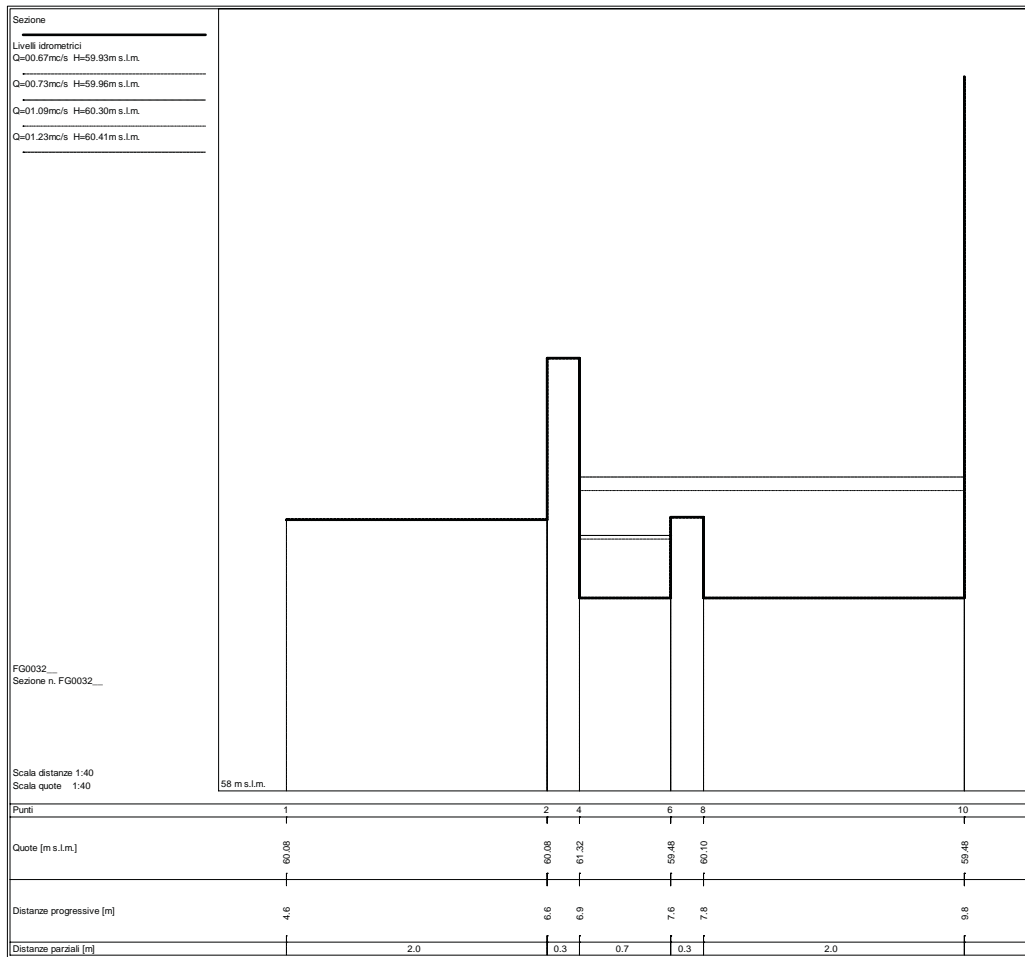

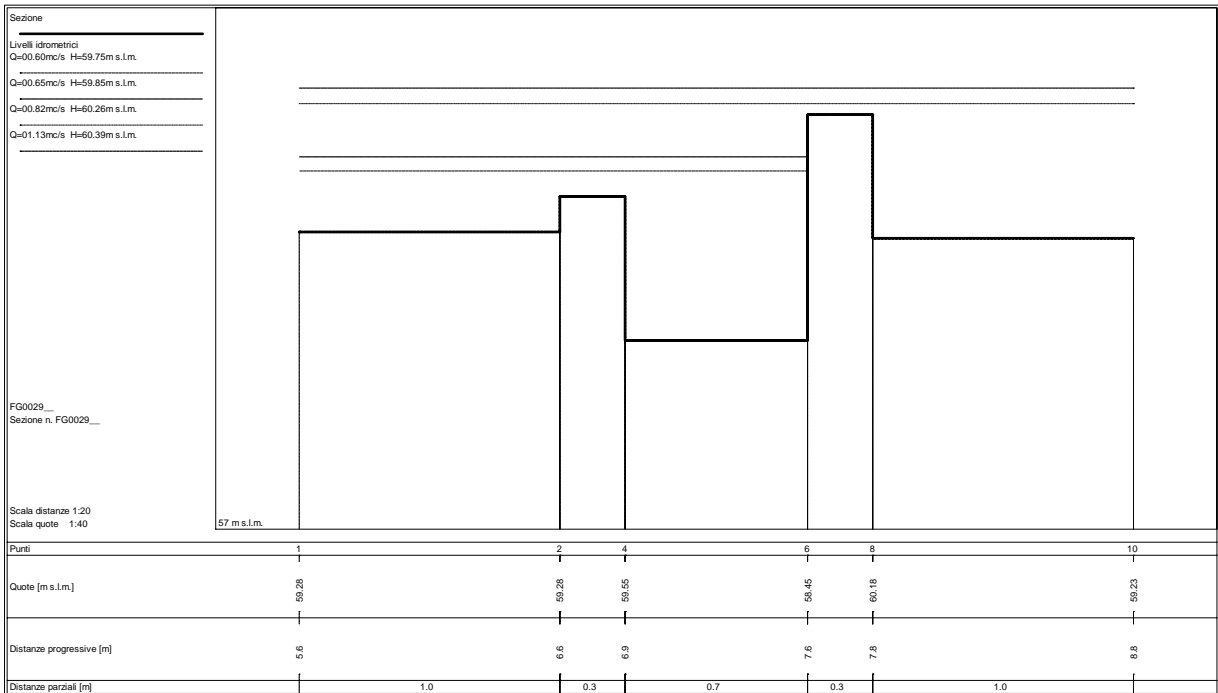
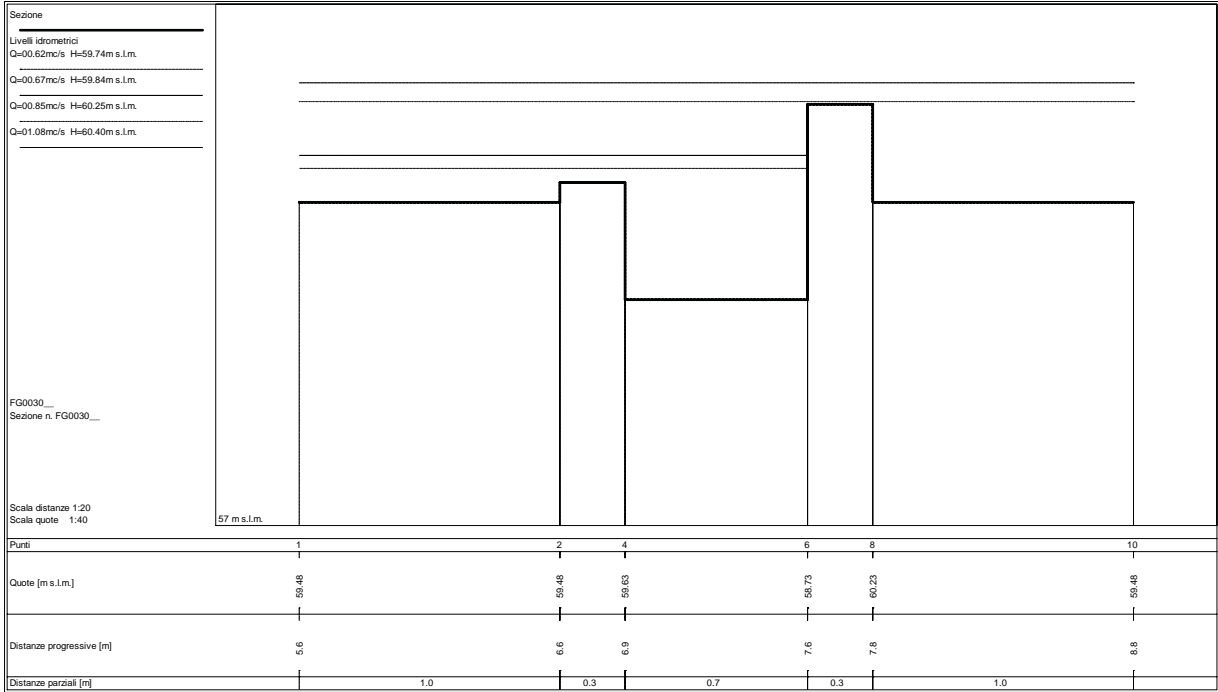

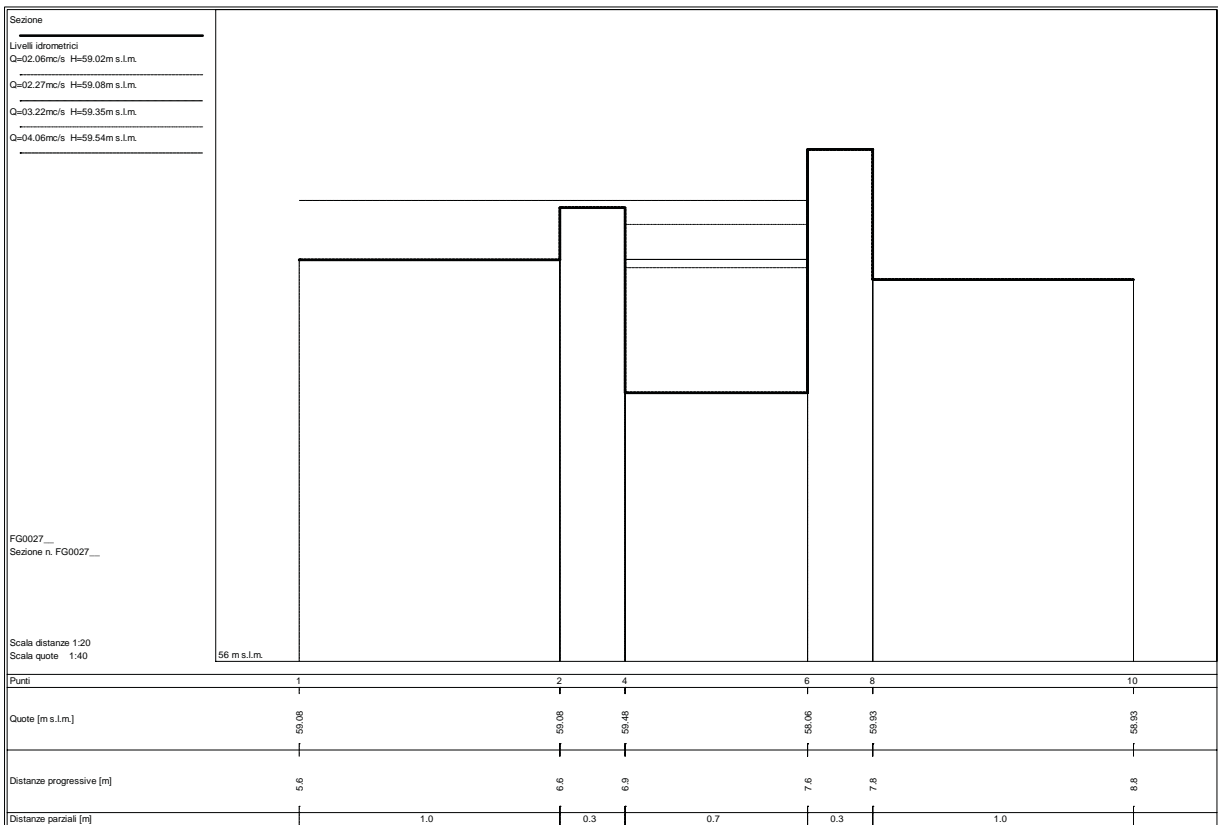
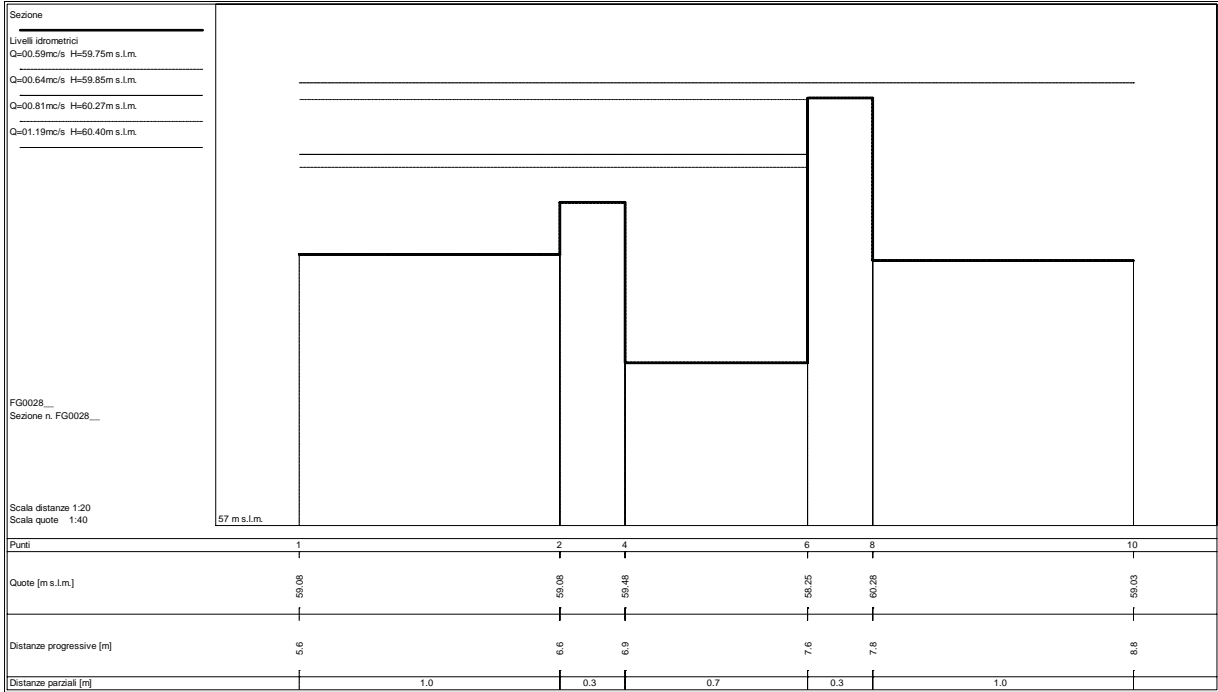

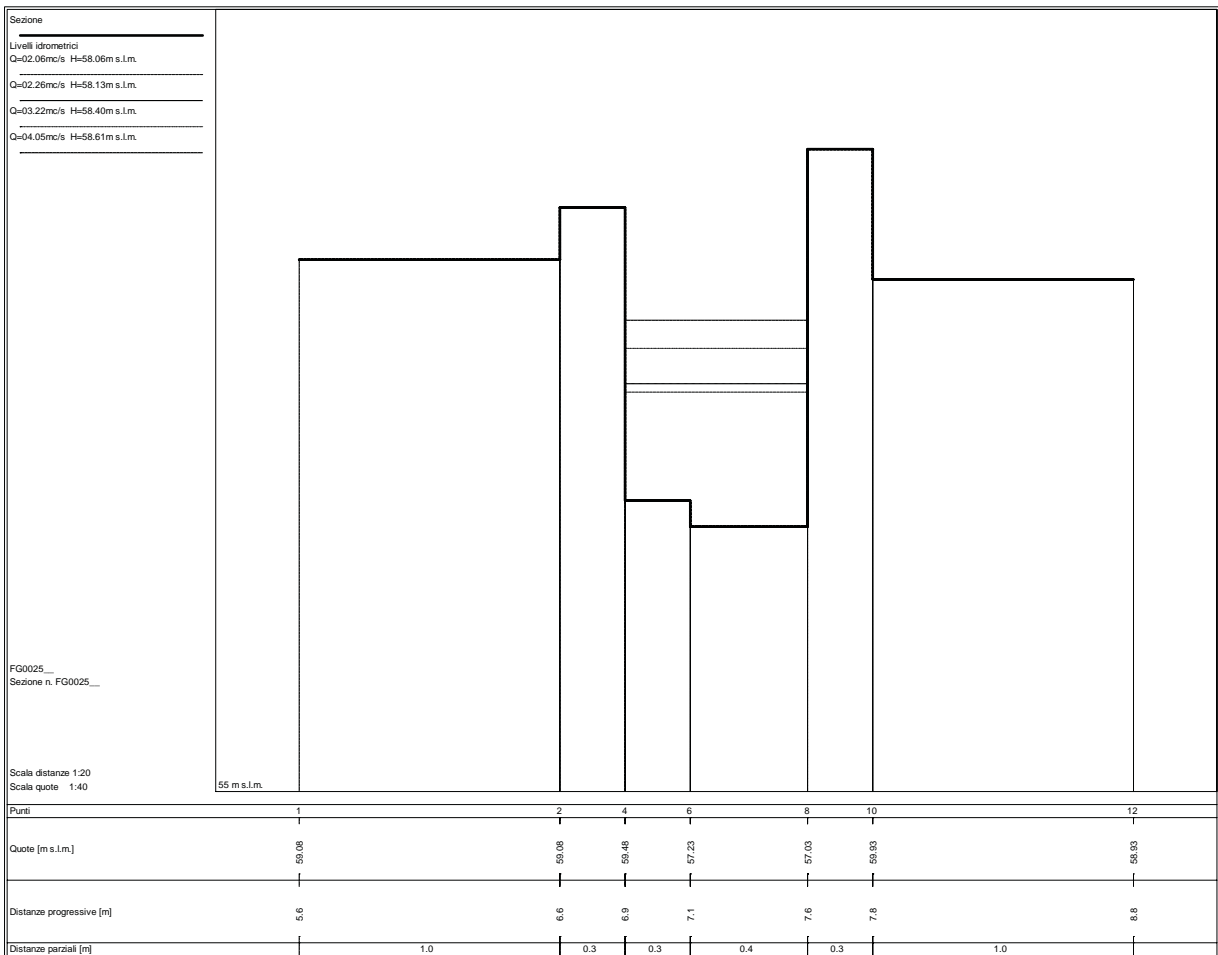
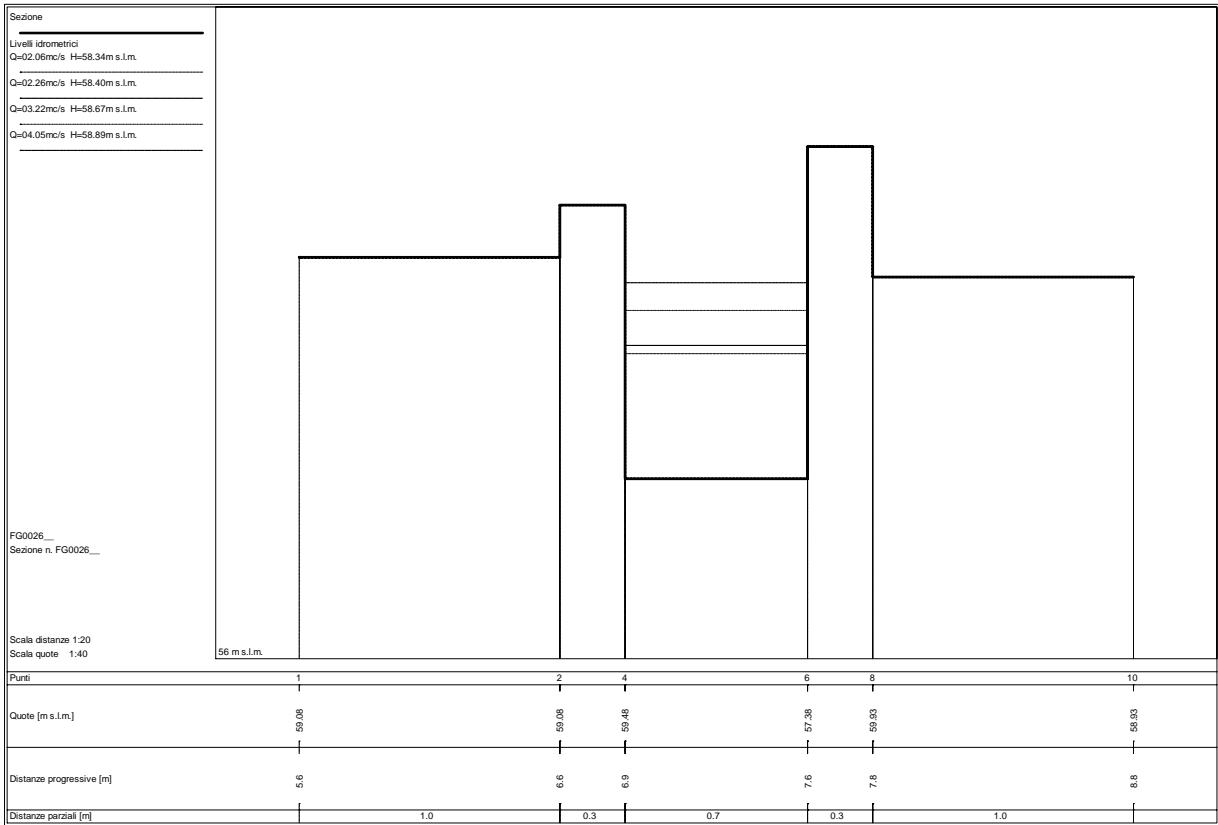

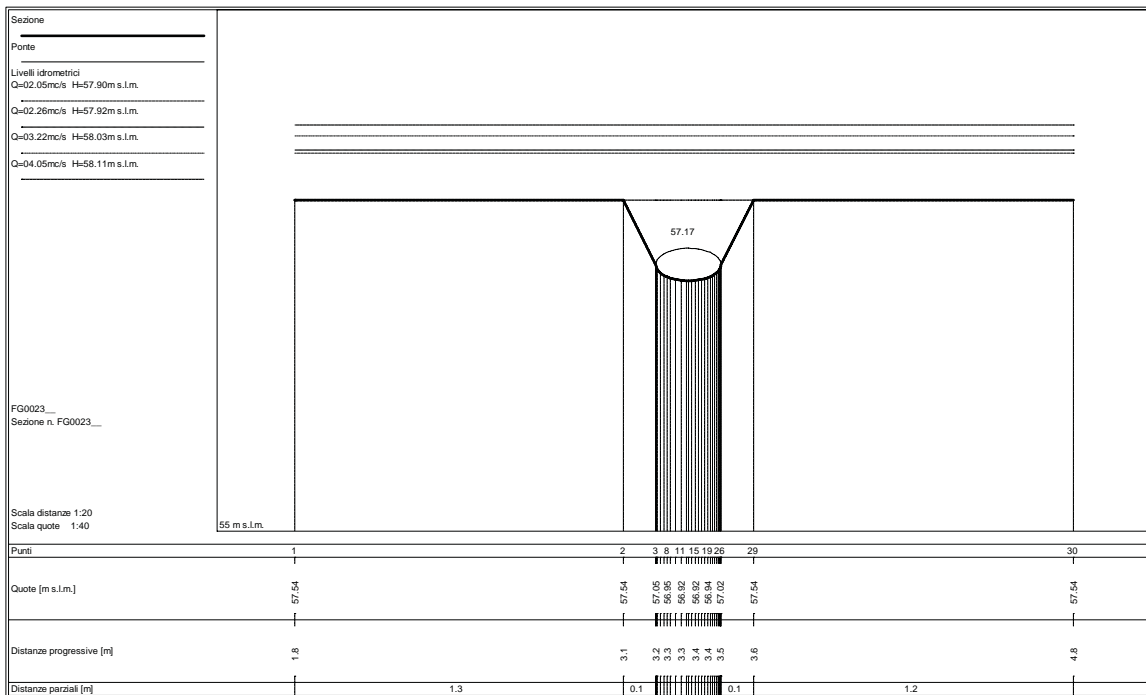
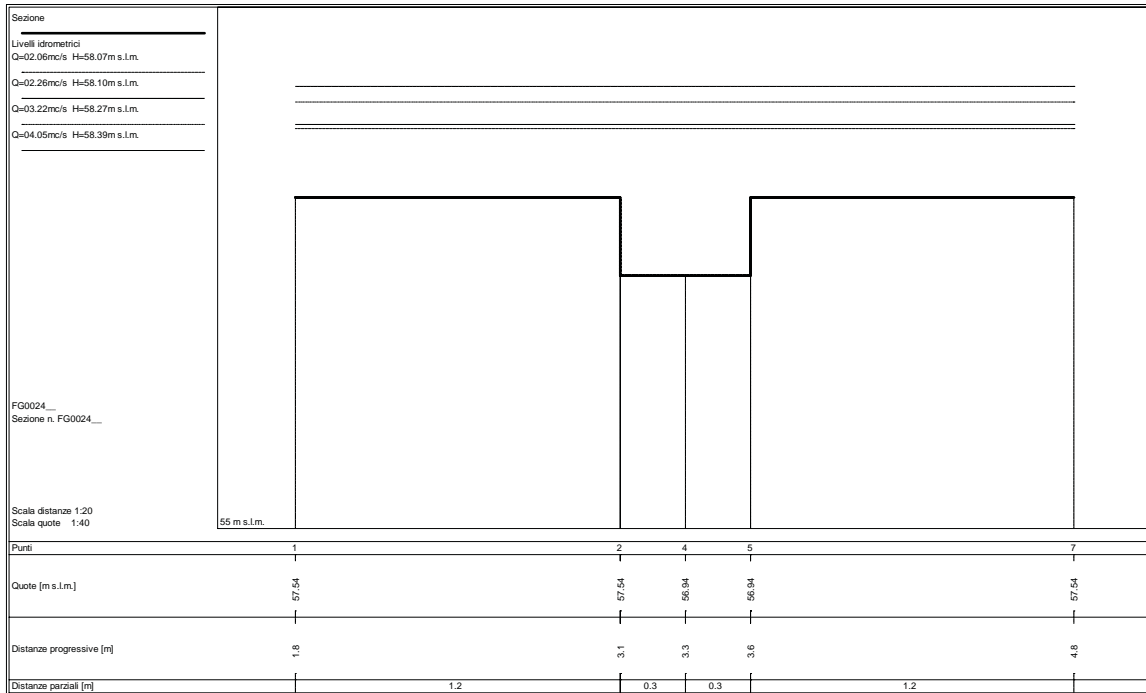

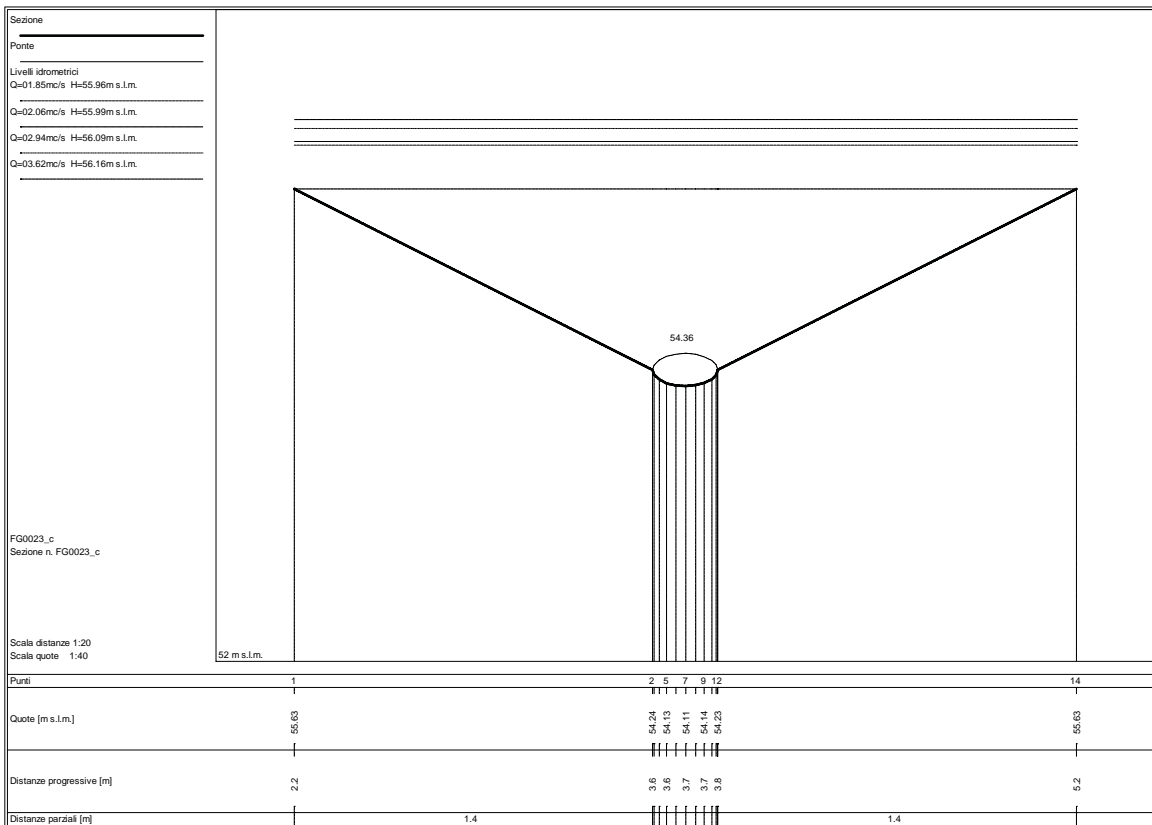
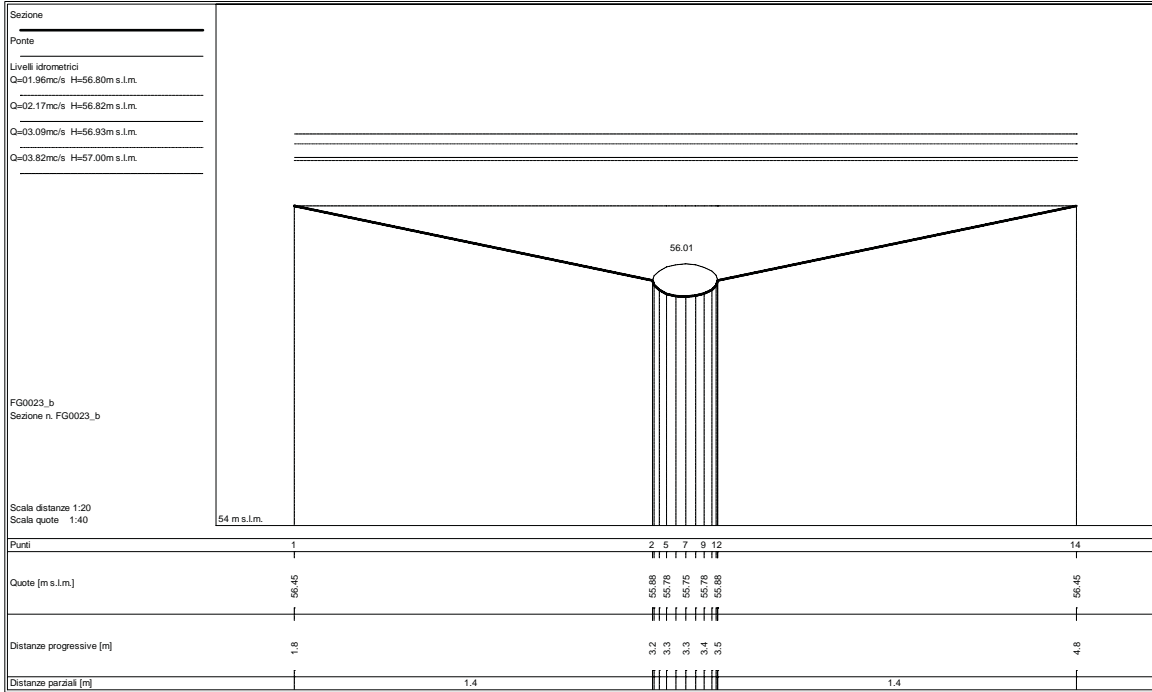

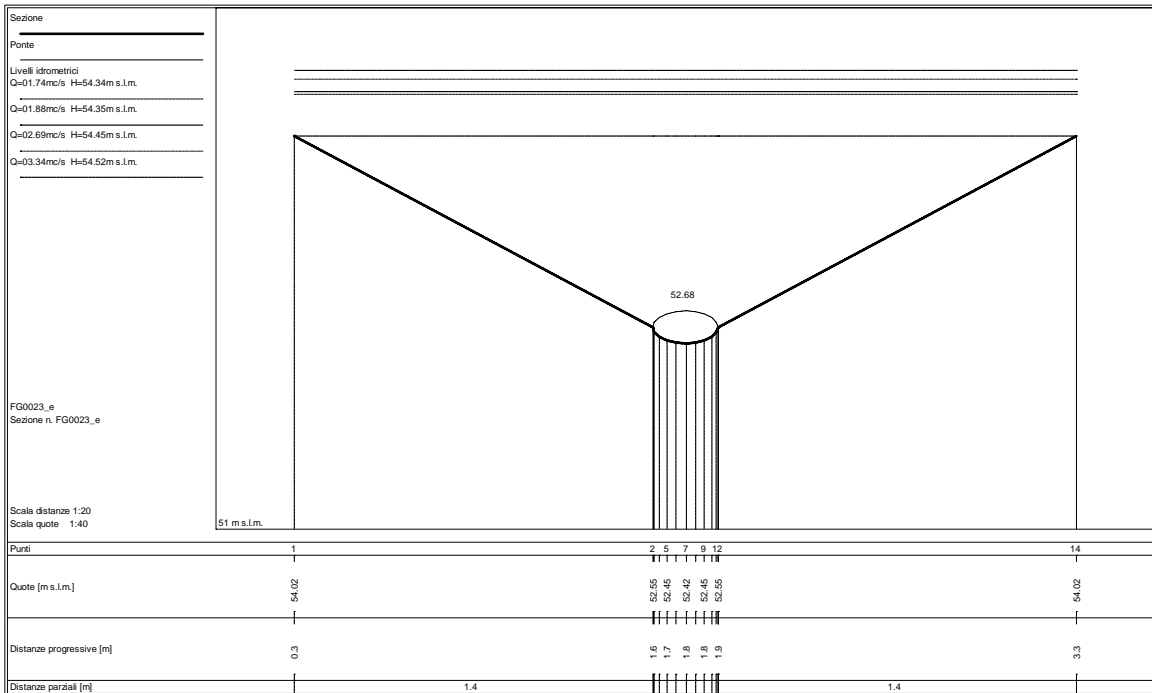
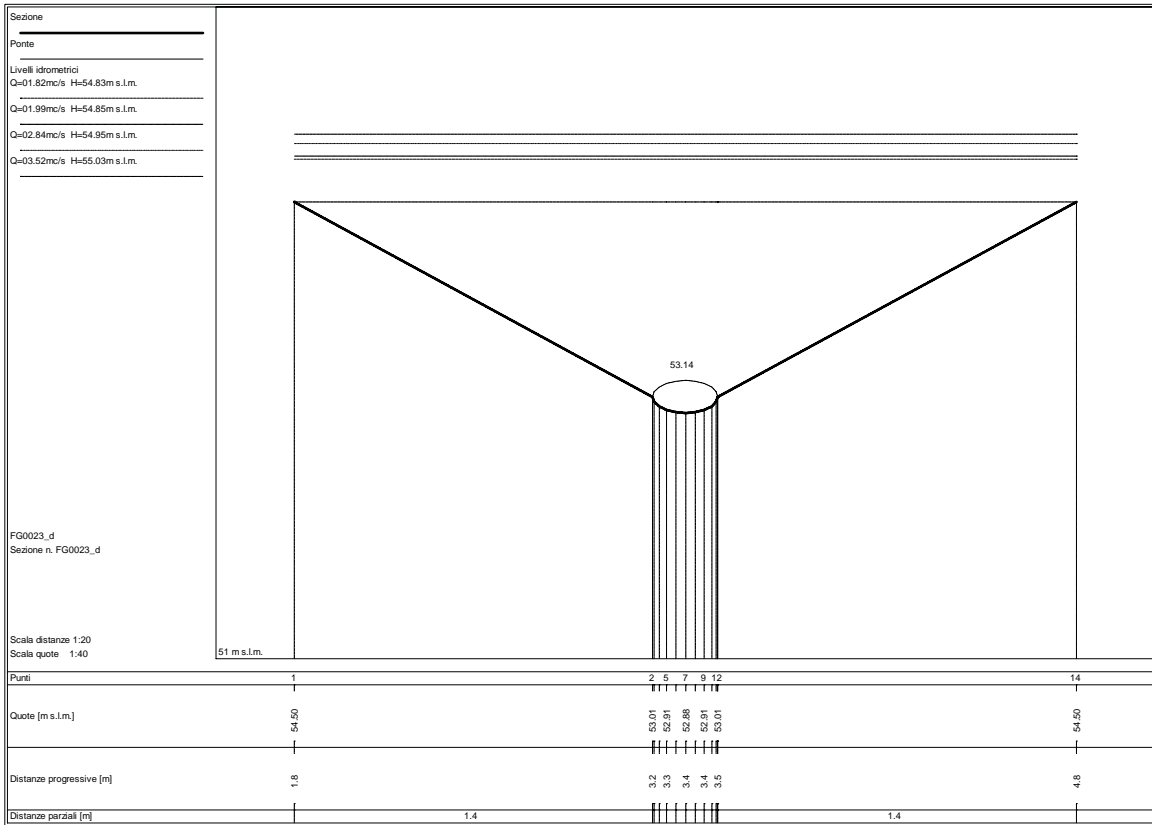

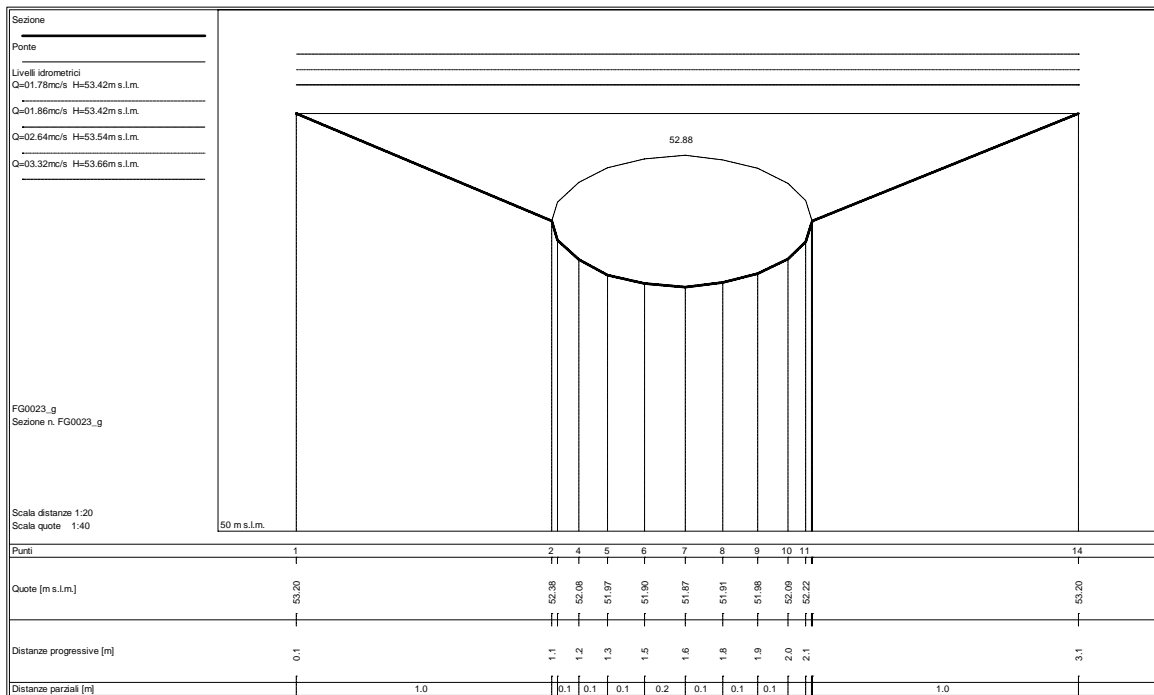
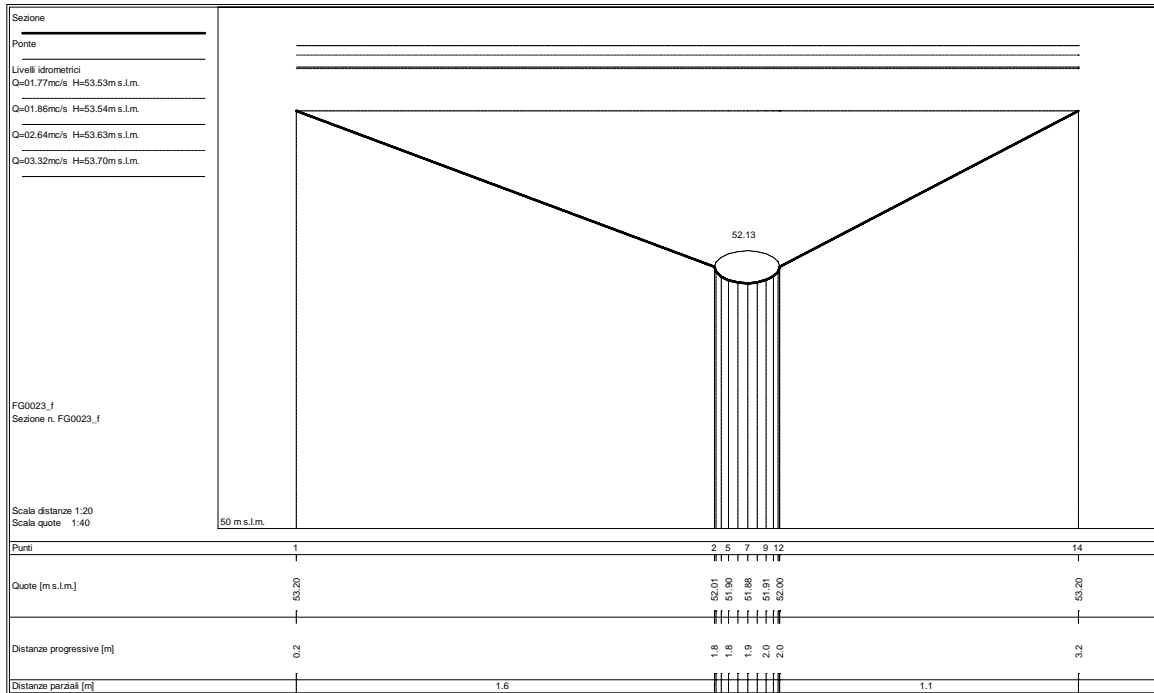

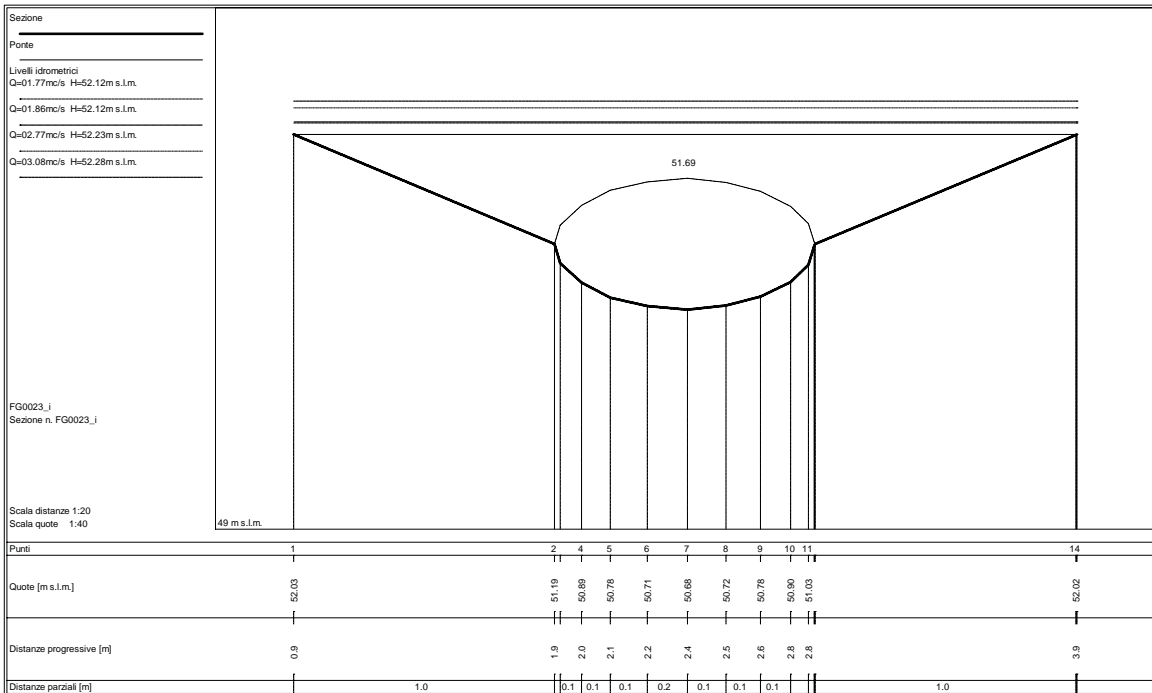
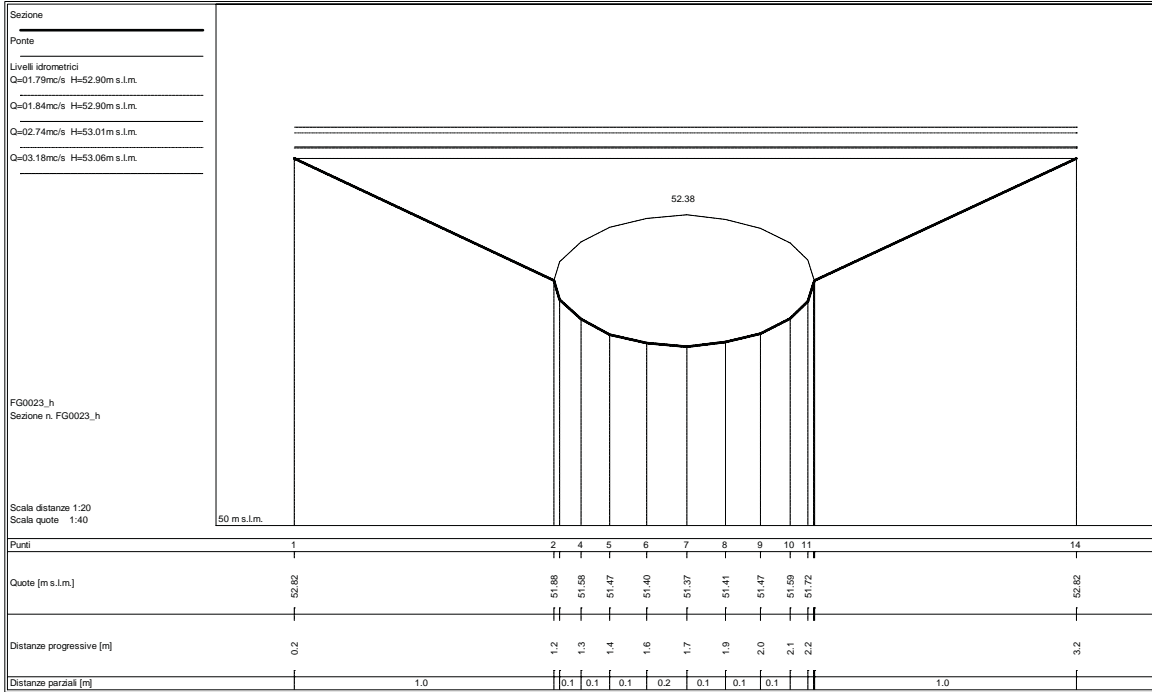

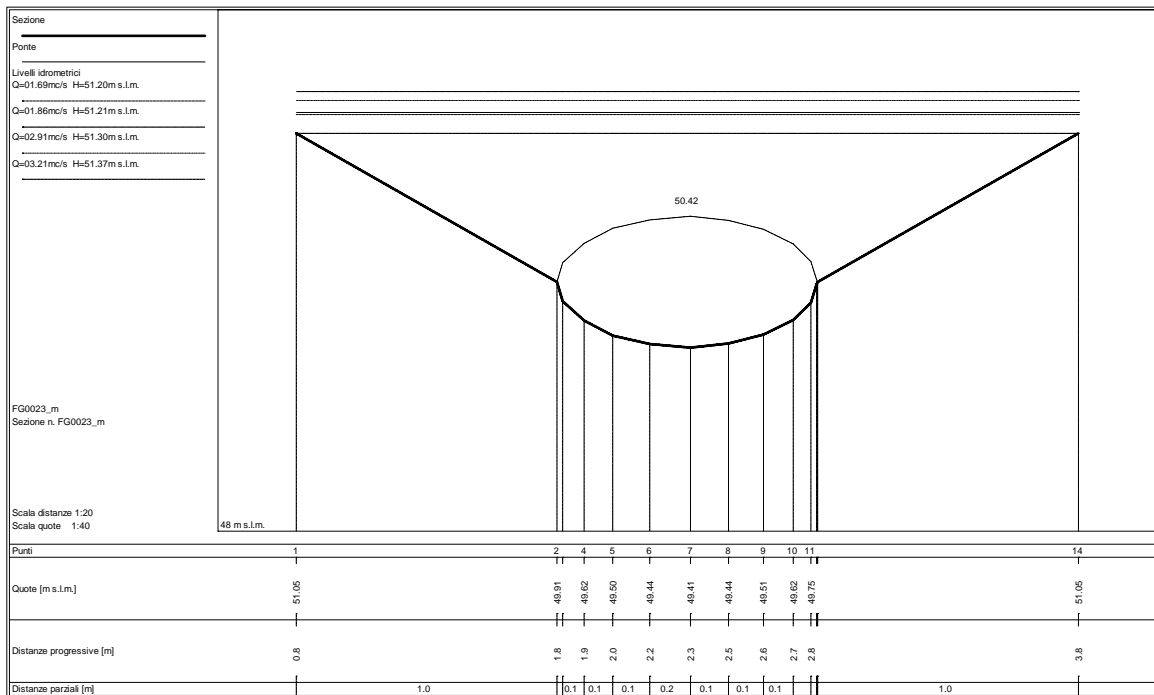
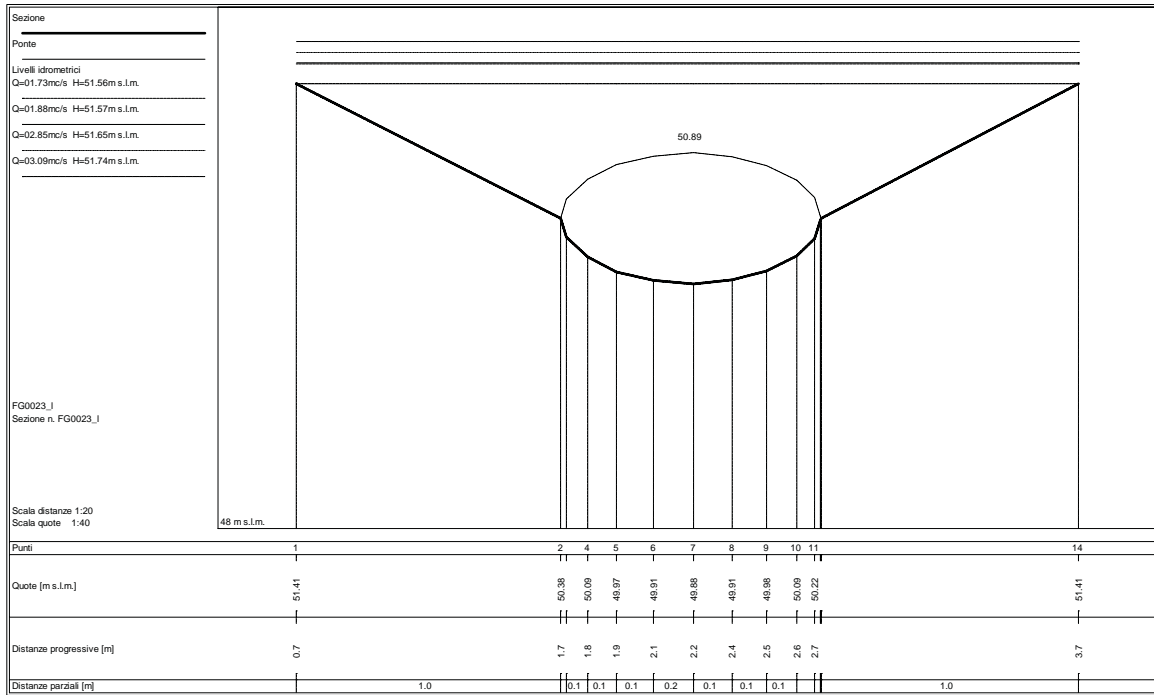

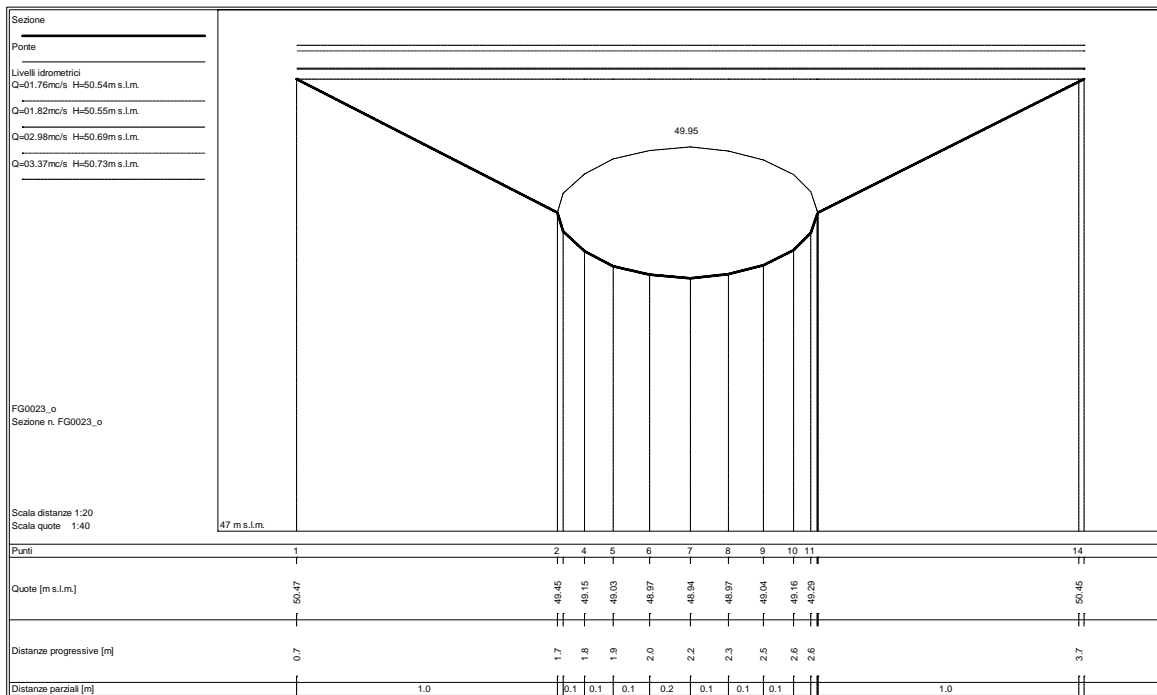
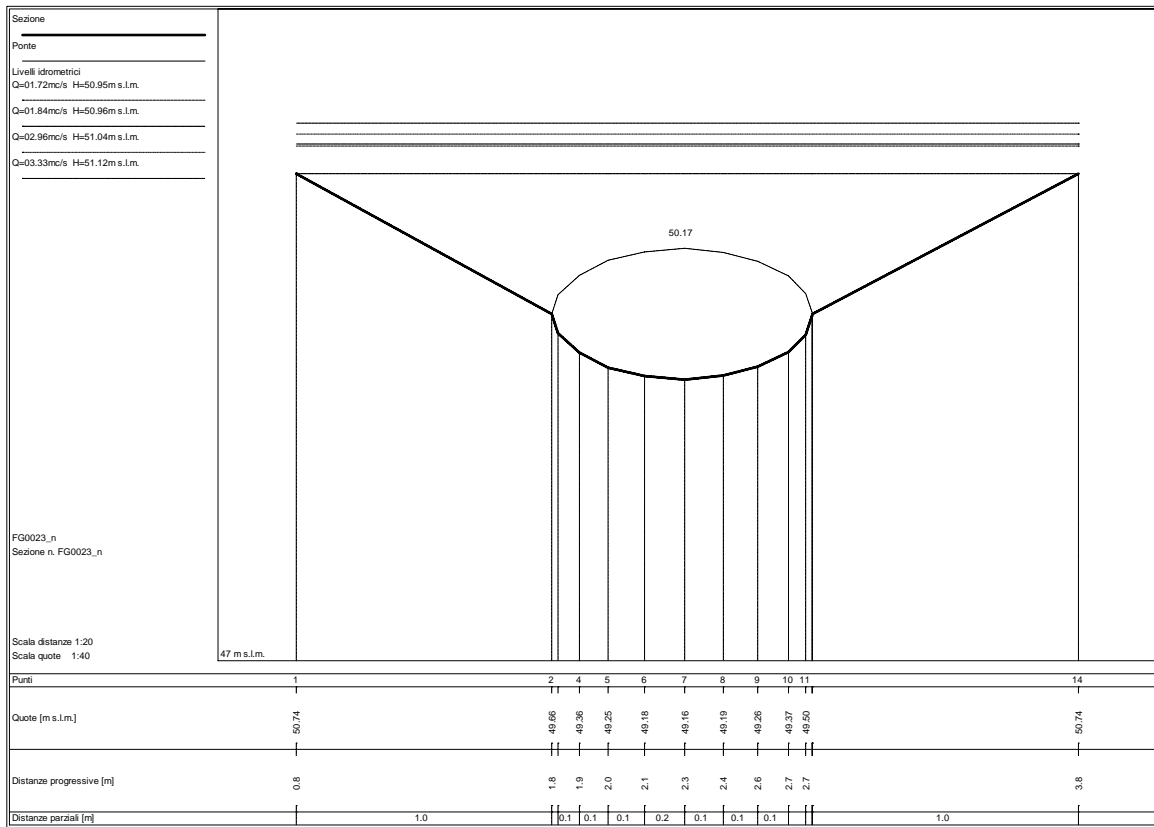

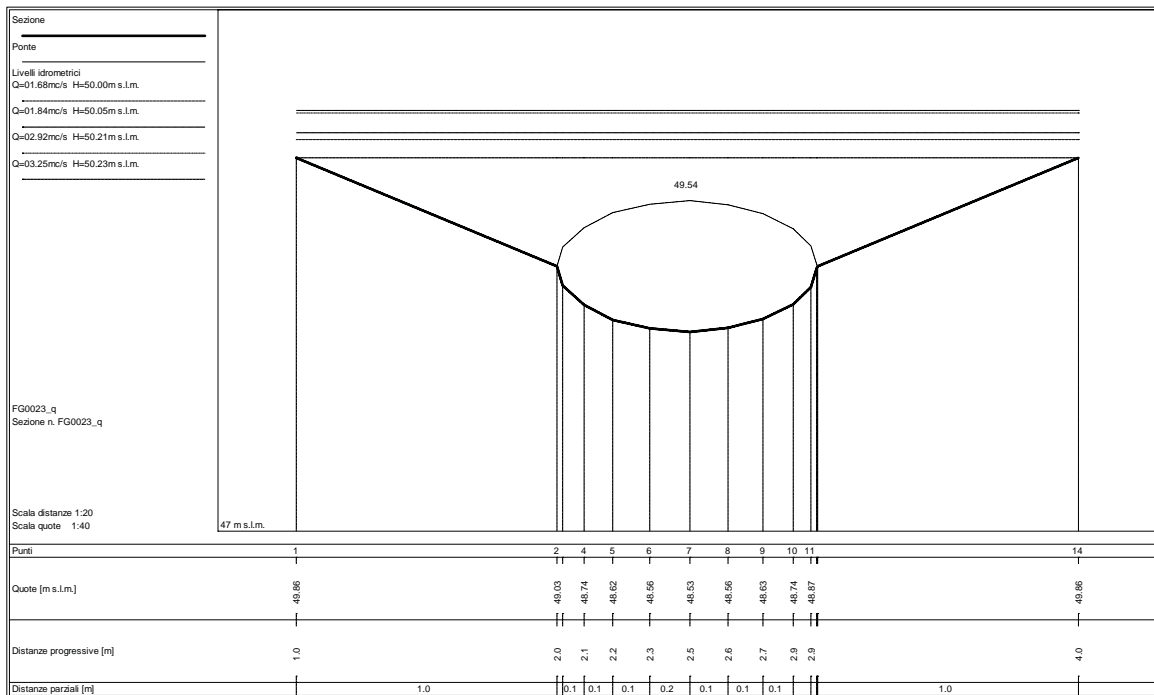
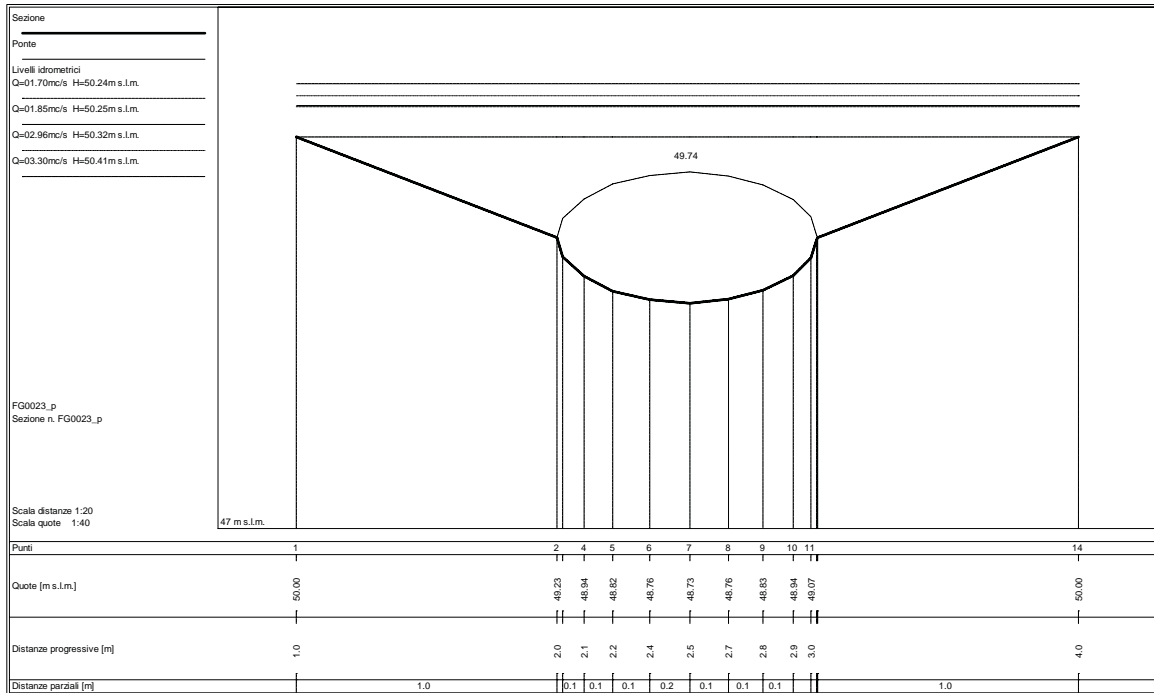

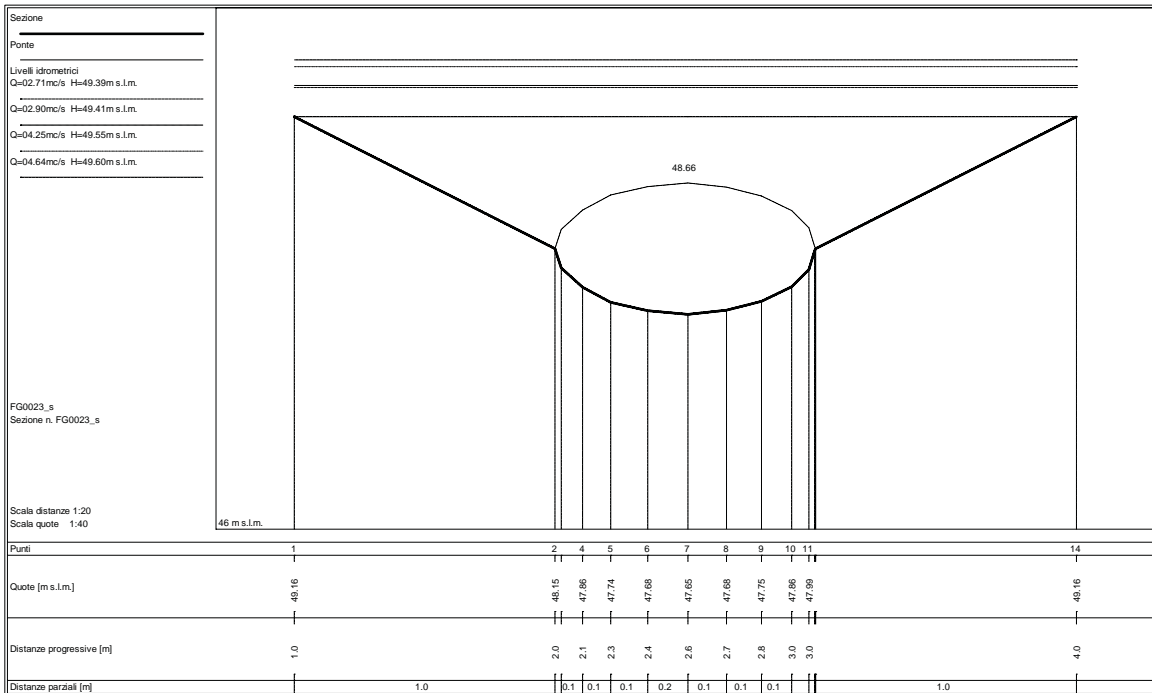
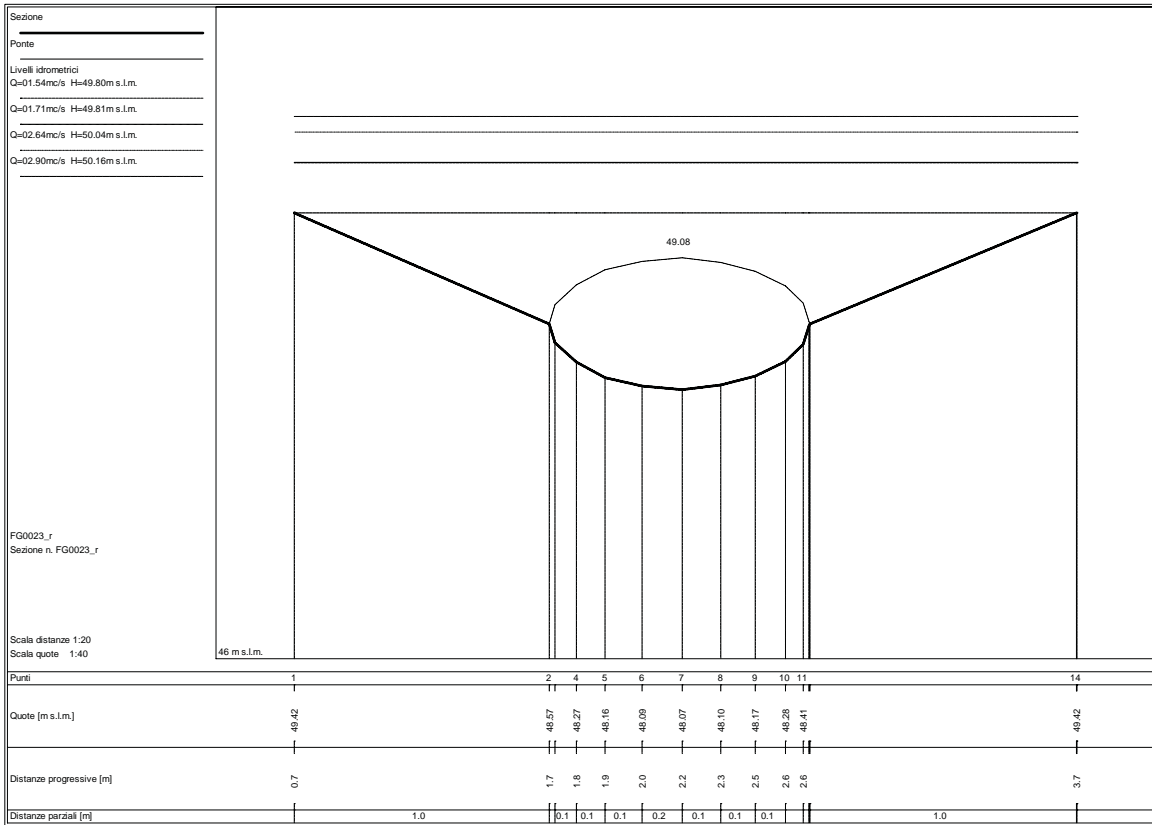

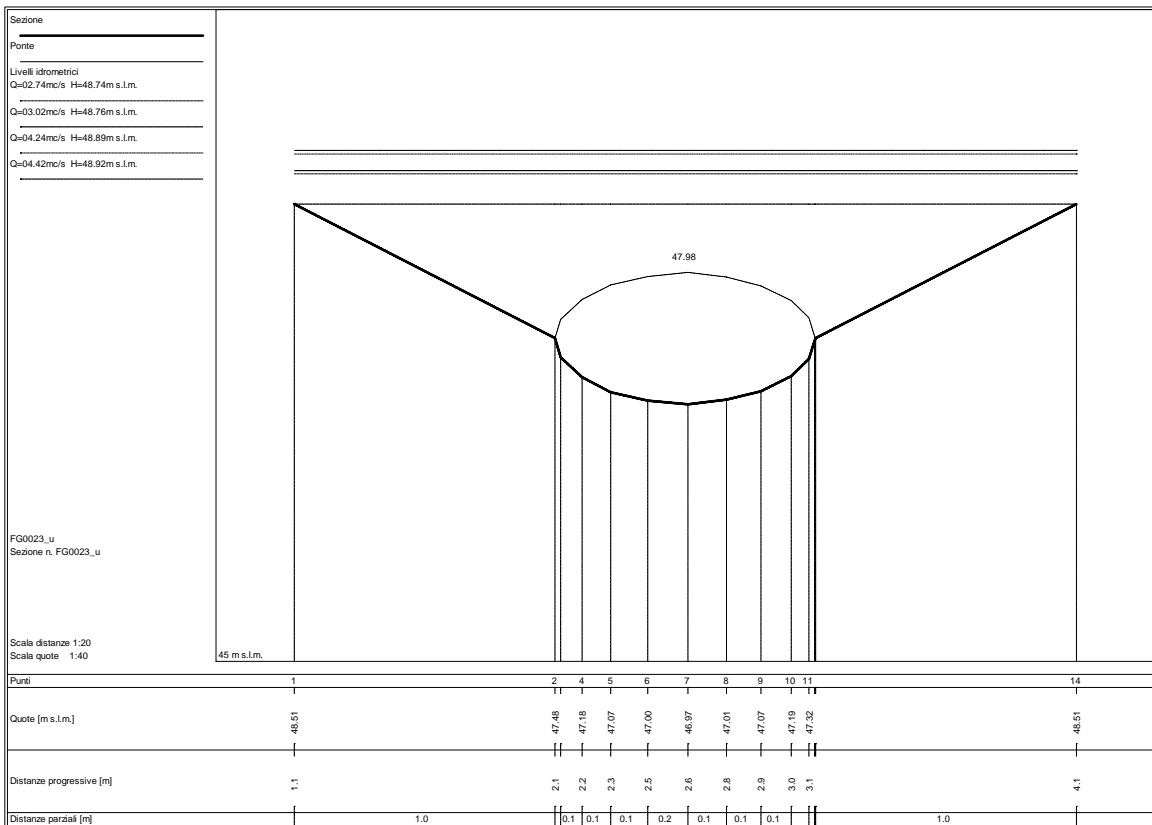
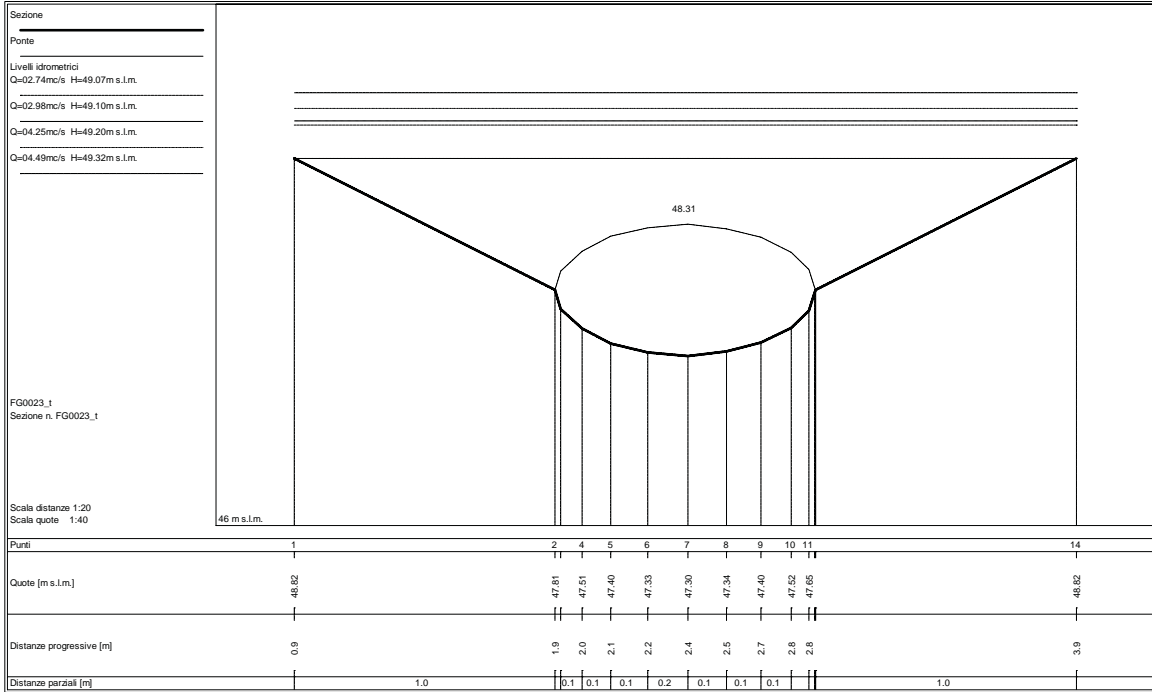

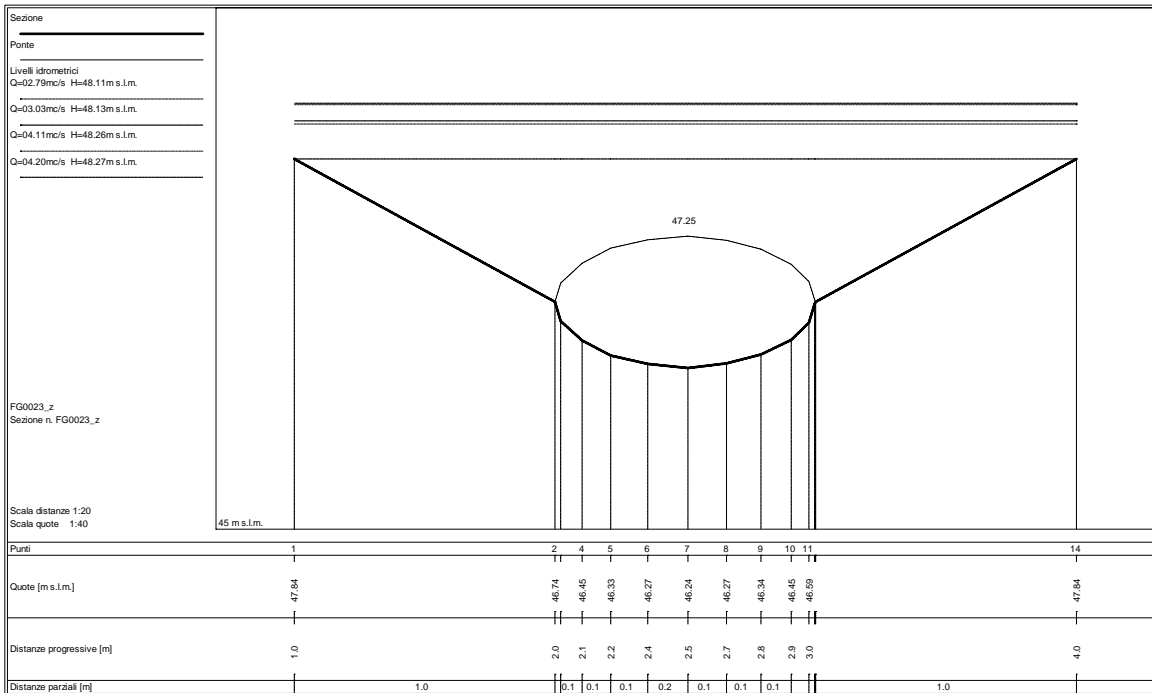
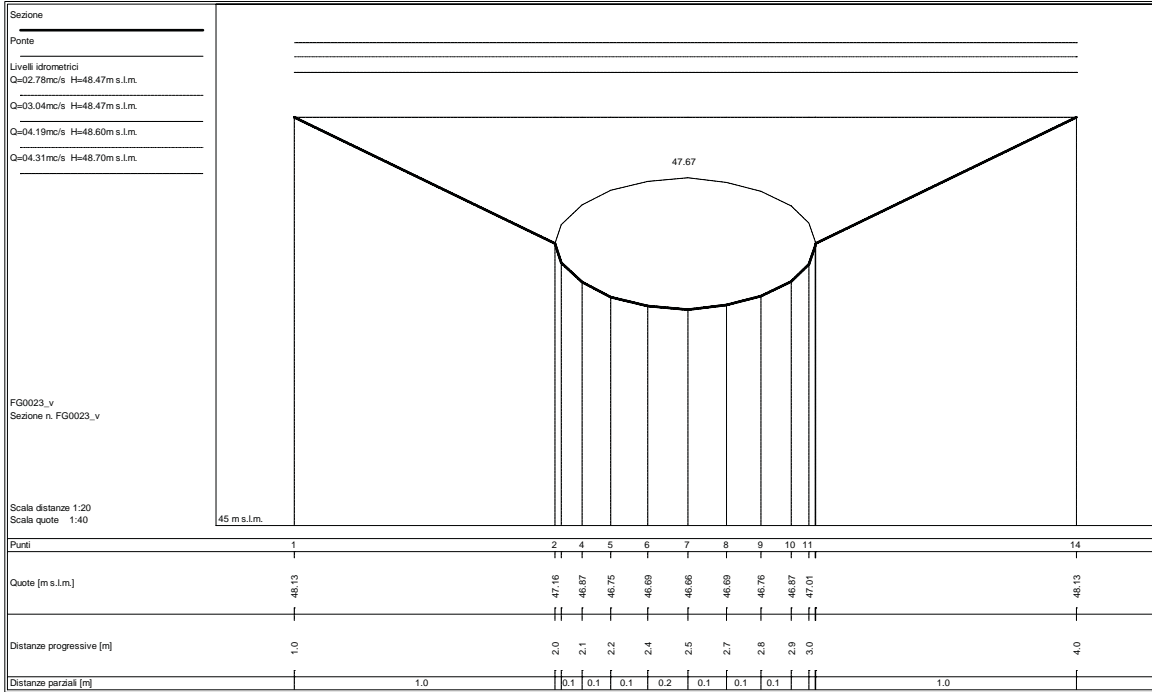

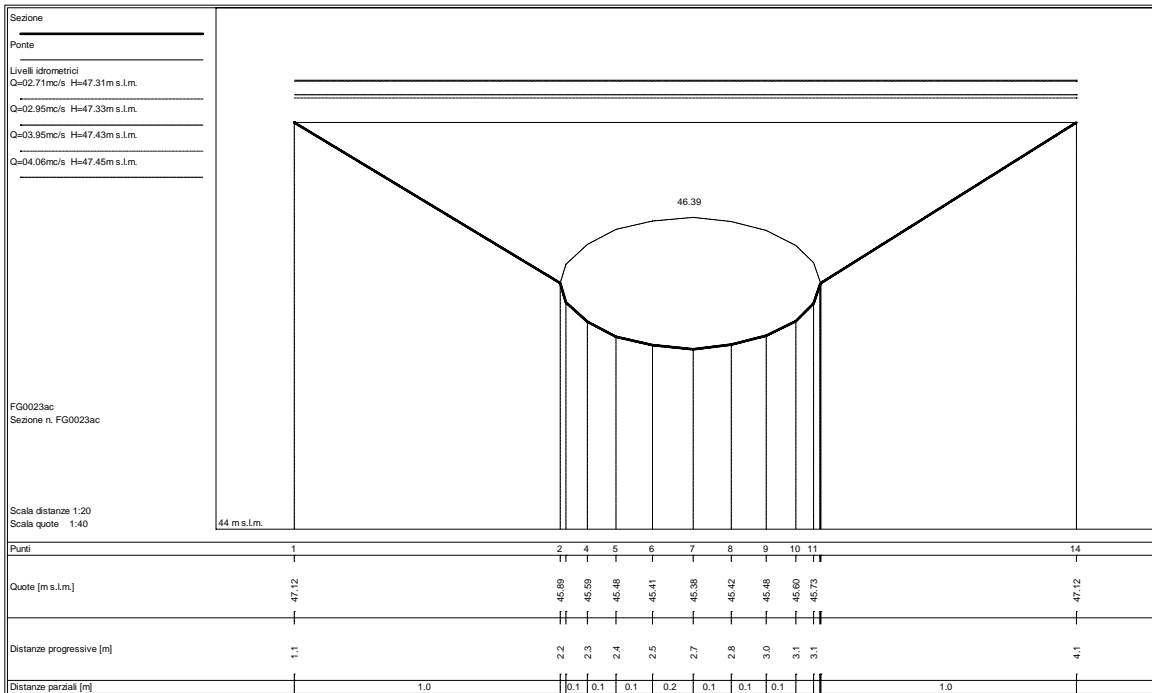
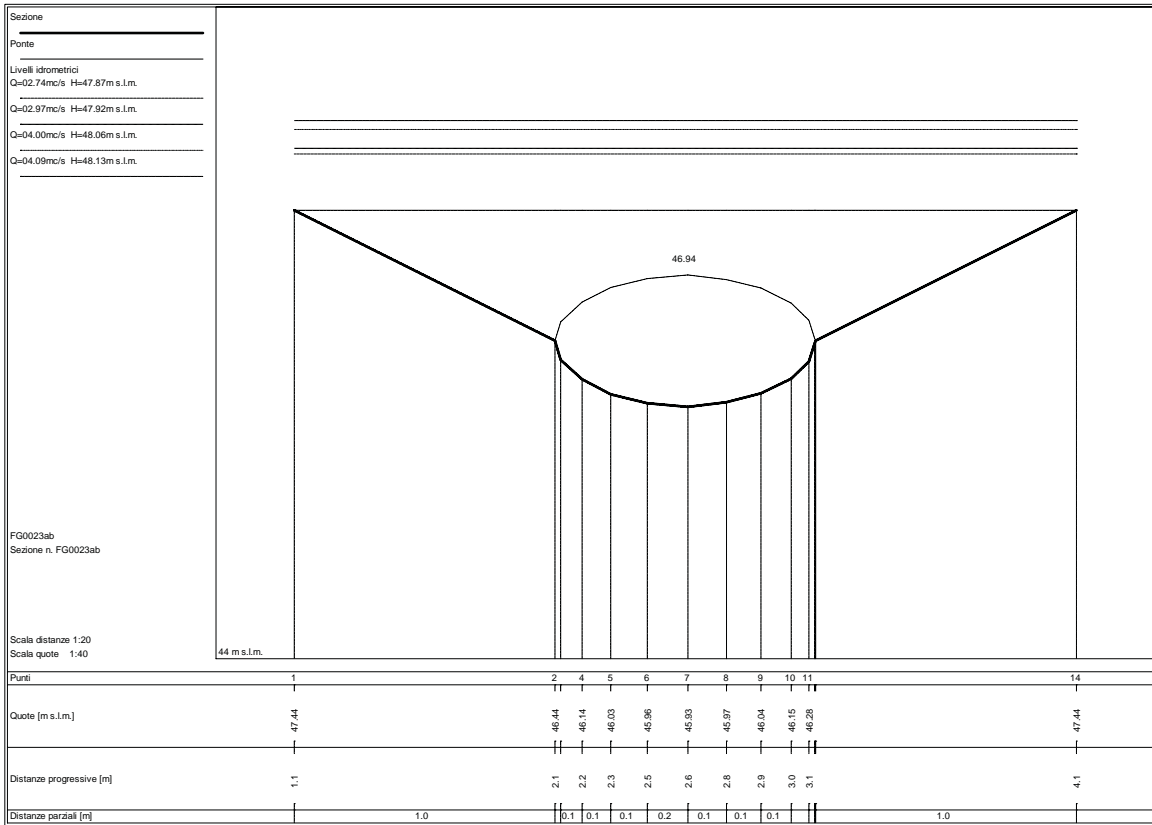

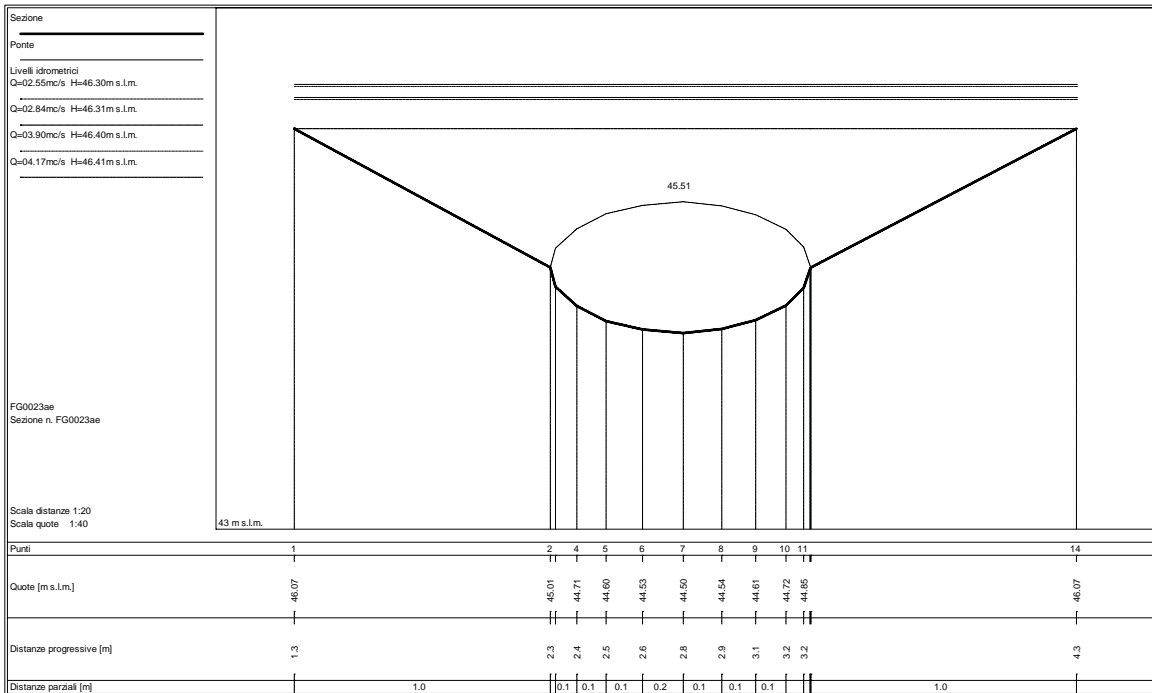
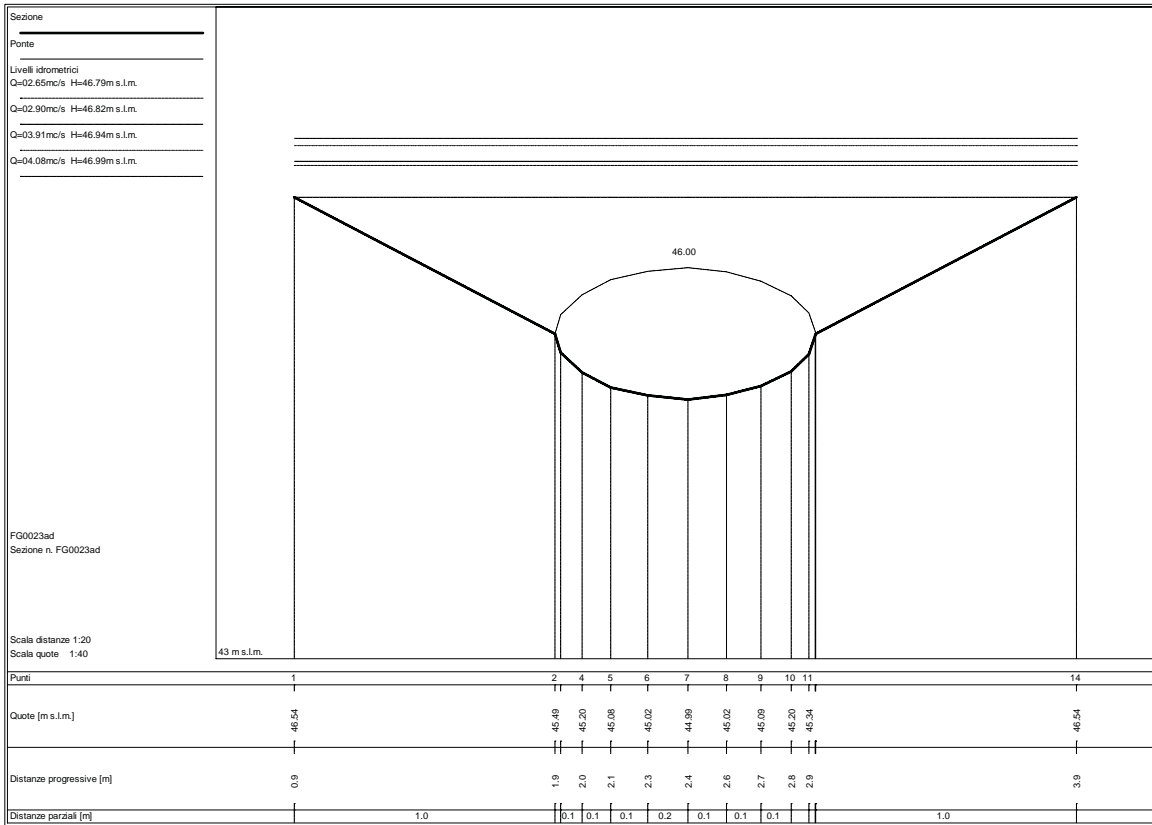

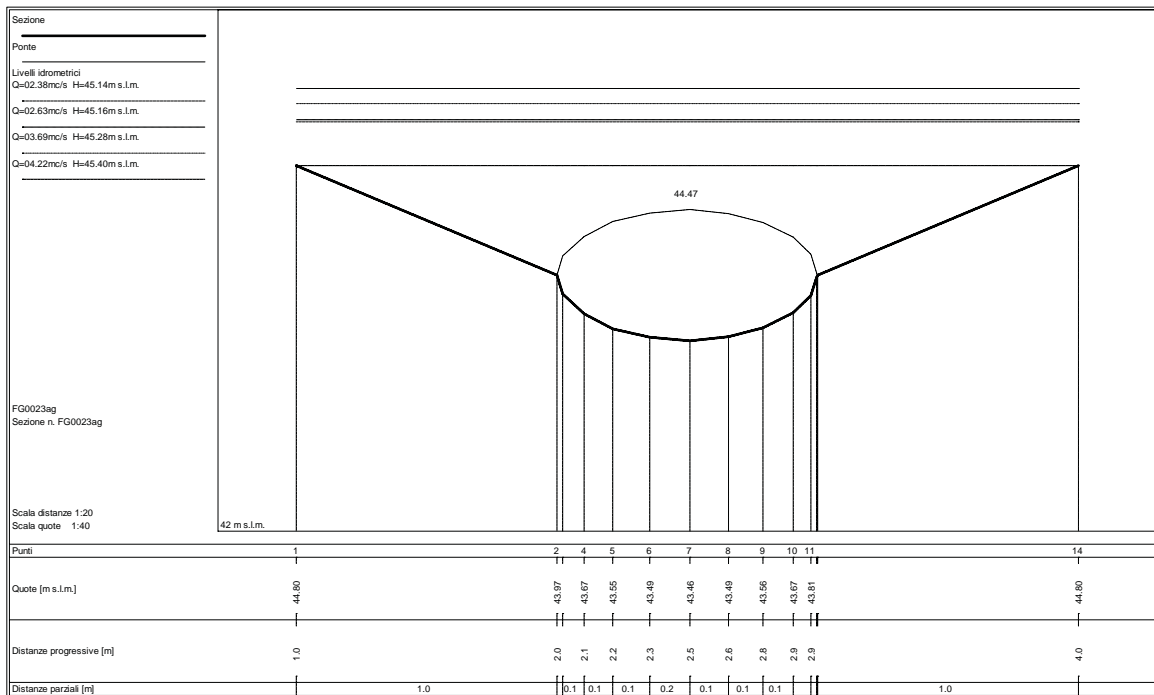
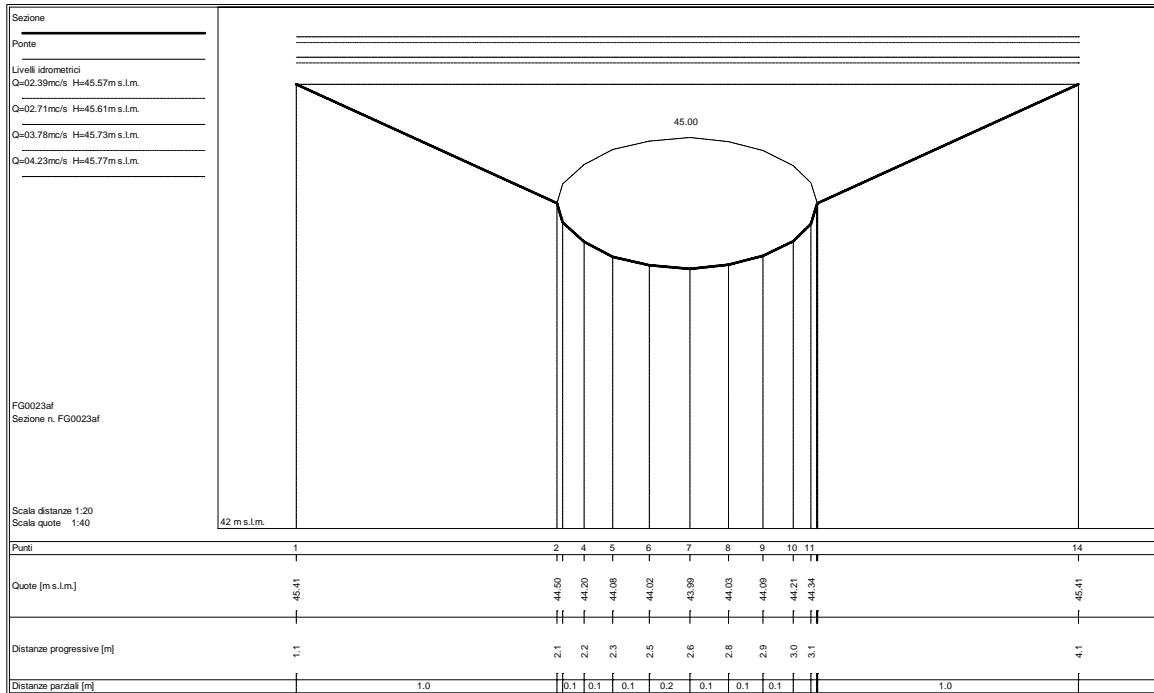

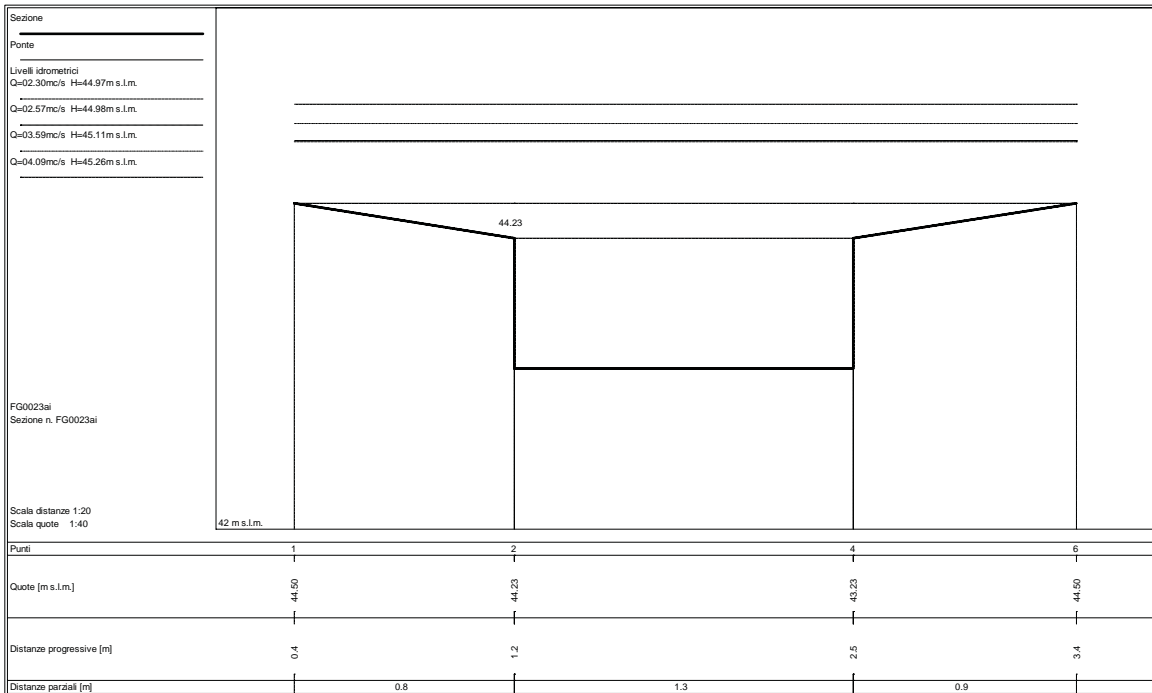
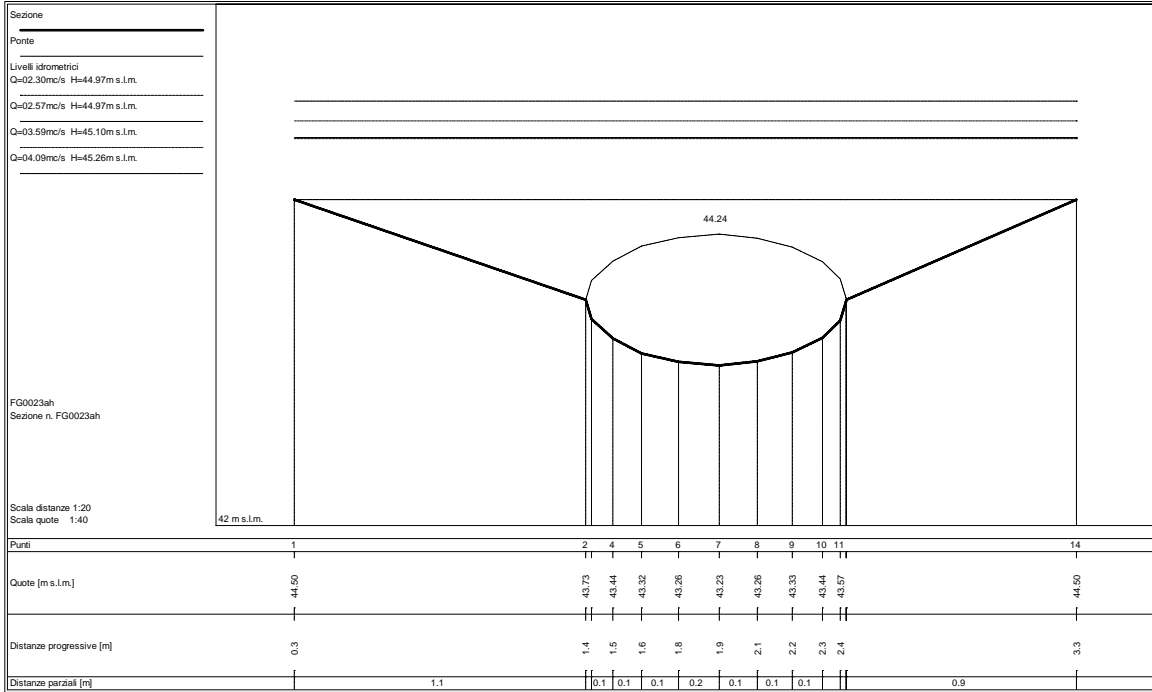

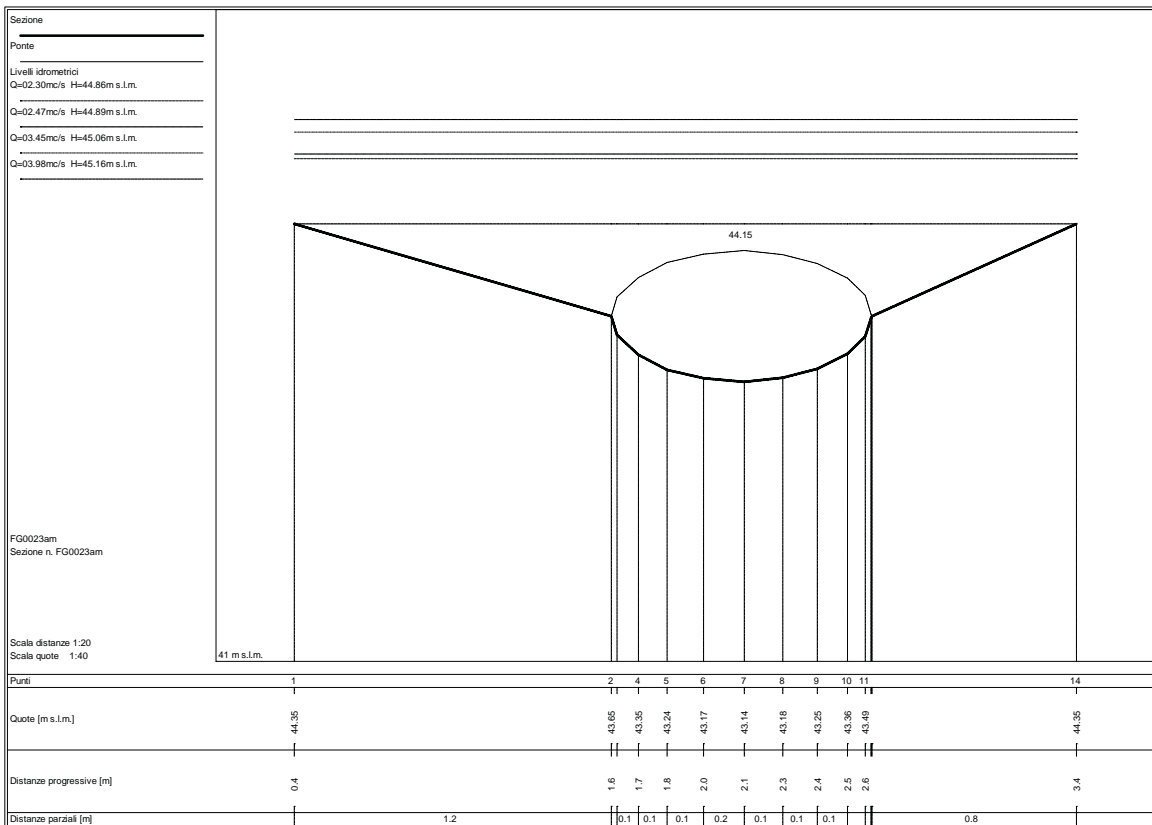
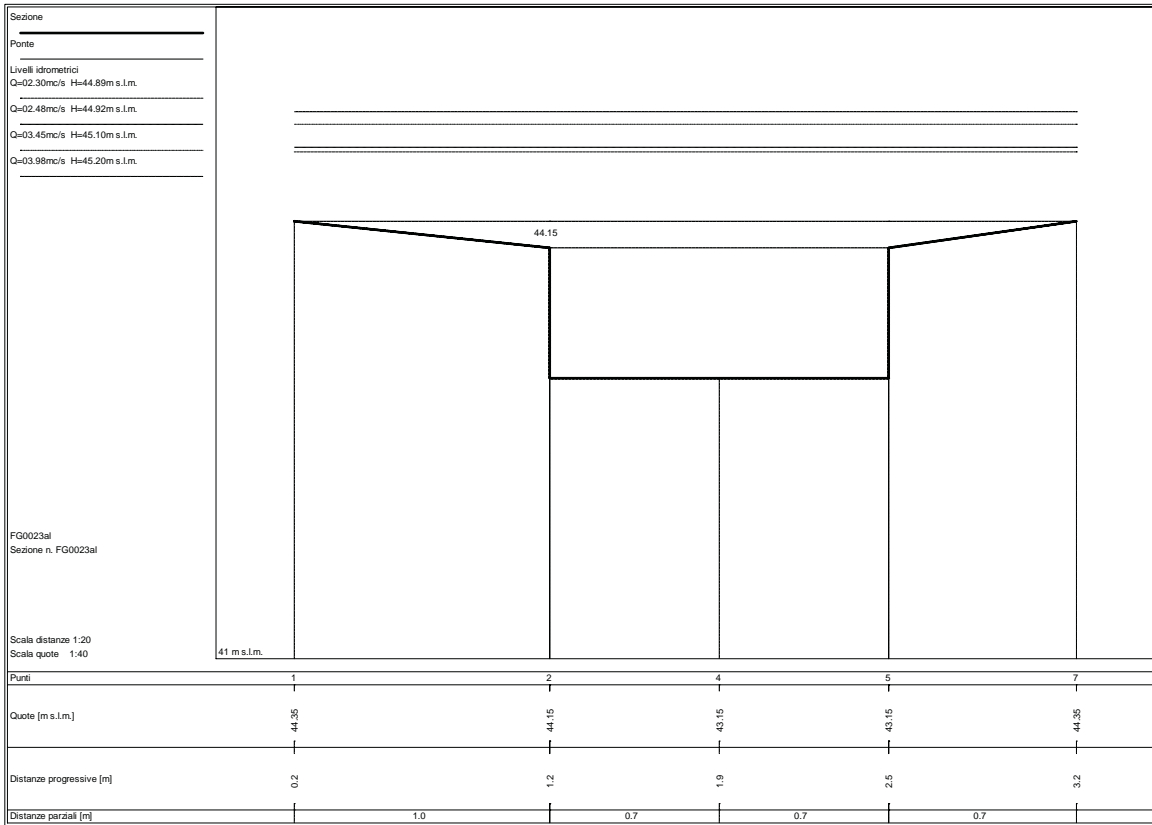

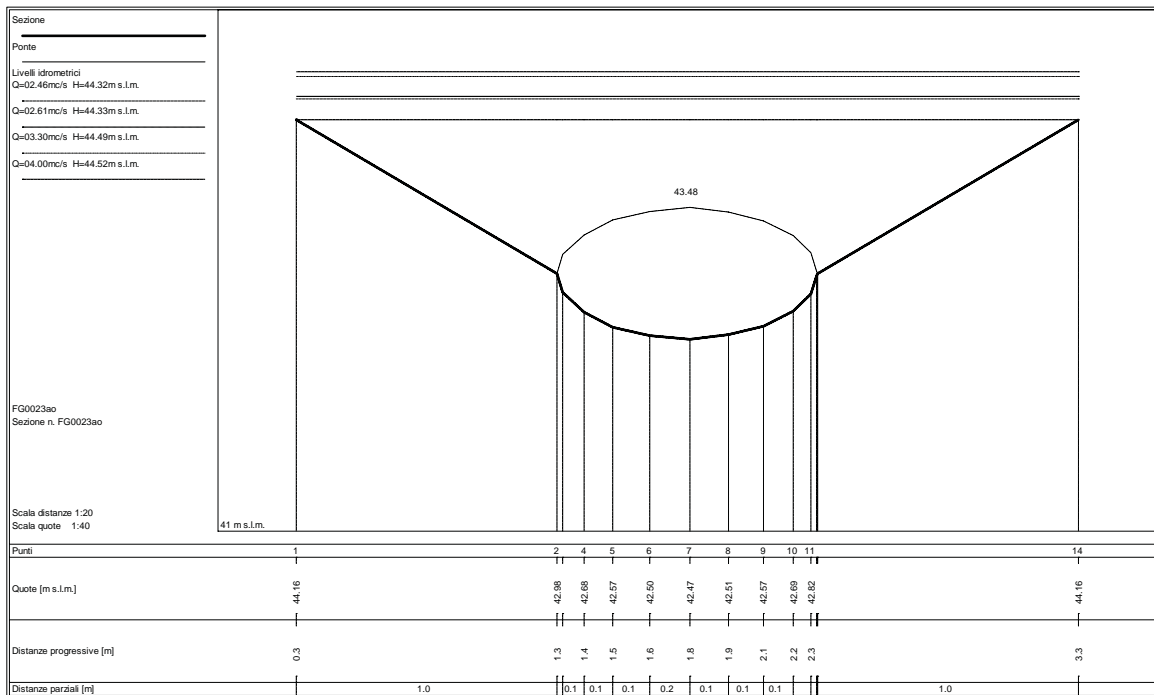
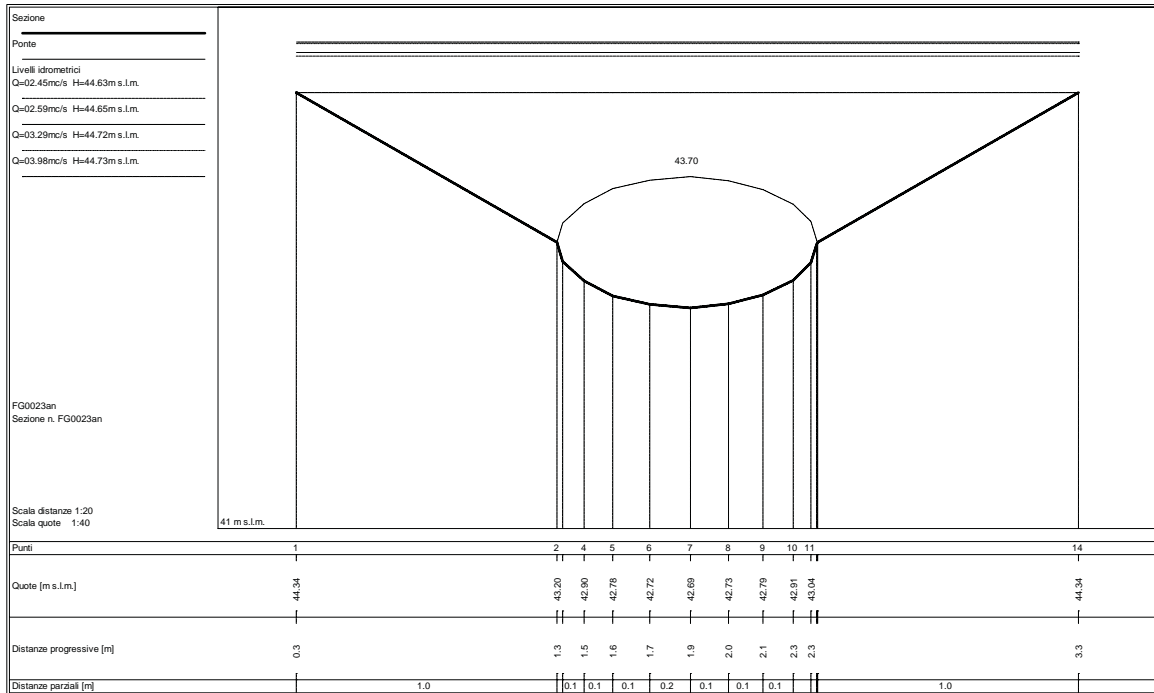

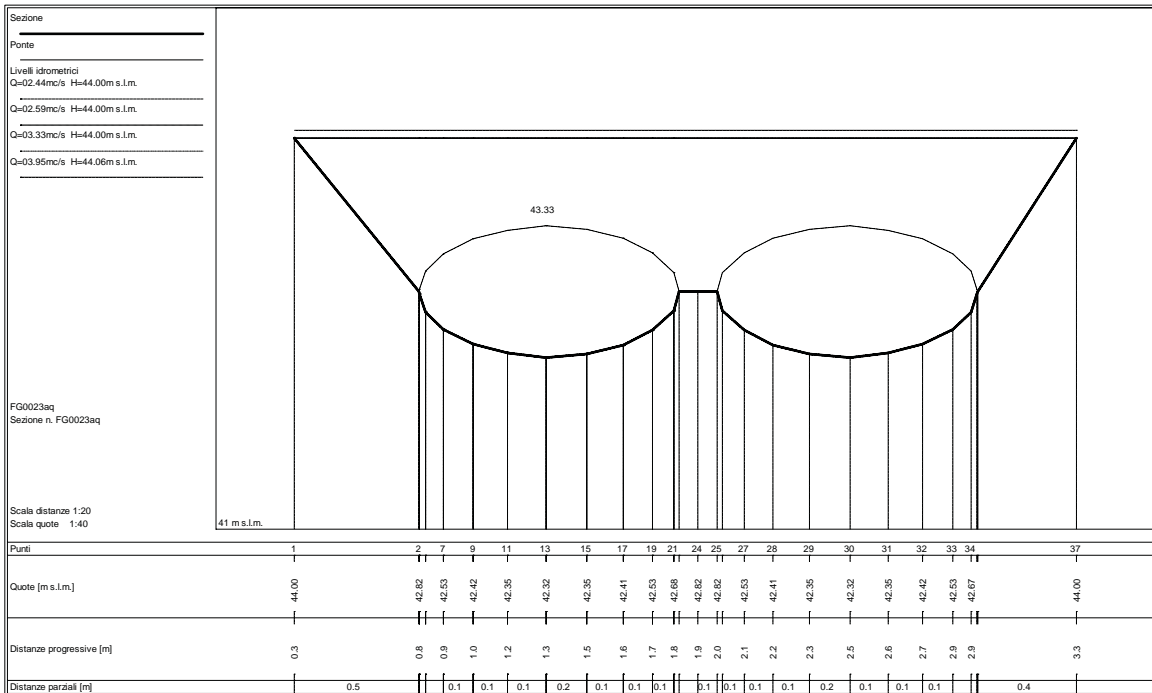
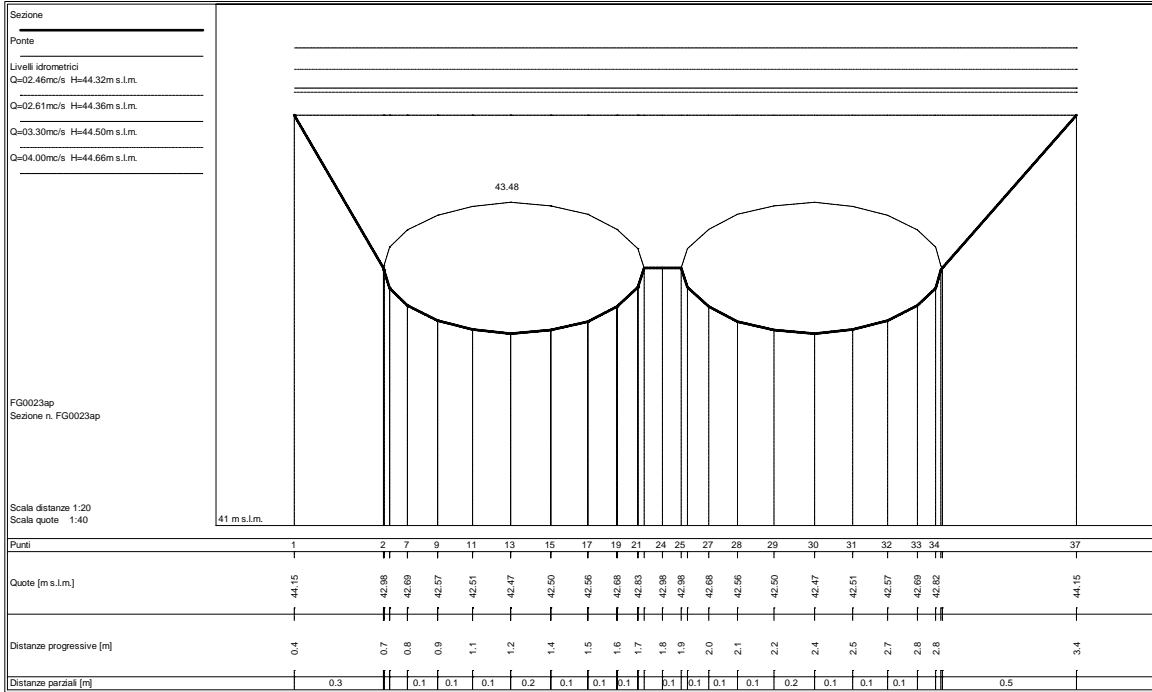

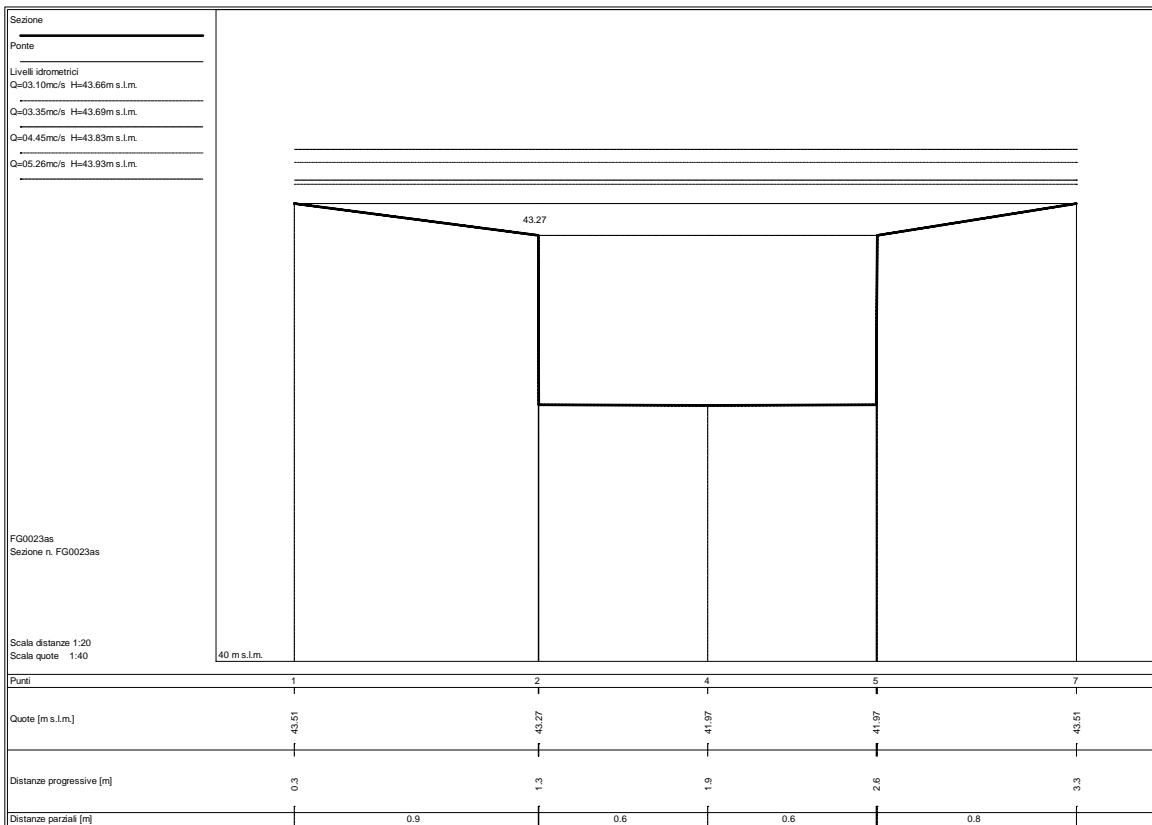
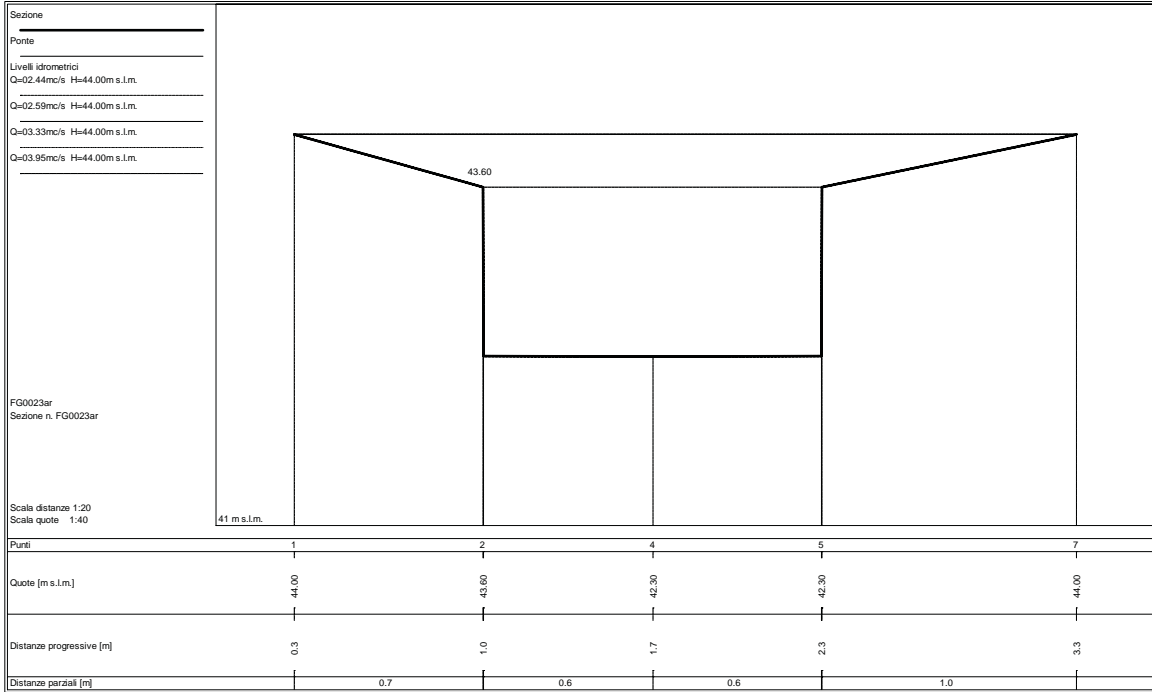

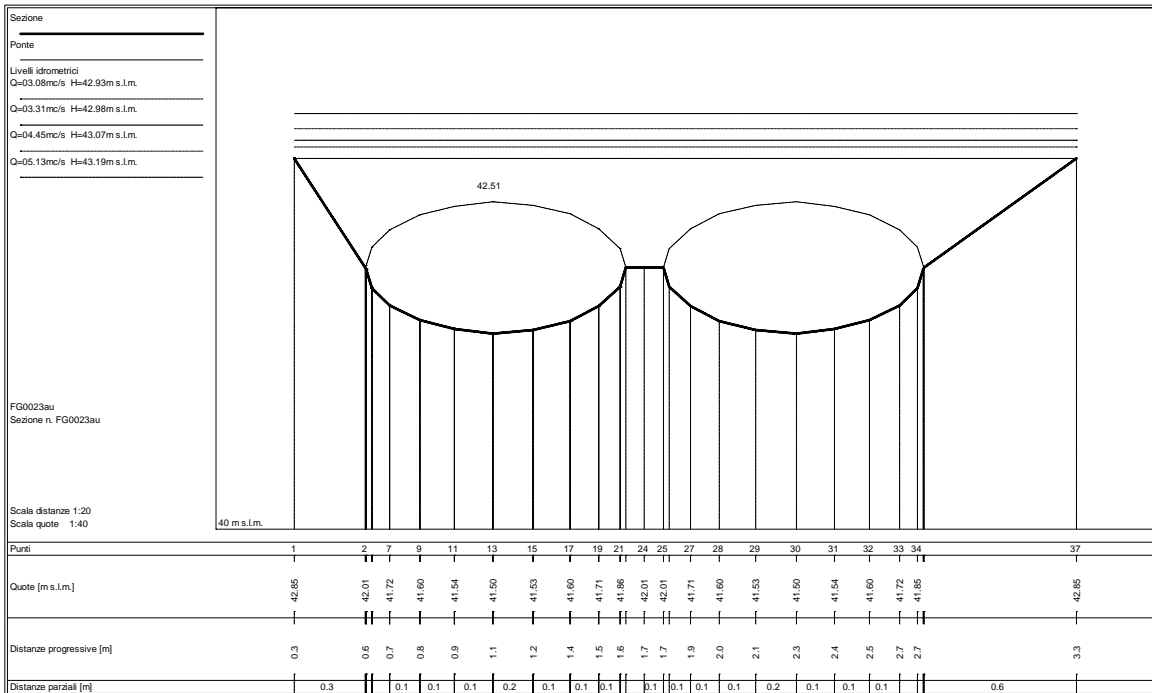
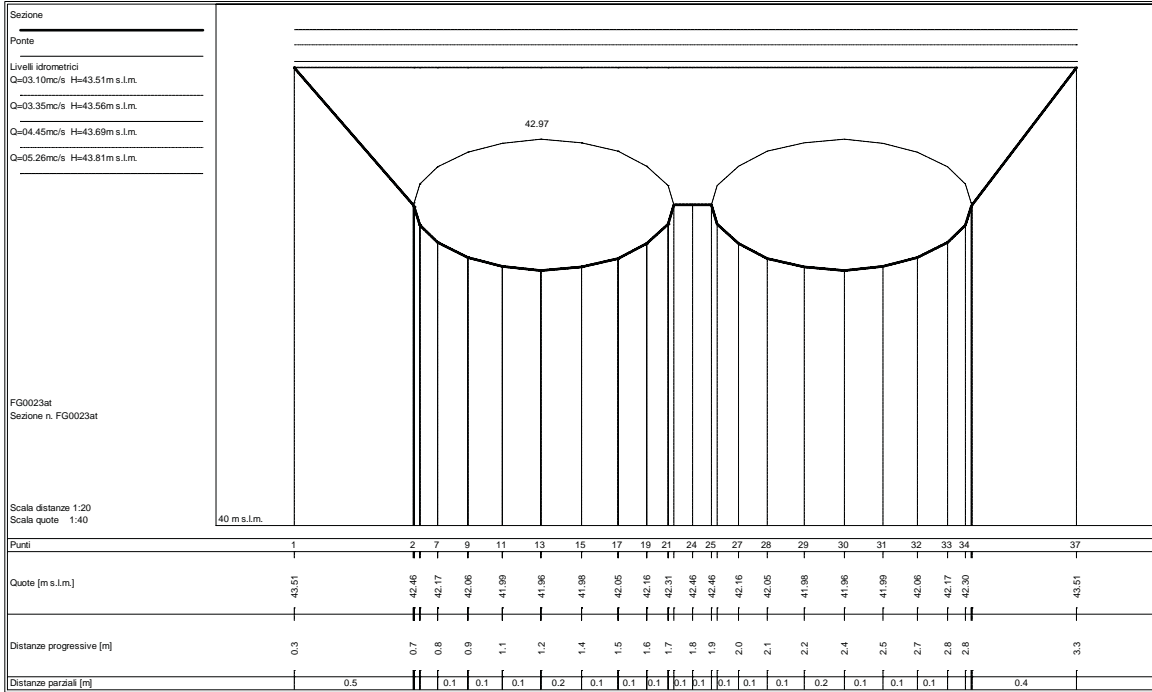

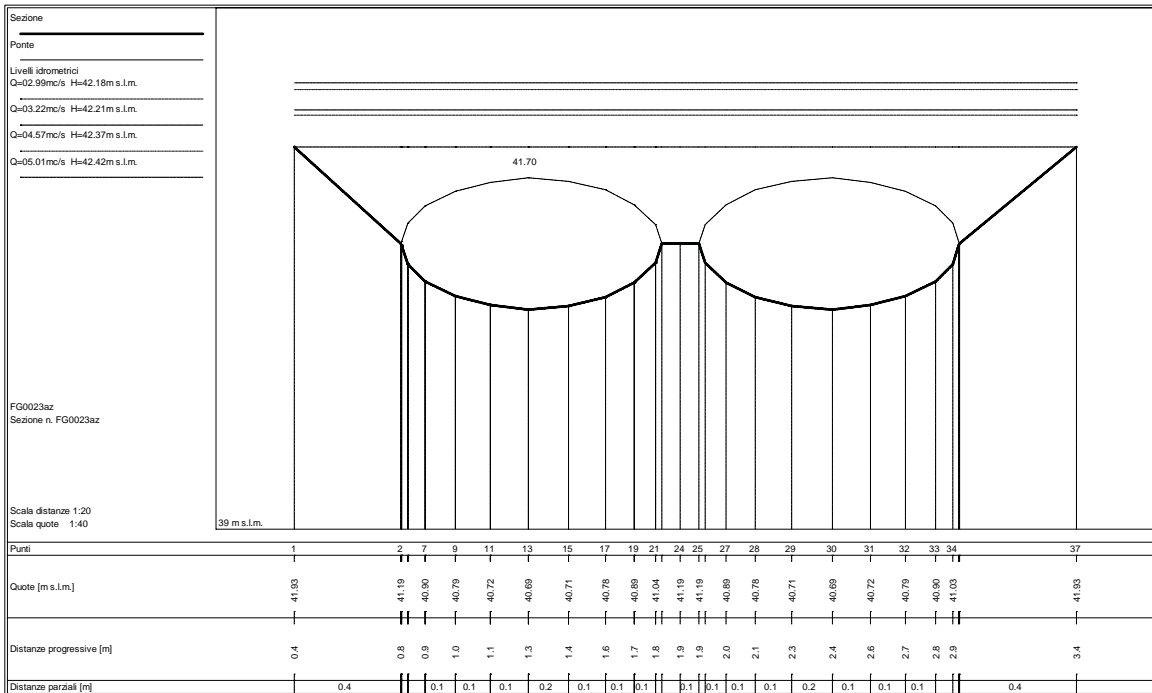
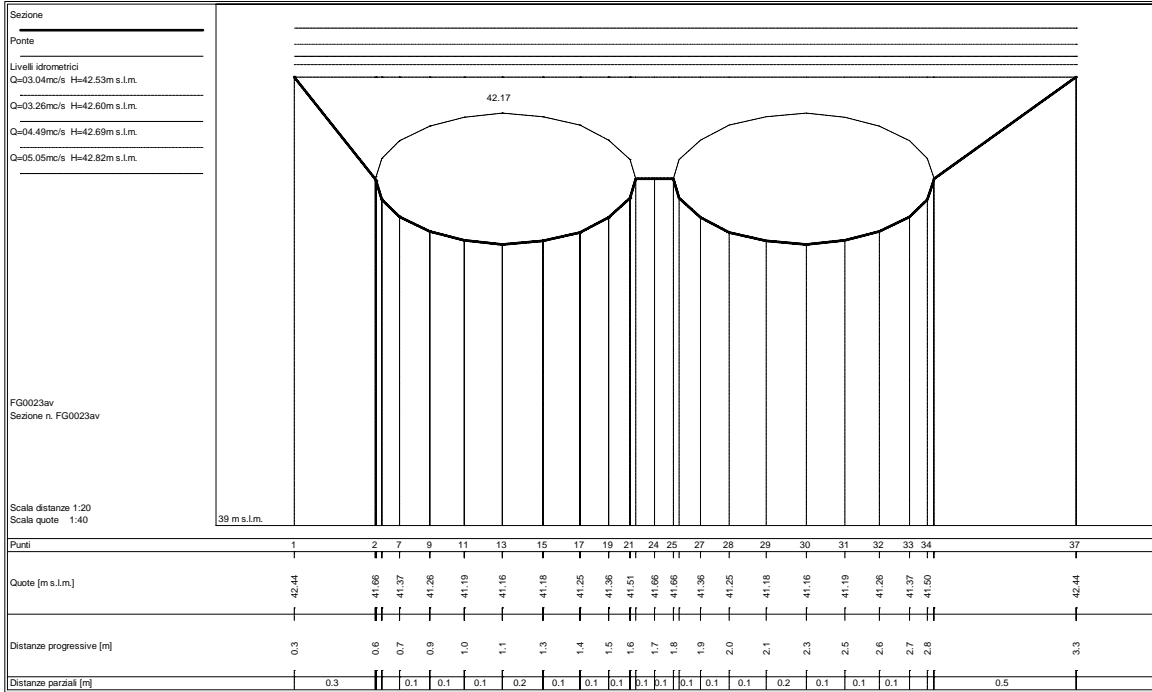

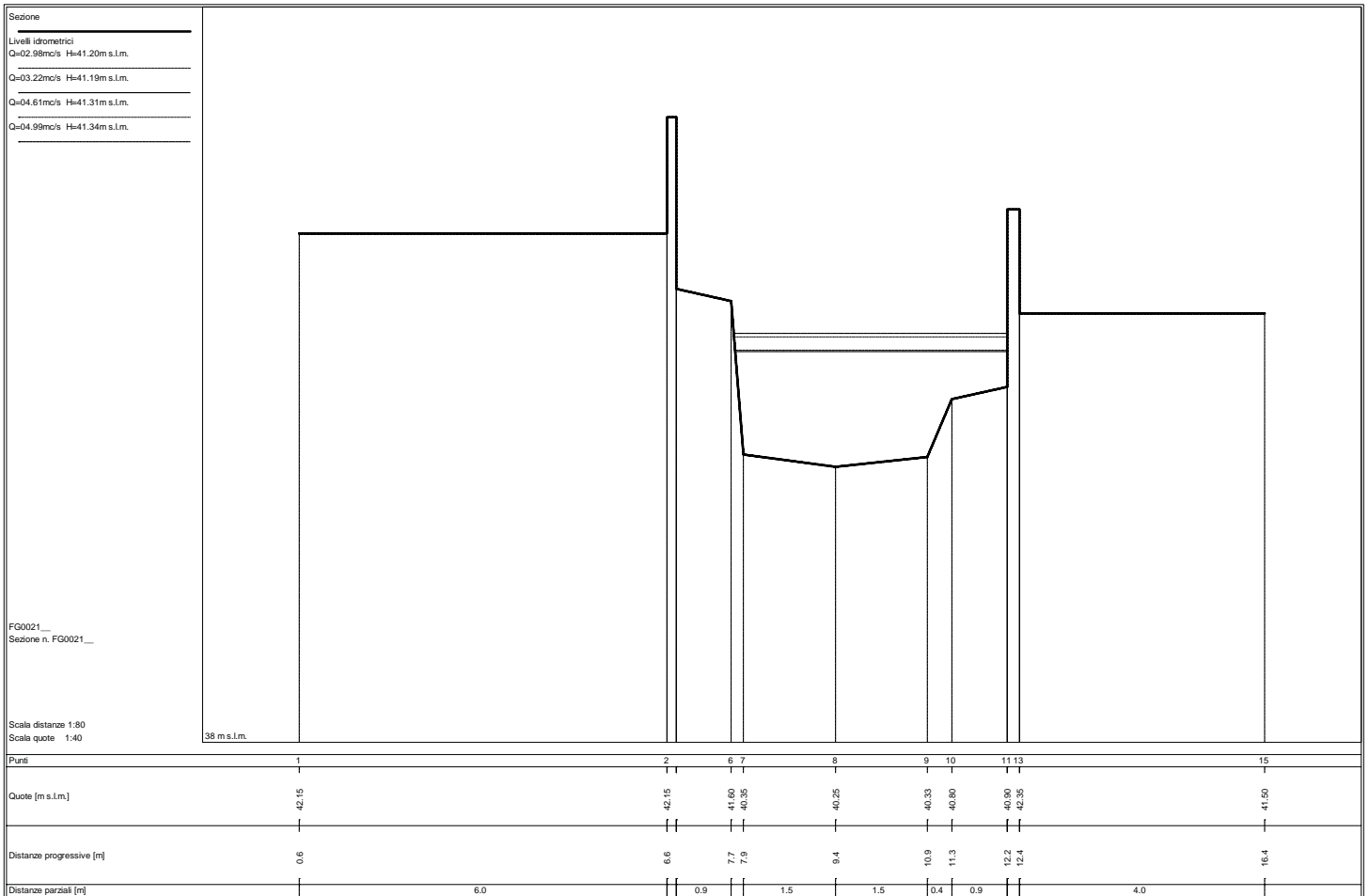
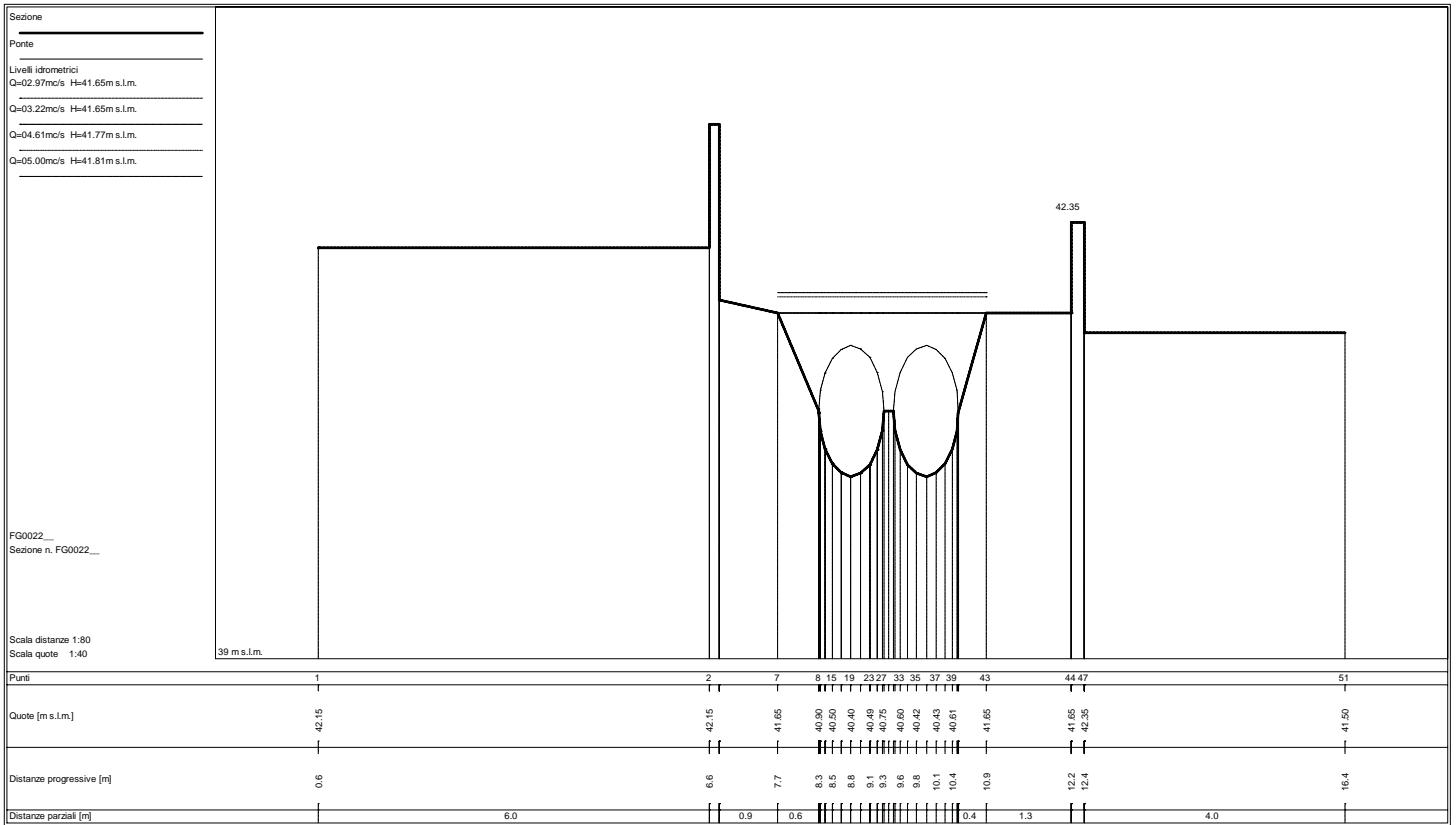

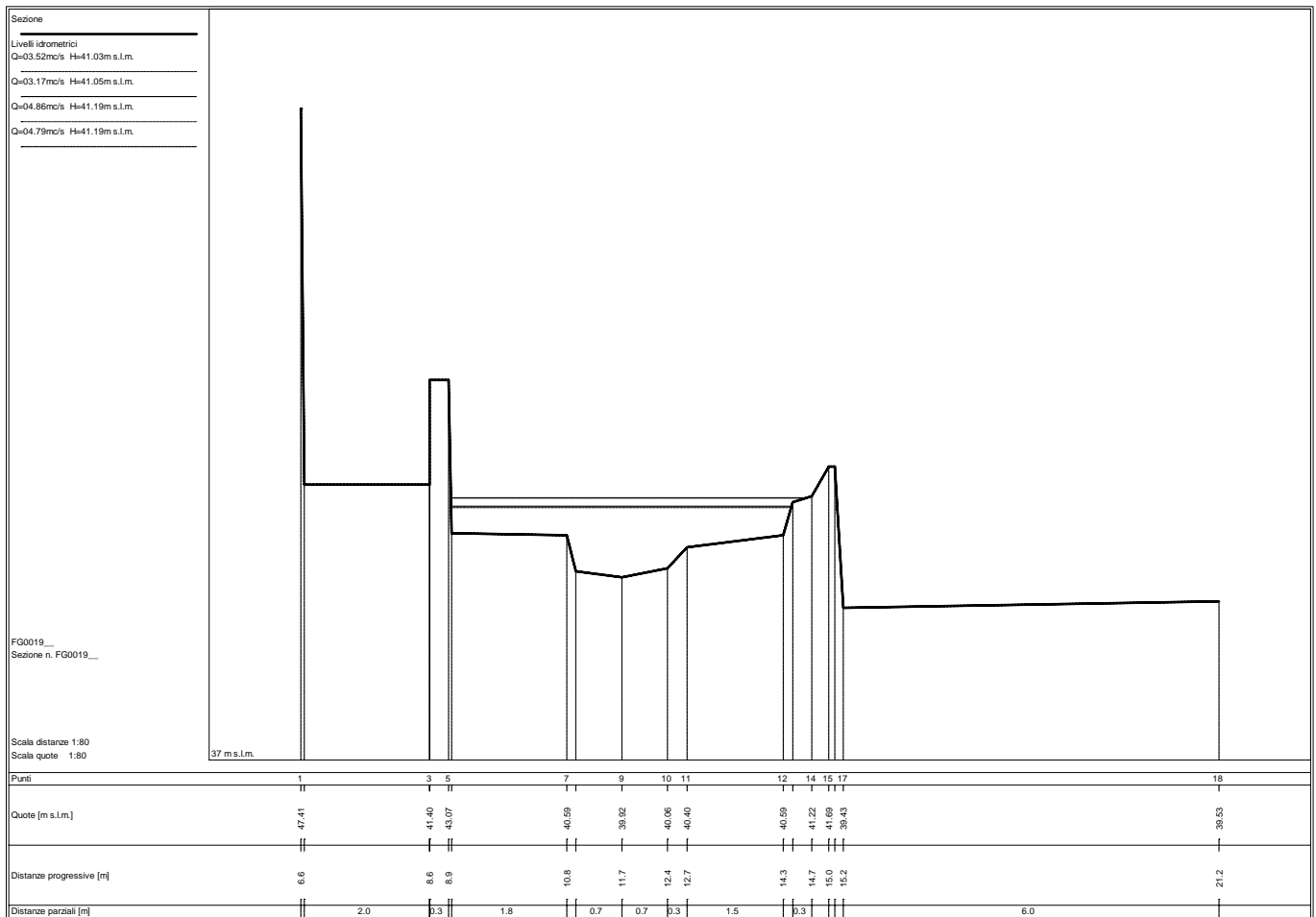
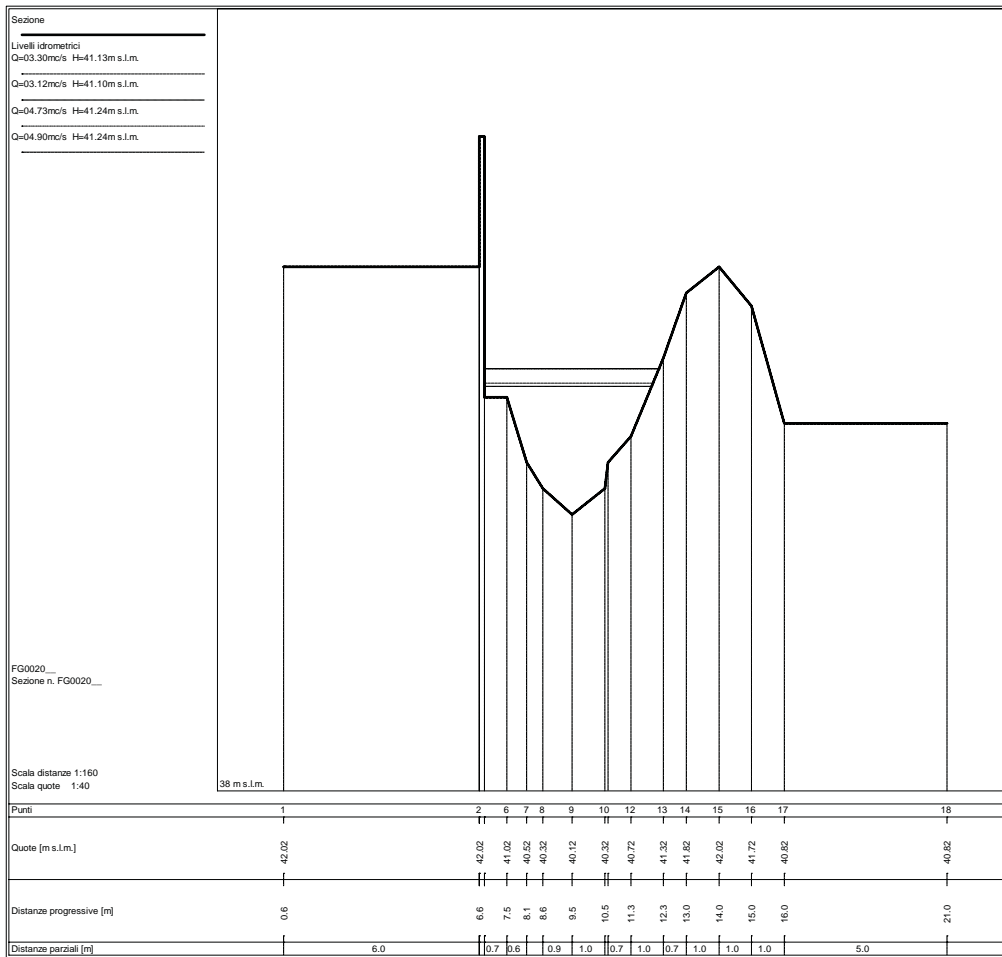

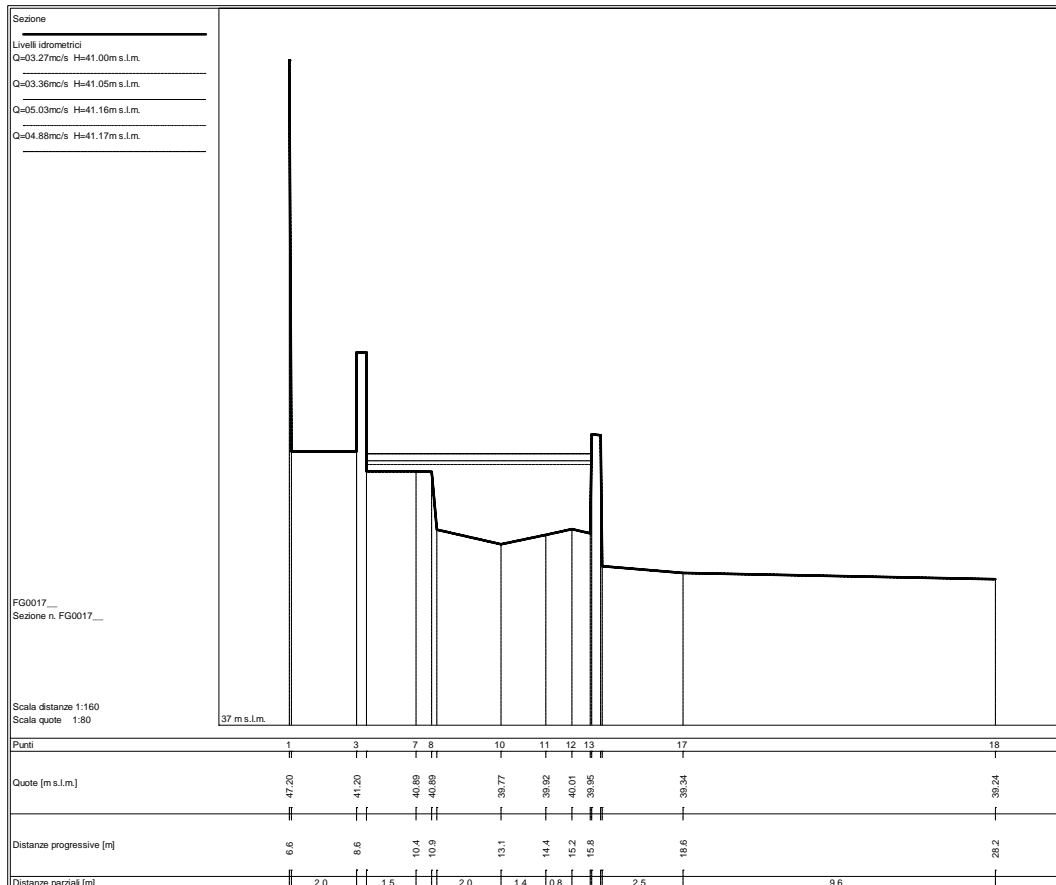
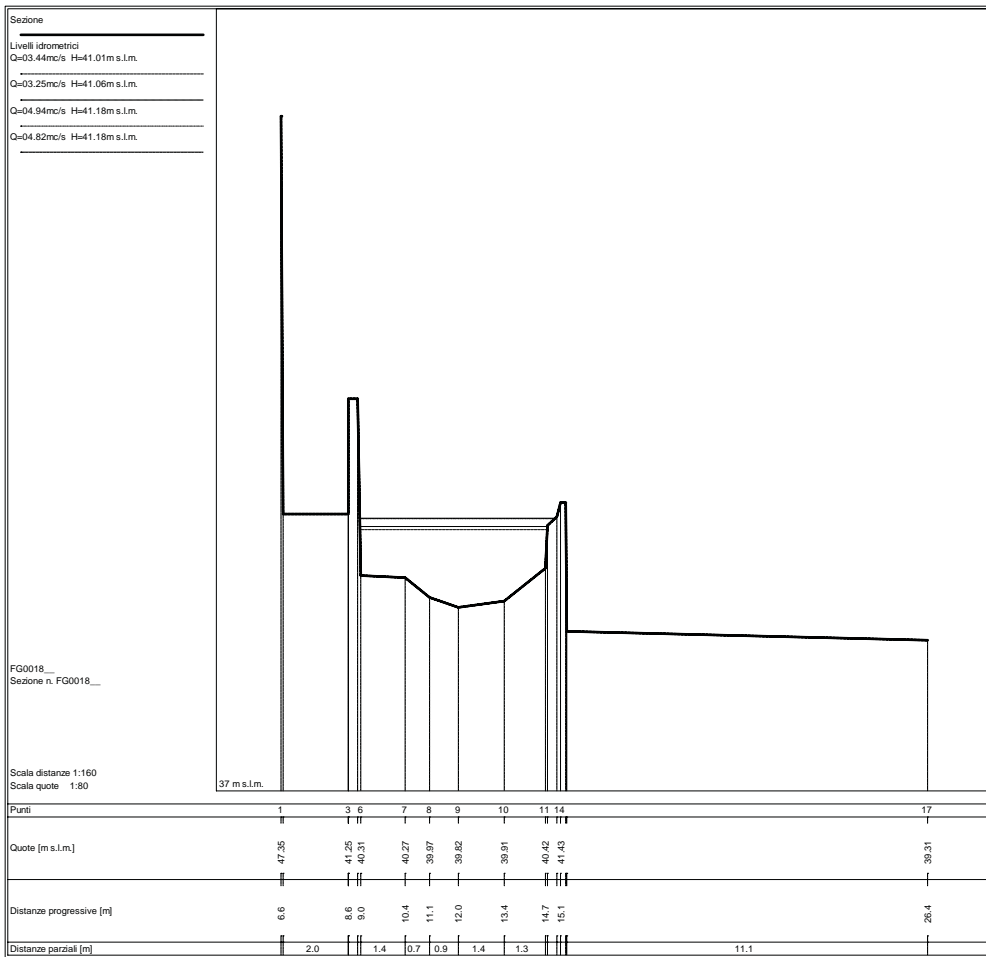

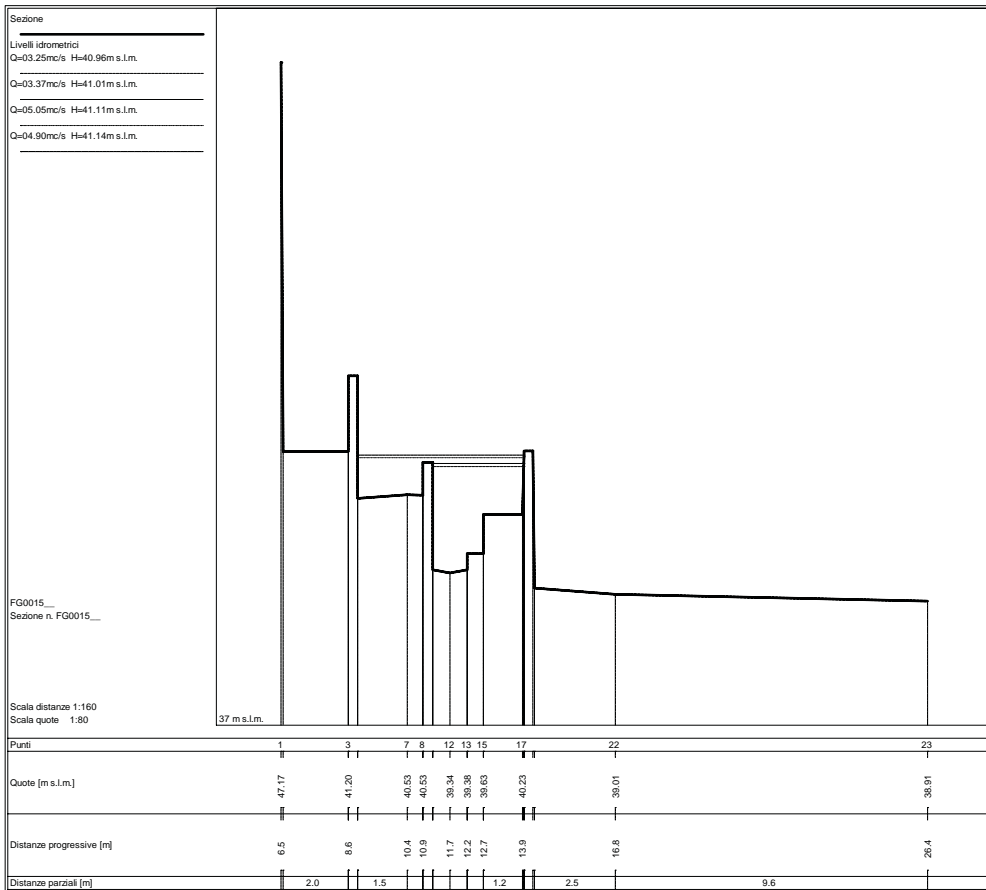
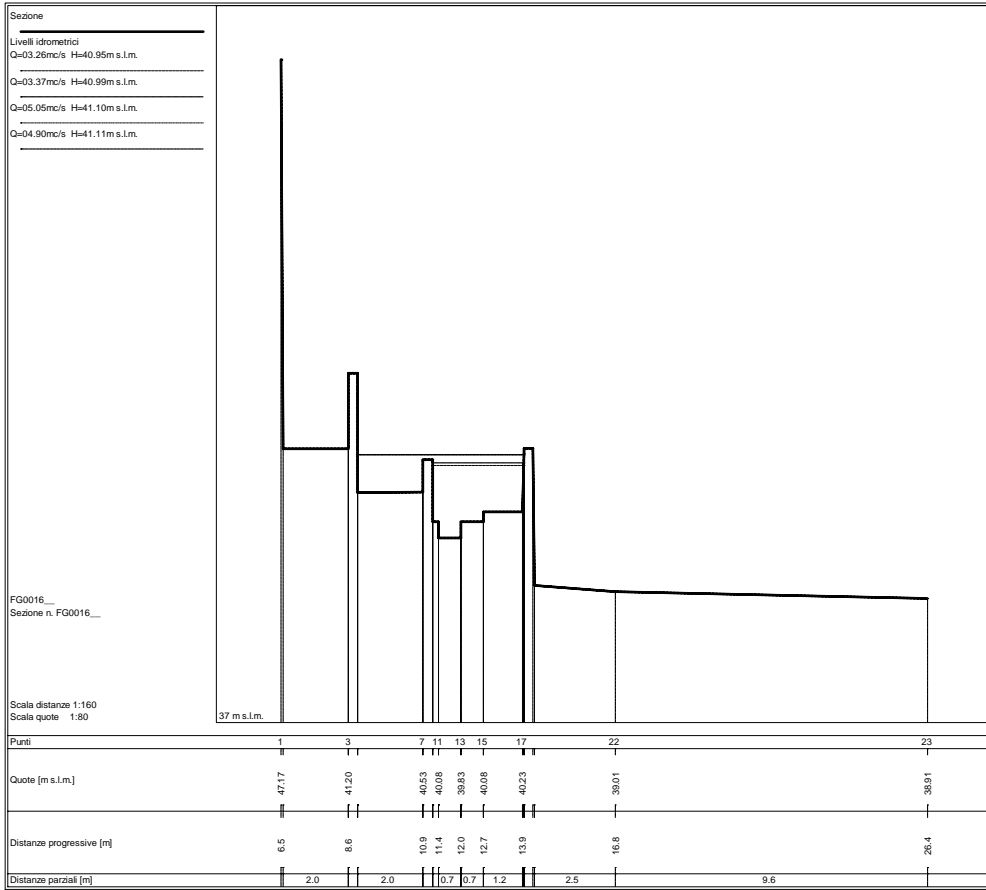

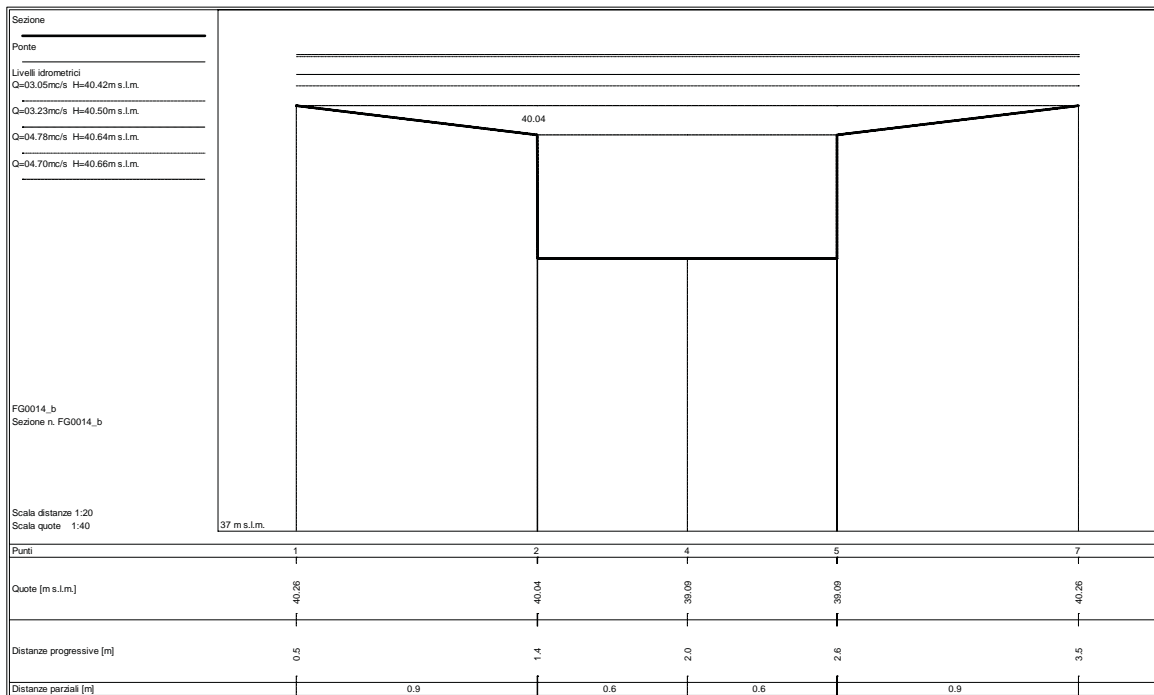
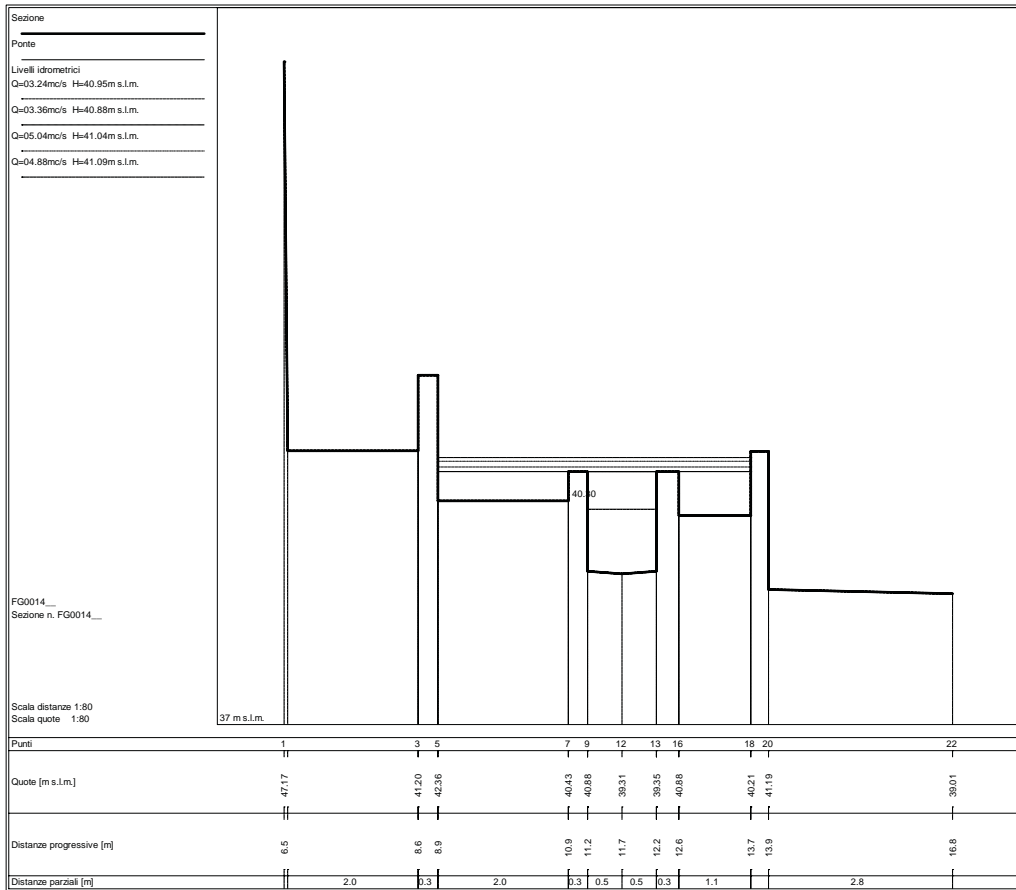

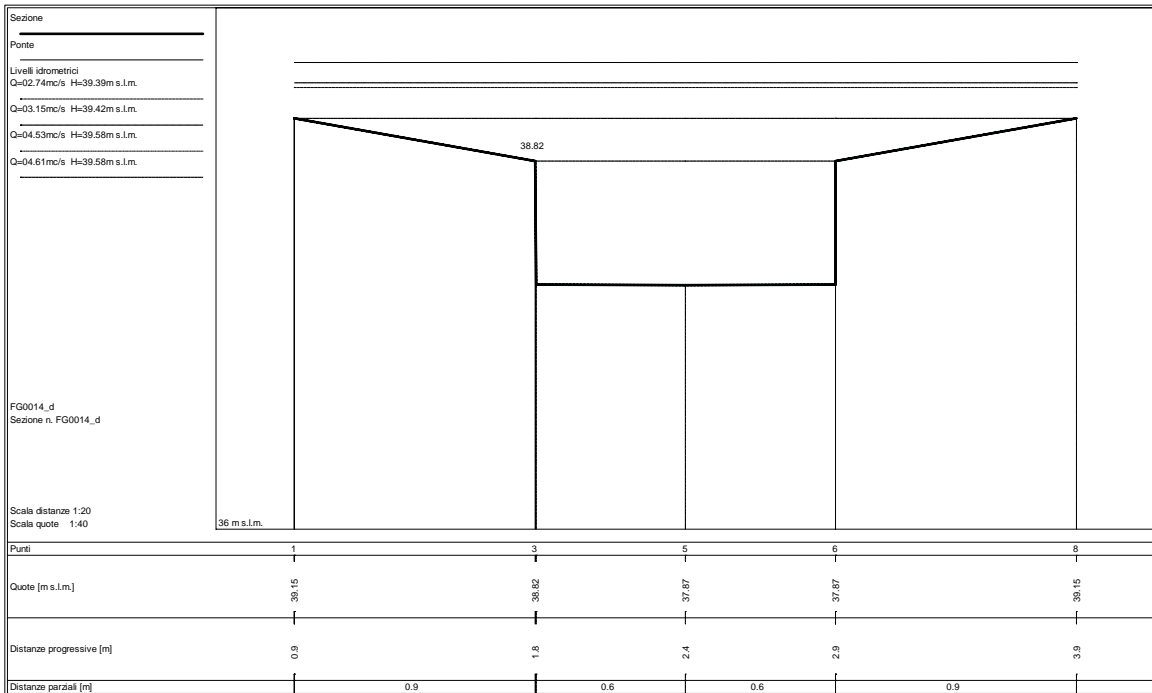
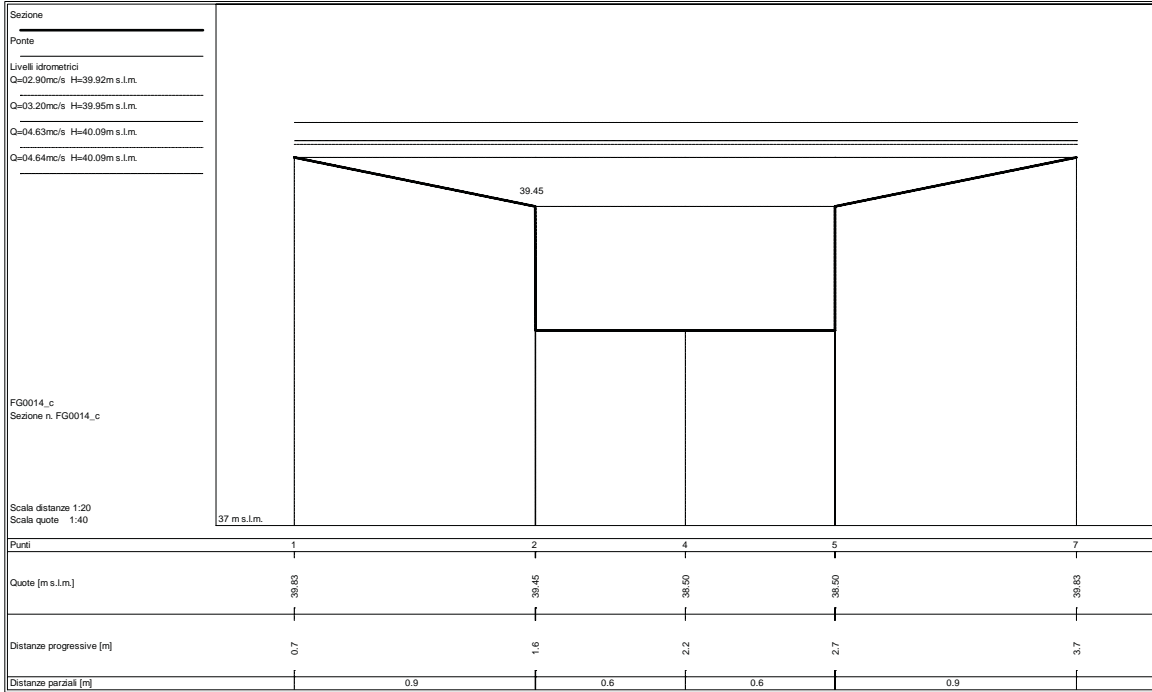

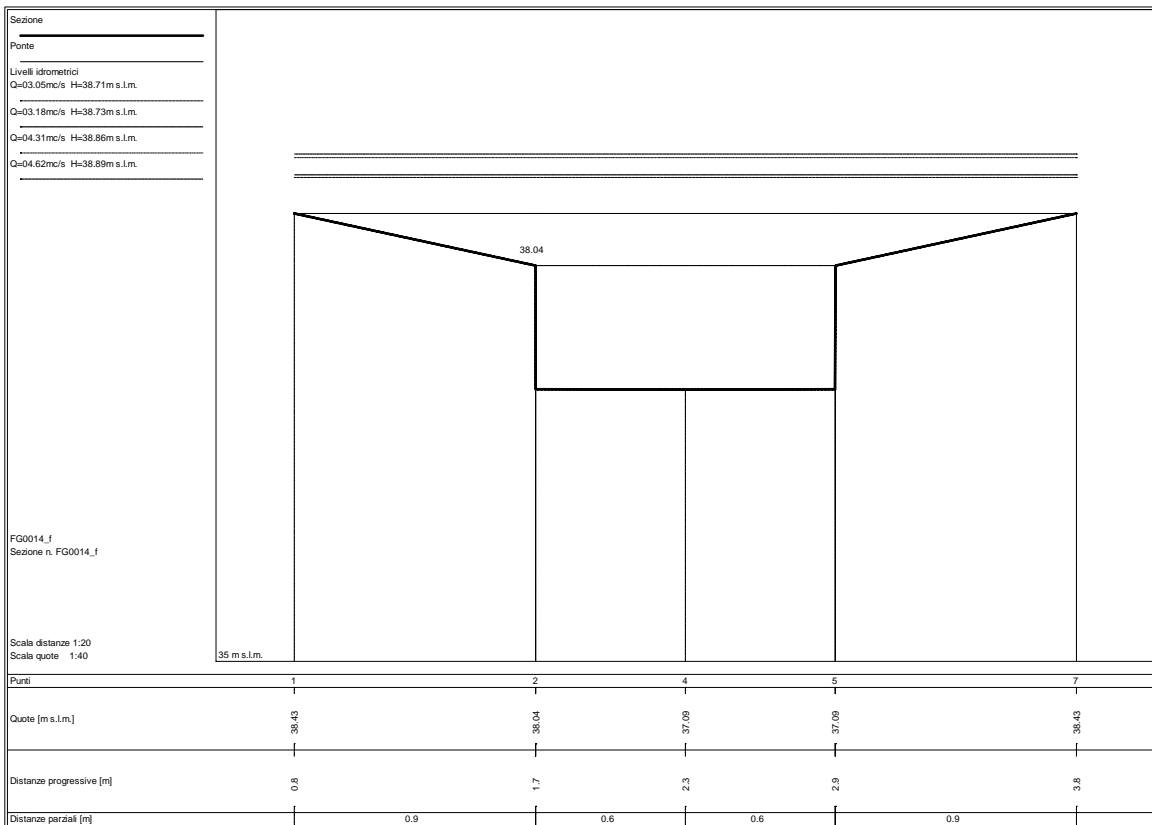
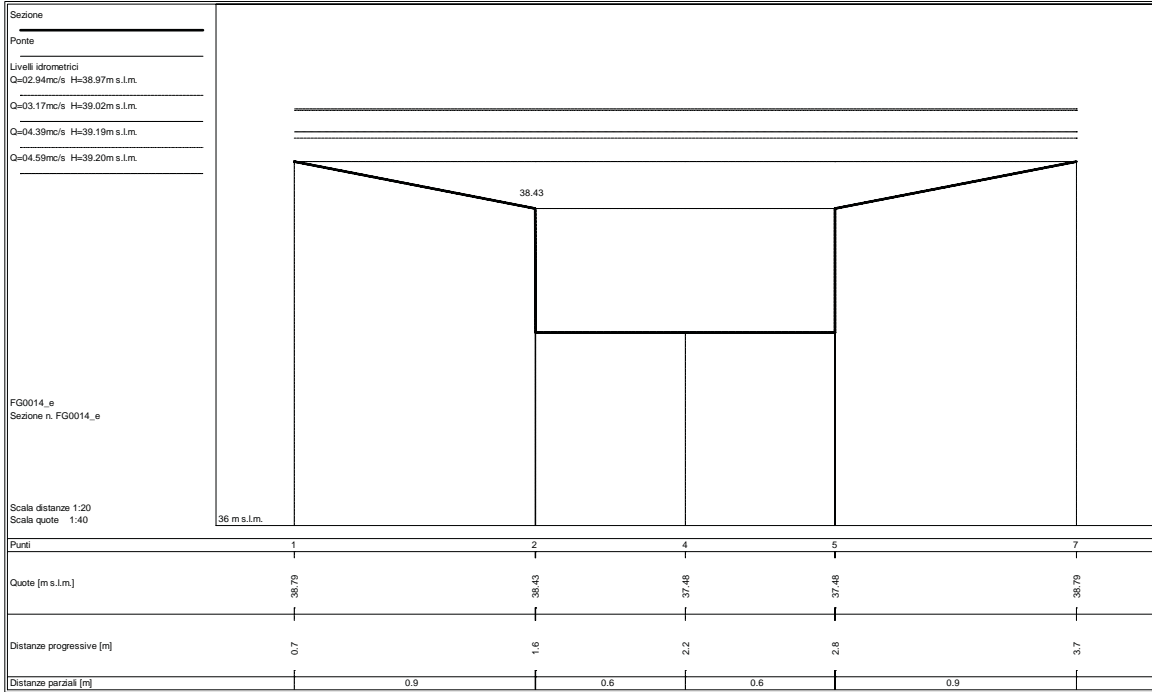

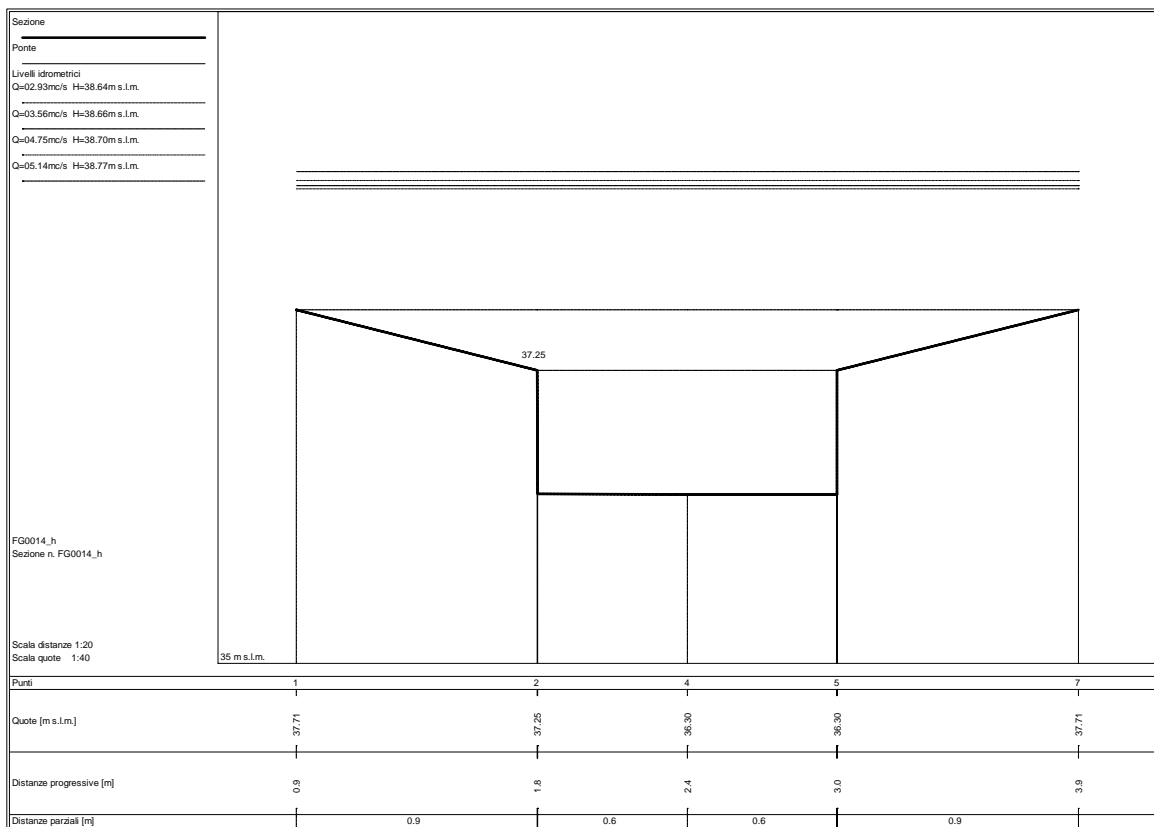
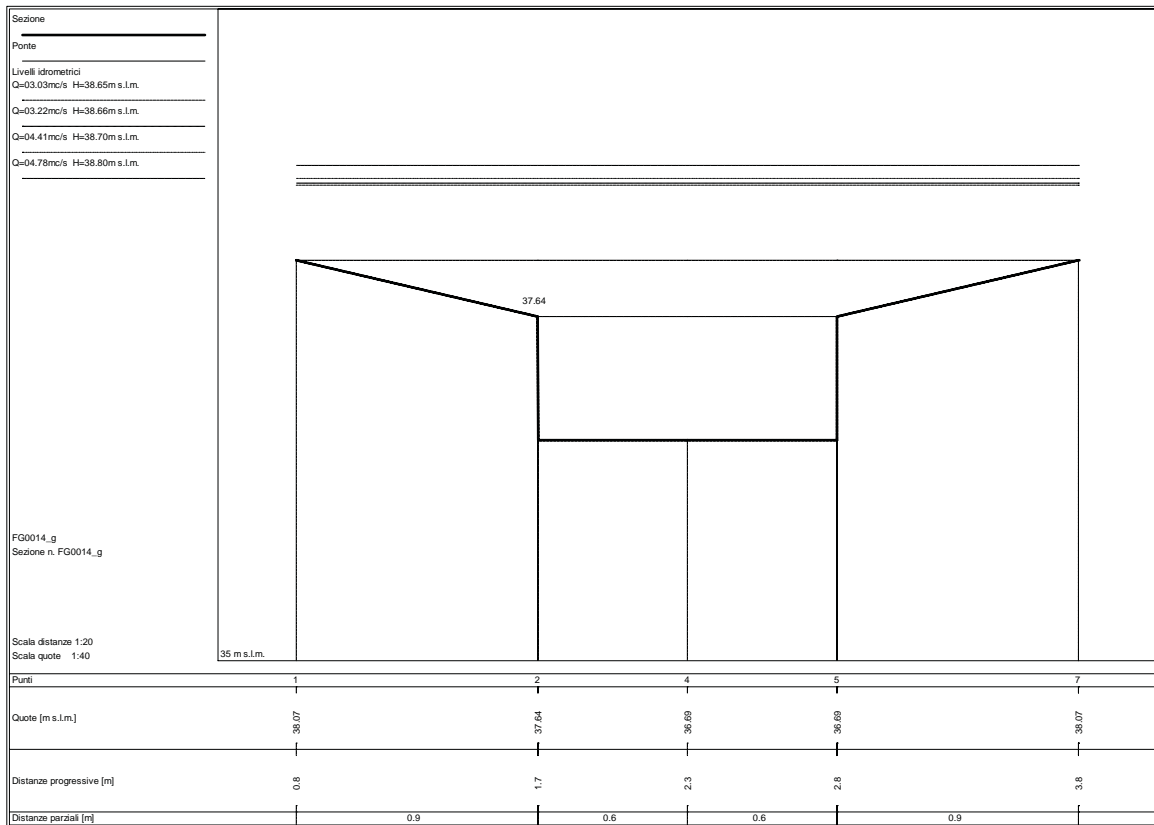

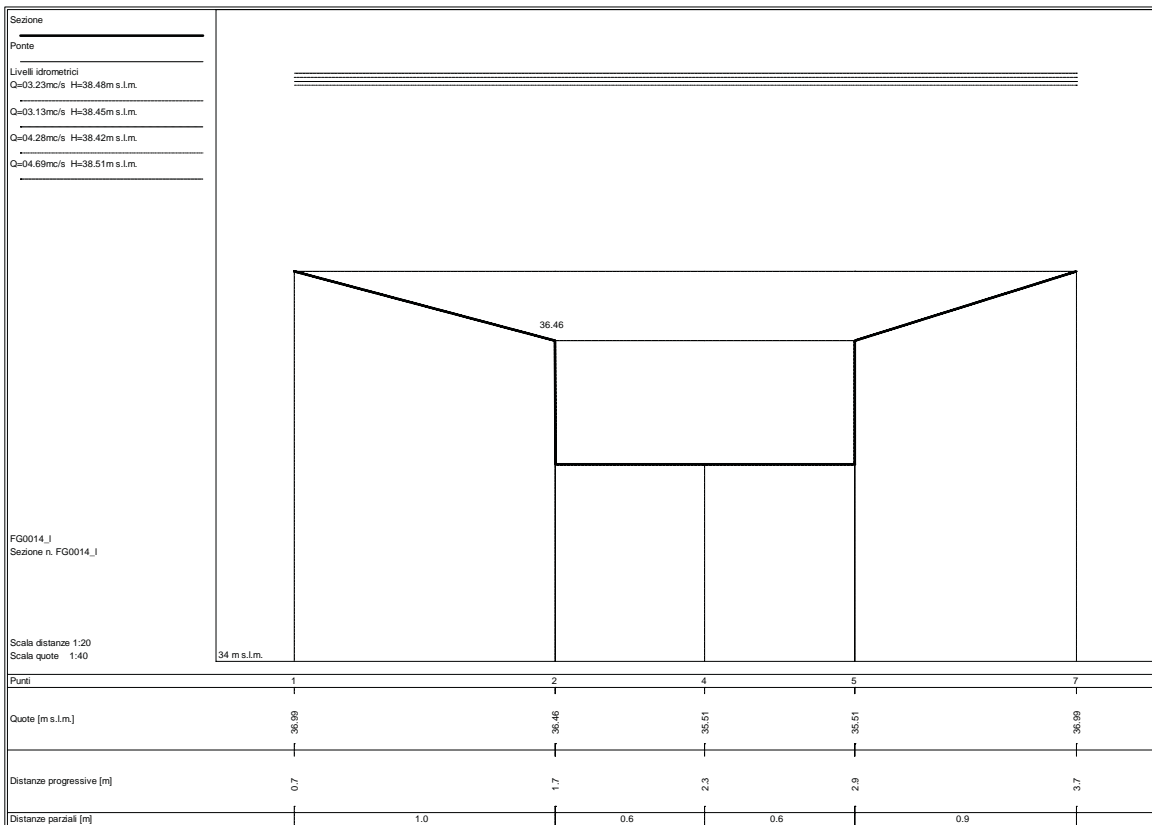
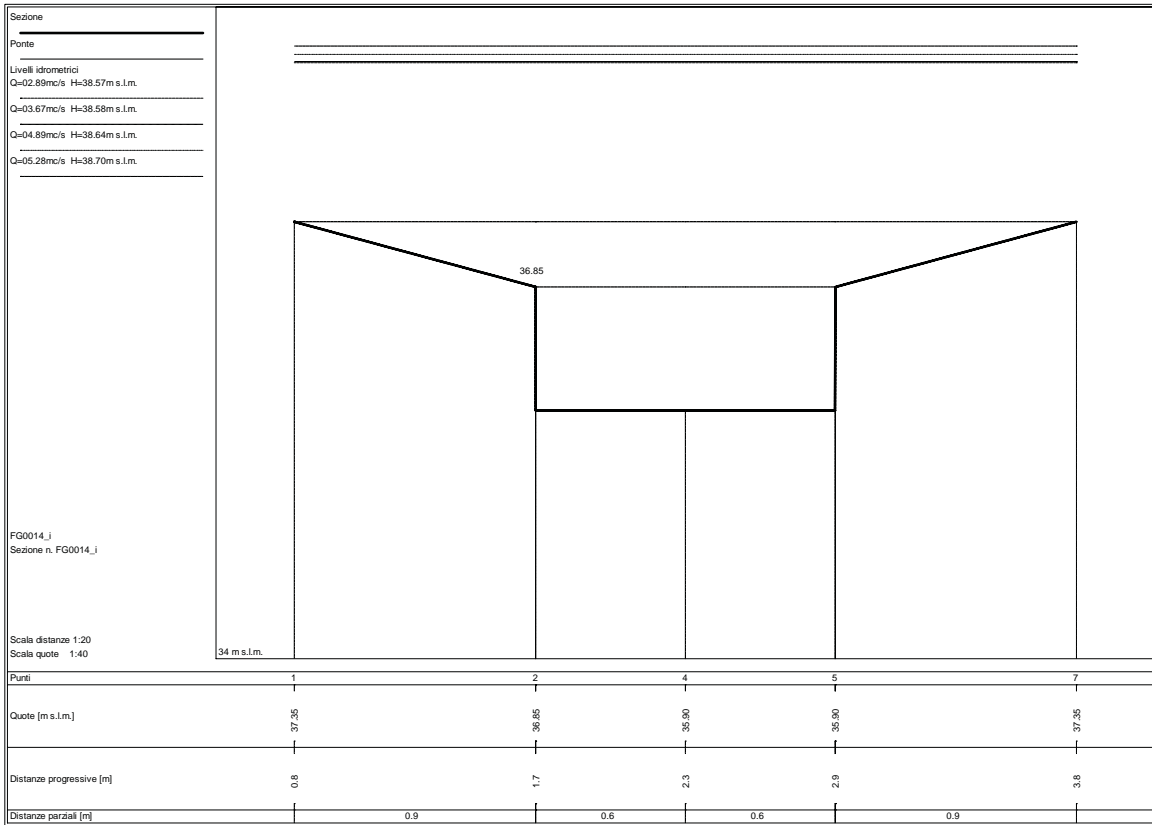

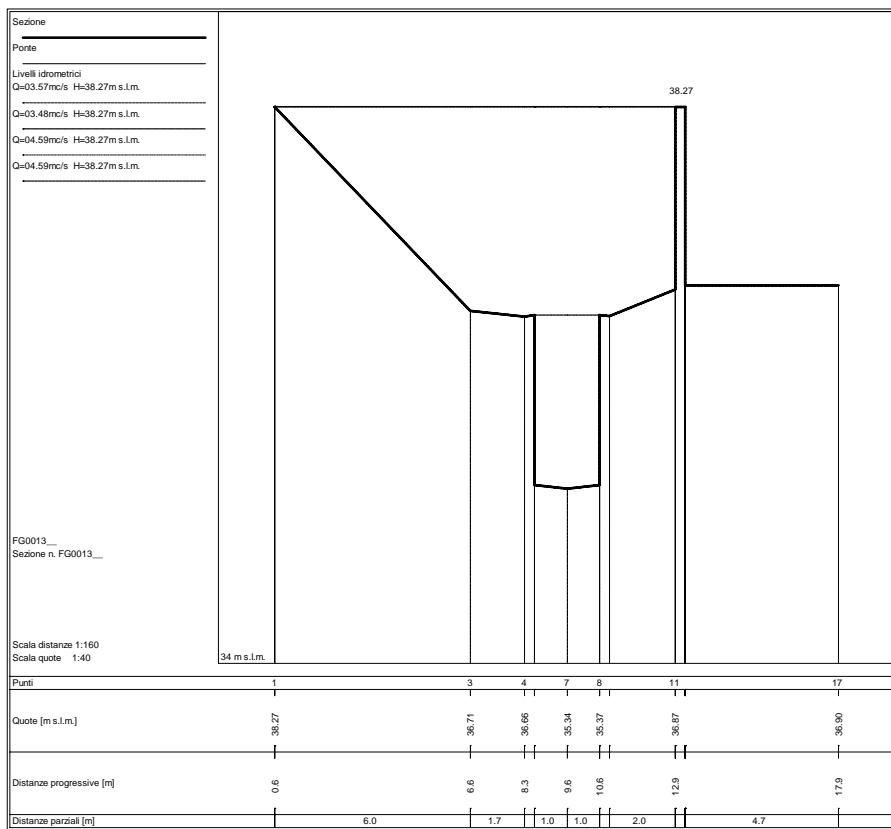
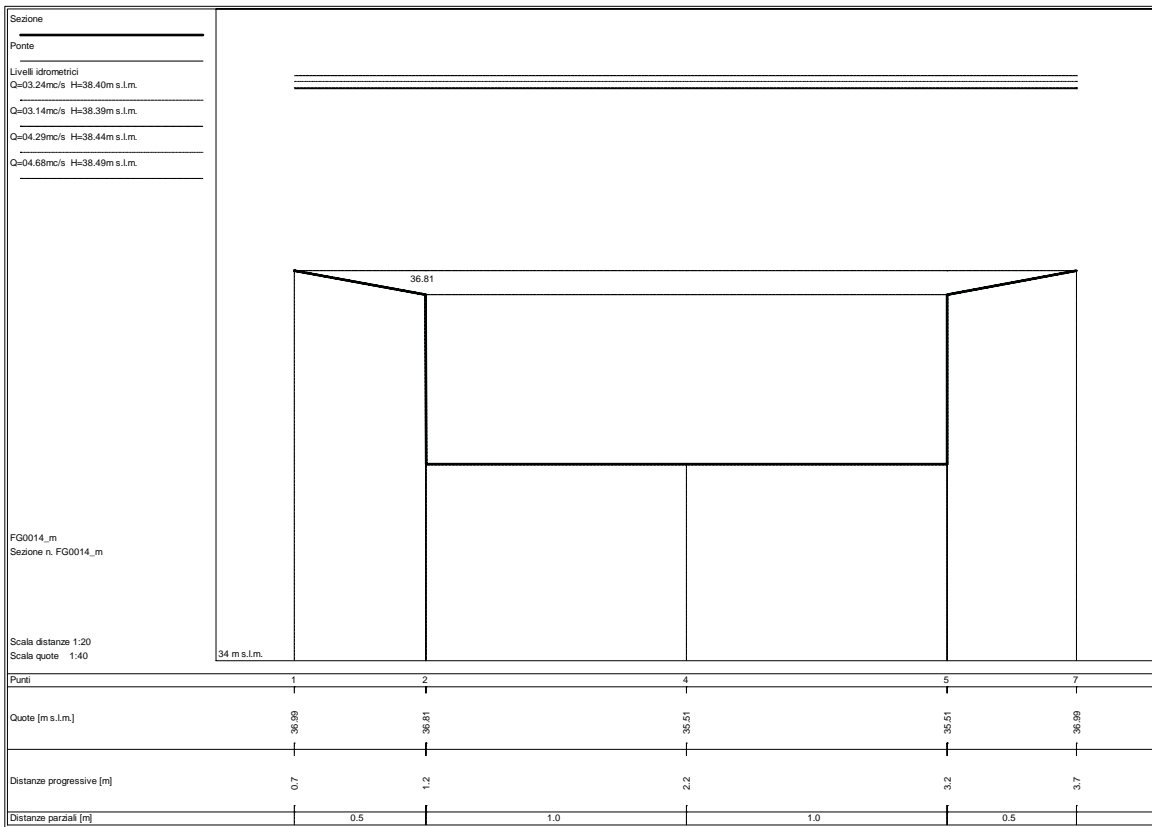

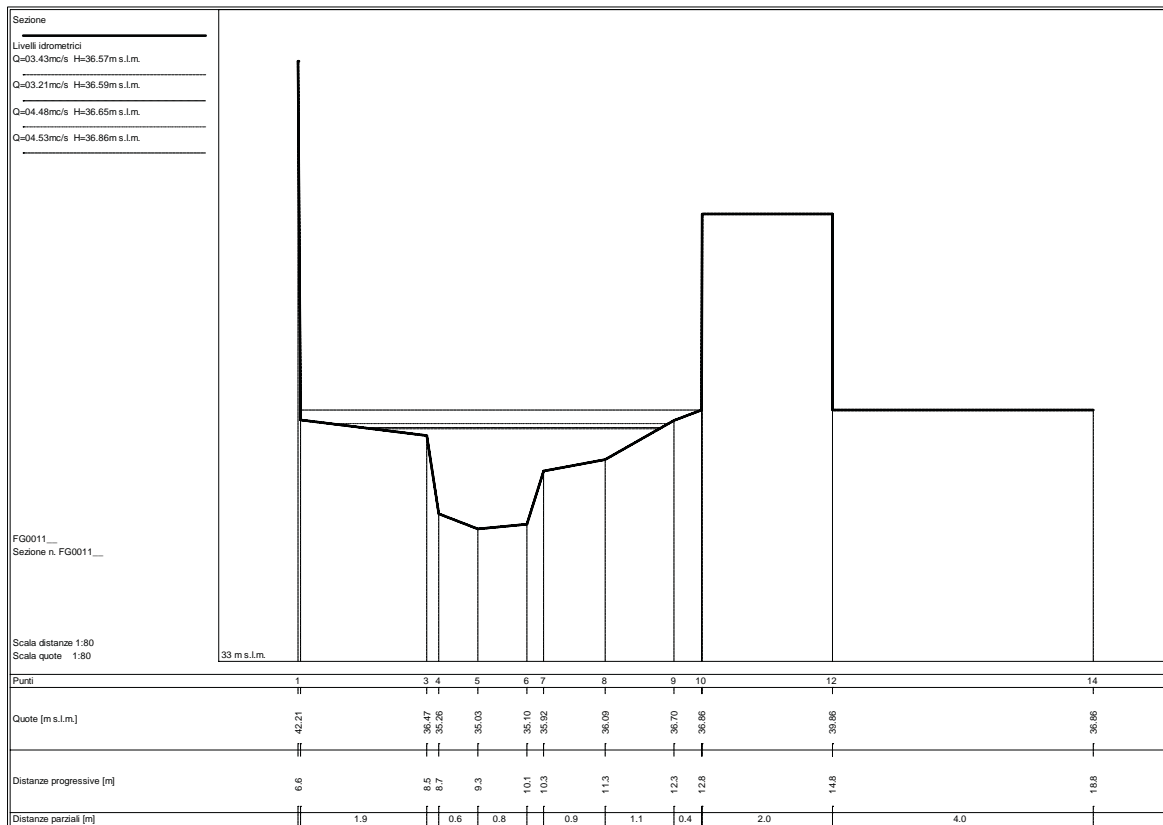
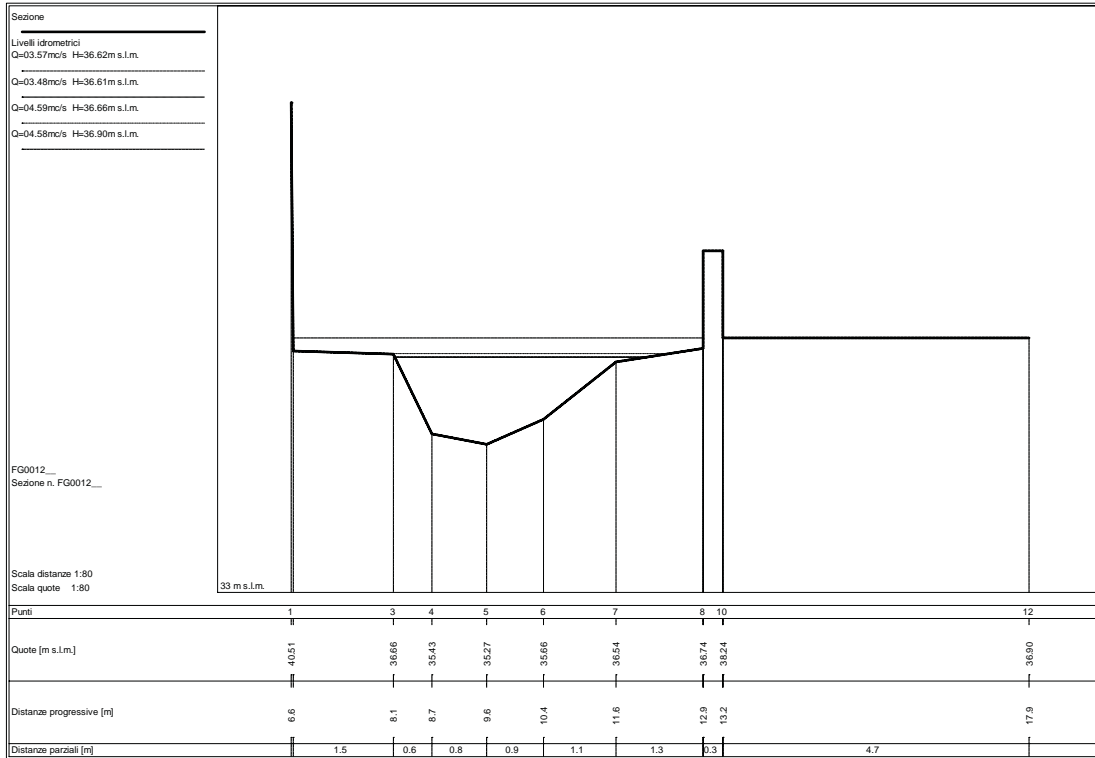

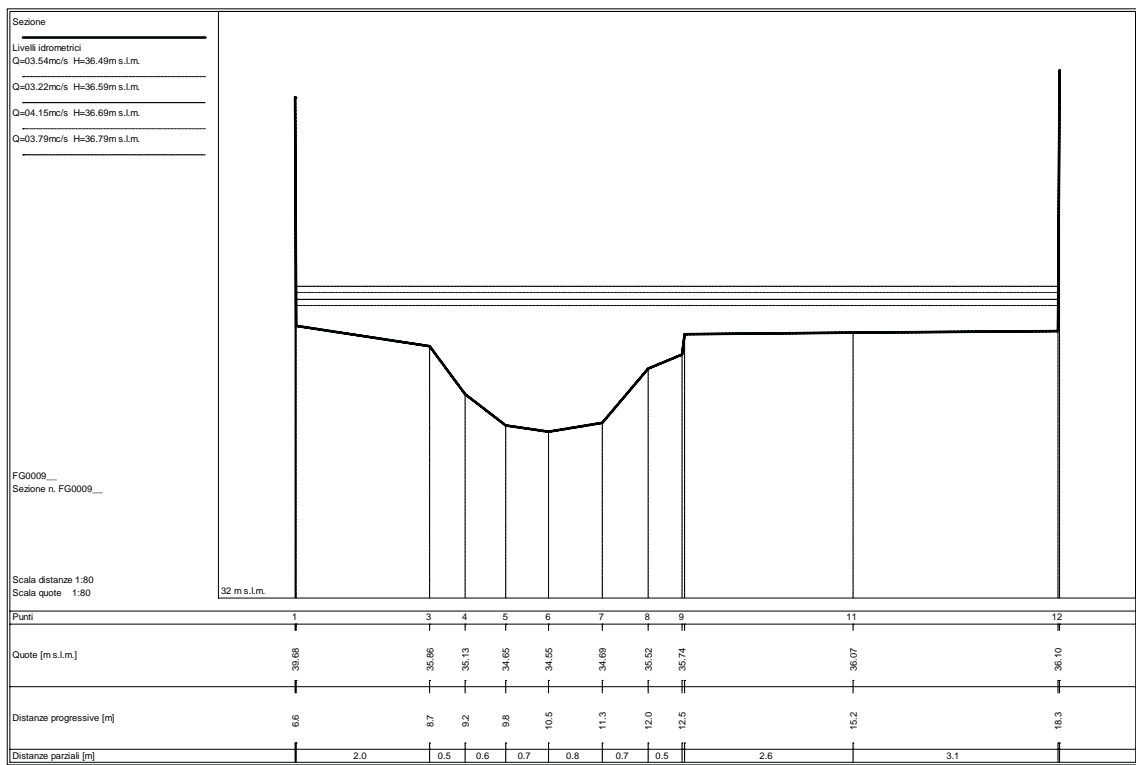
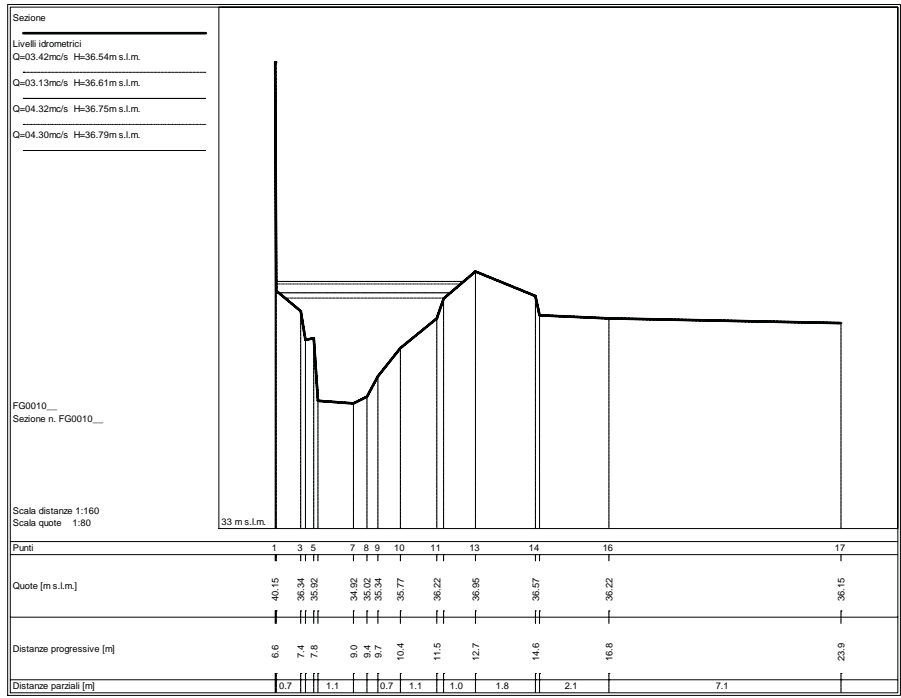

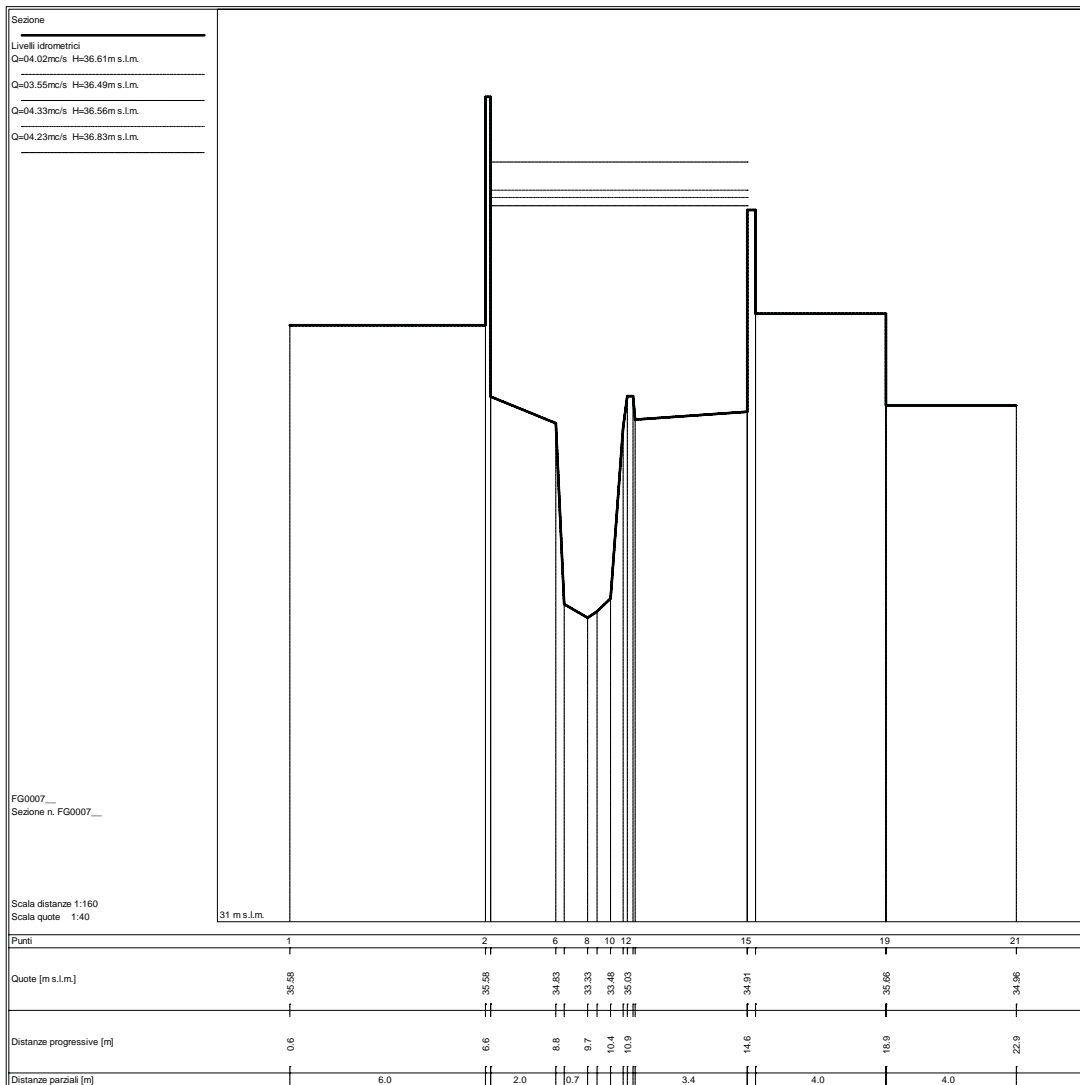
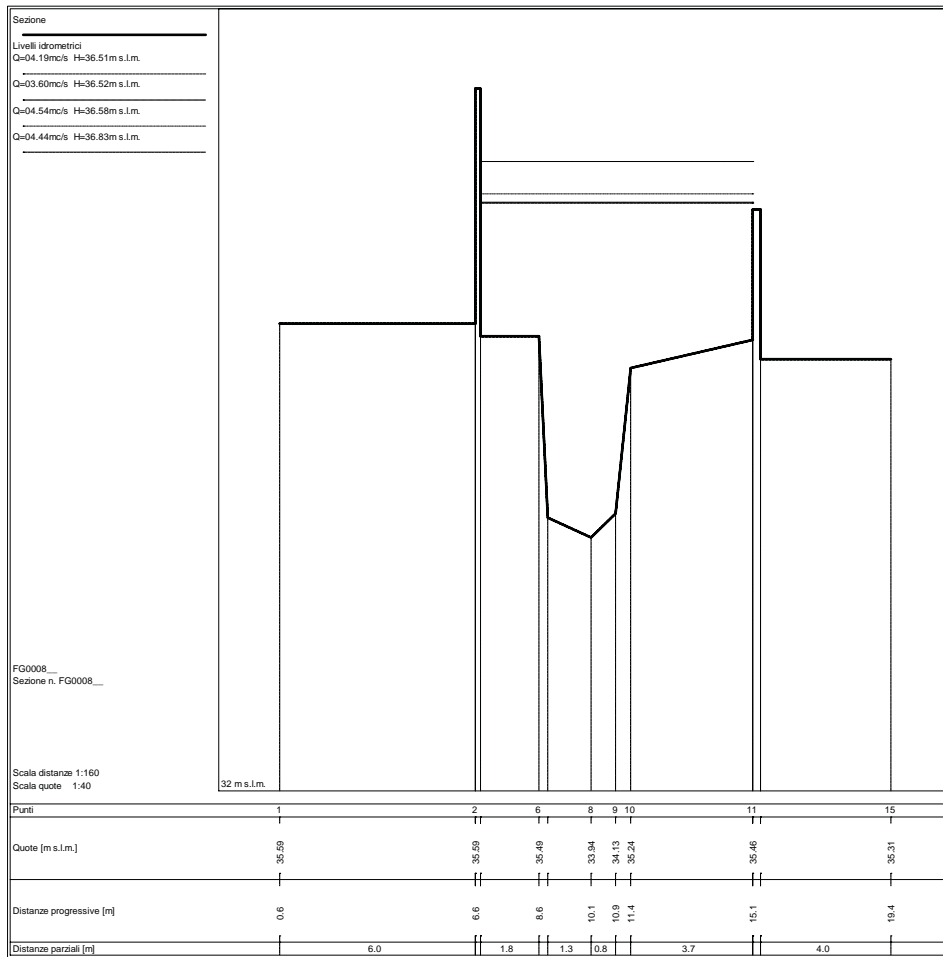

Sezione
 Ponte
 Livelli idrometrici
 Q=03.93mc/s H=36.61m s.l.m.
 Q=03.47mc/s H=36.45m s.l.m.
 Q=04.25mc/s H=36.56m s.l.m.
 Q=04.12mc/s H=36.85m s.l.m.

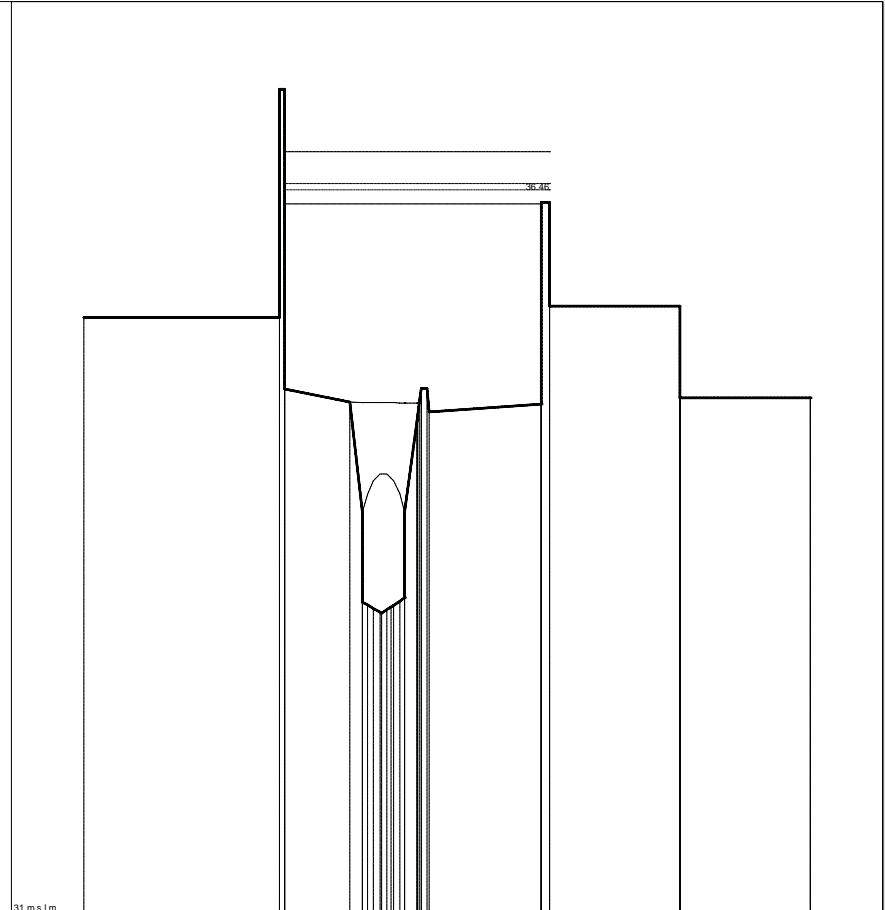

FG0006_
 Sezione n. FG0006_

Scala distanze 1:160
 Scala quote 1:40

31 m s.l.m.

Punti	1	2	7	8	12	16	21	28	35	38
Quote [m s.l.m.]	35.58	35.58	34.93	34.08	33.32	33.37	34.79	34.91	35.66	34.96
Distanze progressive [m]	0.6	6.6	8.8	9.1	9.7	10.1	10.8	14.6	18.9	22.9
Distanze parziali [m]		6.0	2.0	0.3	0.6	0.4	0.7	3.4	4.0	4.0

Sezione
 Ponte
 Livelli idrometrici
 Q=02.84mc/s H=36.62m s.l.m.
 Q=02.39mc/s H=36.42m s.l.m.
 Q=02.88mc/s H=36.61m s.l.m.
 Q=02.86mc/s H=36.84m s.l.m.

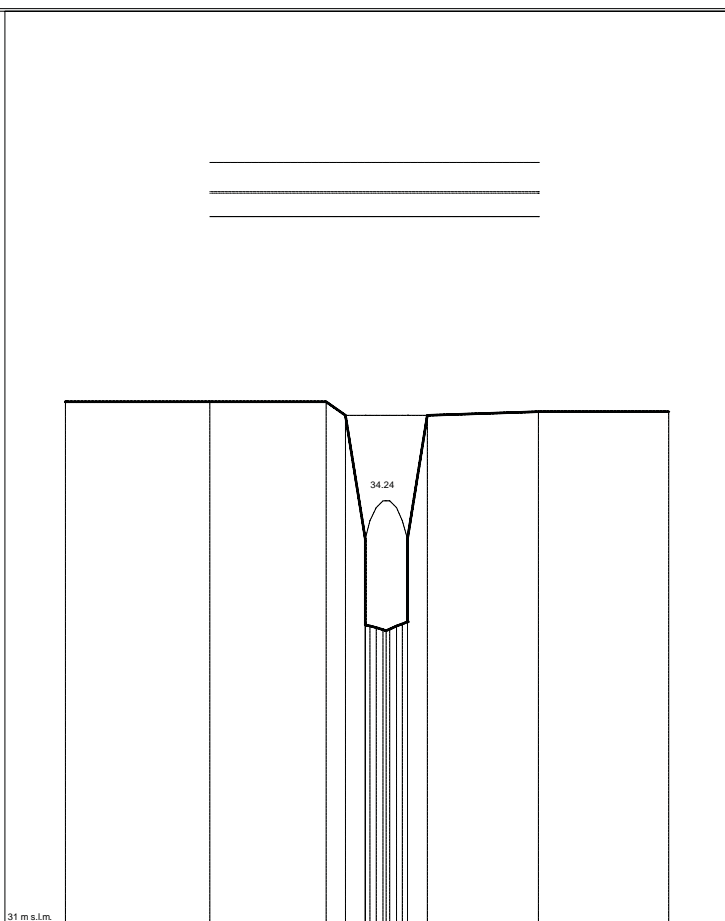

FG0005_
 Sezione n. FG0005_

Scala distanze 1:160
 Scala quote 1:40

31 m s.l.m.

Punti	1	2	3	4	5	8	11	13	17	18	19
Quote [m s.l.m.]	35.00	35.01	35.00	34.90	33.95	33.27	33.26	33.30	34.90	34.93	34.93
Distanze progressive [m]	0.6	5.0	8.6	9.2	9.8	10.1	10.6	10.9	11.7	15.1	19.1
Distanze parziali [m]		4.4	3.6	0.6	0.6	0.3	0.5	0.3	0.6	3.4	4.0

Sezione
 Livelli idrometrici
 Q=02.78mc/s H=36.61m s.l.m.
 Q=02.38mc/s H=36.45m s.l.m.
 Q=02.82mc/s H=36.59m s.l.m.
 Q=02.82mc/s H=36.83m s.l.m.

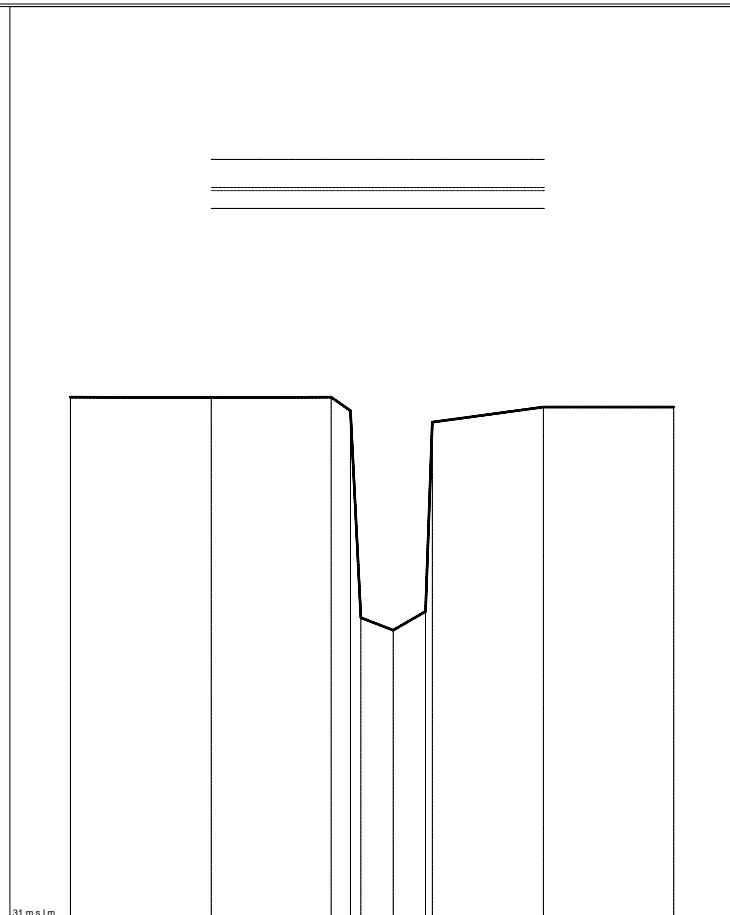

FG0004_
 Sezione n. FG0004_

Scala distanze 1:160
 Scala quote 1:40

Punti	1	2	3	4	5	6	7	9	10
Quote [m s.l.m.]	35.00	35.00	35.00	34.90	33.31	33.22	33.36	34.03	34.03
Distanze progressive [m]	0.6	4.9	8.6	9.2	9.5	10.5	11.5	15.1	19.1
Distanze parziali [m]		4.3	3.7	0.6	1.0	1.0	3.4	4.0	

Sezione
 Livelli idrometrici
 Q=02.48mc/s H=36.62m s.l.m.
 Q=02.35mc/s H=36.46m s.l.m.
 Q=02.53mc/s H=36.59m s.l.m.
 Q=02.75mc/s H=36.82m s.l.m.

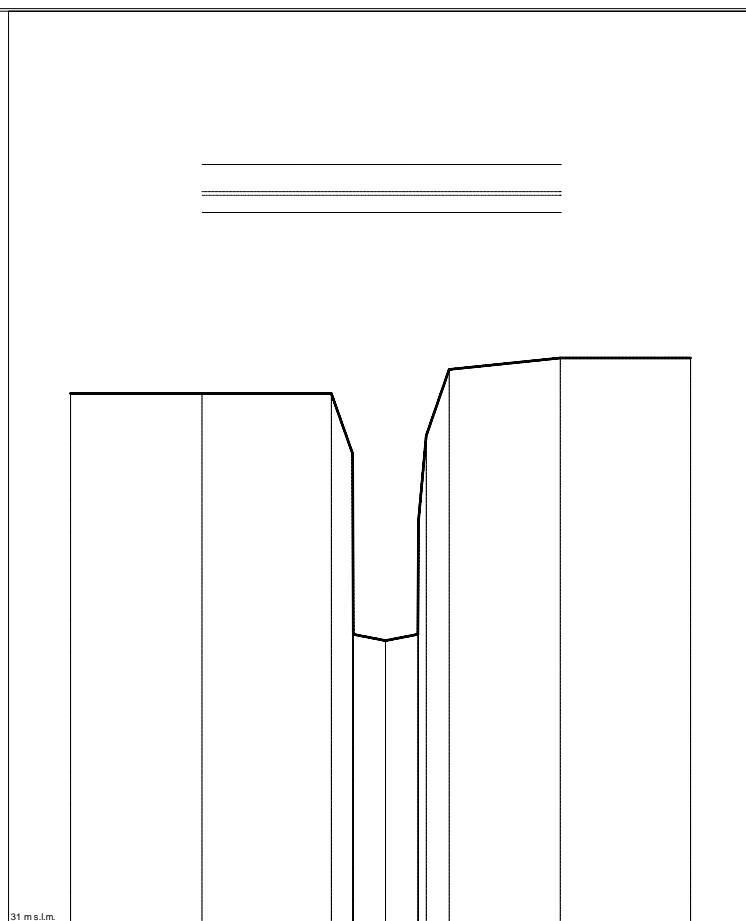

FG0003_
 Sezione n. FG0003_

Scala distanze 1:160
 Scala quote 1:40

Punti	1	2	3	4	6	7	10	11	12
Quote [m s.l.m.]	35.07	35.07	35.07	34.61	33.17	33.22	35.25	35.34	35.34
Distanze progressive [m]	0.6	4.6	8.6	9.3	10.3	11.3	12.2	15.6	19.6
Distanze parziali [m]		4.0	4.0	0.7	1.0	1.0	0.7	3.4	4.0

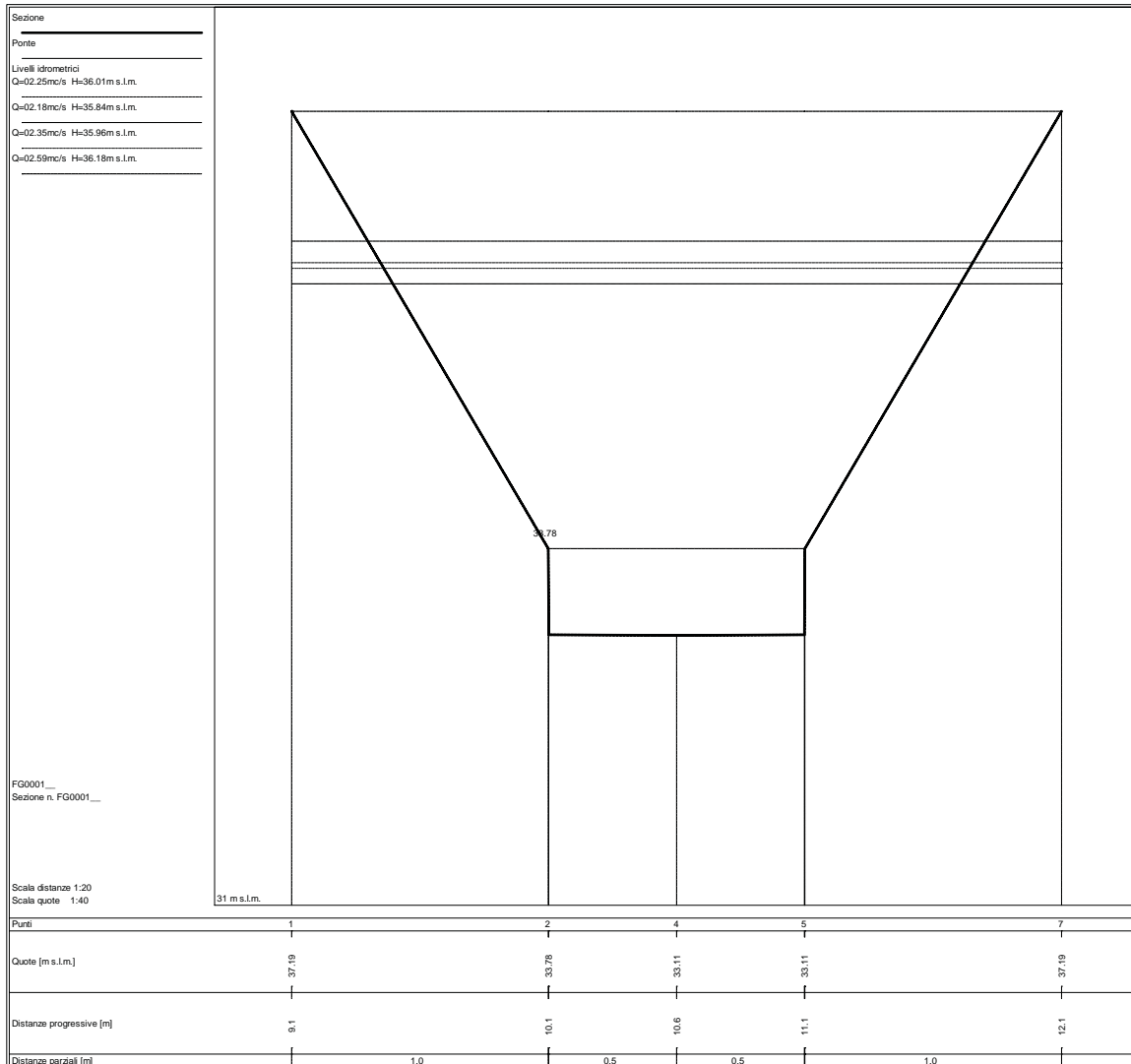
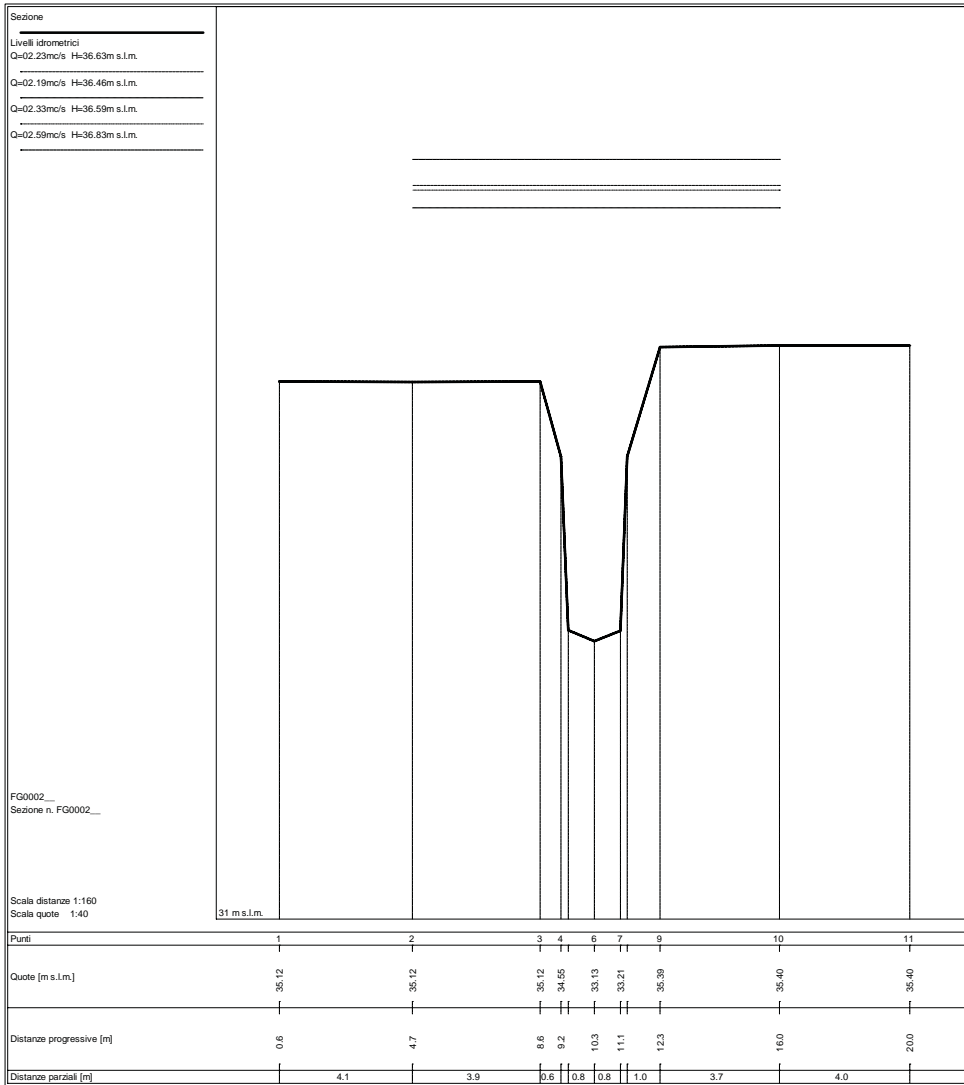

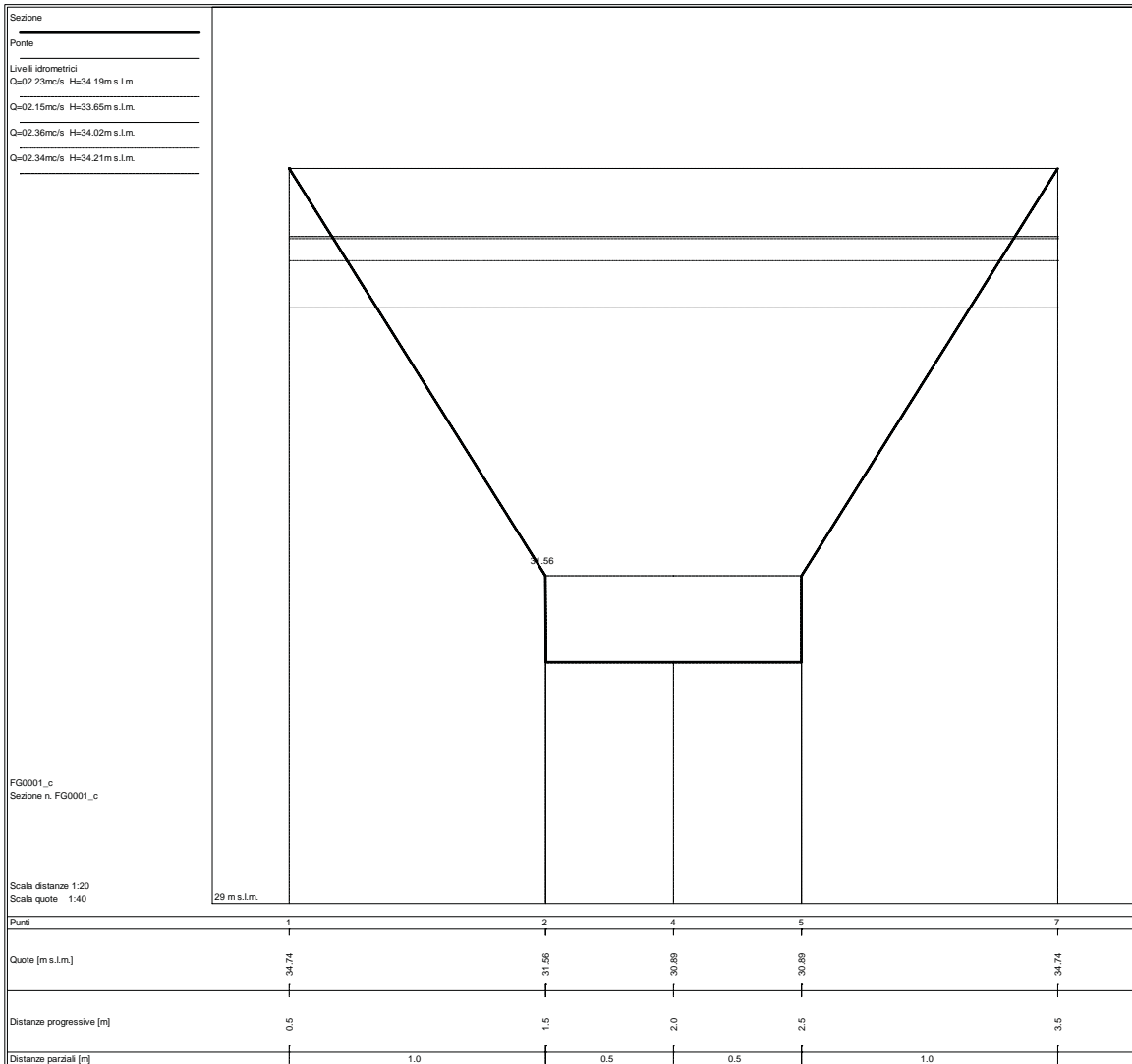
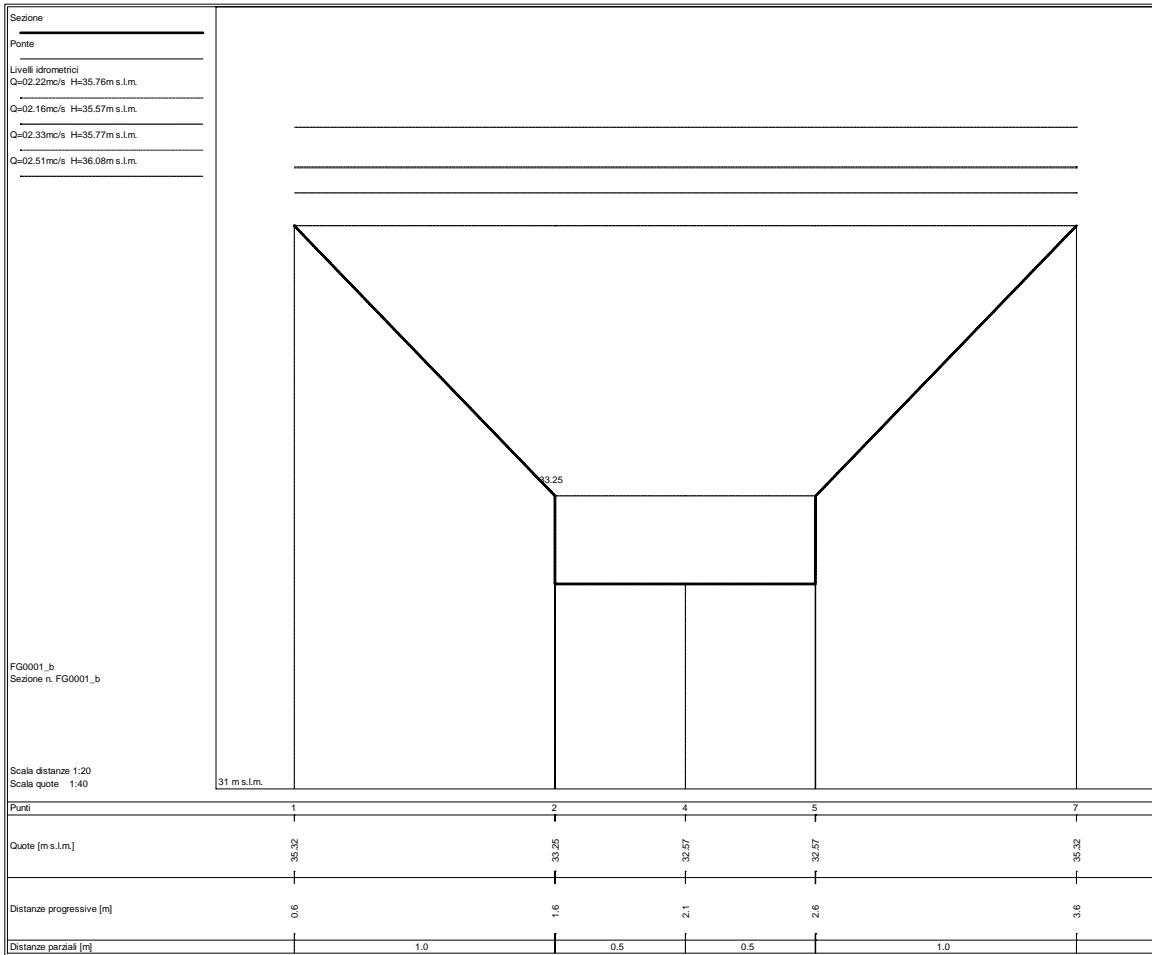

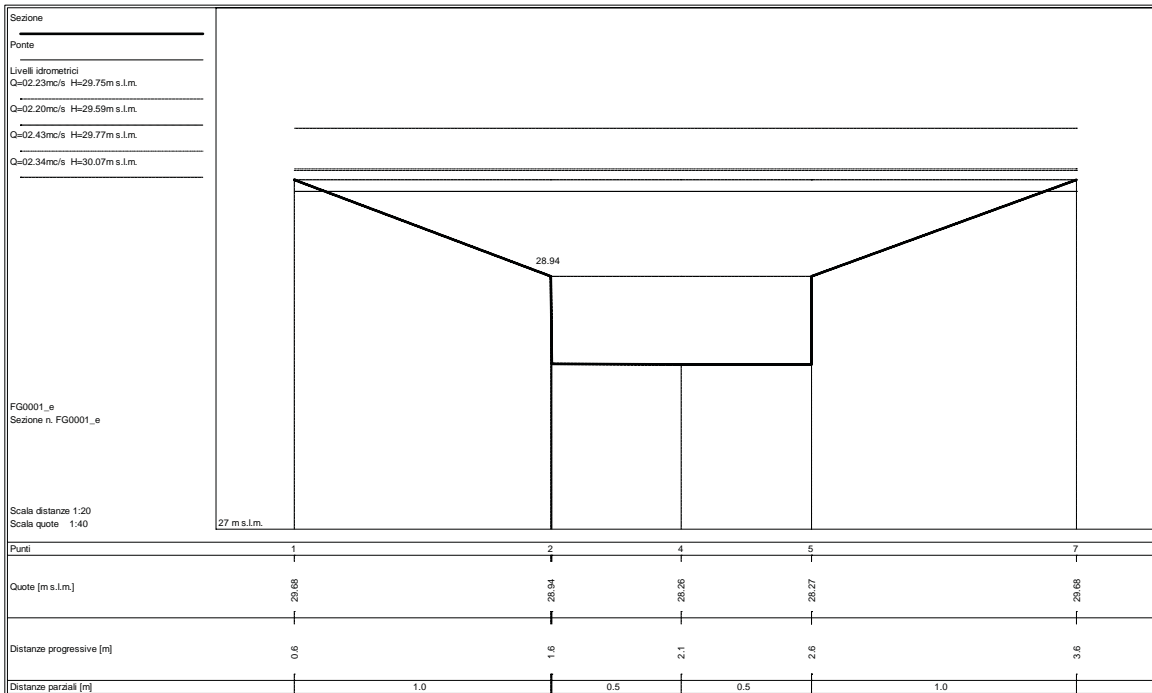
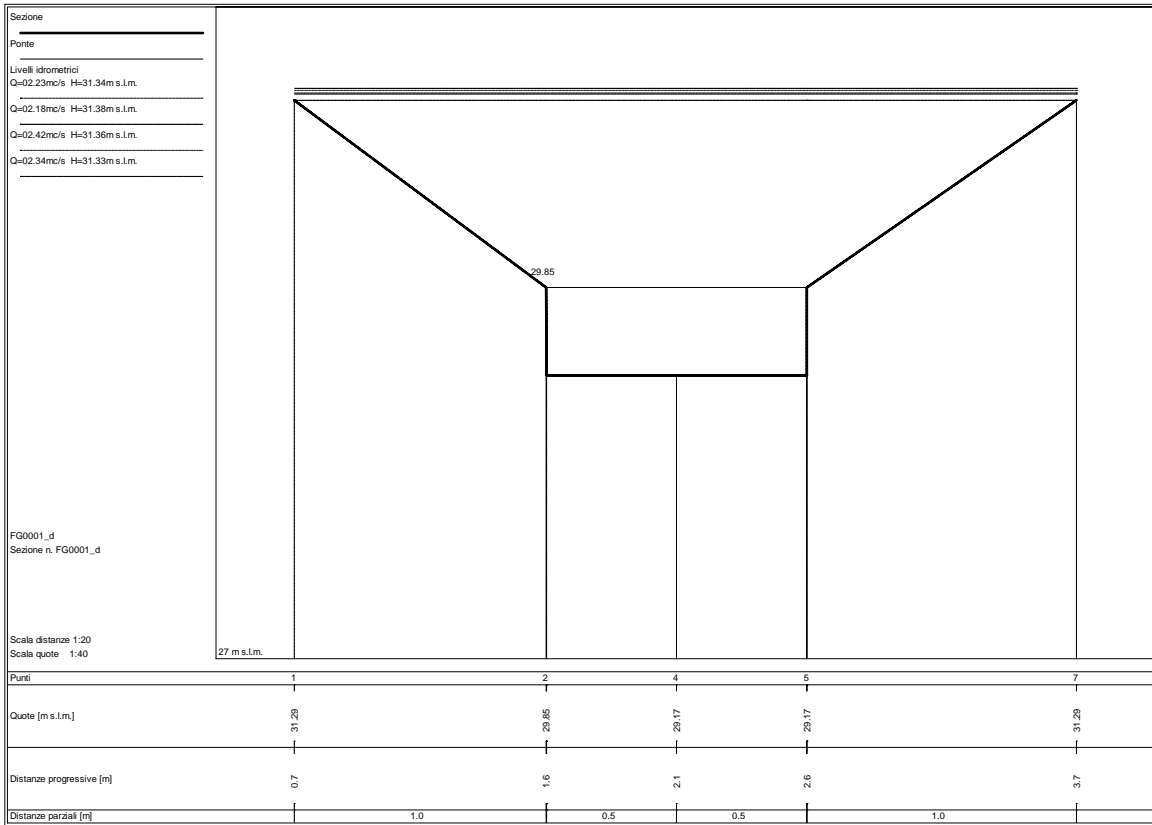

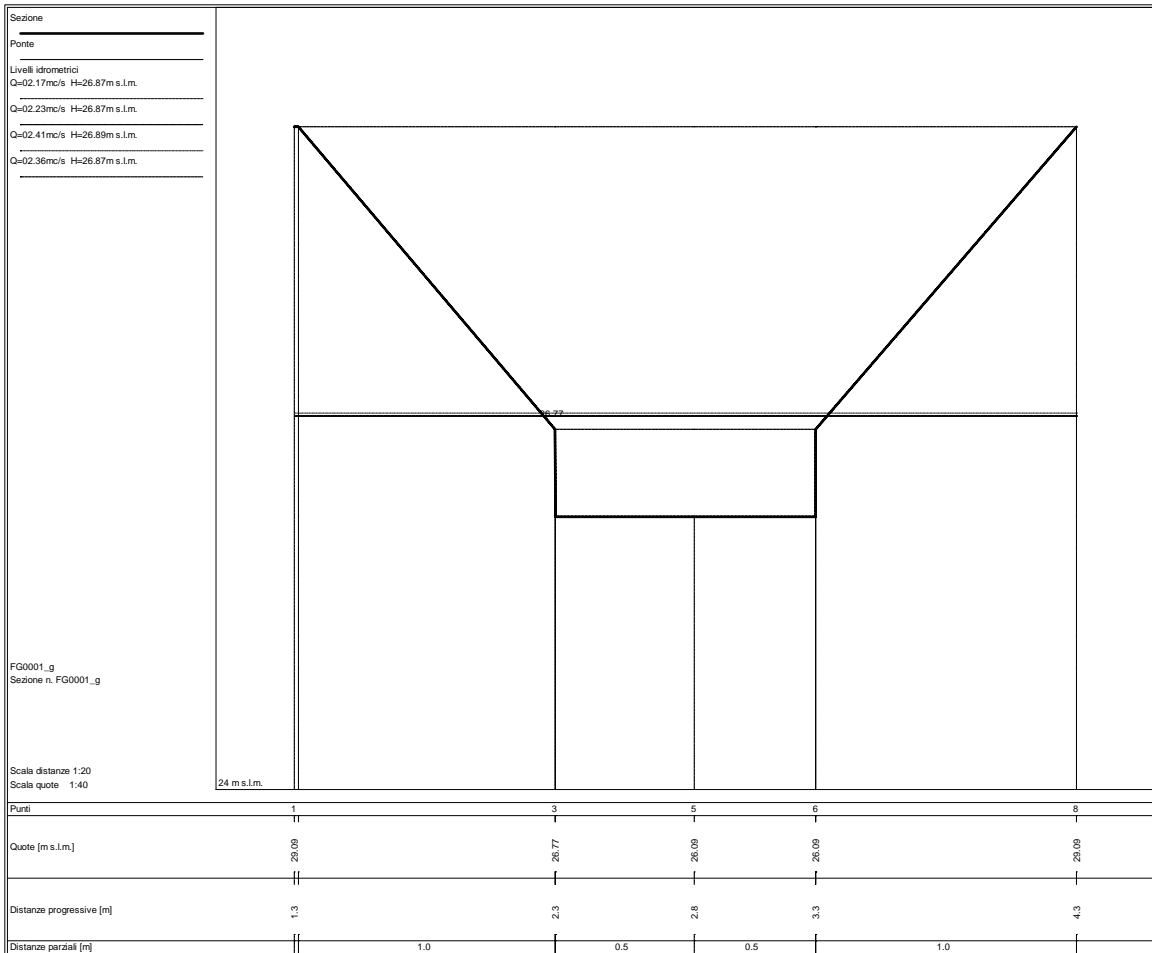
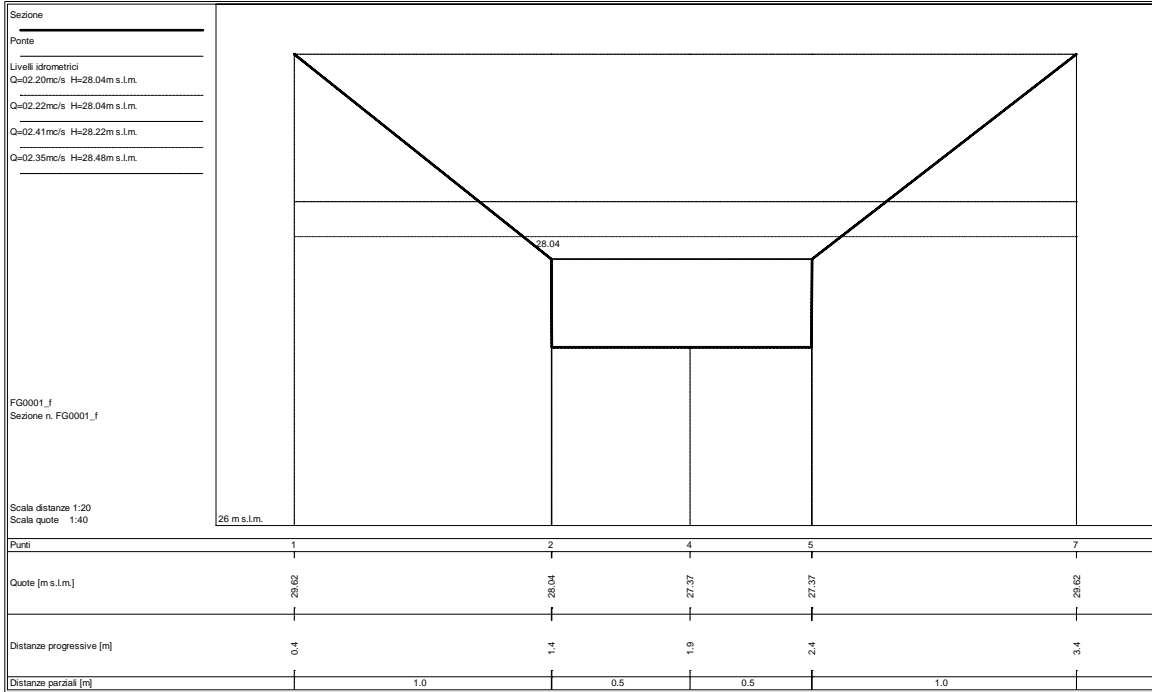

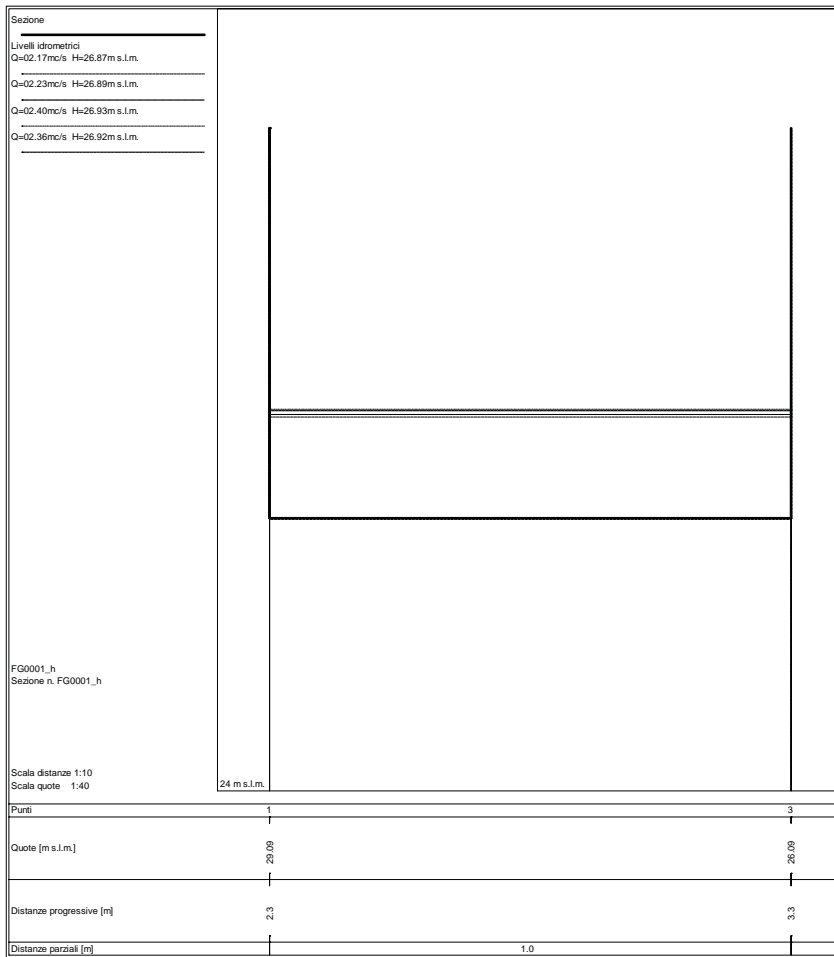

STATO ATTUALE

Sezioni fluviali fosso Bocchetta – Bocchetta_a

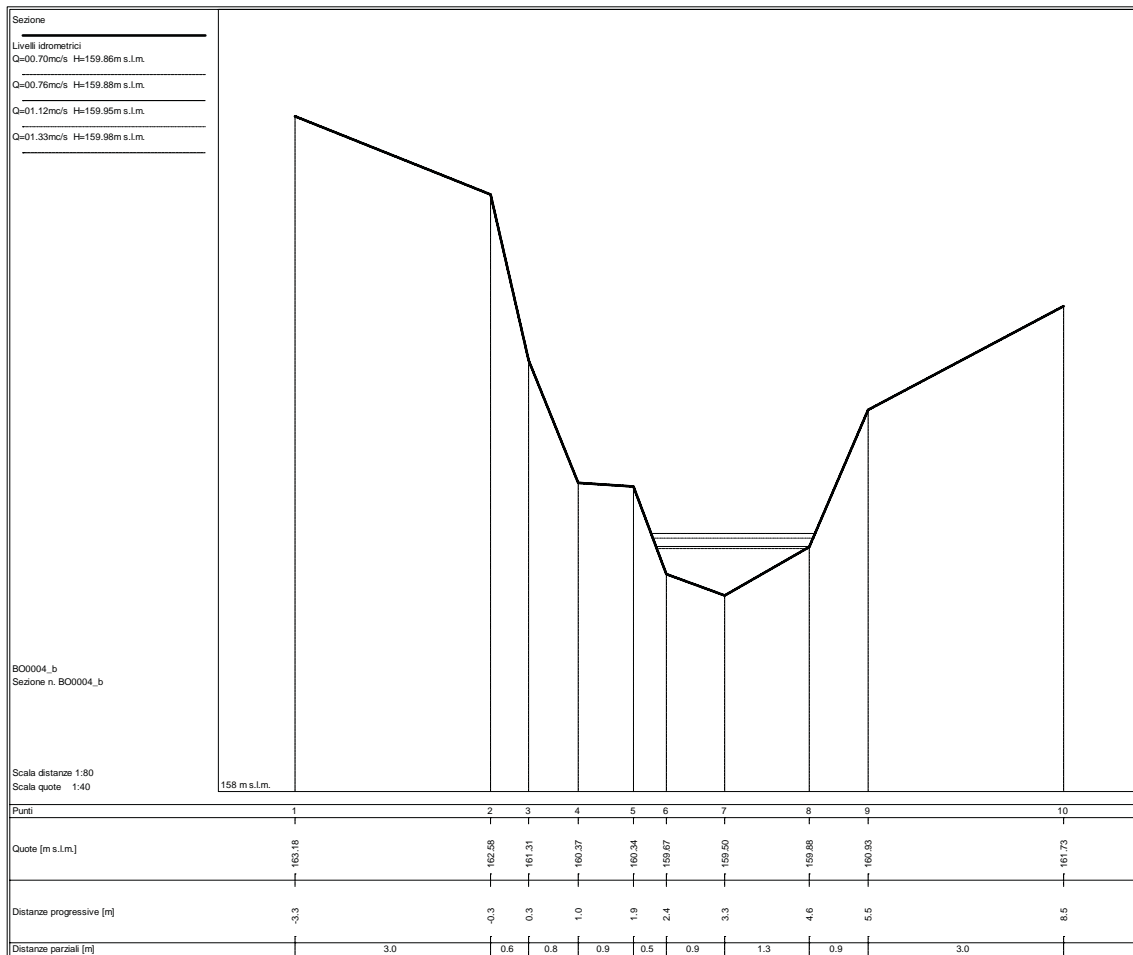
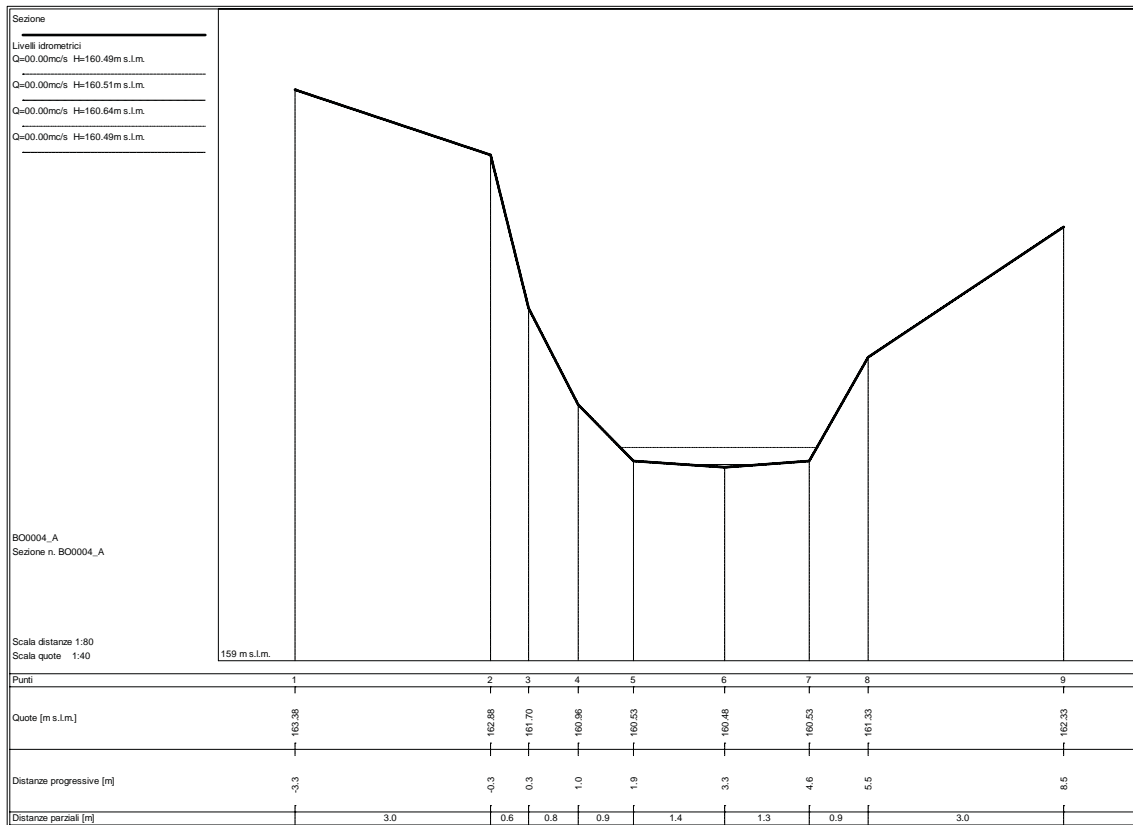

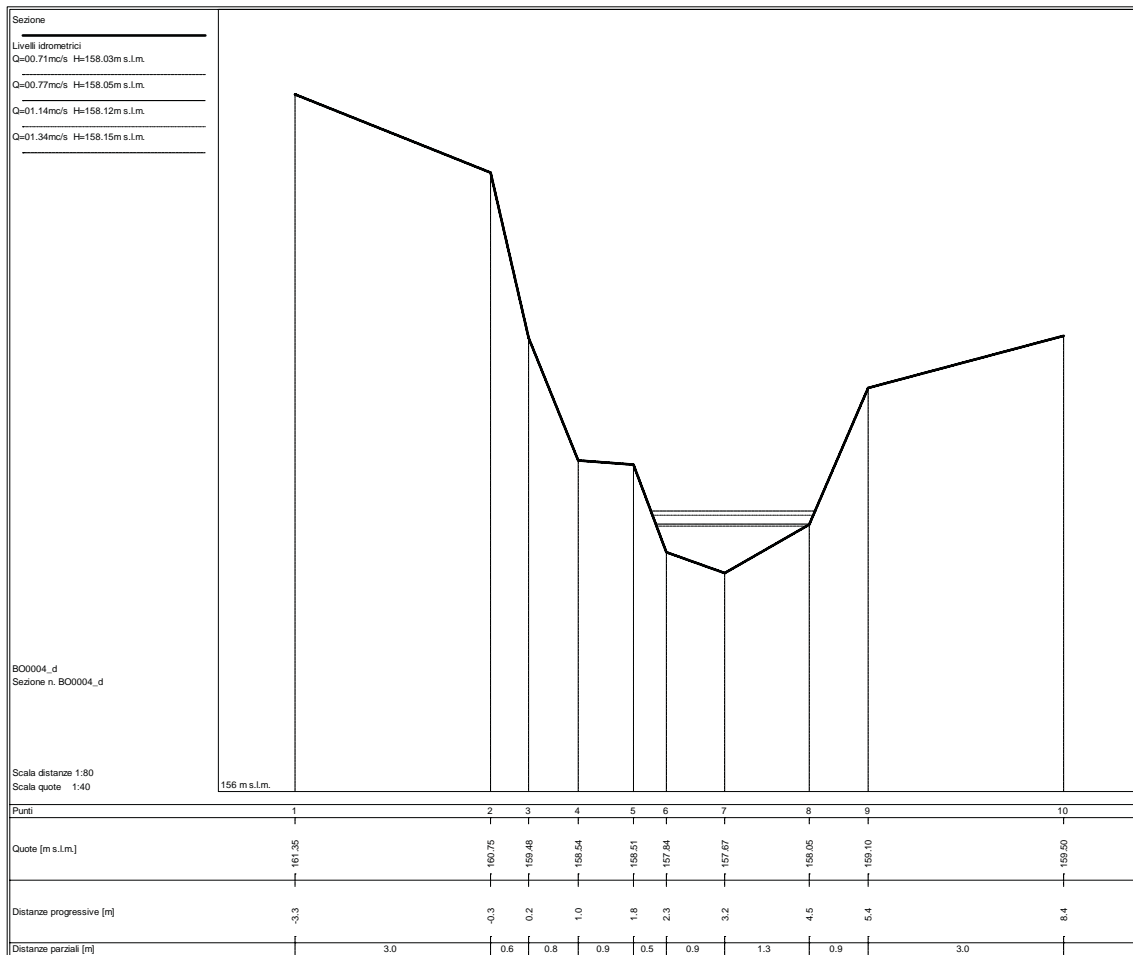
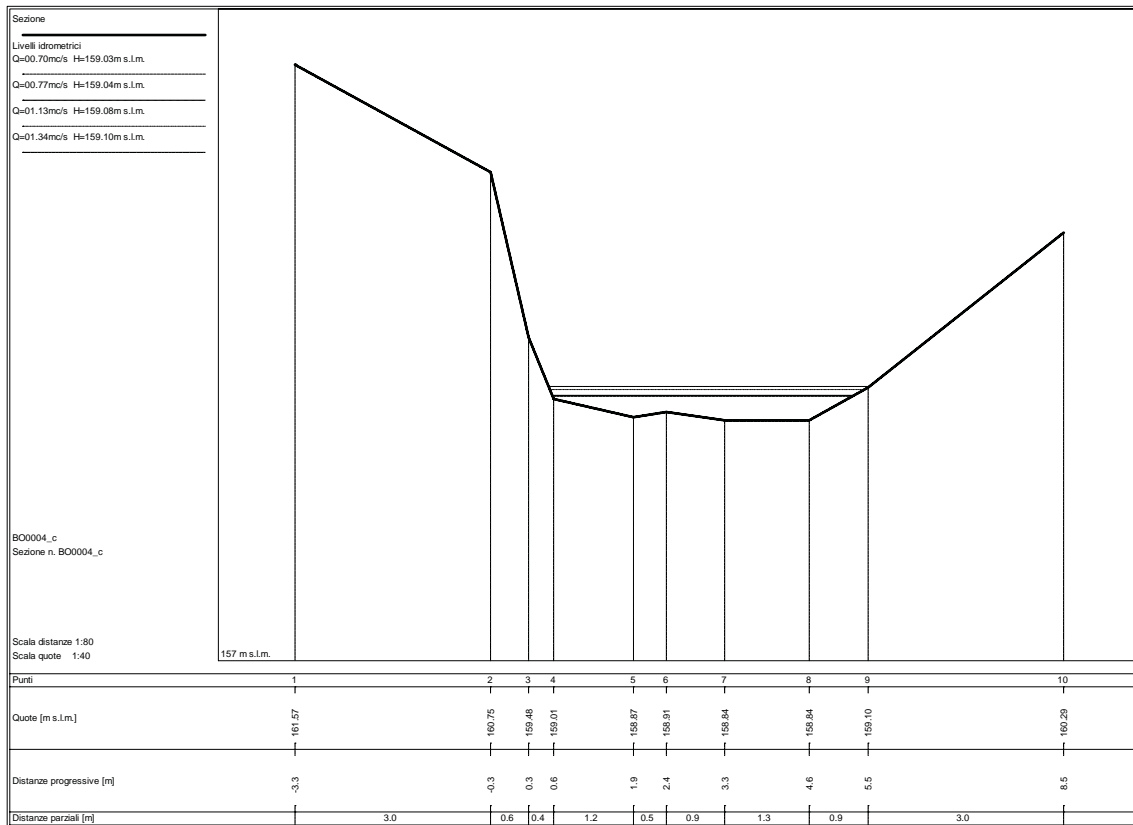

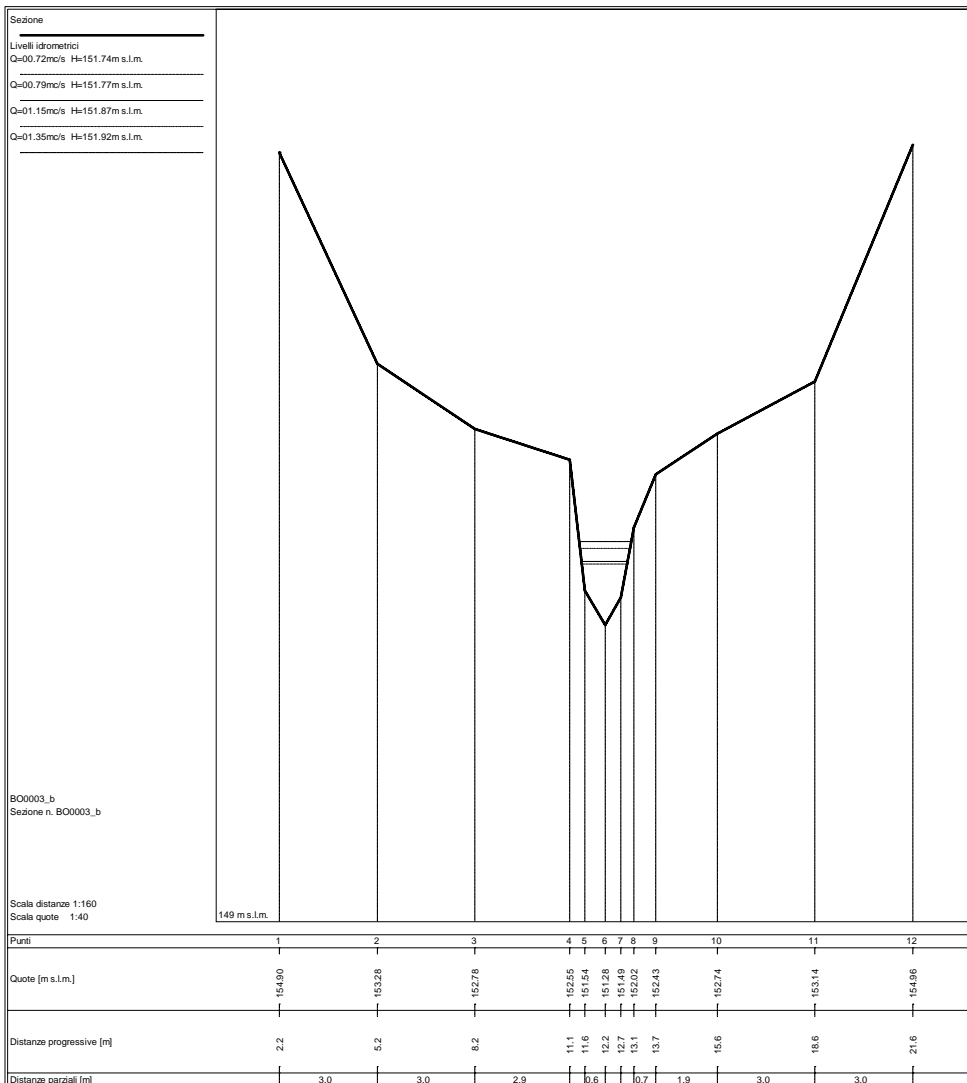
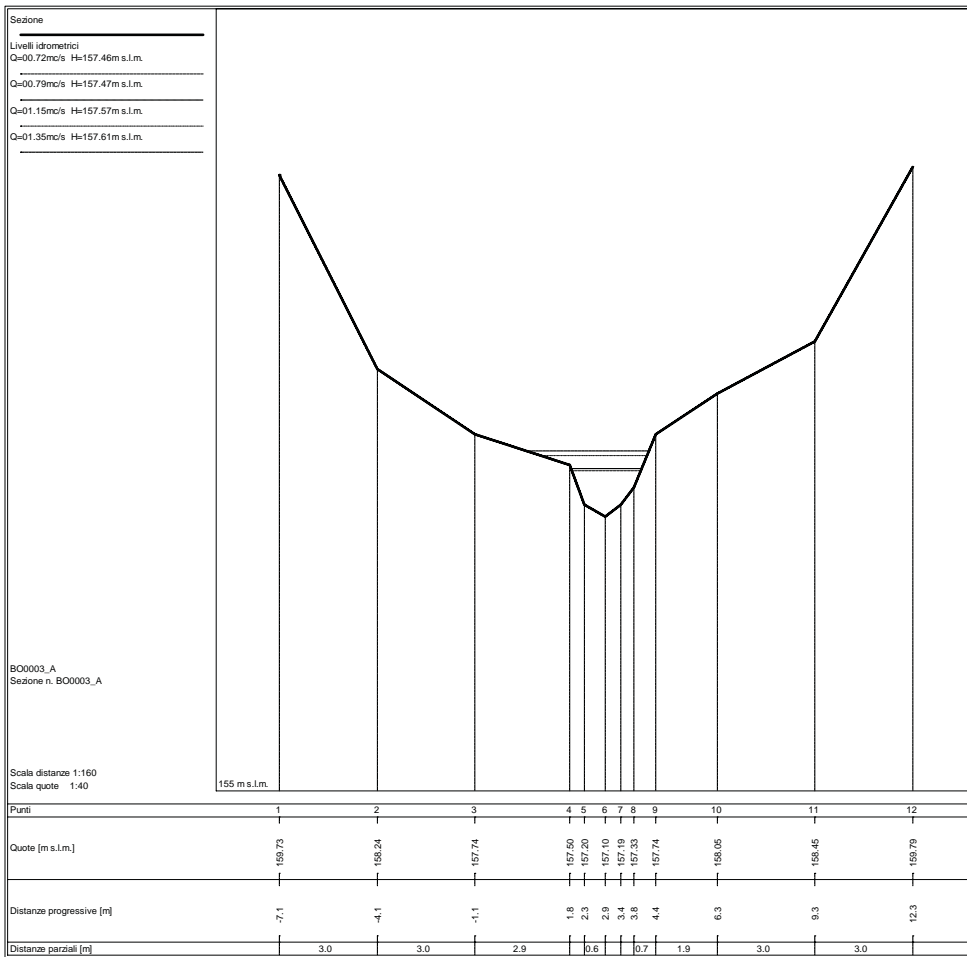

Sezione
 Livelli idrometrici
 Q=00.72mc/s H=150.36m s.l.m.
 Q=00.79mc/s H=150.39m s.l.m.
 Q=01.16mc/s H=150.49m s.l.m.
 Q=01.36mc/s H=150.54m s.l.m.

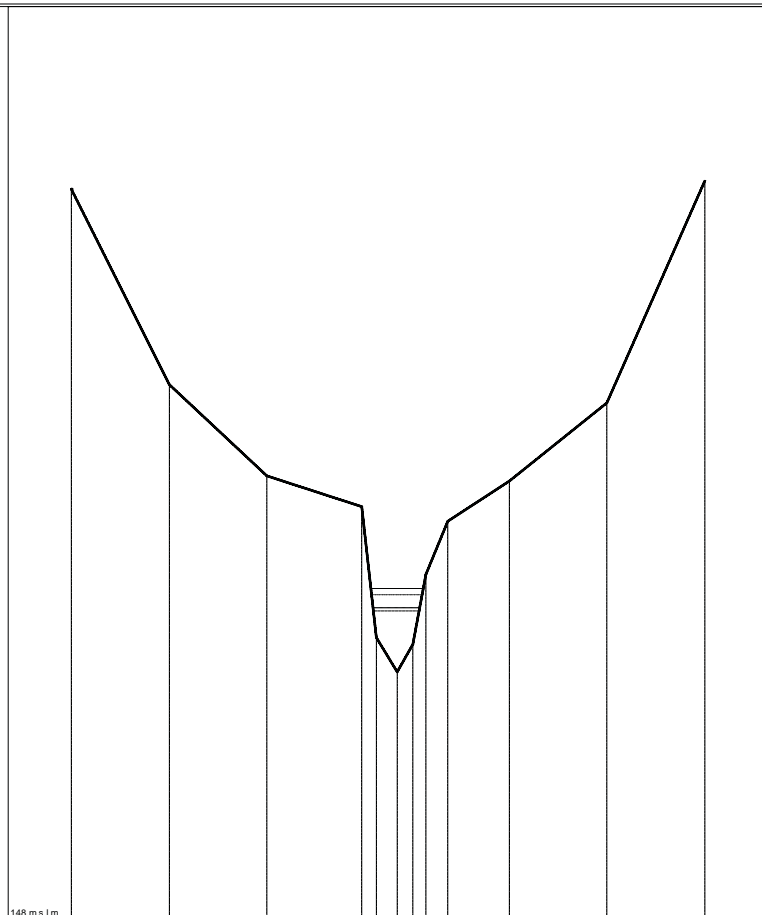

BO0003_c
 Sezione n. BO0003_c

Scala distanze 1:160
 Scala quote 1:40

Punti	1	2	3	4	5	6	7	8	9	10	11	12
Quote [m s.l.m.]	153.60	152.10	151.40	151.17	150.16	148.90	150.11	150.64	151.05	151.36	151.96	153.66
Distanze progressive [m]	2.1	5.1	8.1	11.0	11.5	12.1	12.6	13.0	13.7	15.6	18.6	21.6
Distanze parziali [m]		3.0	3.0	2.9	0.6	0.7	1.9	3.0	3.0			

Sezione
 Livelli idrometrici
 Q=00.73mc/s H=146.18m s.l.m.
 Q=00.80mc/s H=146.19m s.l.m.
 Q=01.17mc/s H=146.28m s.l.m.
 Q=01.37mc/s H=146.32m s.l.m.

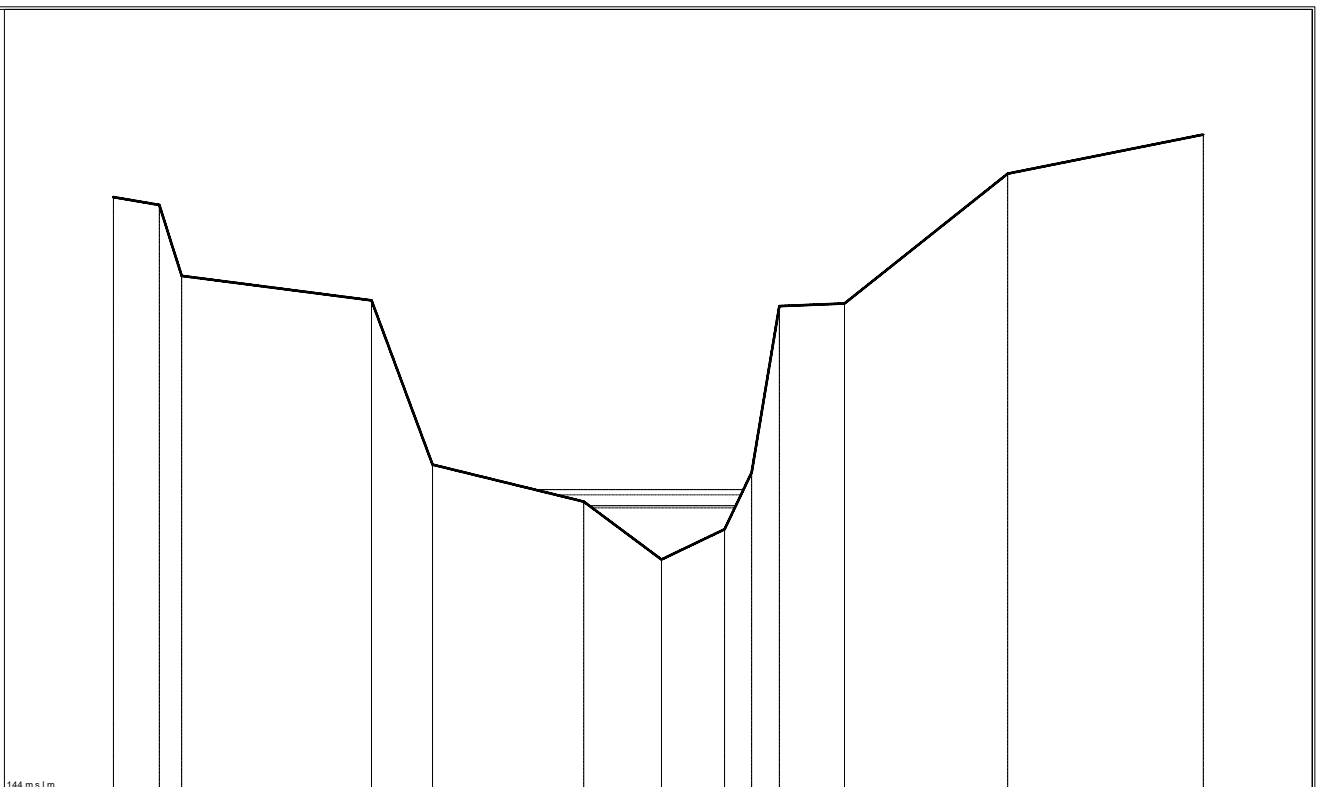

BO0002_a
 Sezione n. BO0002_a

Scala distanze 1:80
 Scala quote 1:40

Punti	1	2	3	4	5	6	7	8	9	10	11	12	13
Quote [m s.l.m.]	148.56	148.50	147.96	147.77	146.51	146.22	145.76	146.01	146.45	147.73	147.74	148.74	149.04
Distanze progressive [m]	4.7	5.4	5.8	8.7	9.6	12.0	13.1	14.1	14.5	15.0	16.0	18.5	21.5
Distanze parziali [m]		0.7	0.3	2.9	0.9	2.3	1.2	1.0	0.4	0.4	1.0	2.5	3.0

Sezione
 Livelli idrometrici
 Q=00.73m³/s H=145.06m s.l.m.
 Q=00.80m³/s H=145.08m s.l.m.
 Q=01.17m³/s H=145.18m s.l.m.
 Q=01.37m³/s H=145.23m s.l.m.

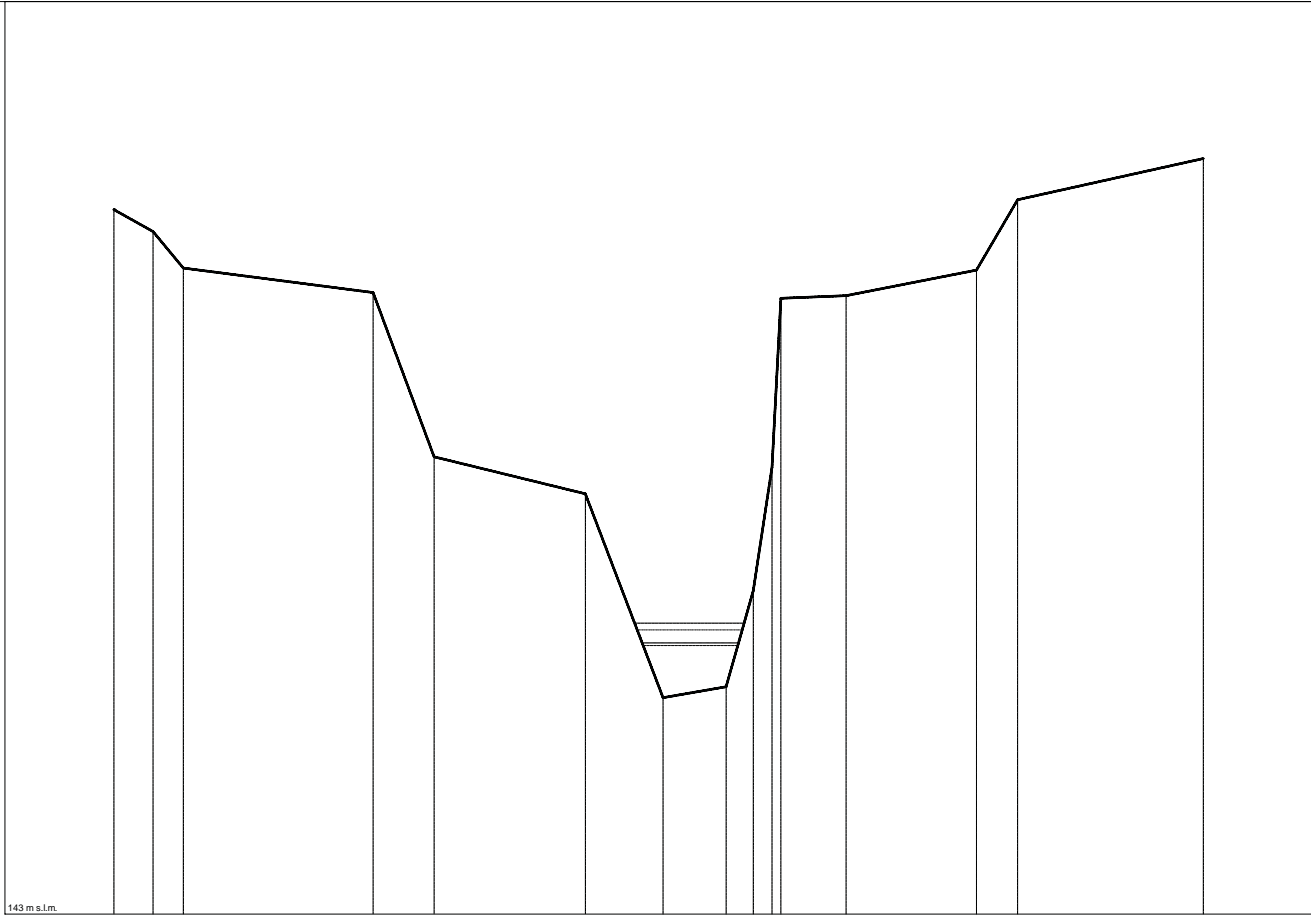

BO0002_b
 Sezione n. BO0002_b
 Scala distanze 1:80
 Scala quote 1:40

Punti	1	2	3	4	5	6	7	8	9	10	12	13	14	15
Quote [m s.l.m.]	148.40	148.24	147.98	147.77	148.51	148.22	144.99	144.74	145.48	146.43	147.74	147.94	148.48	148.80
Distanze progressive [m]	4.6	5.2	5.6	8.5	9.5	11.8	13.0	14.0	14.4	14.7	15.8	17.8	18.4	21.3
Distanze parziali [m]	0.6	0.5	2.9	0.9	2.3	1.2	1.0	0.4	0.3	1.0	2.0	0.6	2.8	

Sezione
 Livelli idrometrici
 Q=00.73m³/s H=144.30m s.l.m.
 Q=00.80m³/s H=144.32m s.l.m.
 Q=01.17m³/s H=144.39m s.l.m.
 Q=01.37m³/s H=144.42m s.l.m.

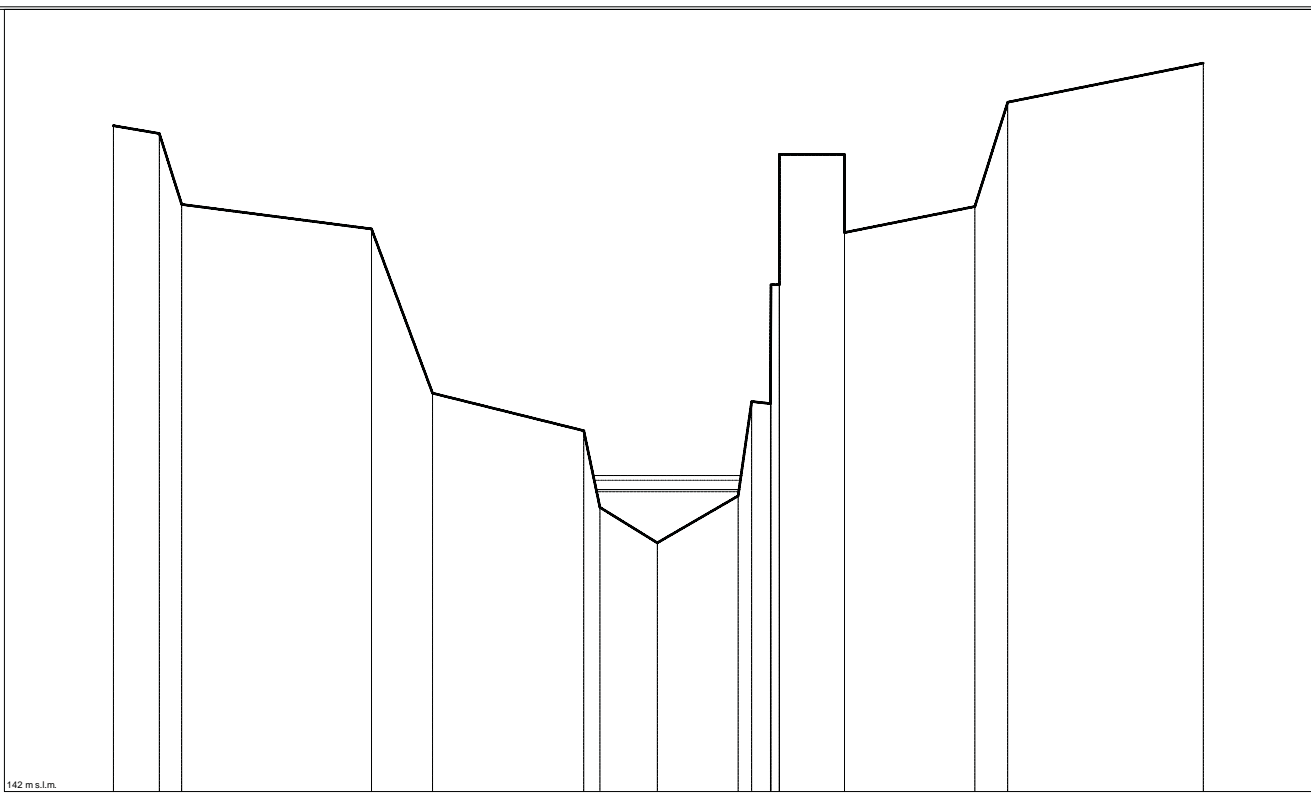

BO0002_
 Sezione n. BO0002_
 Scala distanze 1:80
 Scala quote 1:40

Punti	1	2	3	4	5	6	7	8	9	10	11	15	17	18	19
Quote [m s.l.m.]	147.11	147.05	146.50	146.32	145.08	144.77	144.18	143.91	144.27	144.09	144.88	146.89	146.49	147.29	147.59
Distanze progressive [m]	4.6	5.3	5.7	8.6	9.5	11.8	12.1	13.0	14.2	14.4	14.7	15.8	17.8	18.3	21.3
Distanze parziali [m]	0.7	0.3	2.9	0.9	2.3	0.9	1.2	0.3	0.3	1.0	1.0	2.0	0.5	3.0	

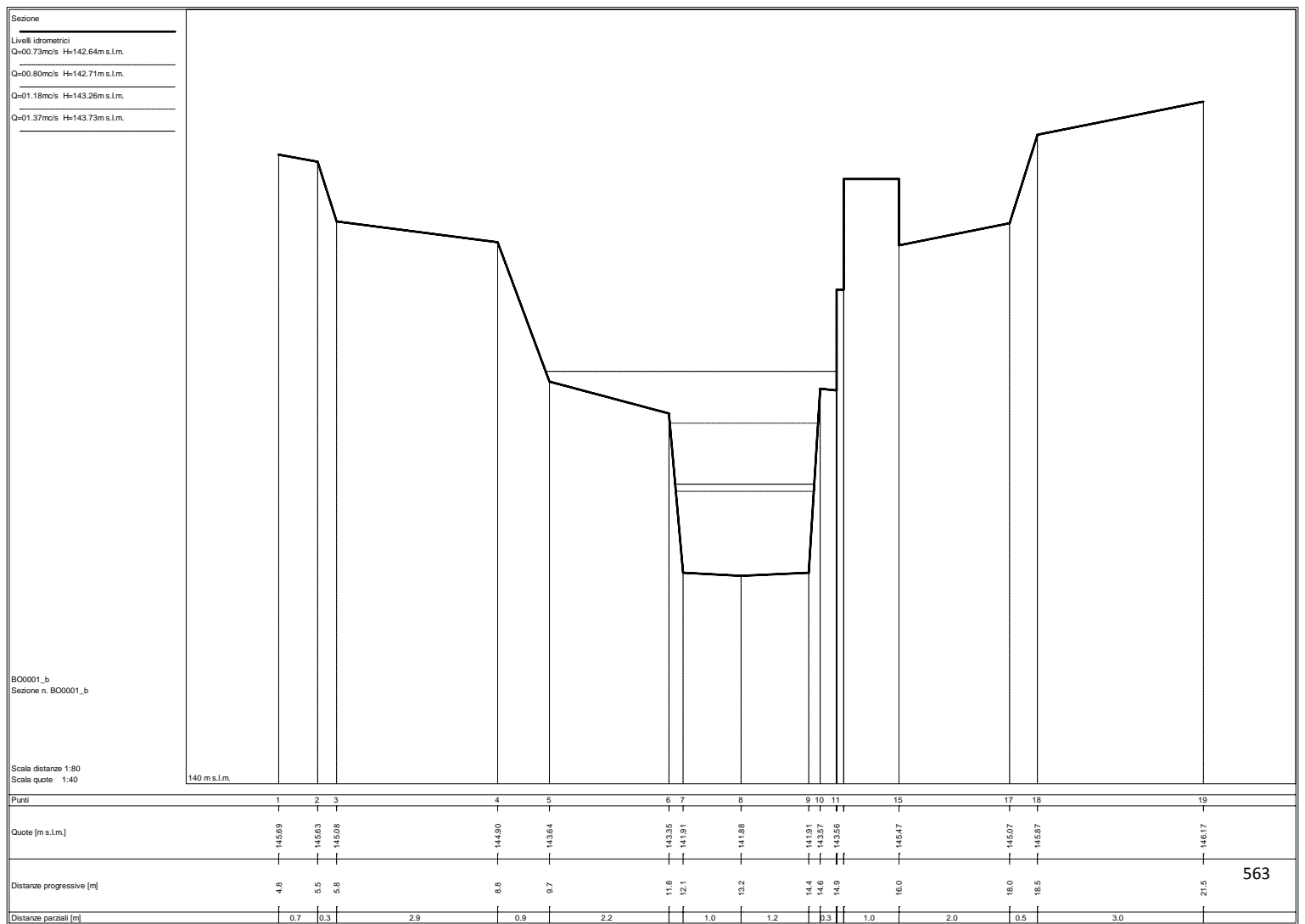
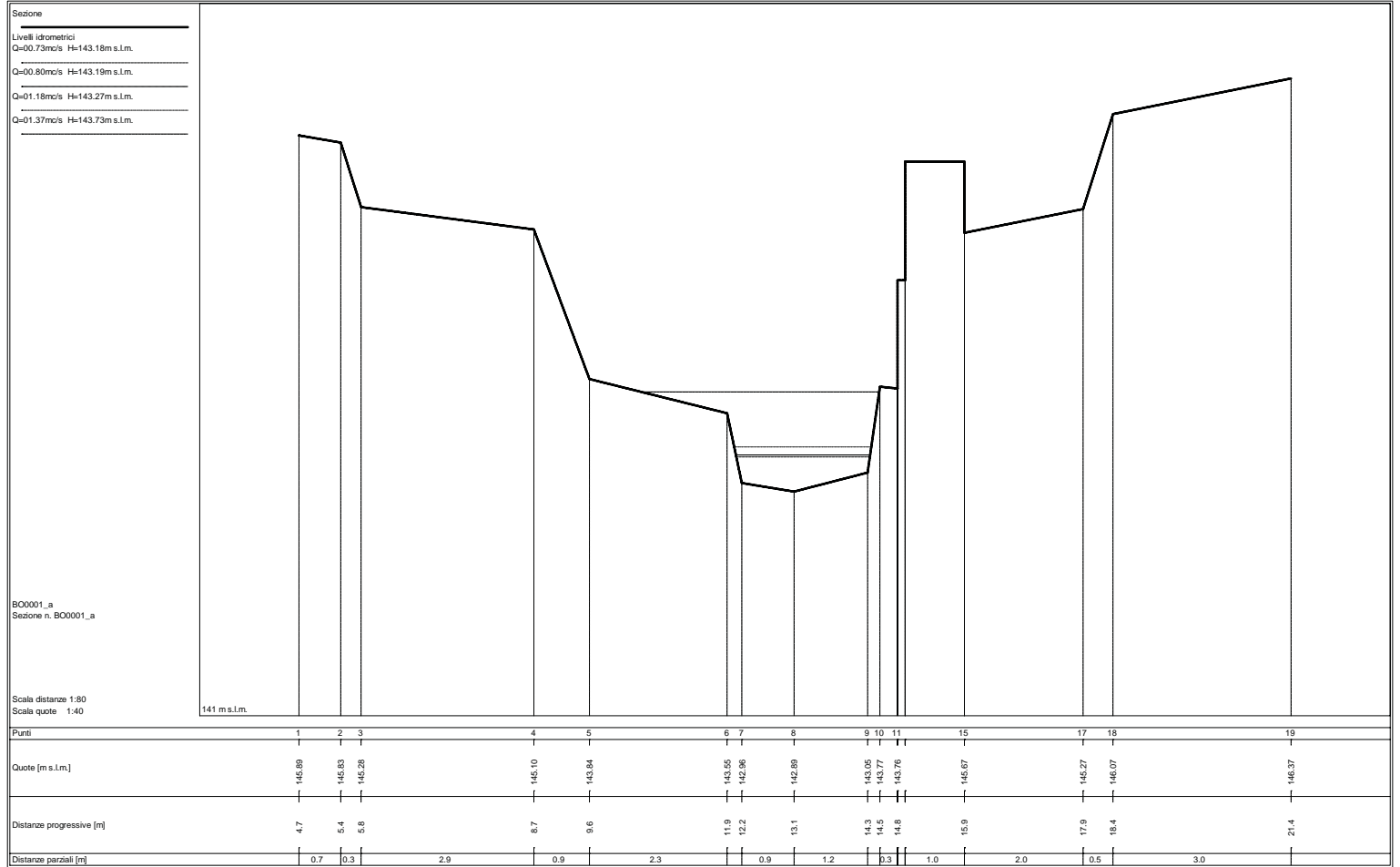

STATO ATTUALE

Sezioni fluviali fosso Bocchetta – Bocchetta_b

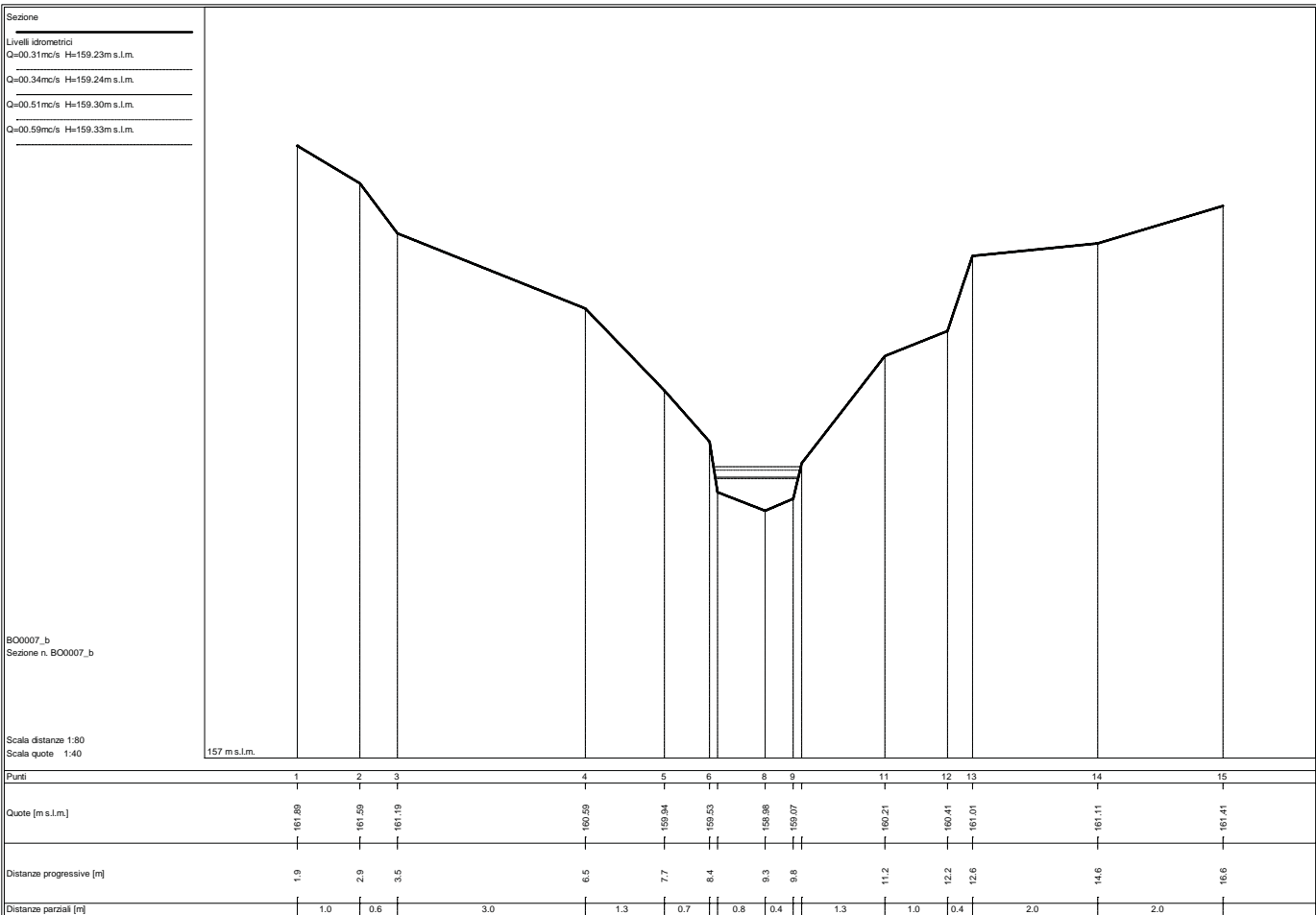
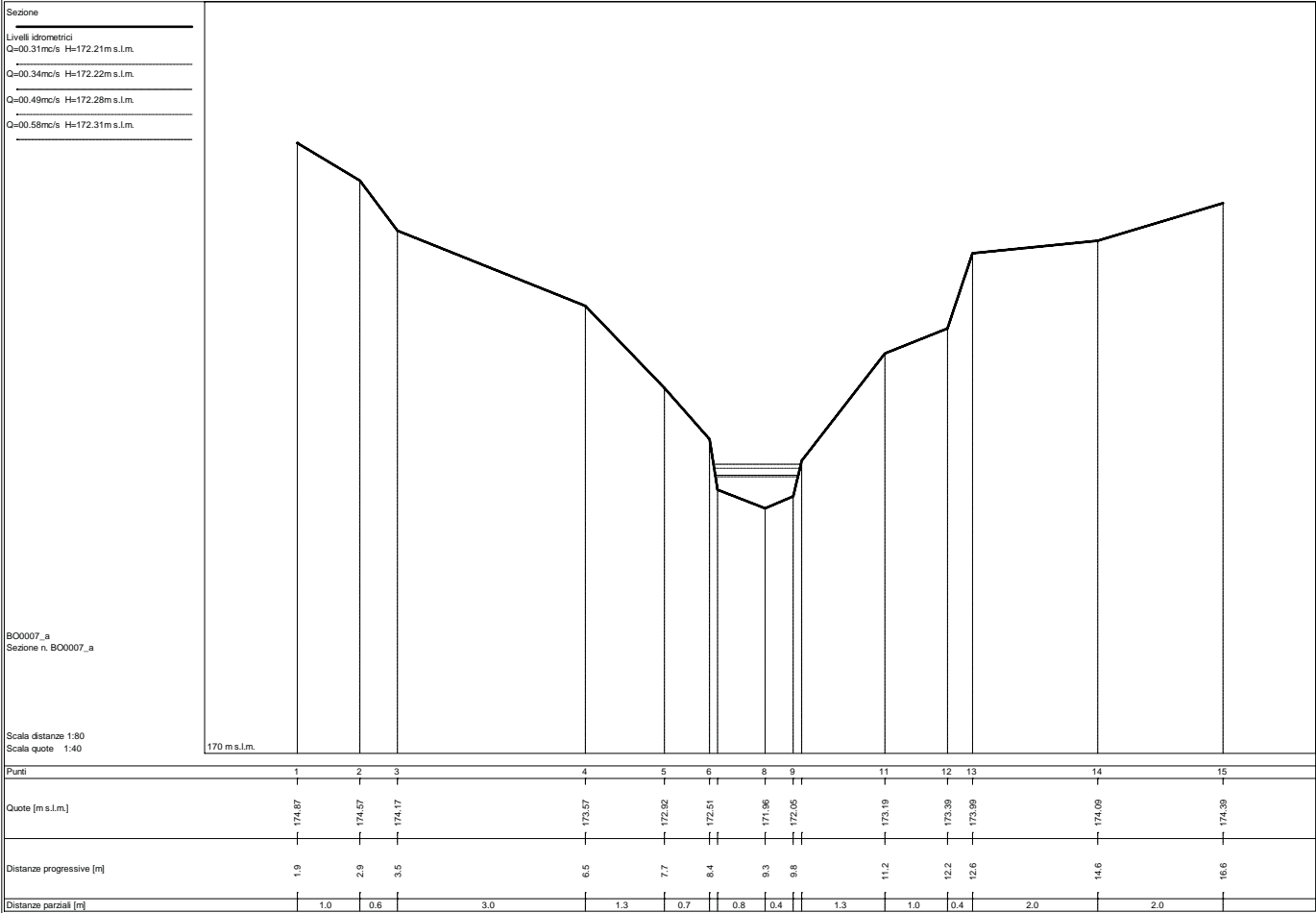

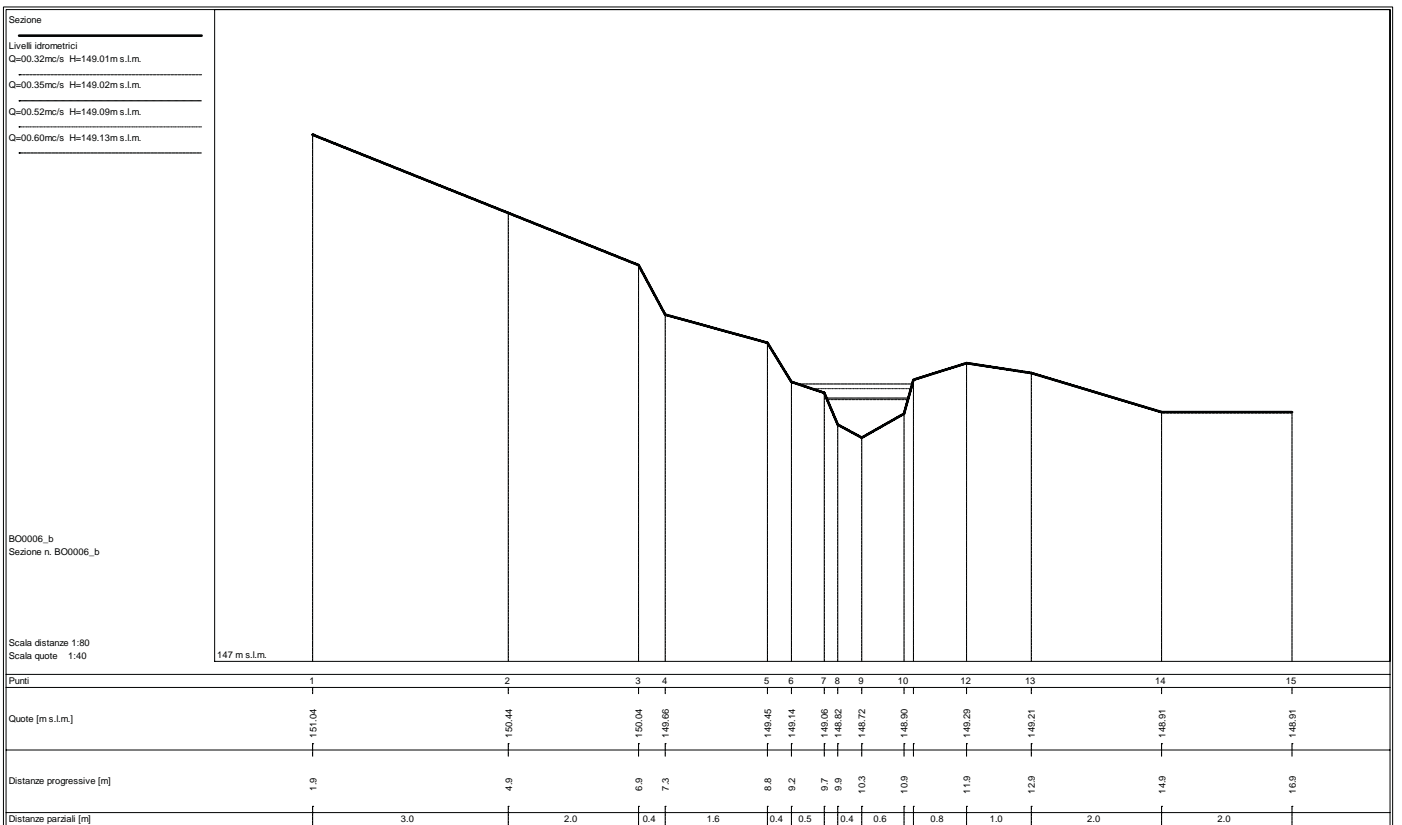
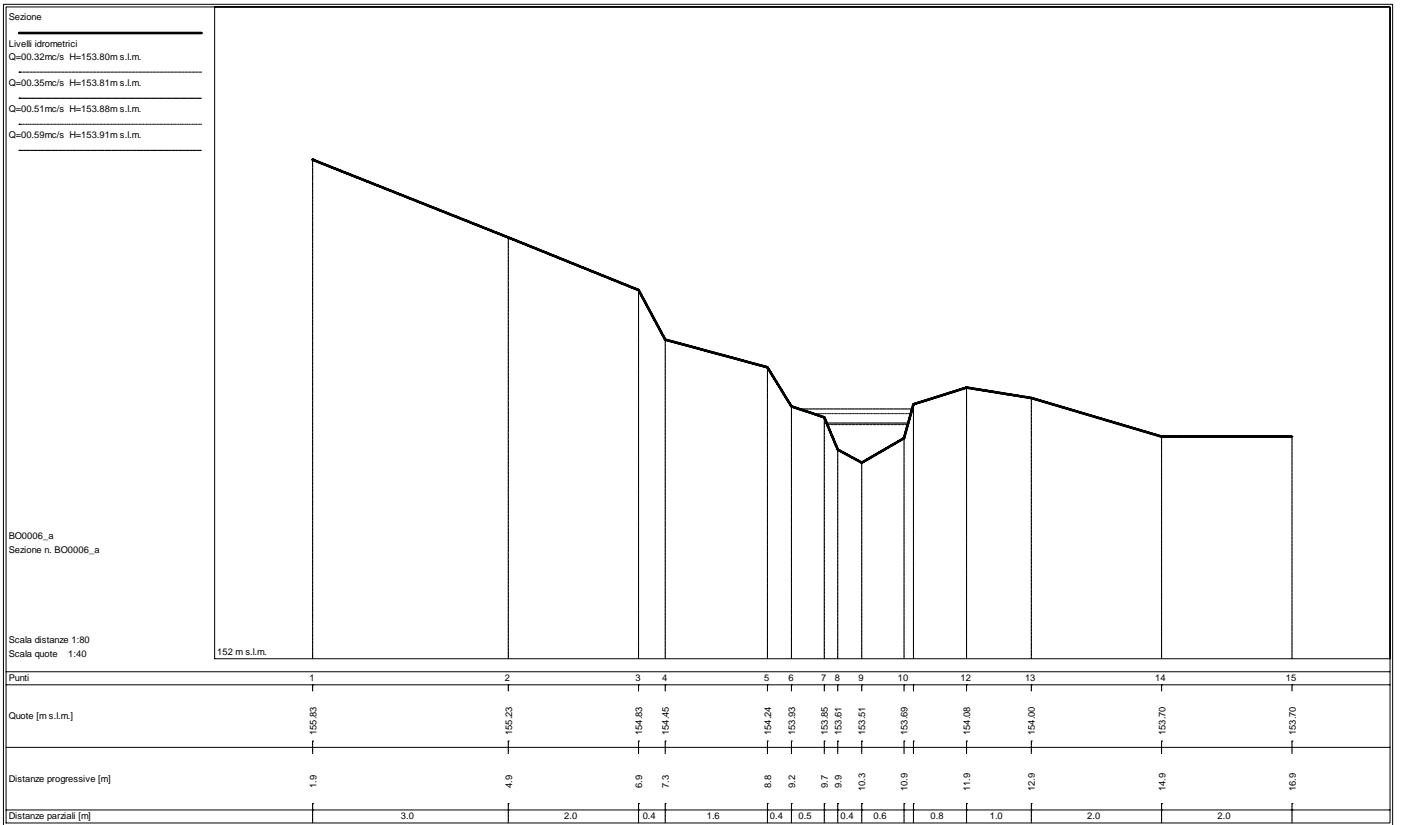

Sezione

Livelli idrometrici

Q=0.33mc/s H=143.74m s.L.m.

Q=0.35mc/s H=143.76m s.L.m.

Q=0.52mc/s H=143.83m s.L.m.

Q=0.60mc/s H=143.86m s.L.m.

BO0005_

Sezione n. BO0005_

Scala distanze 1:80

Scala quote 1:80

139 m s.L.m.

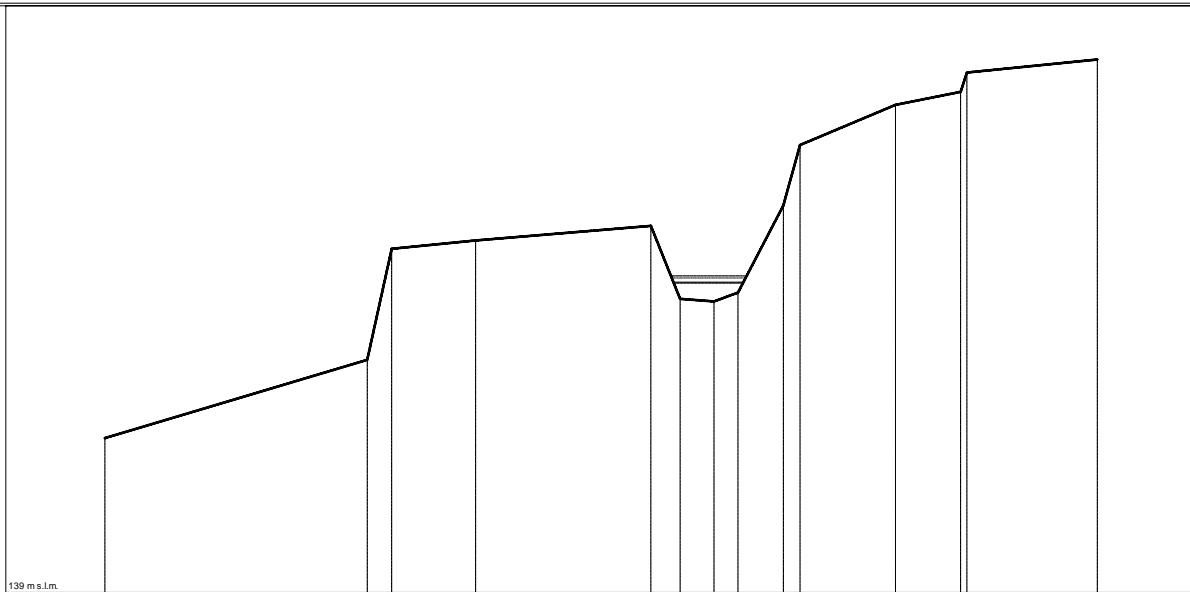

Punti	1	2	3	4	5	6	7	8	9	10	11	12	14
Quote [m s.L.m.]	141.37	142.57	144.27	144.40	144.63	143.50	143.46	143.60	144.94	145.86	146.48	146.68	147.18
Distanze progressive [m]	0.7	4.8	5.1	6.4	9.1	9.6	10.1	10.4	11.1	11.4	12.9	13.9	16.0
Distanze parziali [m]		4.0	0.4	1.3	2.7	0.4	0.5	0.4	0.7	1.5	1.0	2.0	

STATO ATTUALE

Sezioni fluviali fosso Bocchetta – Bocchetta_c

Sezione
 Livelli idrometrici
 Q=01.06mc/s H=142.64m s.l.m.
 Q=01.16mc/s H=142.71m s.l.m.
 Q=01.70mc/s H=143.26m s.l.m.
 Q=01.97mc/s H=143.73m s.l.m.

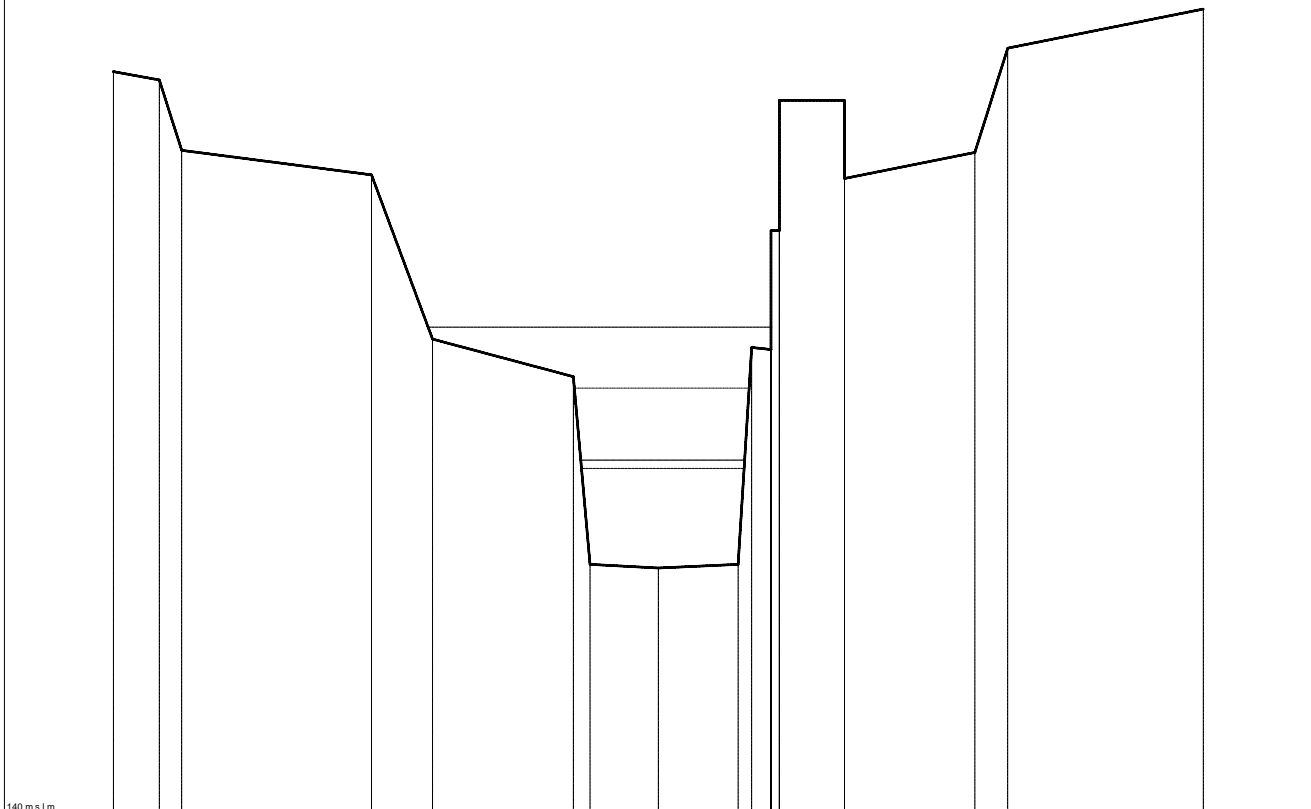

BO0001_b
 Sezione n. BO0001_b
 Scala distanza 1:80
 Scala quote 1:40
 140 m s.l.m.

Punti	1	2	3	4	5	6	7	8	9	10	11	15	17	18	19
Quote [m s.l.m.]	145.69	145.63	145.08	144.90	143.64	143.35	141.91	141.88	141.91	143.57	143.56	145.47	145.07	145.87	146.17
Distanze progressive [m]	4.8	5.5	5.8	8.8	9.7	11.8	12.1	13.2	14.4	14.6	14.9	16.0	18.0	18.5	21.5
Distanze parziali [m]	0.7	0.3	2.9	0.9	2.2	1.0	1.2	1.3	1.0	2.0	0.5	3.0			

Sezione
 Livelli idrometrici
 Q=01.06mc/s H=142.62m s.l.m.
 Q=01.16mc/s H=142.70m s.l.m.
 Q=01.70mc/s H=143.25m s.l.m.
 Q=01.96mc/s H=143.71m s.l.m.

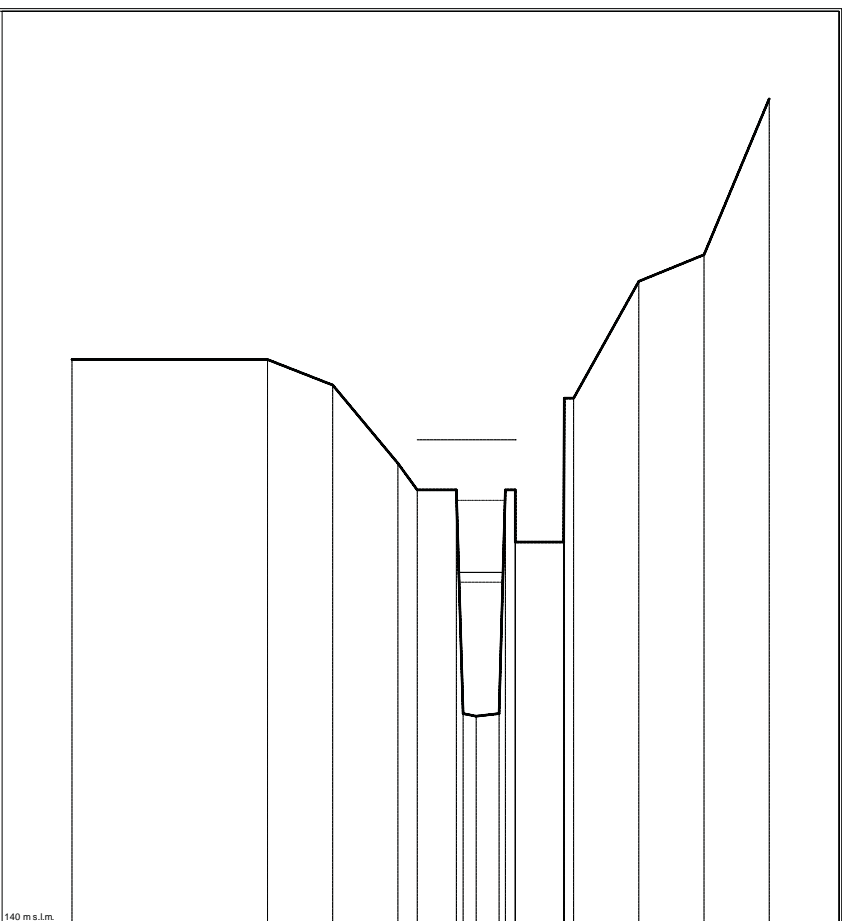

BO0001_c
 Sezione n. BO0001_c
 Scala distanza 1:160
 Scala quote 1:40
 140 m s.l.m.

Punti	1	2	3	4	5	6	8	9	11	13	16	17	18
Quote [m s.l.m.]	144.33	144.33	144.13	143.53	143.33	143.33	141.59	141.61	143.33	142.93	144.93	145.13	146.33
Distanze progressive [m]	0.8	6.8	8.8	10.8	11.4	12.6	13.2	13.9	14.4	15.9	18.2	20.2	22.2
Distanze parziali [m]		6.0	2.0	2.0	0.6	1.2	0.7		1.5	2.0	2.0	2.0	

Sezione
 Ponte
 Livelli idrometrici
 Q=01.06mc/s H=142.24m s.l.m.
 Q=01.16mc/s H=142.27m s.l.m.
 Q=01.70mc/s H=142.35m s.l.m.
 Q=01.96mc/s H=143.52m s.l.m.

BO0001_d
 Sezione n. BO0001_d

Scala distanze 1:160
 Scala quote 1:40

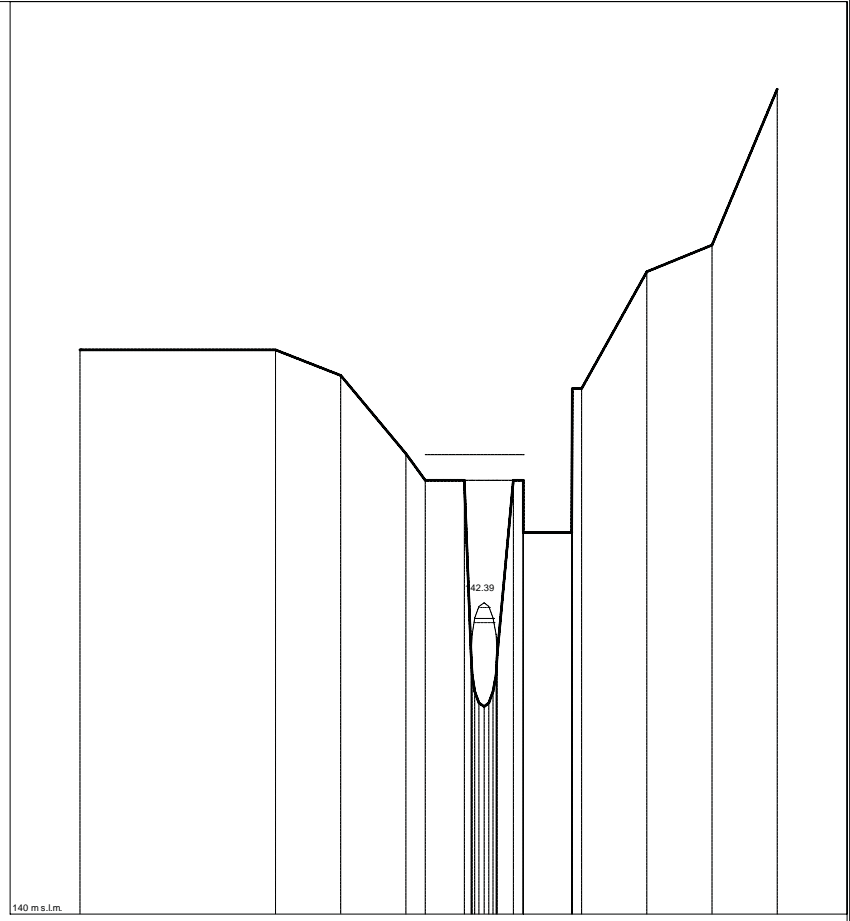

Punti	1	2	3	4	5	6	10	13	16	20	23	24	25
Quote [m s.l.m.]	144.33	144.33	144.13	143.53	143.33	143.33	141.62	141.71	143.33	142.83	144.93	145.13	146.33
Distanze progressive [m]	0.8	6.8	8.8	10.8	11.4	12.6	13.1	13.5	14.1	15.9	18.2	20.2	22.2
Distanze parziali [m]		6.0	2.0	2.0	0.6	1.2	0.5	0.4	0.6	1.5	2.0	2.0	2.0

Sezione
 Ponte
 Livelli idrometrici
 Q=01.07mc/s H=137.69m s.l.m.
 Q=01.17mc/s H=137.72m s.l.m.
 Q=01.71mc/s H=137.81m s.l.m.
 Q=01.93mc/s H=138.85m s.l.m.

BO0001da
 Sezione n. BO0001da

Scala distanze 1:20
 Scala quote 1:40

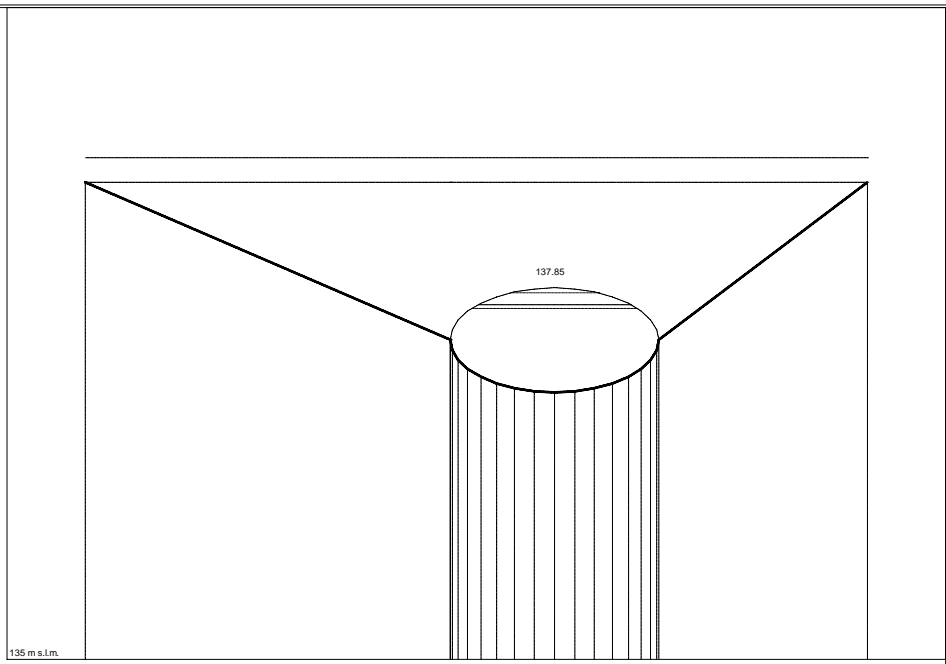

Punti	1	2	6	7	8	9	10	11	12	13	14	15	16	18	20
Quote [m s.l.m.]	138.66	137.45	137.23	137.17	137.12	137.08	137.06	137.05	137.06	137.08	137.12	137.17	137.23	137.37	138.66
Distanze progressive [m]	1.2	2.6	2.7	2.7	2.8	2.8	2.9	3.0	3.1	3.2	3.2	3.3	3.3	3.4	4.2
Distanze parziali [m]		1.4	0.1	0.1	0.1	0.1	0.1	0.1	0.1	0.1	0.1	0.1	0.1	0.1	0.8

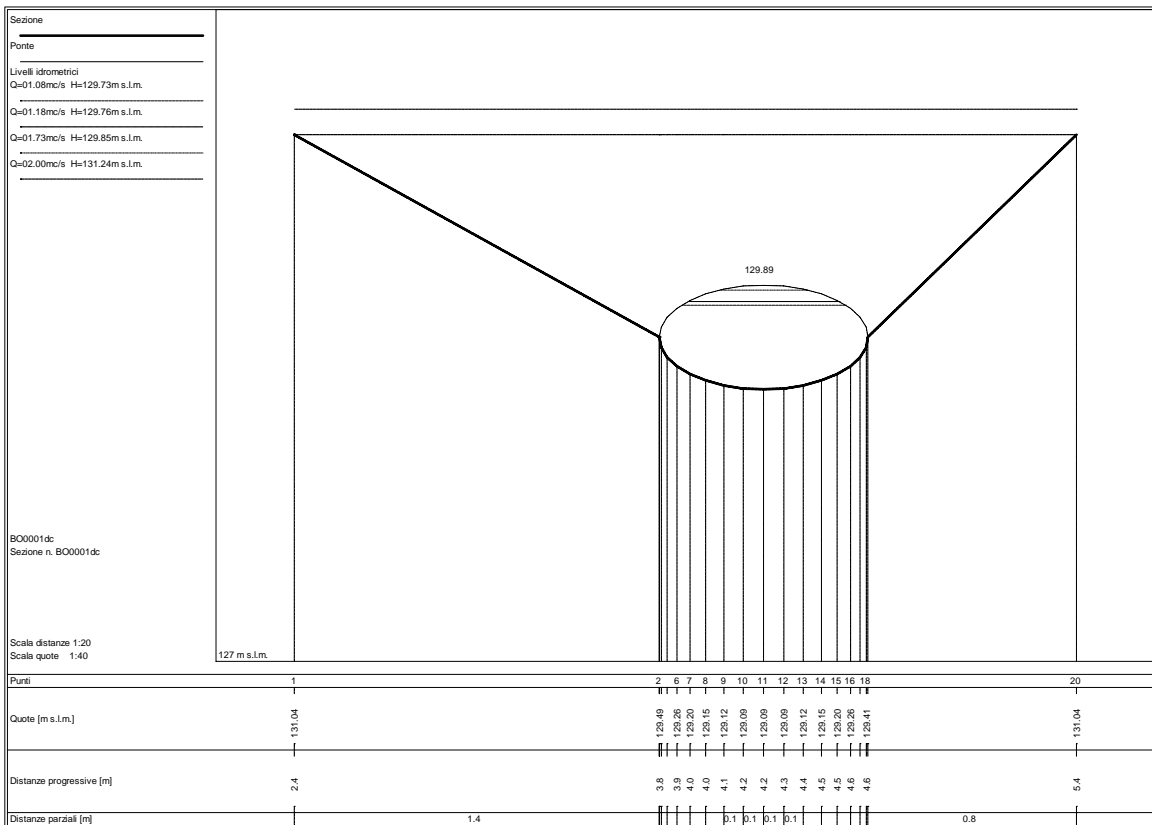
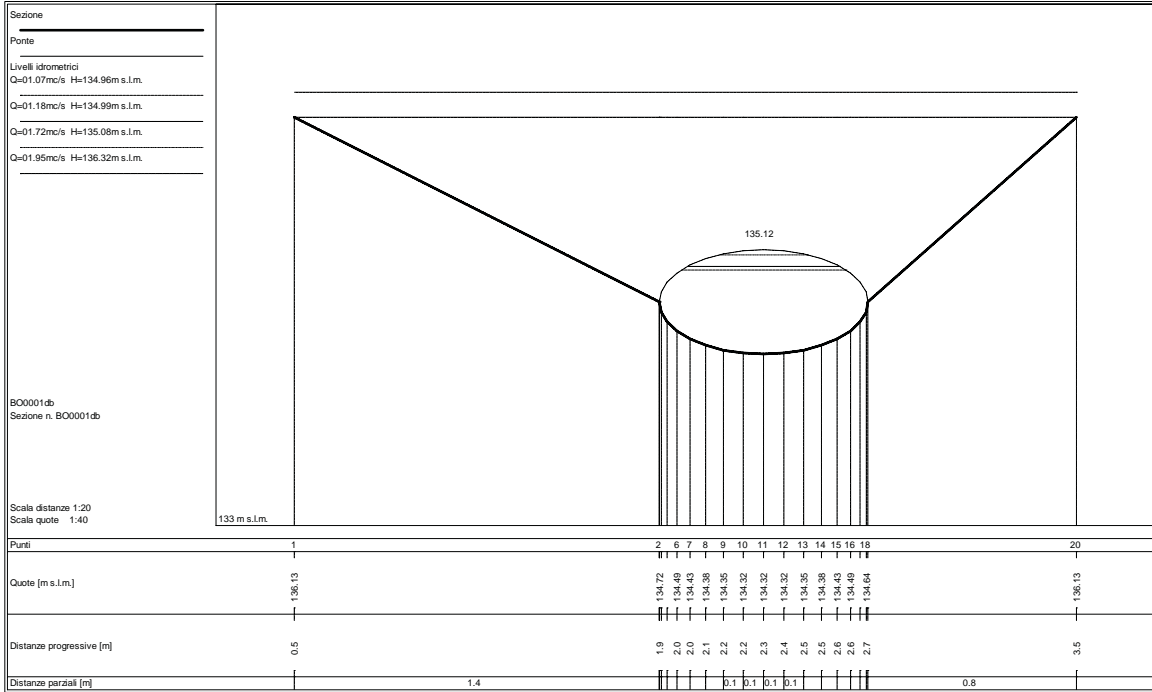

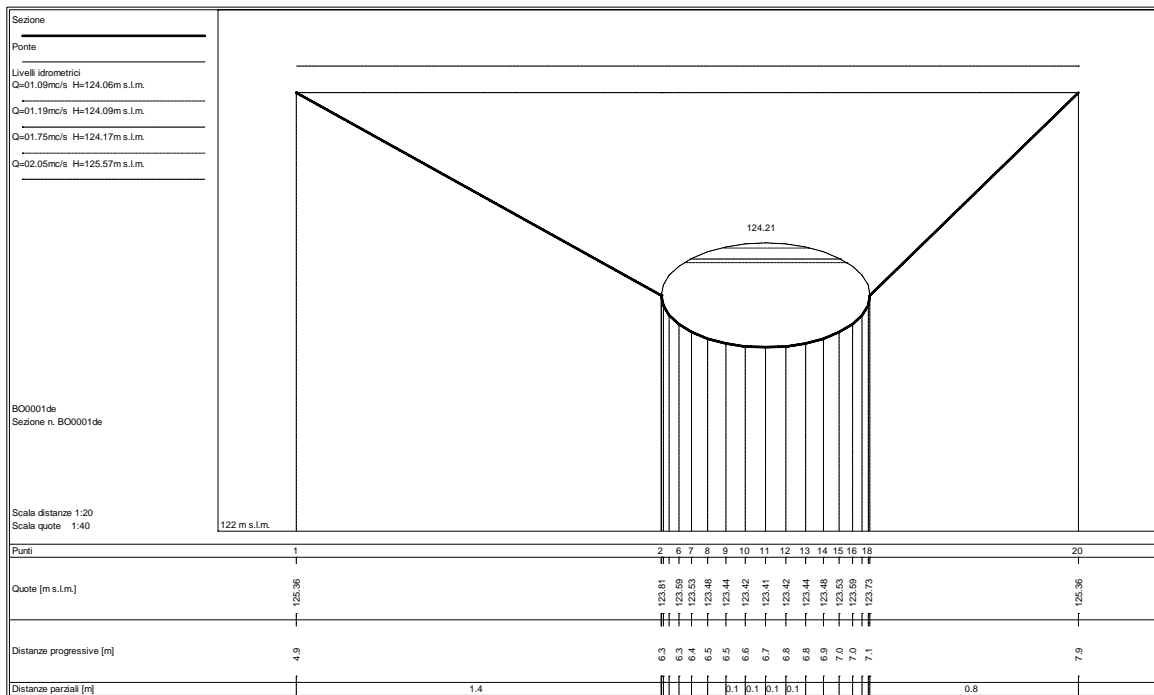
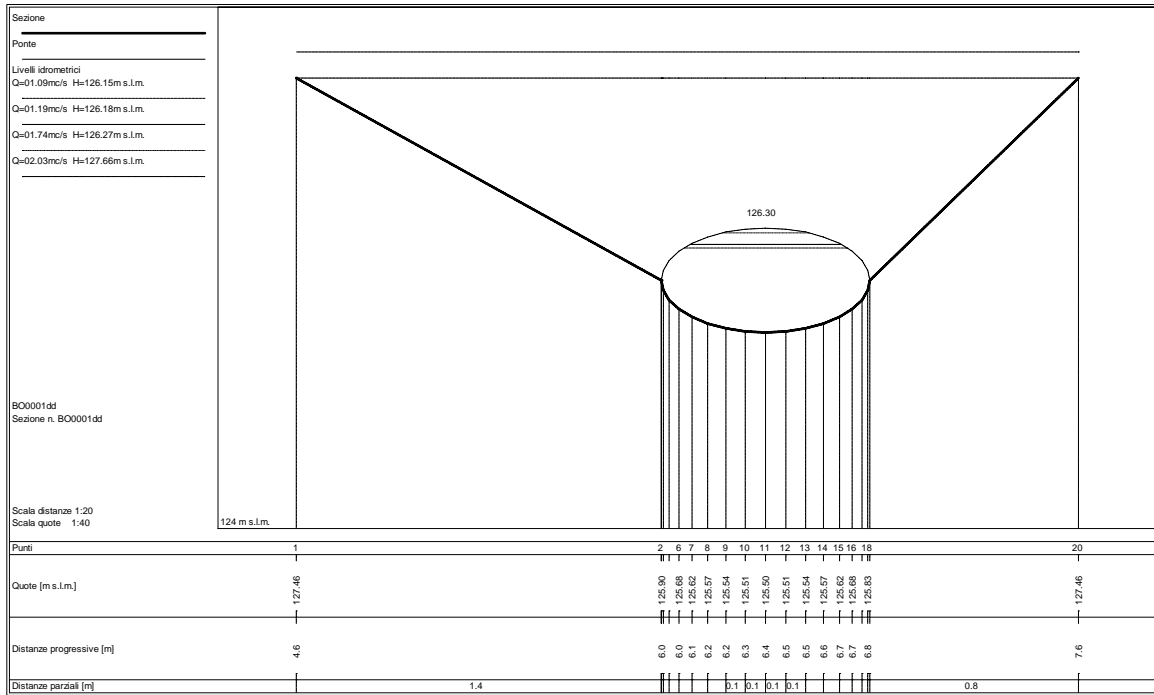

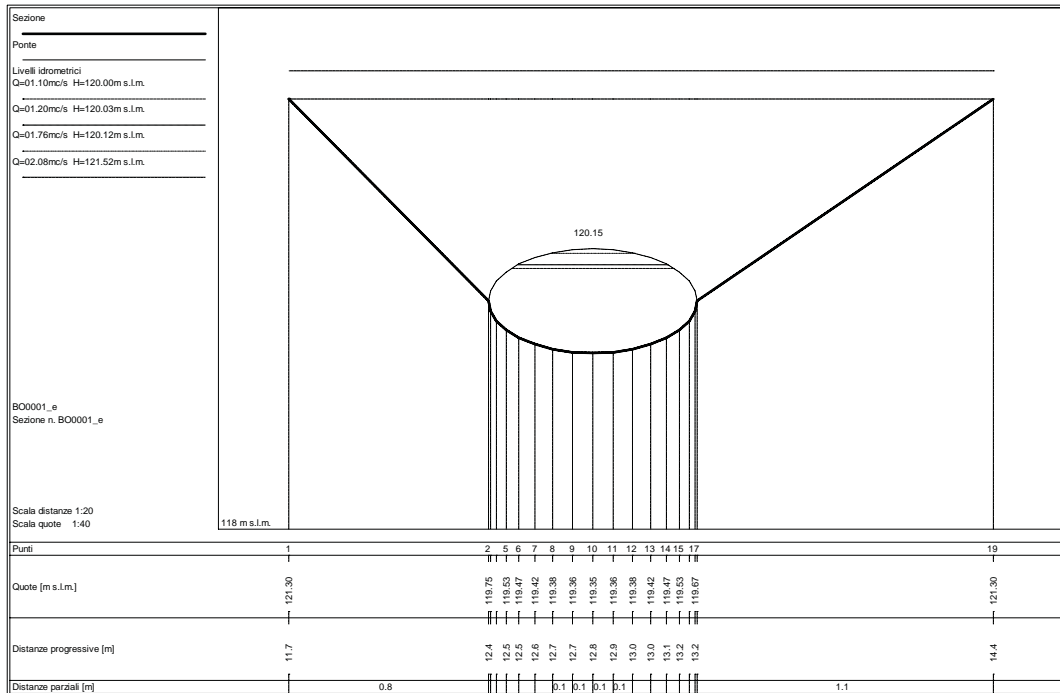
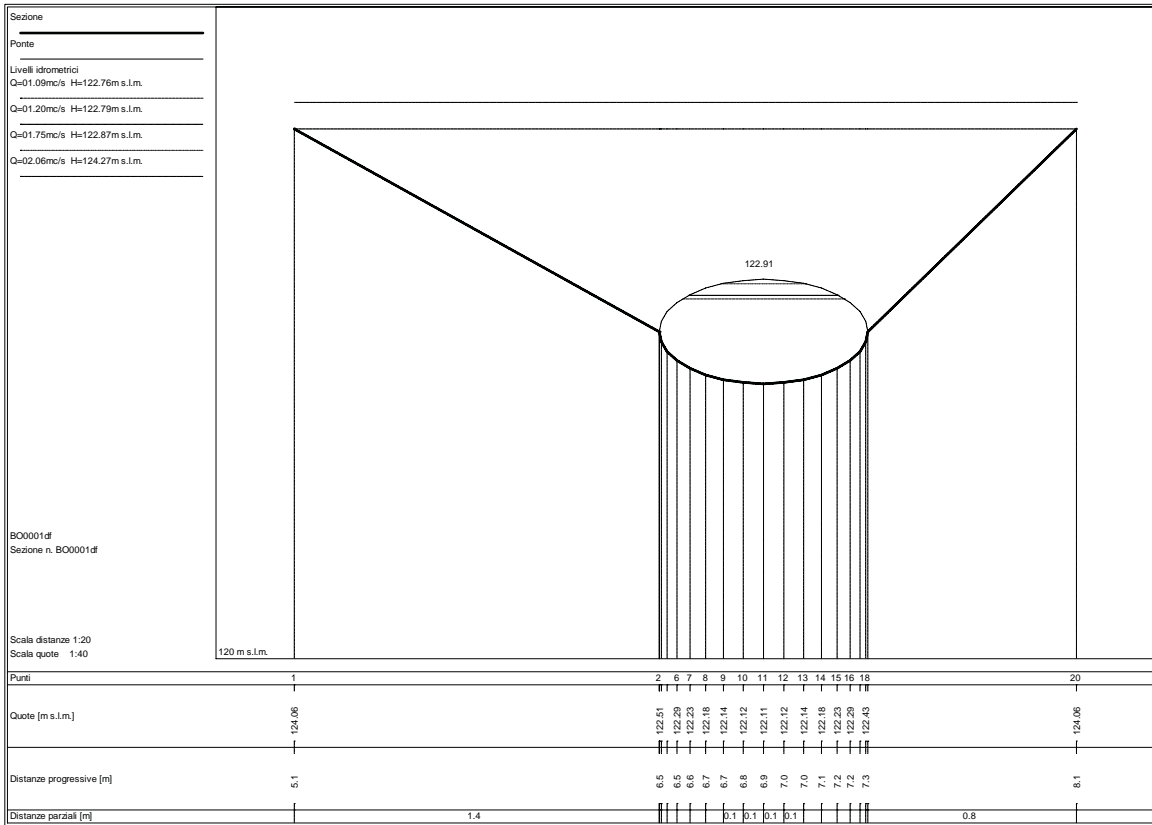

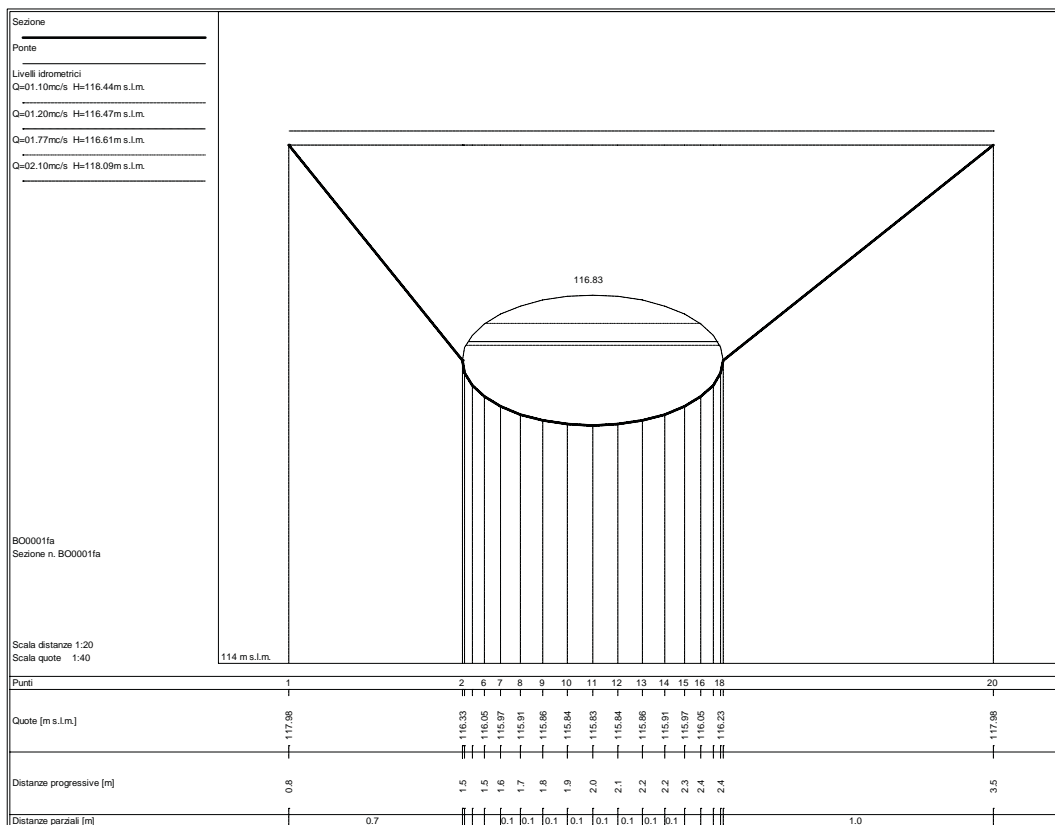
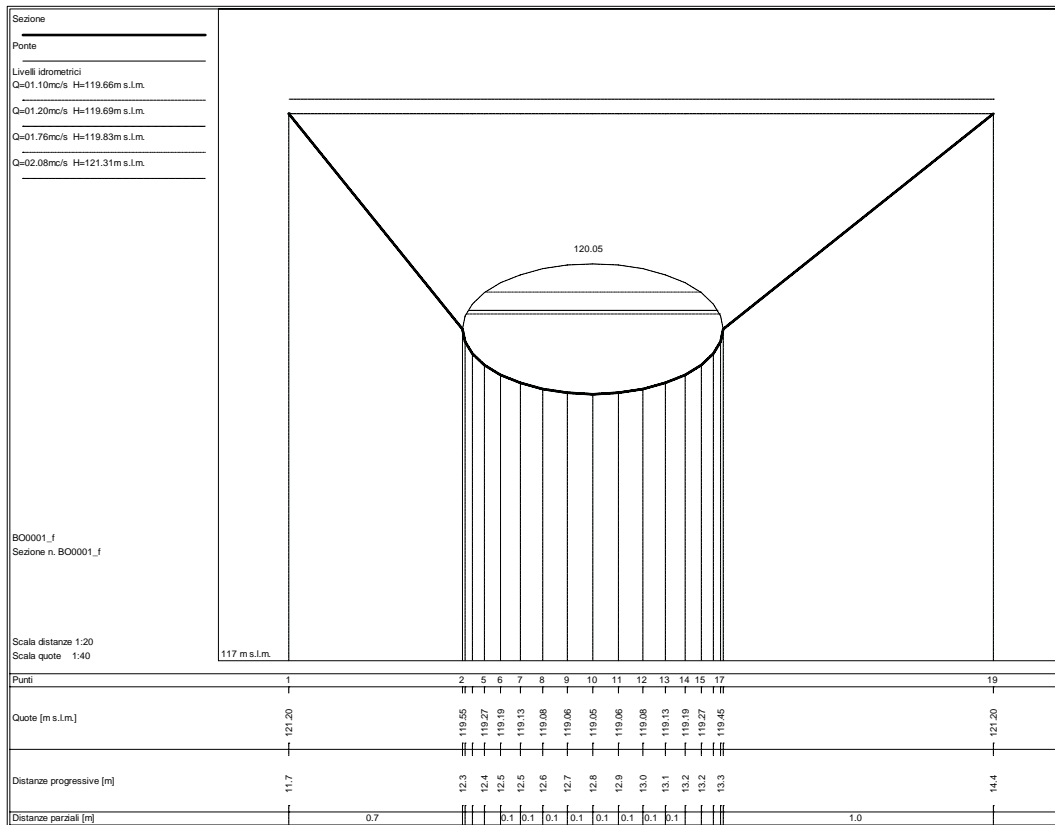

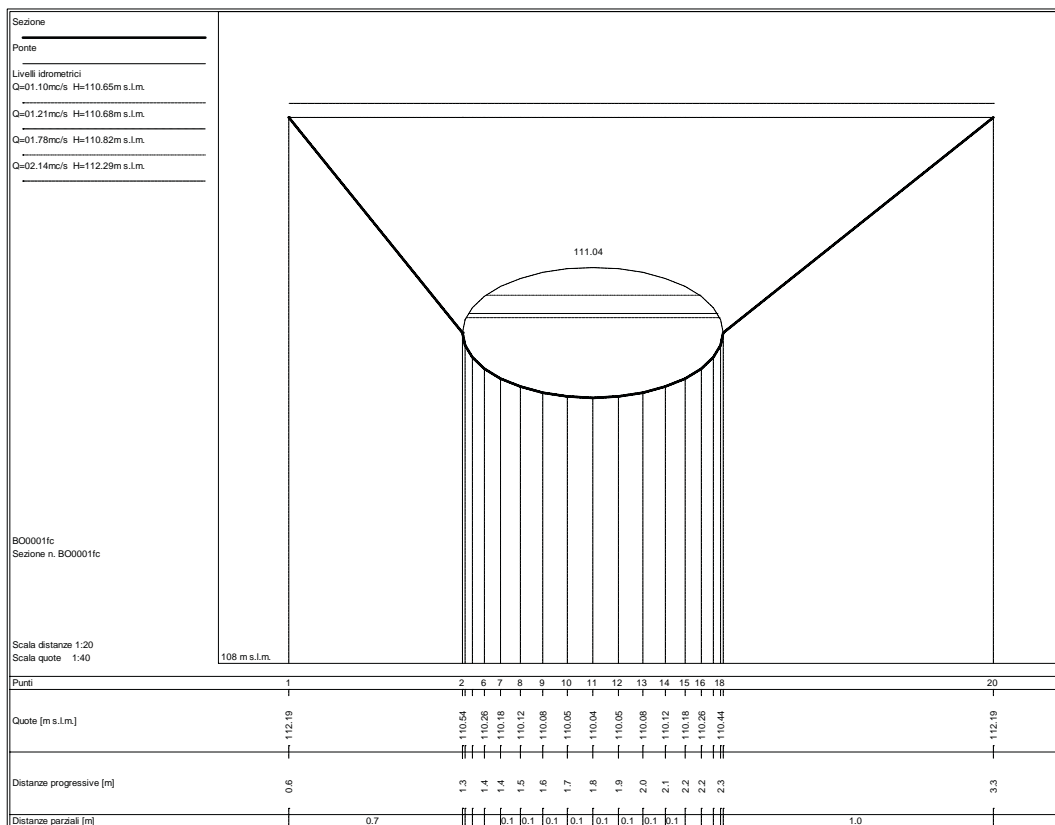
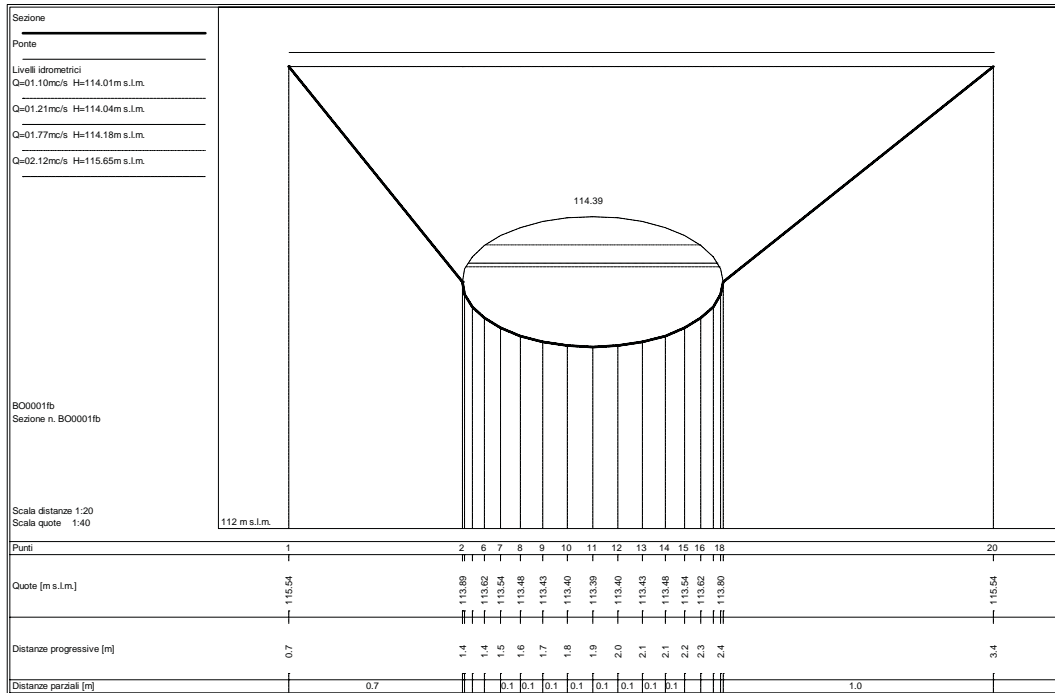

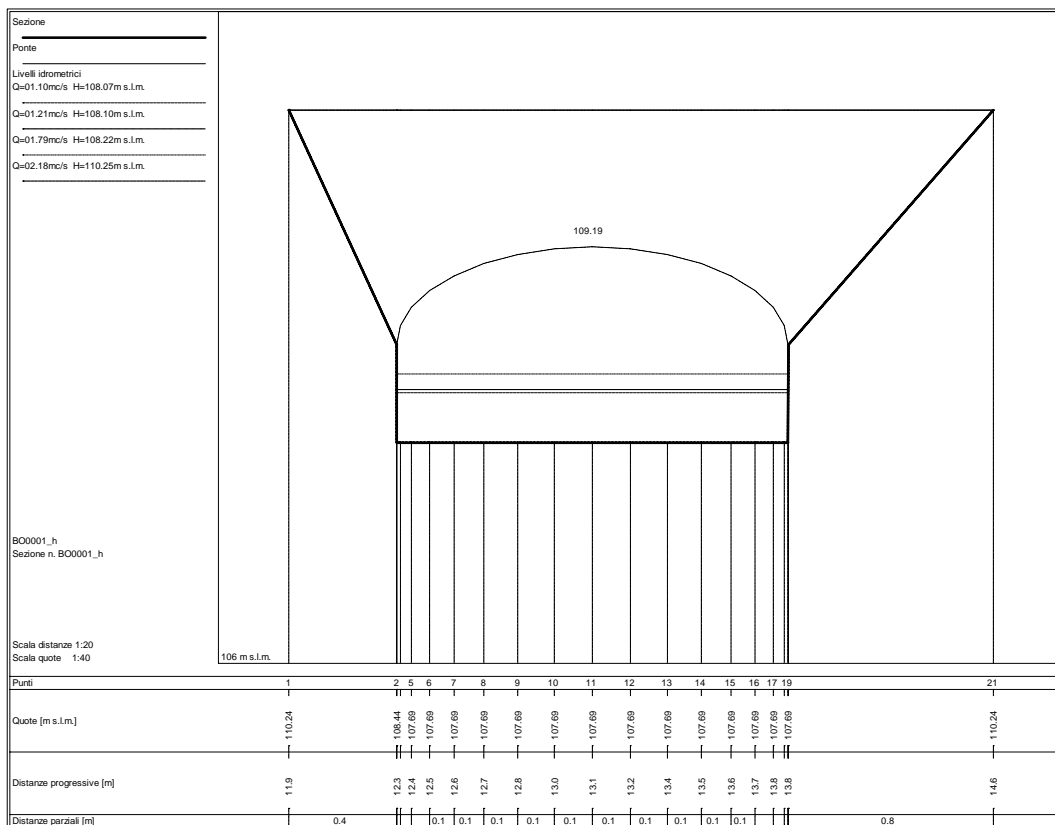
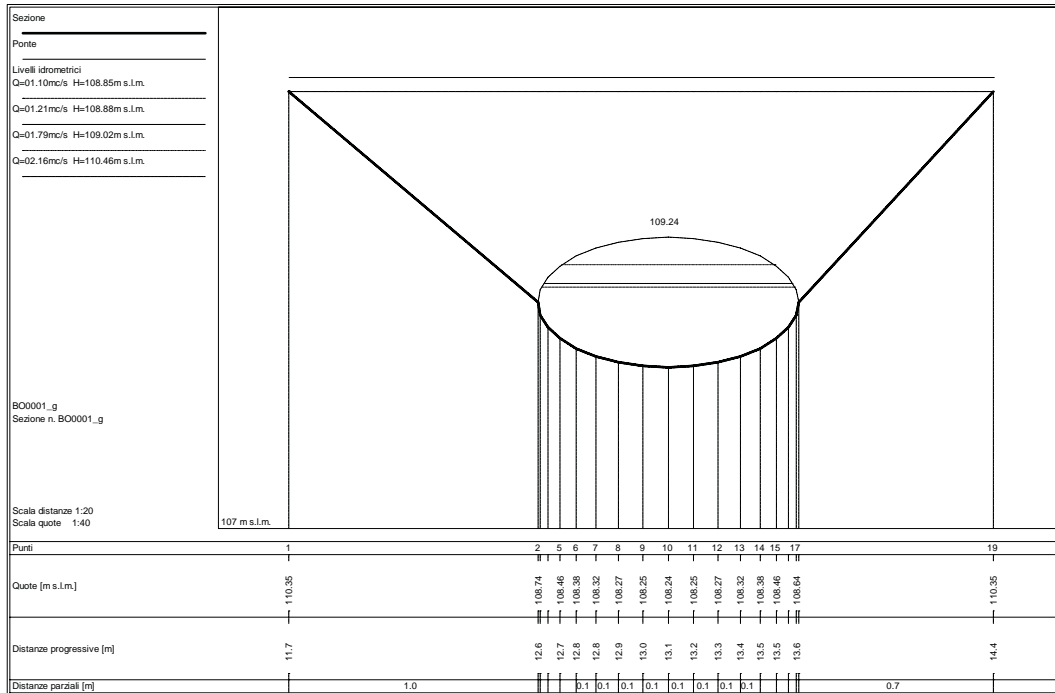

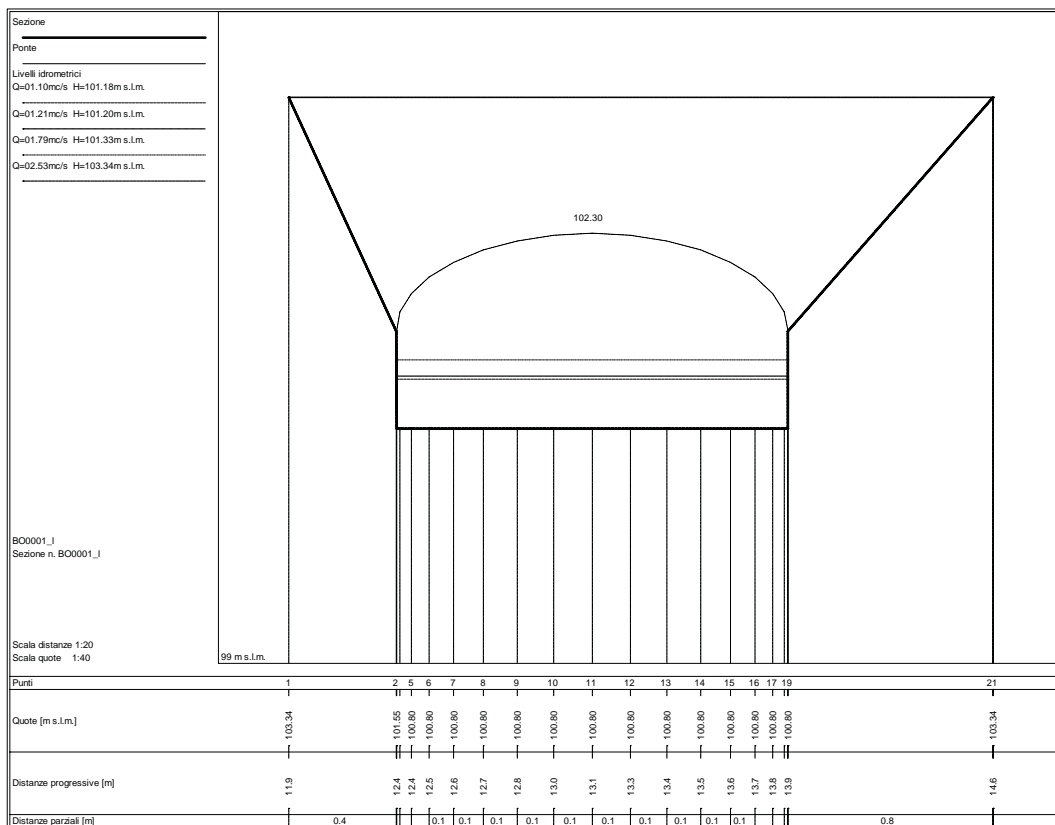
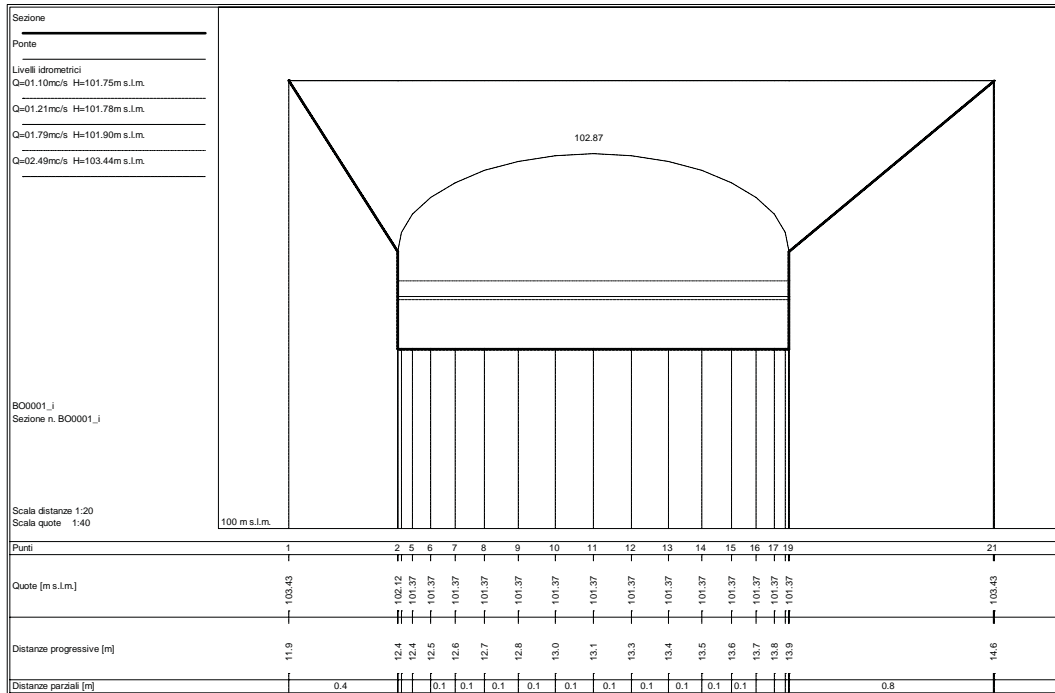

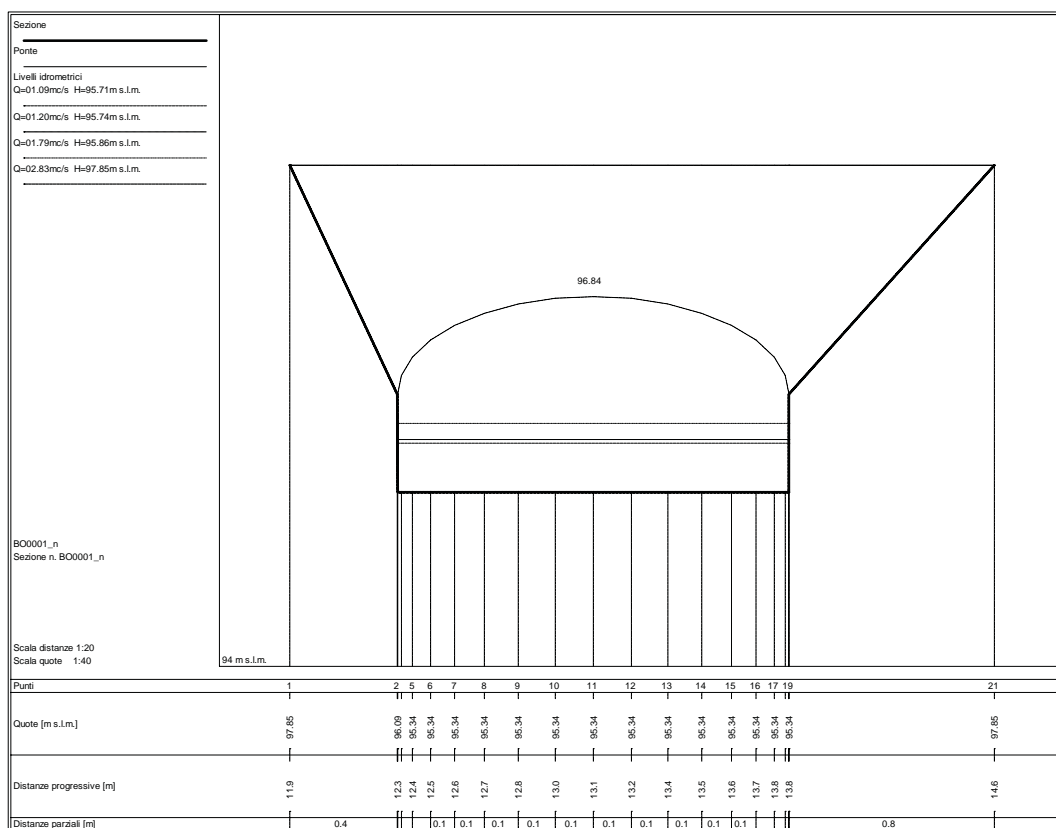
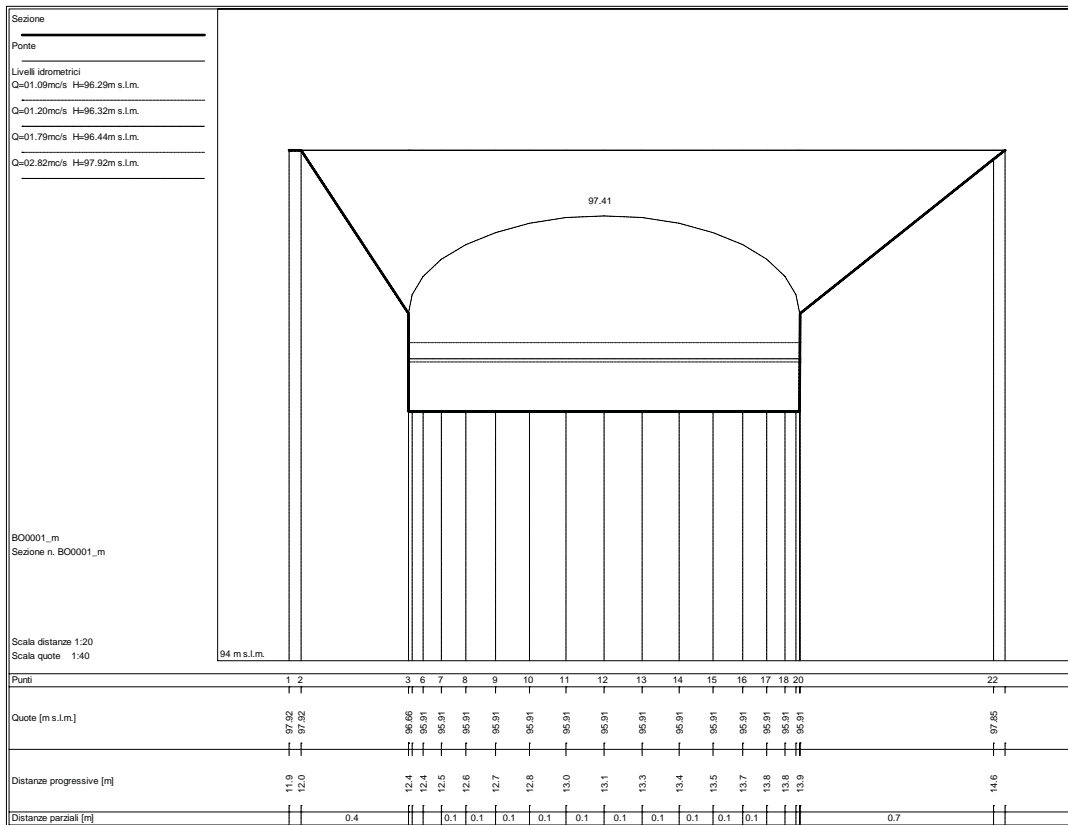

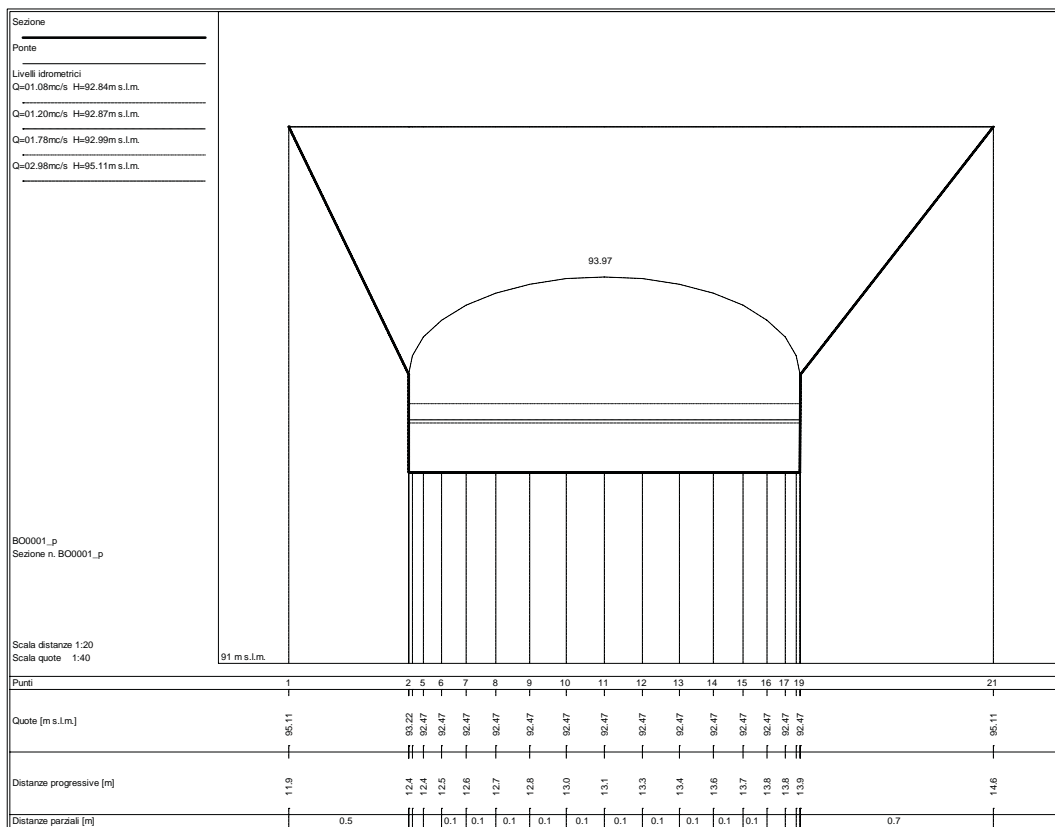
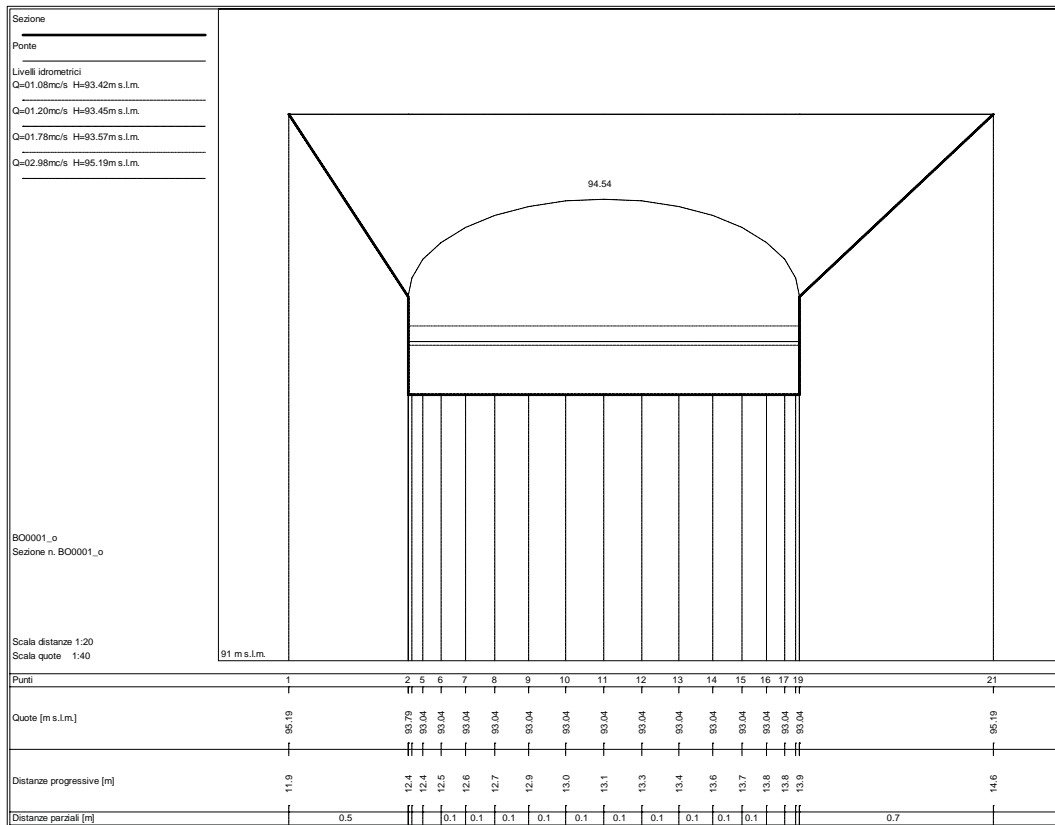

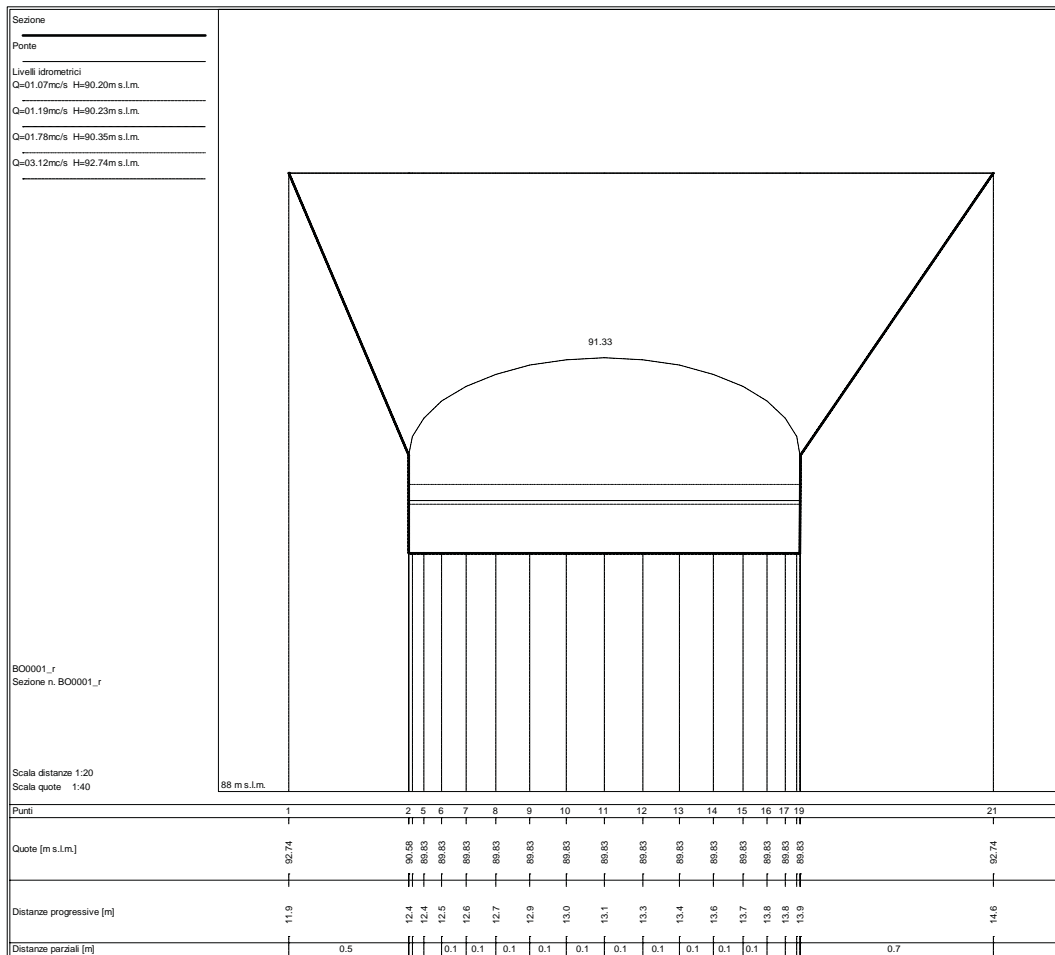
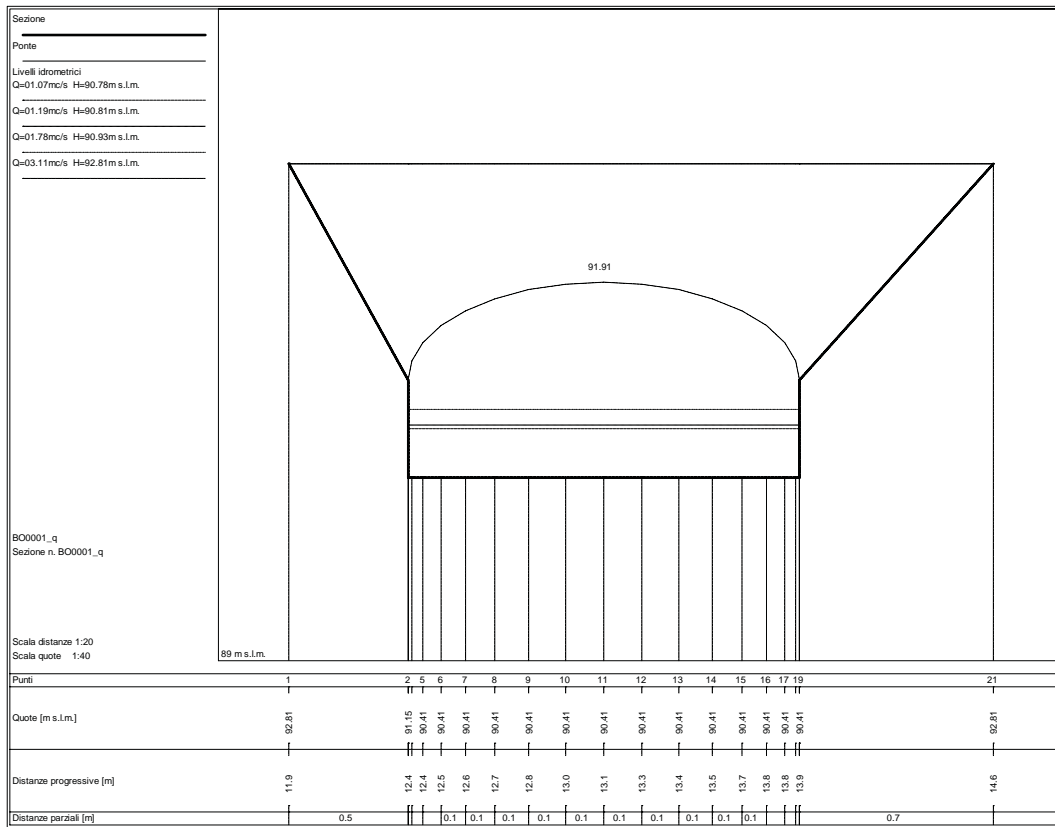

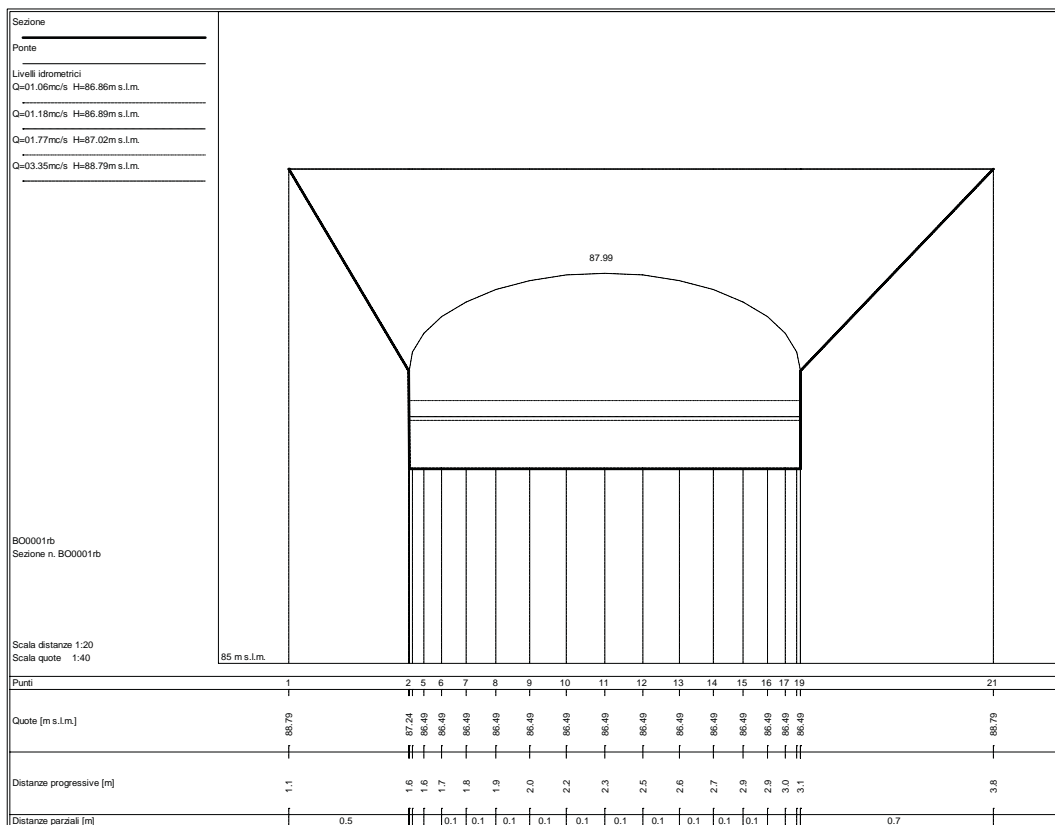
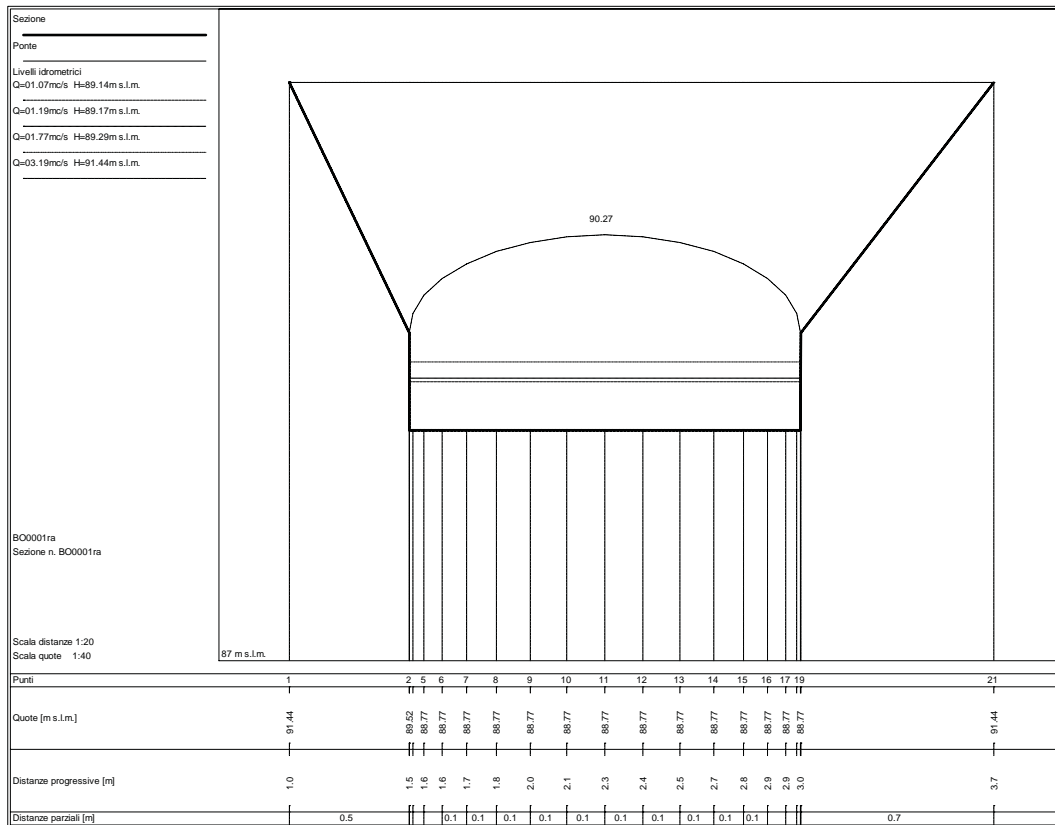

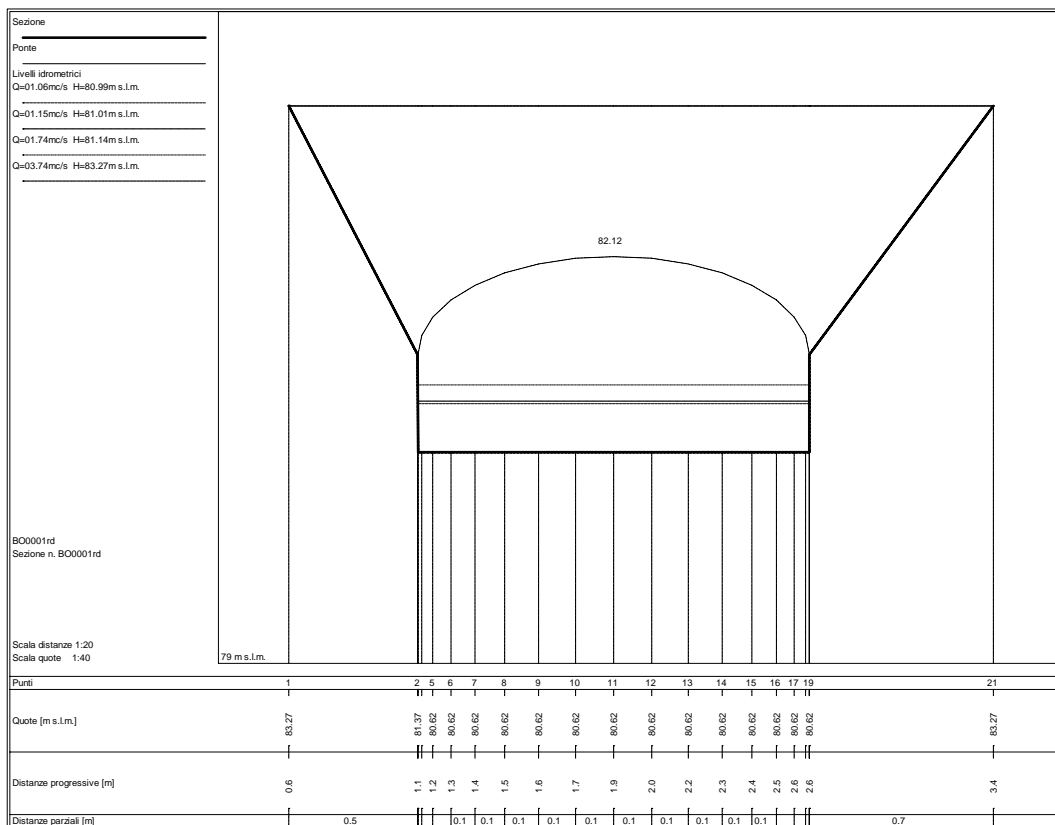
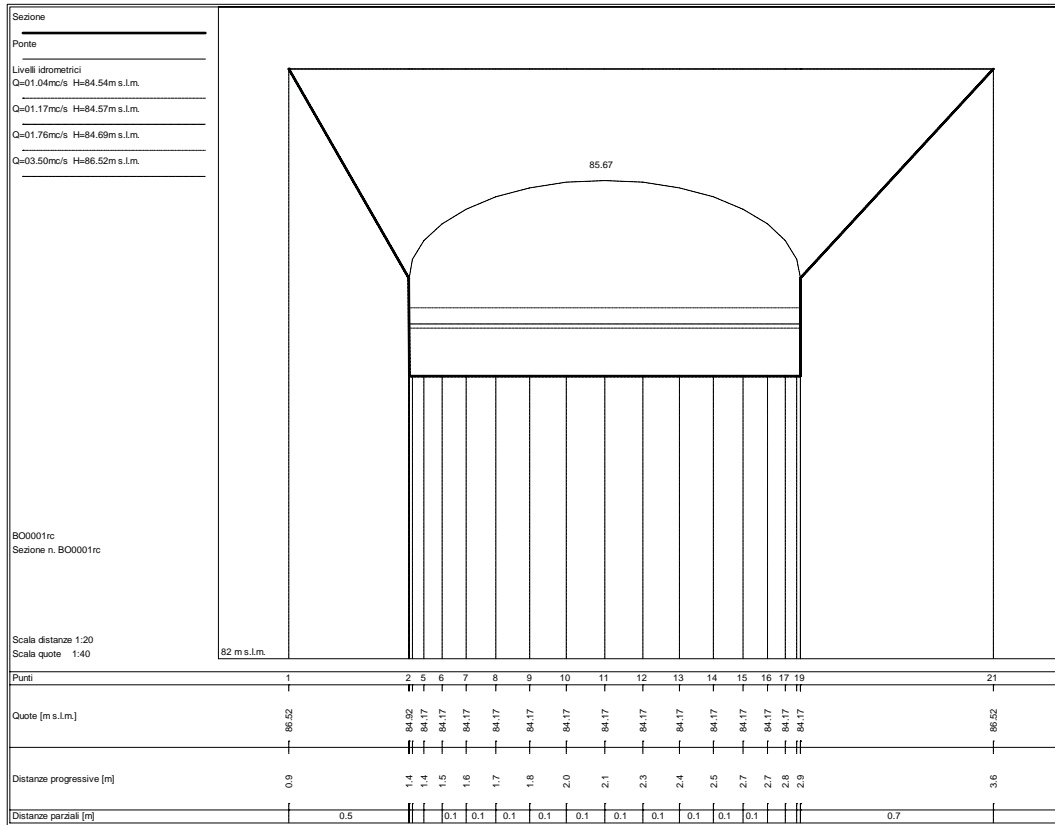

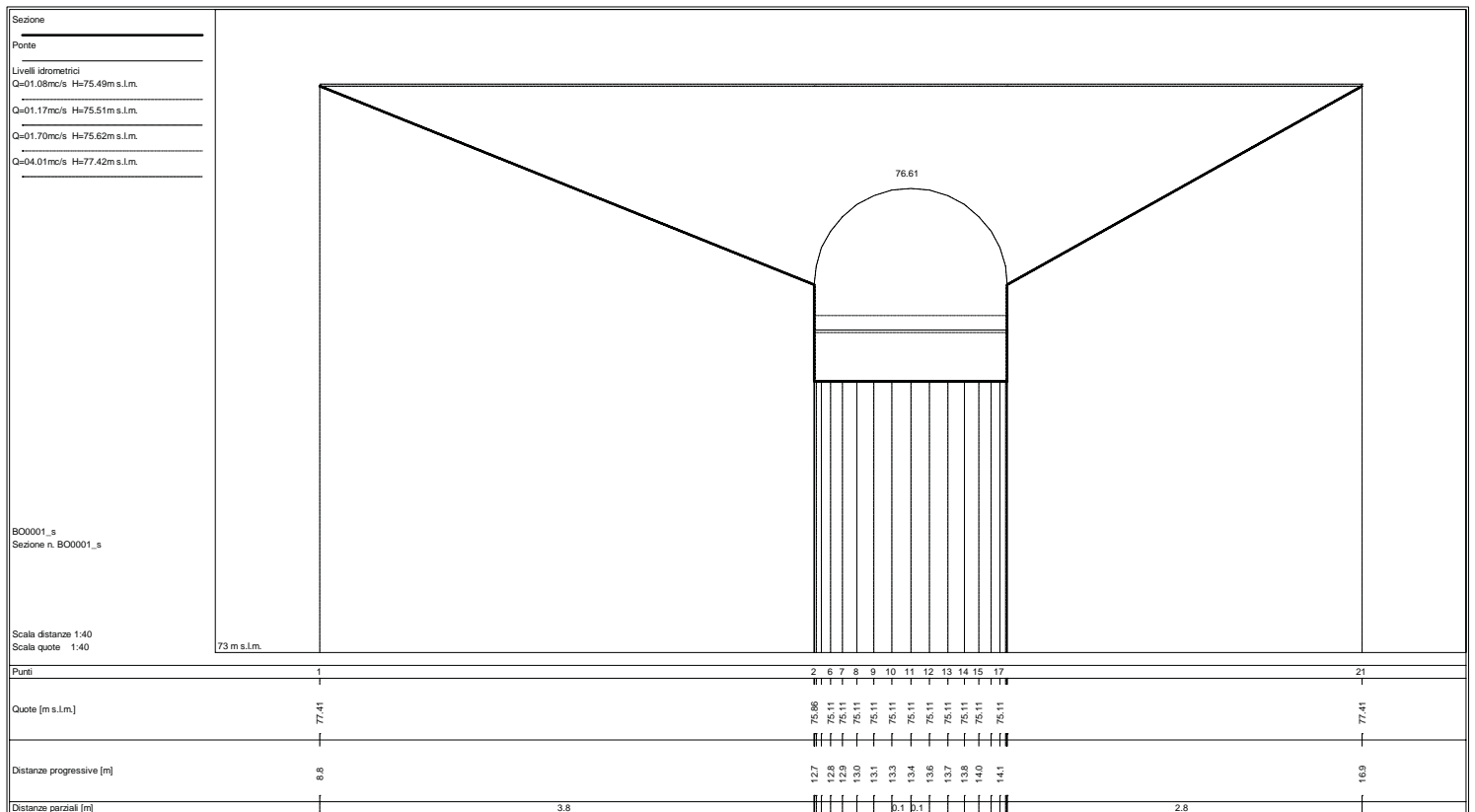
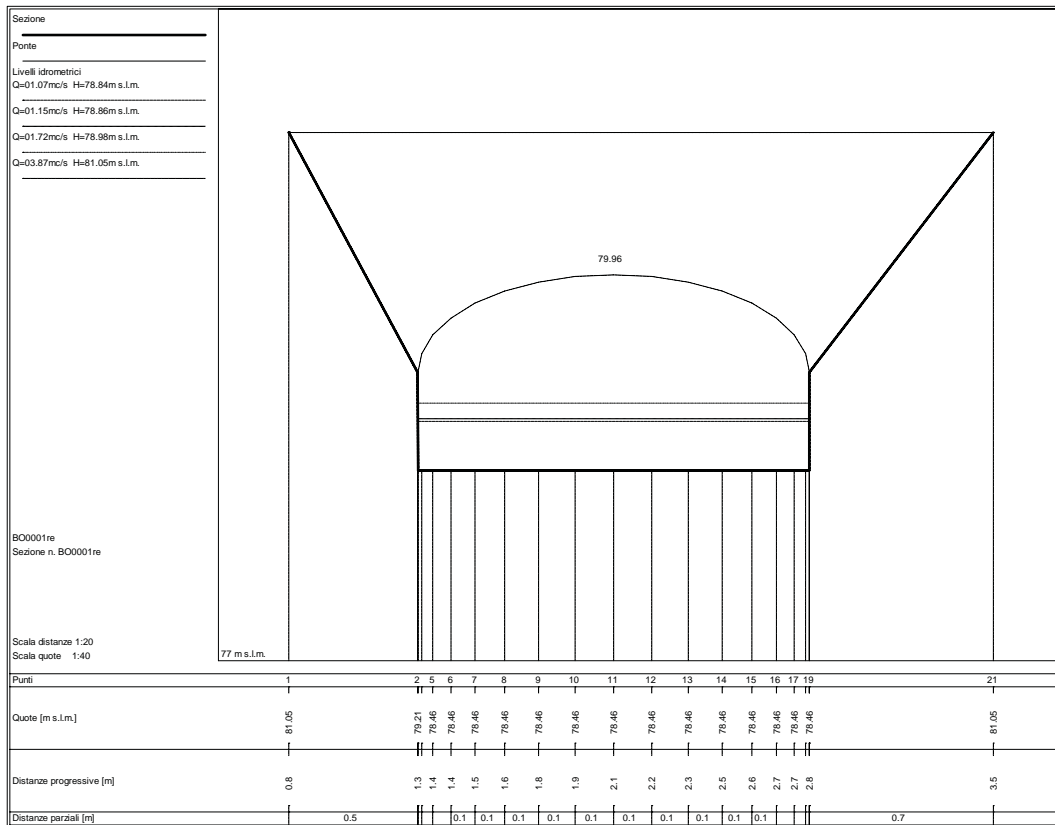

Sezione
 Ponte
 Livelli idrometrici
 Q=01.08mc/s H=75.41m s.Lm.
 Q=01.17mc/s H=75.43m s.Lm.
 Q=01.70mc/s H=75.53m s.Lm.
 Q=04.01mc/s H=77.41m s.Lm.

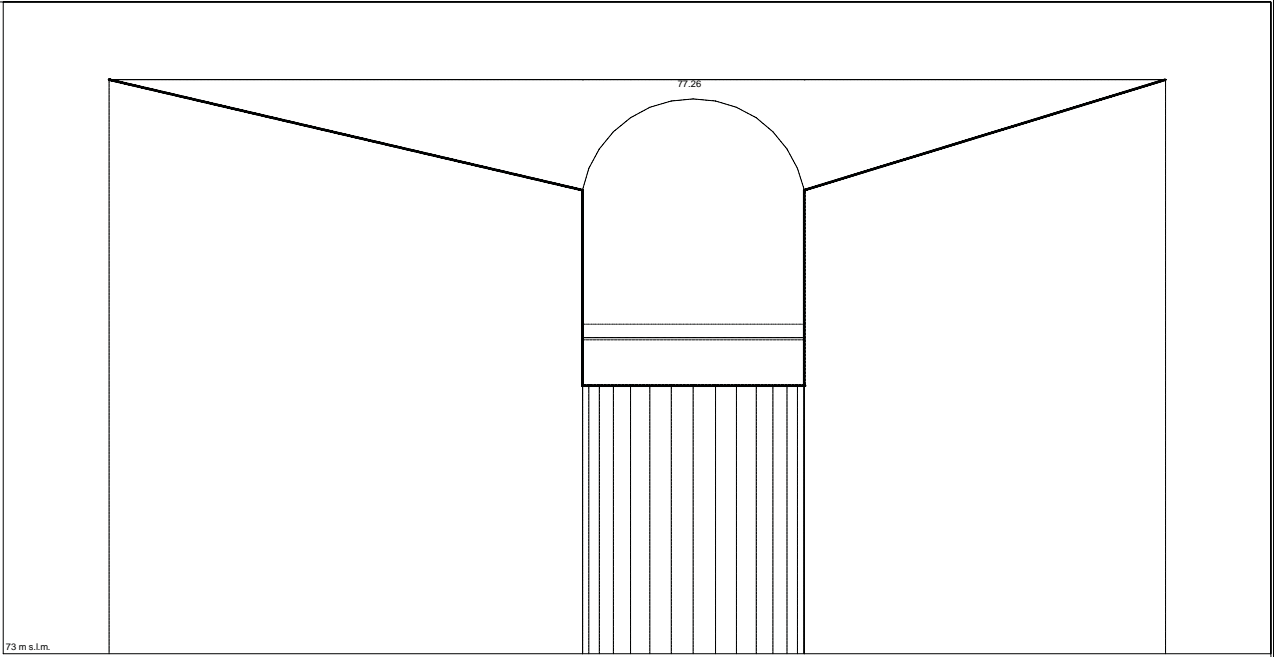

BO0001_t
 Sezione n. BO0001_t
 Scala distanza 1:40
 Scala quote 1:40

Punti	1	2	6	7	8	9	10	11	12	13	14	15	16	18	21
Quote [m s.Lm]	77.41	76.56	75.06	75.06	75.06	75.06	75.06	75.06	75.06	75.06	75.06	75.06	75.06	75.06	77.41
Distanze progressive [m]	9.0	12.6	12.7	12.8	13.0	13.1	13.3	13.4	13.6	13.8	13.9	14.0	14.2	14.3	17.1
Distanze parziali [m]		3.6			0.1	0.2	0.2	0.2	0.2						2.8

Sezione
 Ponte
 Livelli idrometrici
 Q=03.16mc/s H=74.41m s.Lm.
 Q=03.45mc/s H=74.45m s.Lm.
 Q=05.03mc/s H=74.67m s.Lm.
 Q=07.67mc/s H=76.92m s.Lm.

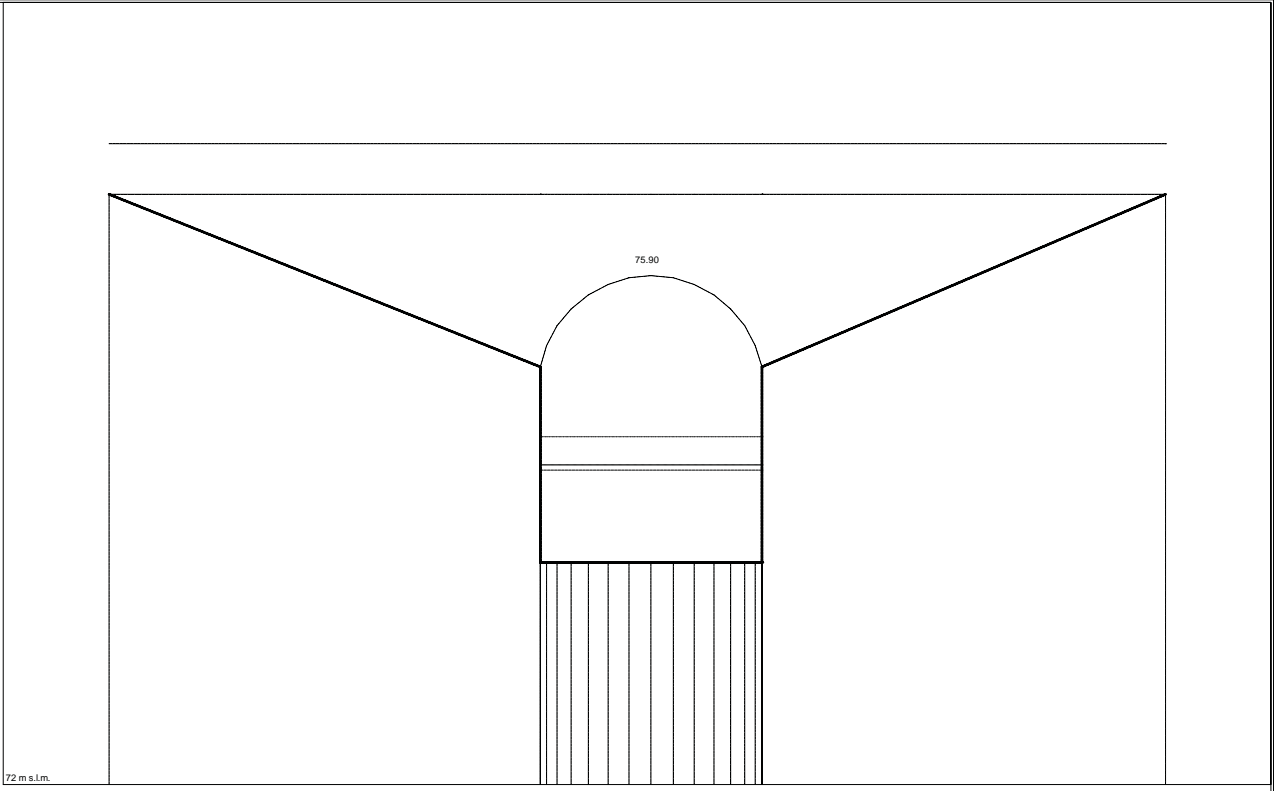

BO0001_u
 Sezione n. BO0001_u
 Scala distanza 1:40
 Scala quote 1:40

Punti	1	2	6	7	8	9	10	11	12	13	14	15	16	18	22
Quote [m s.Lm]	76.53	75.20	73.70	73.70	73.70	73.70	73.70	73.70	73.70	73.70	73.70	73.70	73.70	73.70	76.53
Distanze progressive [m]	8.9	12.3	12.4	12.5	12.6	12.8	12.9	13.1	13.3	13.4	13.6	13.7	13.8	14.0	17.0
Distanze parziali [m]		3.3				0.1	0.2	0.2	0.2	0.1					3.1

Sezione
 Ponte
 Livelli idrometrici
 Q=03.16mc/s H=74.37m s.l.m.
 Q=03.45mc/s H=74.41m s.l.m.
 Q=05.03mc/s H=74.62m s.l.m.
 Q=07.67mc/s H=76.69m s.l.m.

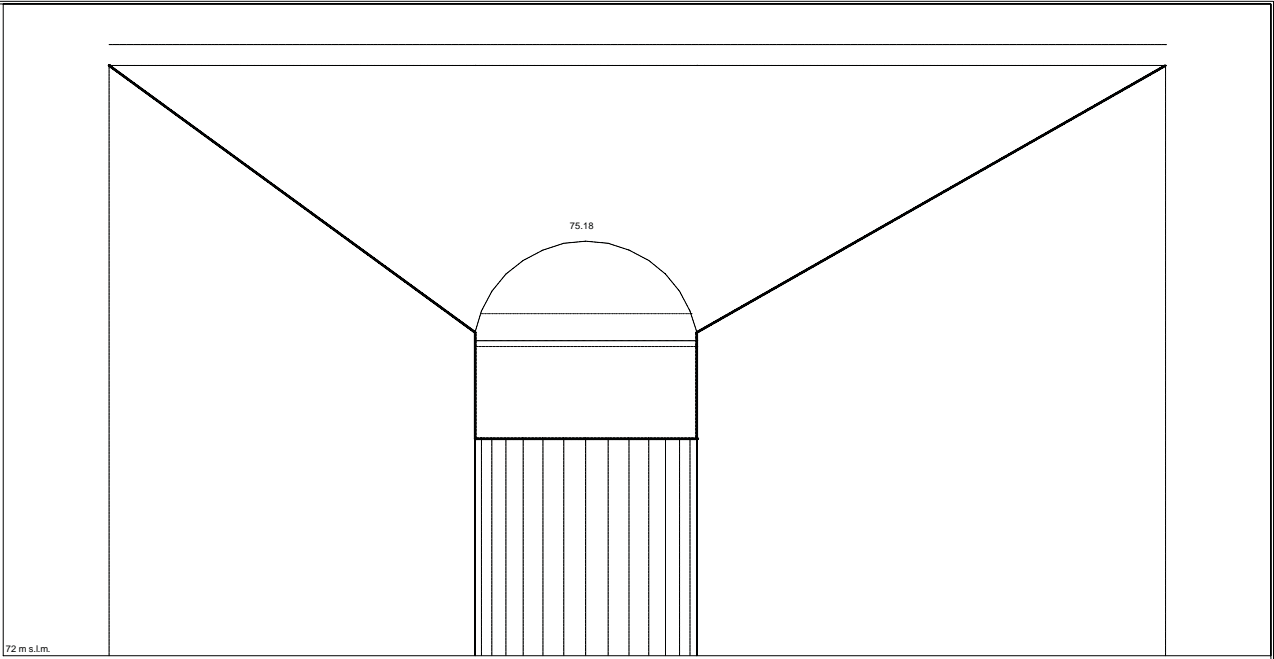

BO0001_v
 Sezione n. BO0001_v

Scala distanza 1:40
 Scala quote 1:40

Punti	1	2	6	7	8	9	10	11	12	13	14	15	16	18	22
Quote [m s.l.m.]	76.53	74.48	73.67	73.67	73.67	73.67	73.67	73.67	73.67	73.67	73.67	73.67	73.67	73.67	76.53
Distanze progressive [m]	9.4	12.3	12.4	12.5	12.6	12.8	12.9	13.1	13.3	13.4	13.6	13.7	13.8	14.0	17.5
Distanze parziali [m]		2.8			0.1	0.2	0.2	0.2	0.2	0.1					3.6

Sezione
 Ponte
 Livelli idrometrici
 Q=03.17mc/s H=73.35m s.l.m.
 Q=03.45mc/s H=73.39m s.l.m.
 Q=05.04mc/s H=73.59m s.l.m.
 Q=07.65mc/s H=75.78m s.l.m.

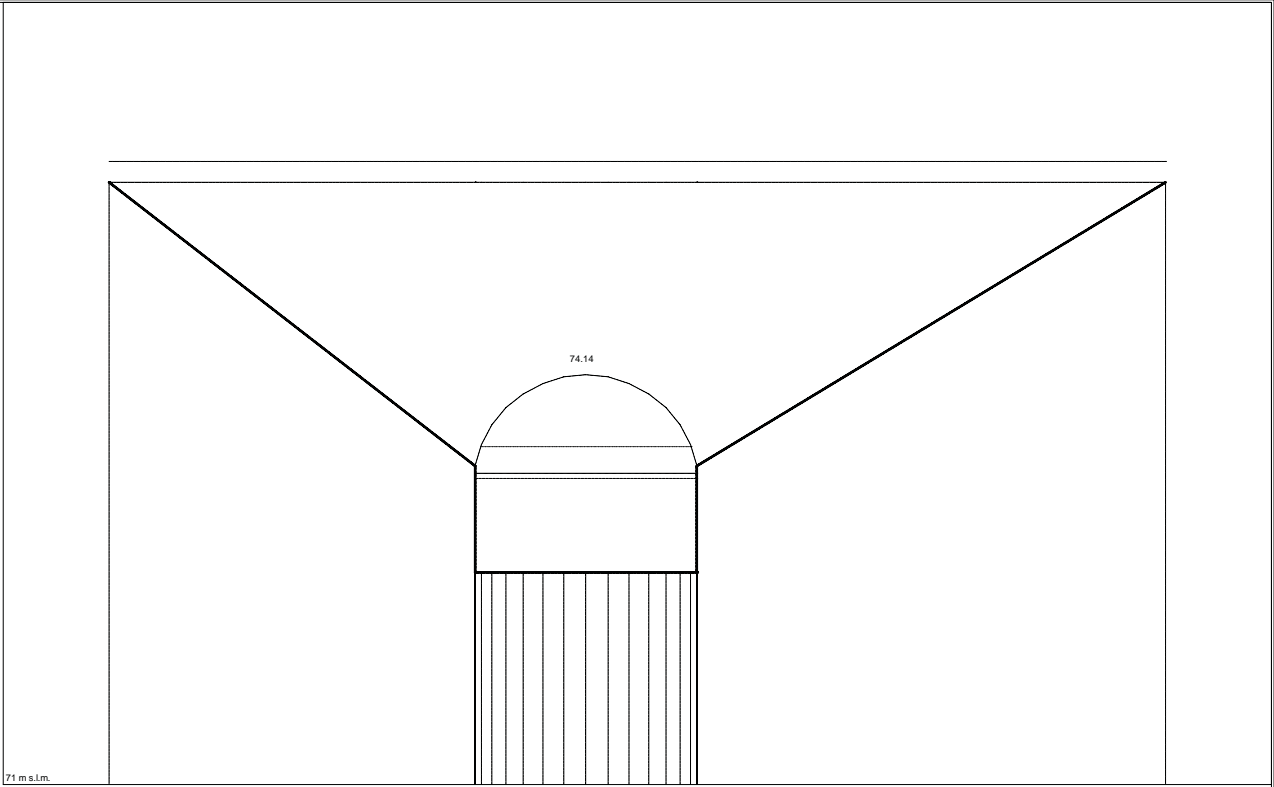

BO0001va
 Sezione n. BO0001va

Scala distanza 1:40
 Scala quote 1:40

Punti	1	2	7	8	9	10	11	12	13	14	15	16	17	19	23
Quote [m s.l.m.]	75.62	73.44	72.63	72.63	72.63	72.63	72.63	72.63	72.63	72.63	72.63	72.63	72.63	72.63	75.62
Distanze progressive [m]	0.2	3.1	3.2	3.3	3.4	3.6	3.7	3.9	4.1	4.2	4.4	4.5	4.6	4.8	8.4
Distanze parziali [m]		2.8			0.2	0.2	0.2	0.2	0.2	0.2					3.6

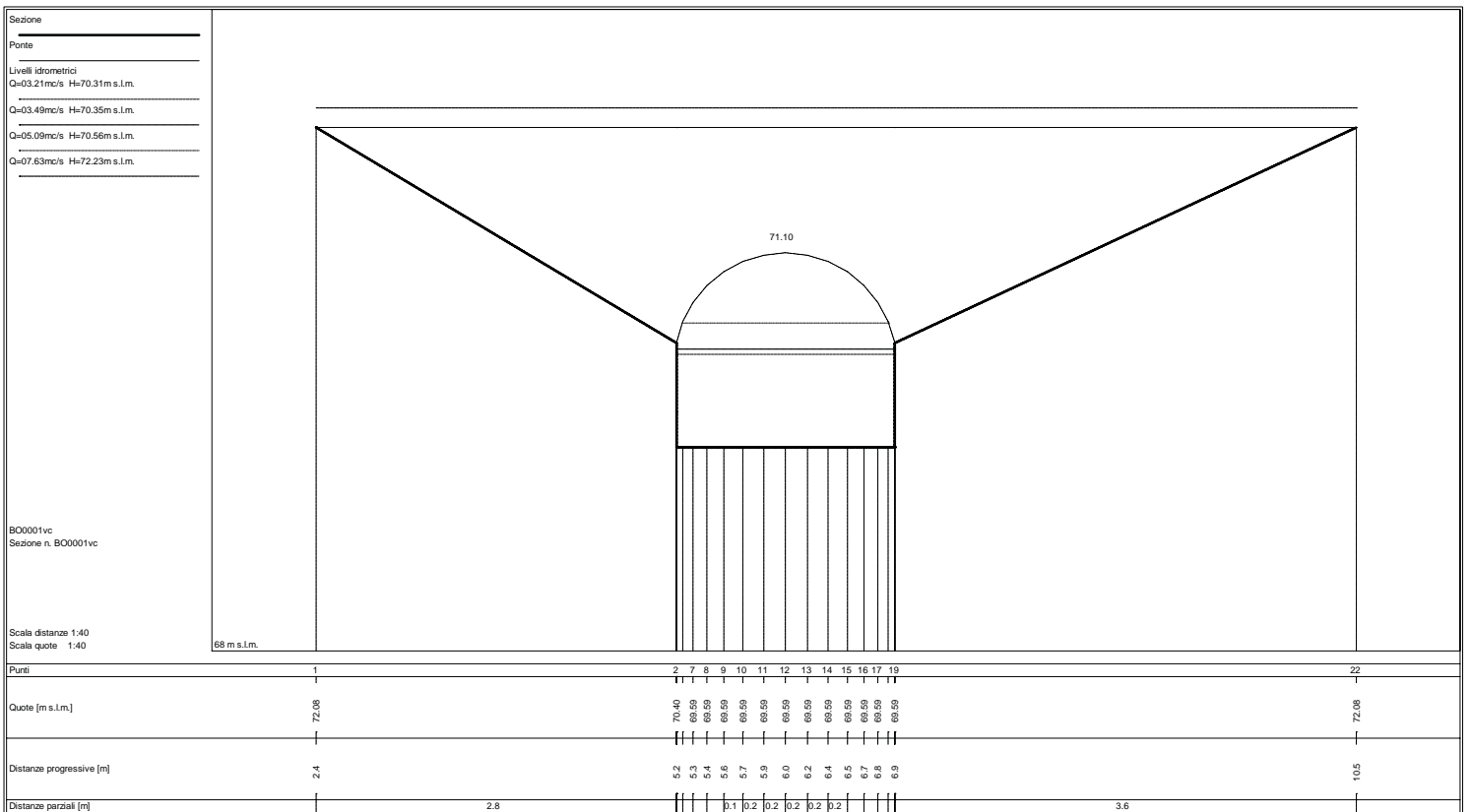
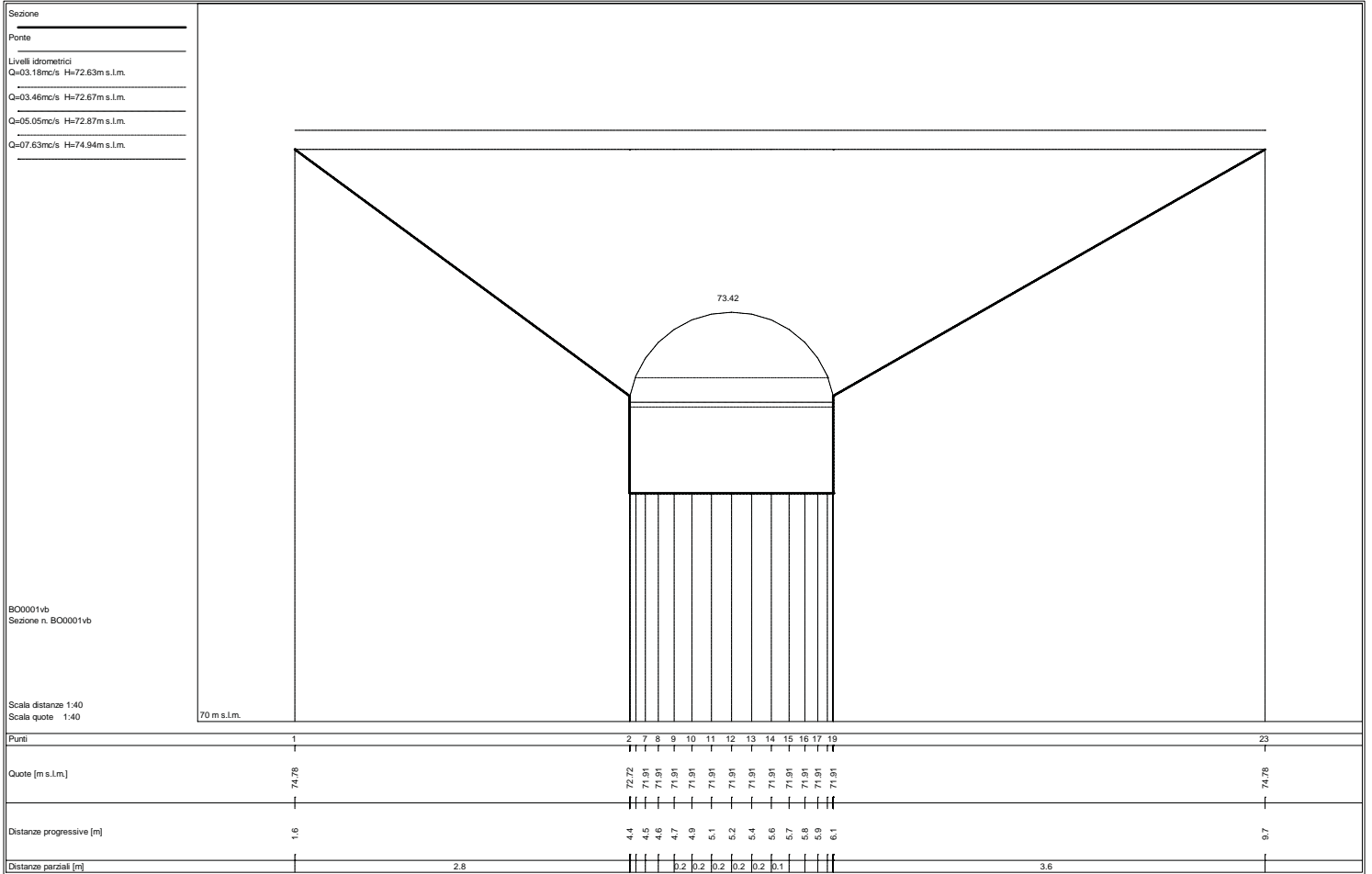

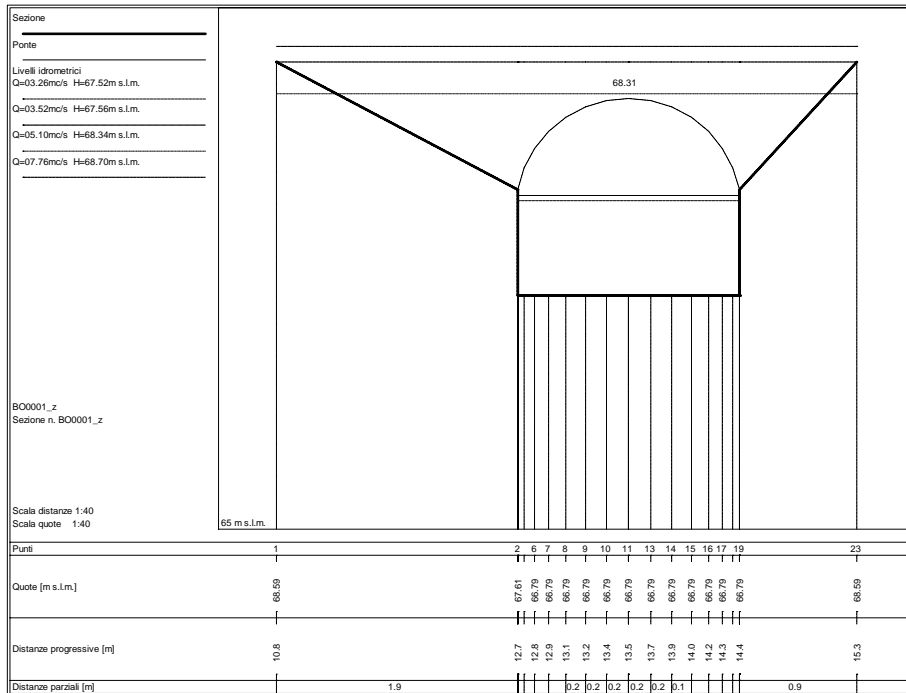
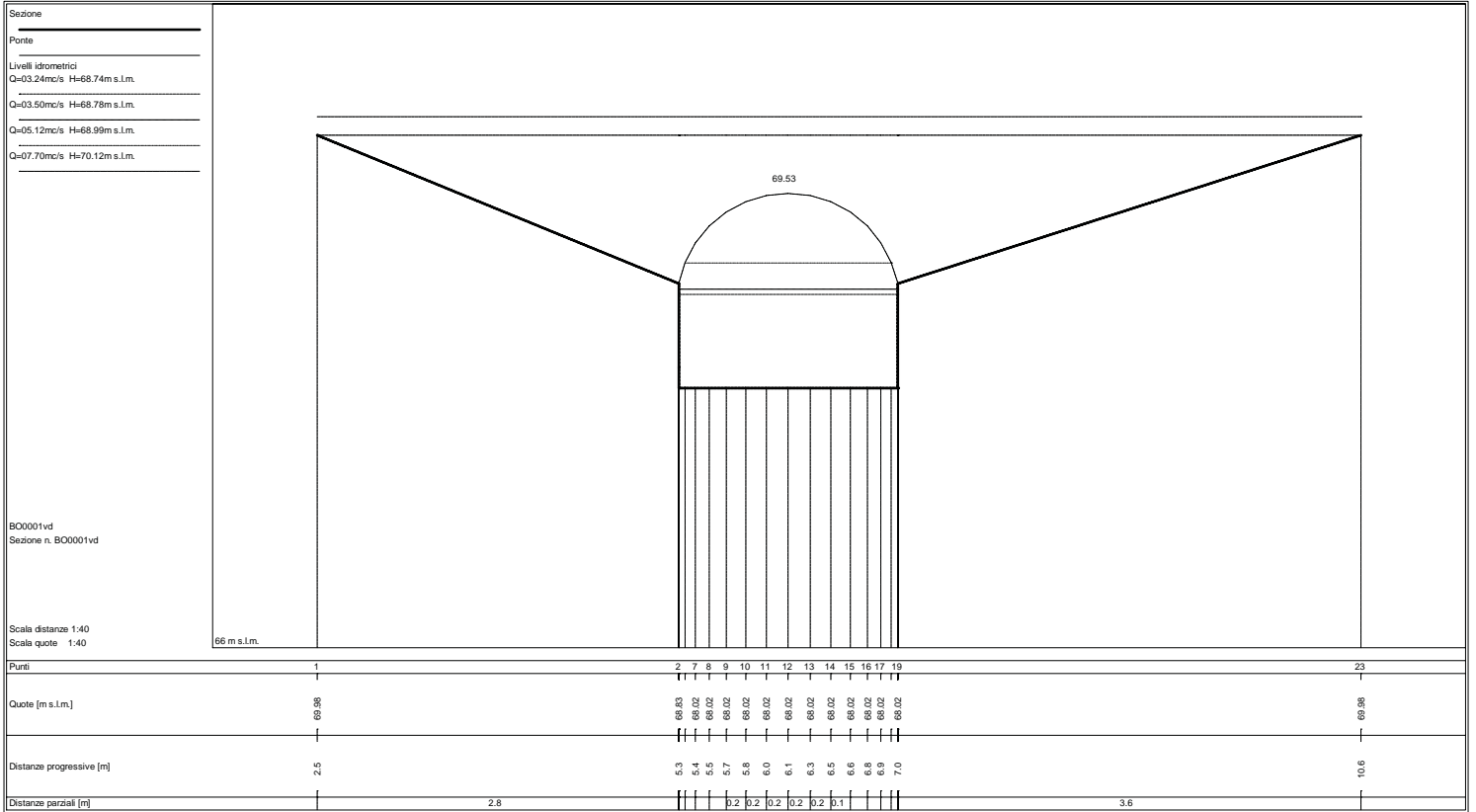

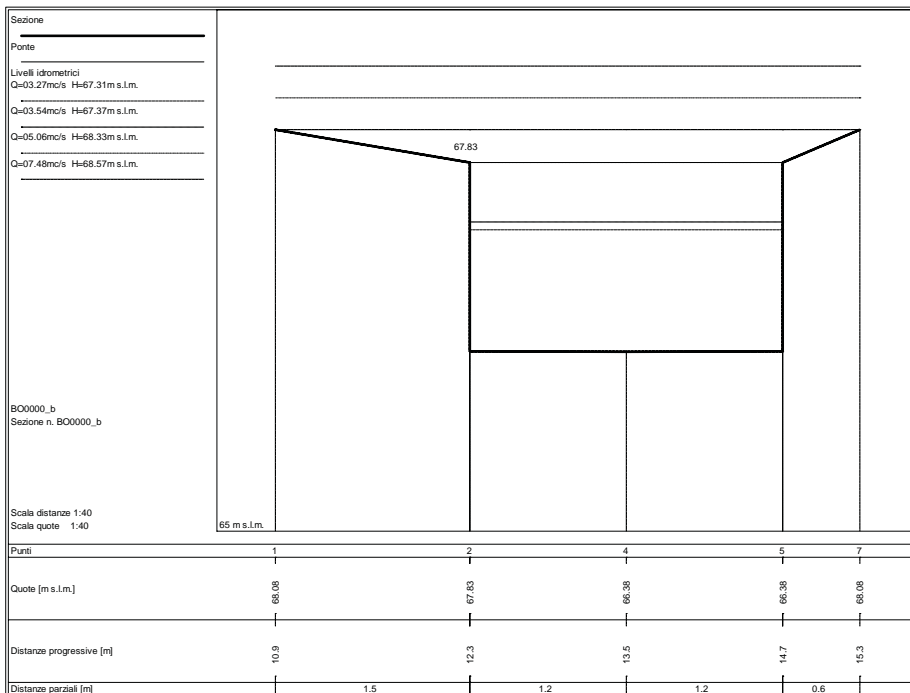
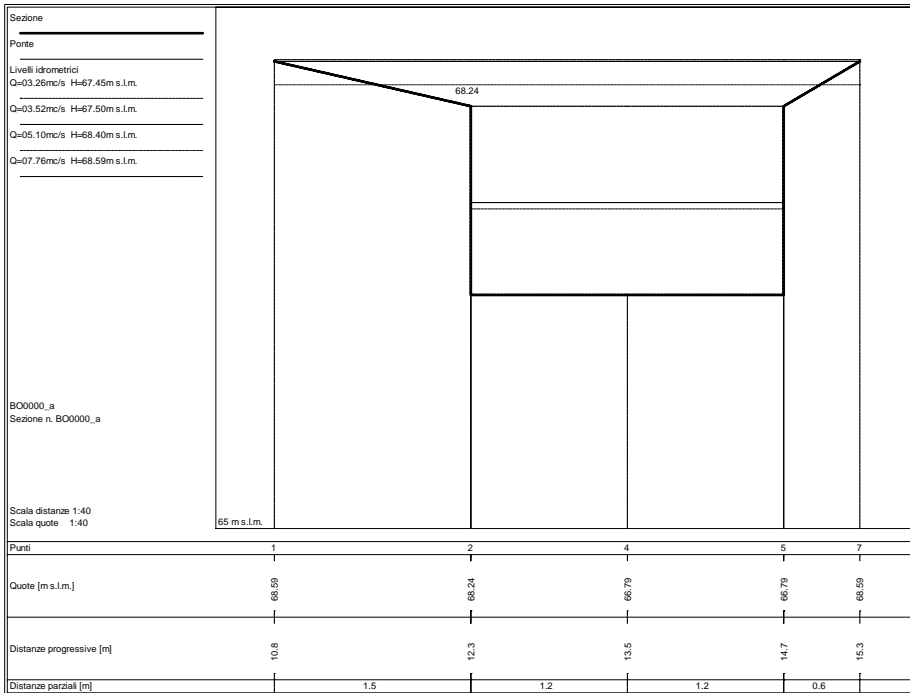

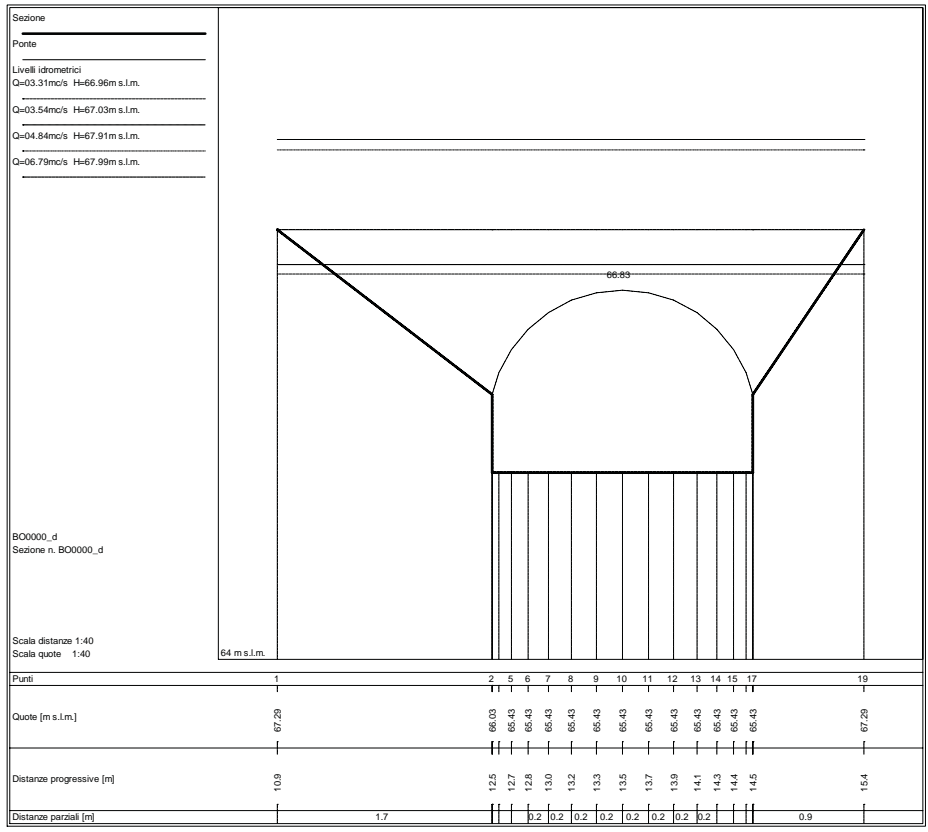
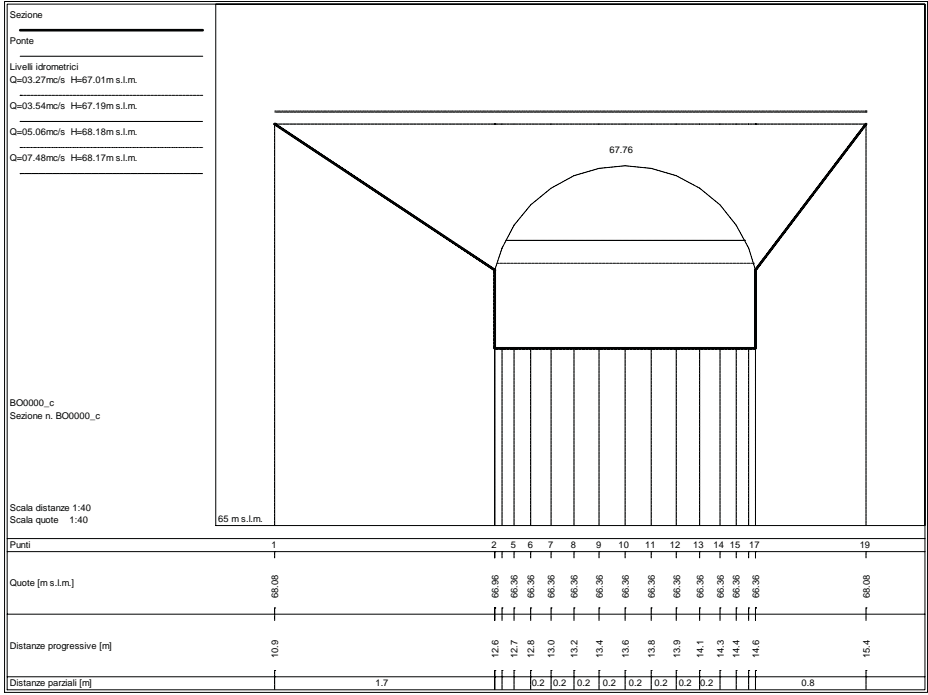

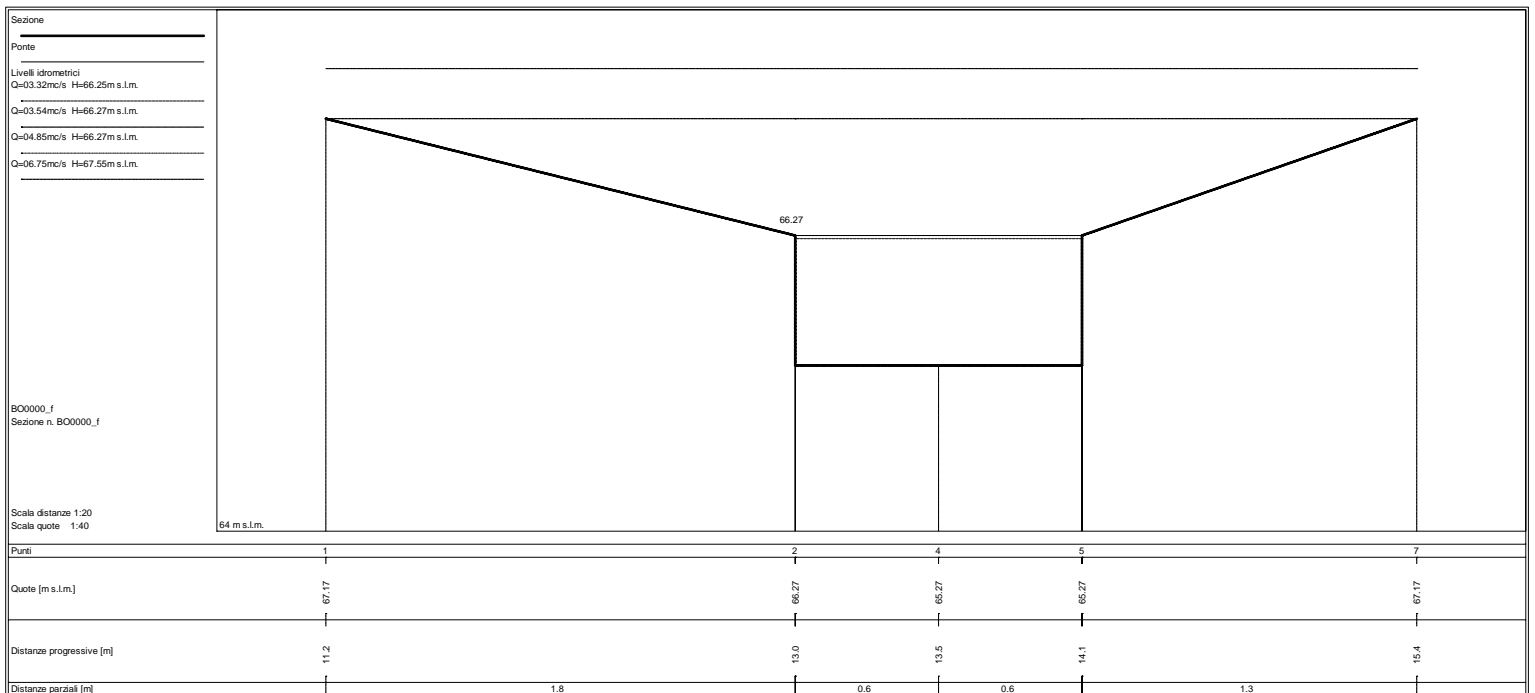
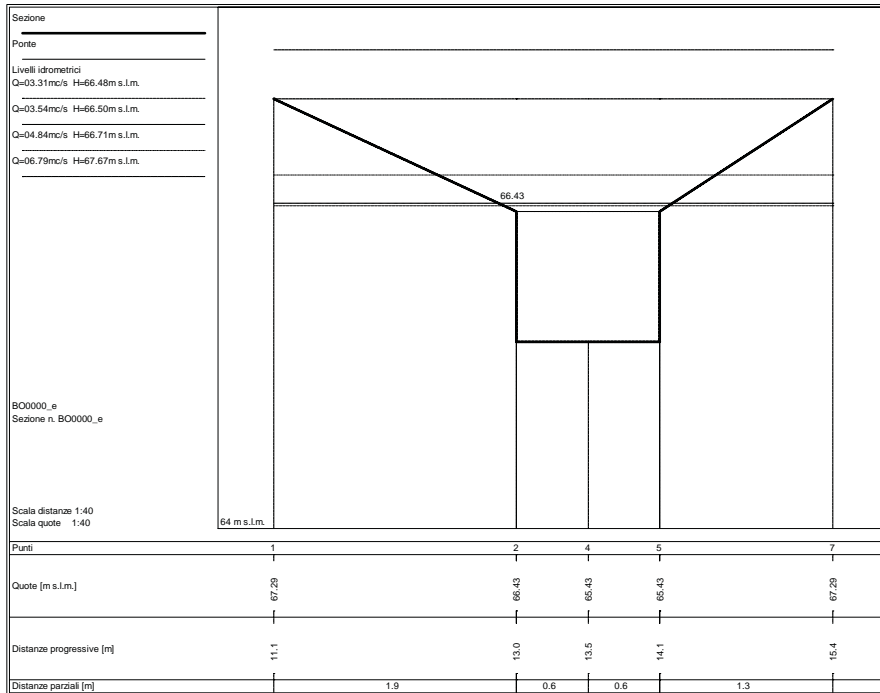

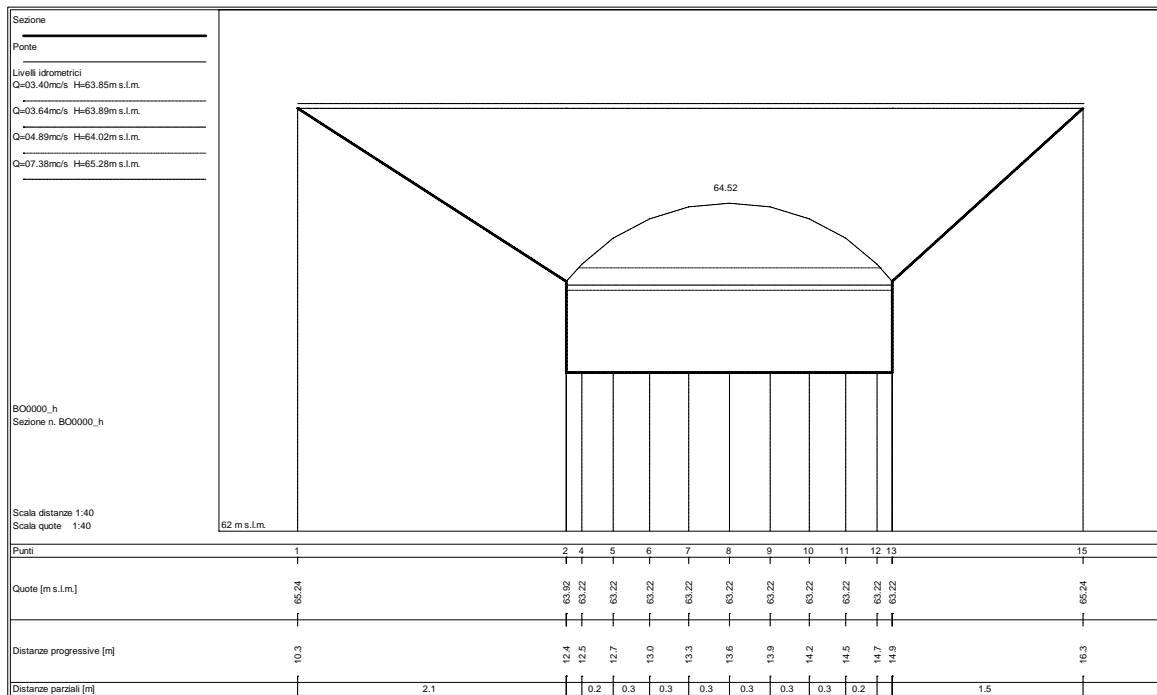
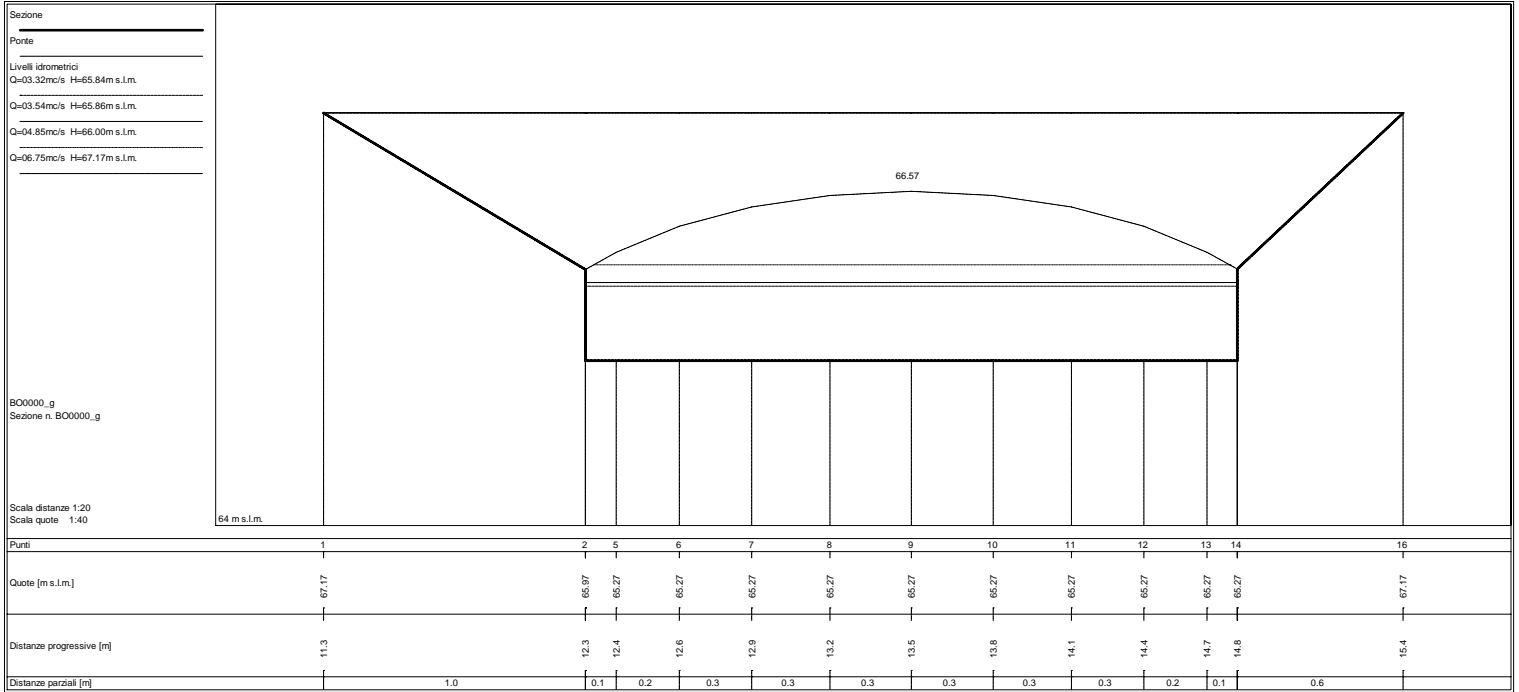

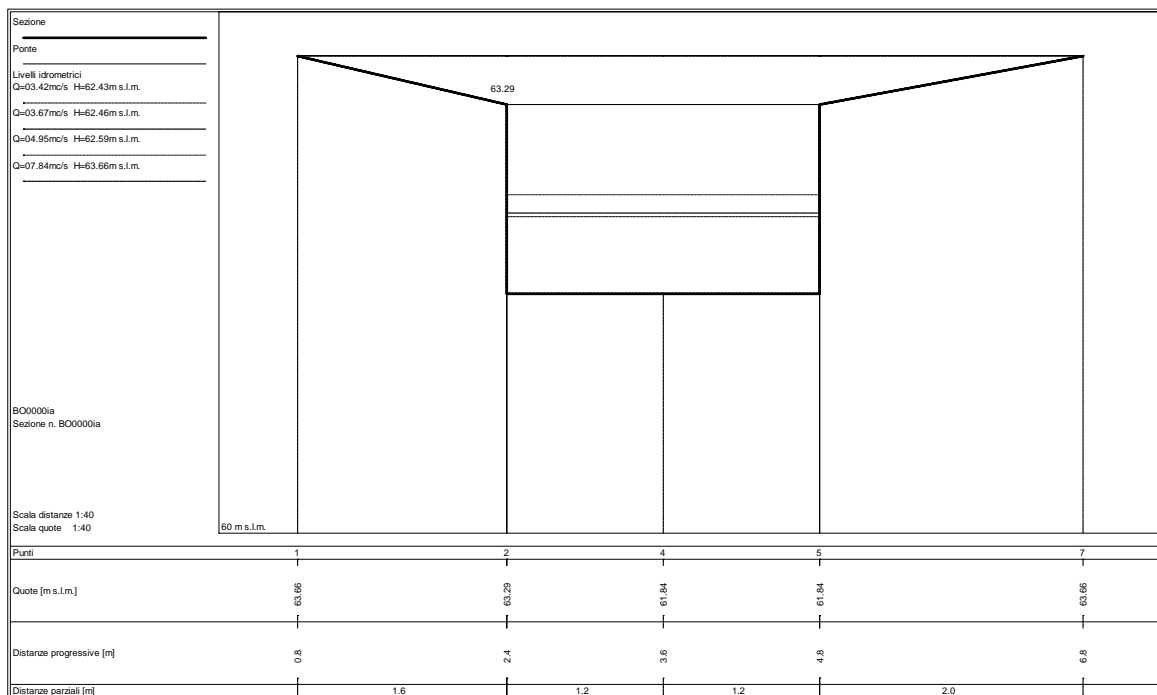
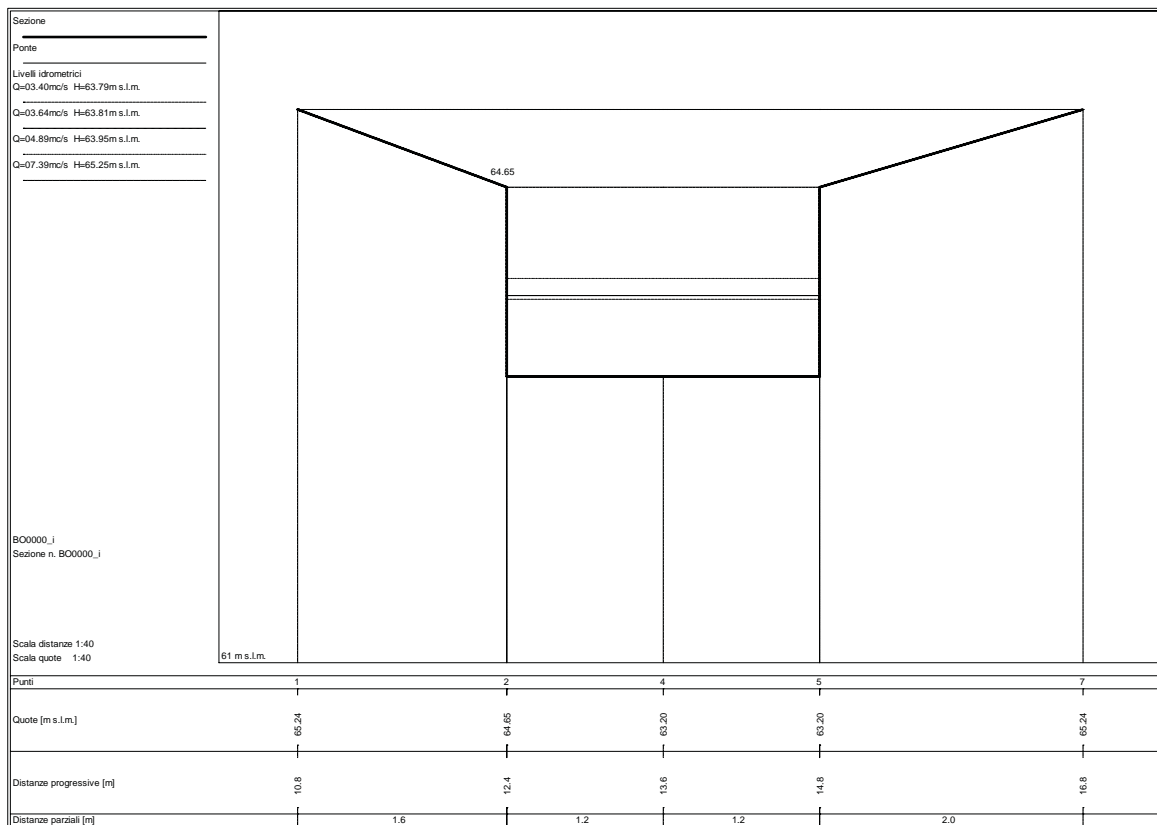

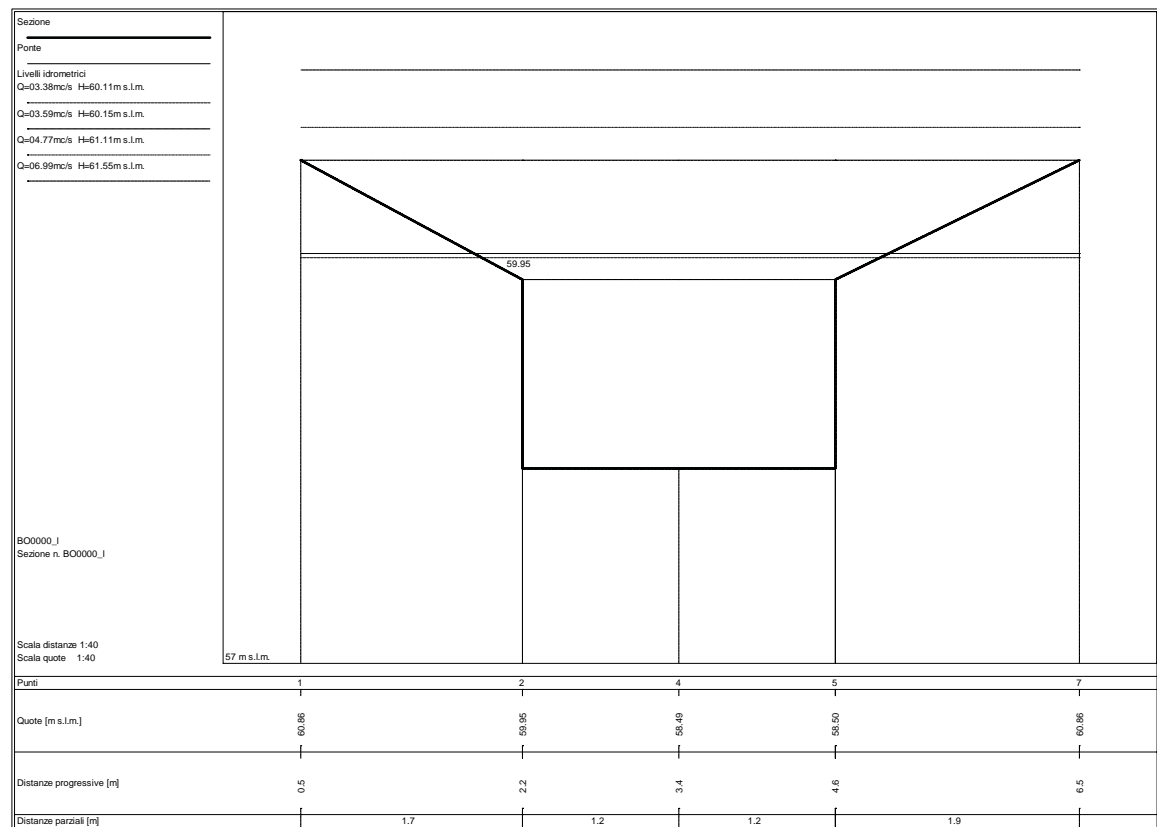
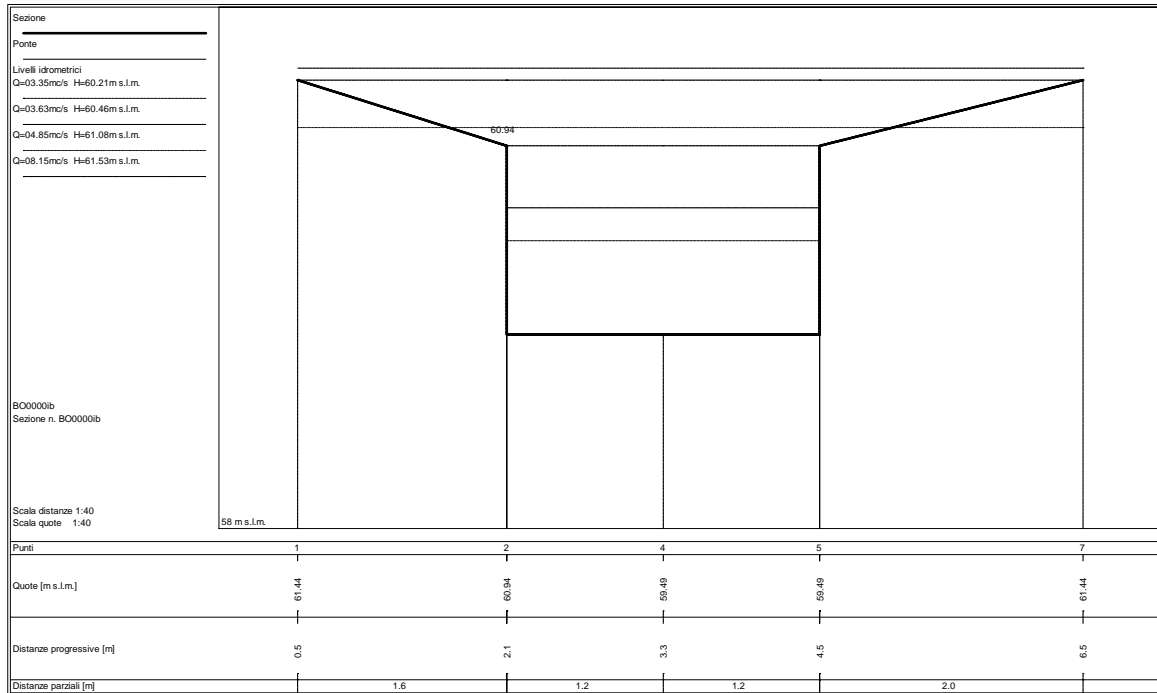

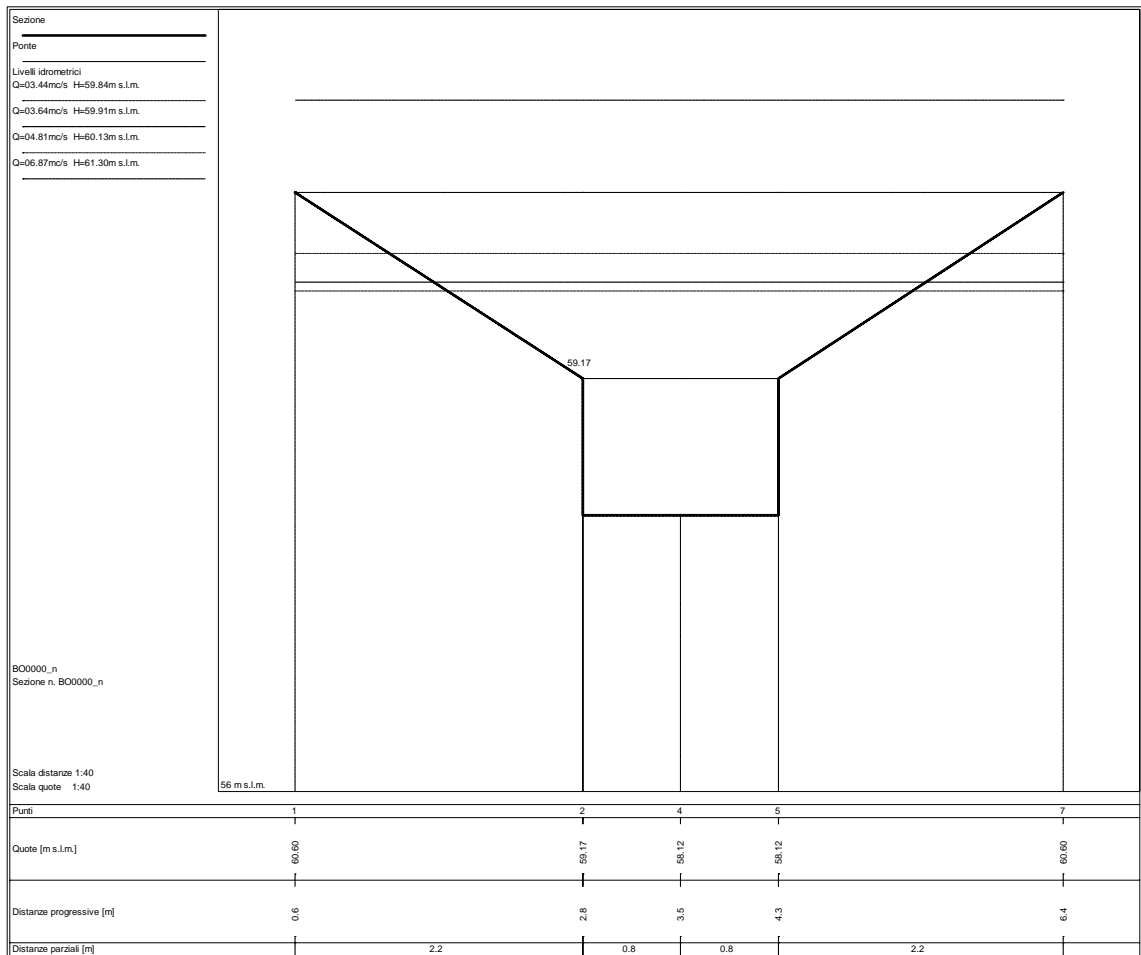
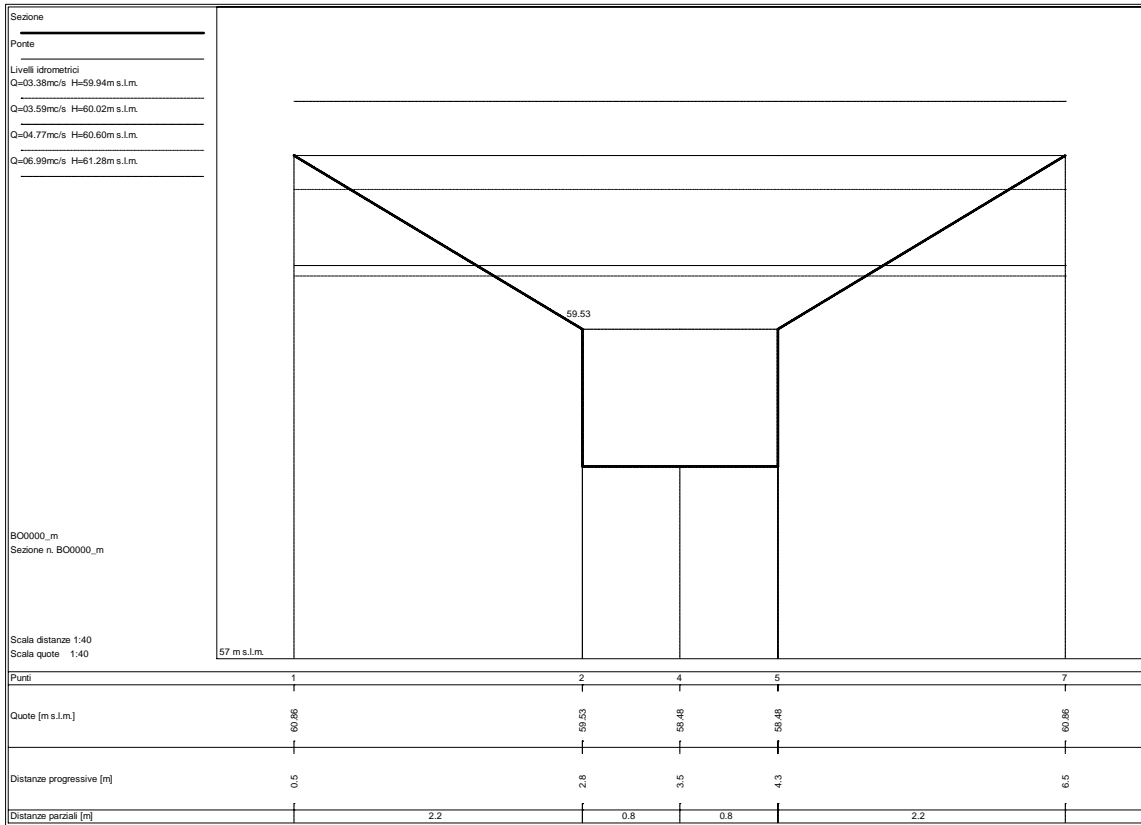

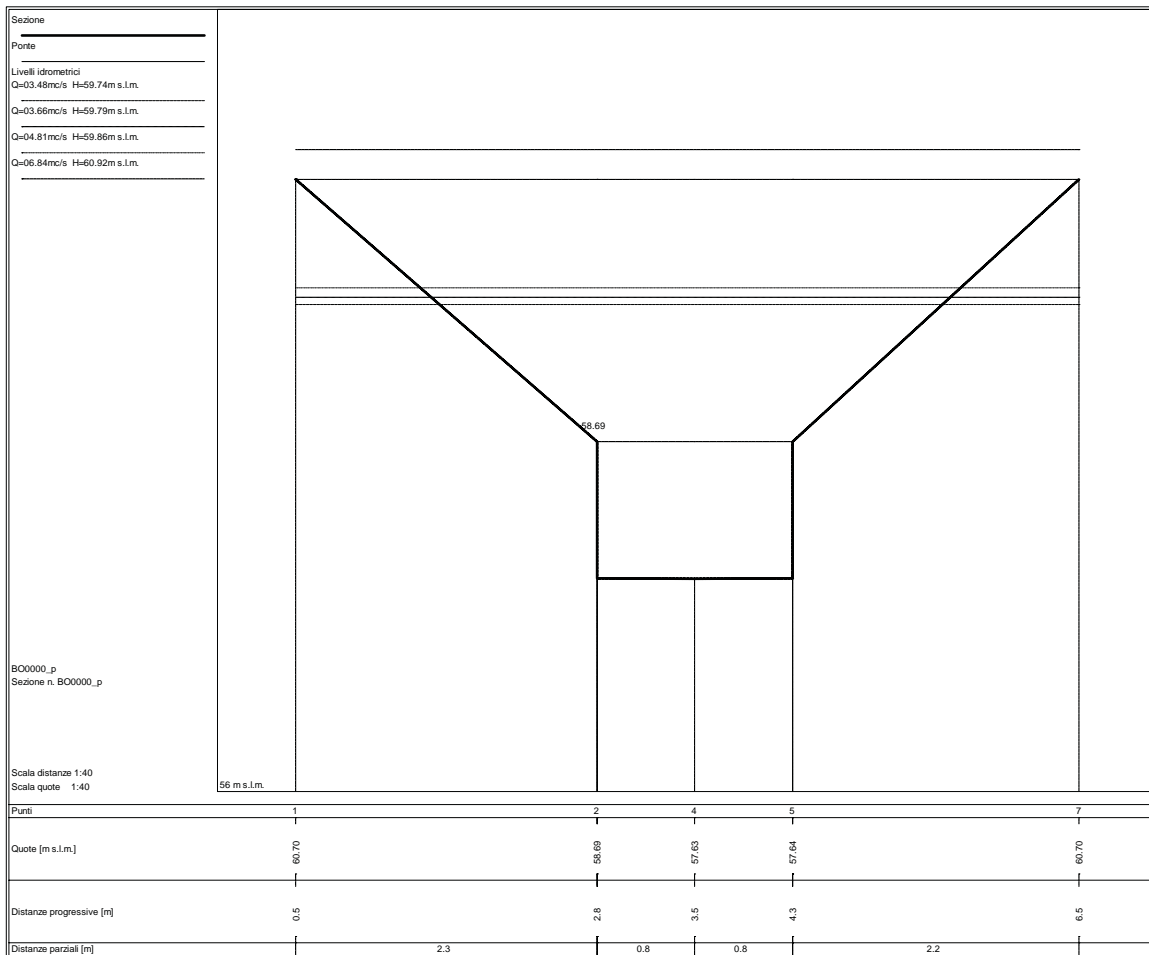
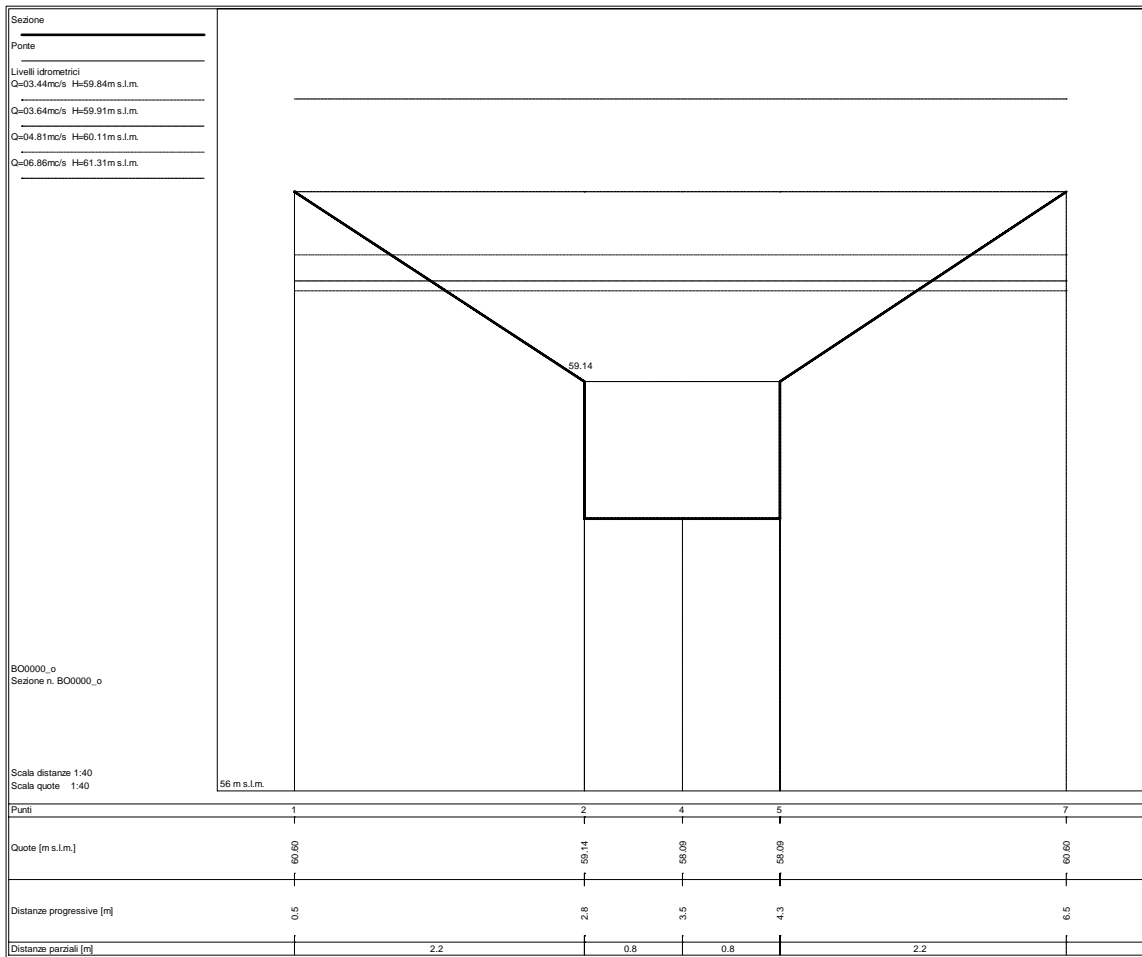

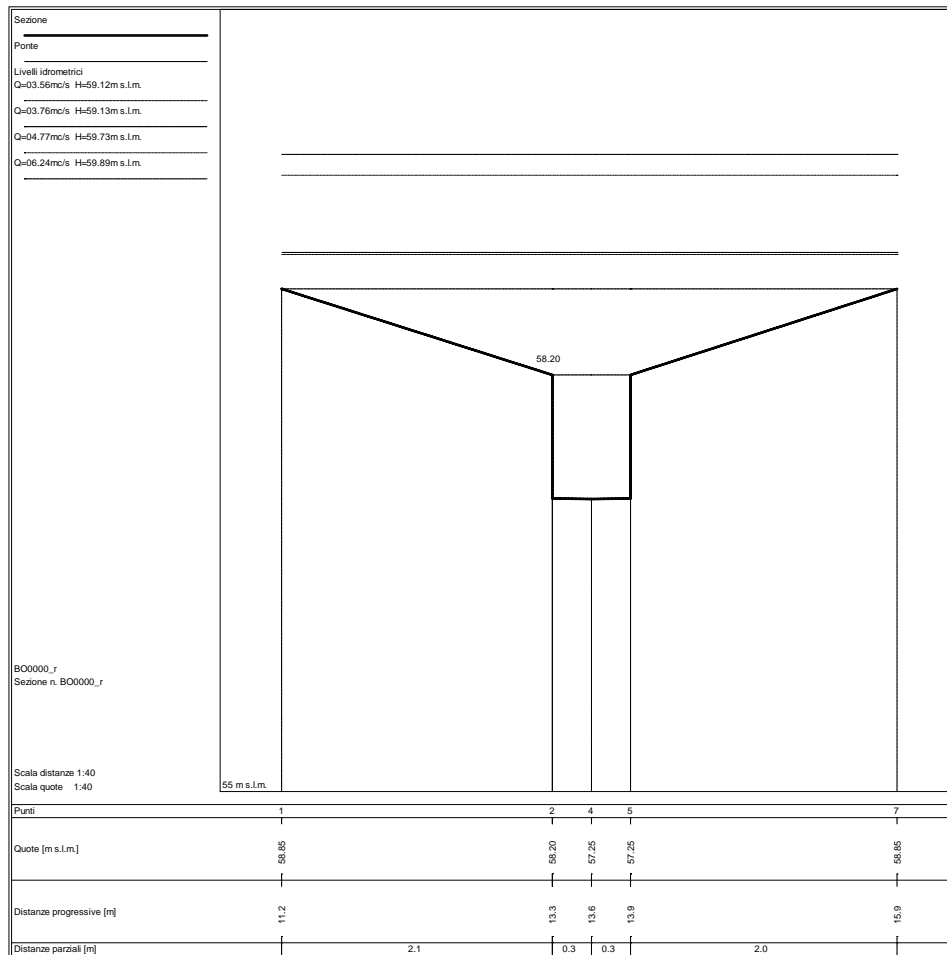
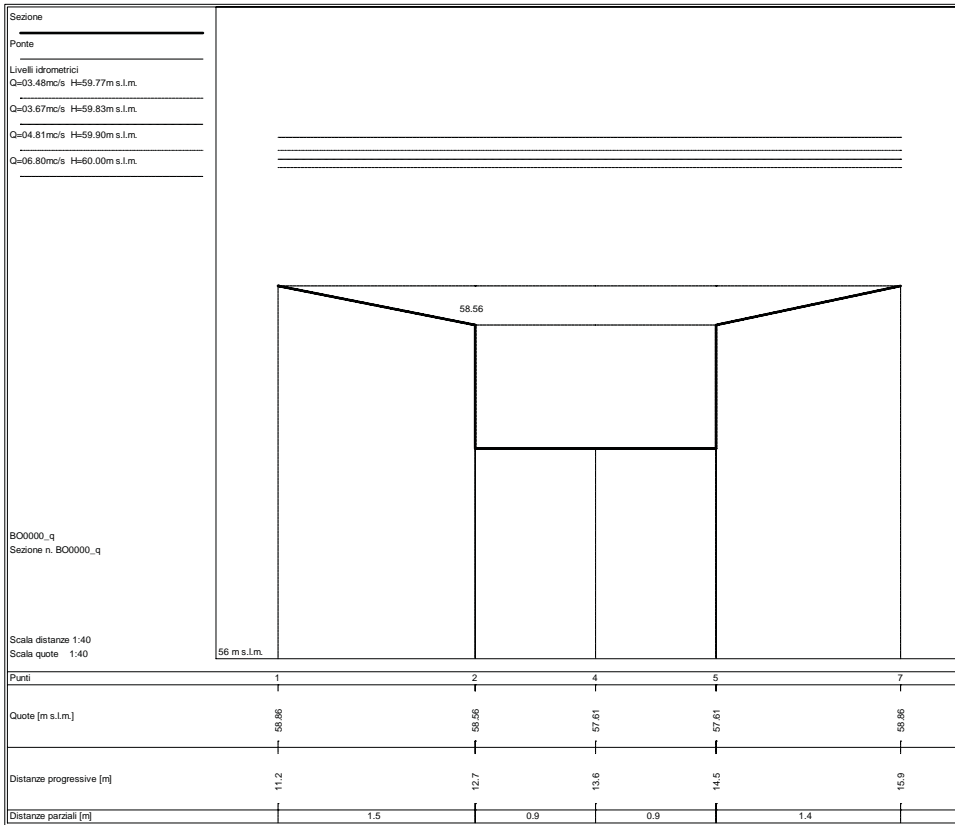

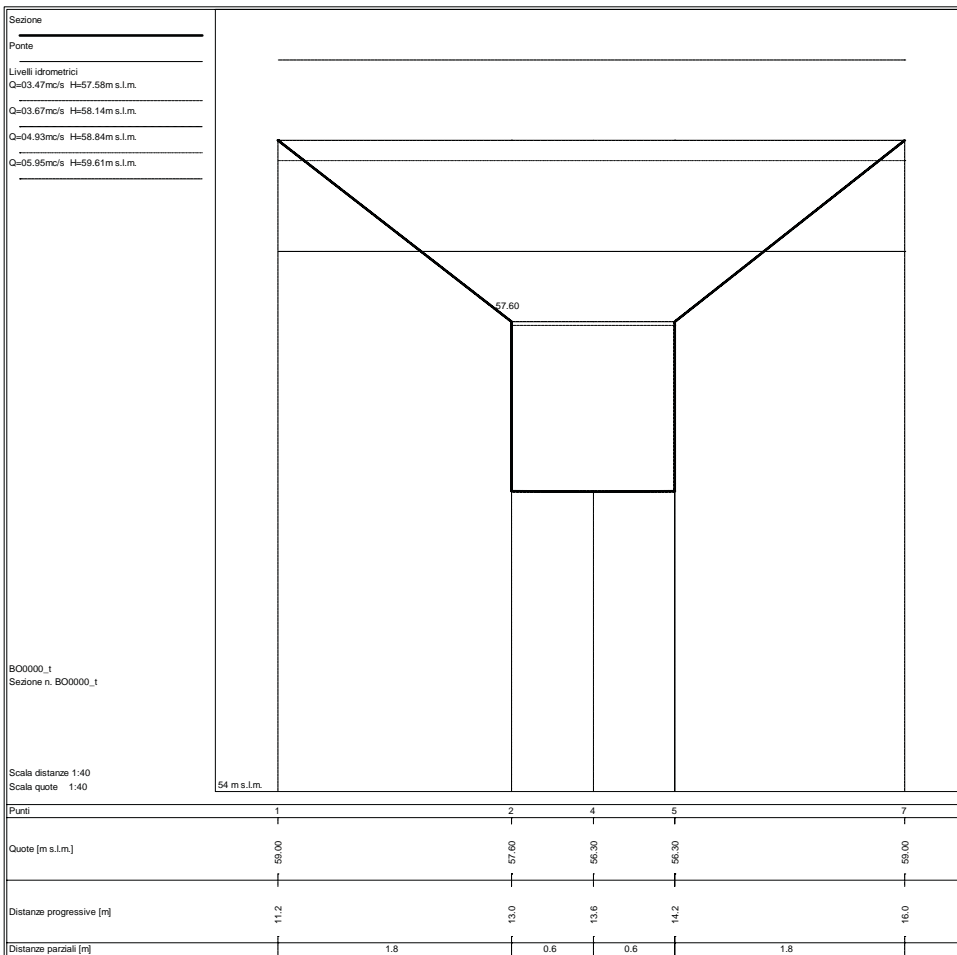
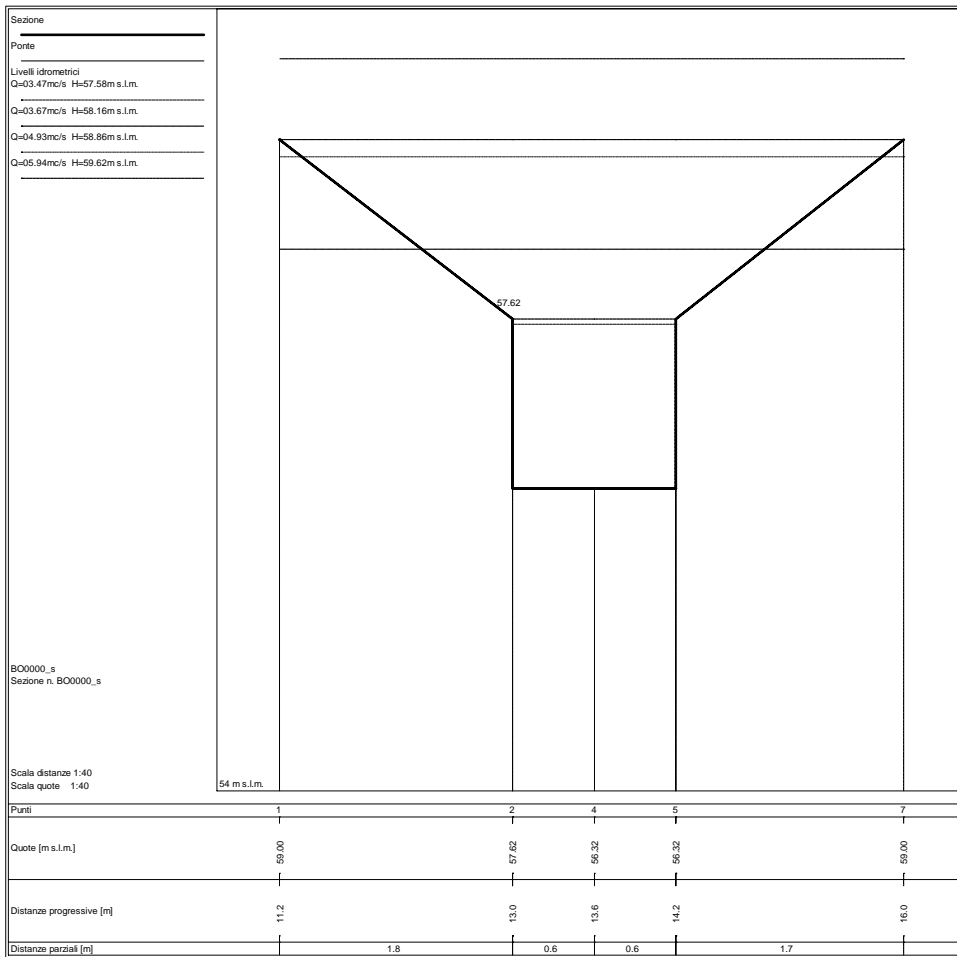

Sezione
 Ponte
 Livelli idrometrici
 Q=03.46mc/s H=57.52m s.l.m.
 Q=03.65mc/s H=57.99m s.l.m.
 Q=04.93mc/s H=58.57m s.l.m.
 Q=05.98mc/s H=59.68m s.l.m.

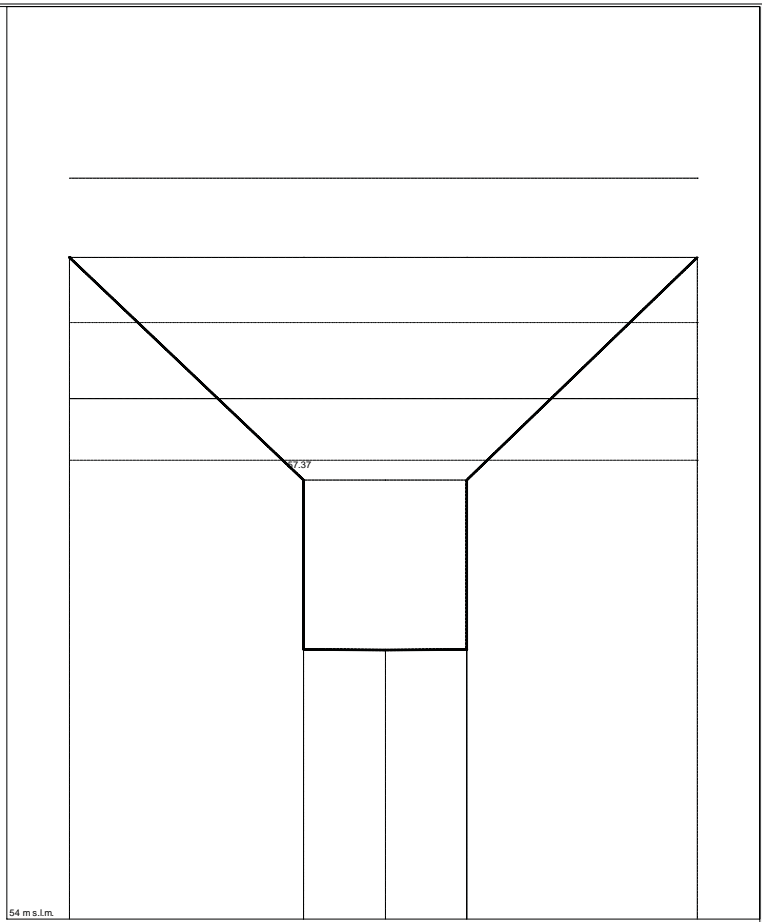

BO0000_u
 Sezione n. BO0000_u

Scala distanze 1:40
 Scala quote 1:40

Punti	1	2	4	5	7
Quote [m s.l.m.]	59.08	57.37	56.07	56.07	59.08
Distanze progressive [m]	11.2	13.0	13.6	14.2	16.0
Distanze parziali [m]		1.8	0.6	0.6	1.8

Sezione
 Ponte
 Livelli idrometrici
 Q=03.46mc/s H=57.45m s.l.m.
 Q=03.65mc/s H=57.85m s.l.m.
 Q=04.93mc/s H=58.72m s.l.m.
 Q=05.98mc/s H=59.67m s.l.m.

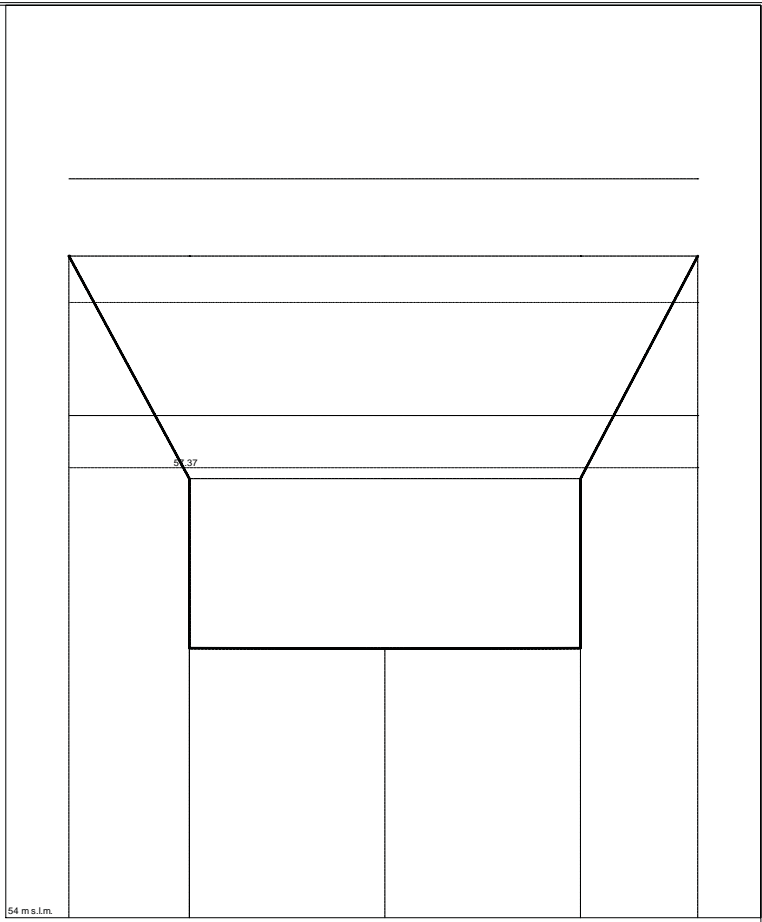

BO0000_v
 Sezione n. BO0000_v

Scala distanze 1:40
 Scala quote 1:40

Punti	1	2	4	5	7
Quote [m s.l.m.]	59.08	57.37	56.07	56.07	59.08
Distanze progressive [m]	11.1	12.1	13.6	15.1	16.0
Distanze parziali [m]		0.9	1.5	1.5	0.9

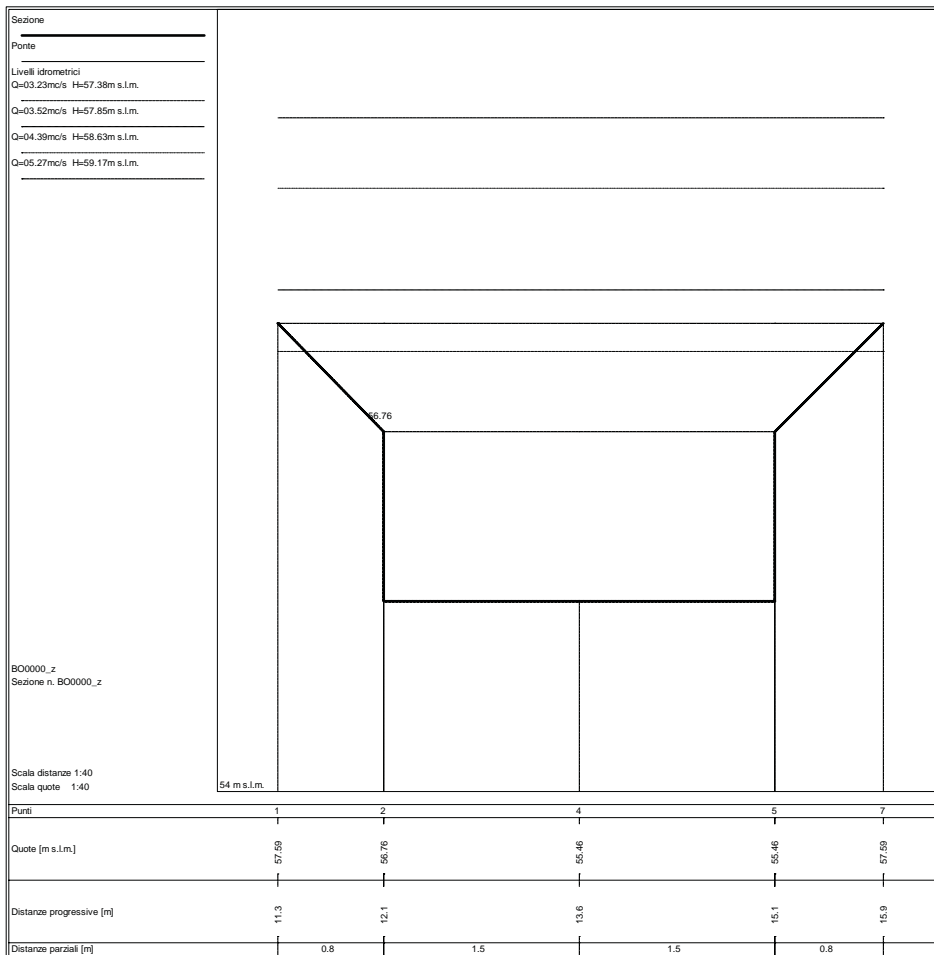
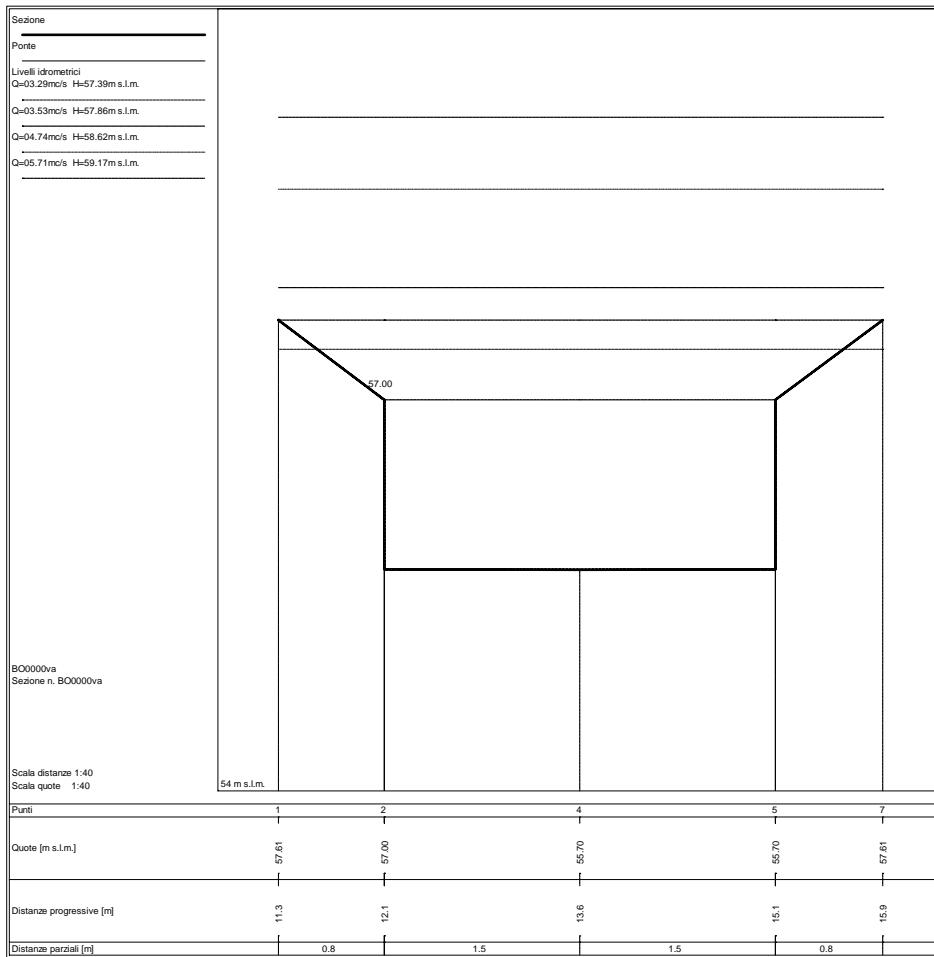

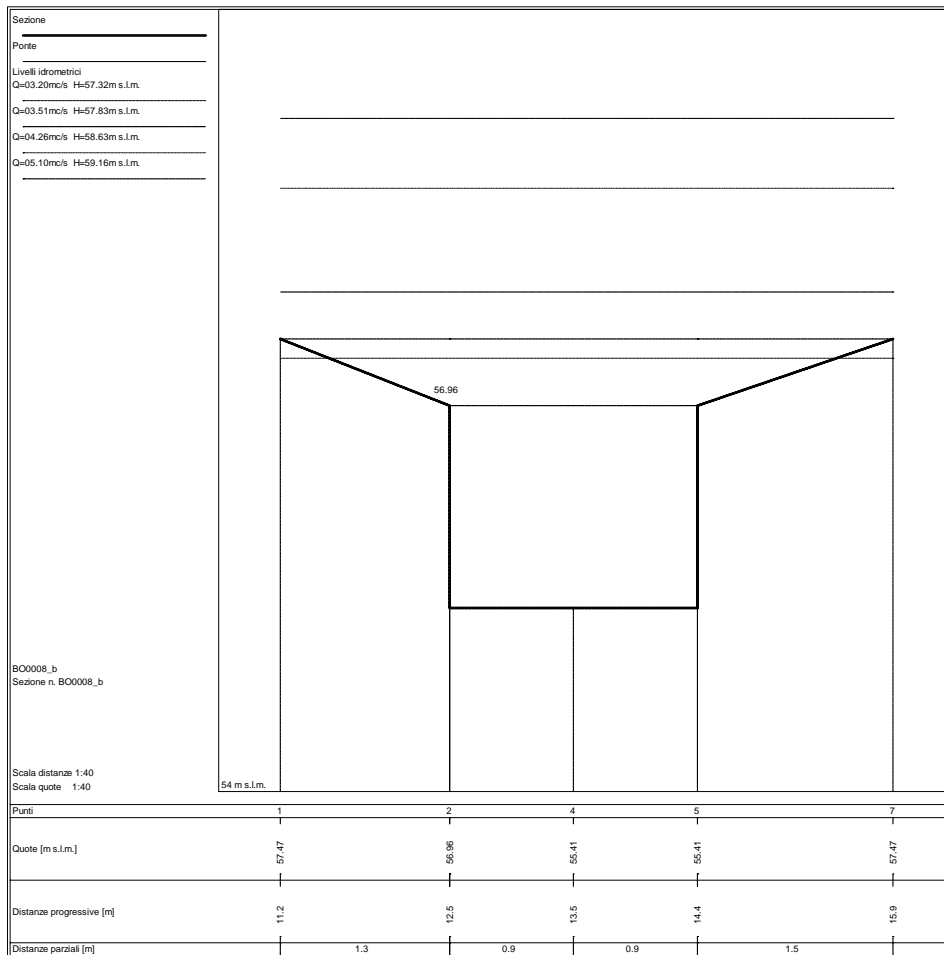
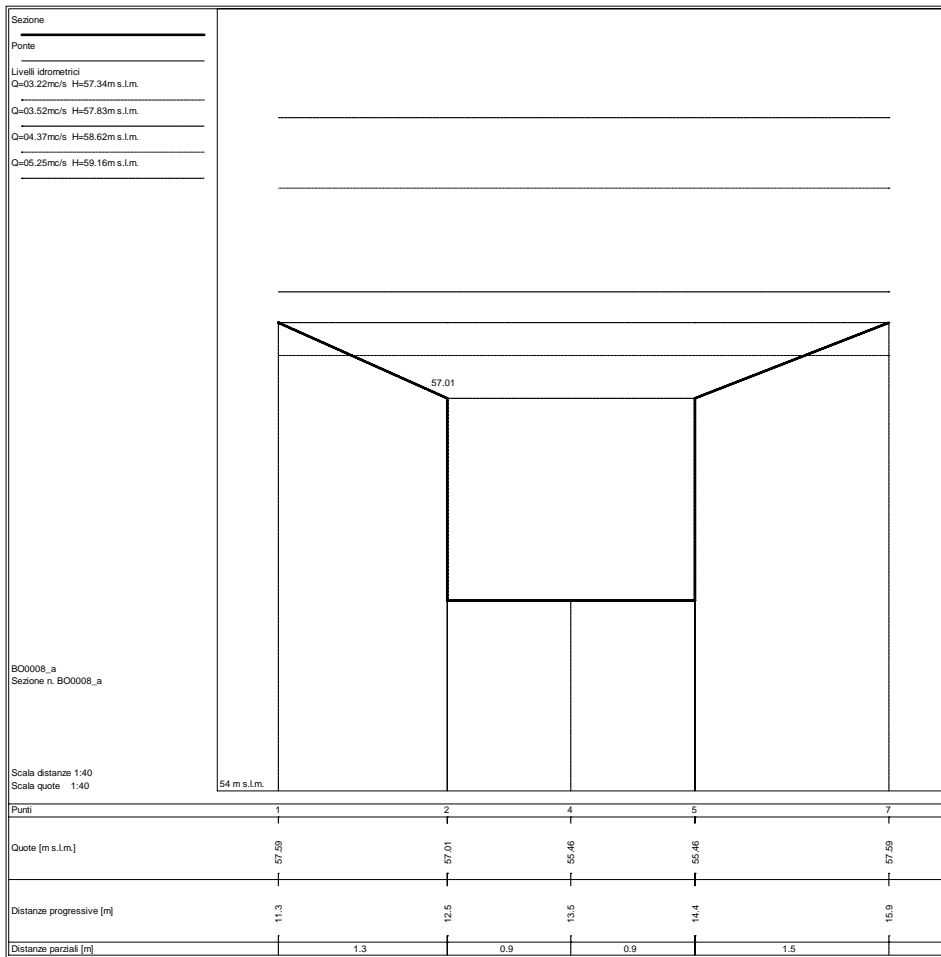

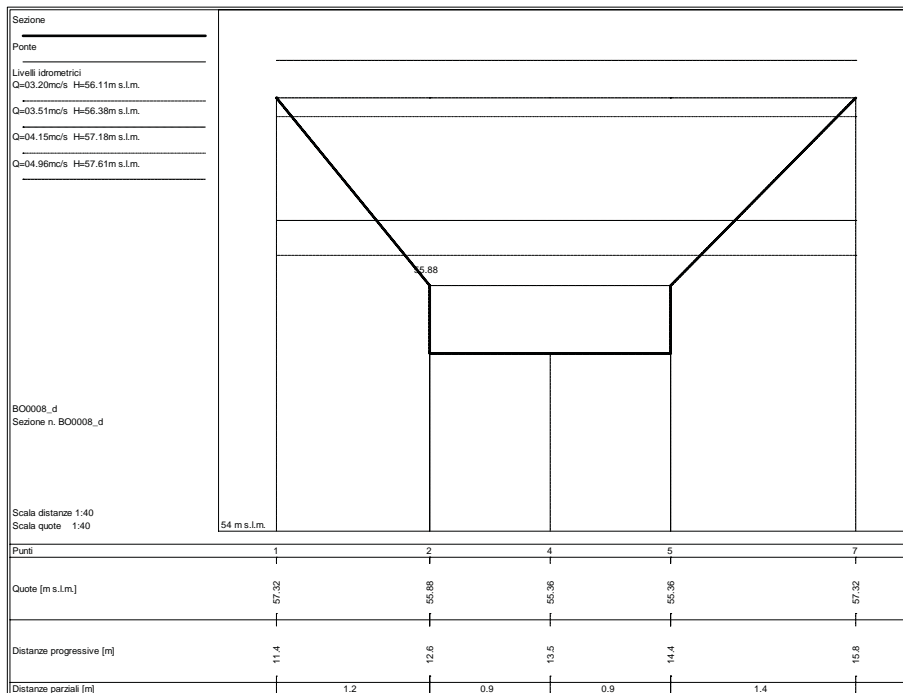
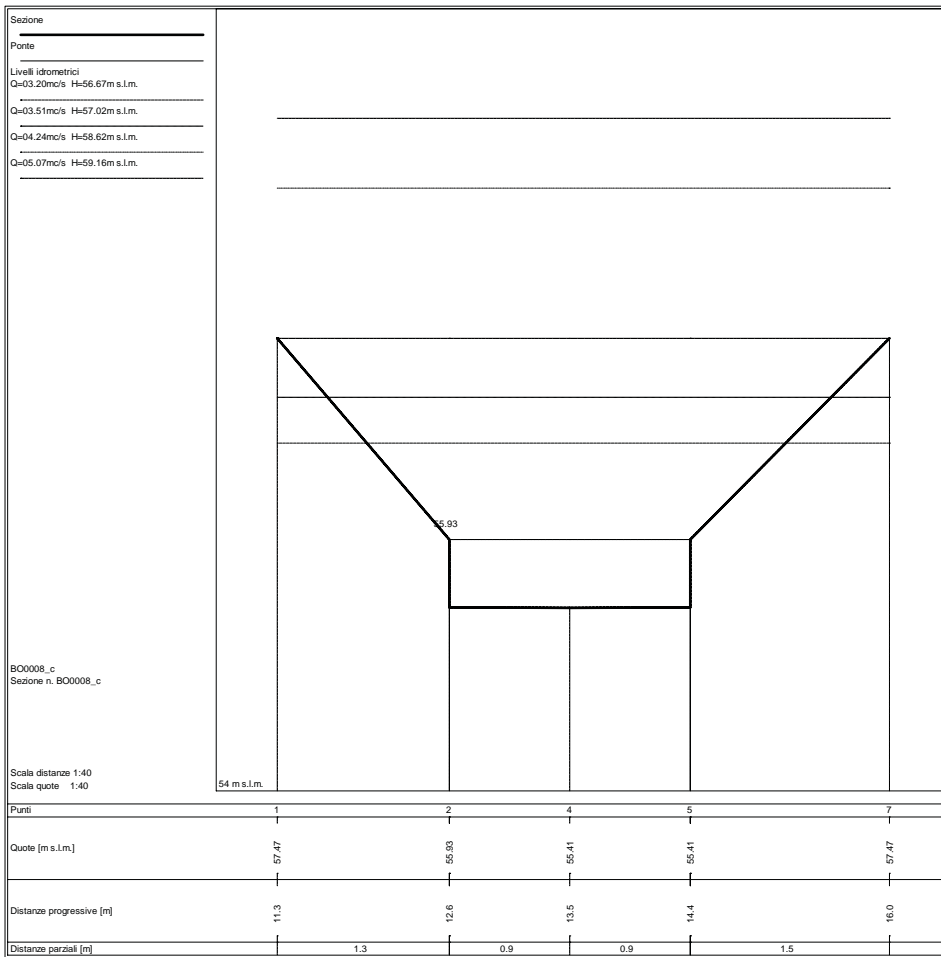

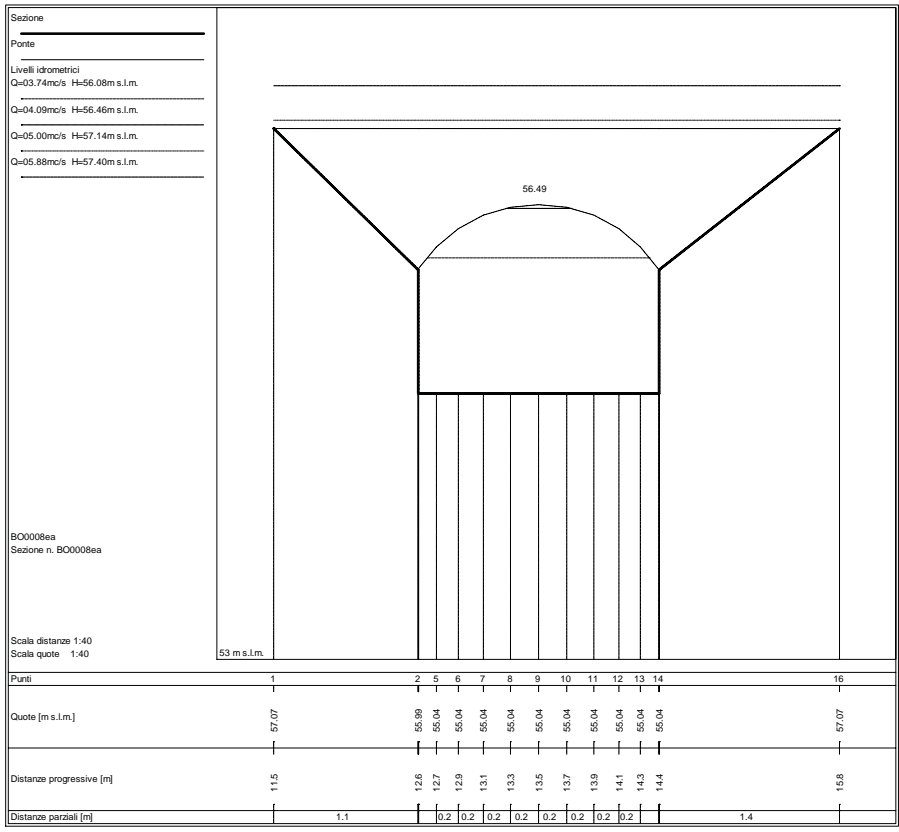
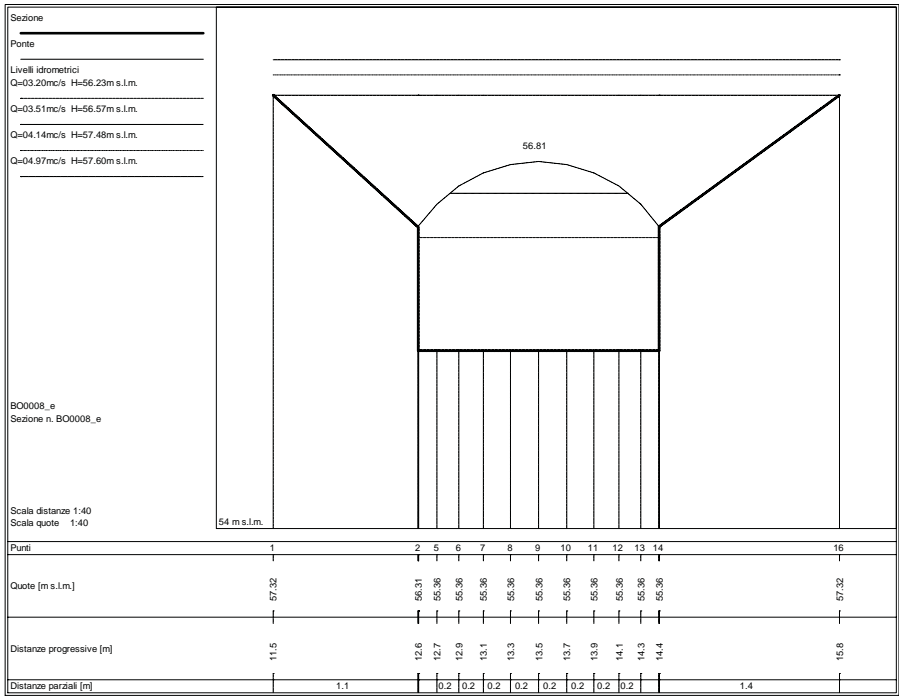

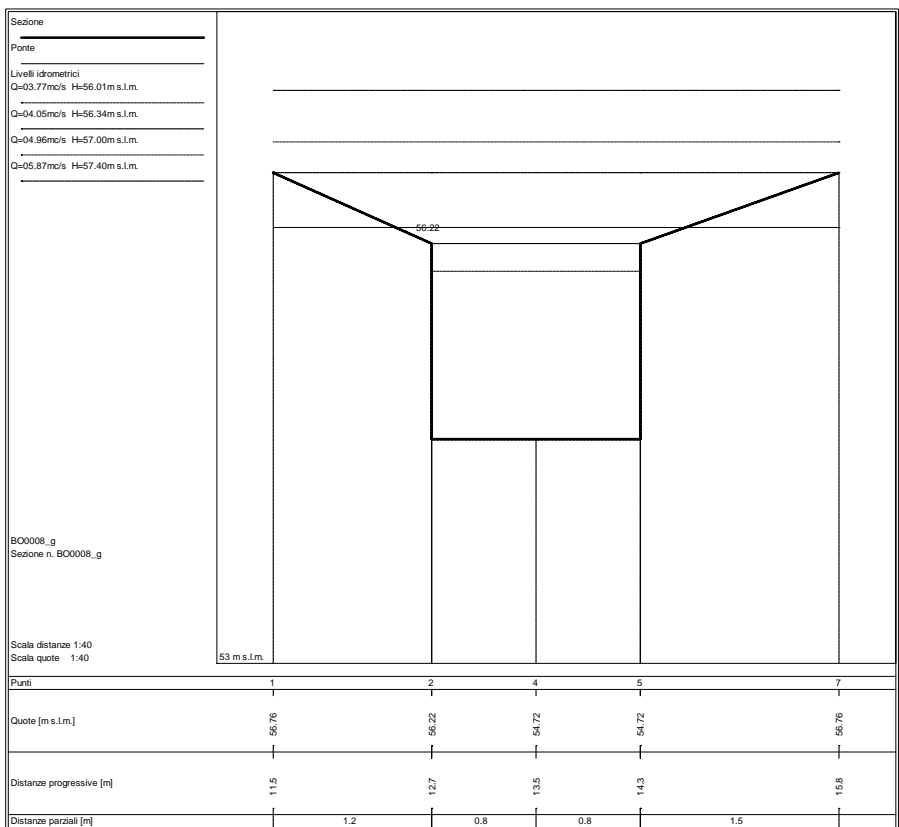
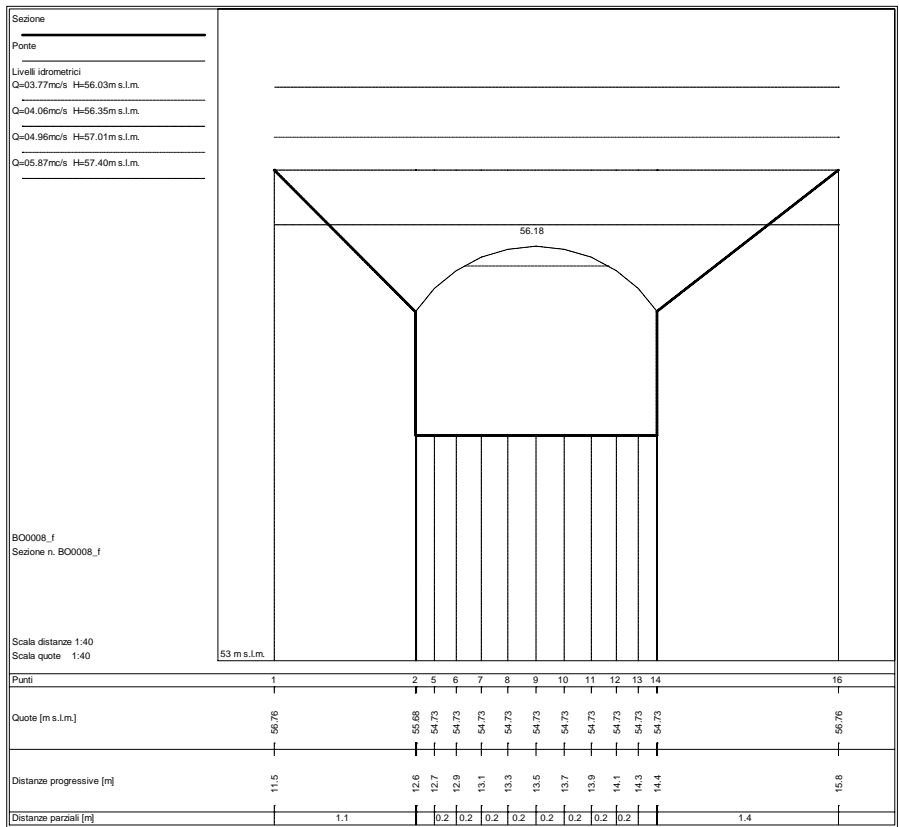

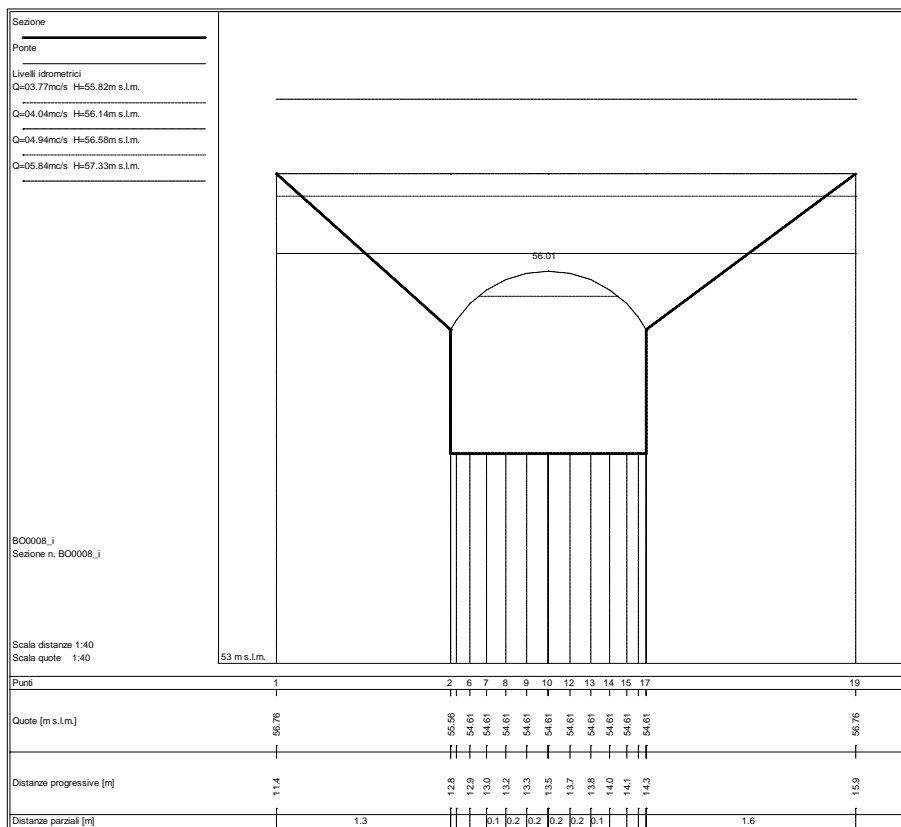
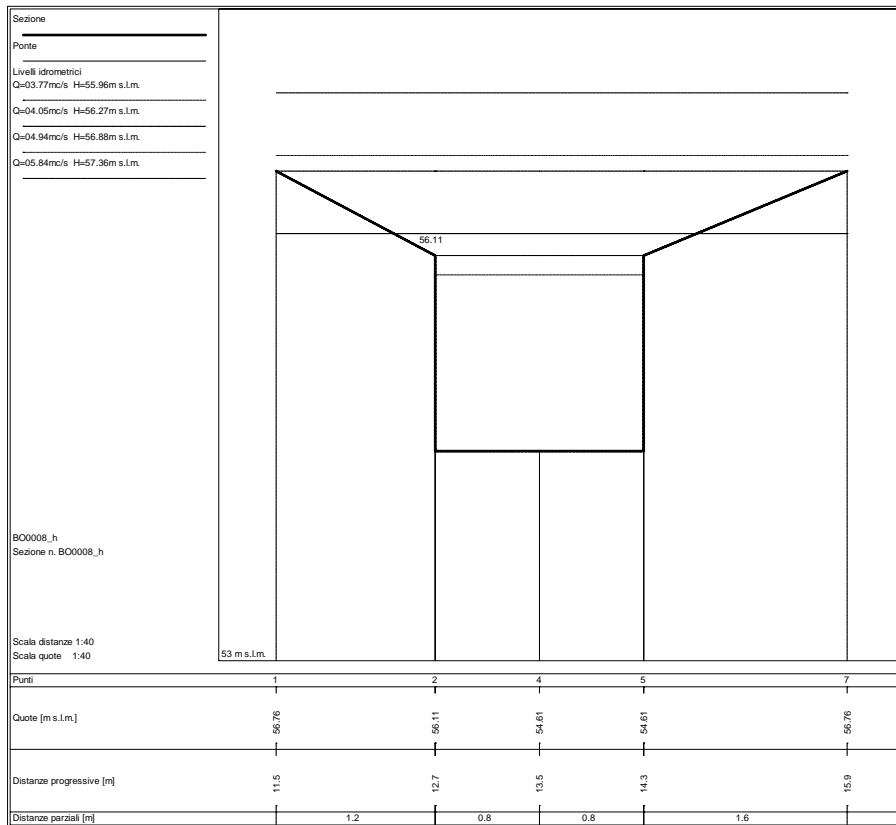

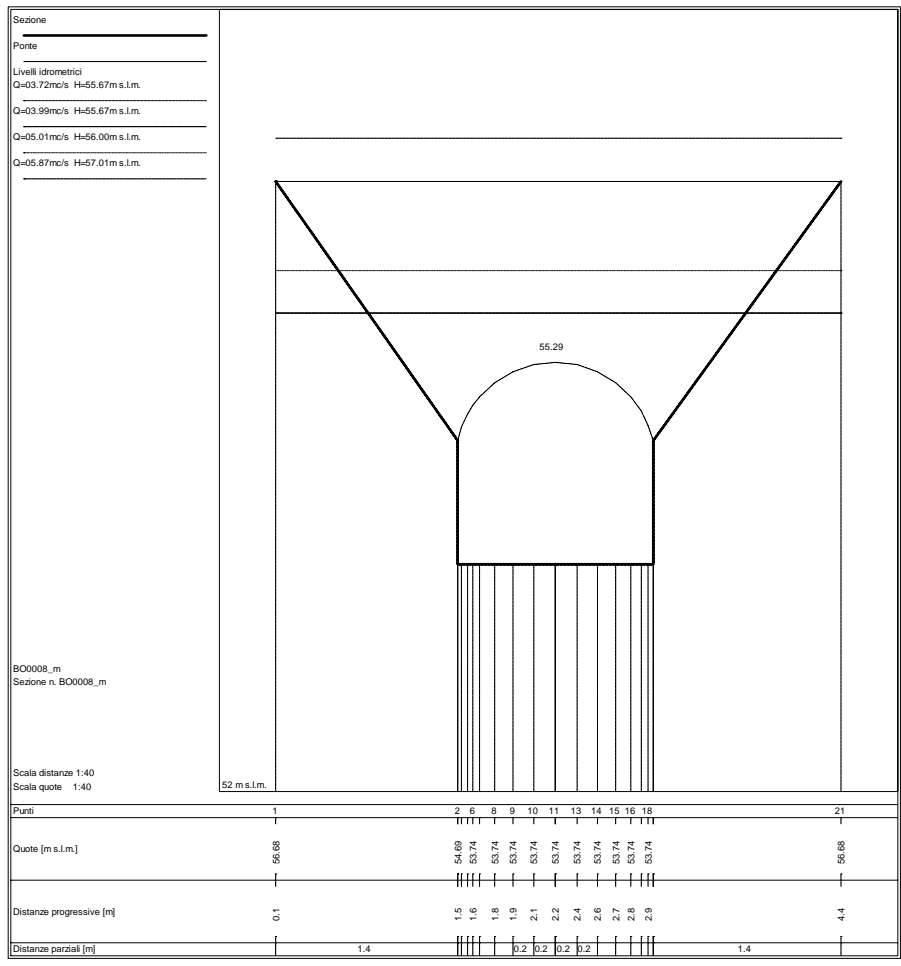
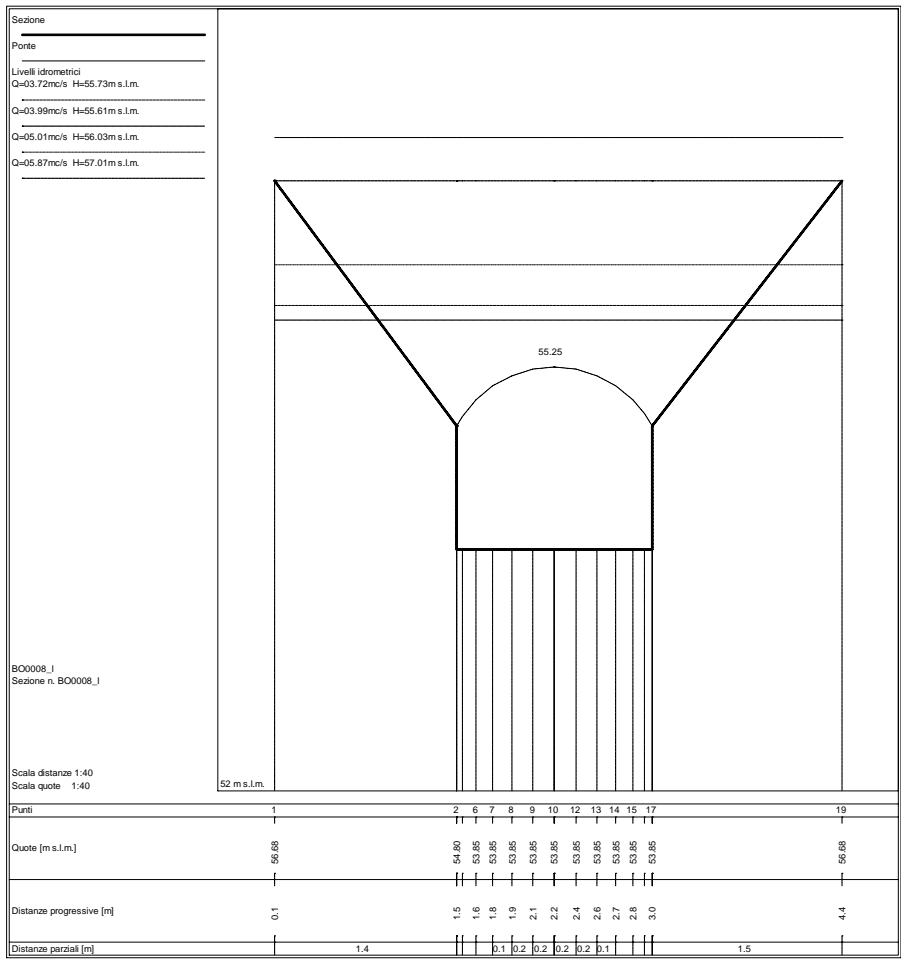

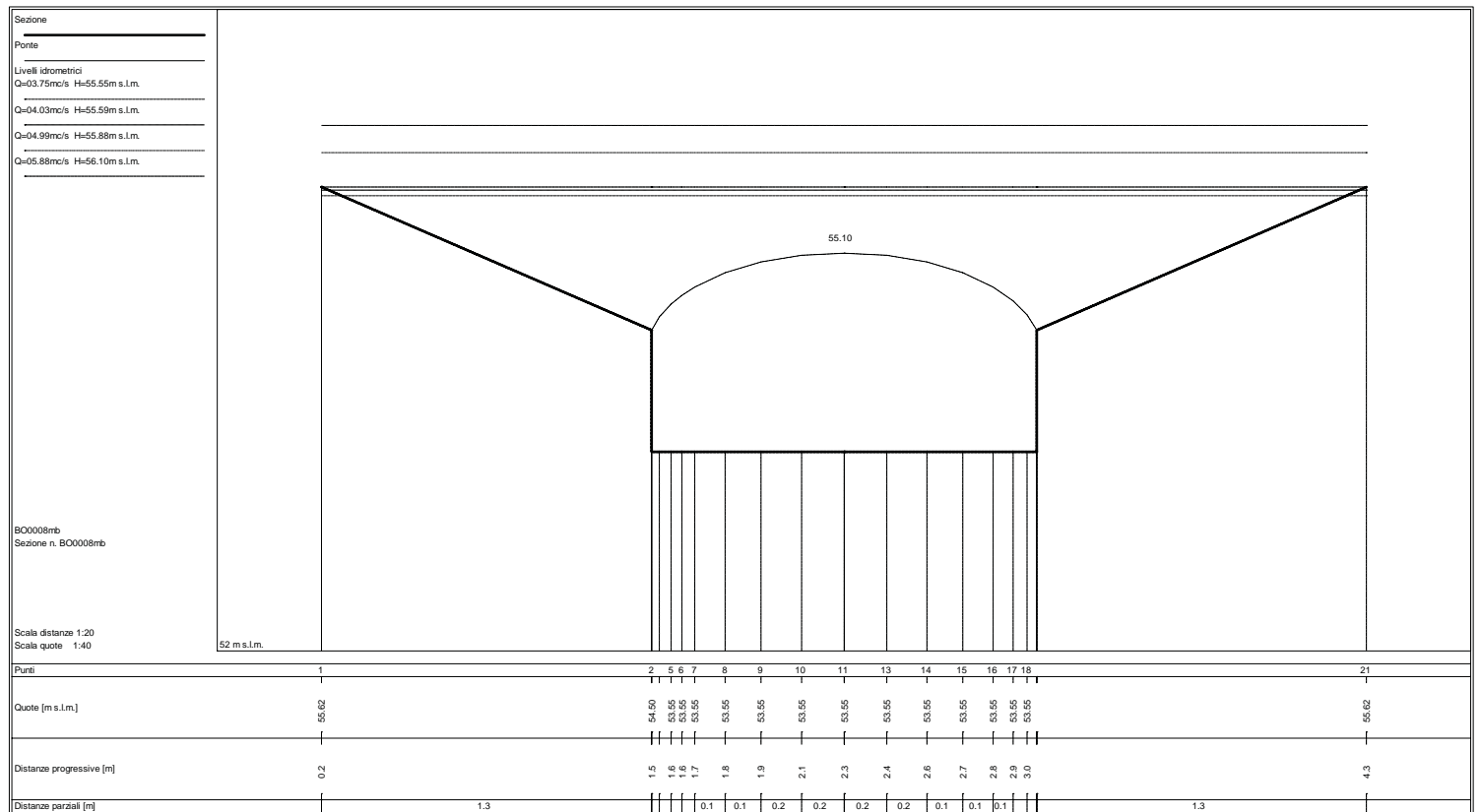
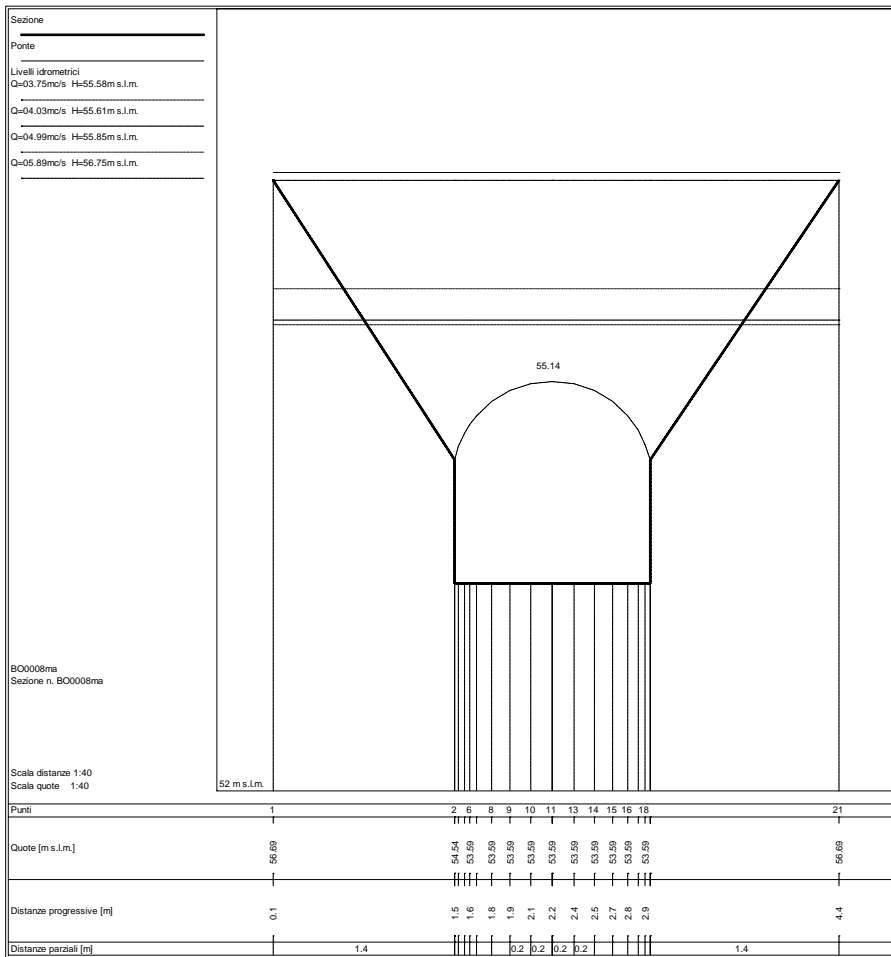

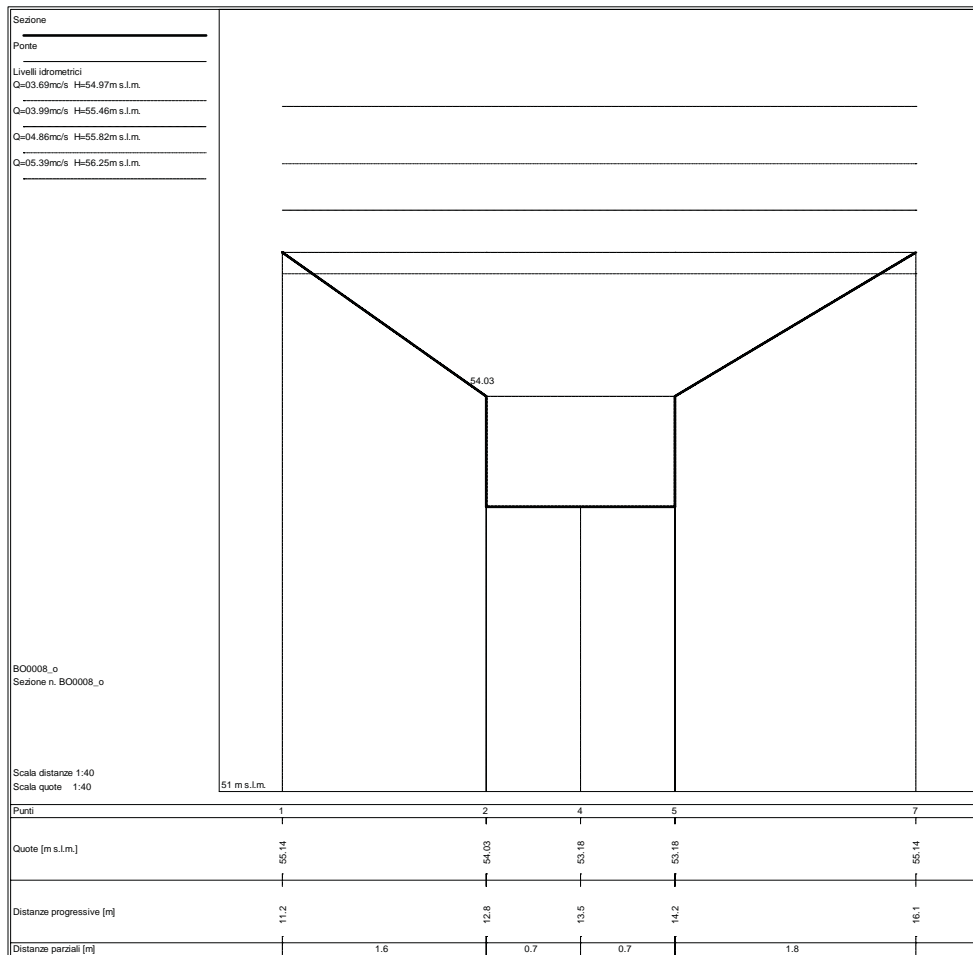
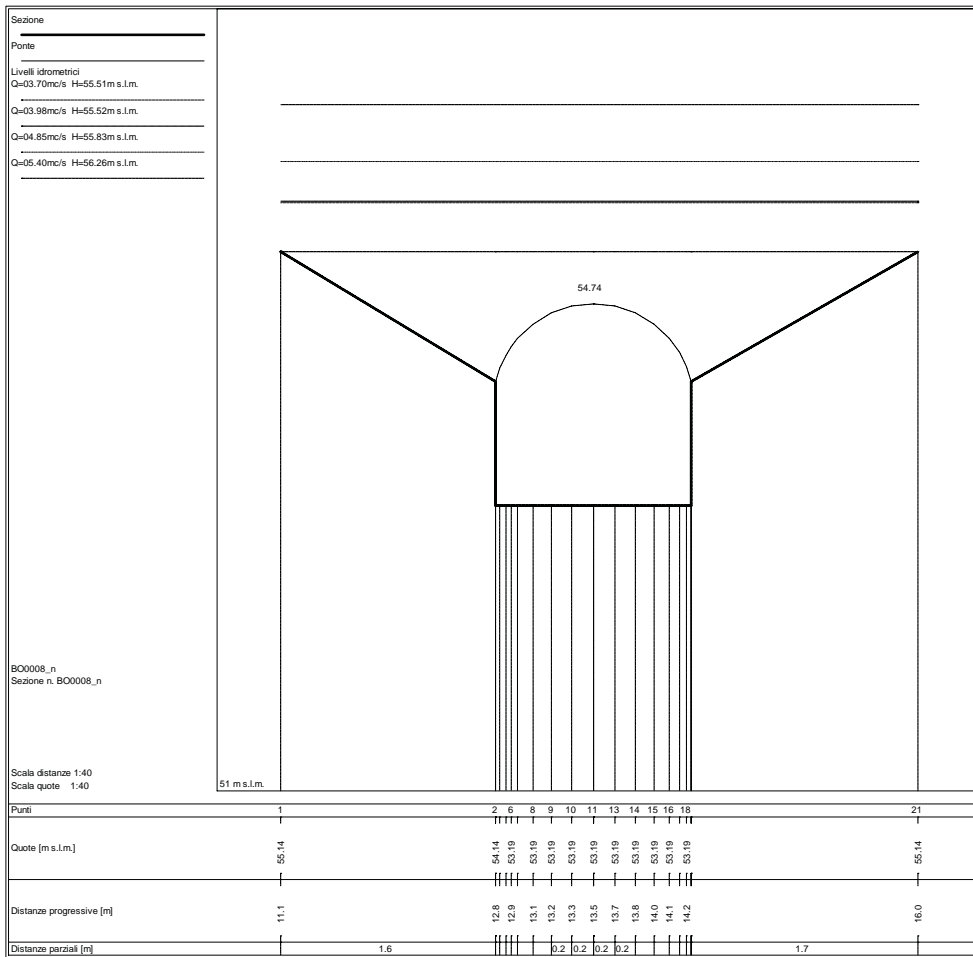

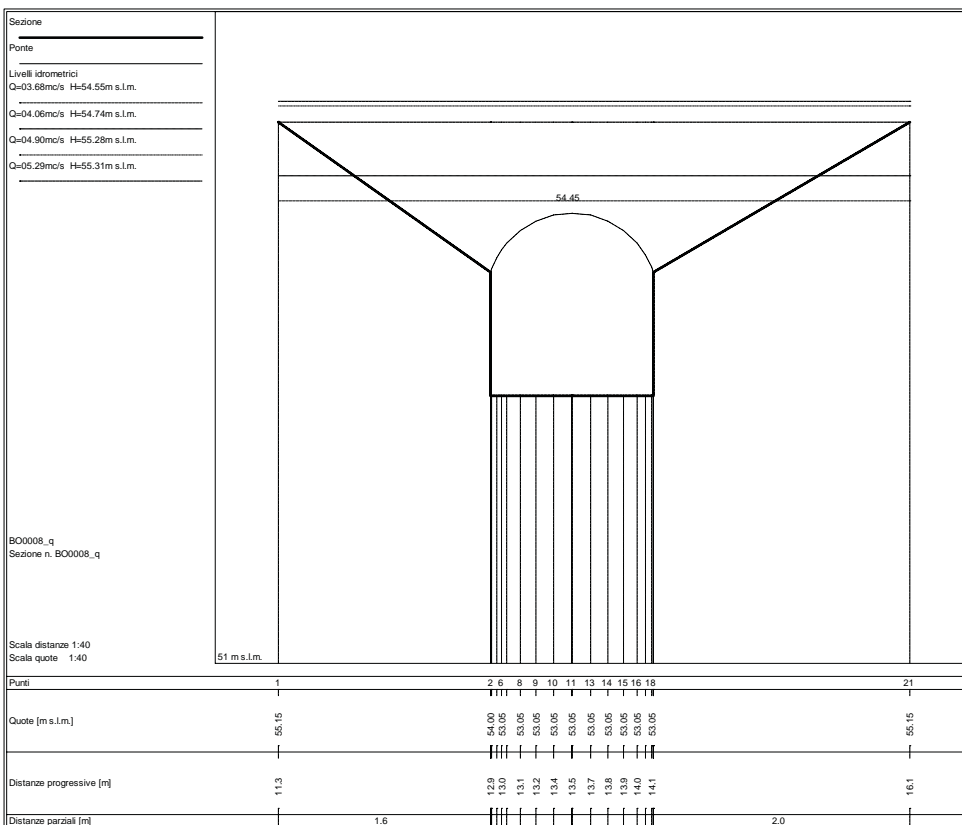
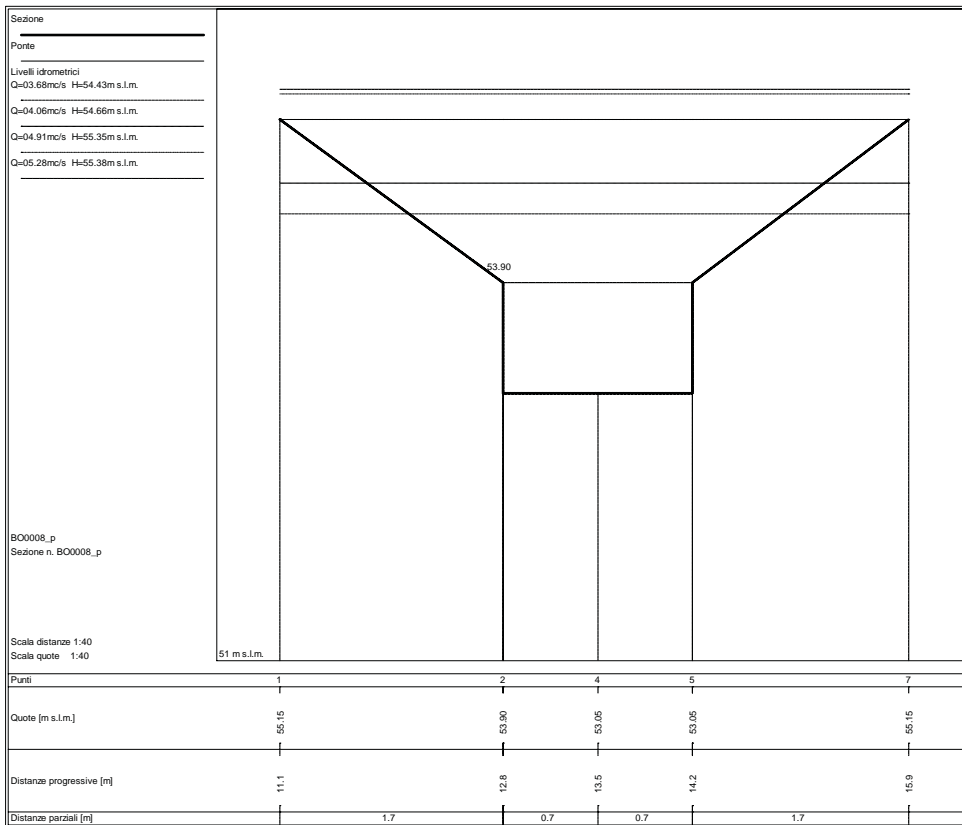

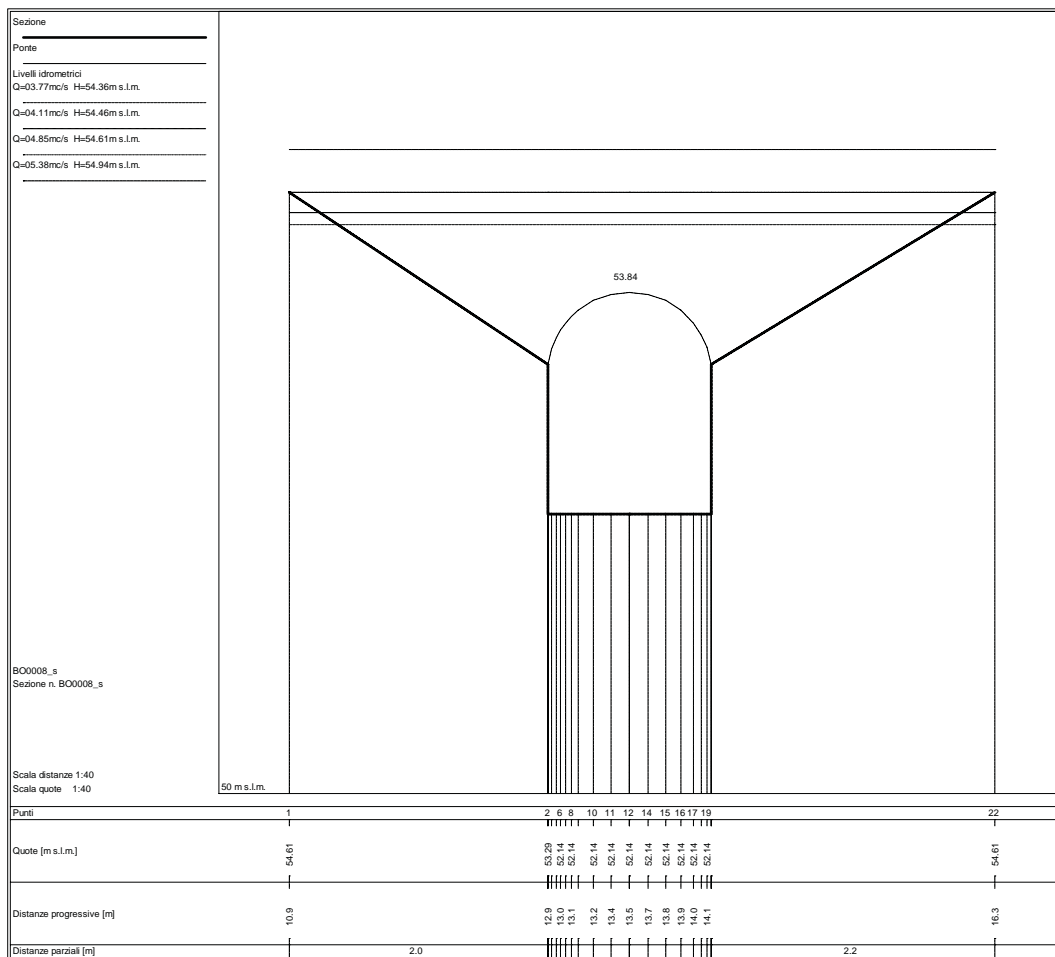
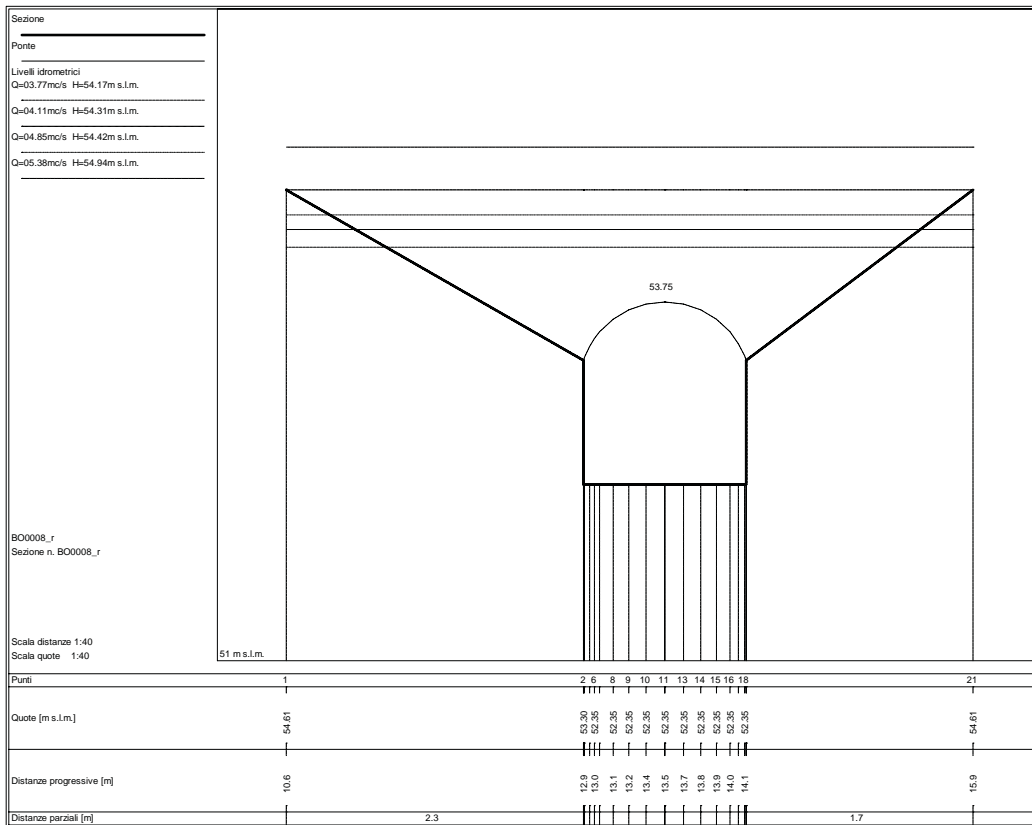

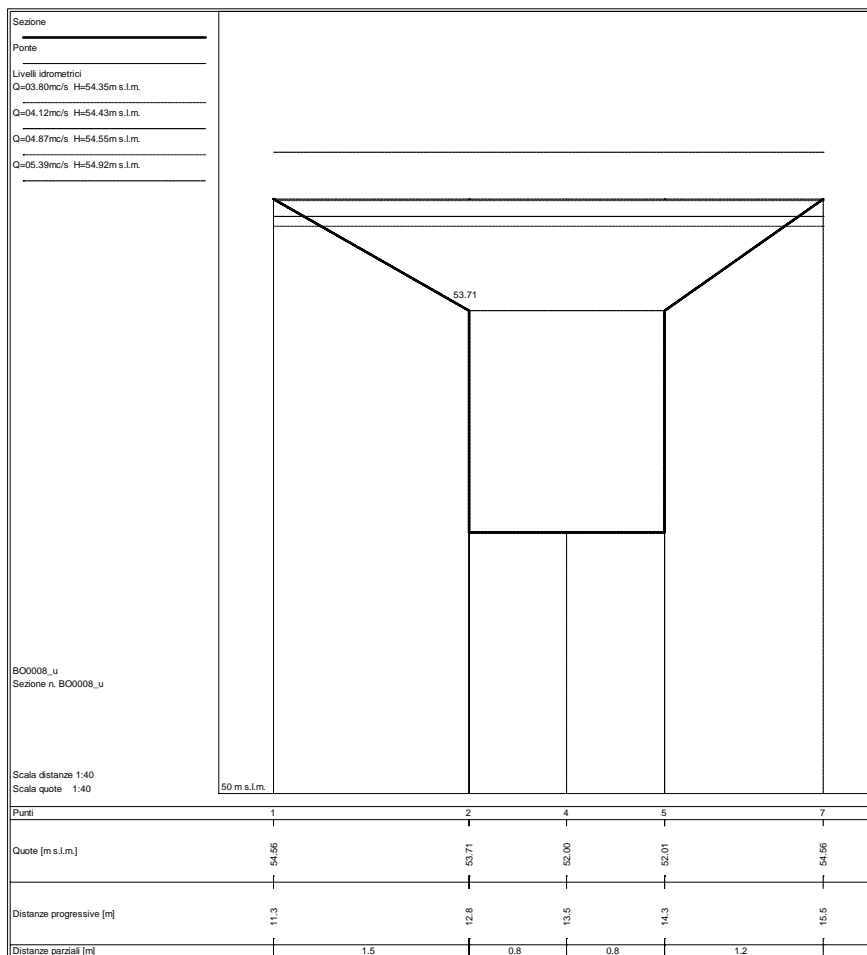
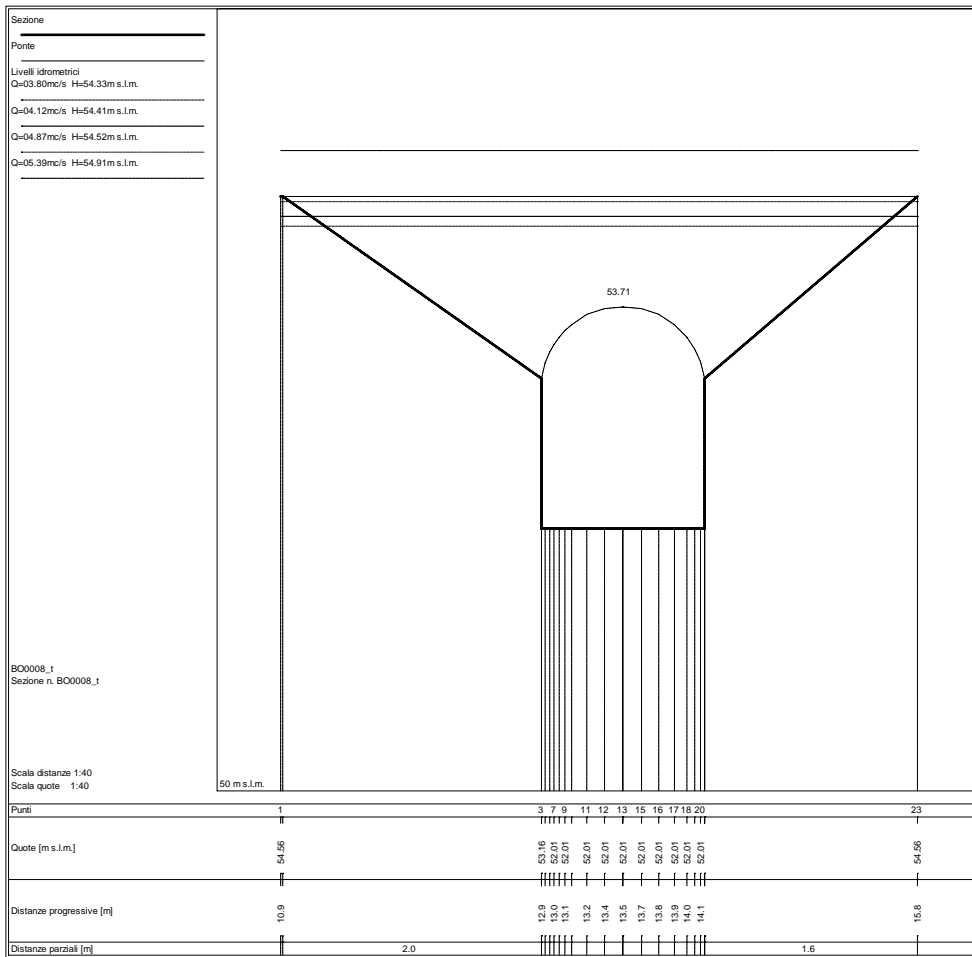

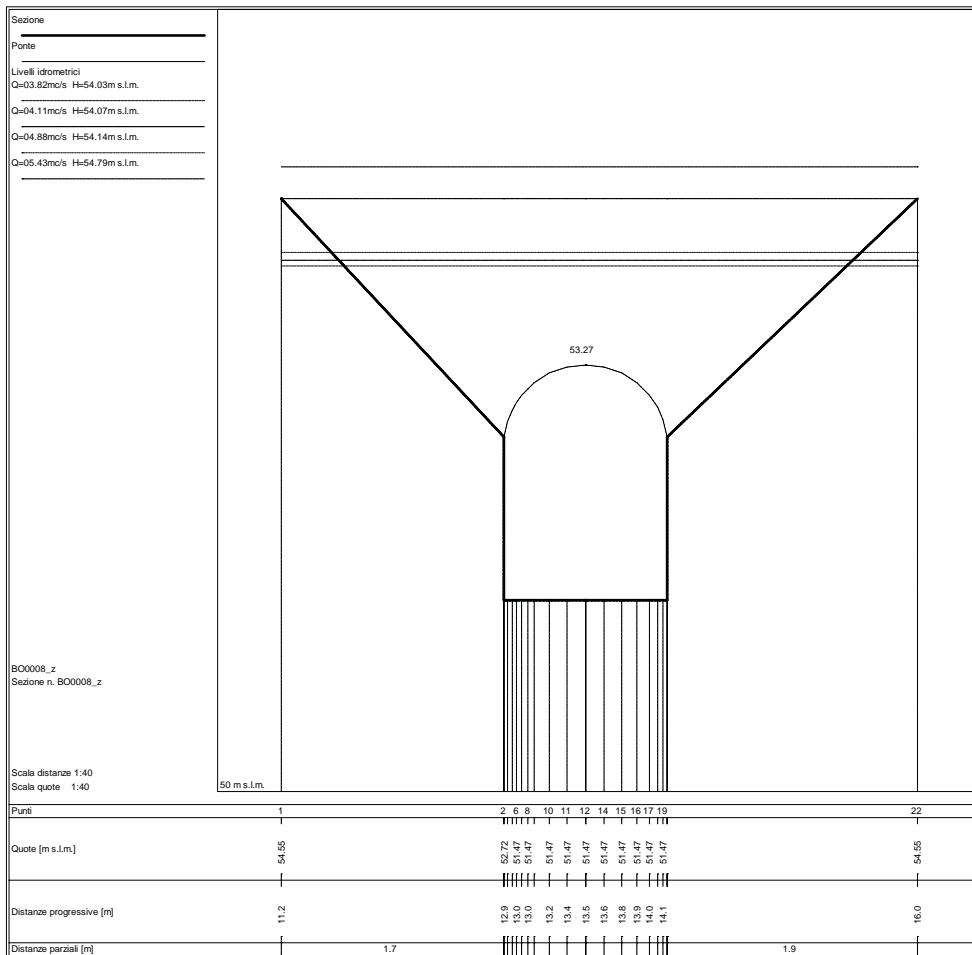
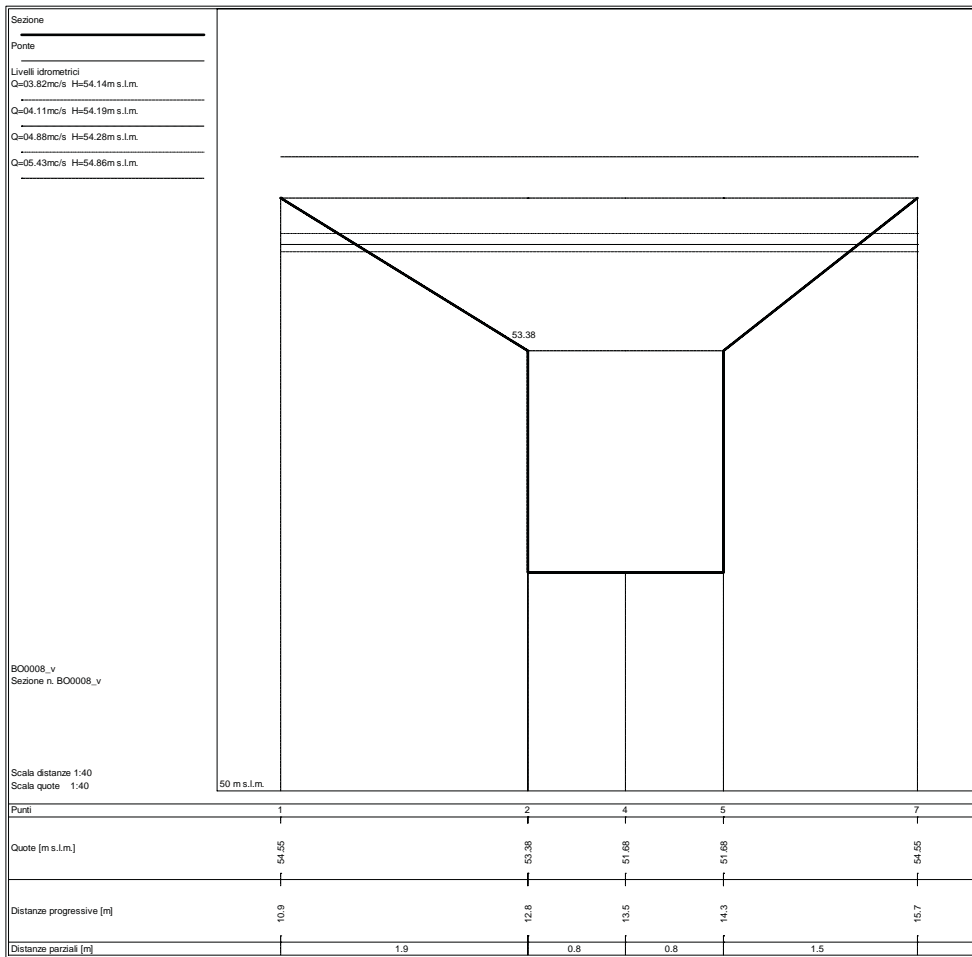

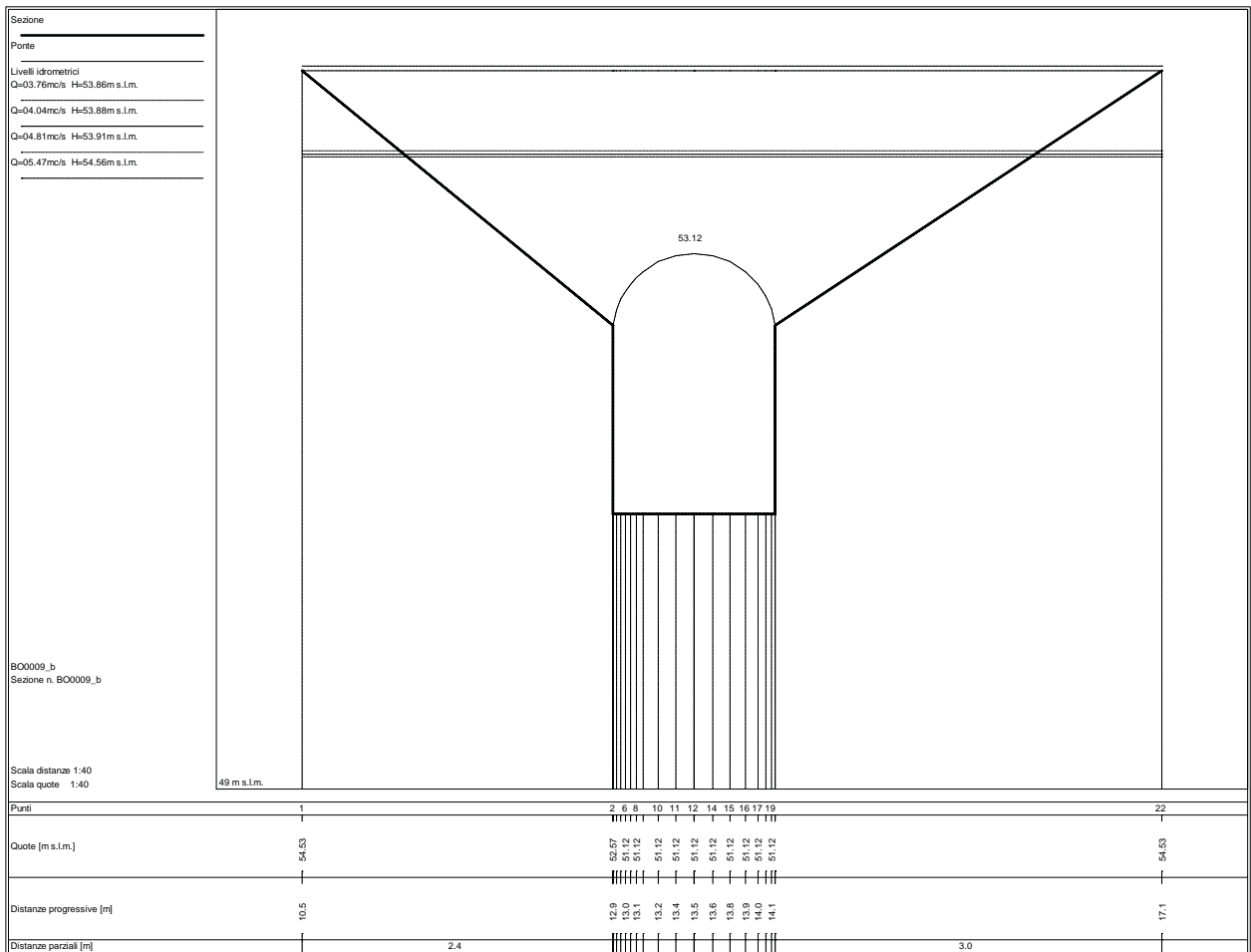
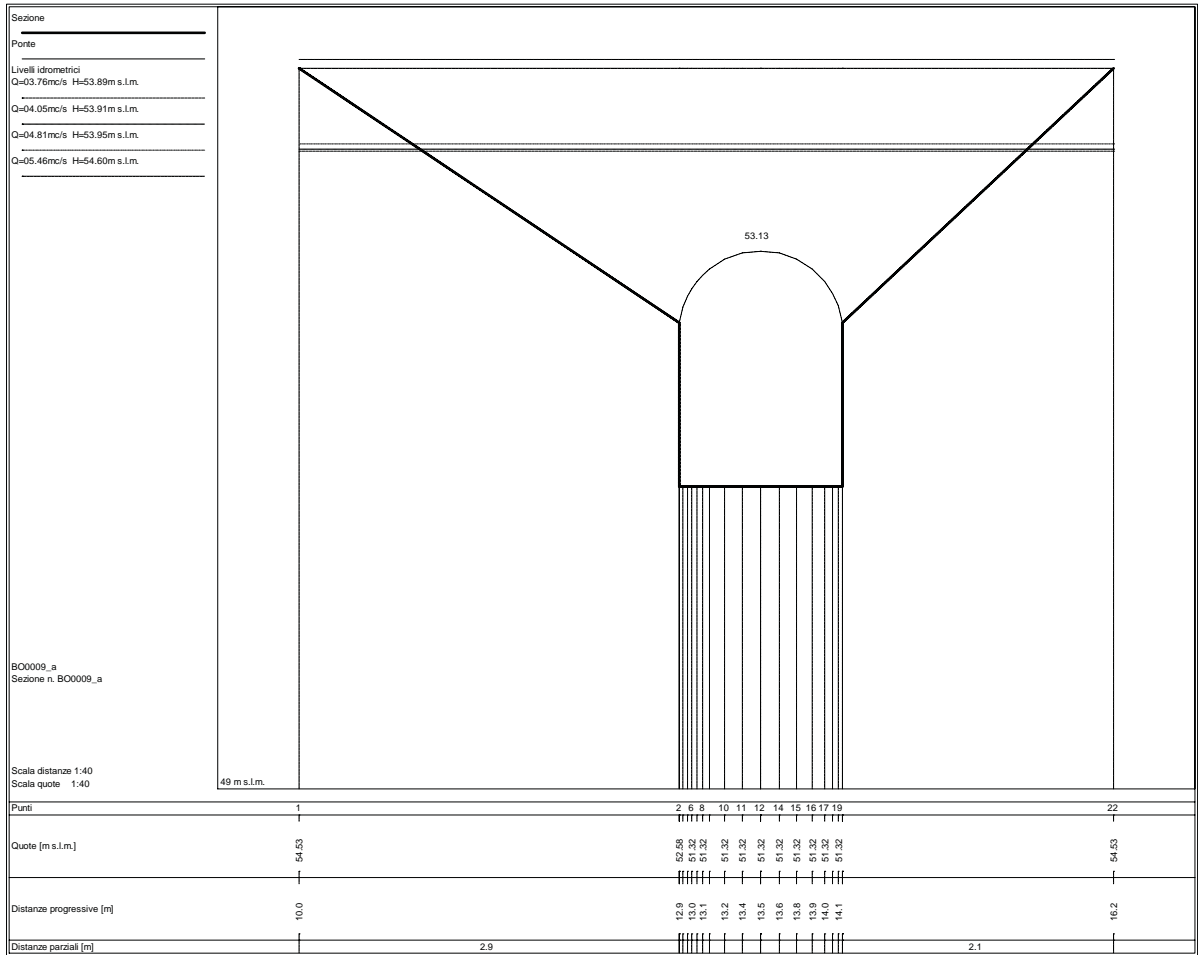

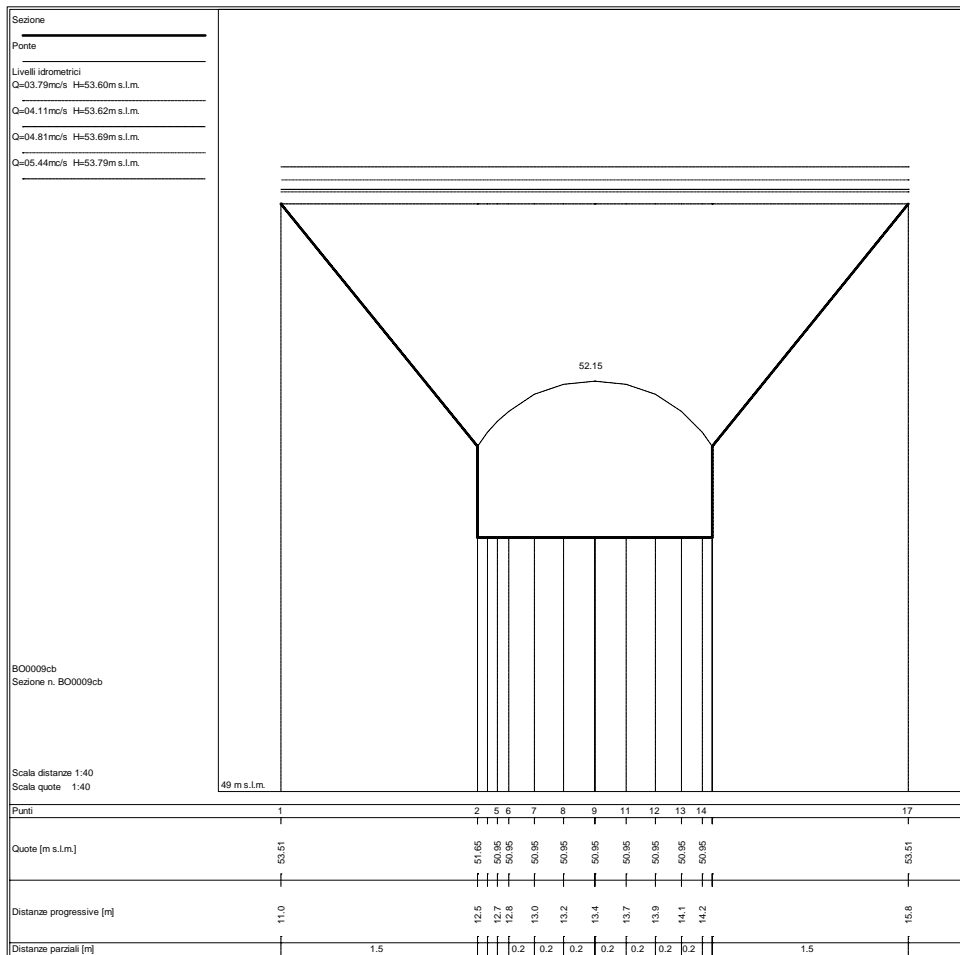
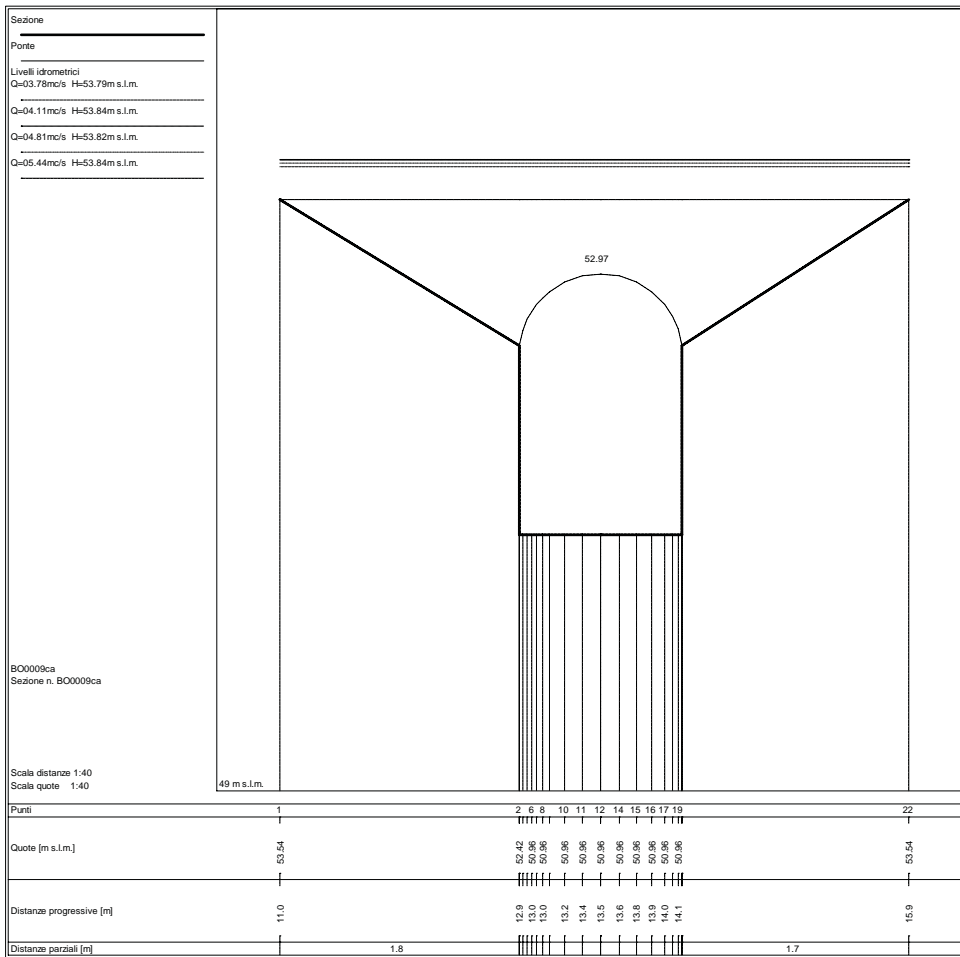

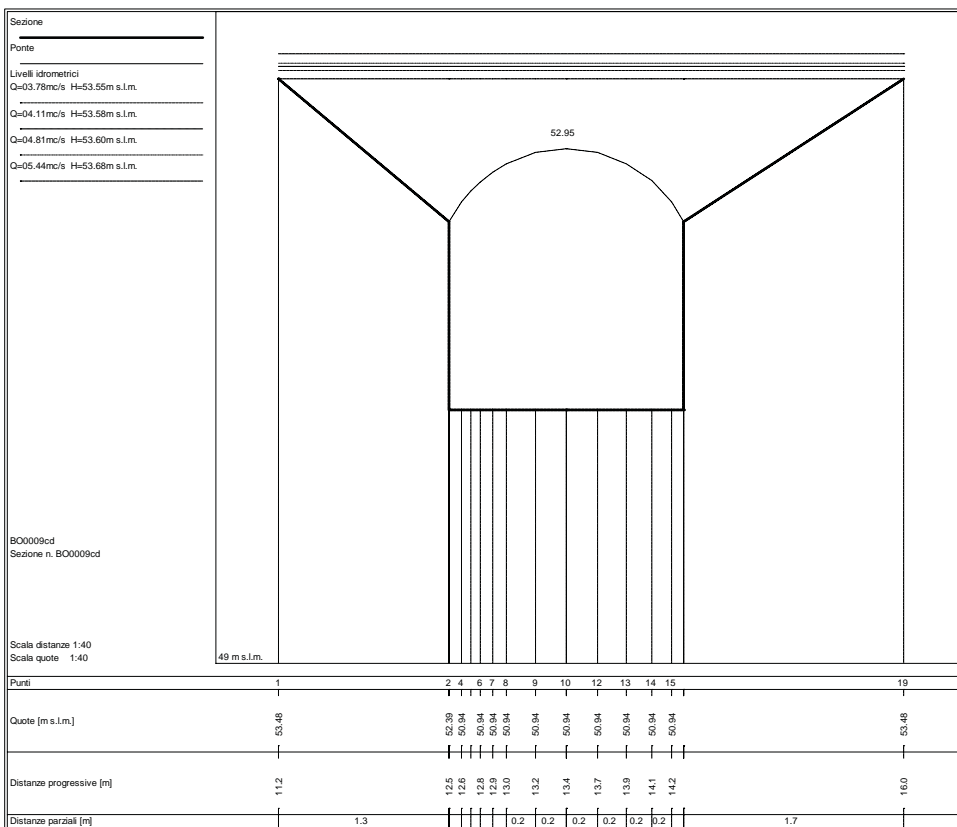
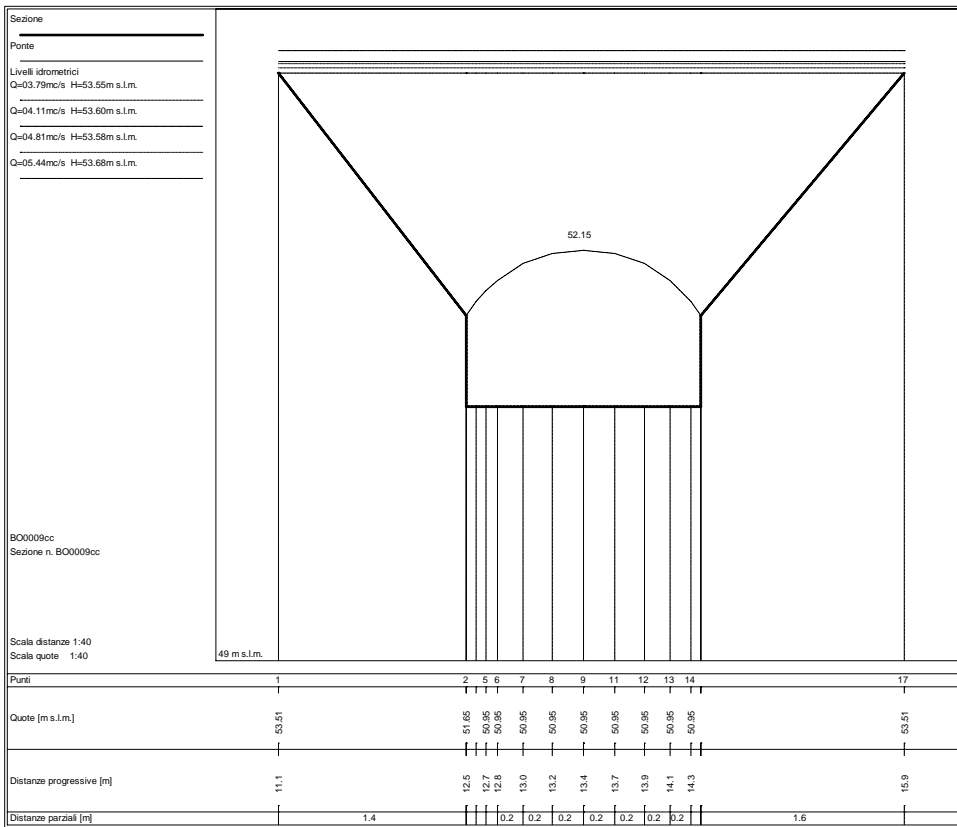

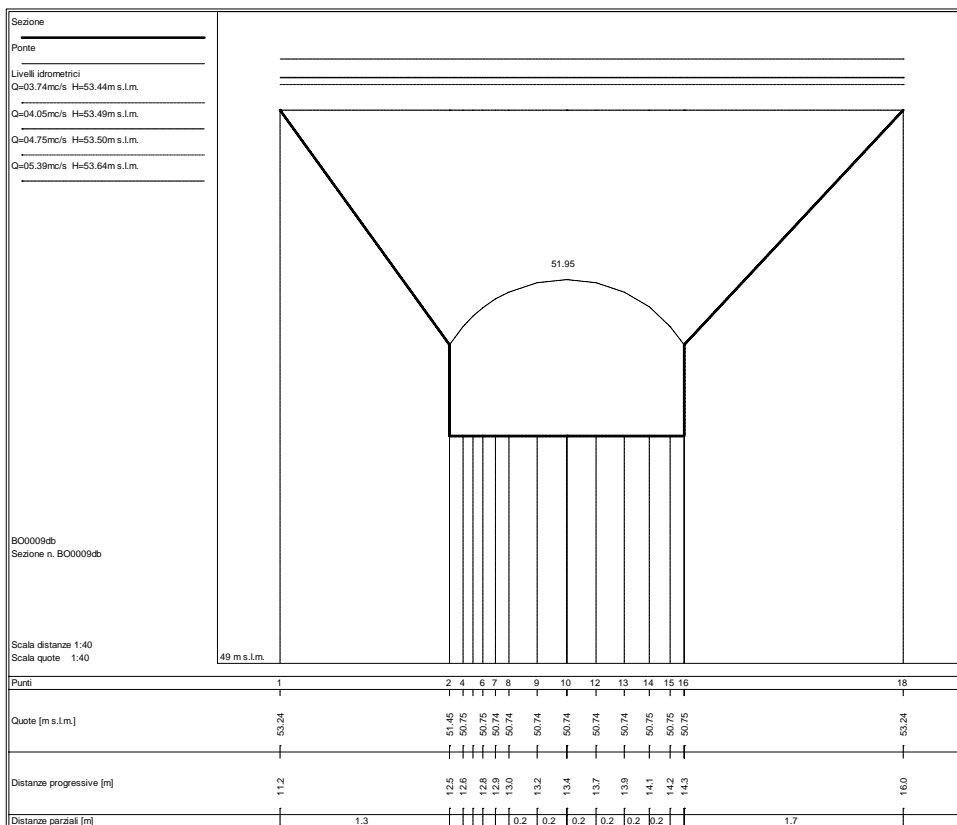
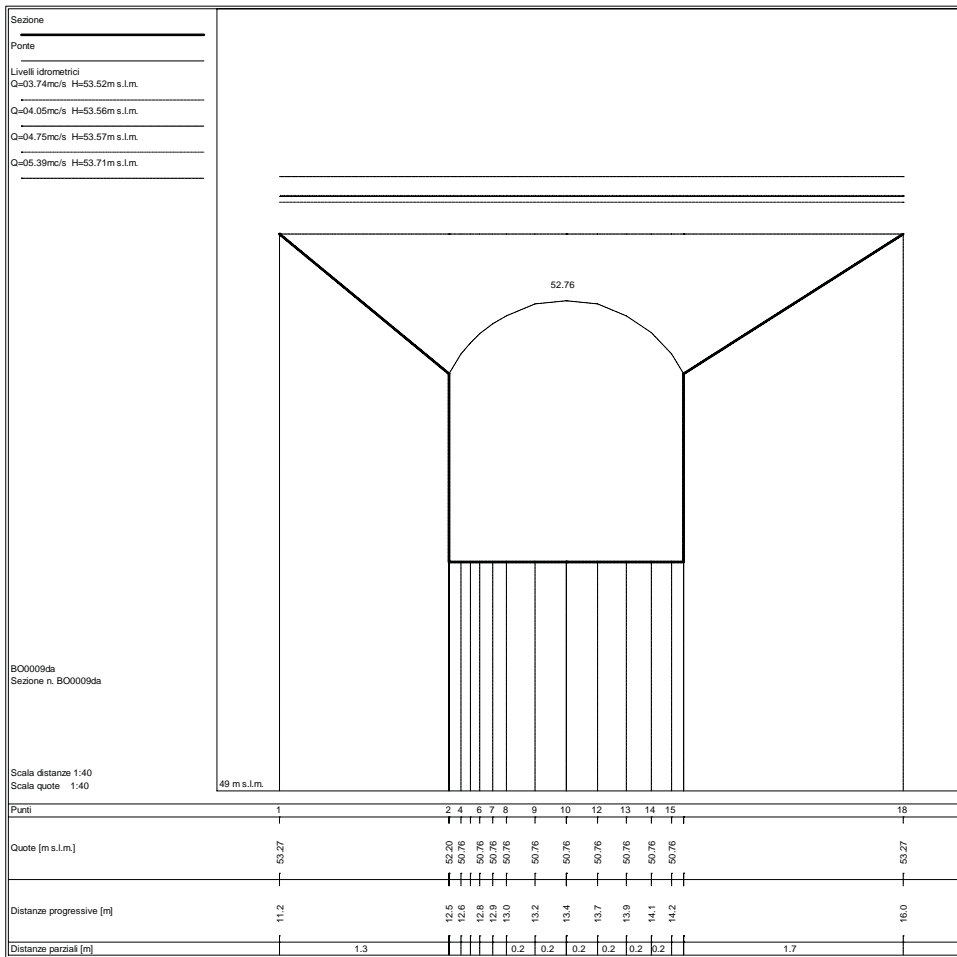

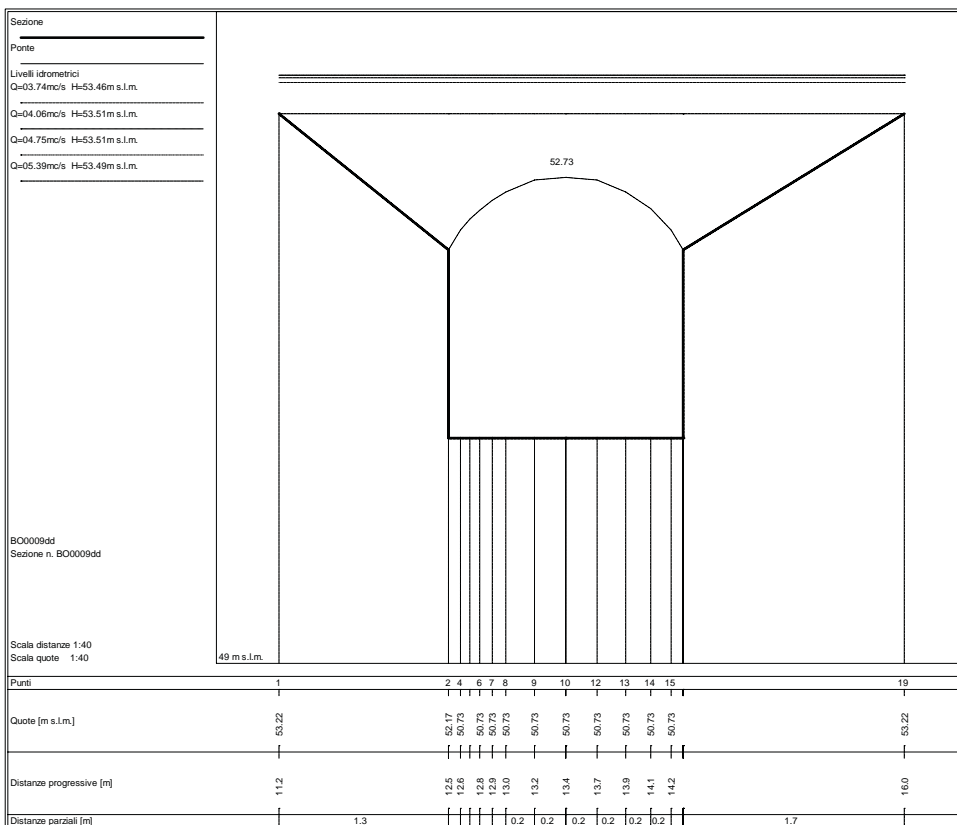
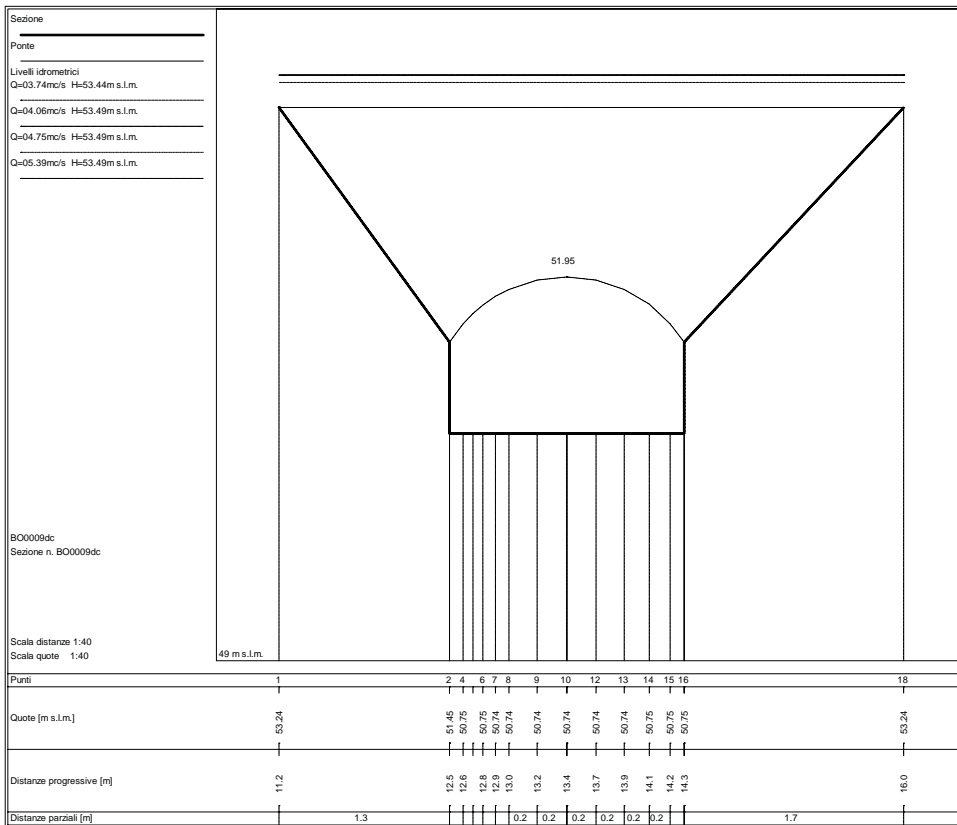

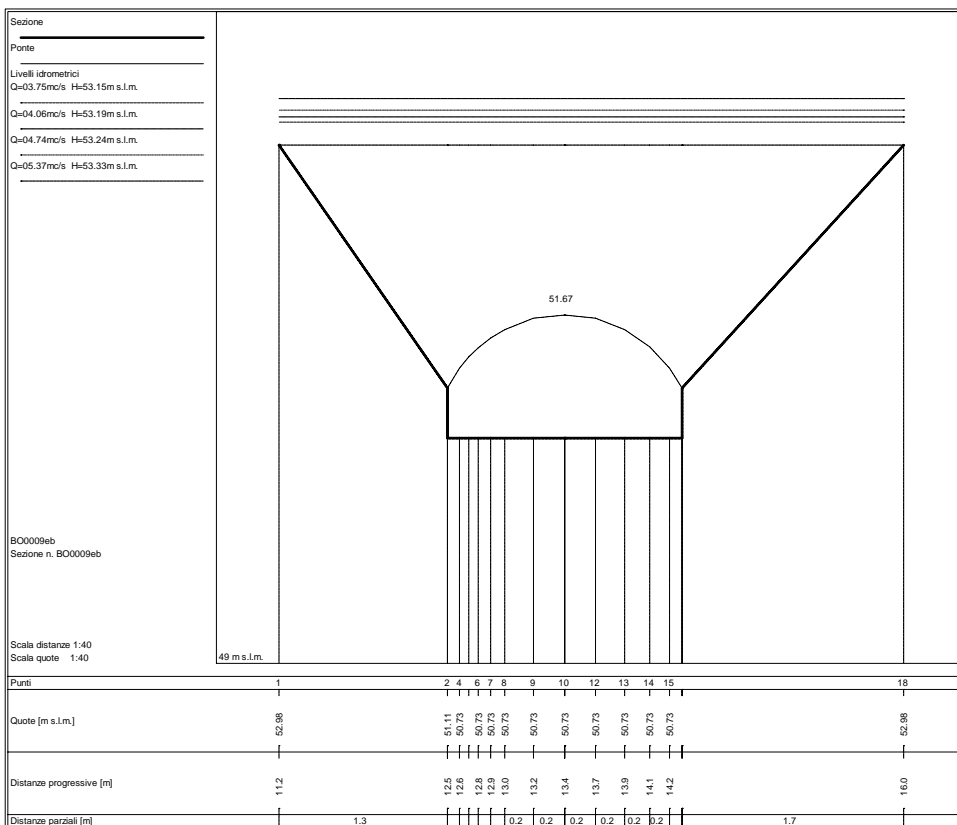
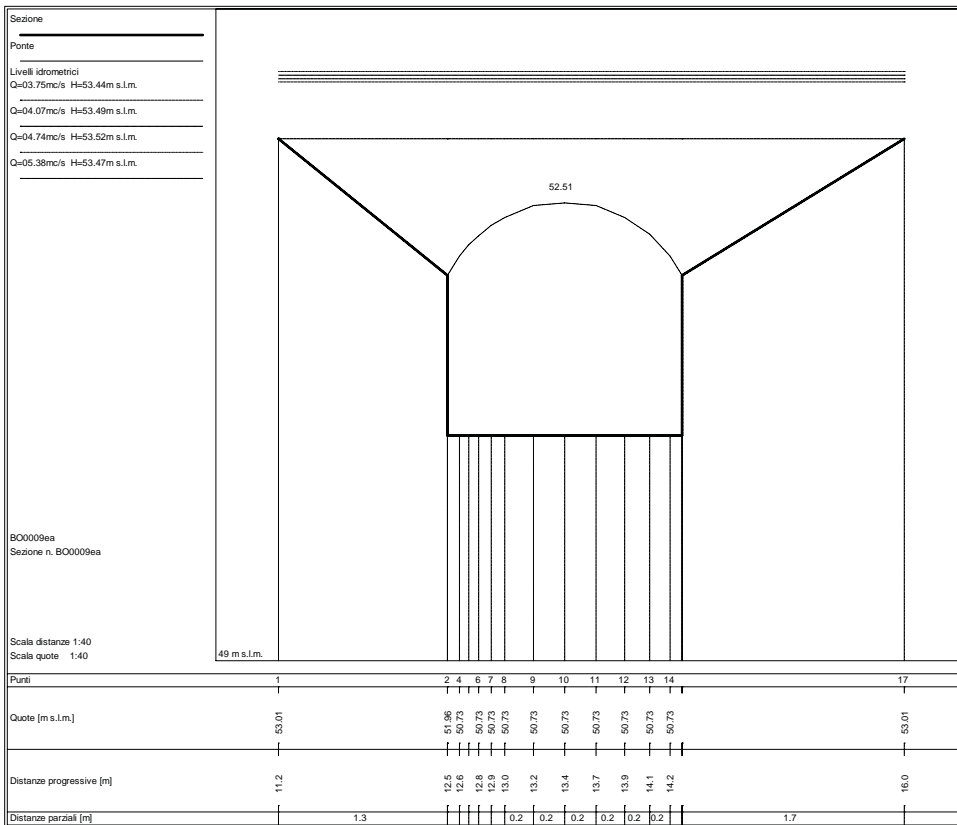

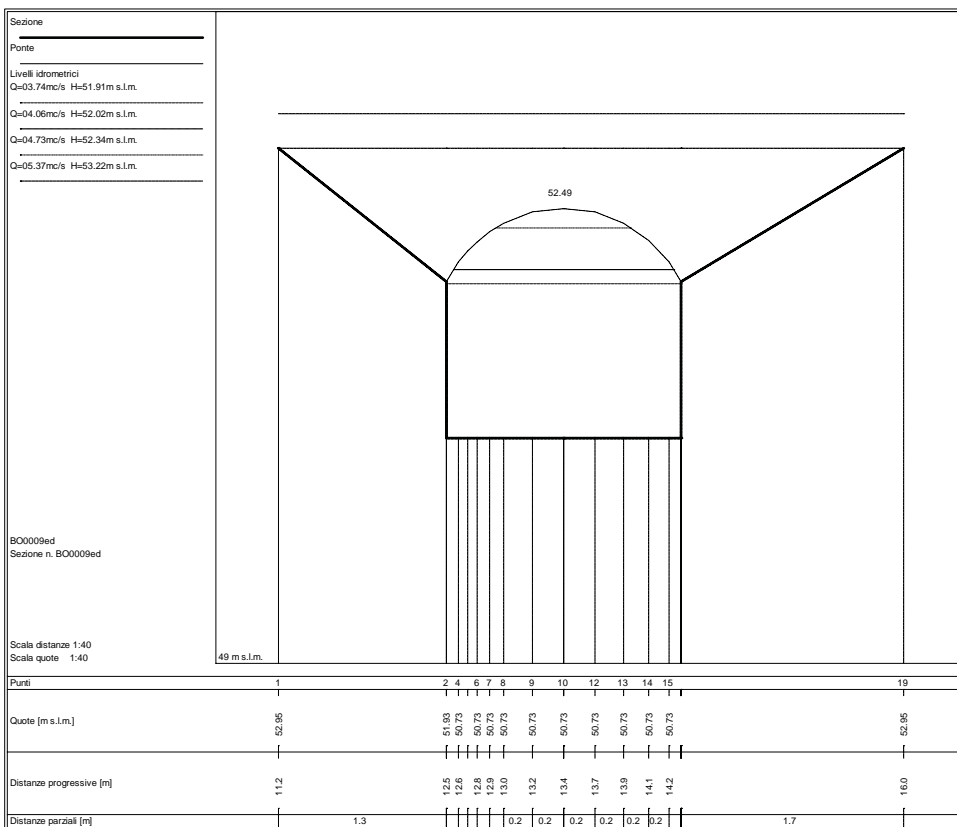
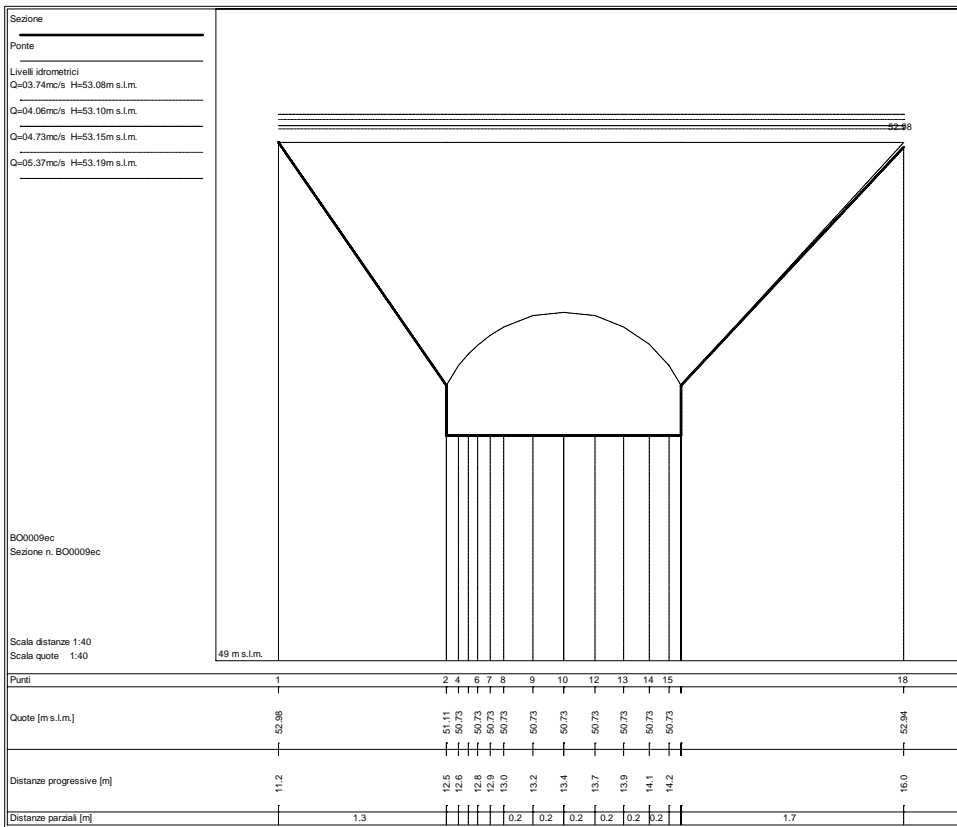

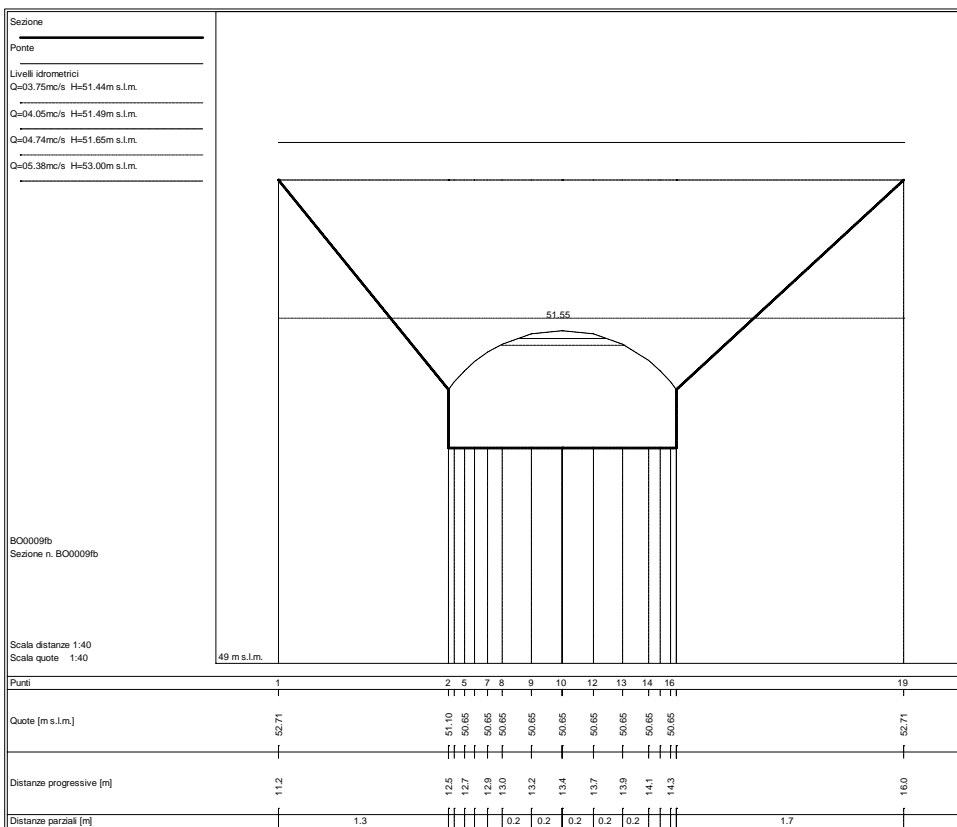
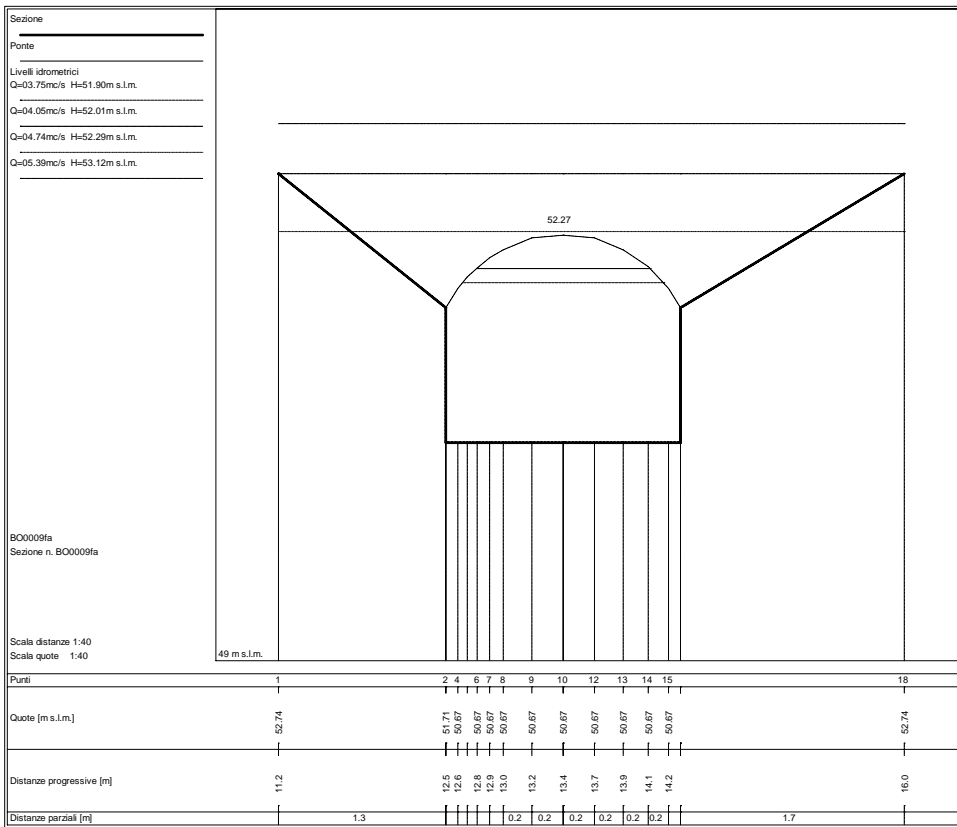

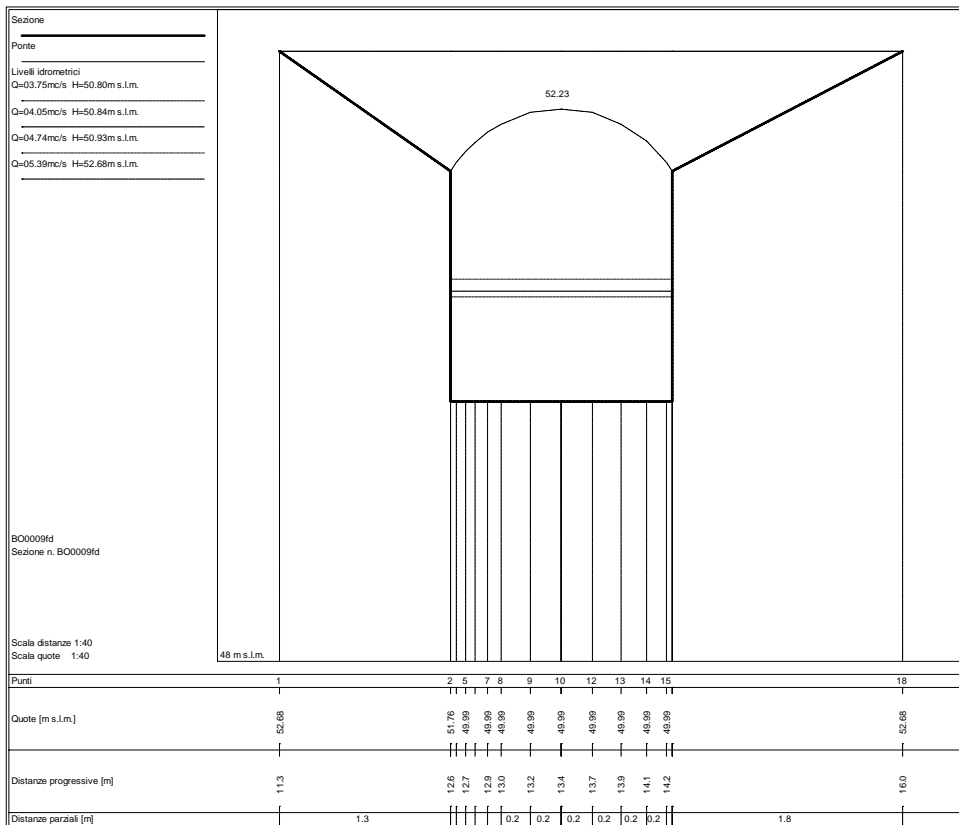
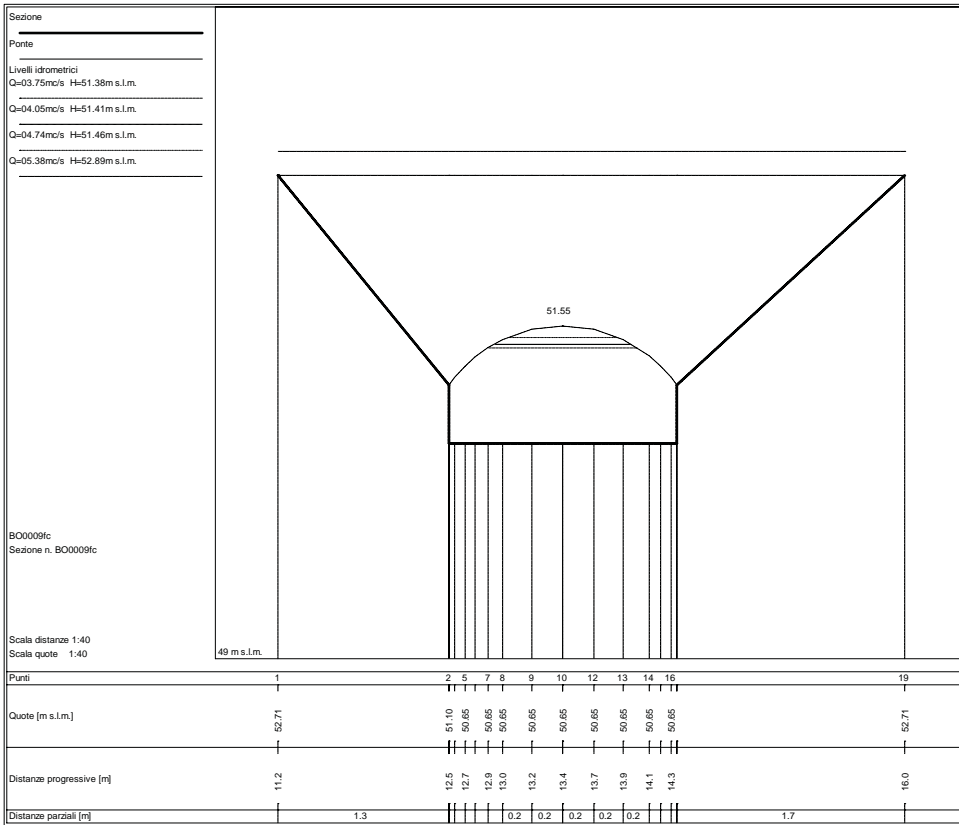

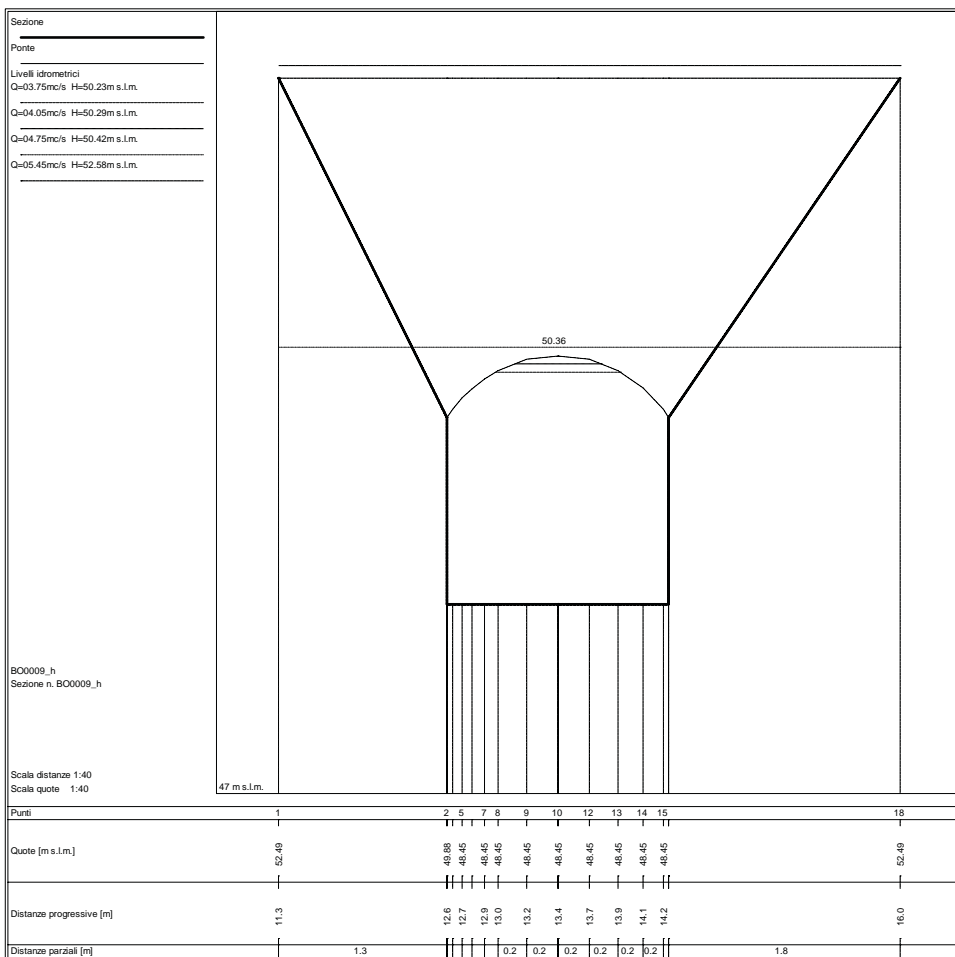
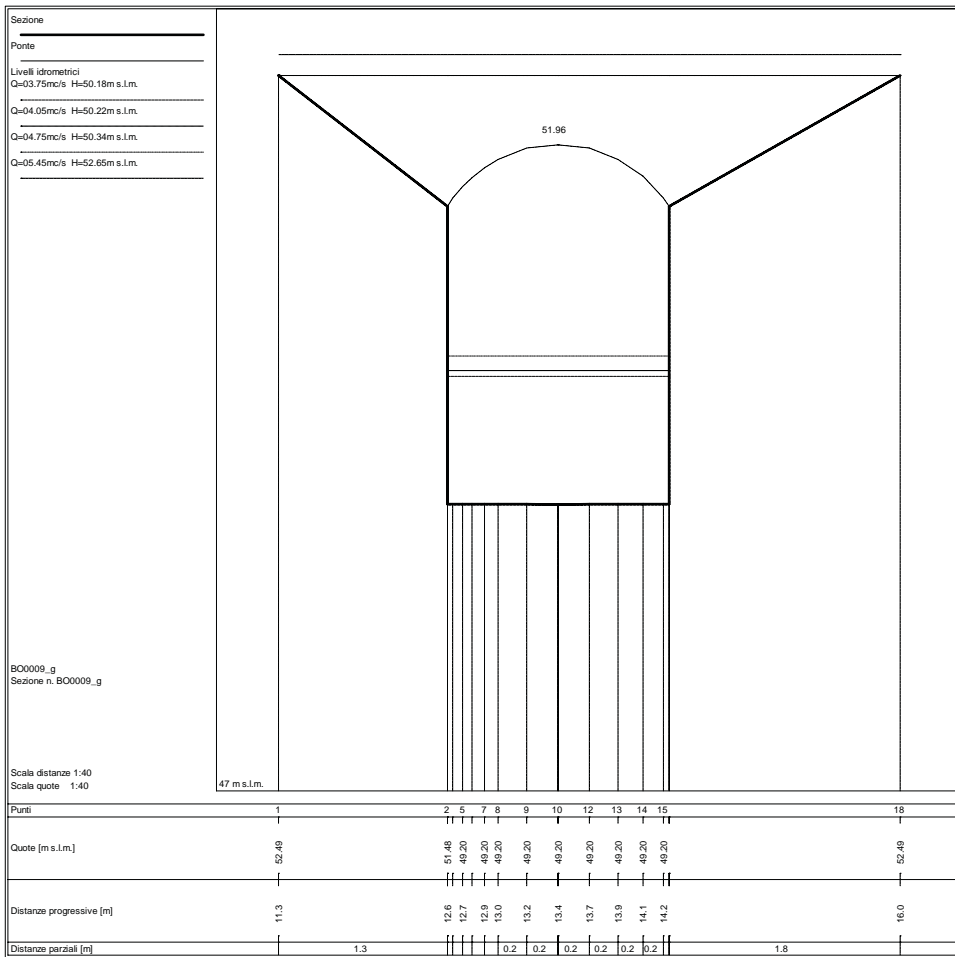

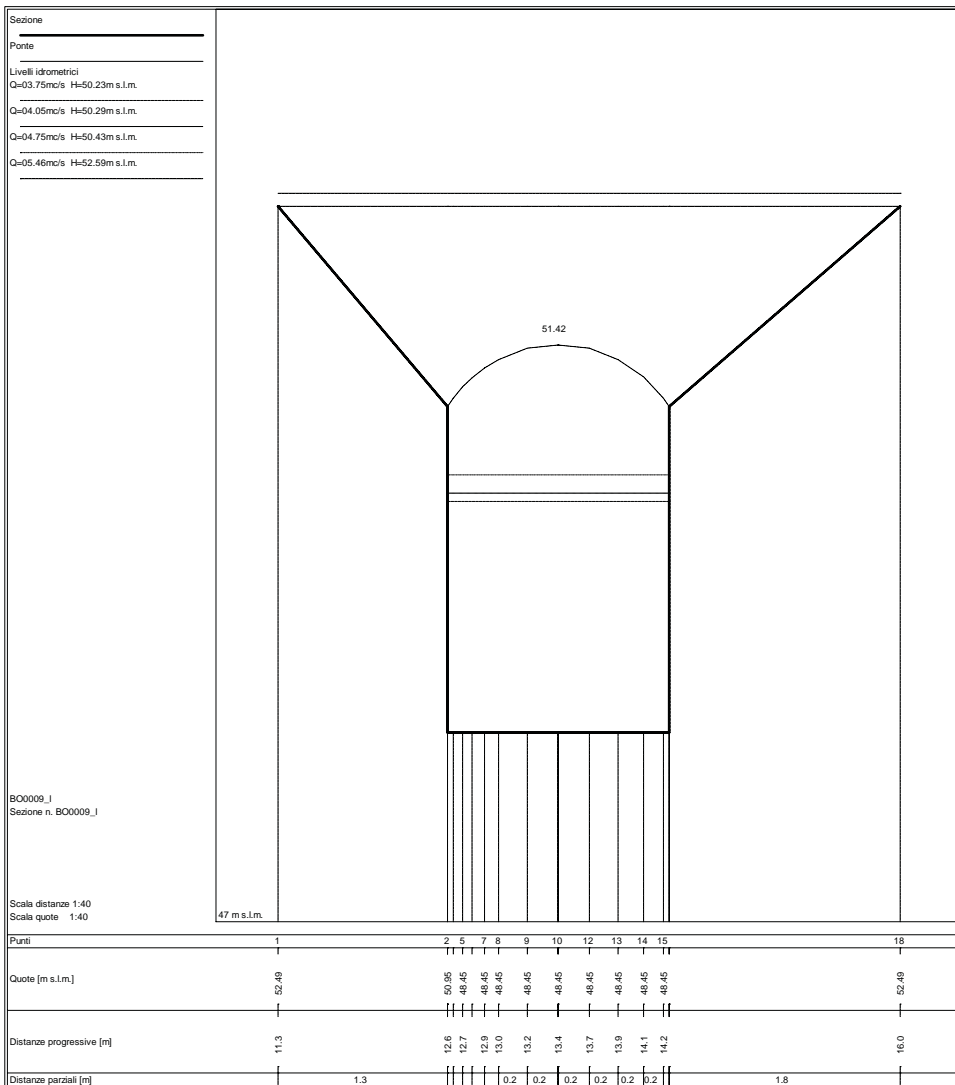
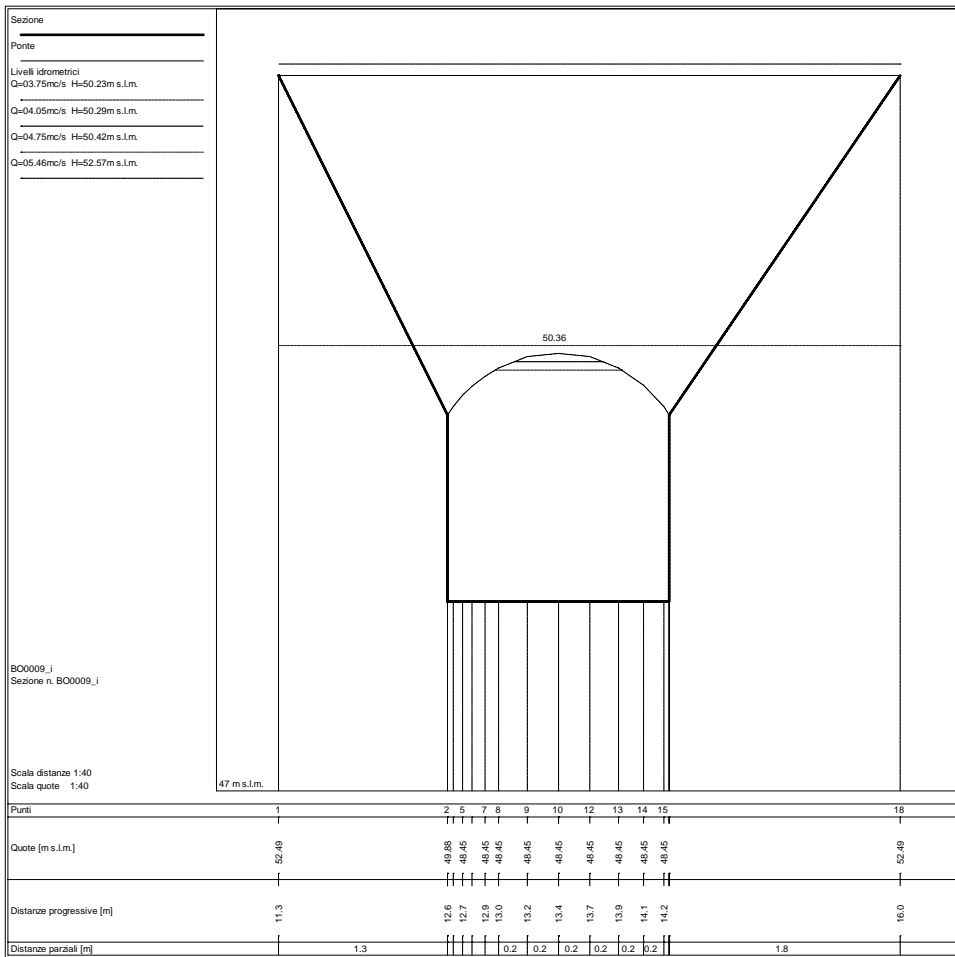

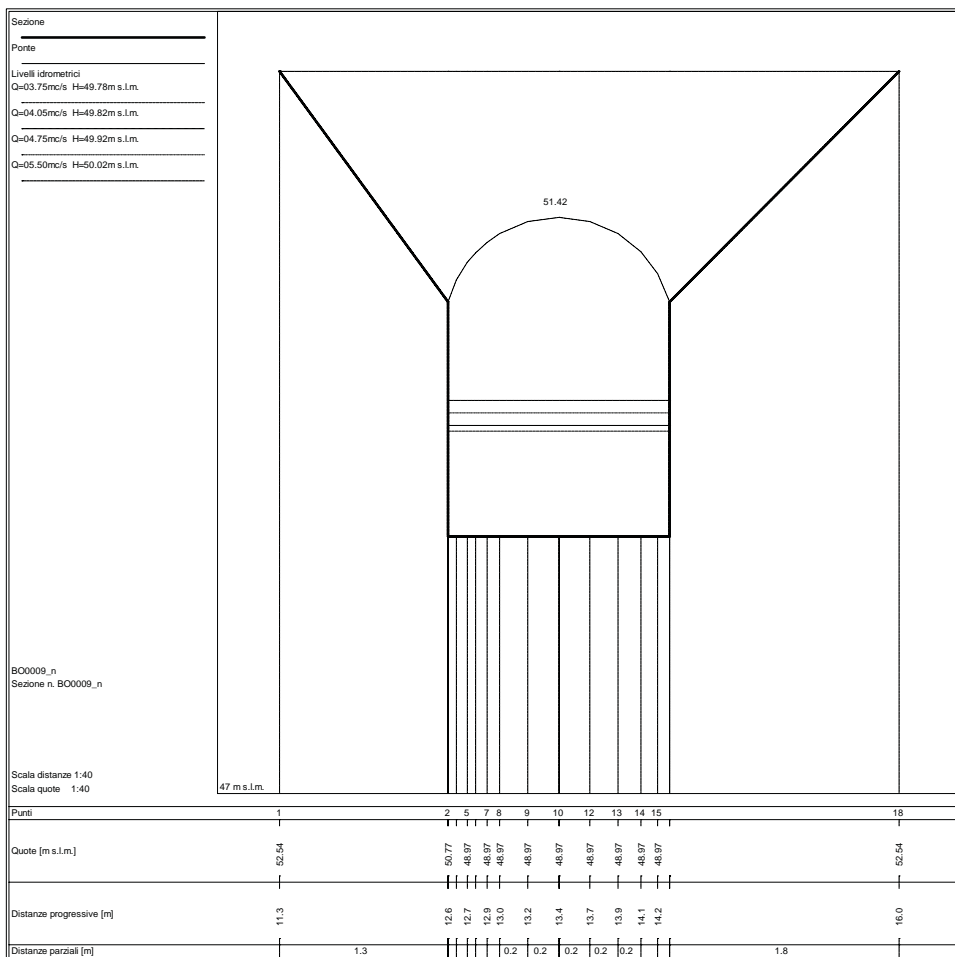
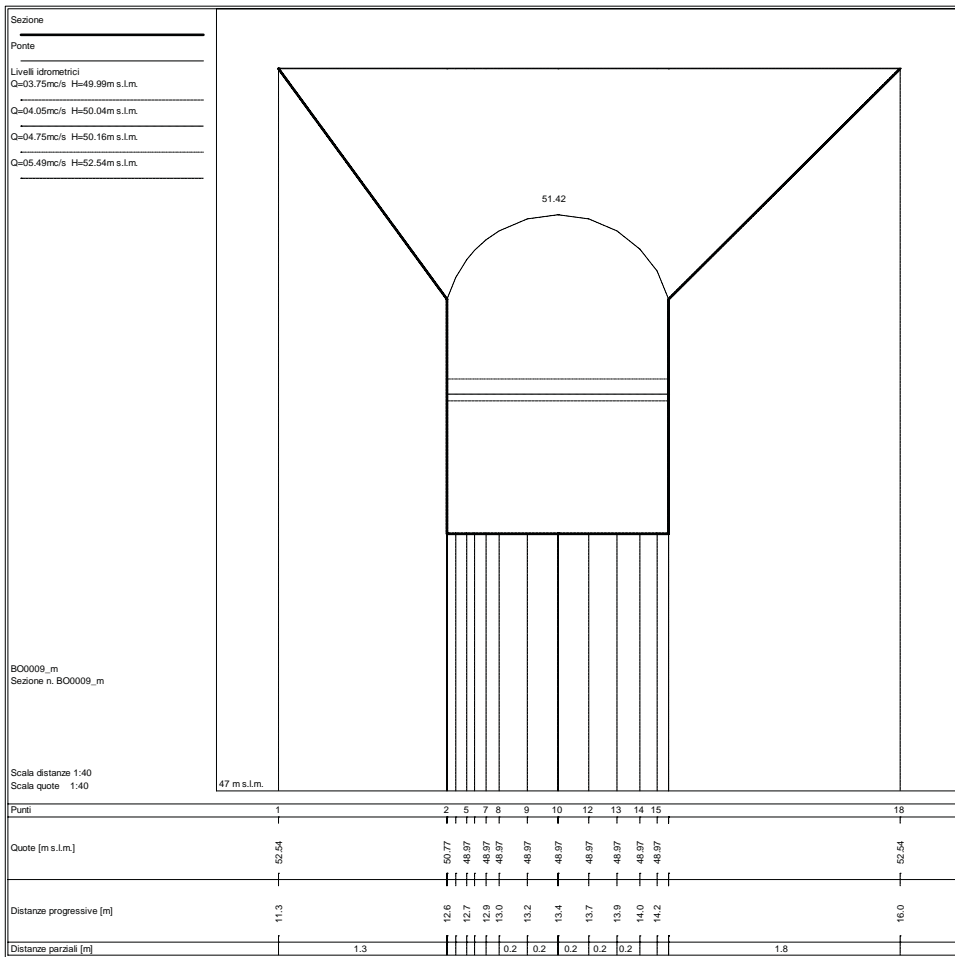

STATO ATTUALE

Sezioni fluviali fosso Castellazzo

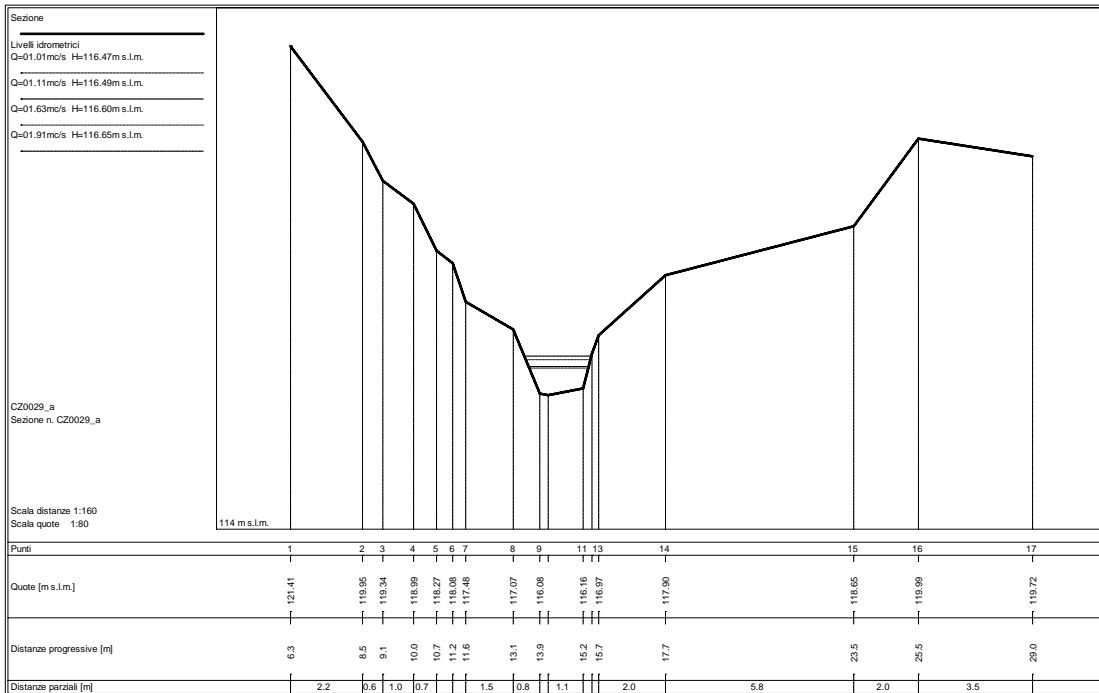
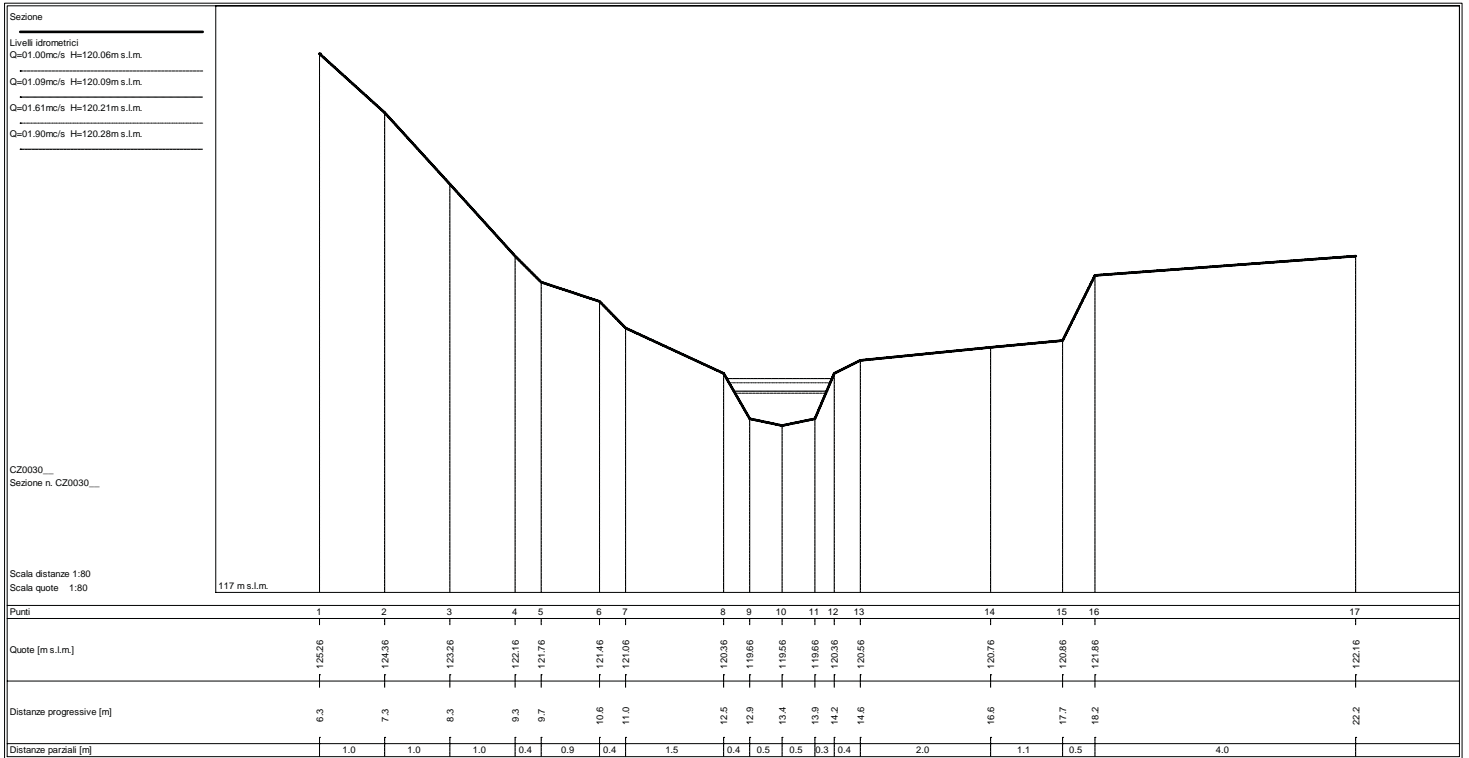

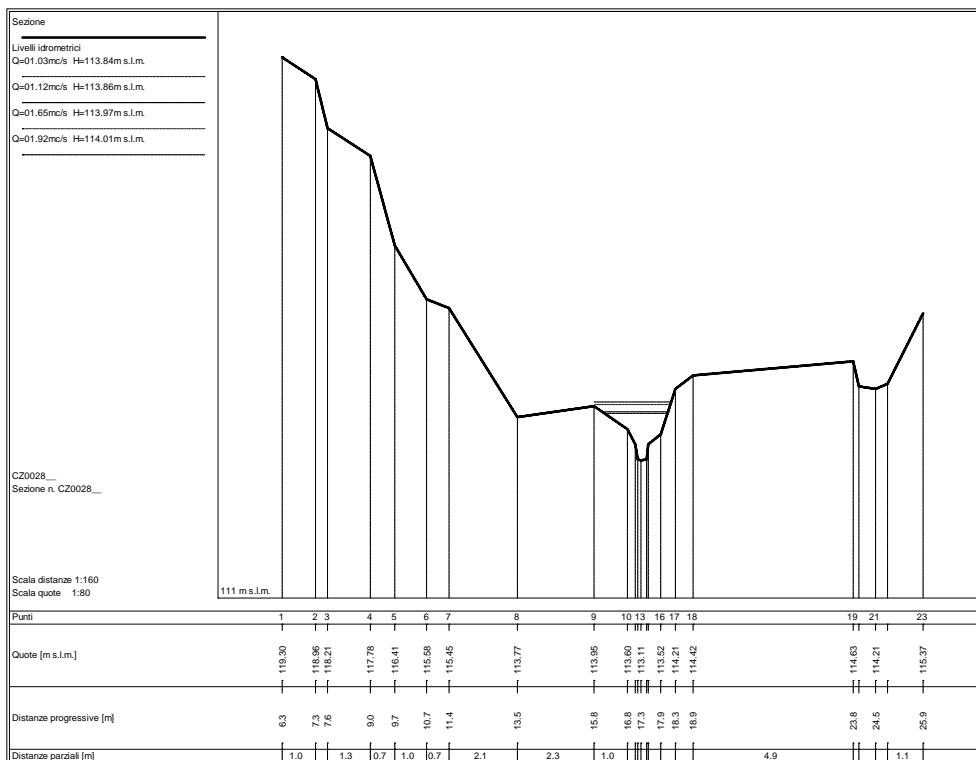
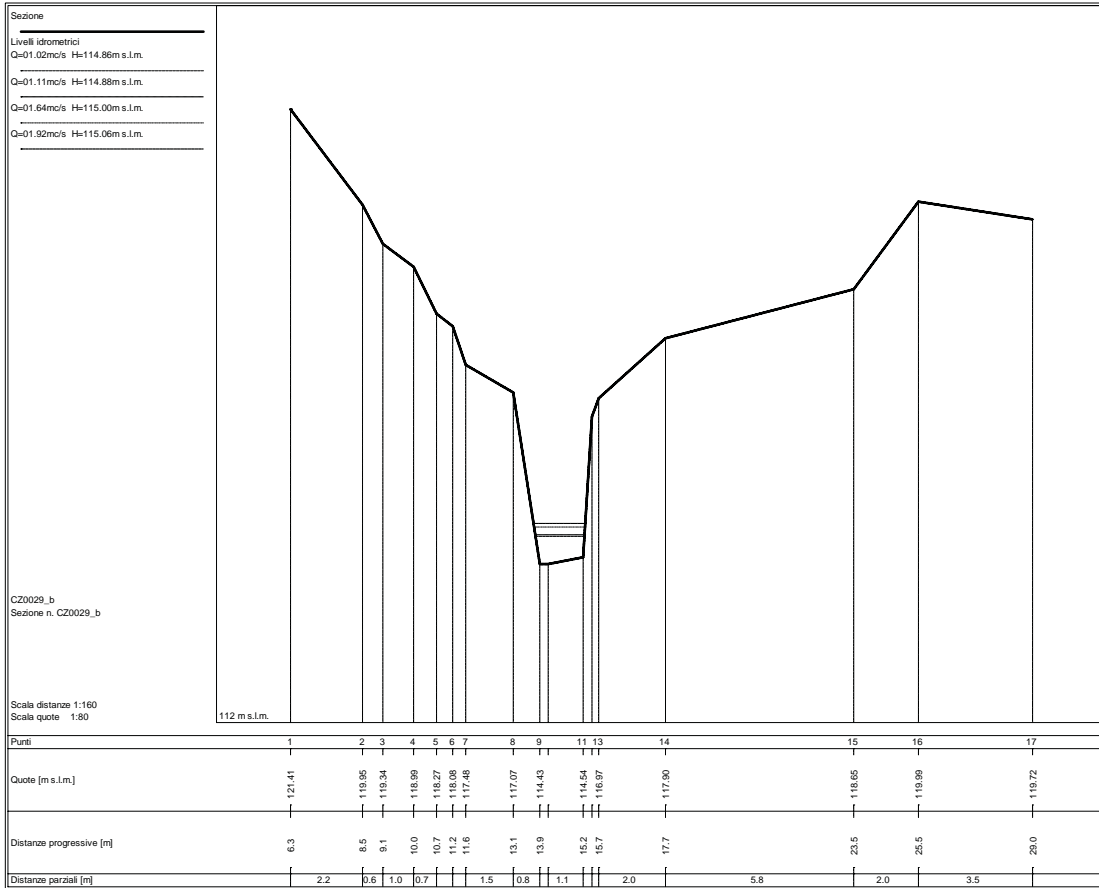

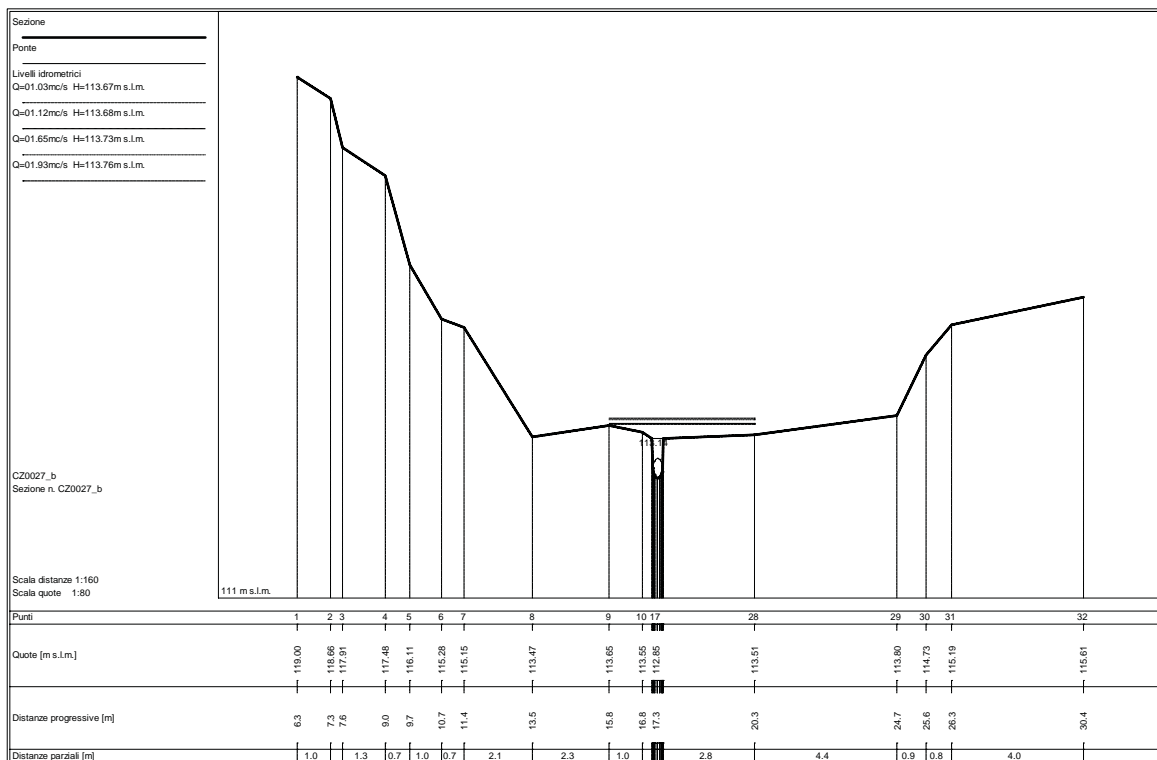
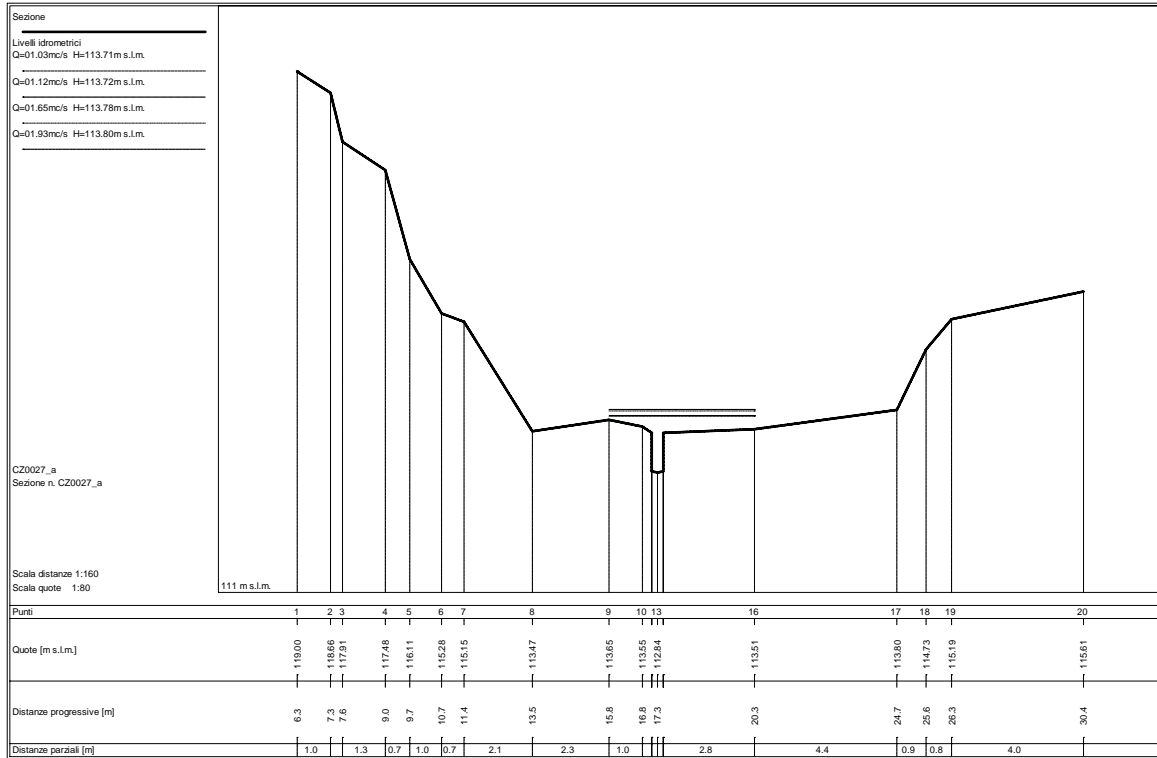

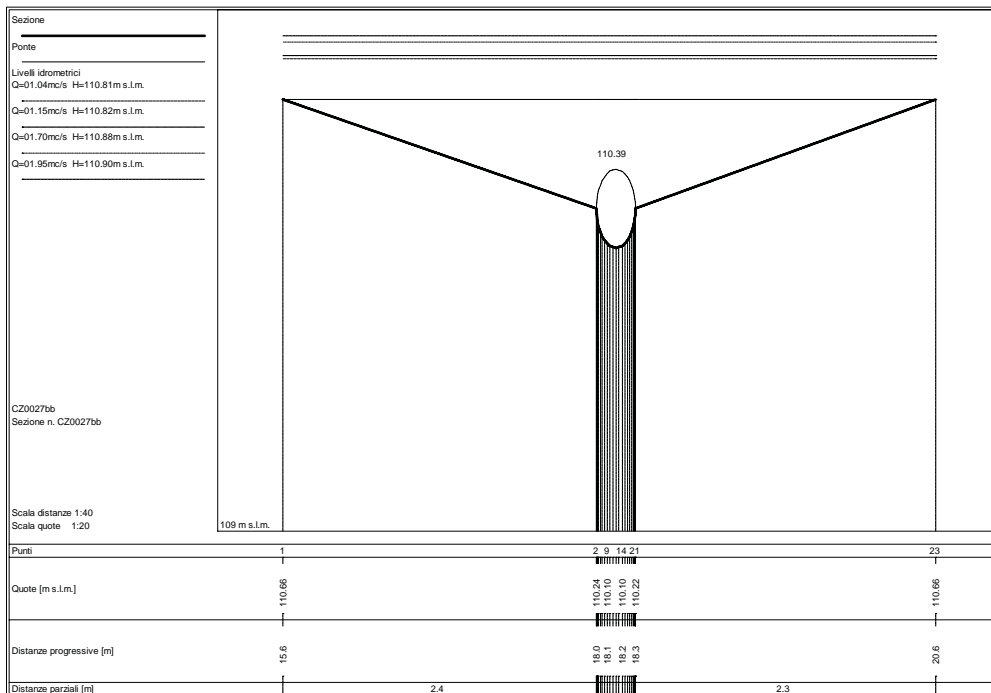
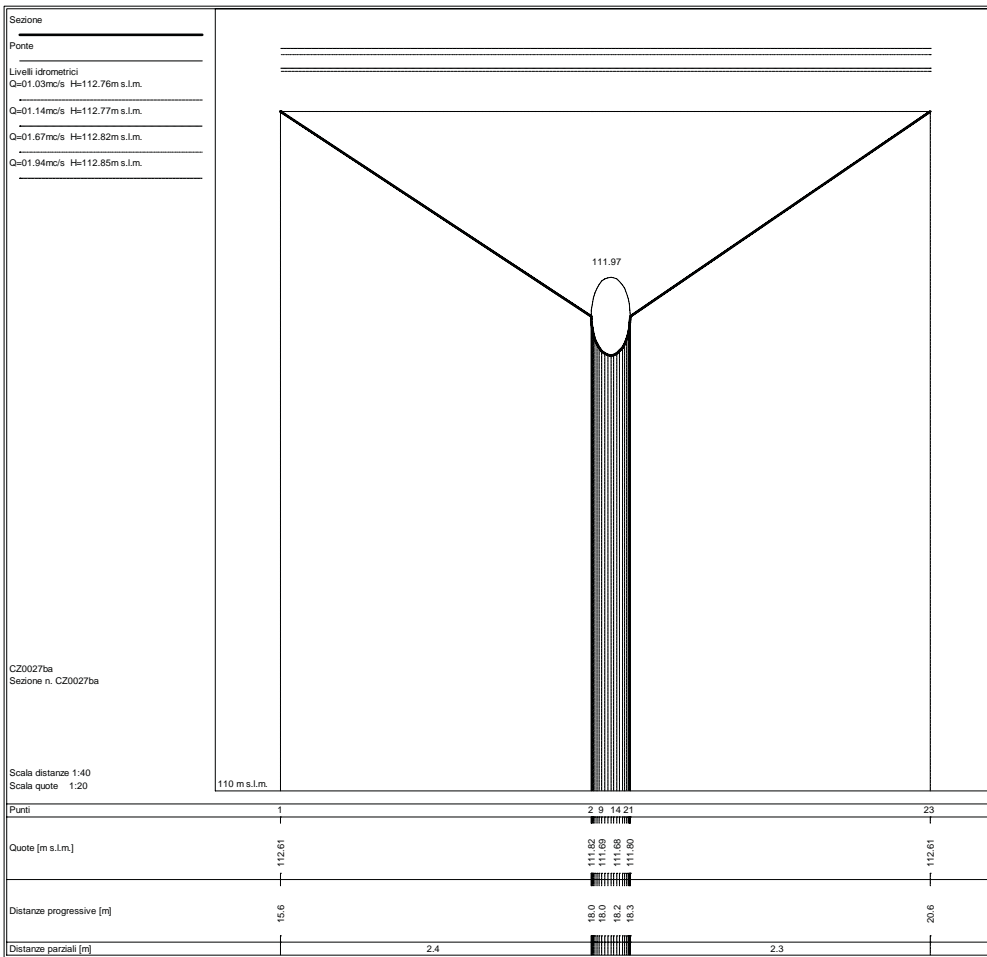

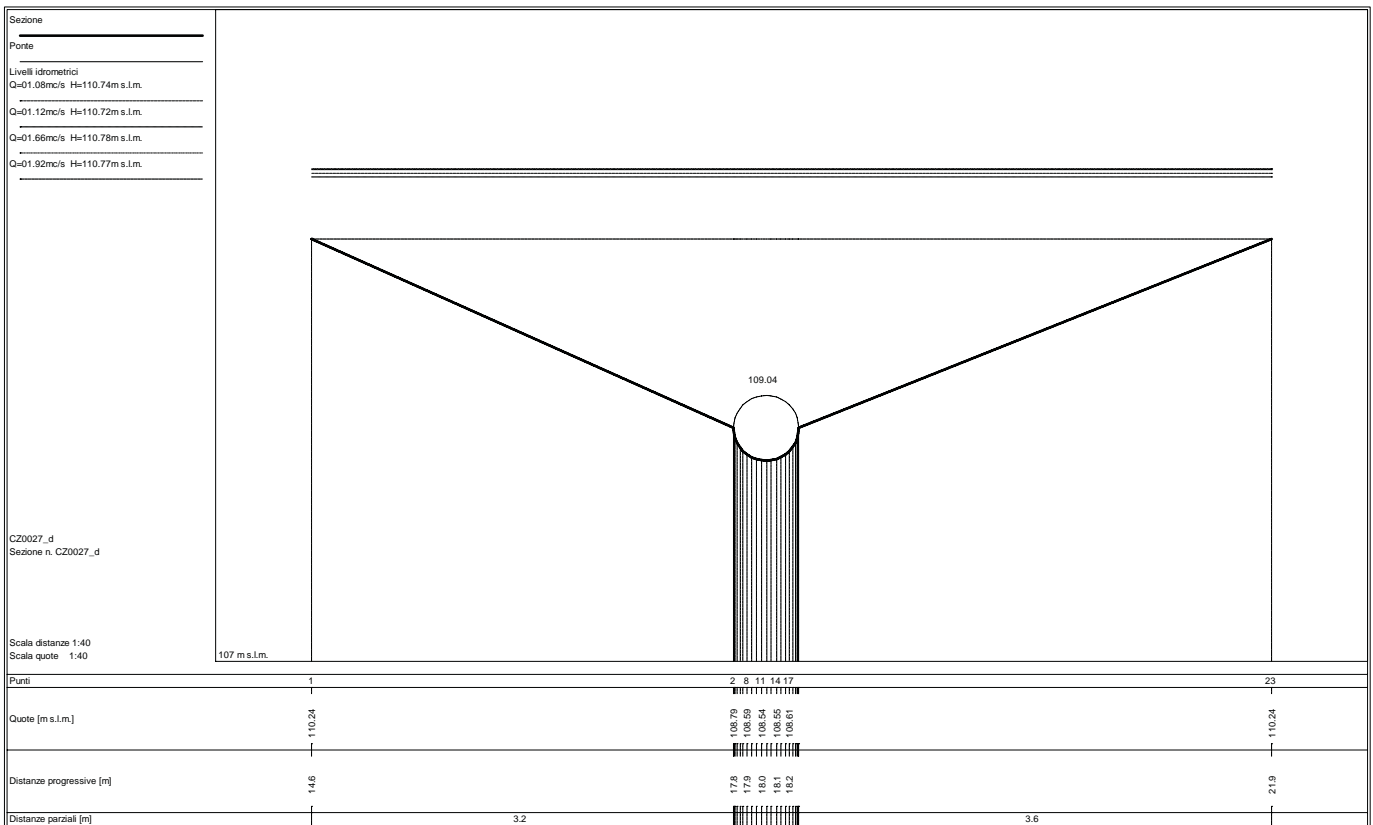
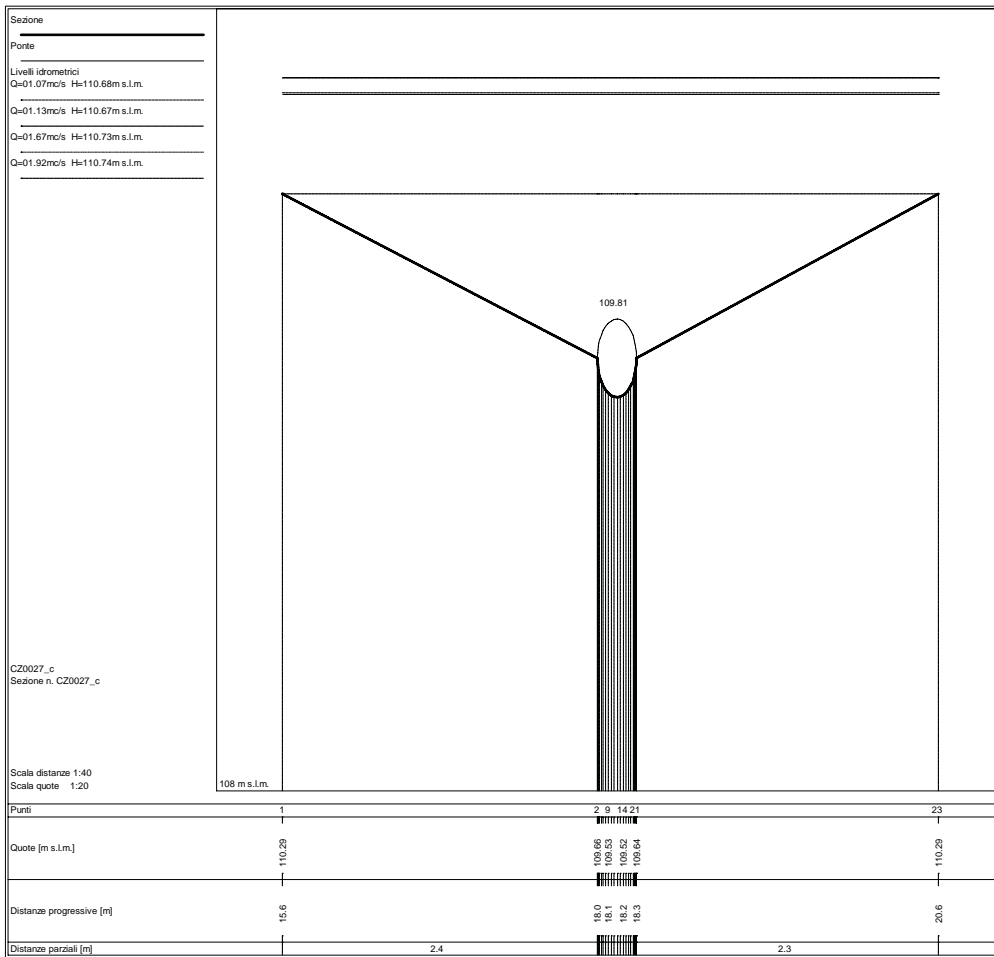

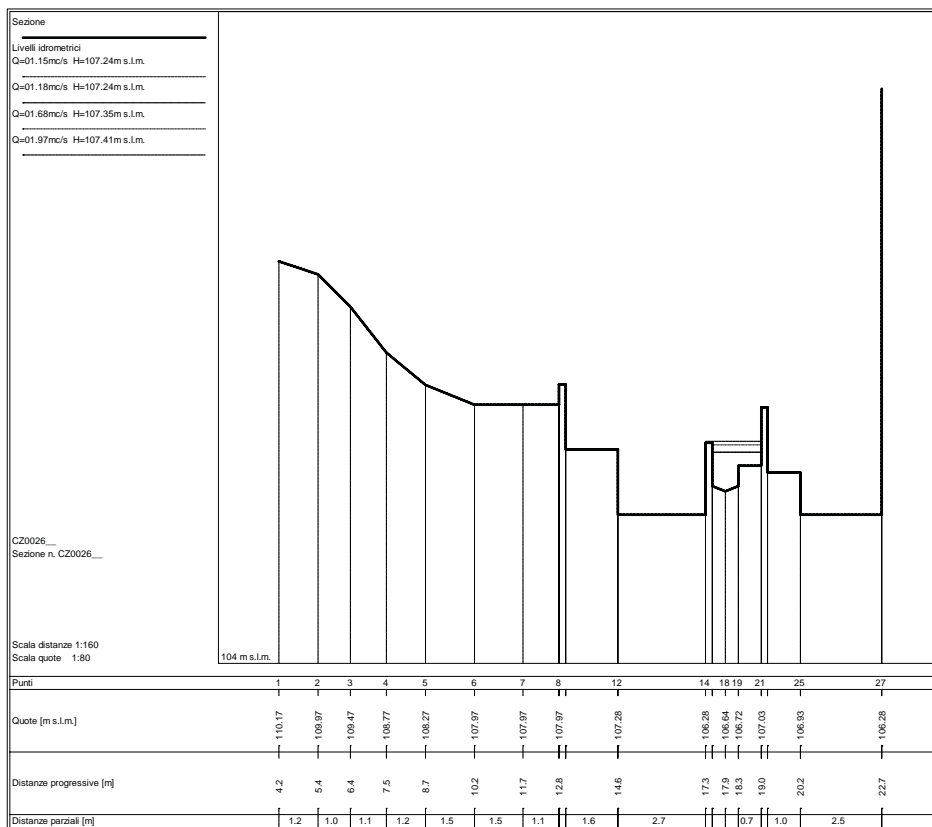
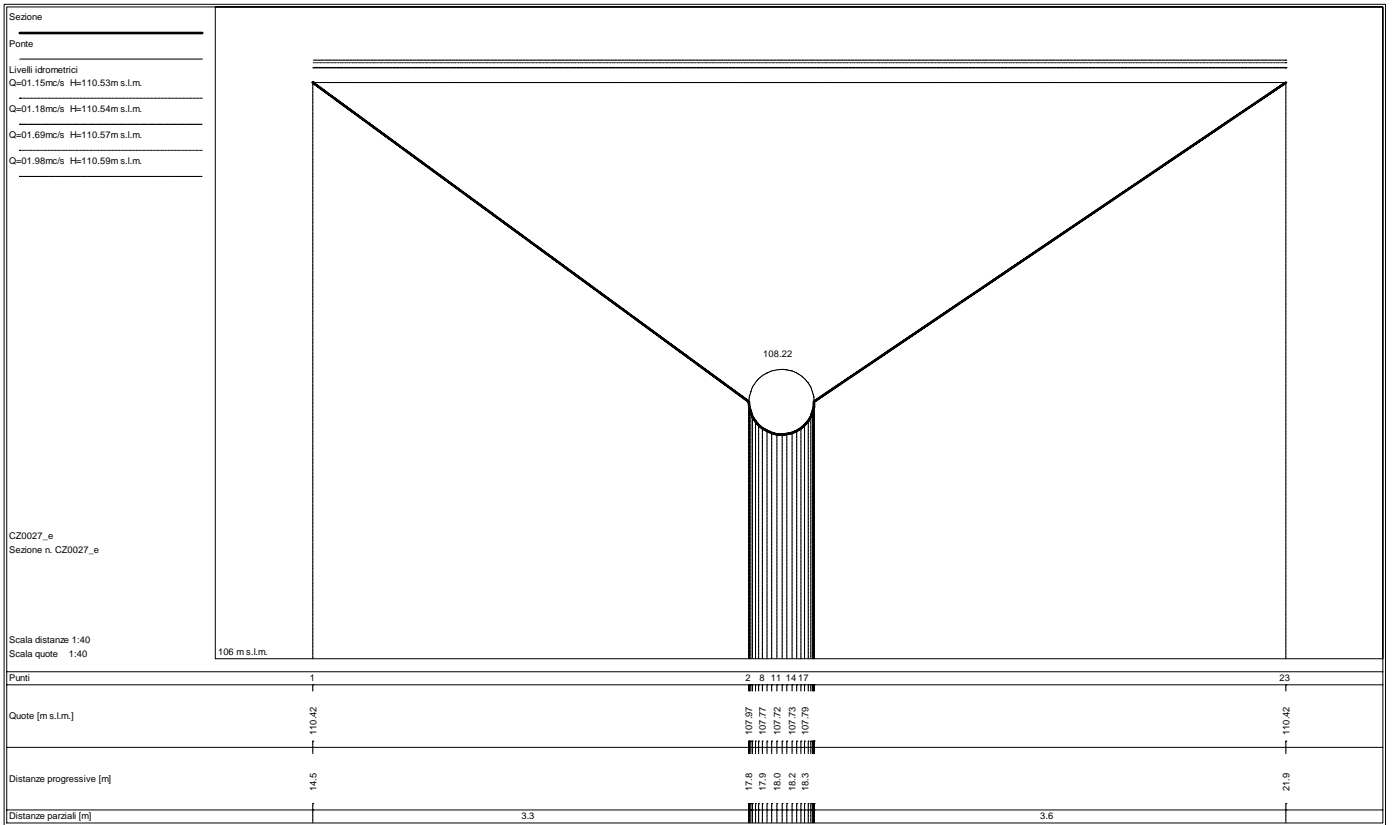

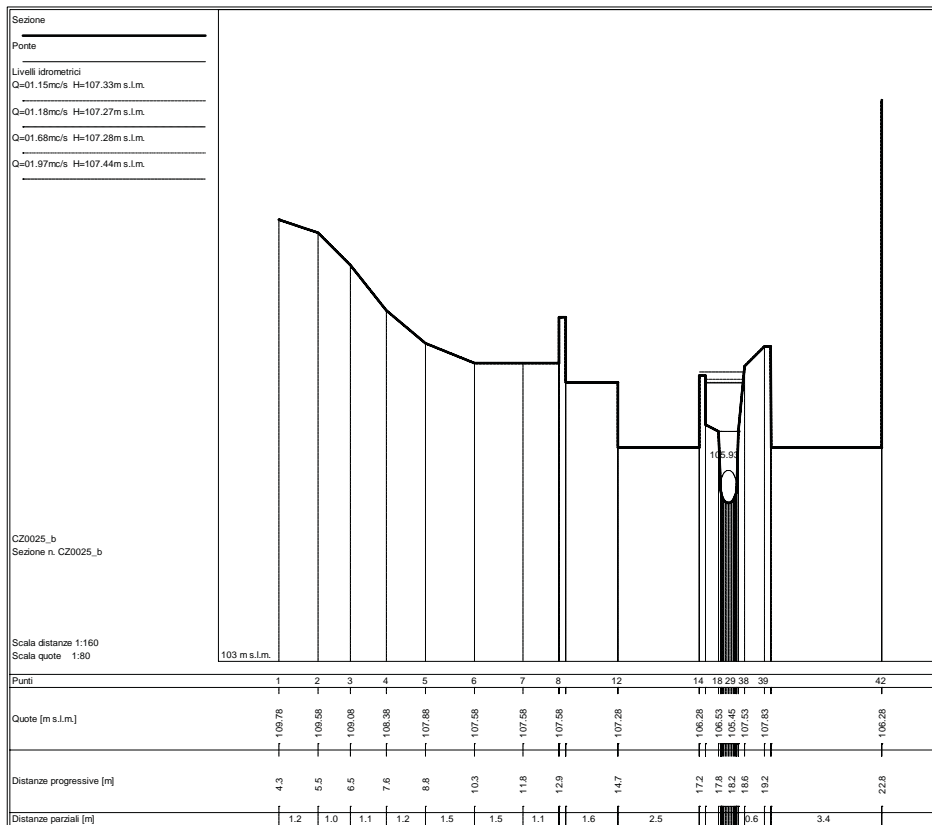
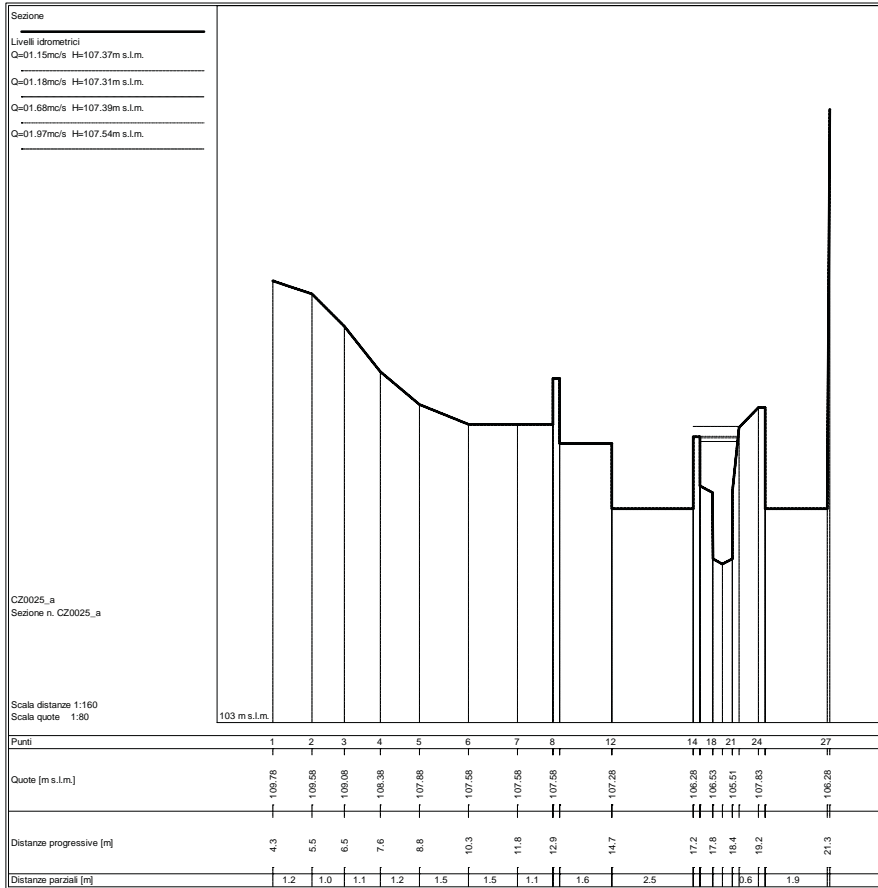

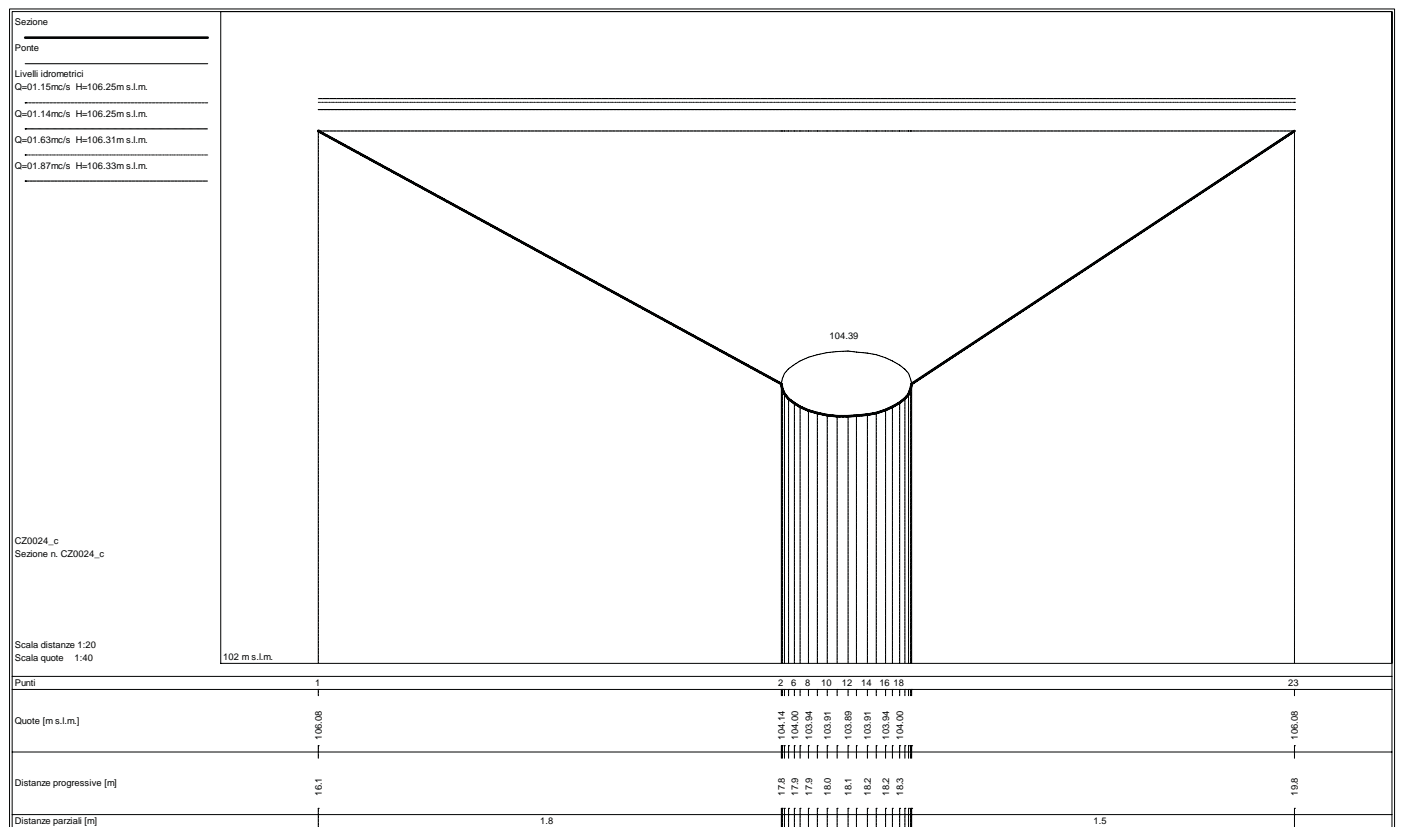
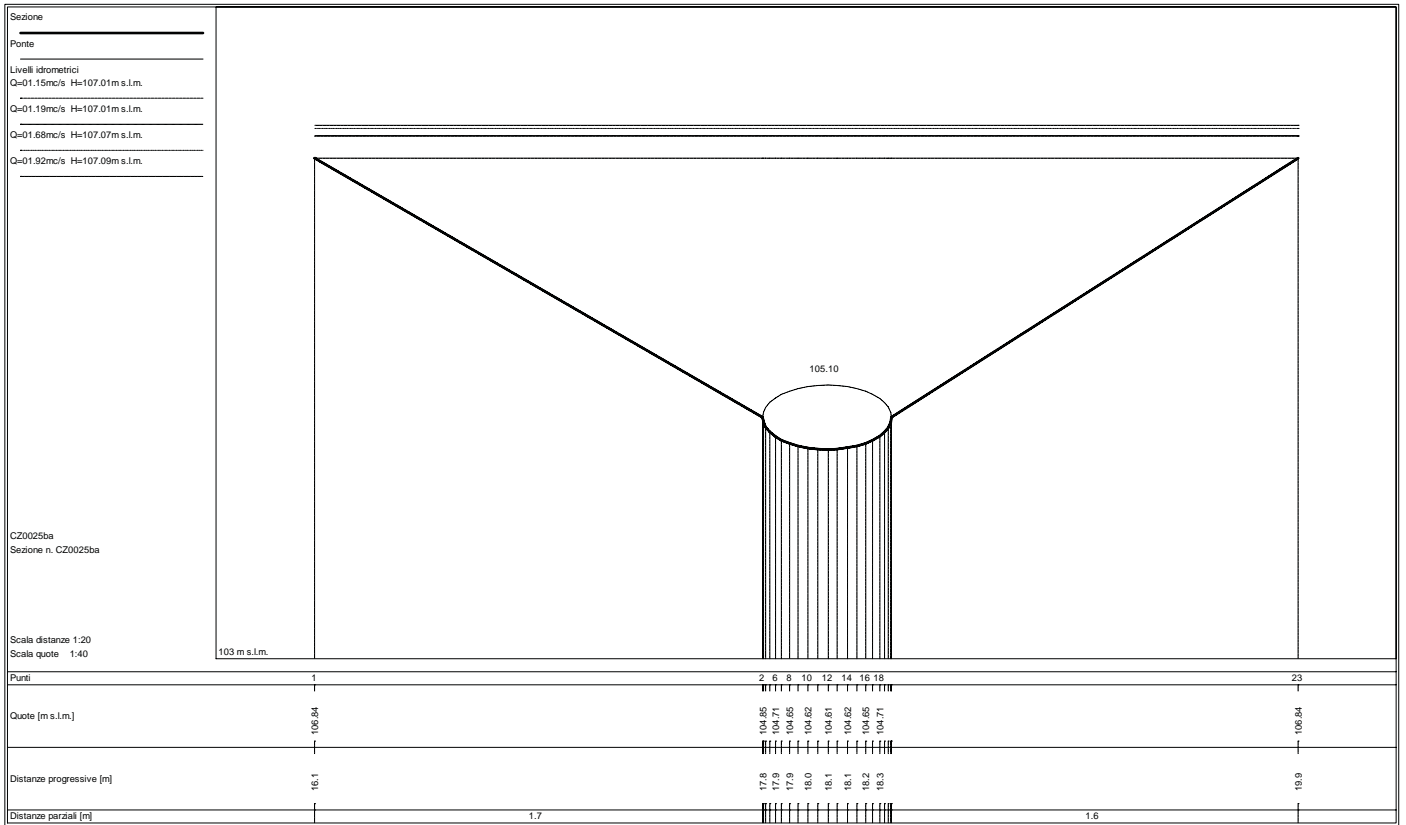

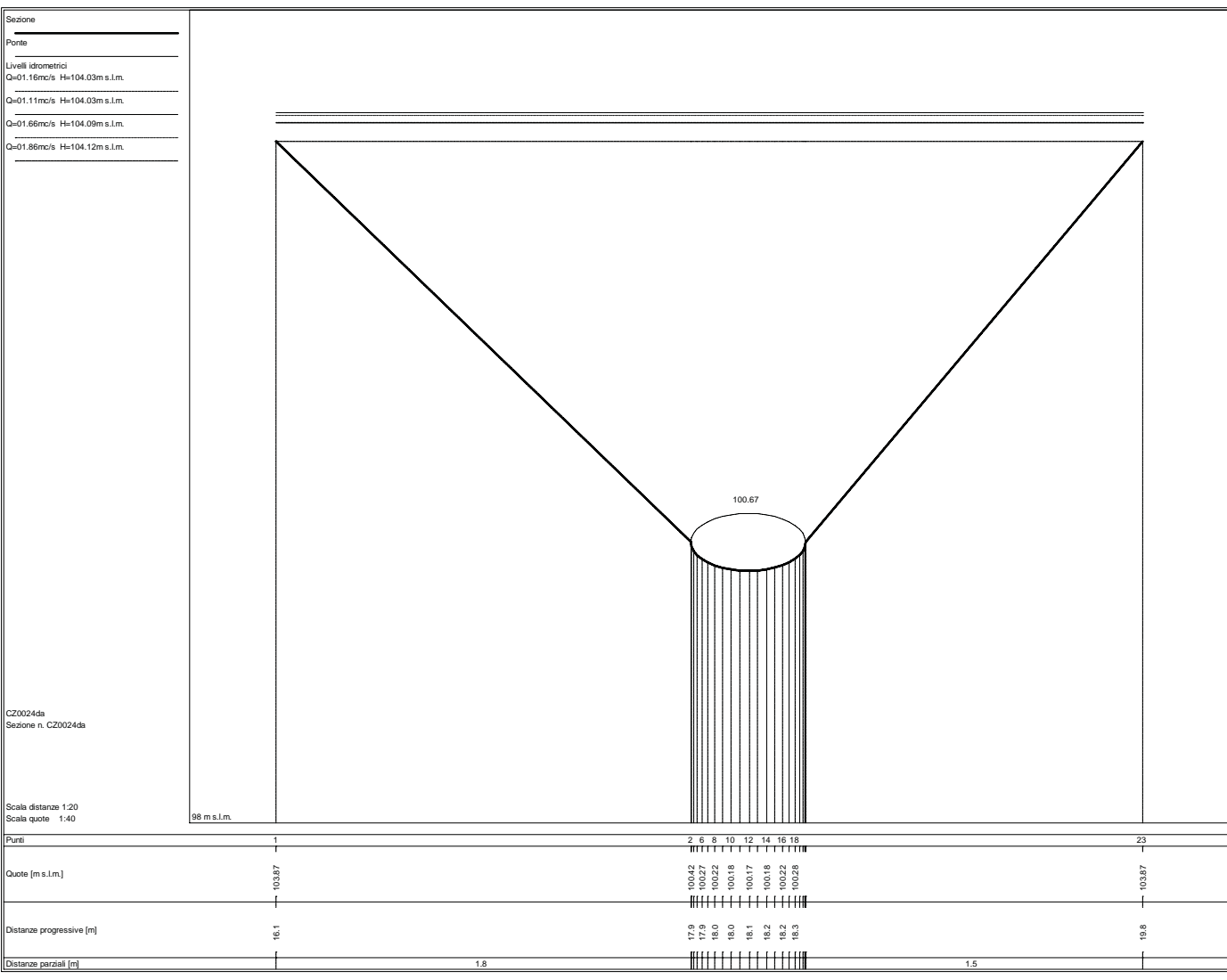
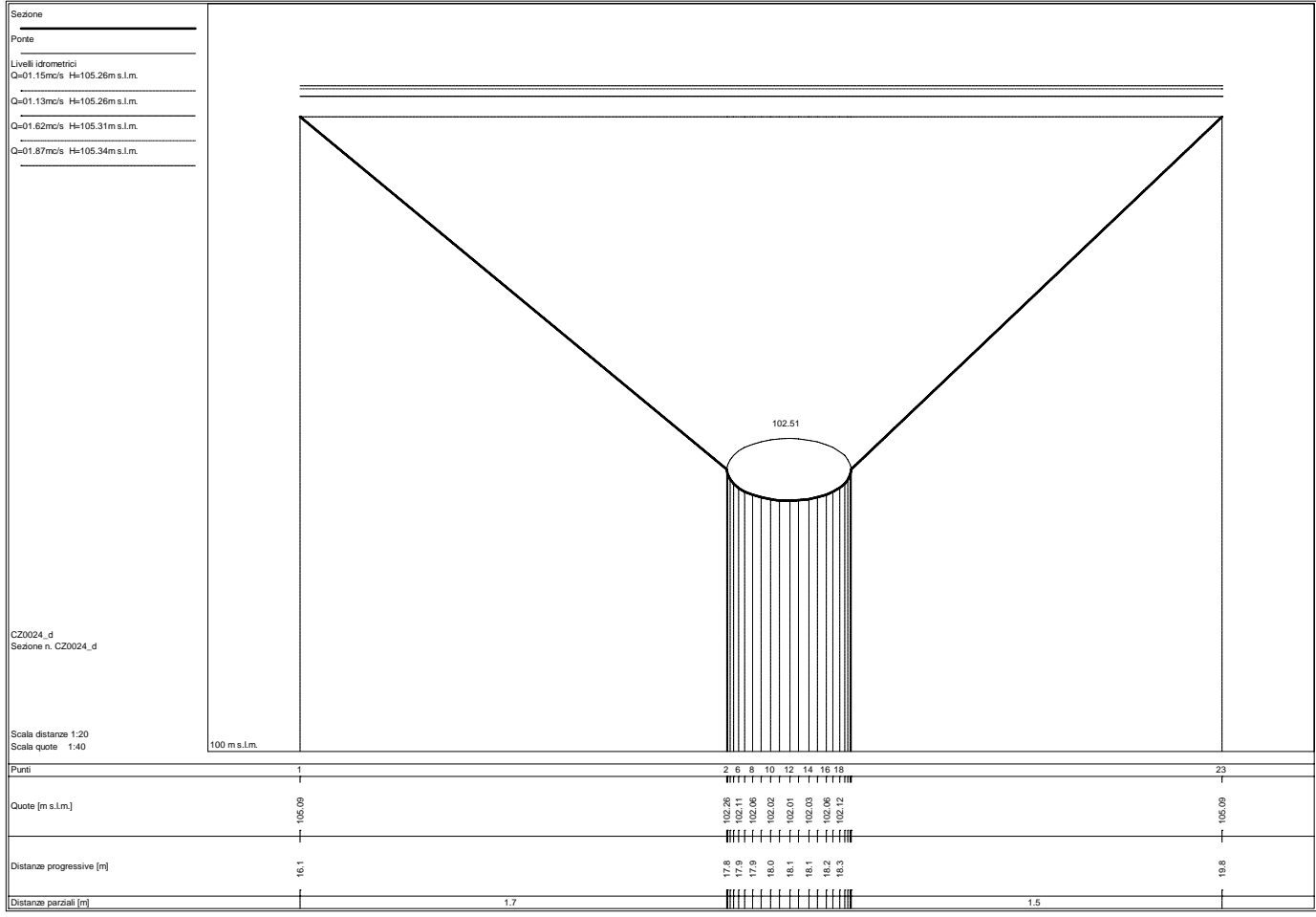

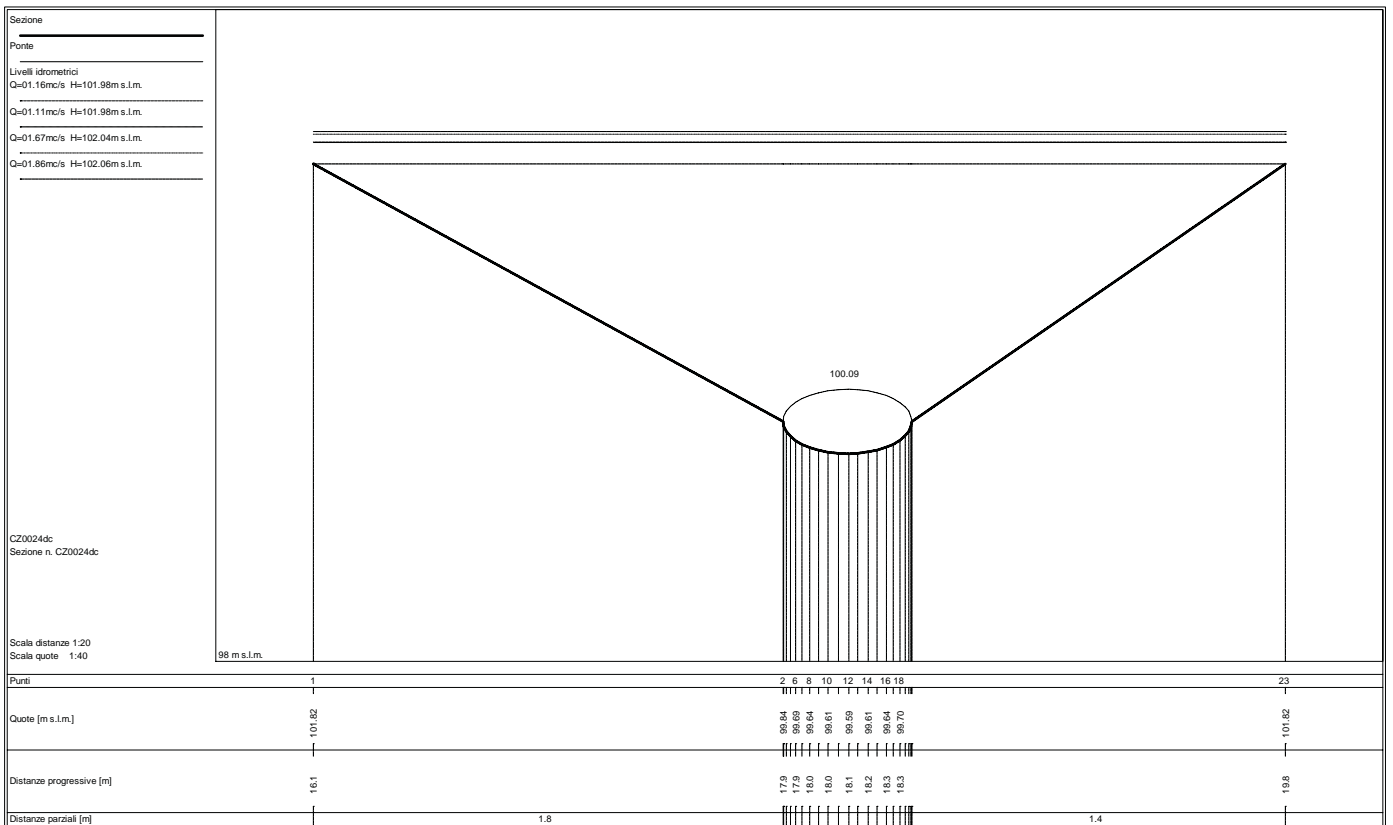
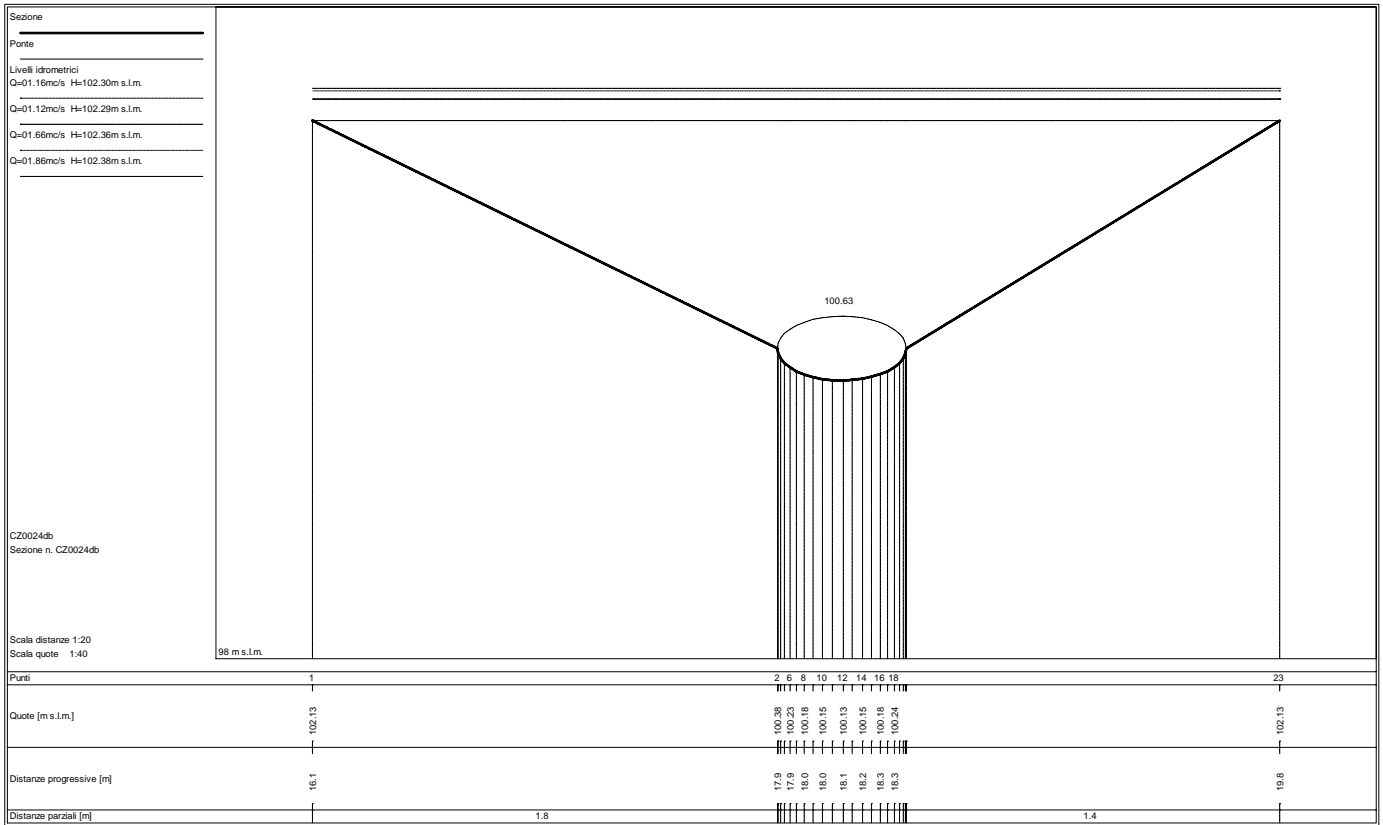

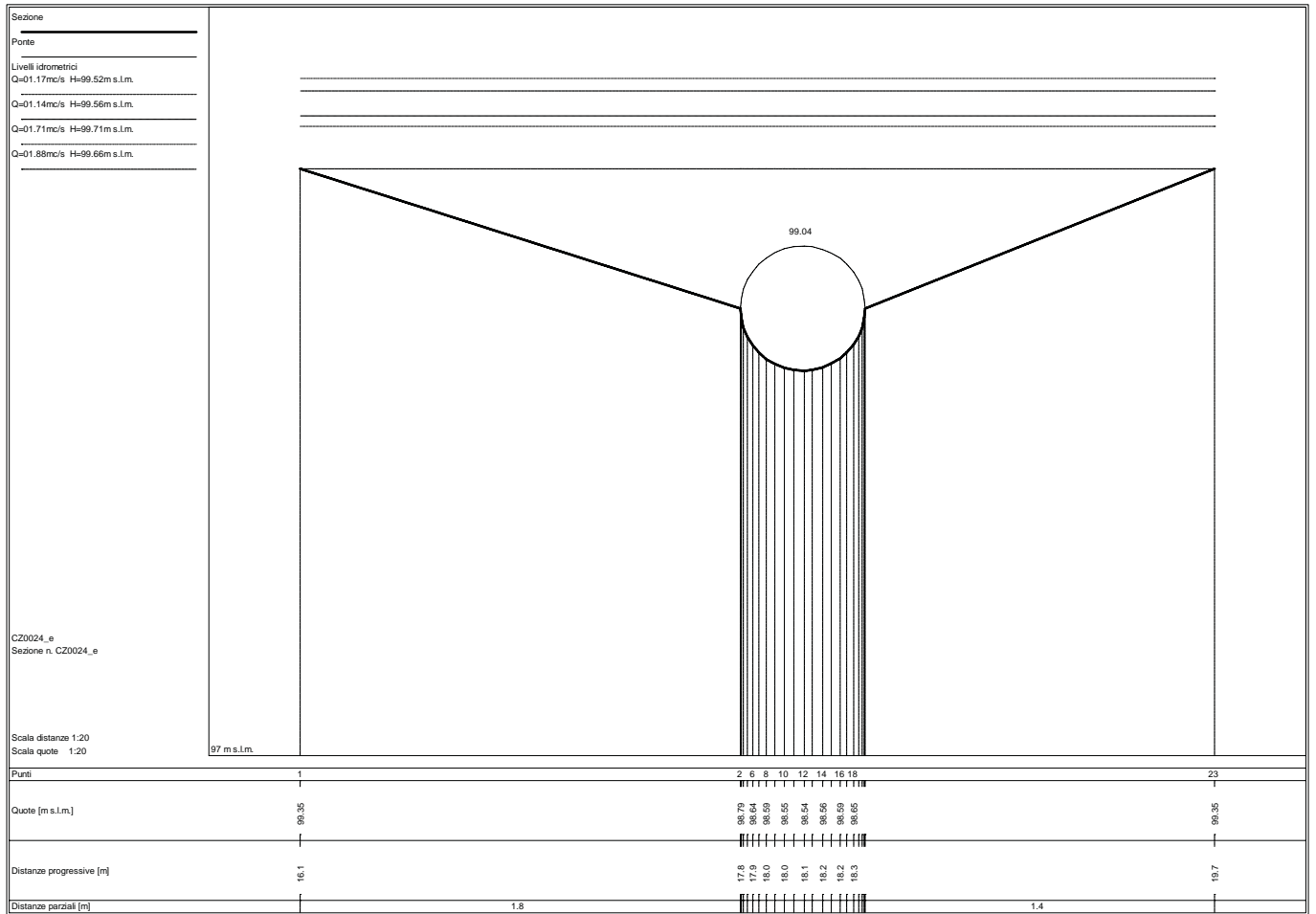
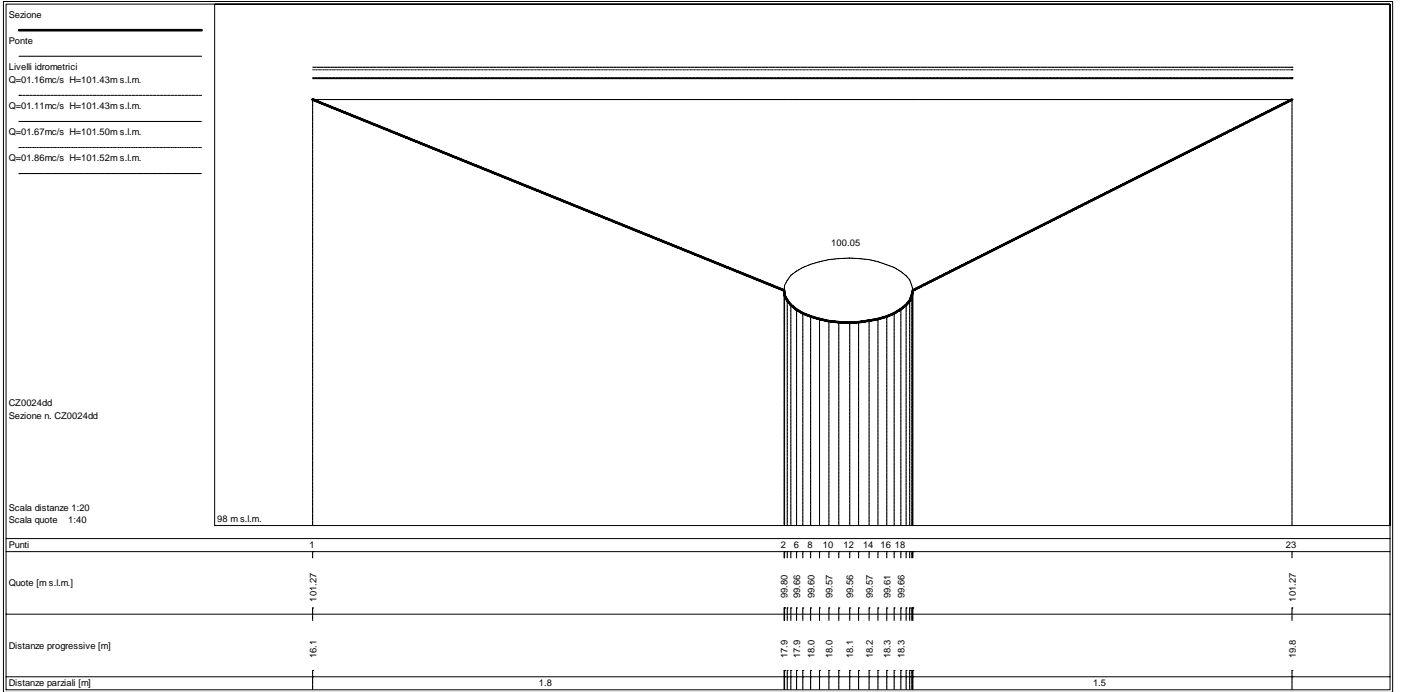

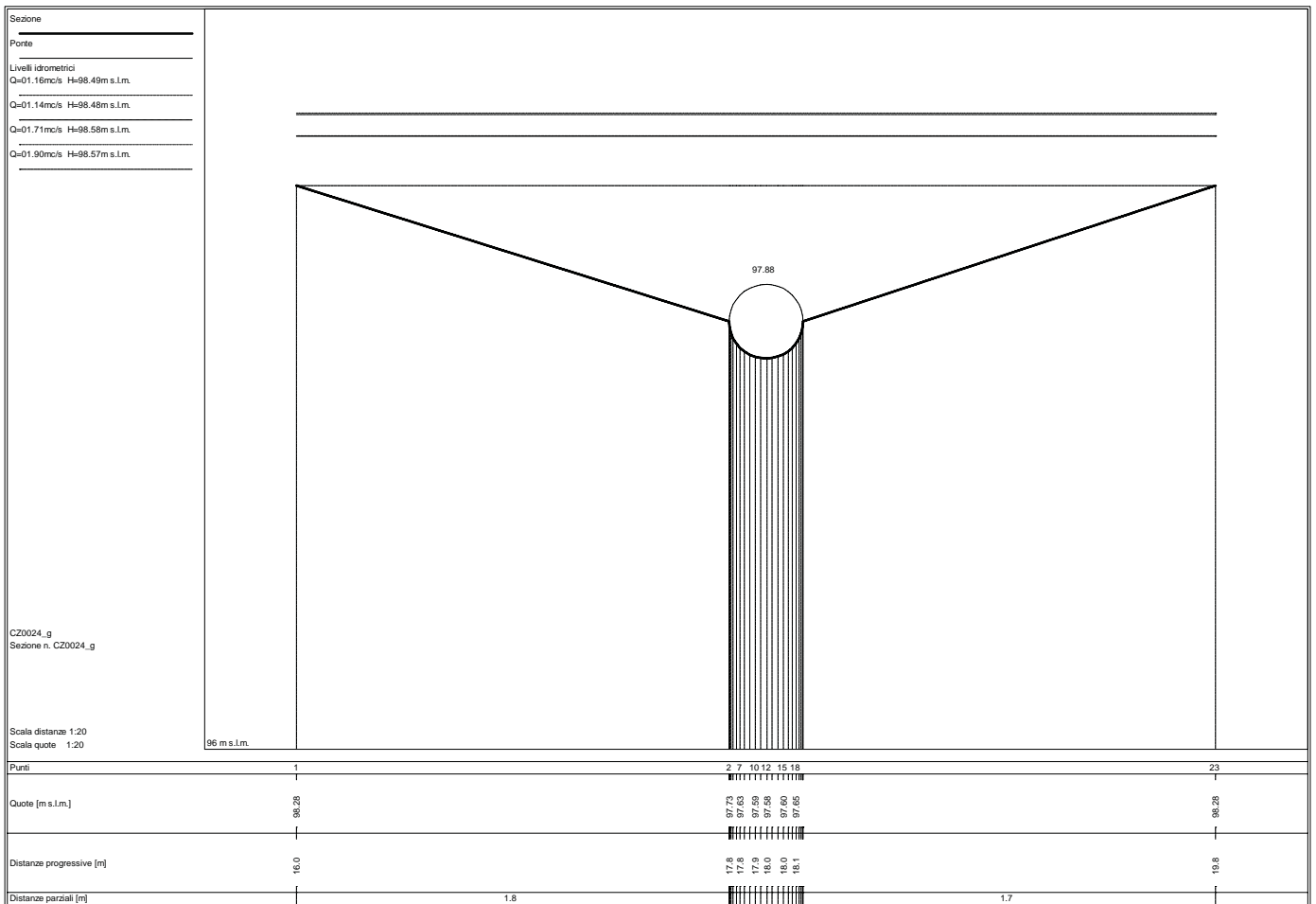
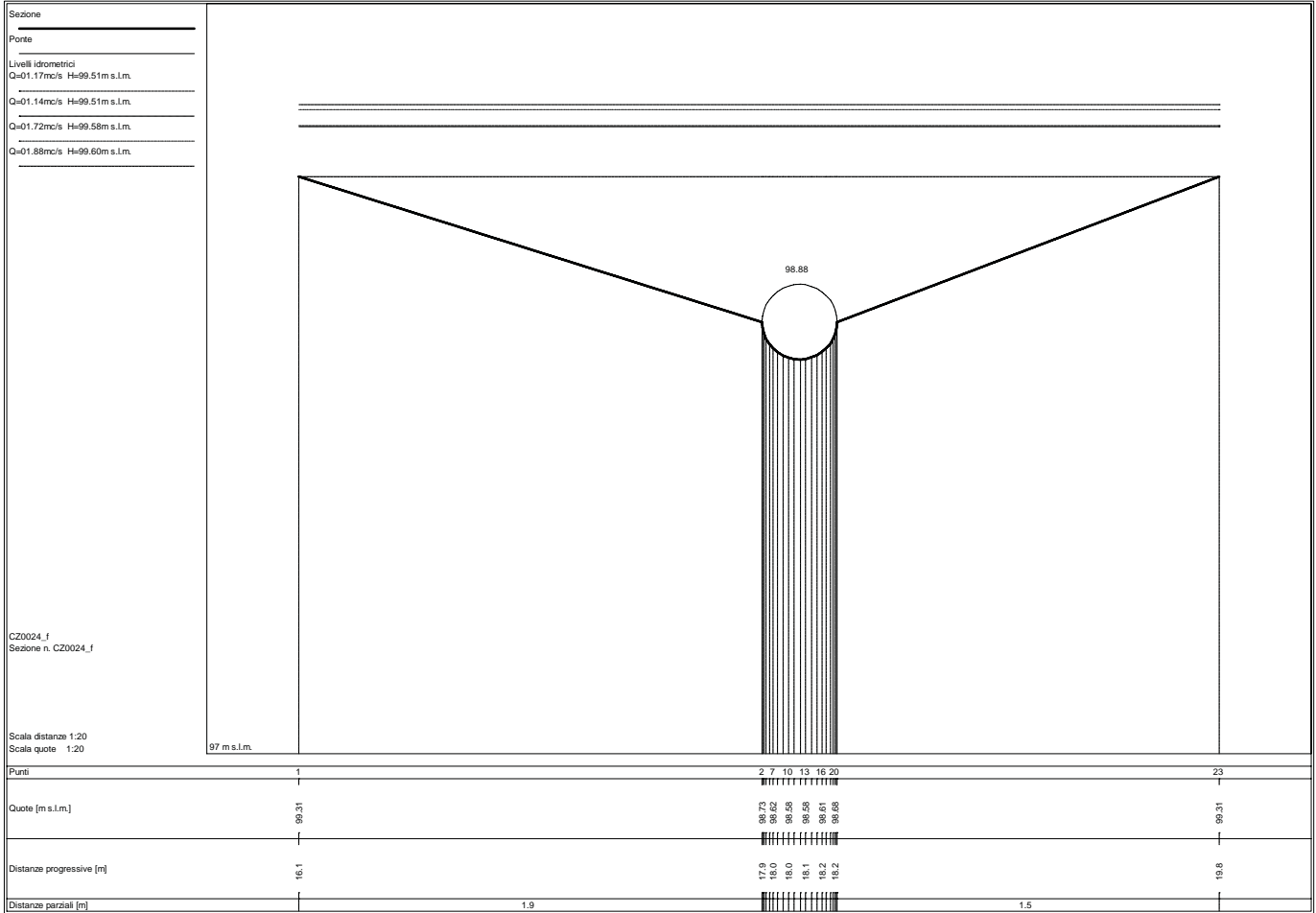

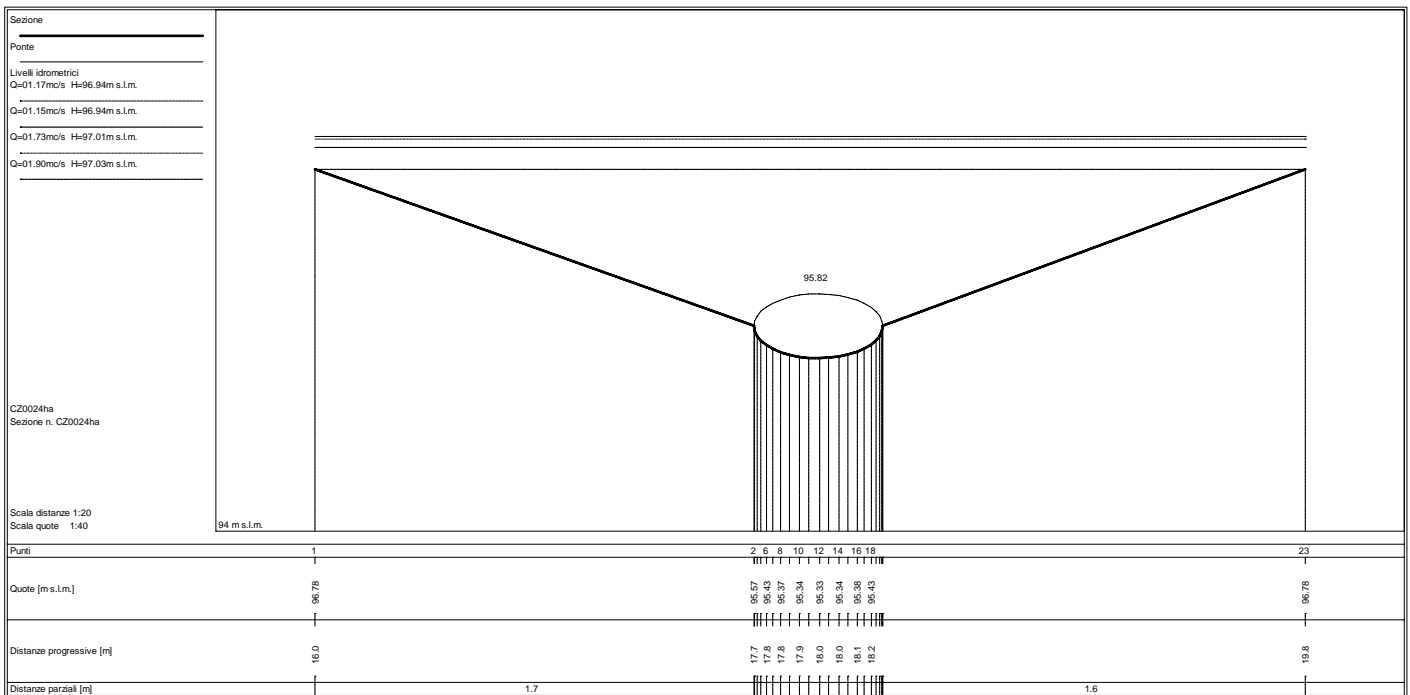
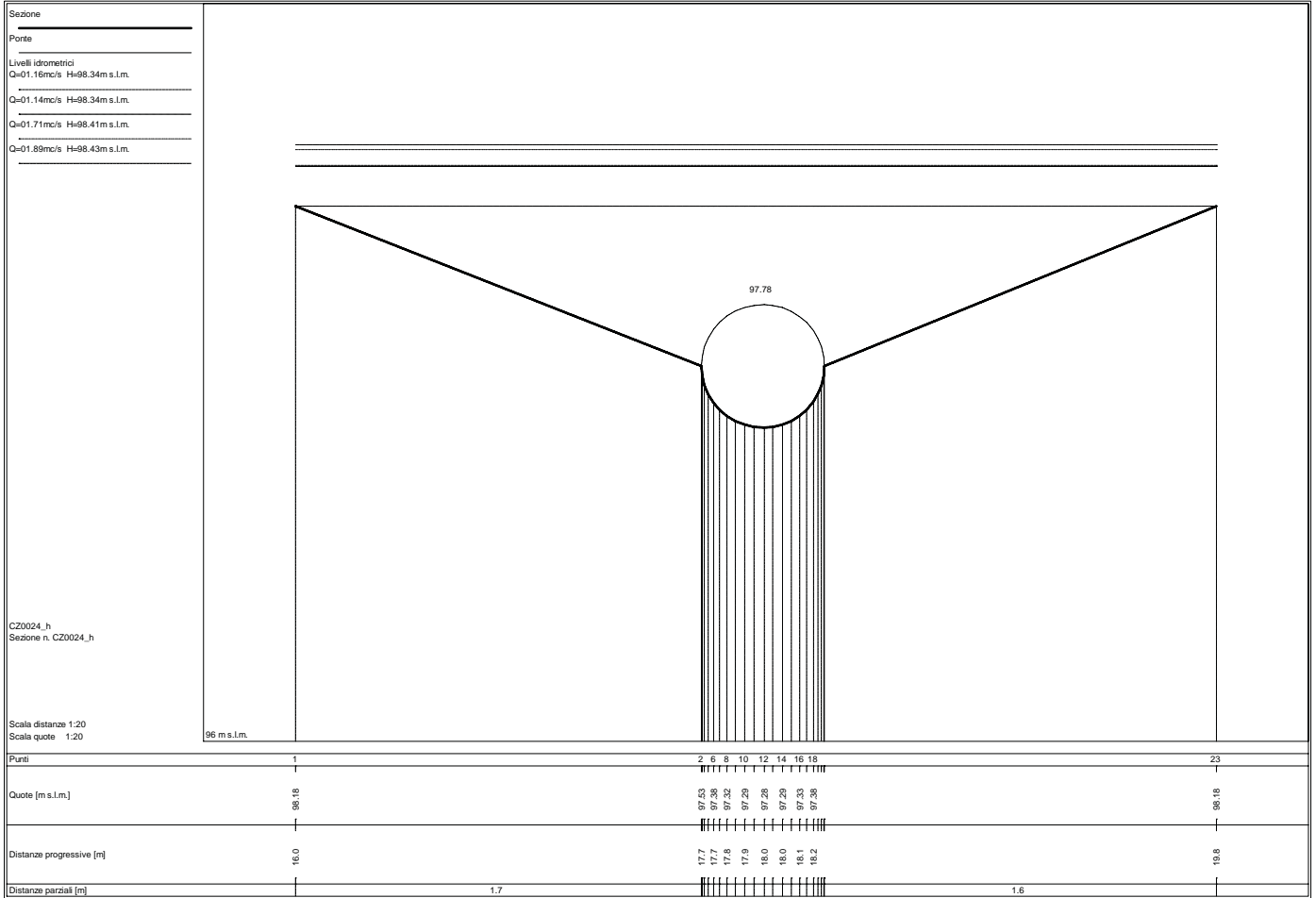

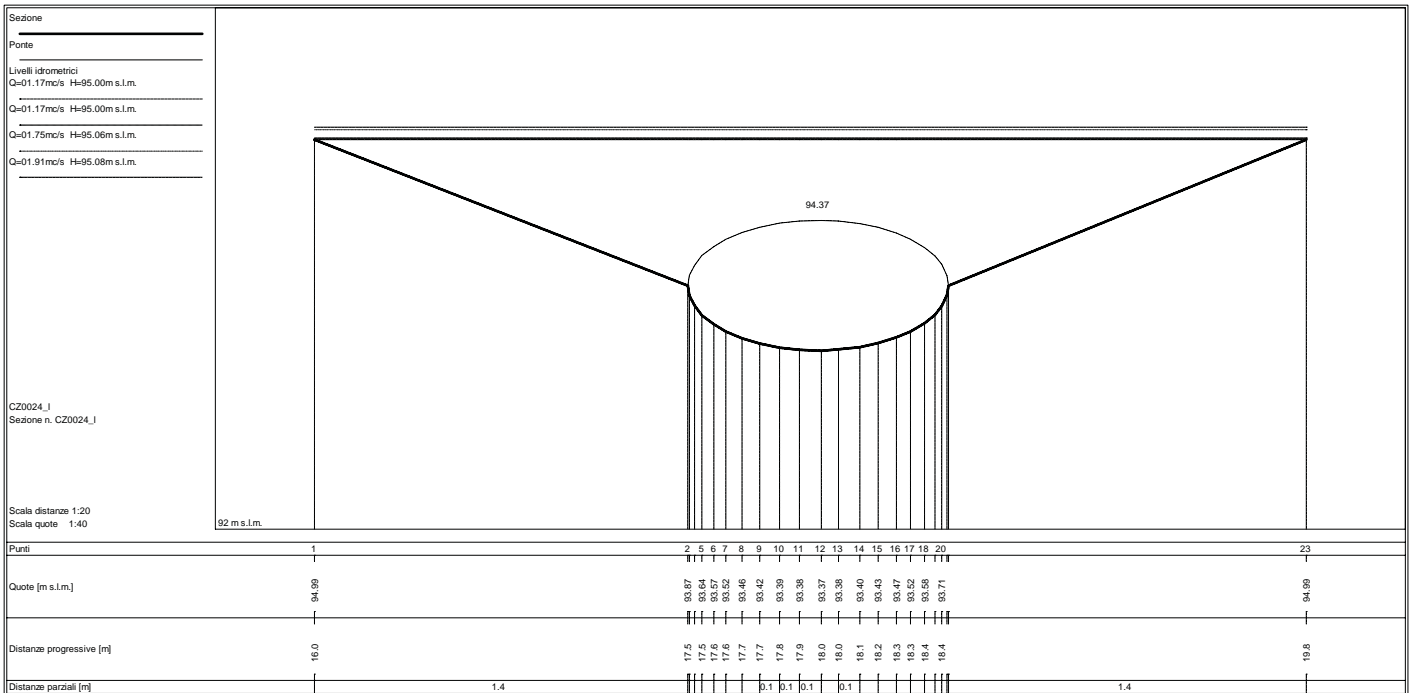
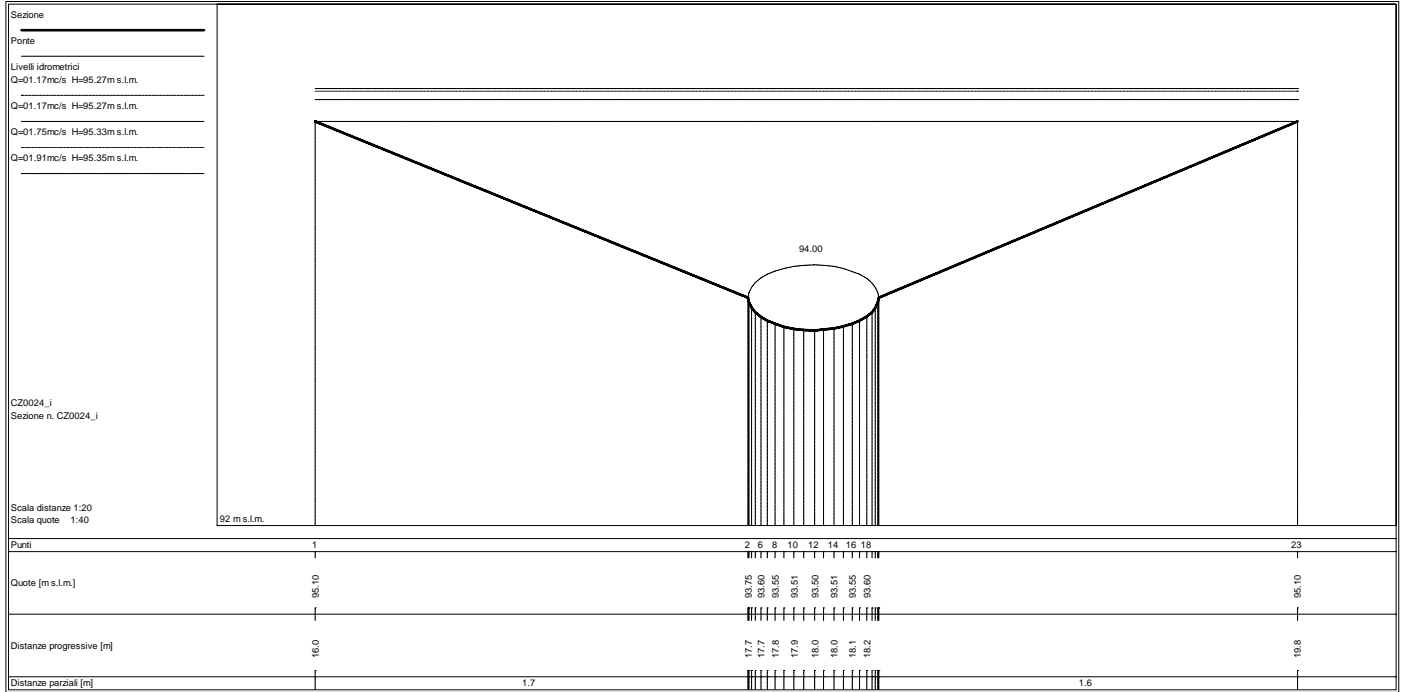

Sezione
 Ponte
 Livelli idrometrici
 Q=01.22m³/s H=92.99m s.l.m.
 Q=01.22m³/s H=92.99m s.l.m.
 Q=01.77m³/s H=93.05m s.l.m.
 Q=01.90m³/s H=93.07m s.l.m.

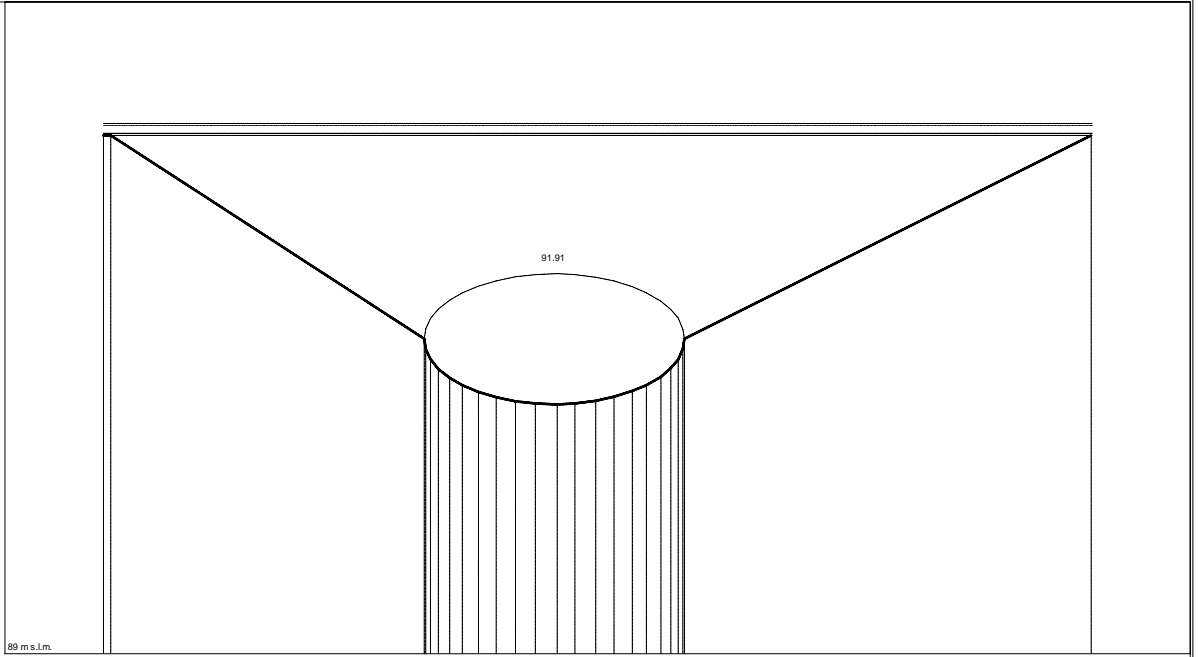

CZ0024_m
 Sezione n. CZ0024_m

Scala distanze 1:20
 Scala quote 1:40

Punti	1	3	6	7	8	9	10	11	12	13	14	15	16	17	18	19	21	24
Quote [m s.l.m.]	92.98	91.41	91.18	91.12	91.06	91.01	90.97	90.94	90.92	90.91	90.92	90.94	90.97	91.01	91.03	91.06	91.26	92.98
Distanze progressive [m]	16.1	17.3	17.3	17.4	17.4	17.5	17.6	17.6	17.7	17.8	17.9	17.9	18.0	18.1	18.1	18.2	18.3	19.8
Distanze parziali [m]			1.2				0.1	0.1	0.1	0.1	0.1	0.1						1.6

Sezione
 Ponte
 Livelli idrometrici
 Q=01.22m³/s H=92.94m s.l.m.
 Q=01.22m³/s H=92.94m s.l.m.
 Q=01.77m³/s H=92.94m s.l.m.
 Q=01.90m³/s H=92.94m s.l.m.

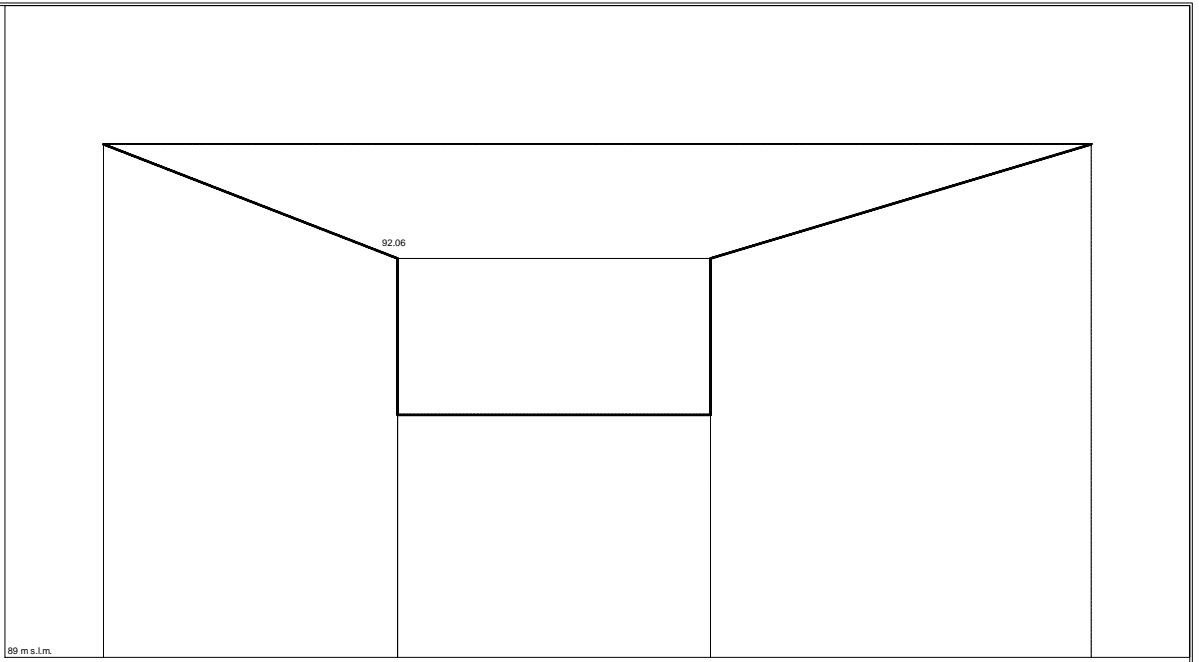

CZ0024_n
 Sezione n. CZ0024_n

Scala distanze 1:20
 Scala quote 1:40

Punti	1	2	4	6
Quote [m s.l.m.]	92.94	92.06	90.96	92.94
Distanze progressive [m]	1.7	2.8	4.0	5.5
Distanze parziali [m]		1.1	1.2	1.5

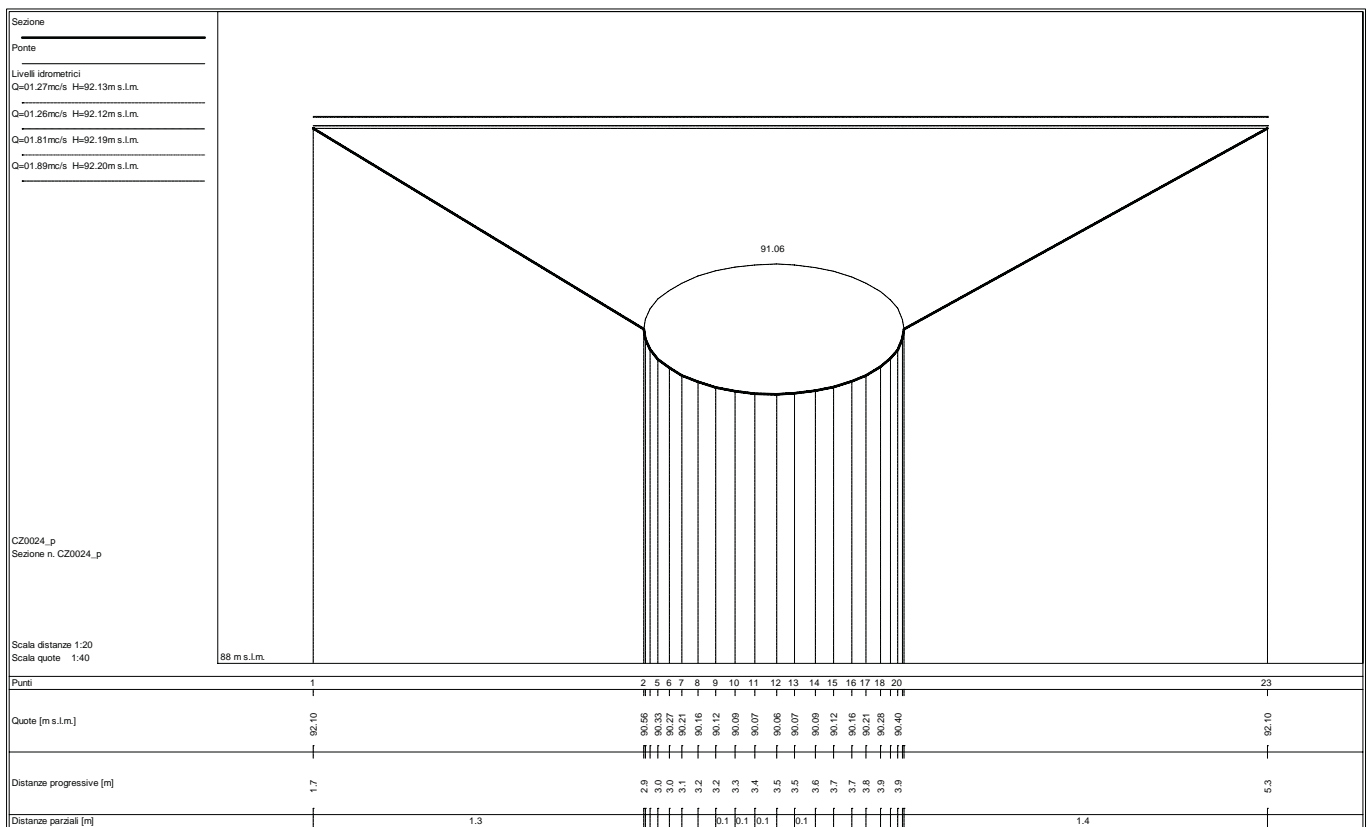
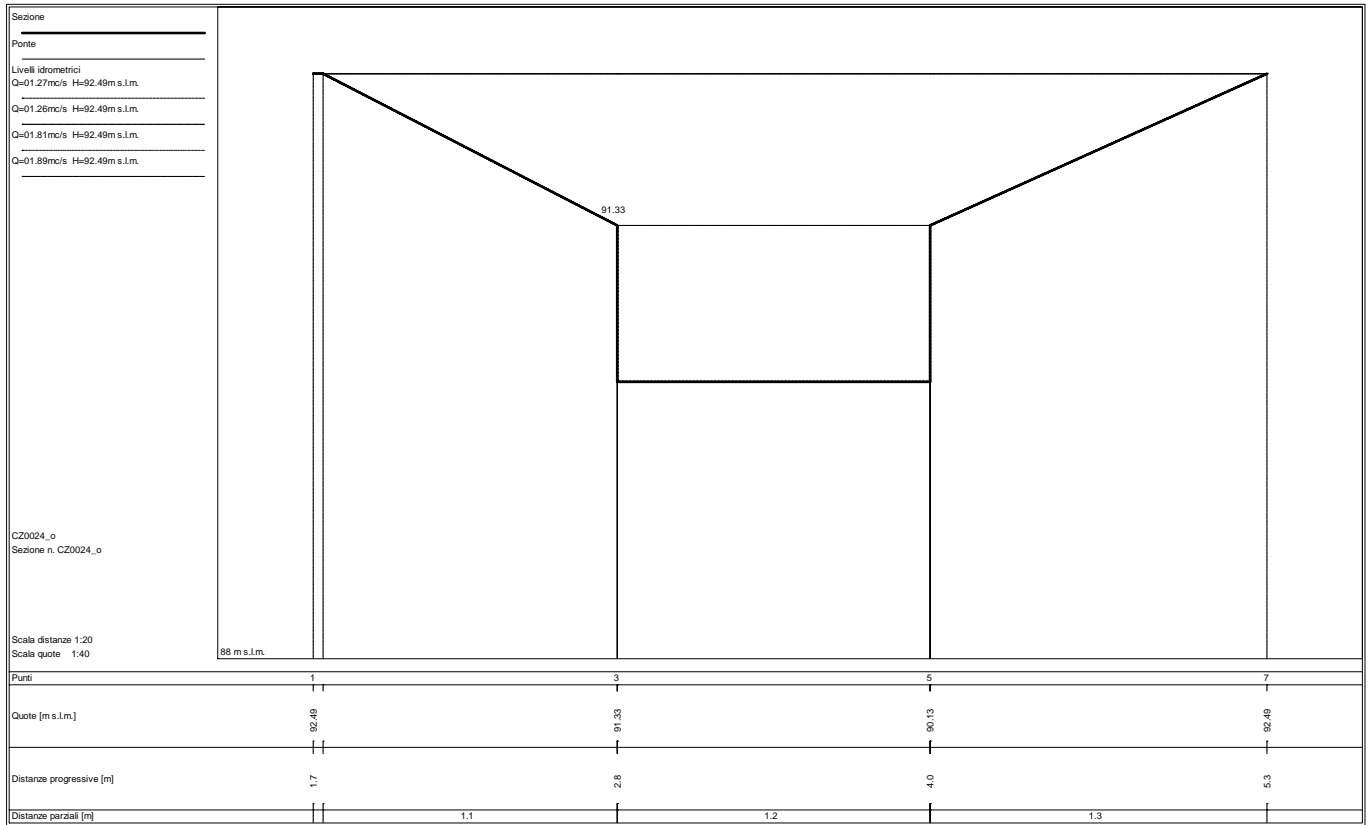

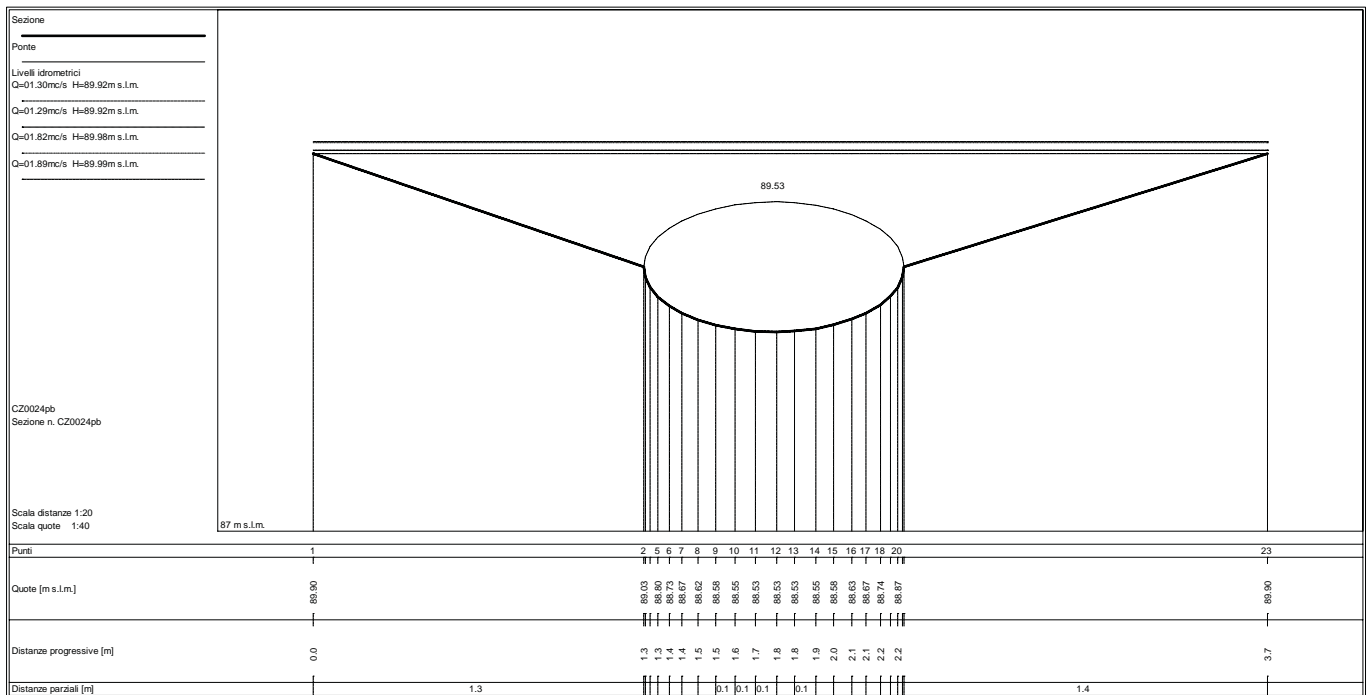
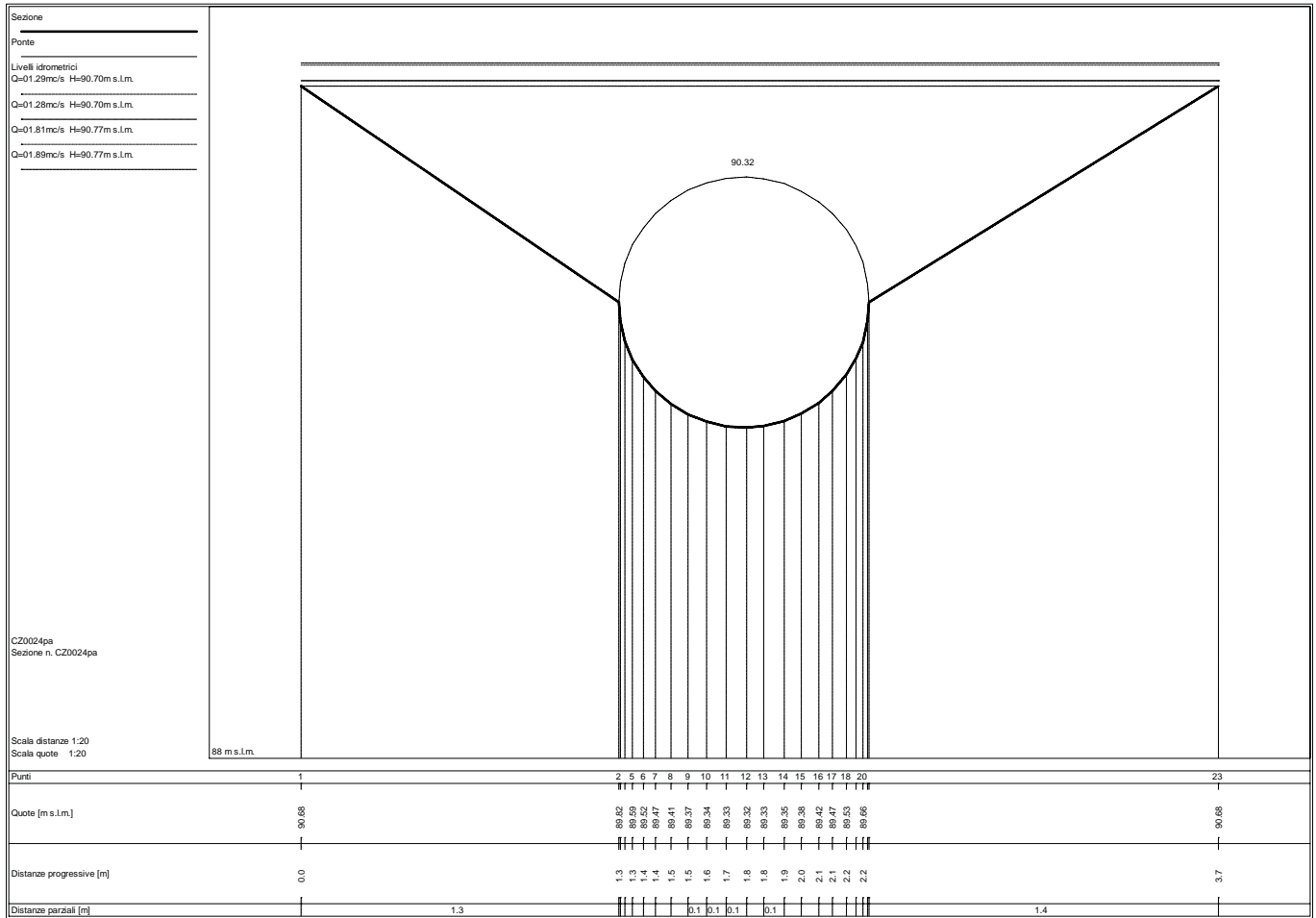

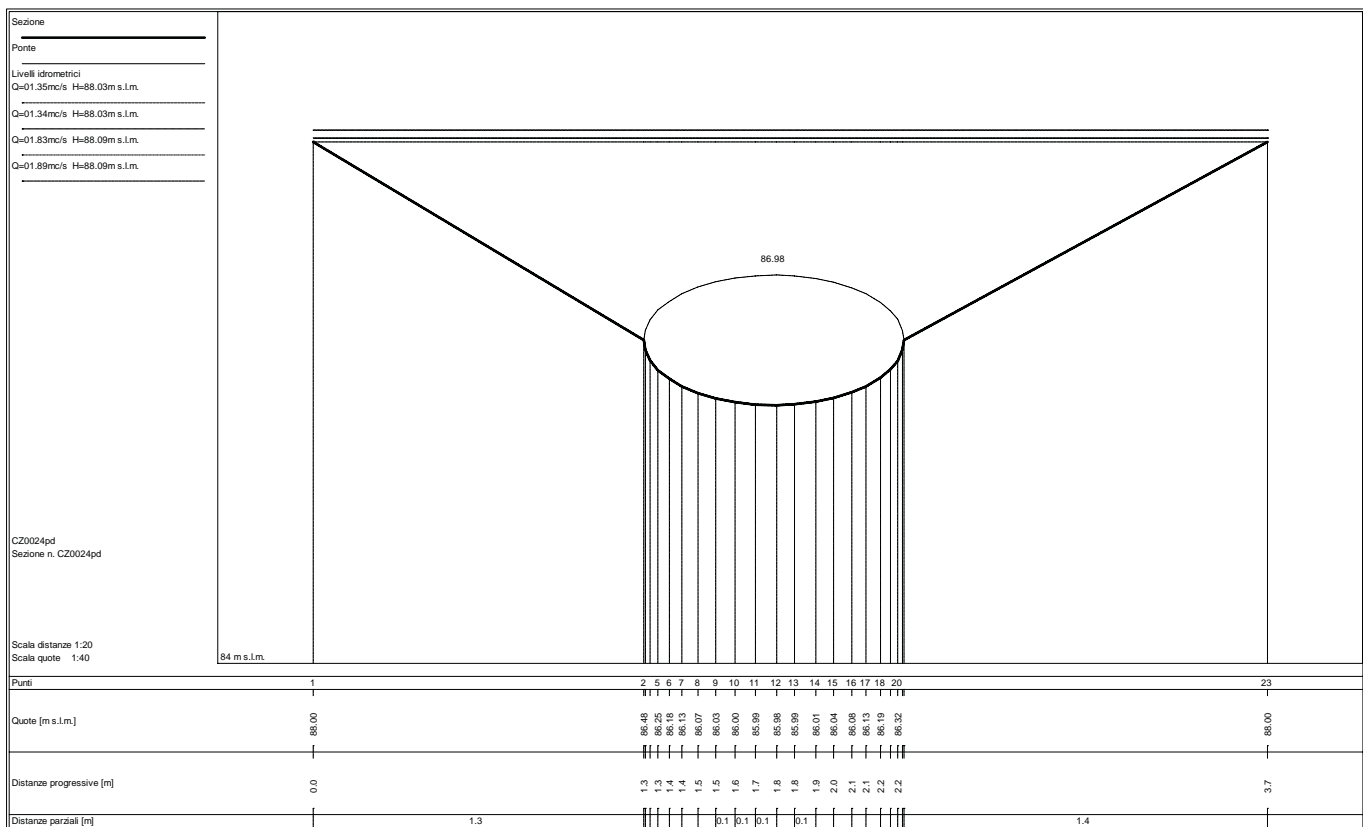
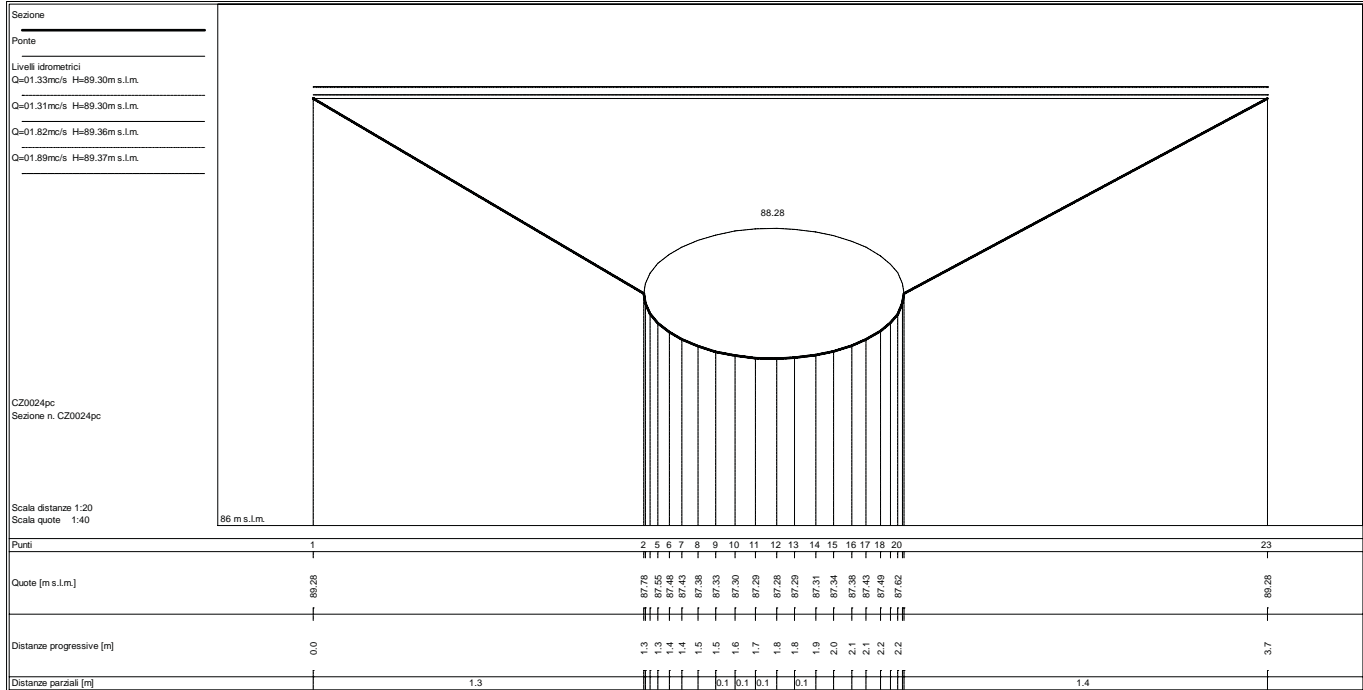

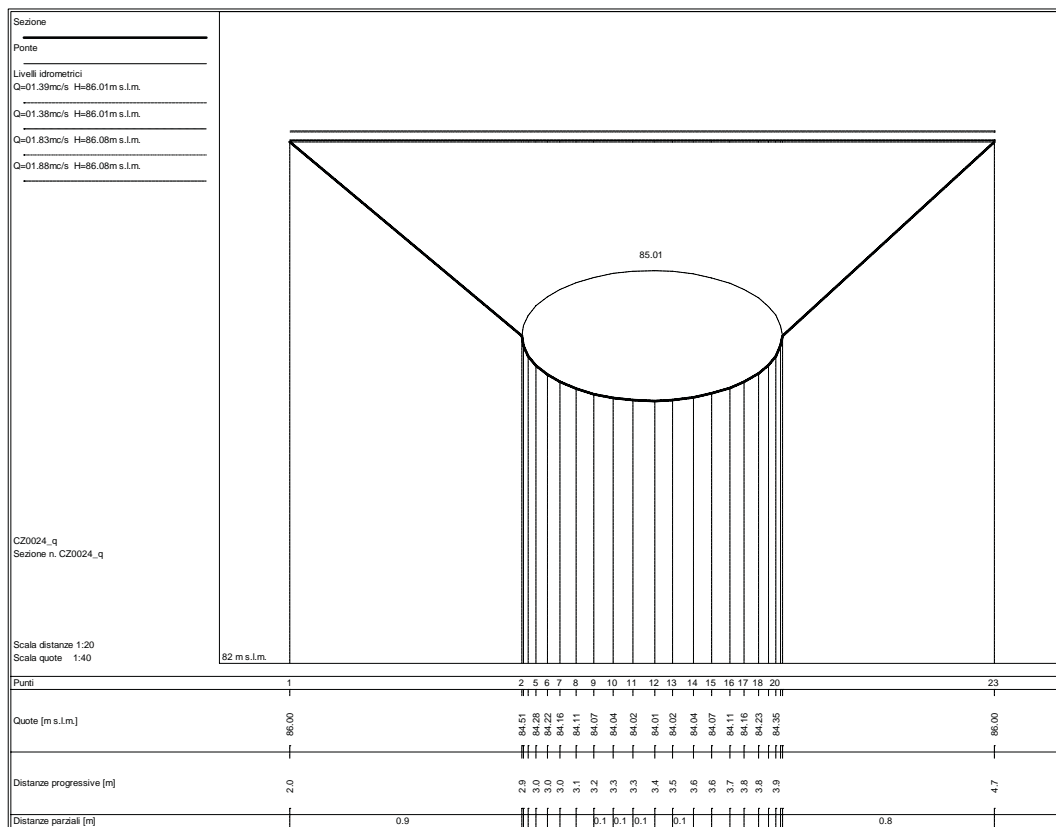
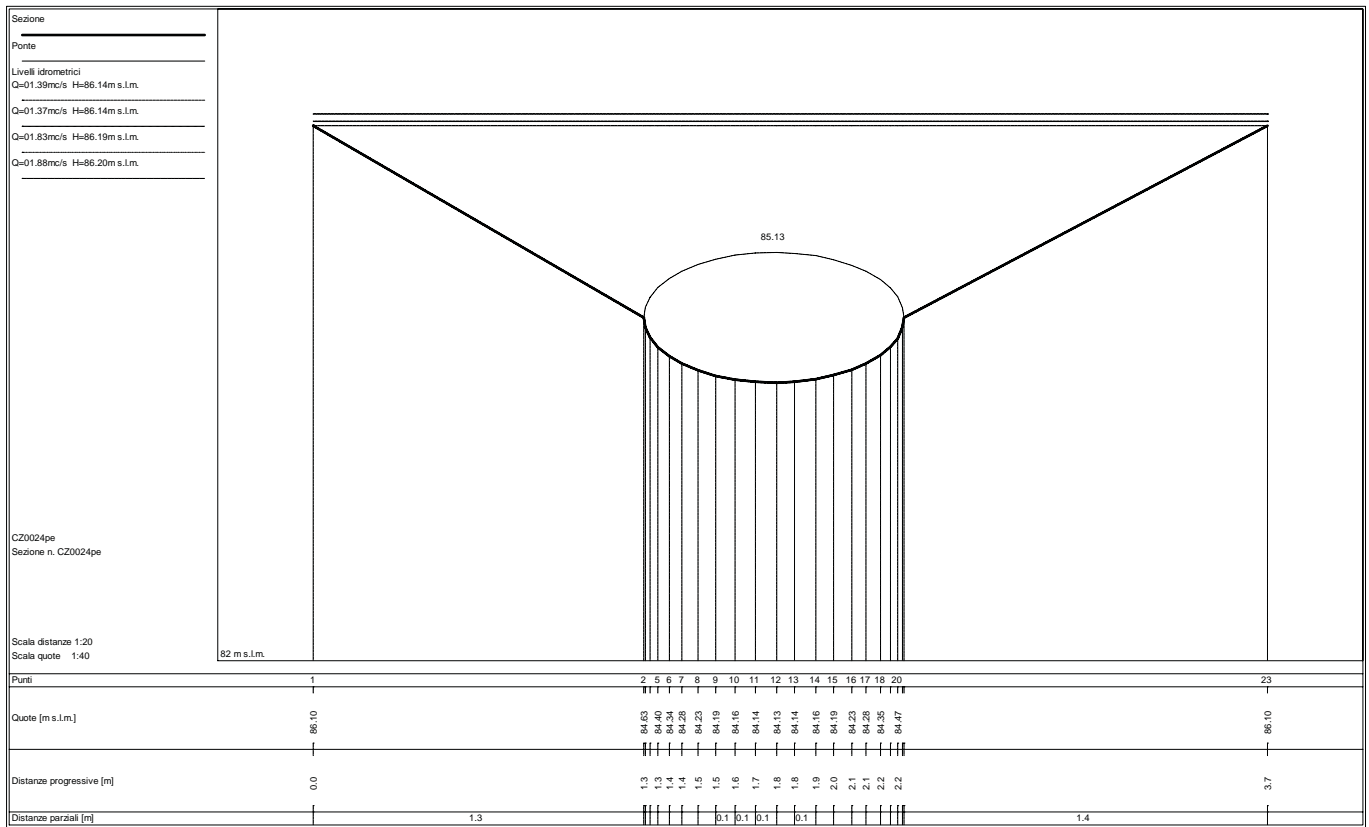

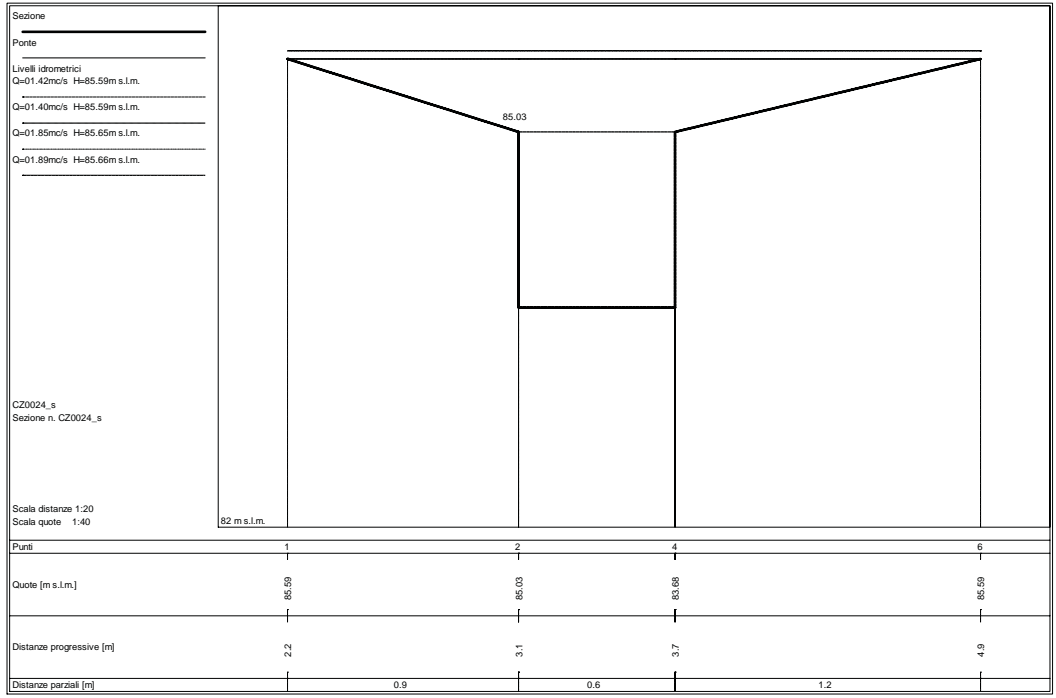
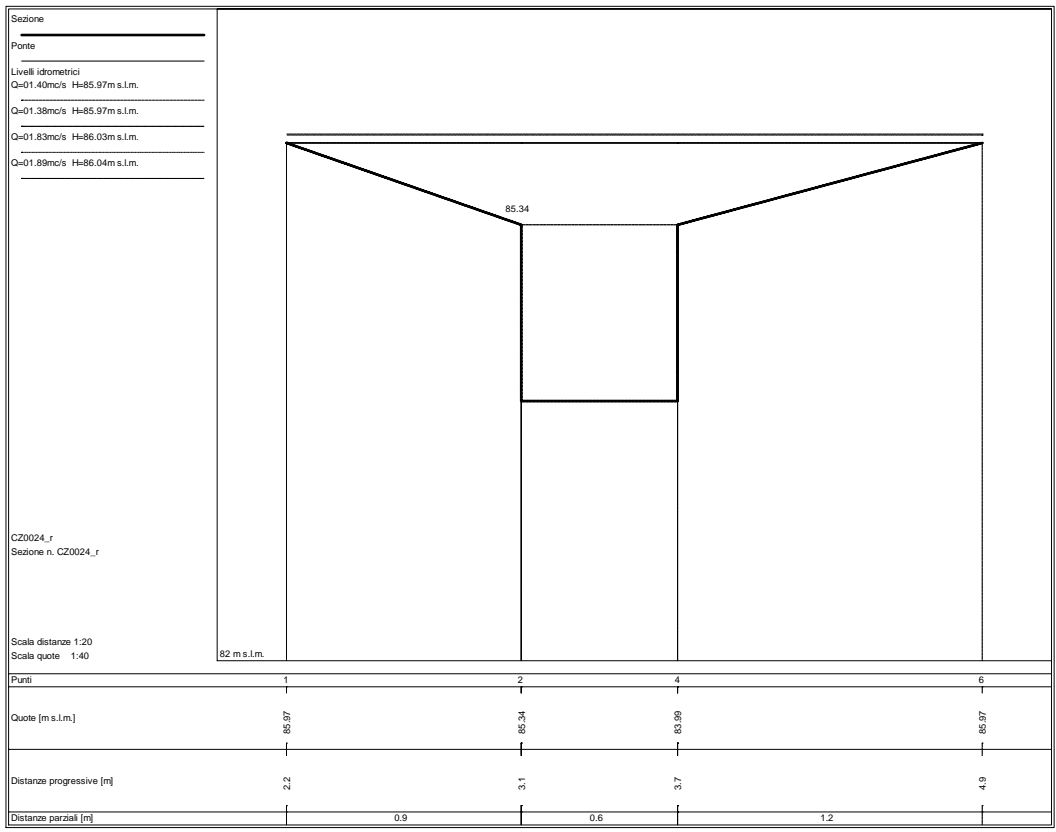

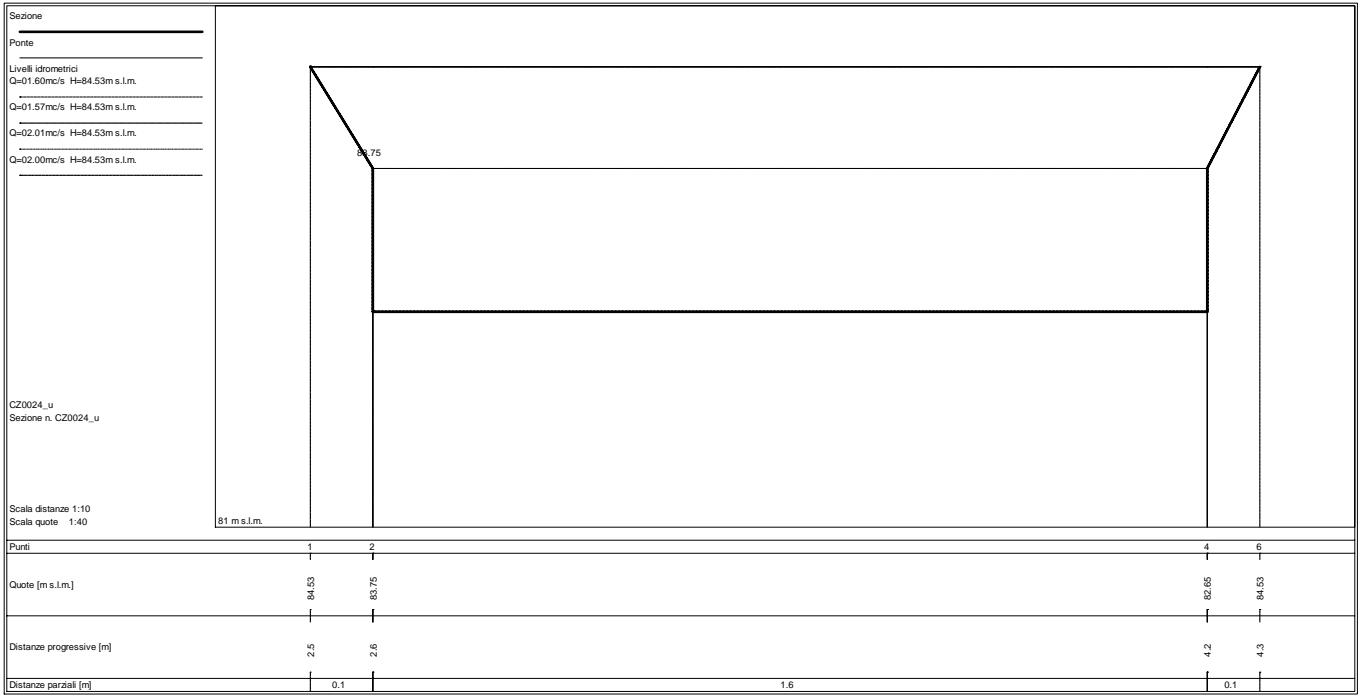
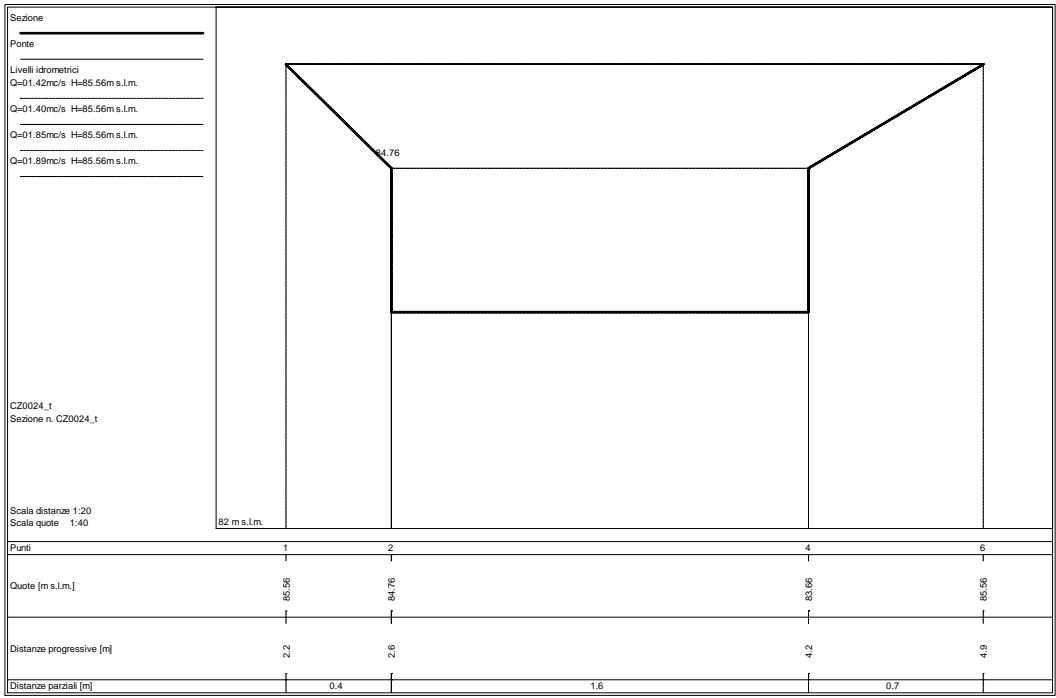

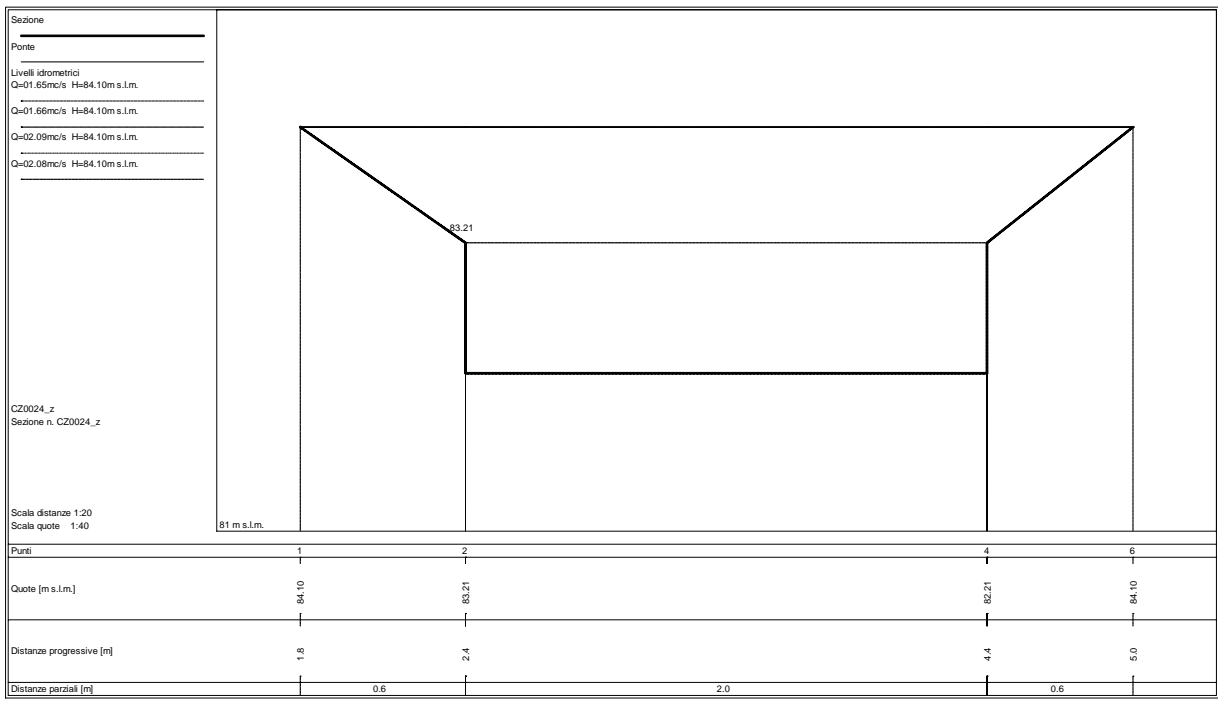
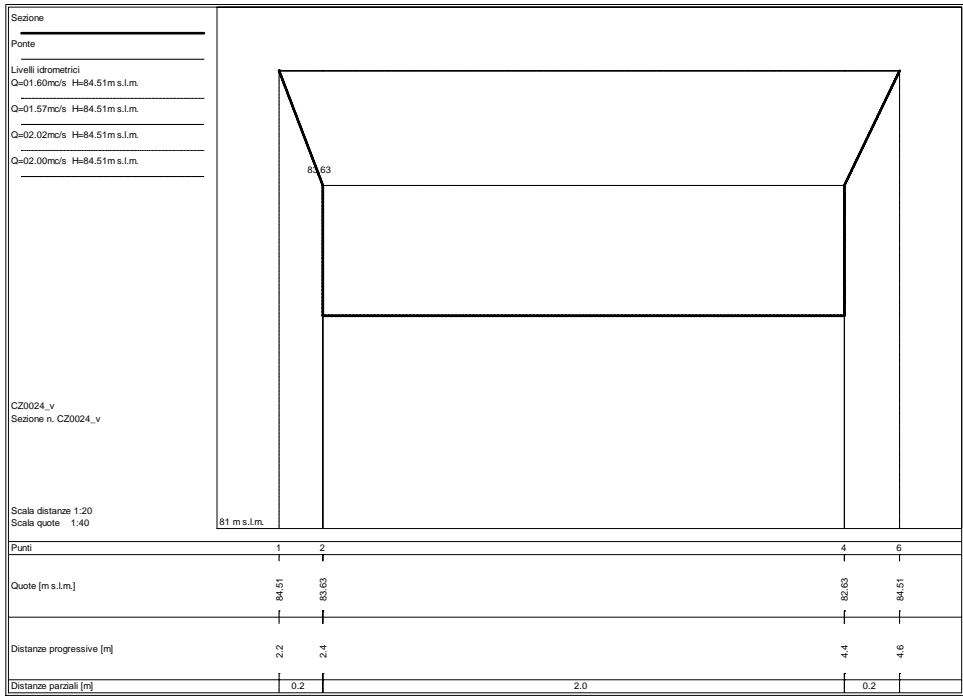

Sezione

Porte

Livelli idrometrici

Q=01.65mc/s H=83.60m s.l.m.

Q=01.67mc/s H=83.60m s.l.m.

Q=02.11mc/s H=83.60m s.l.m.

Q=02.09mc/s H=83.60m s.l.m.

CZ0024zc
Sezione n. CZ0024zc

Scala distanze 1:20
Scala quote 1:40

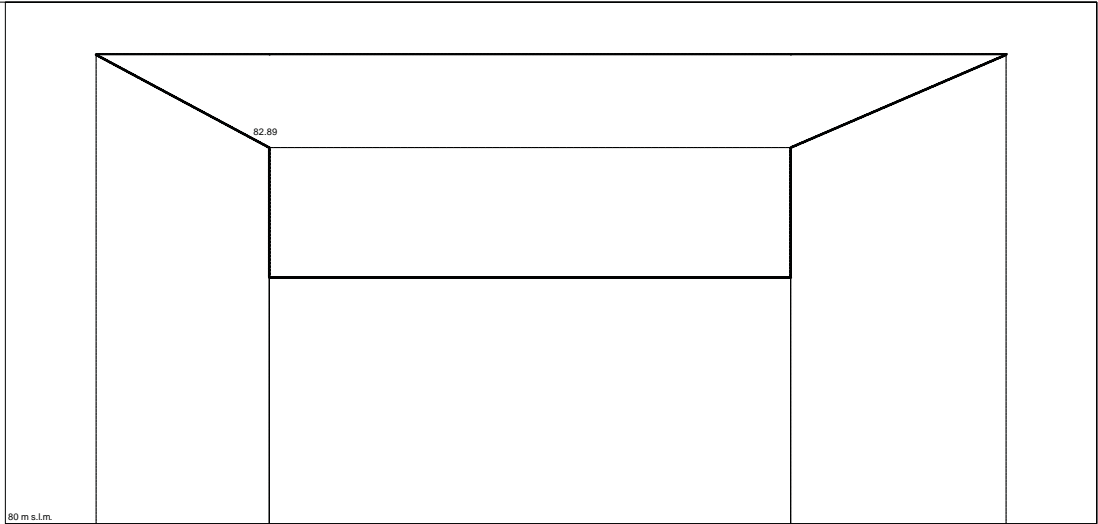

Punti	1	2	4	6
Quote [m s.l.m.]	83.60	82.89	81.89	83.60
Distanze progressive [m]	1.7	2.4	4.4	5.2
Distanze parziali [m]		0.7	2.0	0.8

Sezione

Porte

Livelli idrometrici

Q=01.65mc/s H=83.60m s.l.m.

Q=01.68mc/s H=83.60m s.l.m.

Q=02.11mc/s H=83.60m s.l.m.

Q=02.10mc/s H=83.60m s.l.m.

CZ0024zd
Sezione n. CZ0024zd

Scala distanze 1:20
Scala quote 1:40

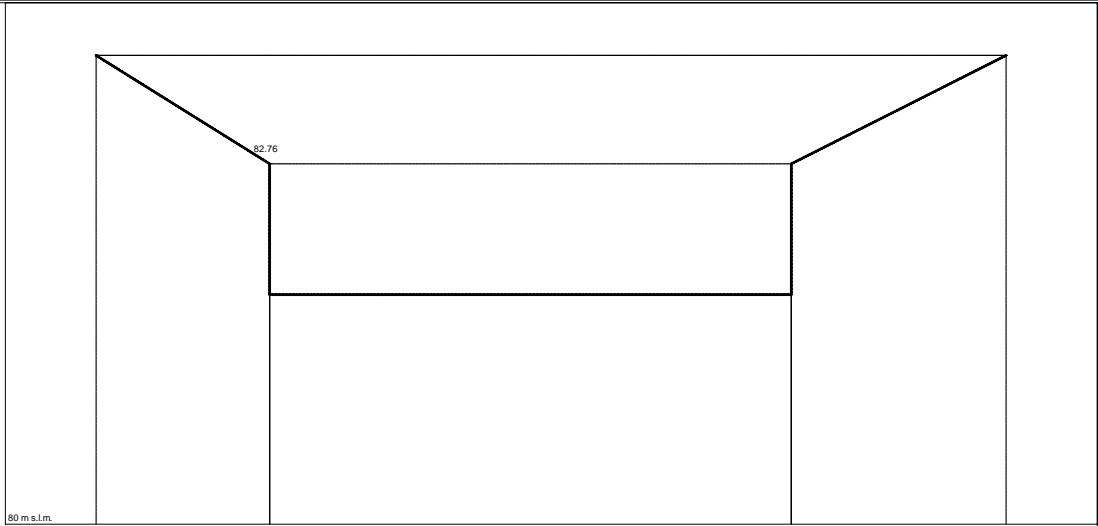

Punti	1	2	4	6
Quote [m s.l.m.]	83.60	82.76	81.76	83.60
Distanze progressive [m]	1.7	2.4	4.4	5.2
Distanze parziali [m]		0.7	2.0	0.8

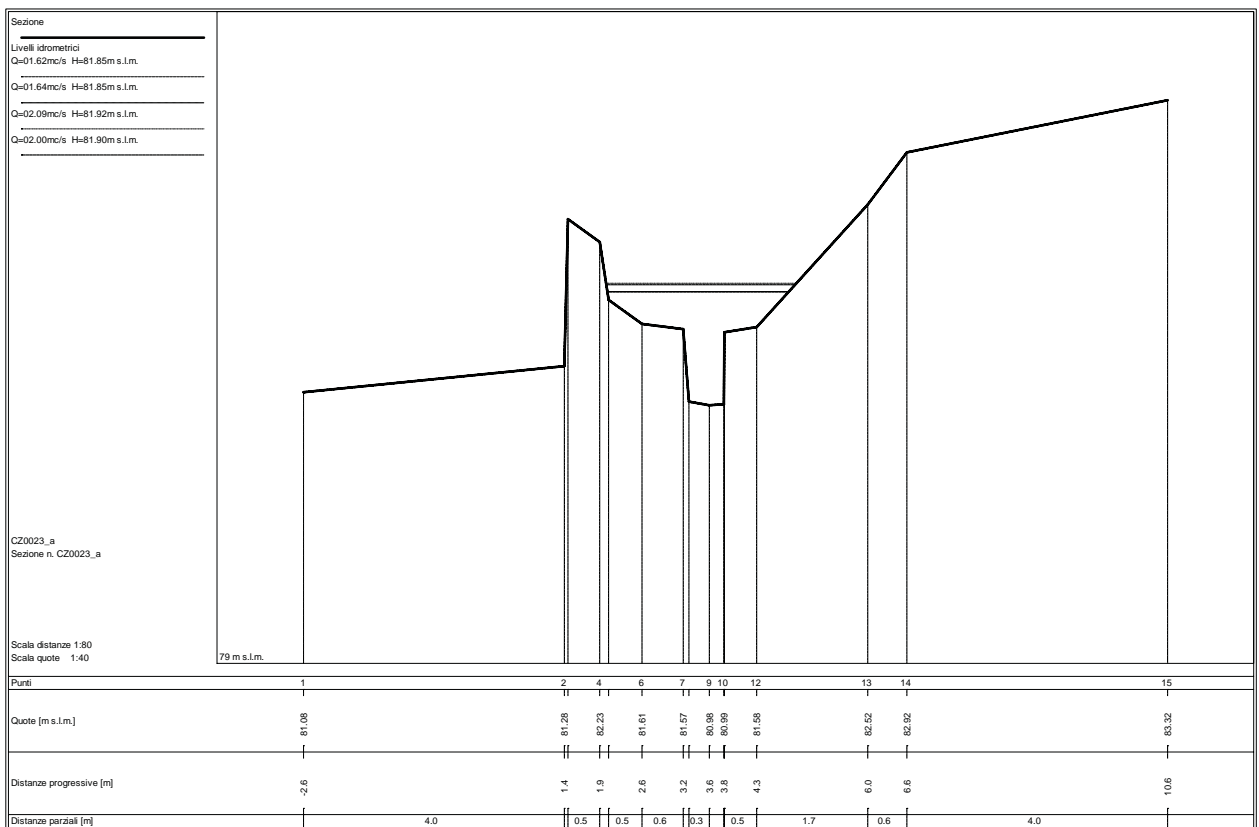
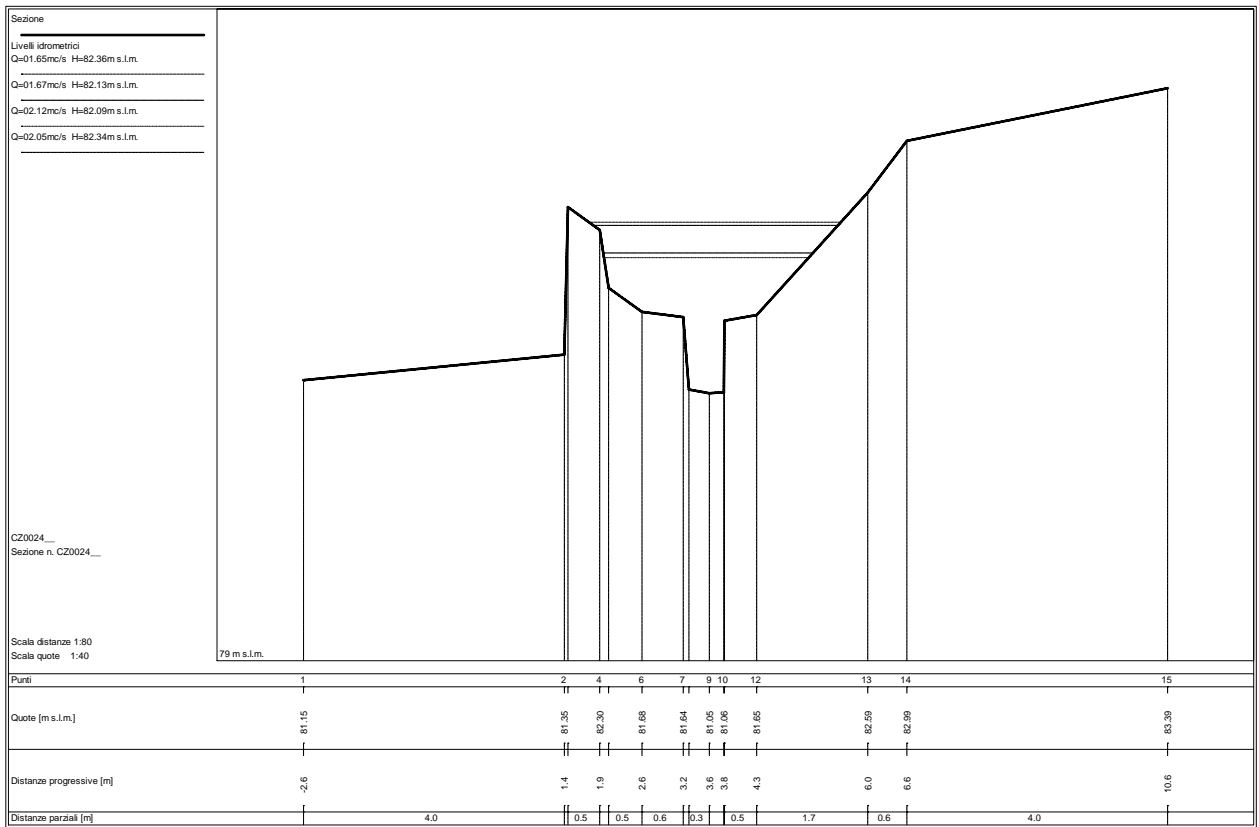

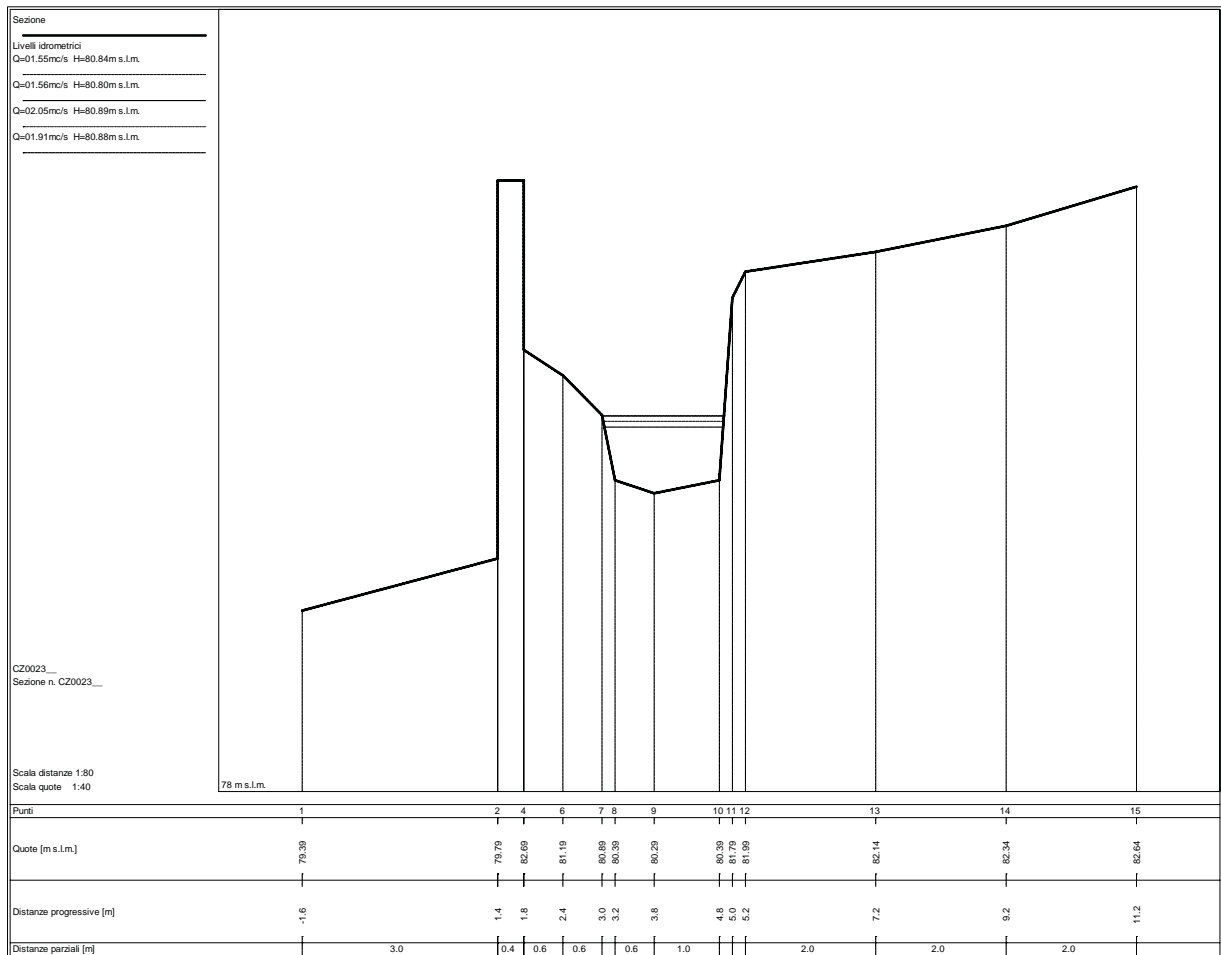
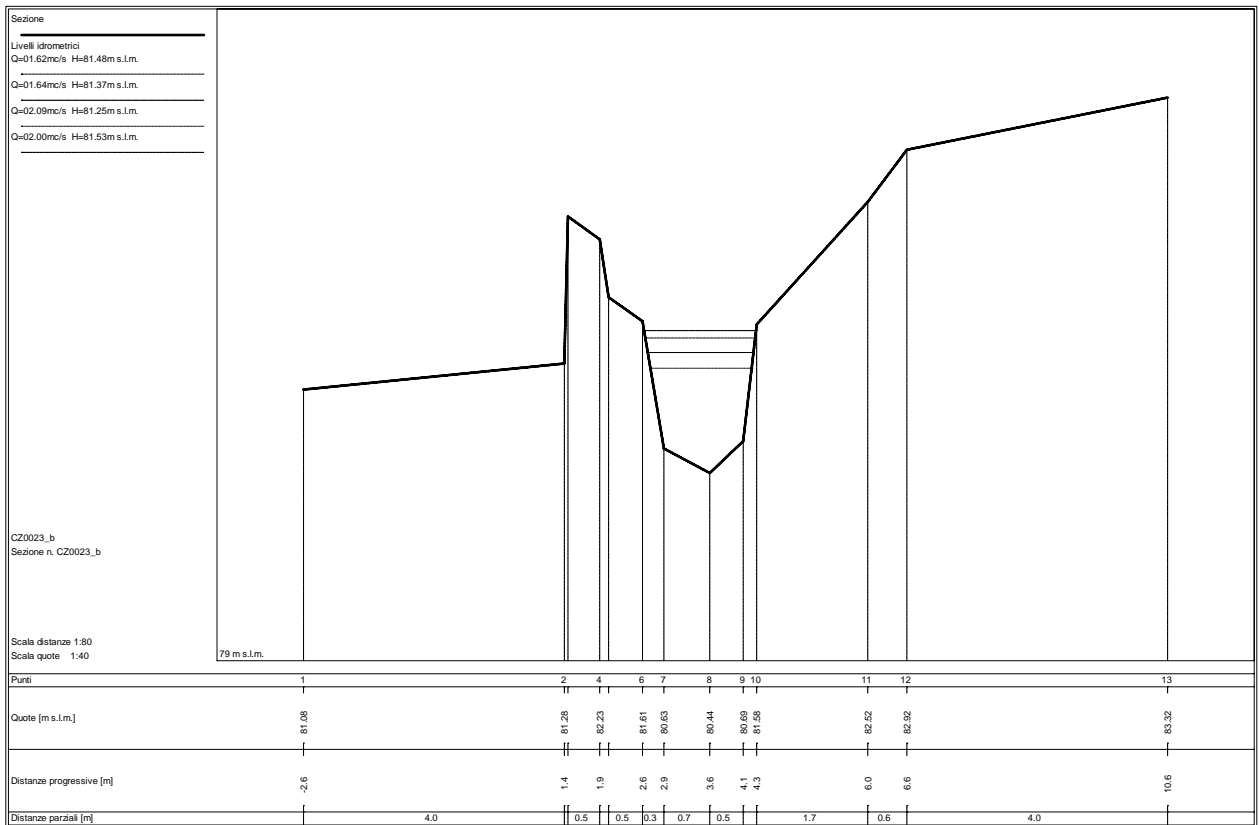

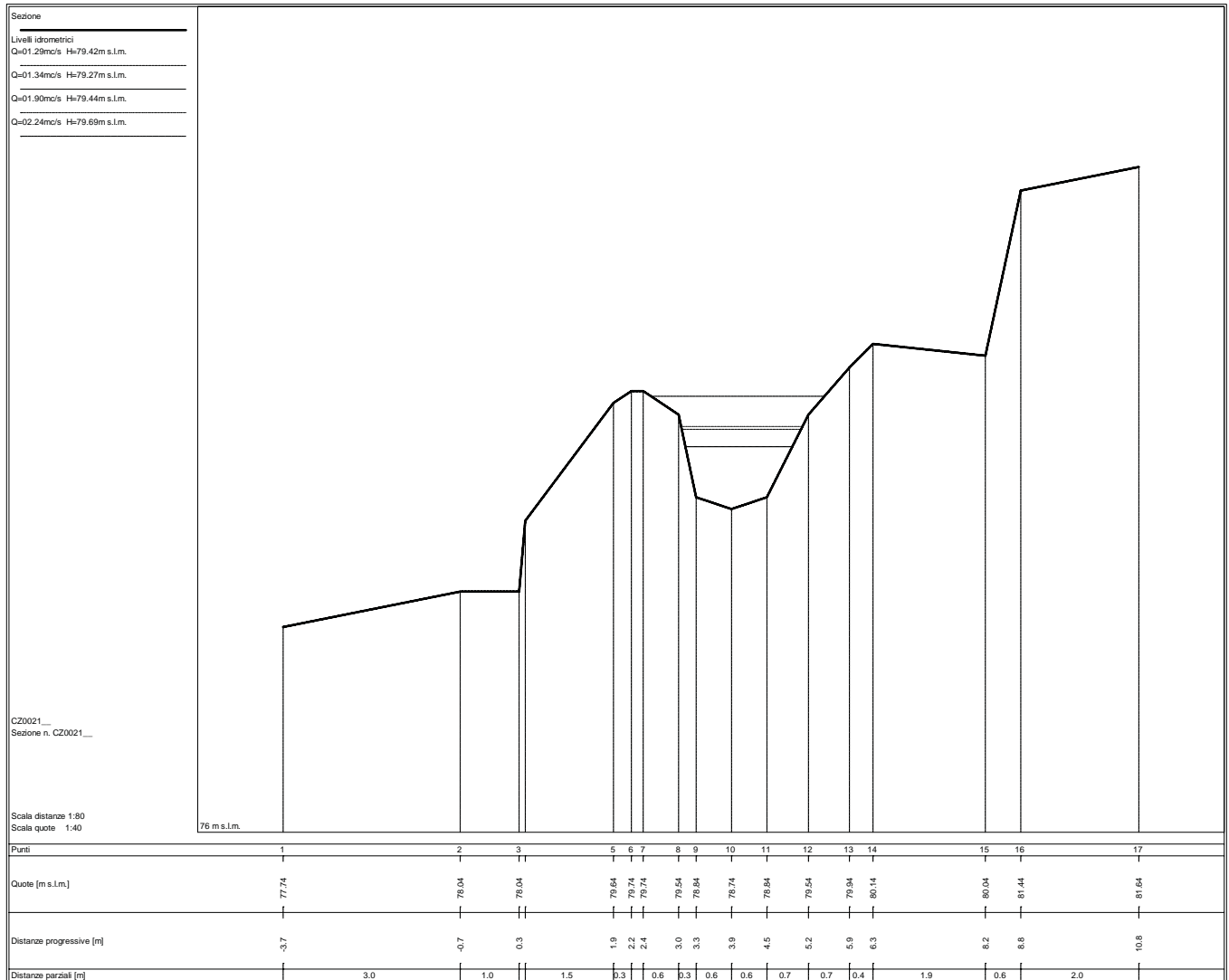
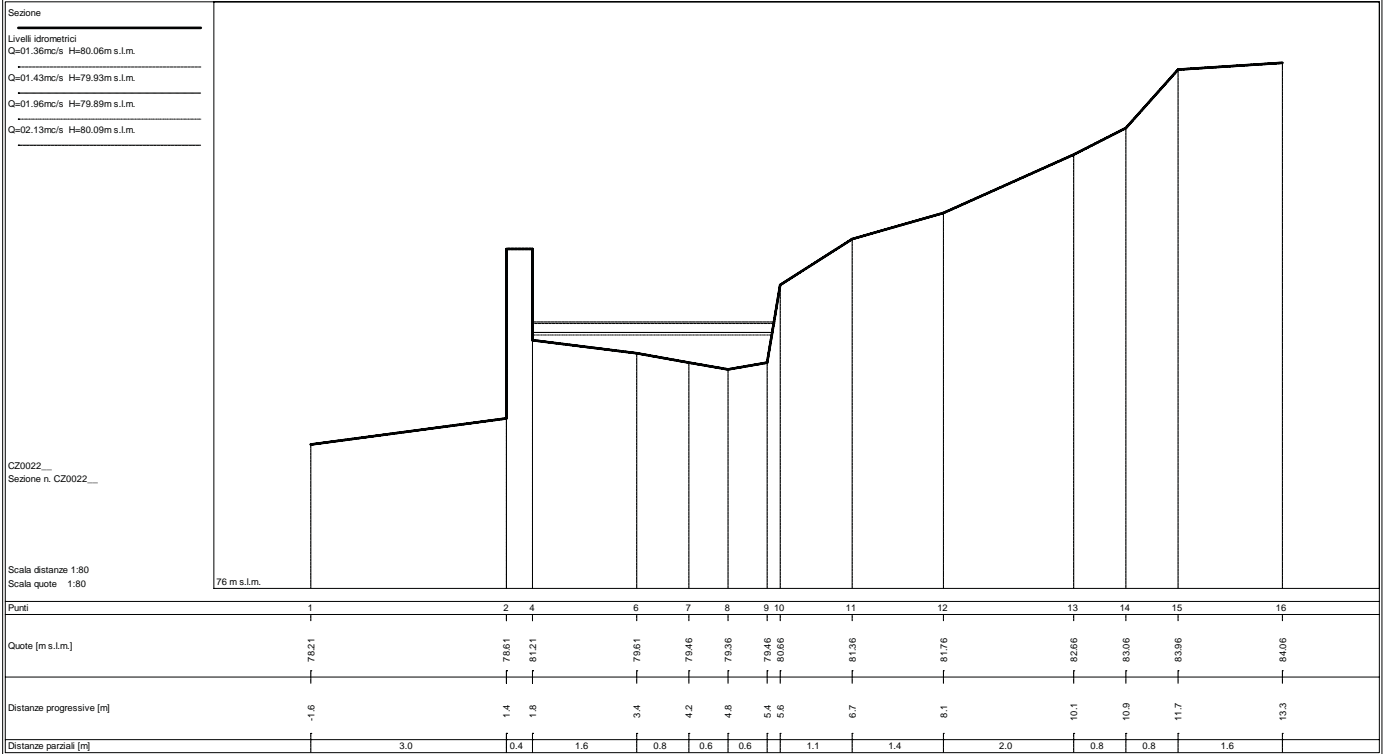

Sezione
 Livelli idrometrici
 Q=01.30mc/s H=79.46m s.l.m.
 Q=01.32mc/s H=79.34m s.l.m.
 Q=01.90mc/s H=79.57m s.l.m.
 Q=02.24mc/s H=79.69m s.l.m.

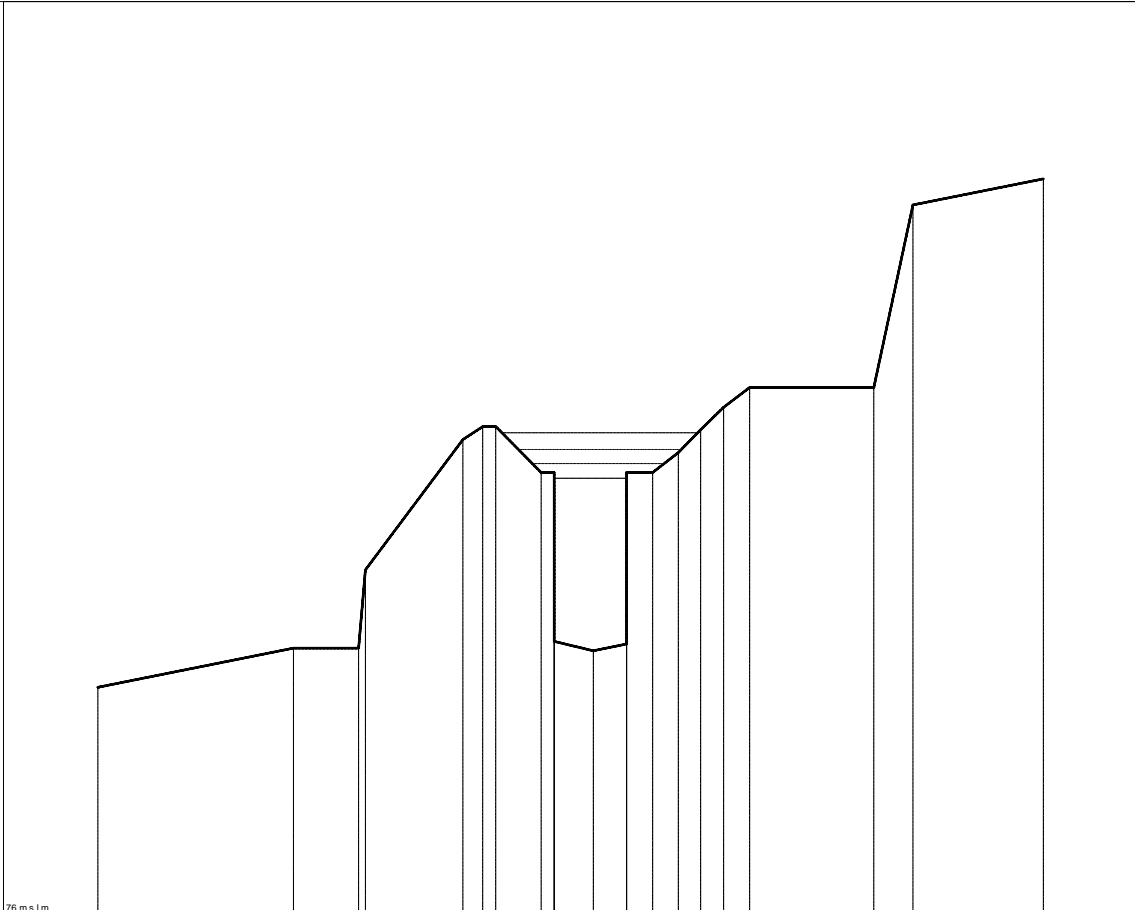

CZ0020_a
 Sezione n. CZ0020_a
 Scala distanze 1:80
 Scala quote 1:40

Punti	1	2	3	5	6	7	8	9	11	12	14	15	16	17	18	19	20	21
Quote [m s.l.m.]	77.74	78.04	78.04	79.64	79.74	79.74	79.69	79.39	78.02	78.07	79.39	79.54	79.72	79.89	80.04	80.04	81.44	81.64
Distanze progressive [m]	-3.7	-0.7	0.3	1.9	2.2	2.4	0.1	3.3	3.9	4.5	4.9	5.2	5.6	5.9	6.3	8.2	8.8	10.8
Distanze parziali [m]		3.0	1.0	1.5	0.3	0.7	0.6	0.5	0.4	0.4	0.3	0.3	0.4	1.9	0.6	2.0		

Sezione
 Ponte
 Livelli idrometrici
 Q=01.30mc/s H=79.39m s.l.m.
 Q=01.32mc/s H=79.13m s.l.m.
 Q=01.90mc/s H=79.21m s.l.m.
 Q=02.24mc/s H=79.42m s.l.m.

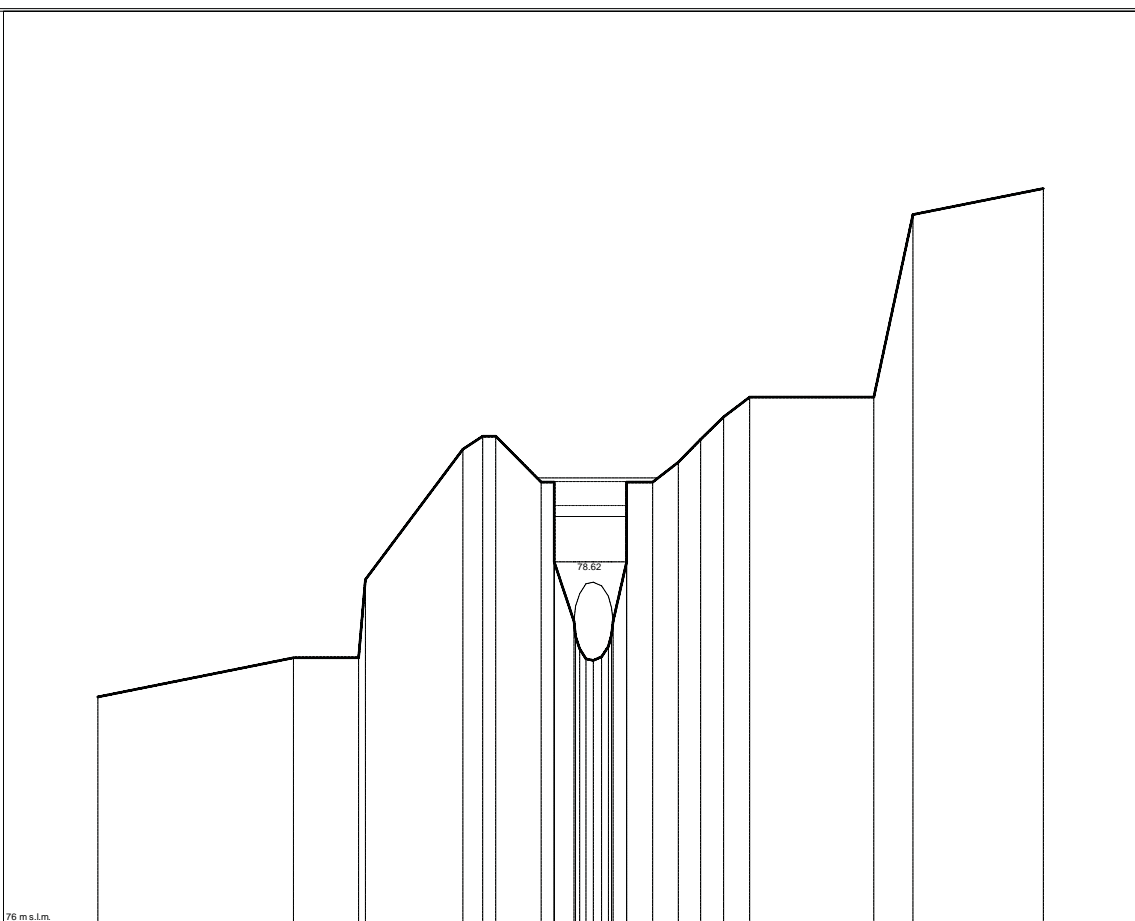

CZ0020_b
 Sezione n. CZ0020_b
 Scala distanze 1:80
 Scala quote 1:40

Punti	1	2	3	5	6	7	8	9	11	15	17	20	22	23	24	25	26	27	28	29
Quote [m s.l.m.]	77.74	78.04	78.04	79.64	79.74	79.74	79.69	79.39	78.32	78.02	78.13	78.77	79.39	79.54	79.72	79.89	80.04	80.04	81.44	81.64
Distanze progressive [m]	-3.7	-0.7	0.3	1.9	2.2	2.4	0.1	3.3	3.6	3.9	4.2	4.5	4.9	5.2	5.6	5.9	6.3	8.2	8.8	10.8
Distanze parziali [m]		3.0	1.0	1.5	0.3	0.7	0.3	0.3	0.3	0.4	0.4	0.4	0.4	0.3	0.3	0.4	1.9	0.6	2.0	

Sezione
 Ponte
 Livelli idrometrici
 Q=01.48mc/s H=76.44m s.l.m.
 Q=01.32mc/s H=76.41m s.l.m.
 Q=01.75mc/s H=76.49m s.l.m.
 Q=02.31mc/s H=76.56m s.l.m.

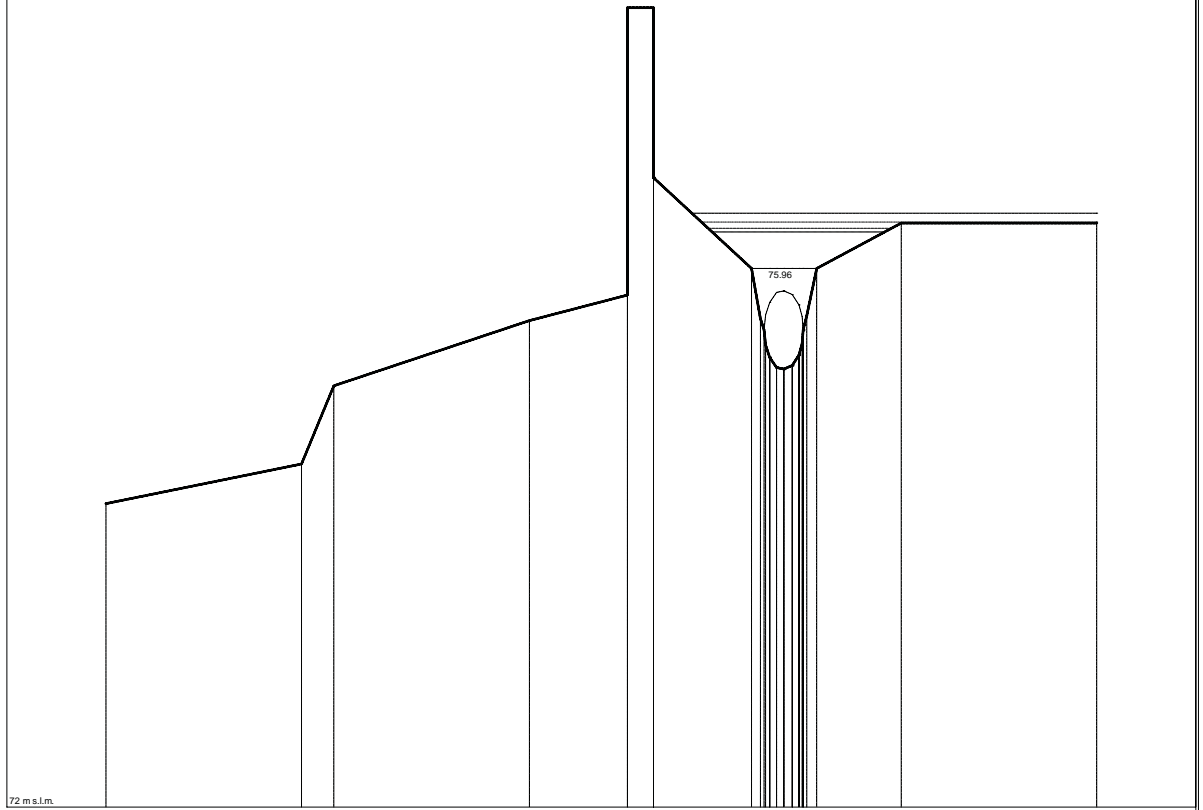

CZ0019_c
 Sezione n. CZ0019_c

Scala distanze 1:80
 Scala quote 1:40

72 m.s.l.m.

Punti	1	2	3	4	5	7	10	12	18	22	28	29	30	
Quote [m s.l.m.]	74.33	74.63	75.23	75.73	75.93	76.13	76.13	75.96	75.36	75.47	76.13	76.48	76.48	
Distanze progressive [m]	-5.8	-2.8	-2.3	0.7	2.2	2.6	4.1	4.3	4.6	4.8	5.1	6.4	9.4	
Distanze parziali [m]		3.0	0.5	3.0	1.5	0.4	1.5					1.3	3.0	

Sezione
 Livelli idrometrici
 Q=01.48mc/s H=75.70m s.l.m.
 Q=01.32mc/s H=75.77m s.l.m.
 Q=01.75mc/s H=75.89m s.l.m.
 Q=02.31mc/s H=75.94m s.l.m.

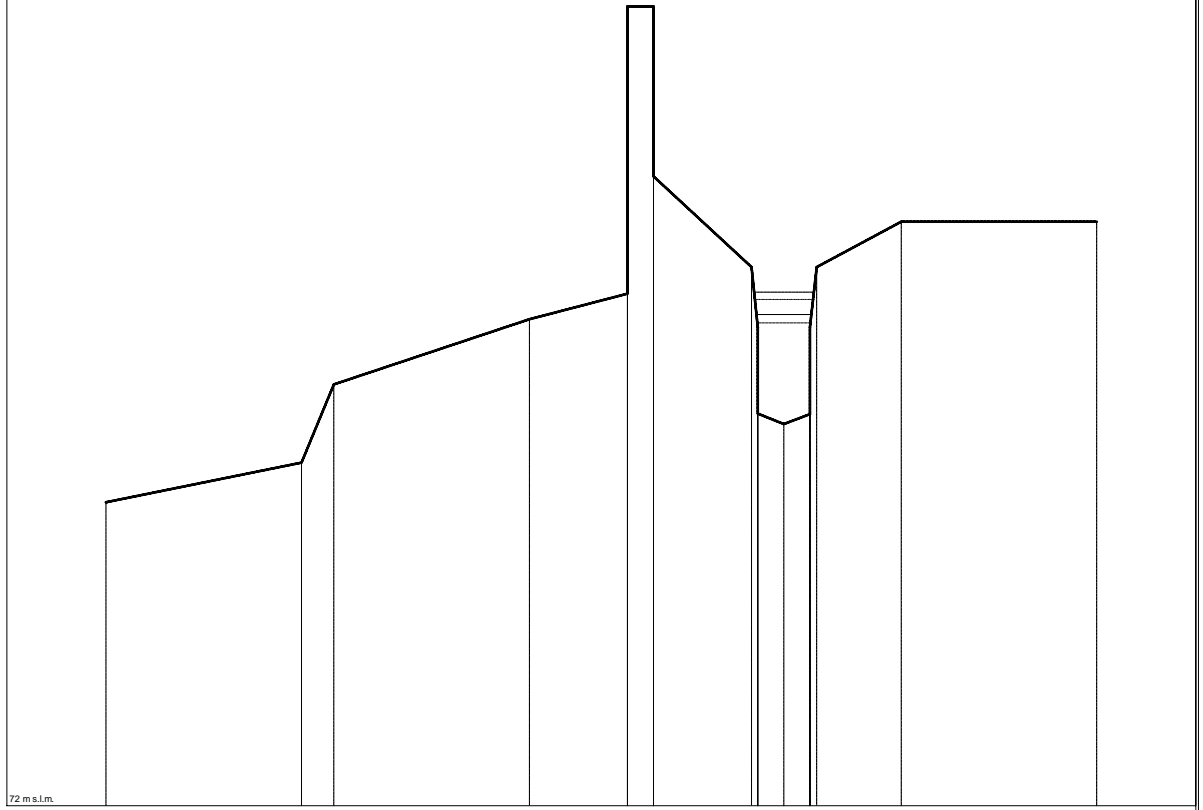

CZ0019_d
 Sezione n. CZ0019_d

Scala distanze 1:80
 Scala quote 1:40

72 m.s.l.m.

Punti	1	2	3	4	5	7	9	12	13	16	17	
Quote [m s.l.m.]	74.33	74.63	75.23	75.73	75.93	76.13	76.13	74.93	75.00	76.48	76.48	
Distanze progressive [m]	-5.8	-2.8	-2.3	0.7	2.2	2.6	4.1	4.6	5.0	6.4	9.4	
Distanze parziali [m]		3.0	0.5	3.0	1.5	0.4	1.5	0.4	0.4	1.3	3.0	

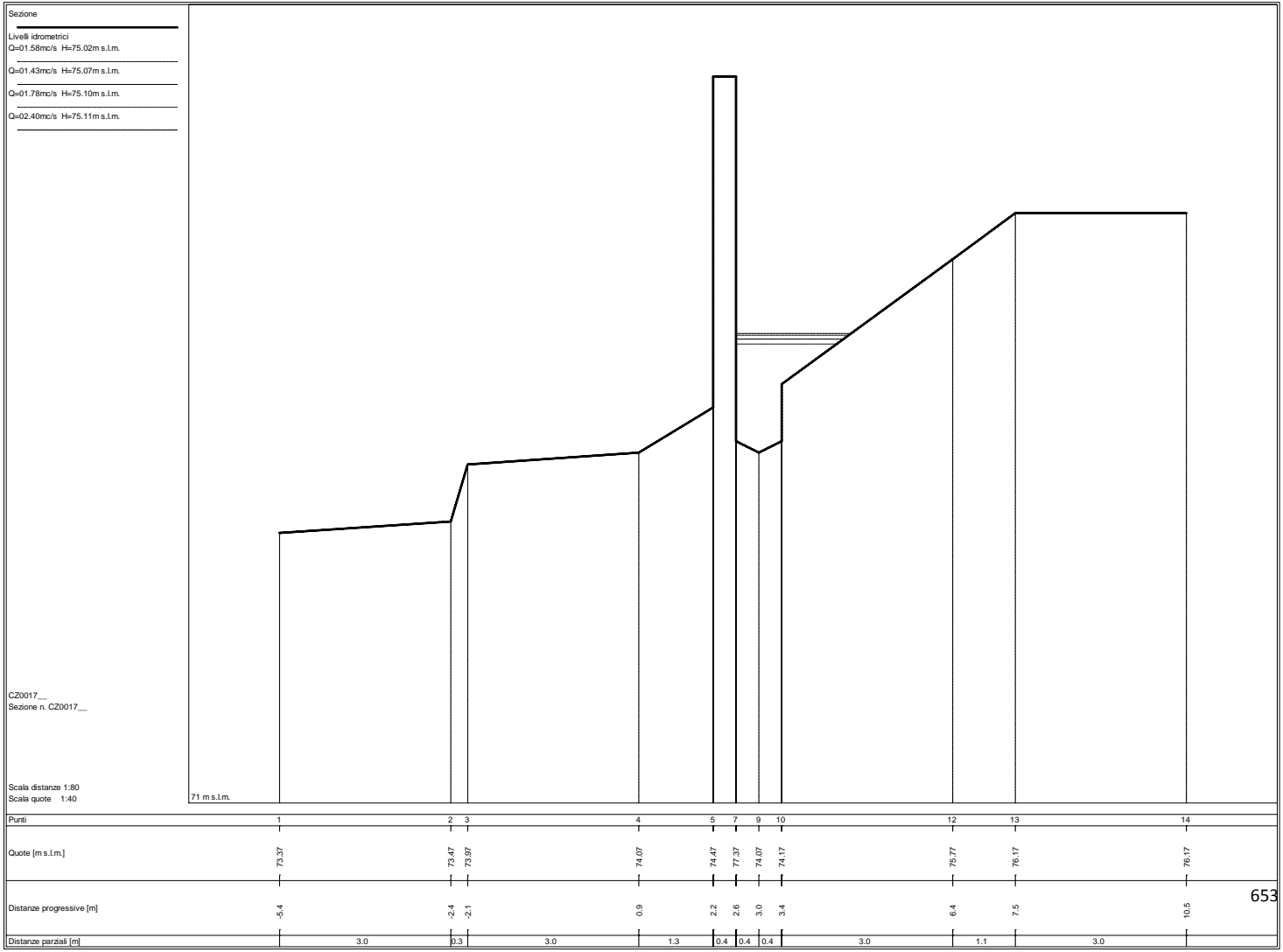
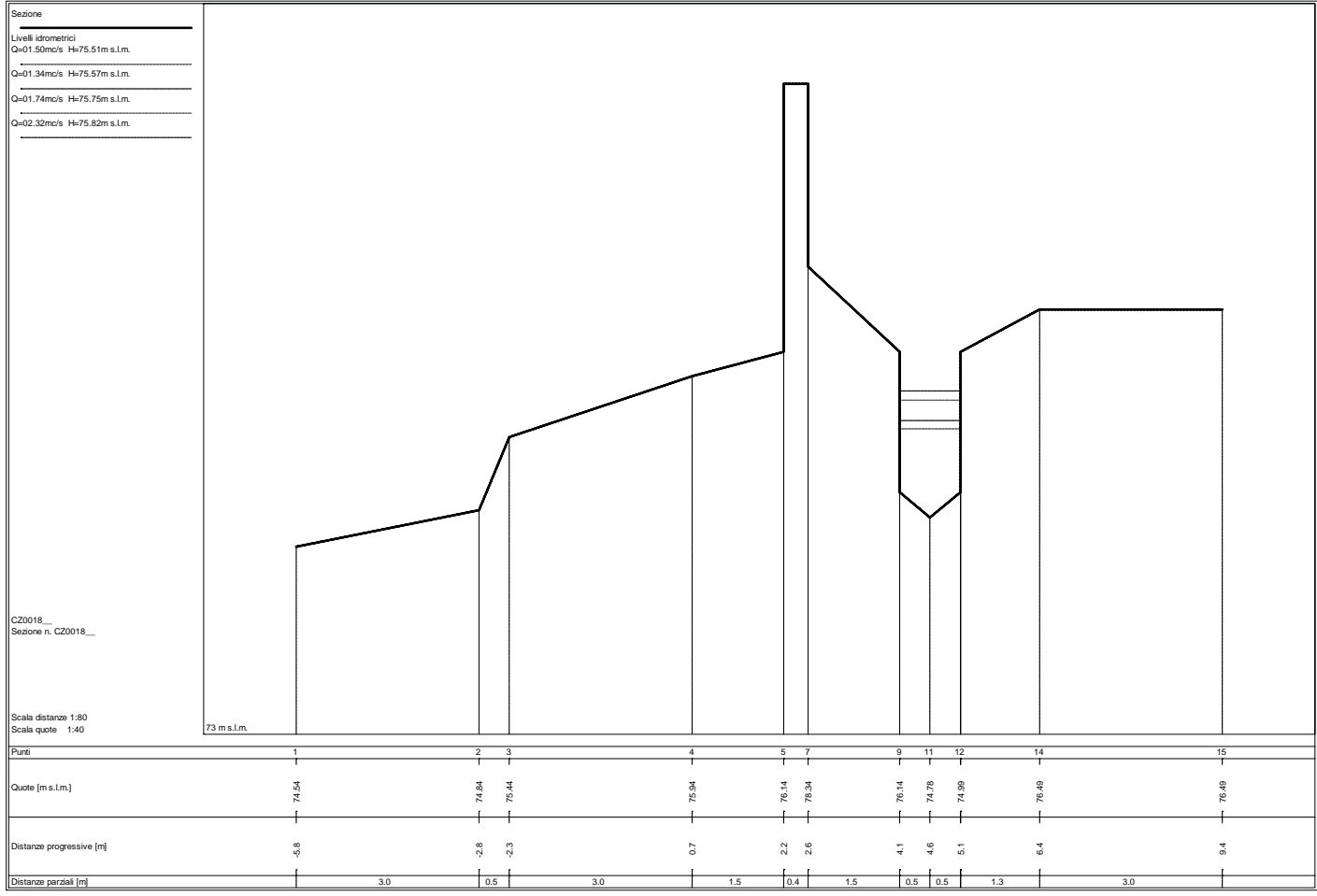

Sezione
 Livelli idrometrici
 Q=01.62mc/s H=74.26m s.l.m.
 Q=01.50mc/s H=74.24m s.l.m.
 Q=01.84mc/s H=74.30m s.l.m.
 Q=02.44mc/s H=74.39m s.l.m.

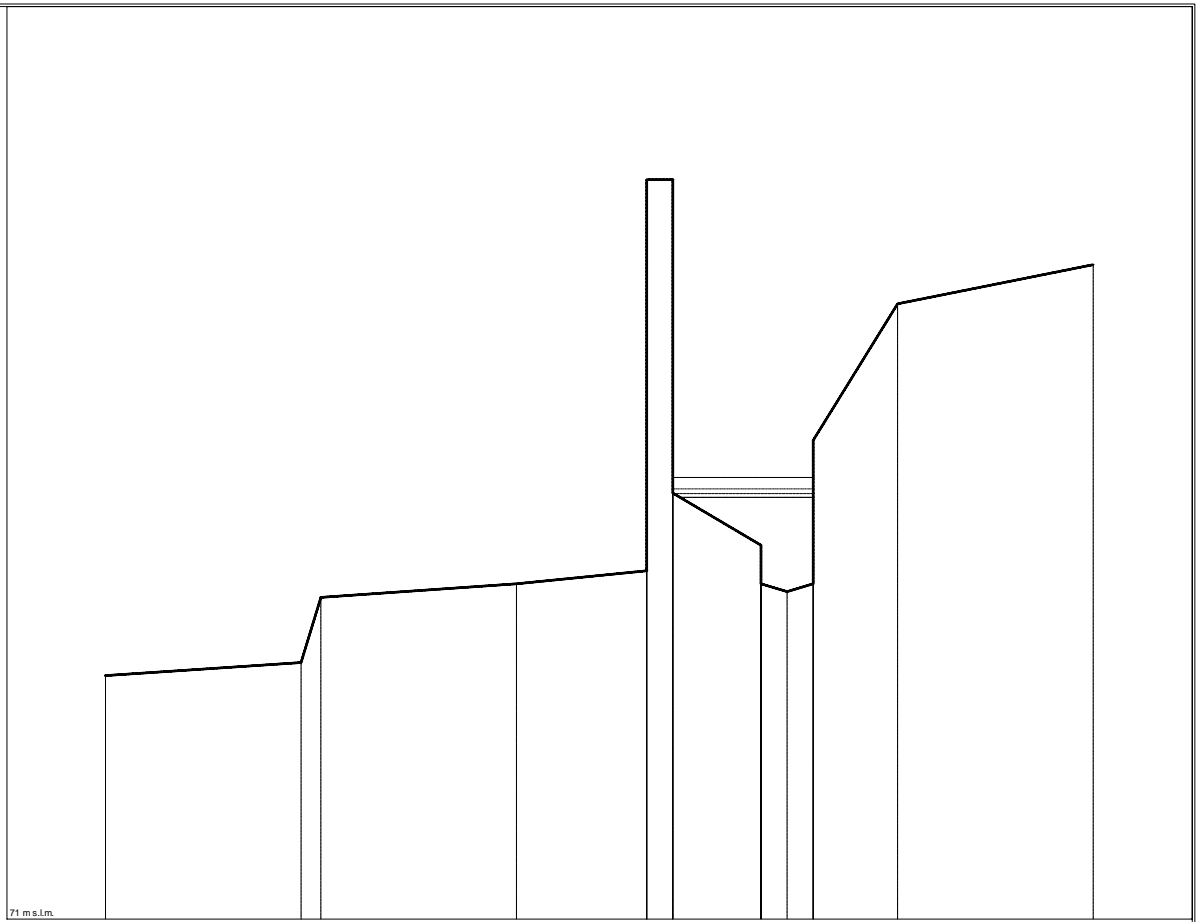

CZ0016_
 Sezione n. CZ0016_

Scala distanze 1:80
 Scala quote 1:40

Punti	1	2	3	4	5	7	9	11	12	14	15
Quote [m s.l.m.]	72.87	72.97	73.47	73.57	73.67	76.67	73.87	73.81	73.57	75.72	76.02
Distanze progressive [m]	-6.1	-3.1	-2.8	0.2	2.2	2.6	3.9	4.3	4.7	6.0	9.0
Distanze parziali [m]		3.0	0.3	3.0	2.0	0.4	1.4	0.4	0.4	1.3	3.0

Sezione
 Livelli idrometrici
 Q=01.61mc/s H=73.09m s.l.m.
 Q=01.51mc/s H=73.06m s.l.m.
 Q=01.87mc/s H=73.17m s.l.m.
 Q=02.43mc/s H=73.33m s.l.m.

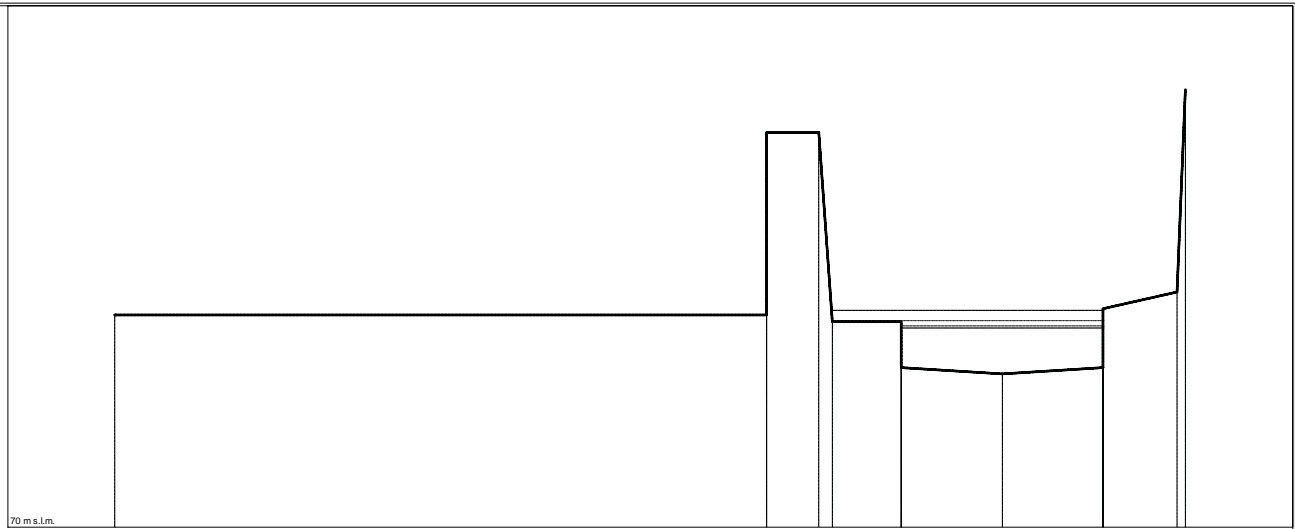

CZ0015_a
 Sezione n. CZ0015_a

Scala distanze 1:40
 Scala quote 1:80

Punti	1	2	4	5	6	8	9	11
Quote [m s.l.m.]	73.26	73.26	76.06	73.15	73.15	72.35	72.45	73.61
Distanze progressive [m]	-2.8	2.2	2.6	2.7	3.2	4.0	4.7	5.3
Distanze parziali [m]		5.0	0.4	0.5	0.8	0.8	0.6	

Sezione

Porte

Livelli idrometrici

Q=0.61mc/s H=73.04m s.l.m.

Q=0.52mc/s H=73.02m s.l.m.

Q=0.87mc/s H=73.12m s.l.m.

Q=0.43mc/s H=73.25m s.l.m.

CZ0015_b
Sezione n. CZ0015_b

Scala distanze 1:40
Scala quote 1:80

70 m s.l.m.

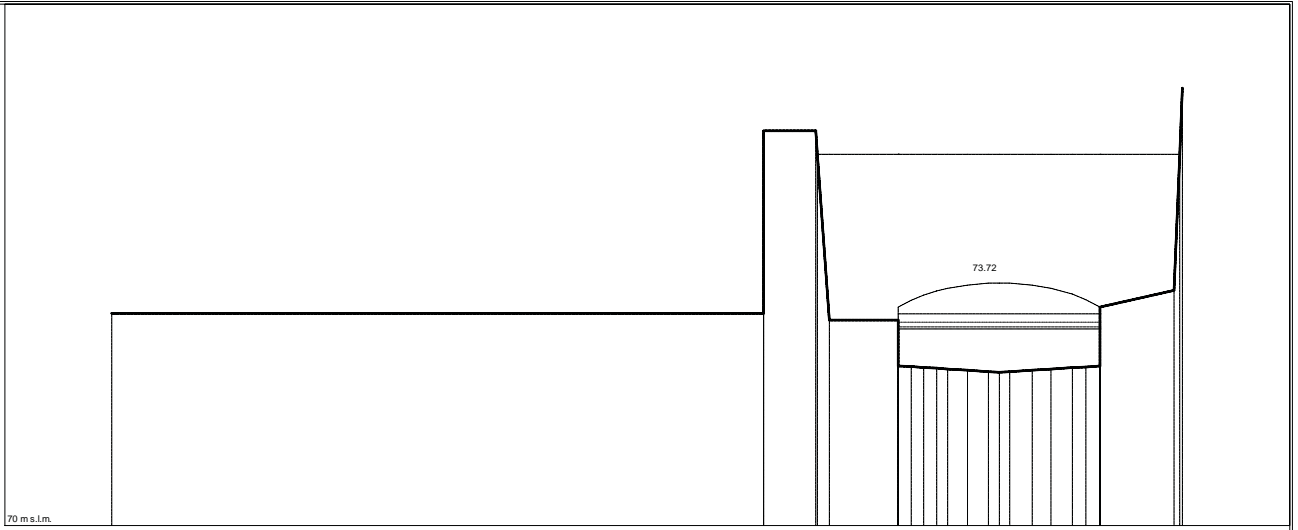

Punti	1	2	4	6	7	10	11	12	14	15	17	18	19	20	21	22	24
Quote [m s.l.m.]	73.26	73.26	76.06	73.15	73.15	72.44	72.43	72.41	72.38	72.36	72.36	72.38	72.40	72.42	72.44	72.45	73.61
Distanze progressive [m]	-2.8	2.2	2.6	2.7	3.2	3.3	3.4	3.5	3.7	3.9	4.1	4.2	4.4	4.5	4.6	4.7	5.3
Distanze parziali [m]			0.4		0.5				0.2	0.2		0.2	0.1	0.2			0.6

Sezione

Porte

Livelli idrometrici

Q=0.61mc/s H=72.89m s.l.m.

Q=0.52mc/s H=72.87m s.l.m.

Q=0.88mc/s H=72.94m s.l.m.

Q=0.43mc/s H=73.05m s.l.m.

CZ0014_c
Sezione n. CZ0014_c

Scala distanze 1:40
Scala quote 1:80

70 m s.l.m.

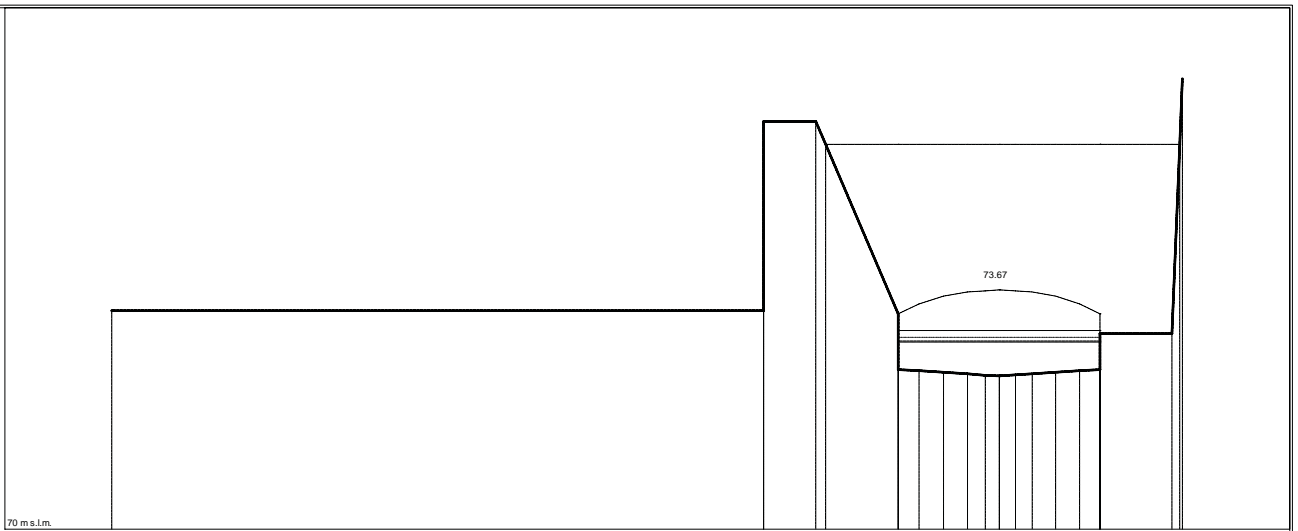

Punti	1	2	4	6	8	9	10	11	12	14	15	16	17	18	21
Quote [m s.l.m.]	73.96	73.96	76.26	73.30	72.43	72.41	72.38	72.36	72.35	72.37	72.38	72.41	72.43	72.45	73.00
Distanze progressive [m]	-2.8	2.2	2.6	3.2	3.4	3.5	3.7	3.9	4.0	4.1	4.2	4.4	4.6	4.7	5.3
Distanze parziali [m]			0.4	0.6	0.2	0.2	0.2					0.2	0.2	0.2	0.5

Sezione
 Livelli idrometrici
 Q=01.61mc/s H=72.81m s.l.m.
 Q=01.52mc/s H=72.80m s.l.m.
 Q=01.88mc/s H=72.87m s.l.m.
 Q=02.43mc/s H=72.98m s.l.m.

CZ0014_d
 Sezione n. CZ0014_d

Scala distanze 1:40
 Scala quote 1:80

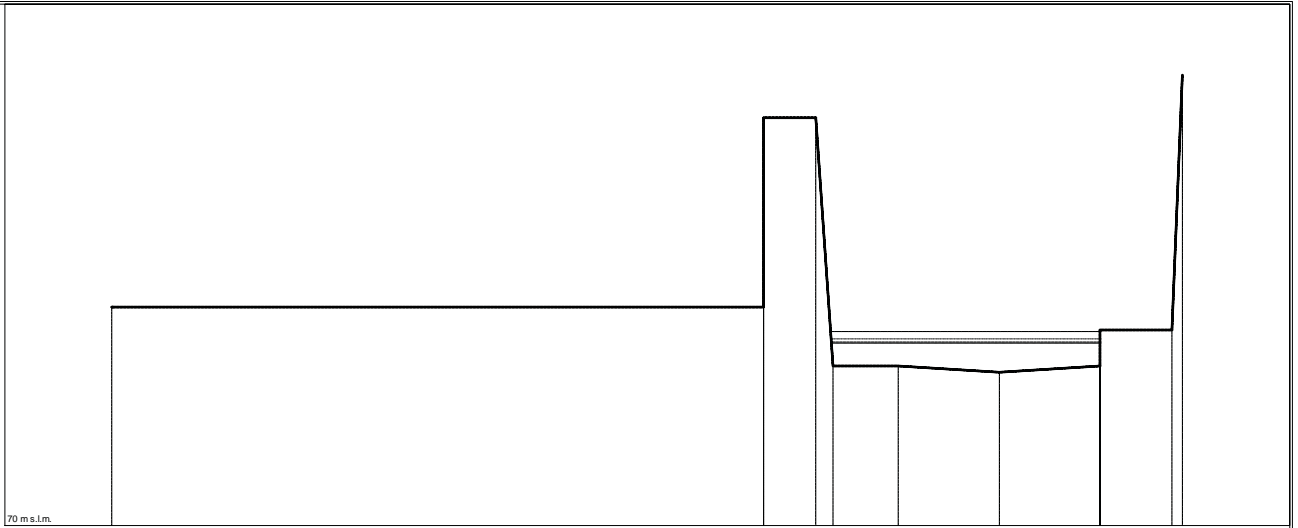

Punti	1	2	4	5	6	7	8	10
Quote [m s.l.m.]	73.96	73.98	76.26	72.45	72.45	72.35	72.45	73.00
Distanze progressive [m]	-2.8	2.2	2.6	2.7	3.2	4.0	4.8	5.3
Distanze parziali [m]		5.0	0.4	0.5	0.8	0.8	0.6	

Sezione
 Livelli idrometrici
 Q=01.61mc/s H=72.45m s.l.m.
 Q=01.53mc/s H=72.44m s.l.m.
 Q=01.89mc/s H=72.49m s.l.m.
 Q=02.43mc/s H=72.57m s.l.m.

CZ0013_
 Sezione n. CZ0013_

Scala distanze 1:40
 Scala quote 1:40

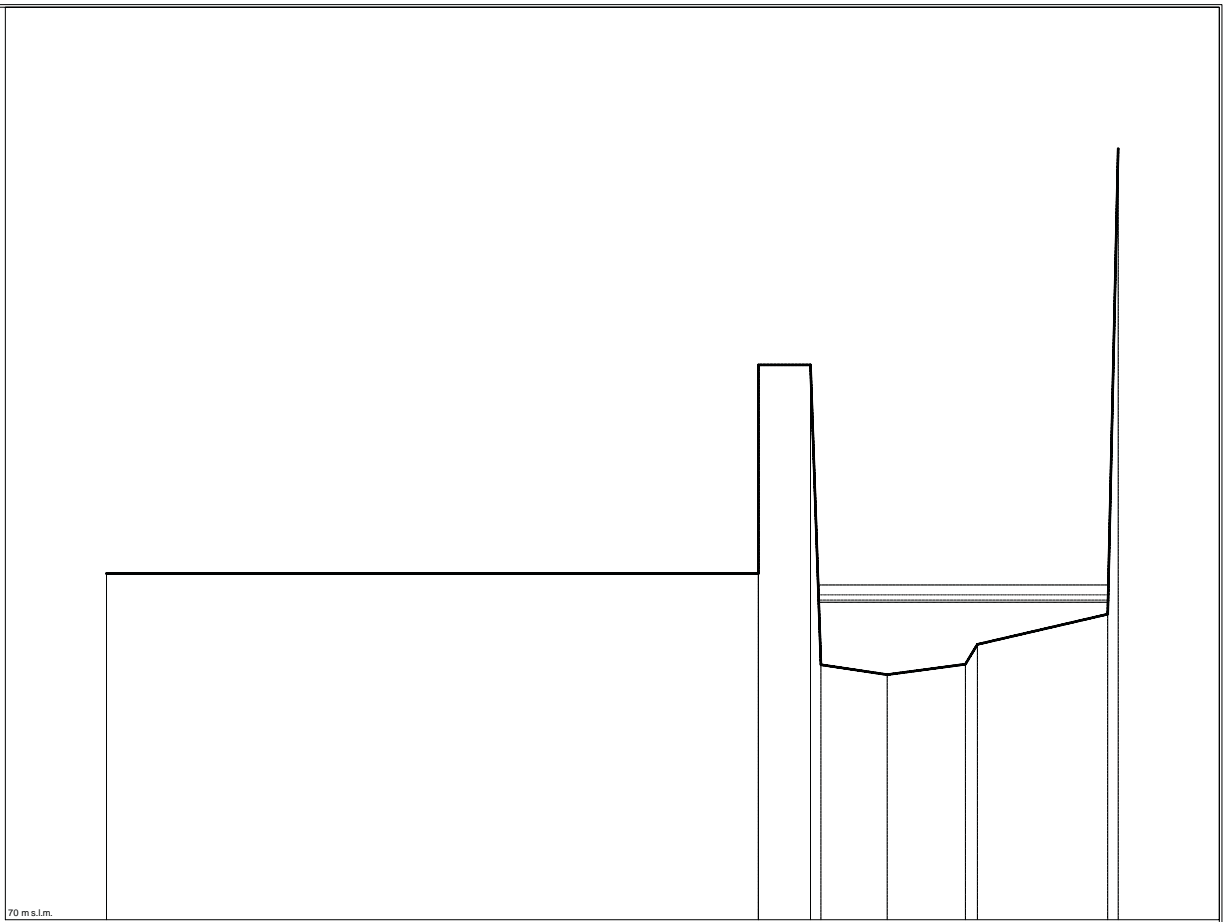

Punti	1	2	4	6	7	8	9
Quote [m s.l.m.]	72.86	72.86	74.26	71.89	71.96	72.11	72.34
Distanze progressive [m]	-2.6	2.4	2.8	3.4	4.0	4.1	5.1
Distanze parziali [m]		5.0	0.4	0.5	0.6	1.0	

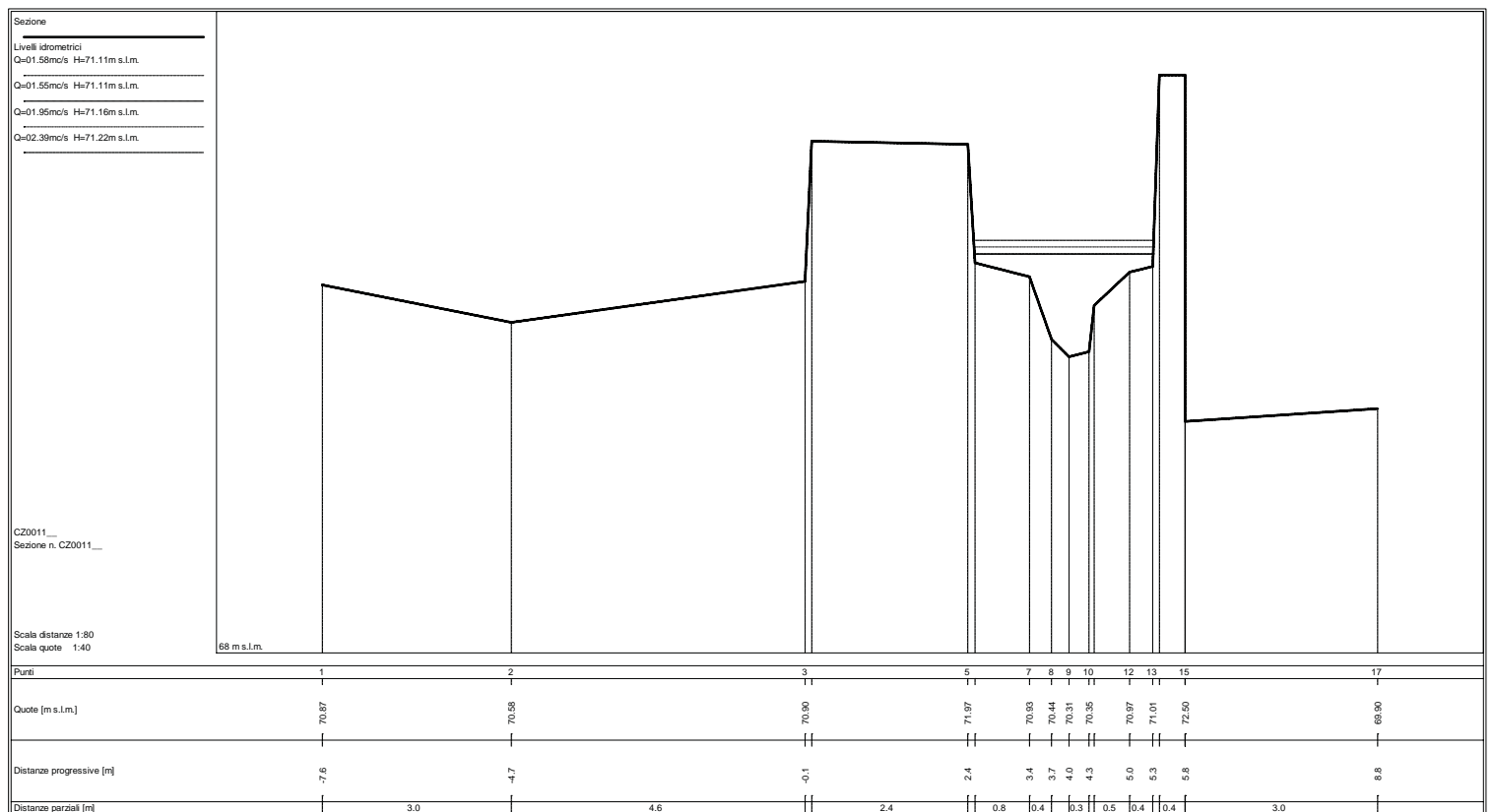
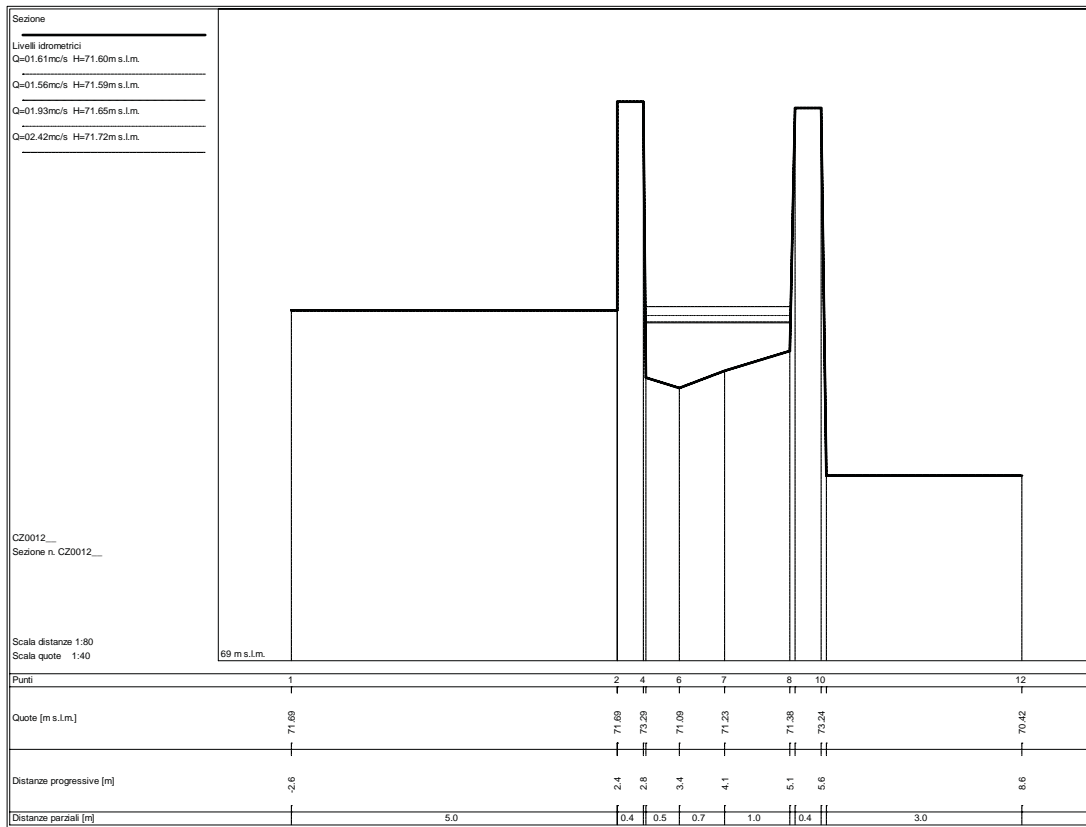

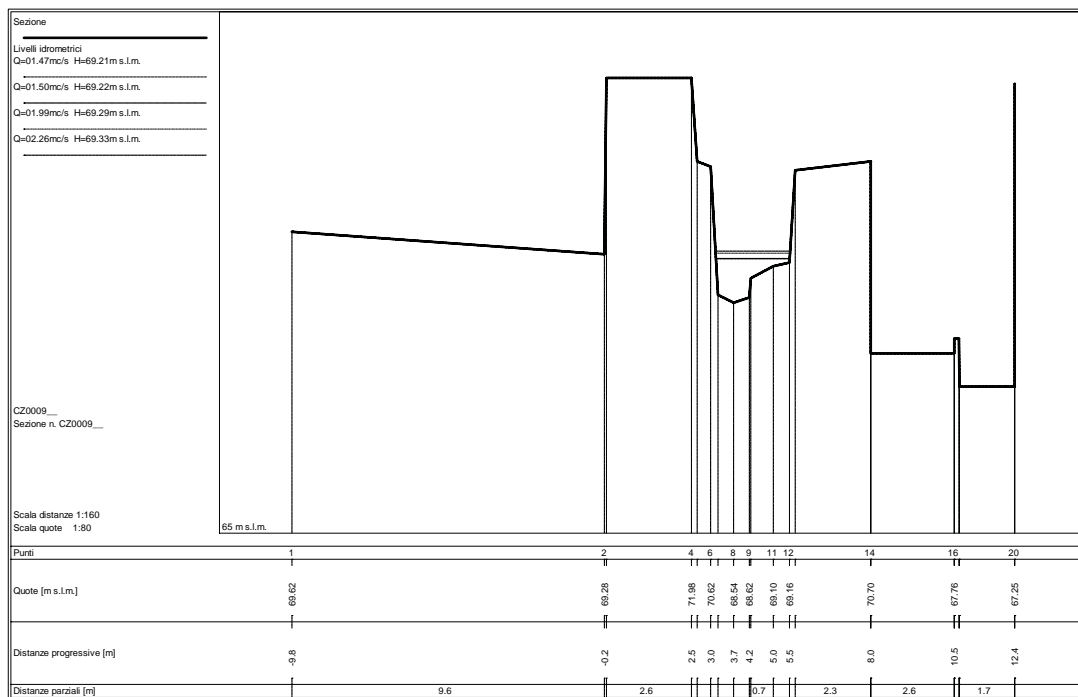
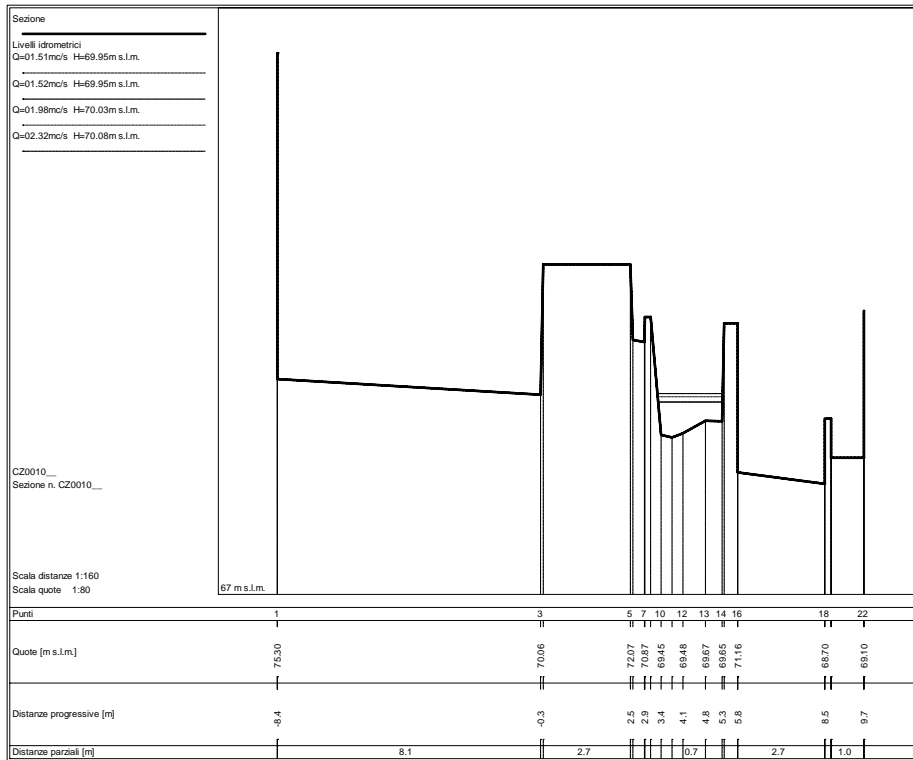

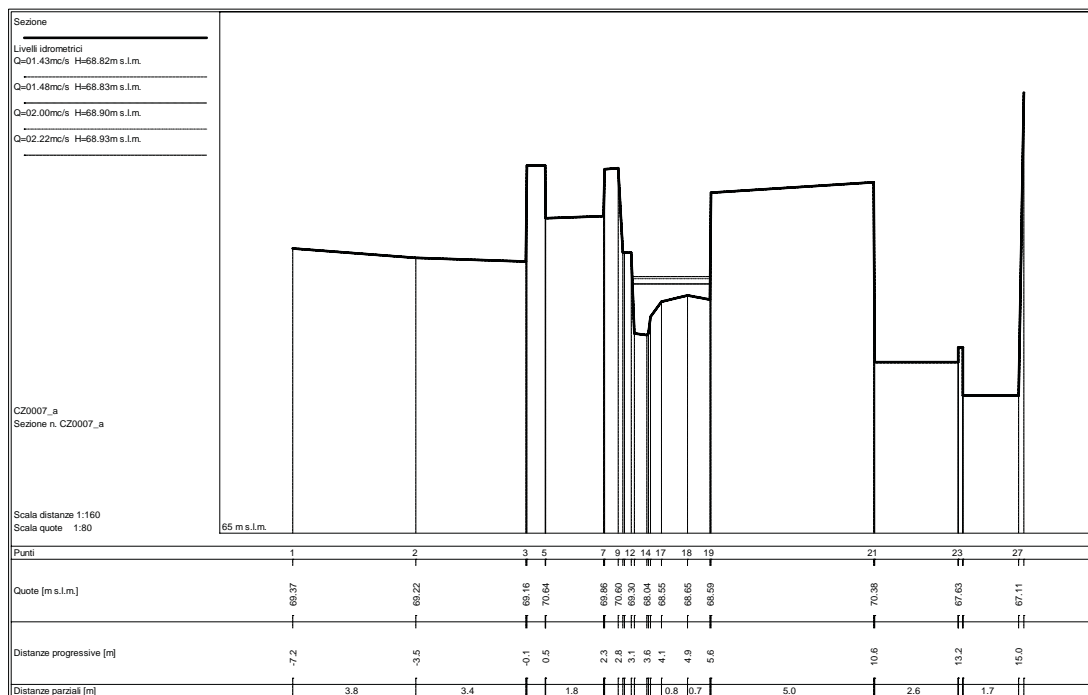
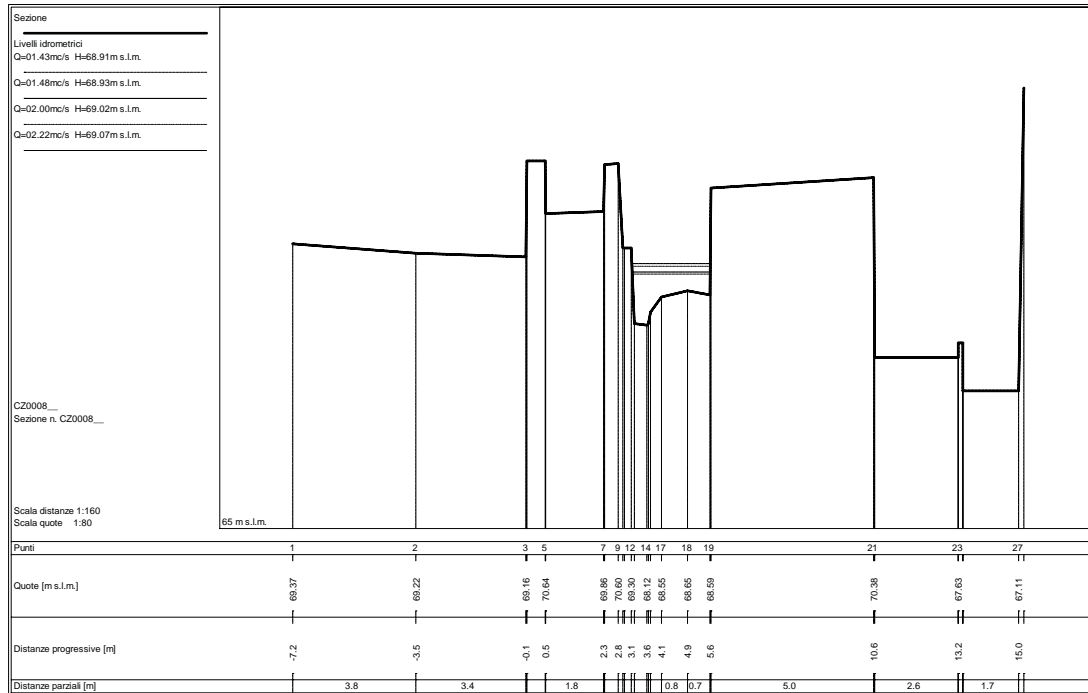

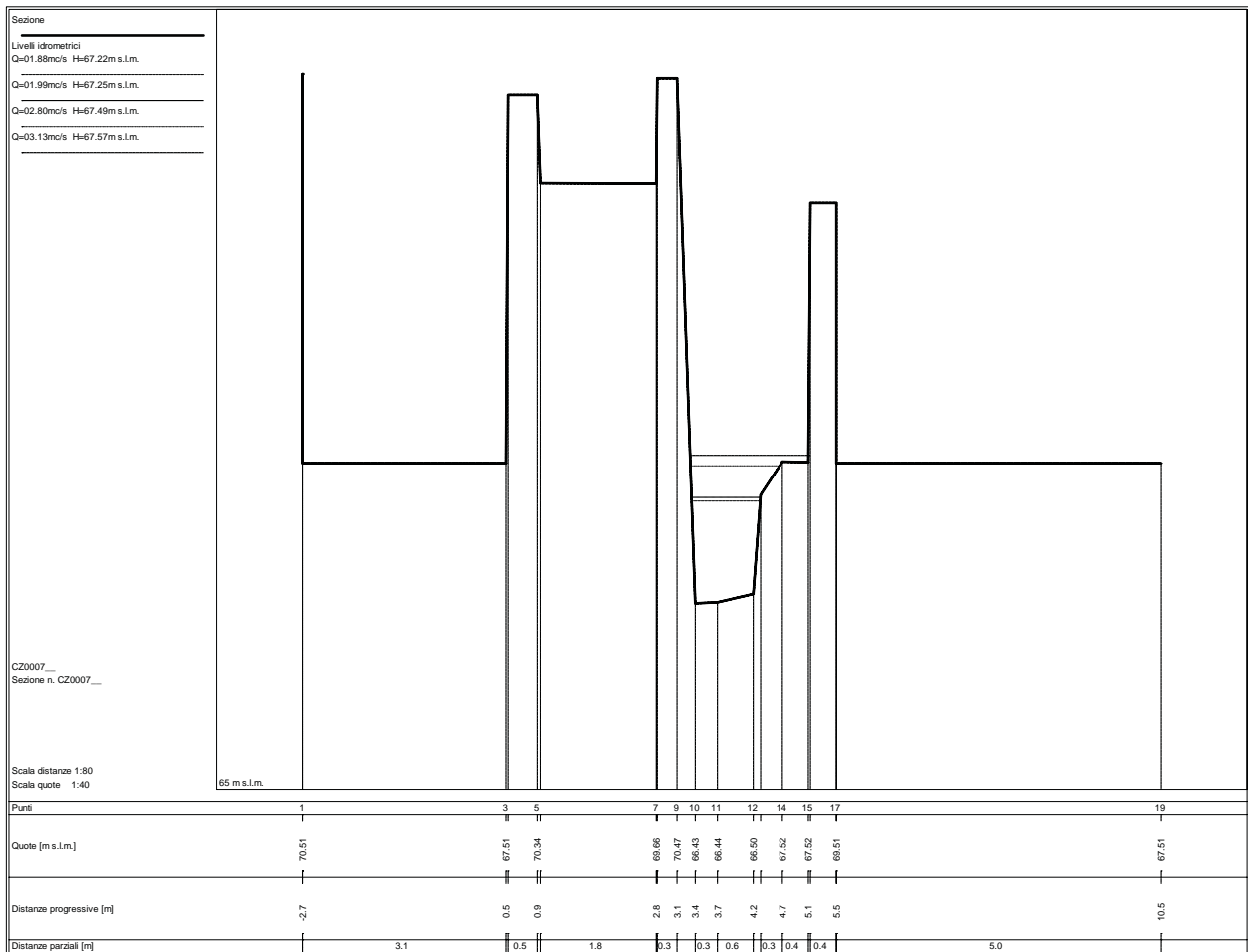
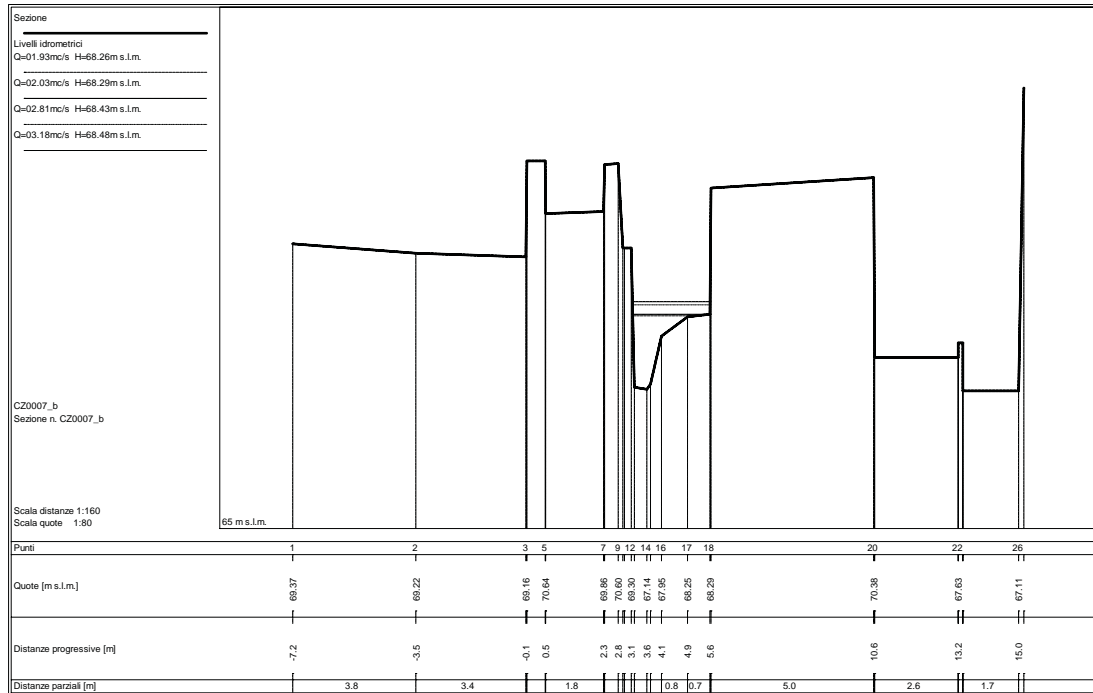

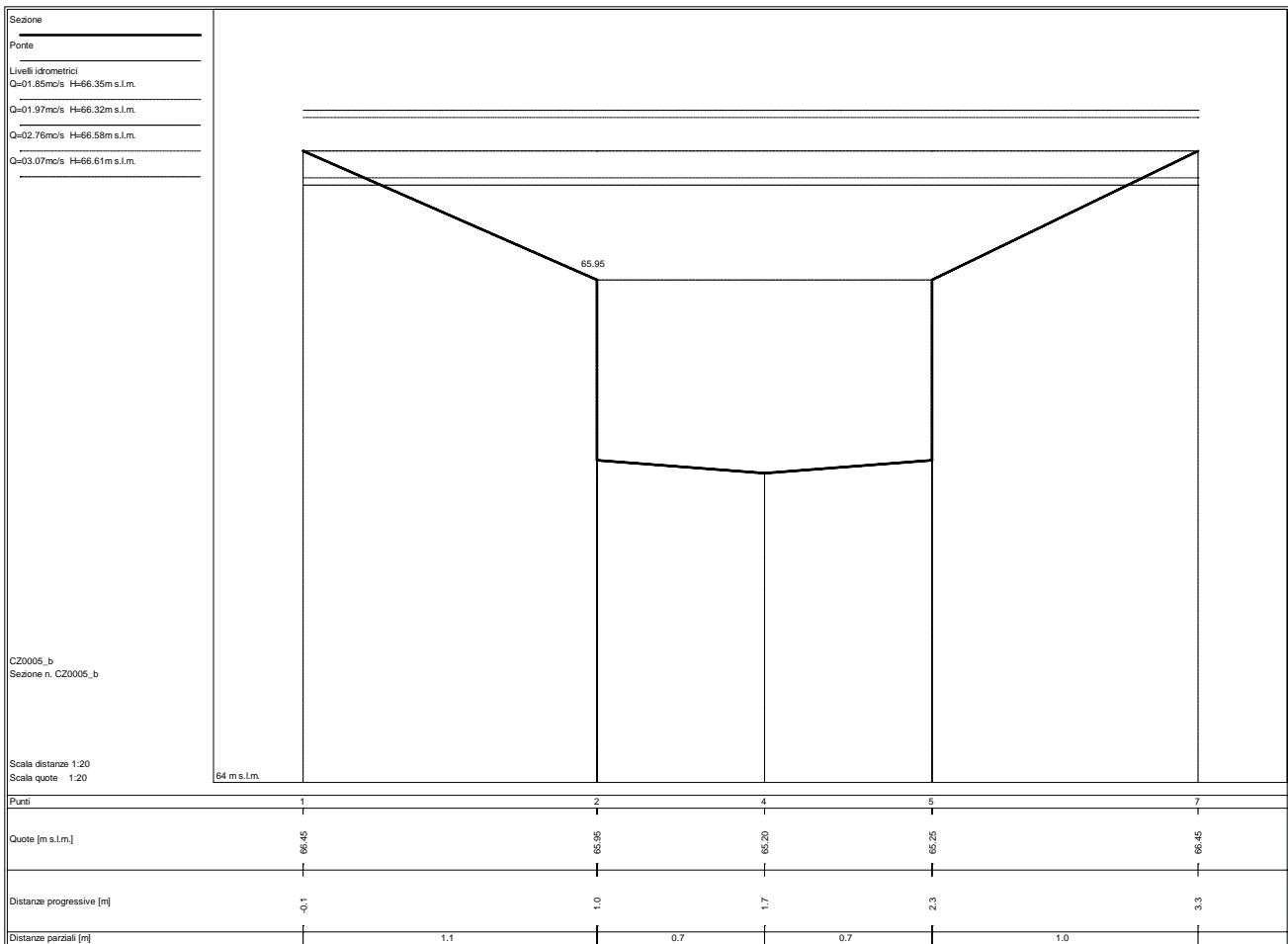
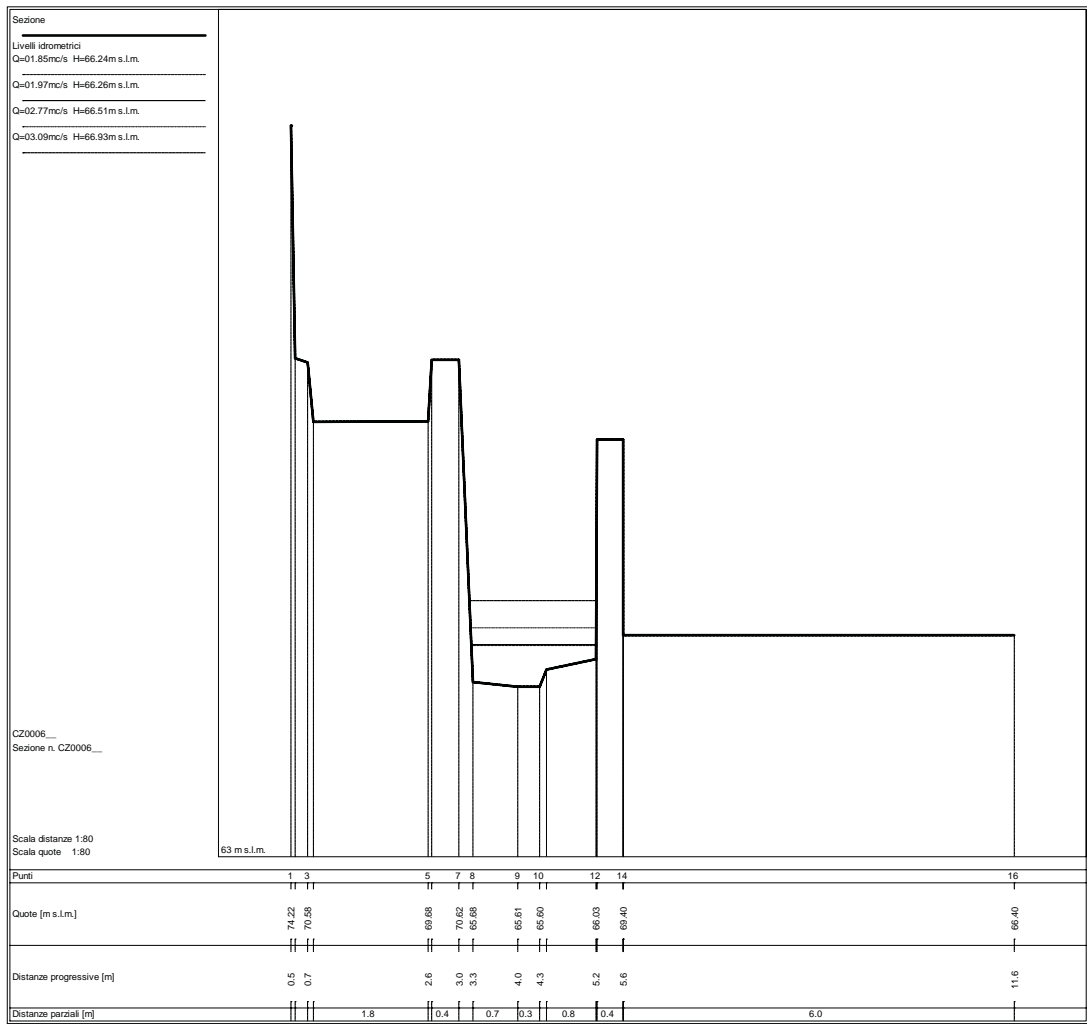

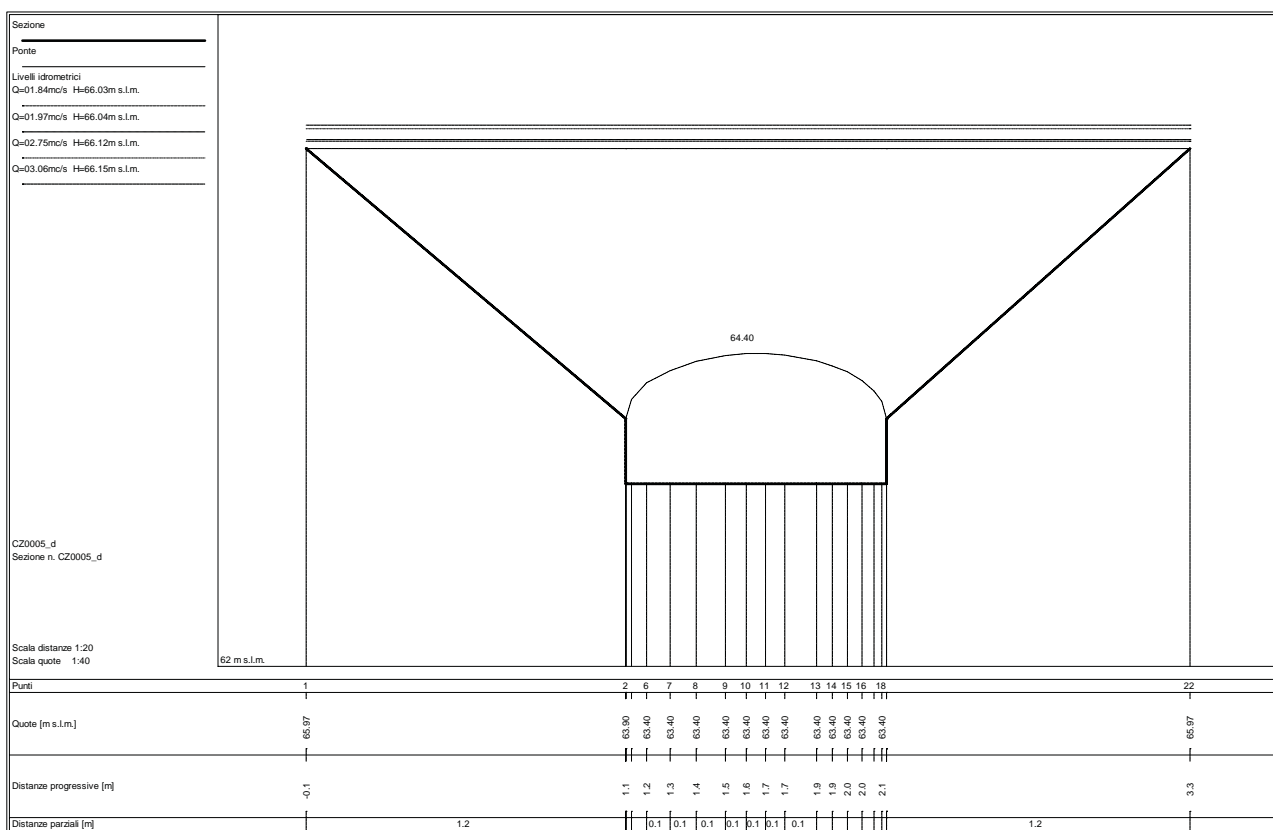
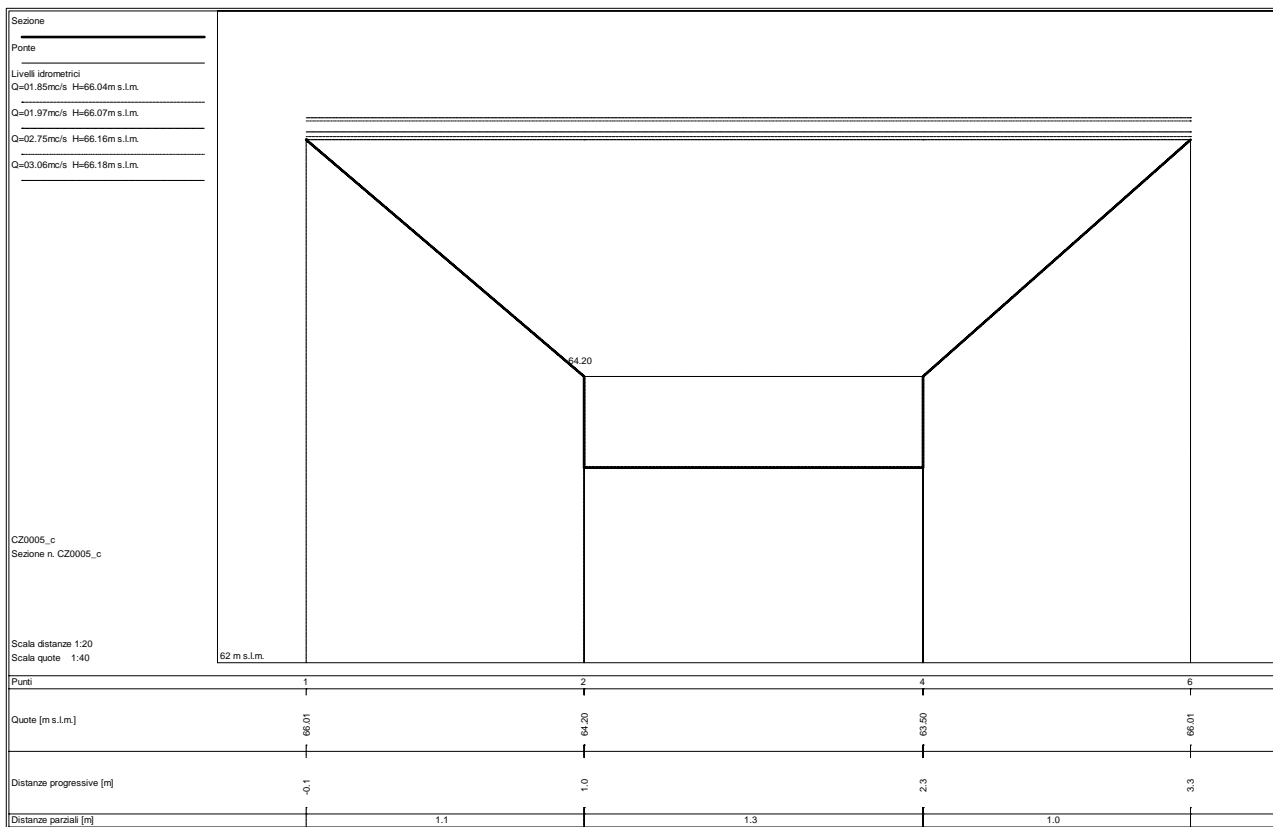

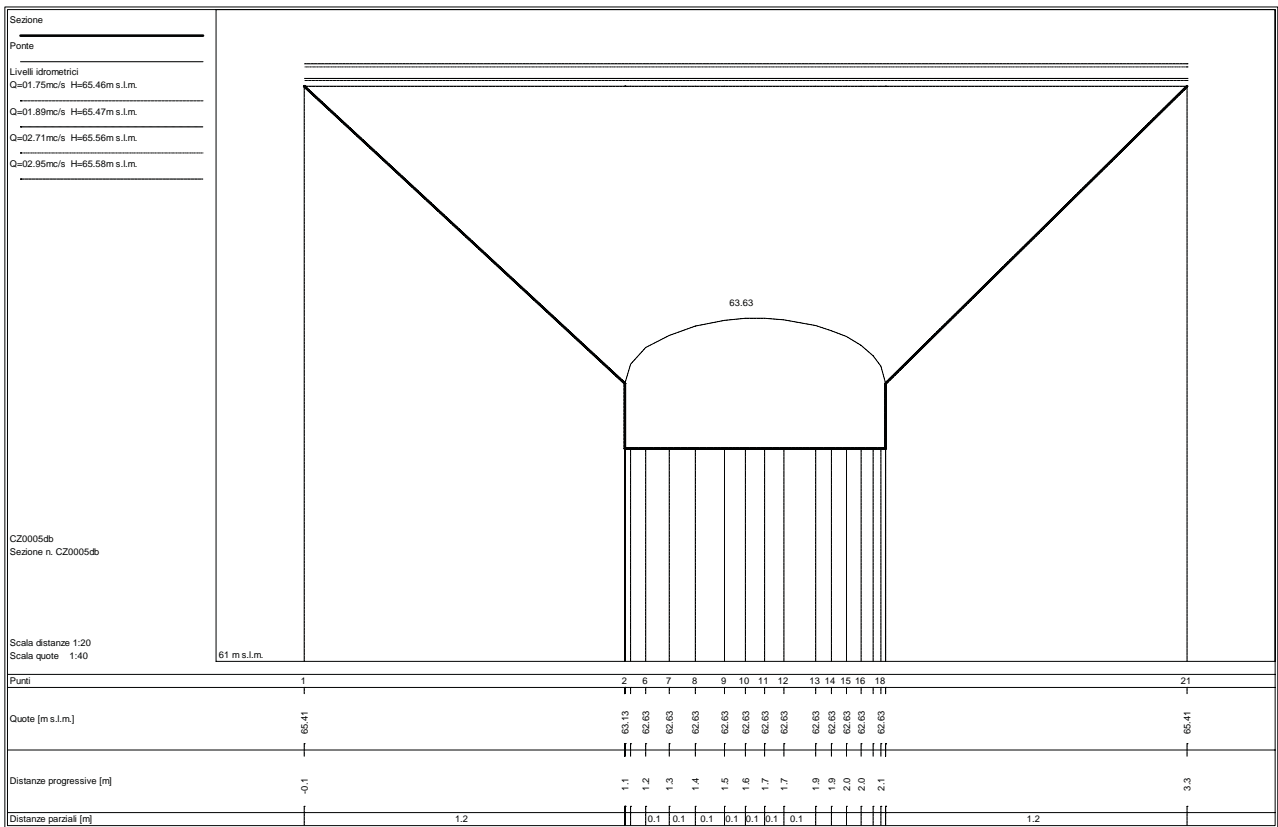
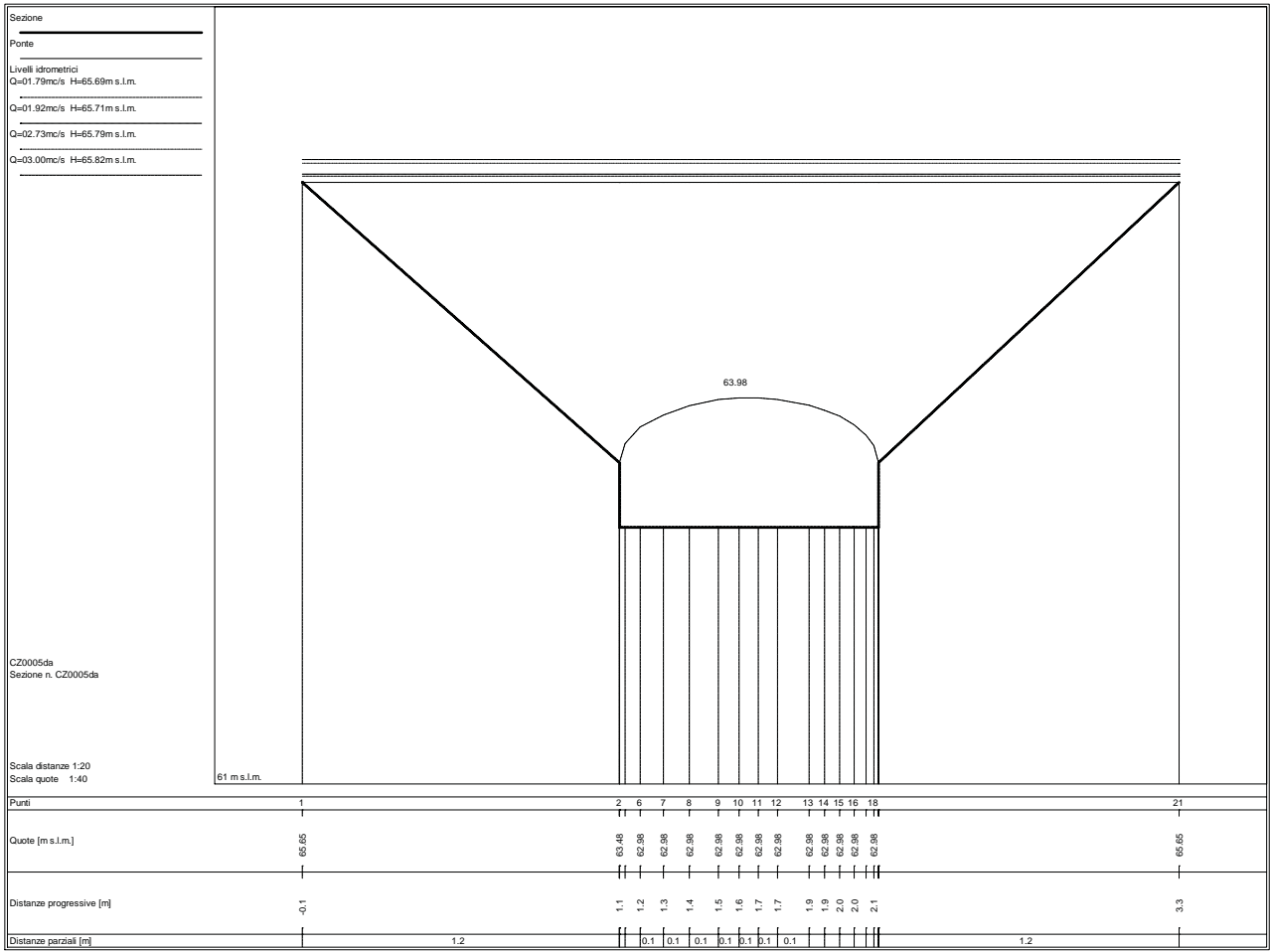

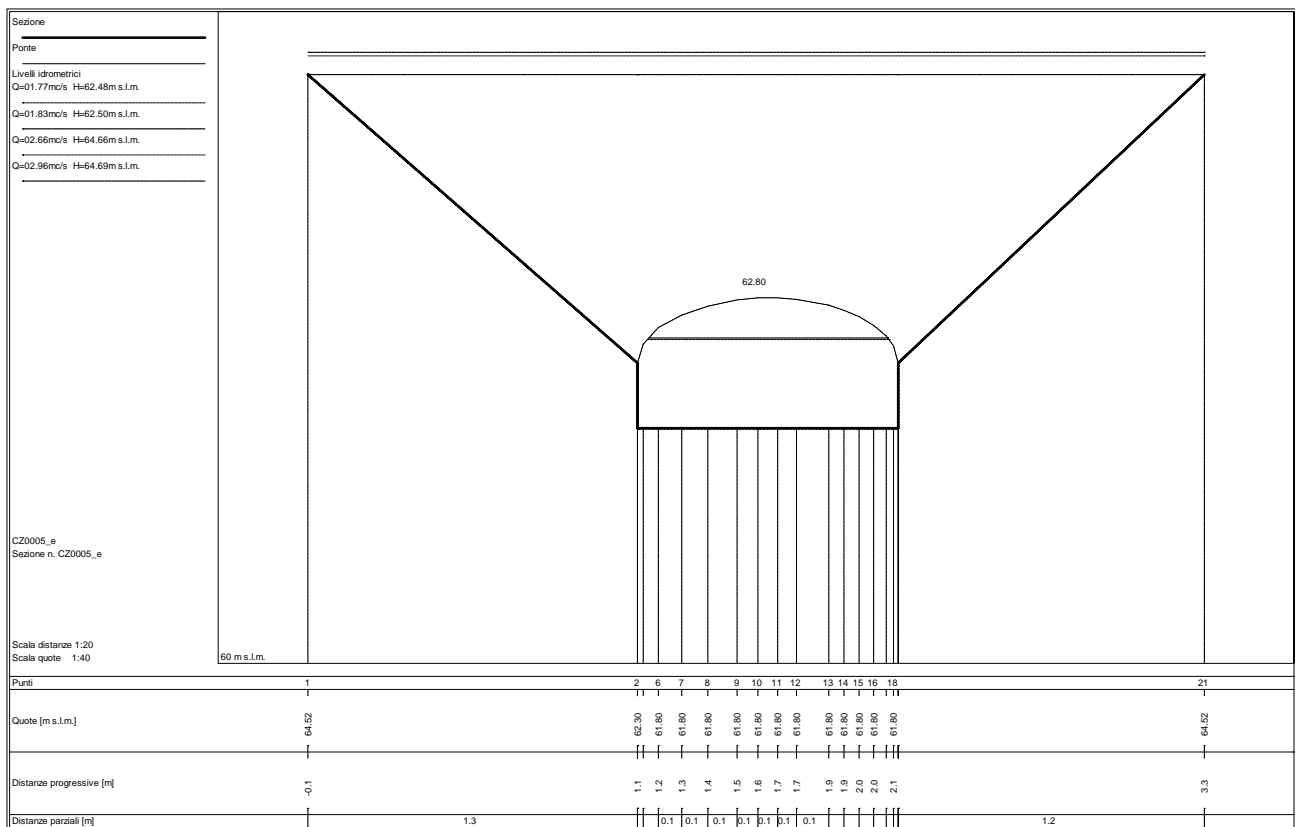
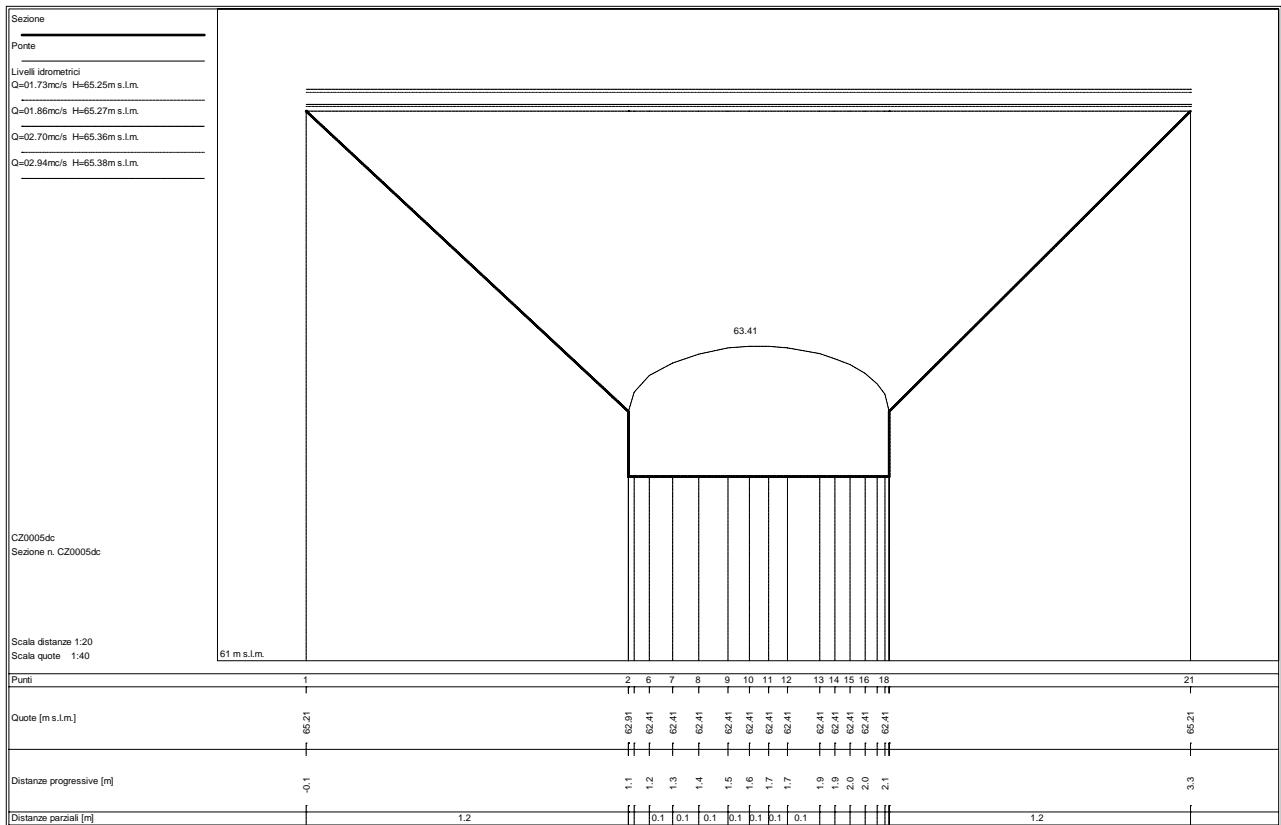

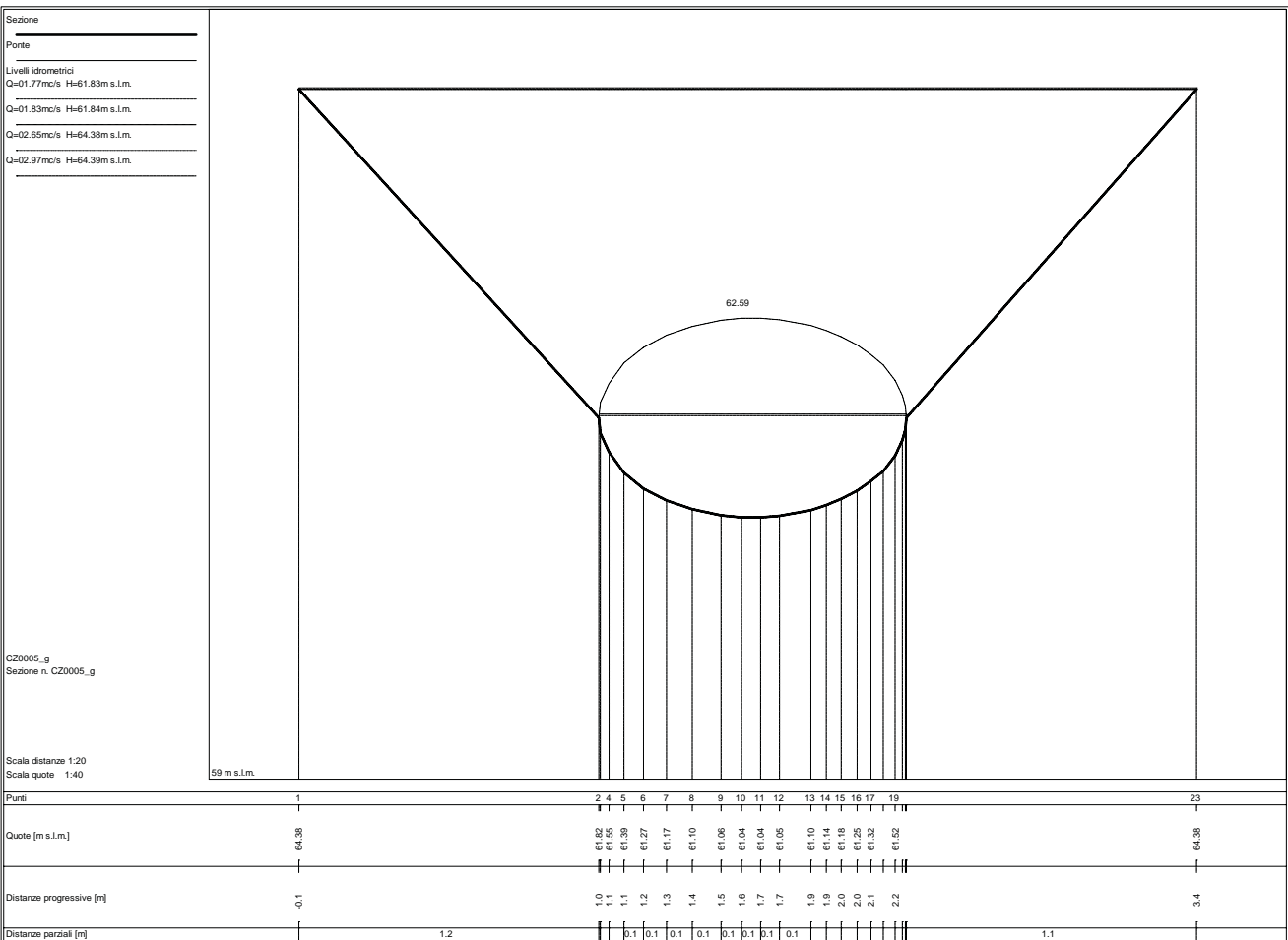
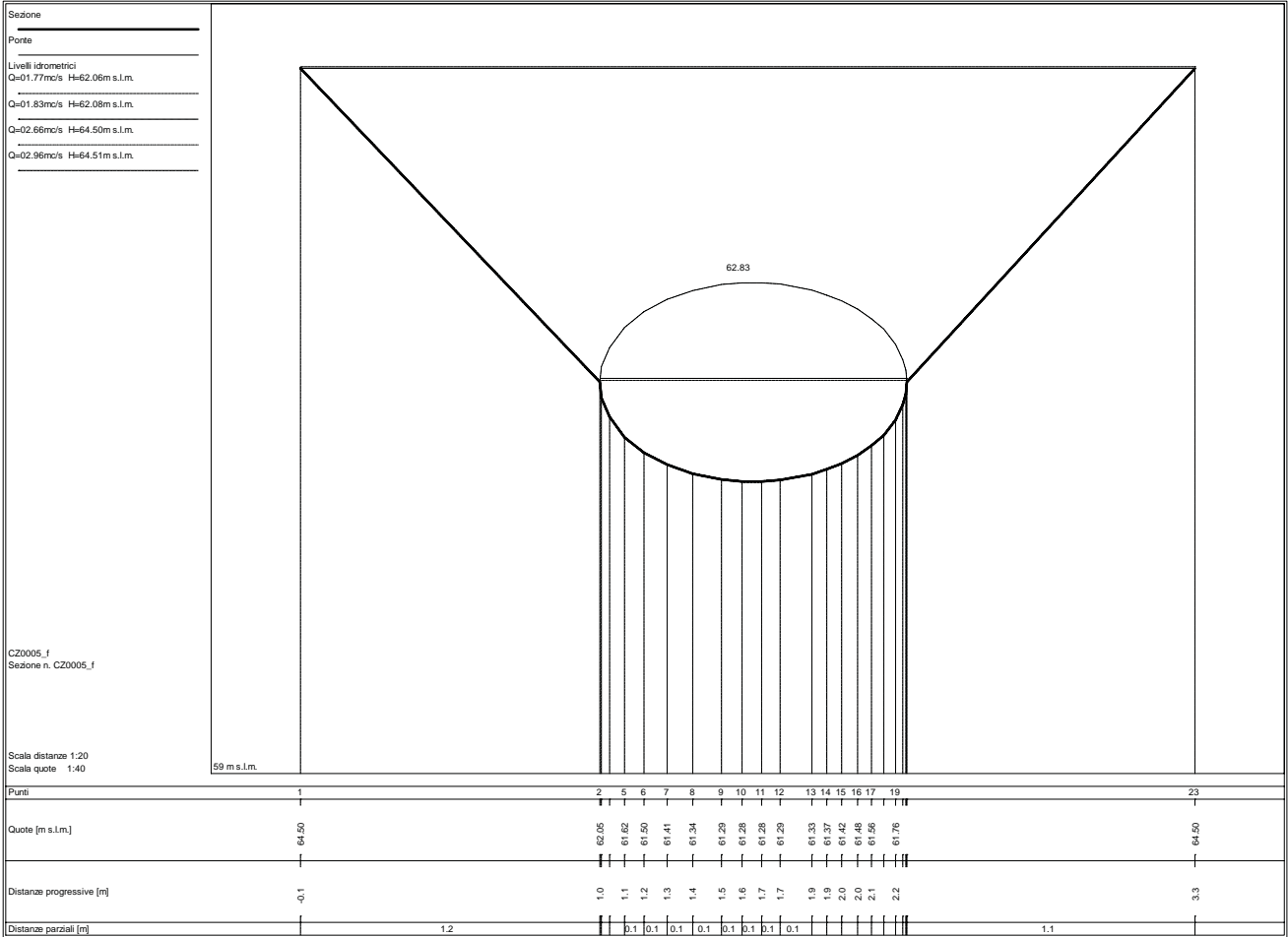

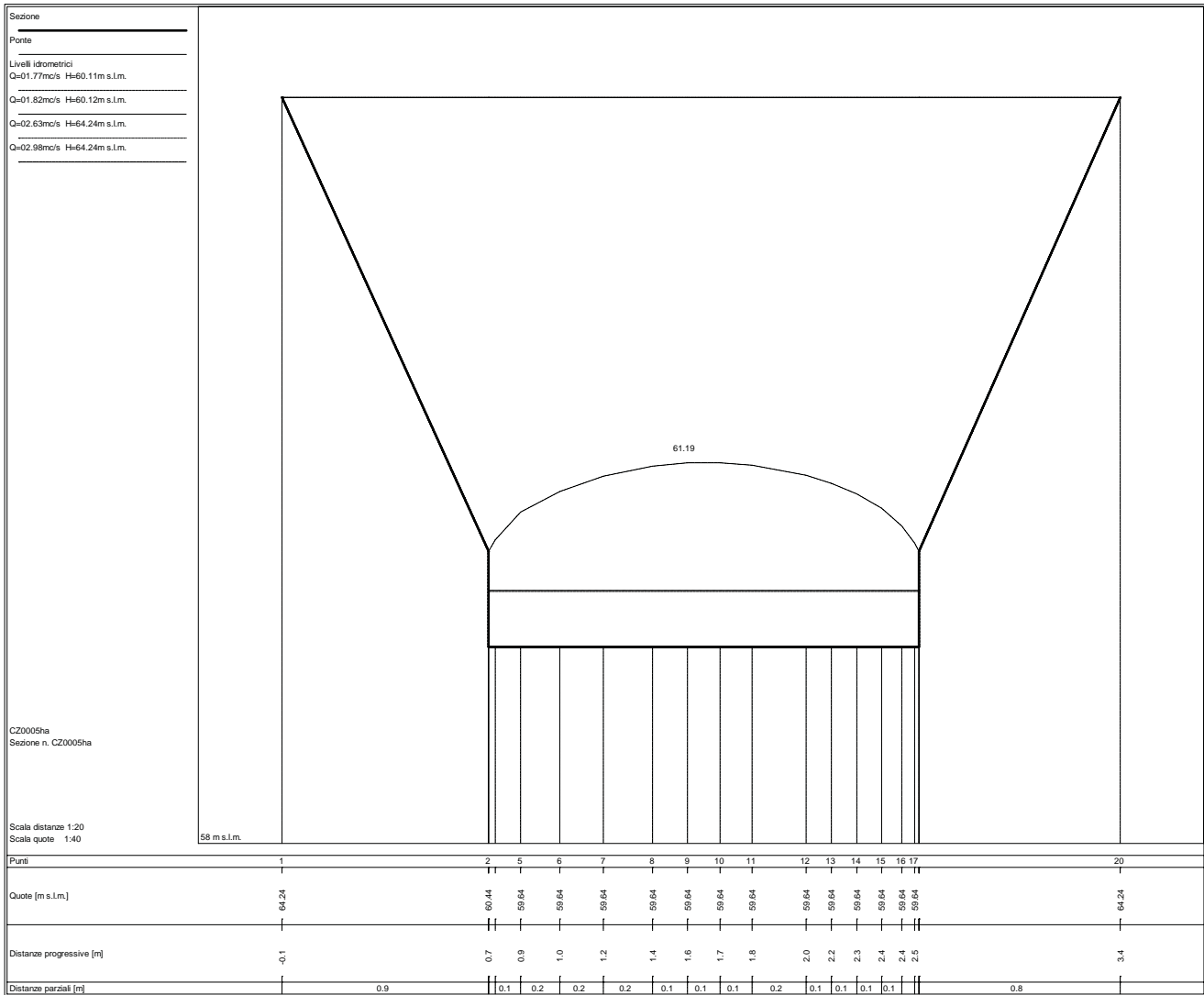
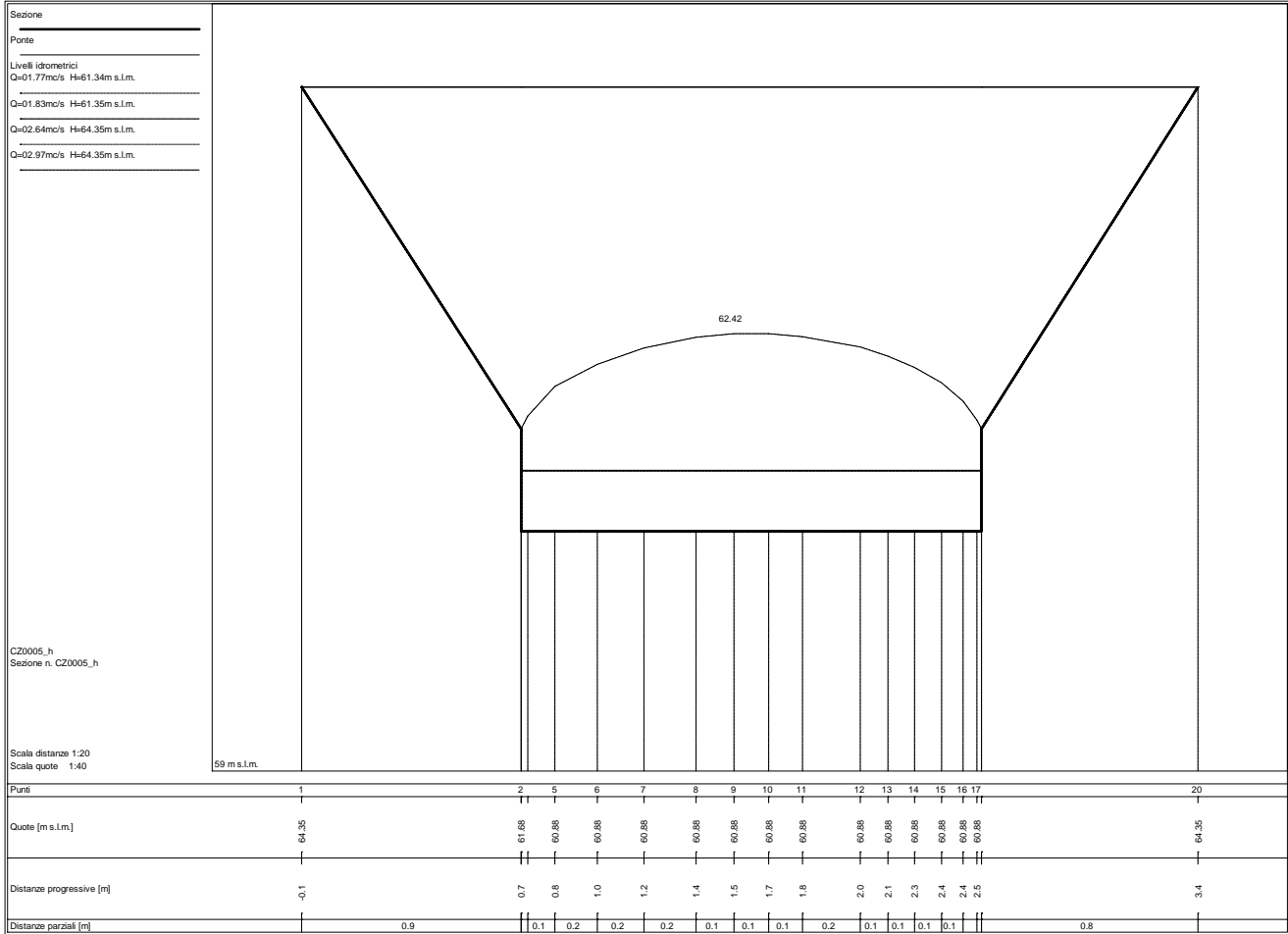

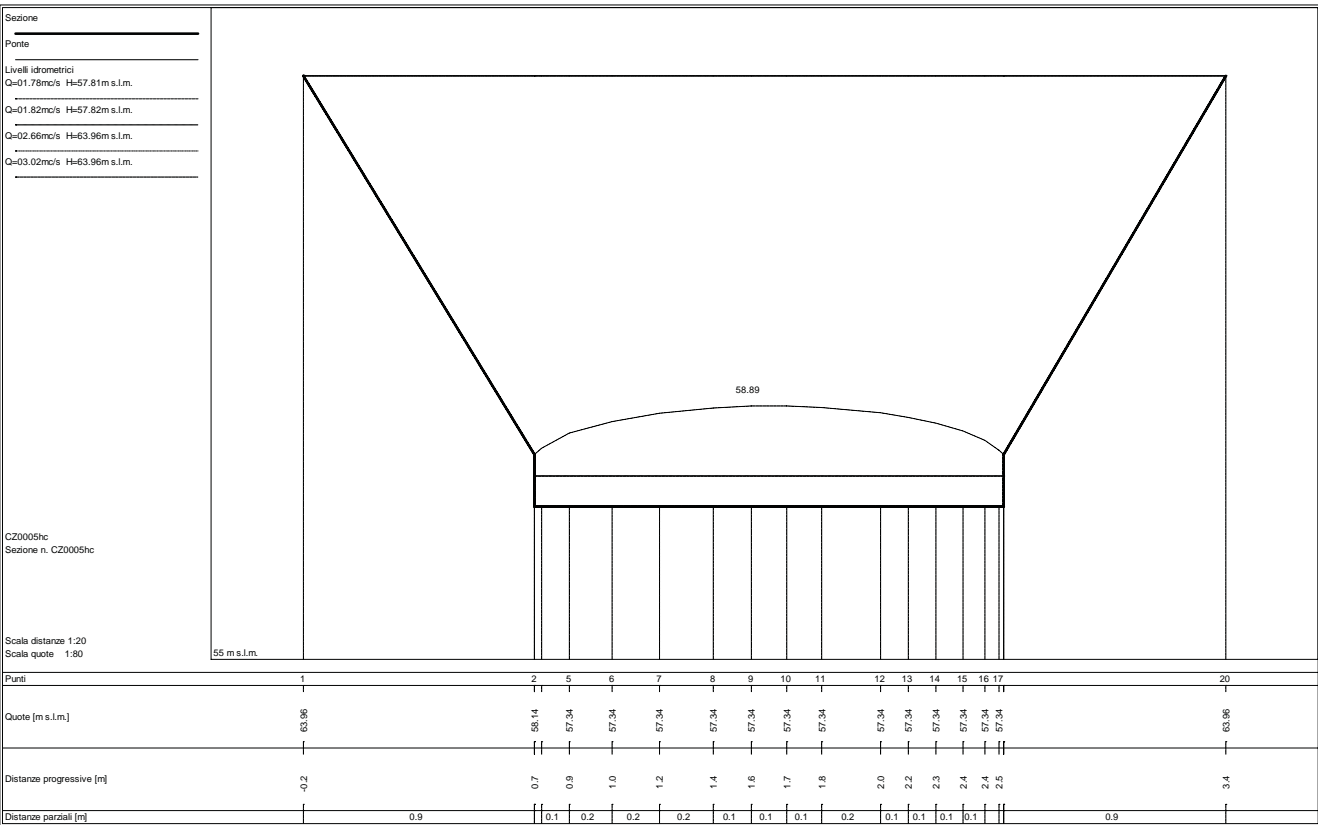
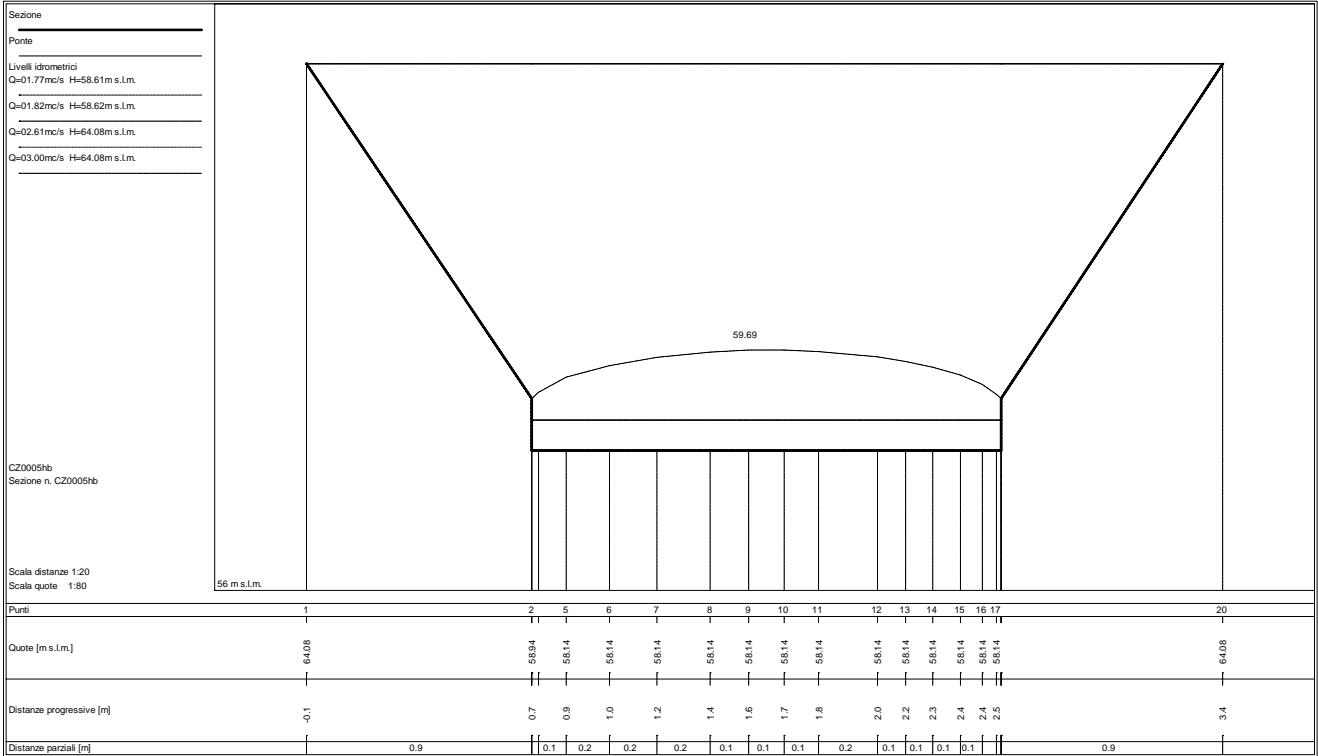

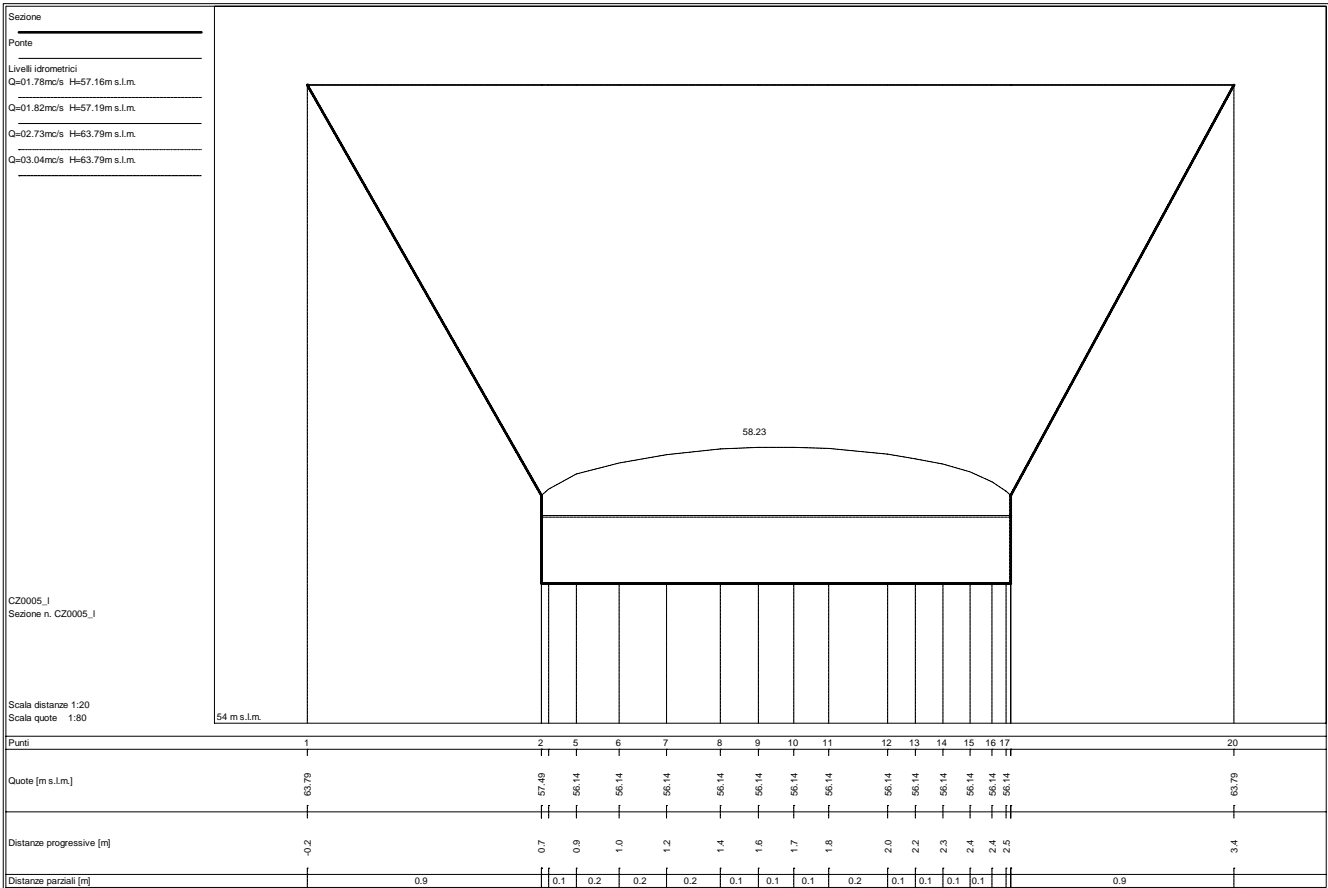
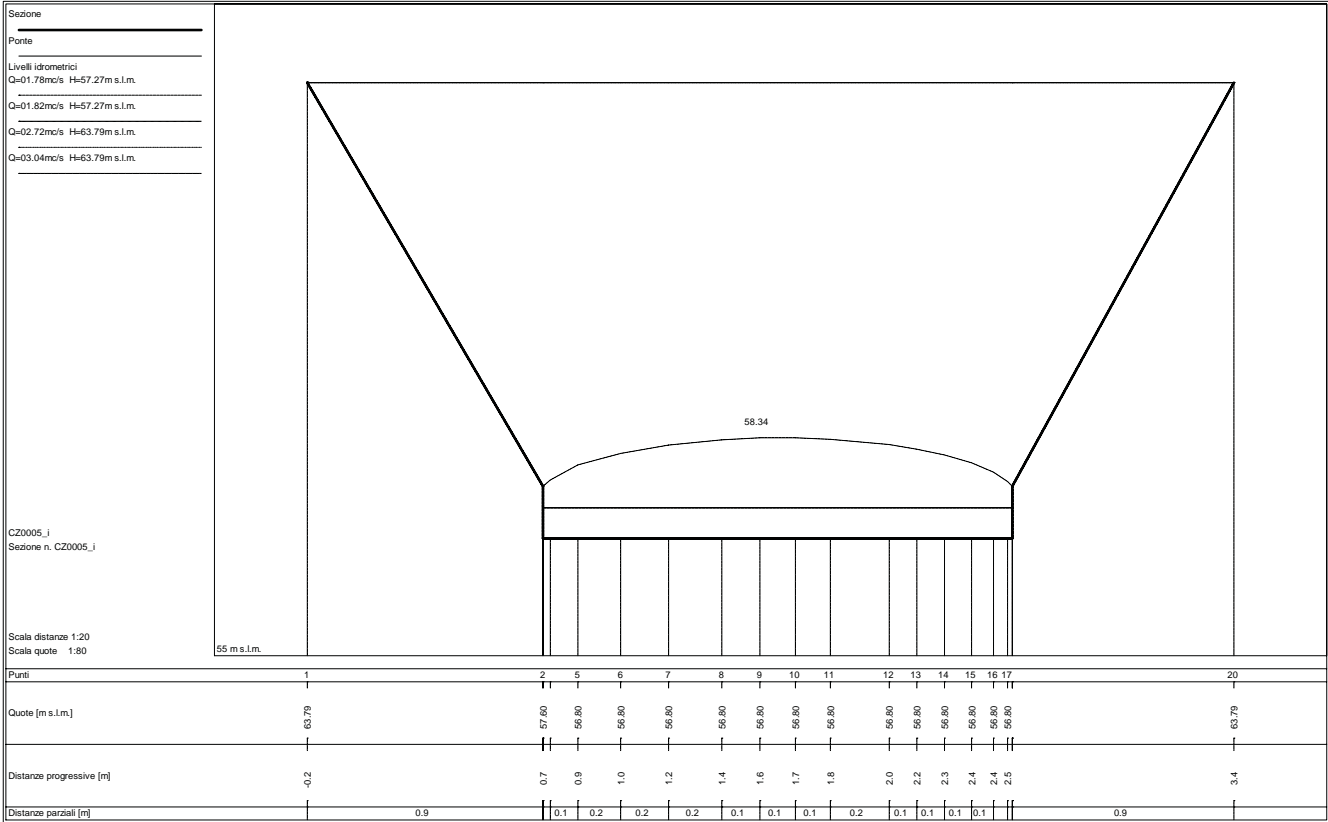

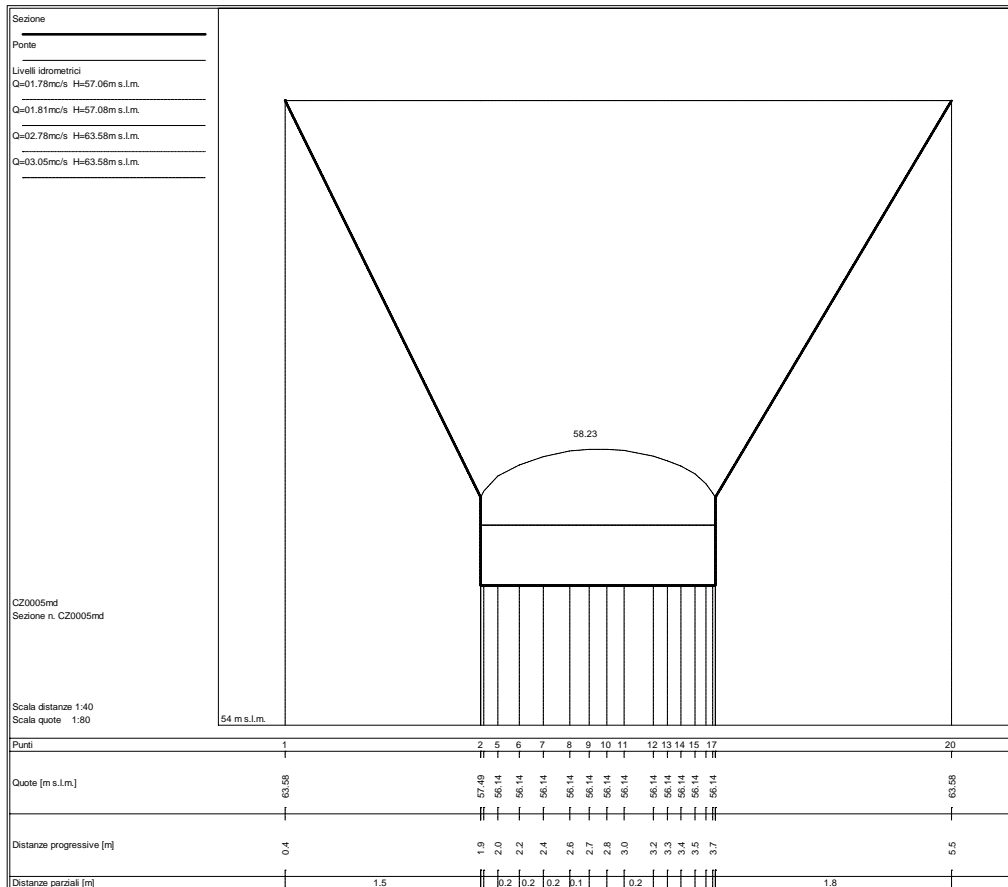
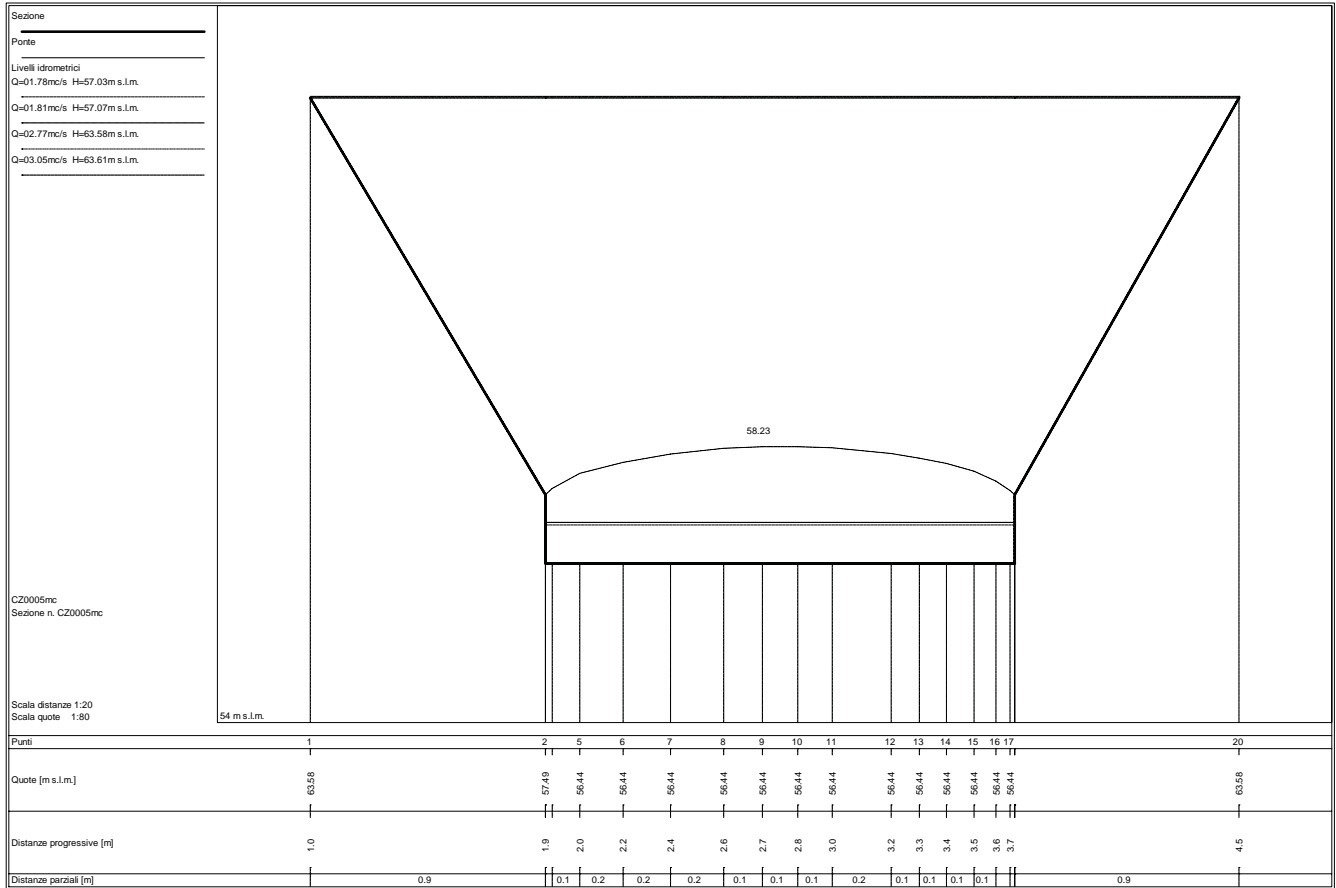

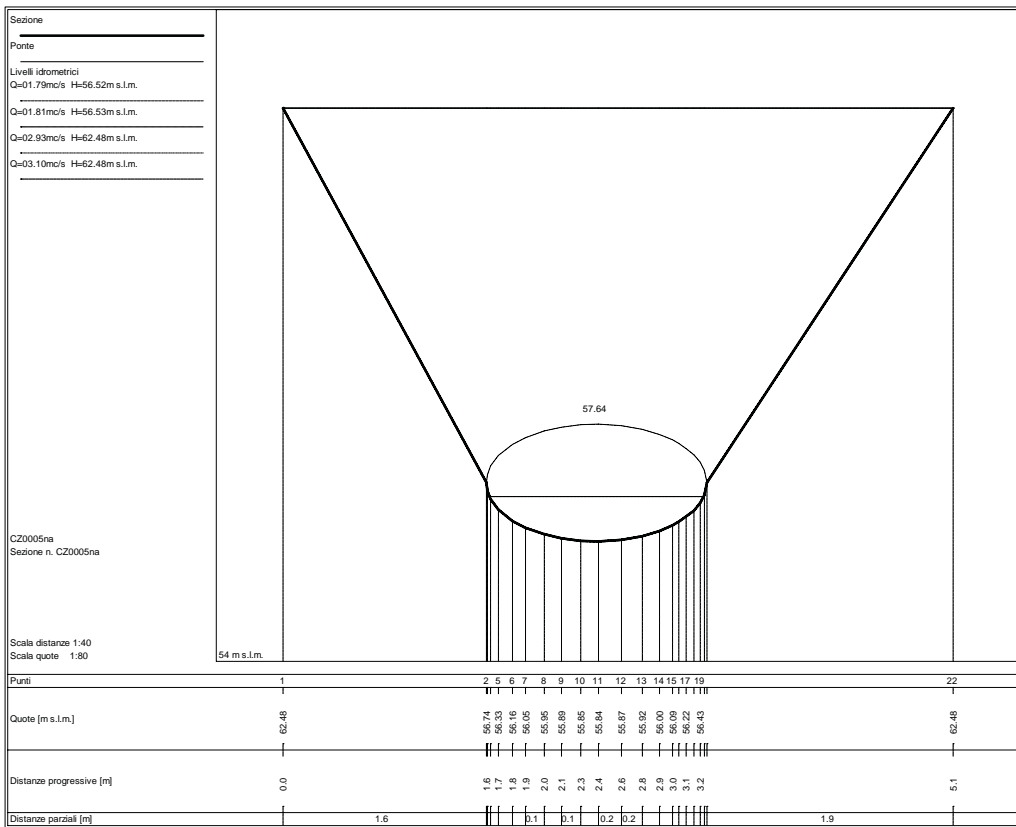
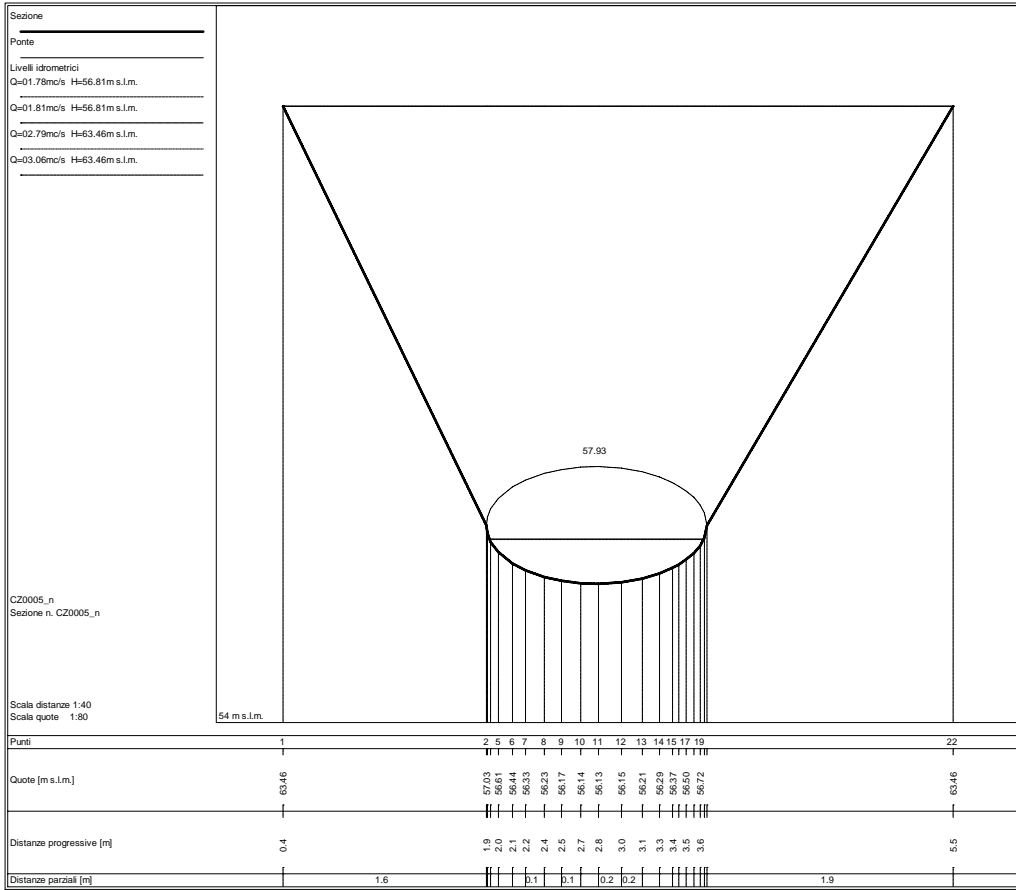

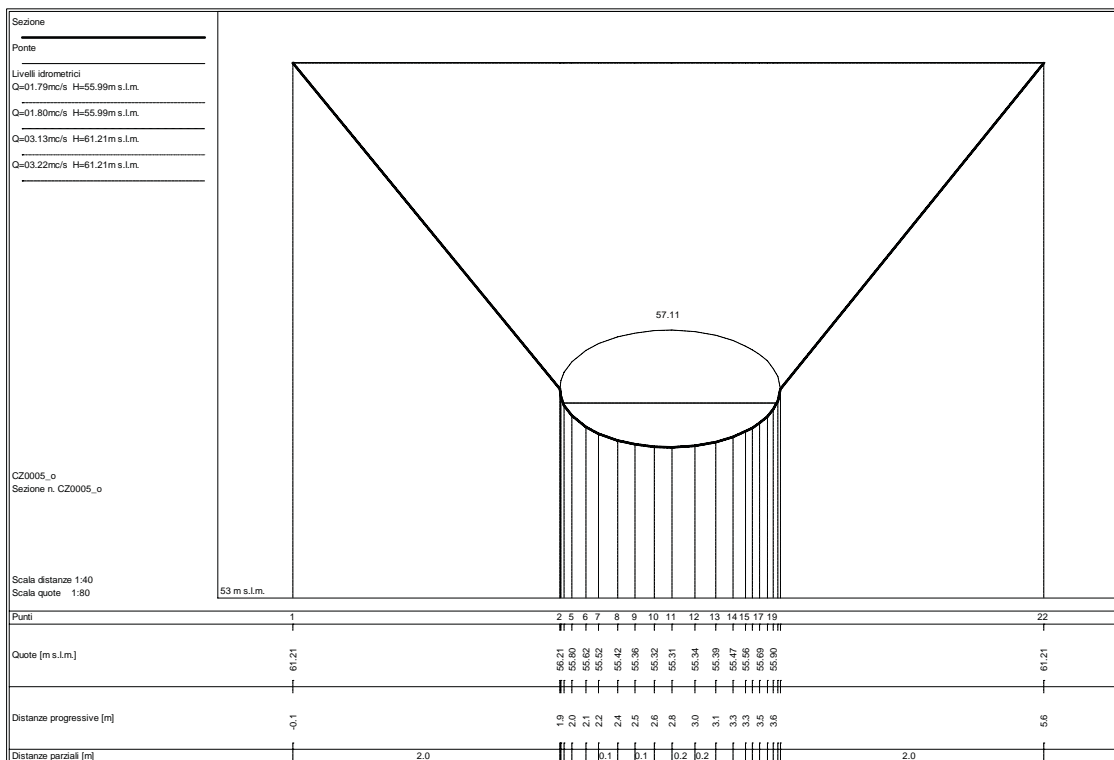
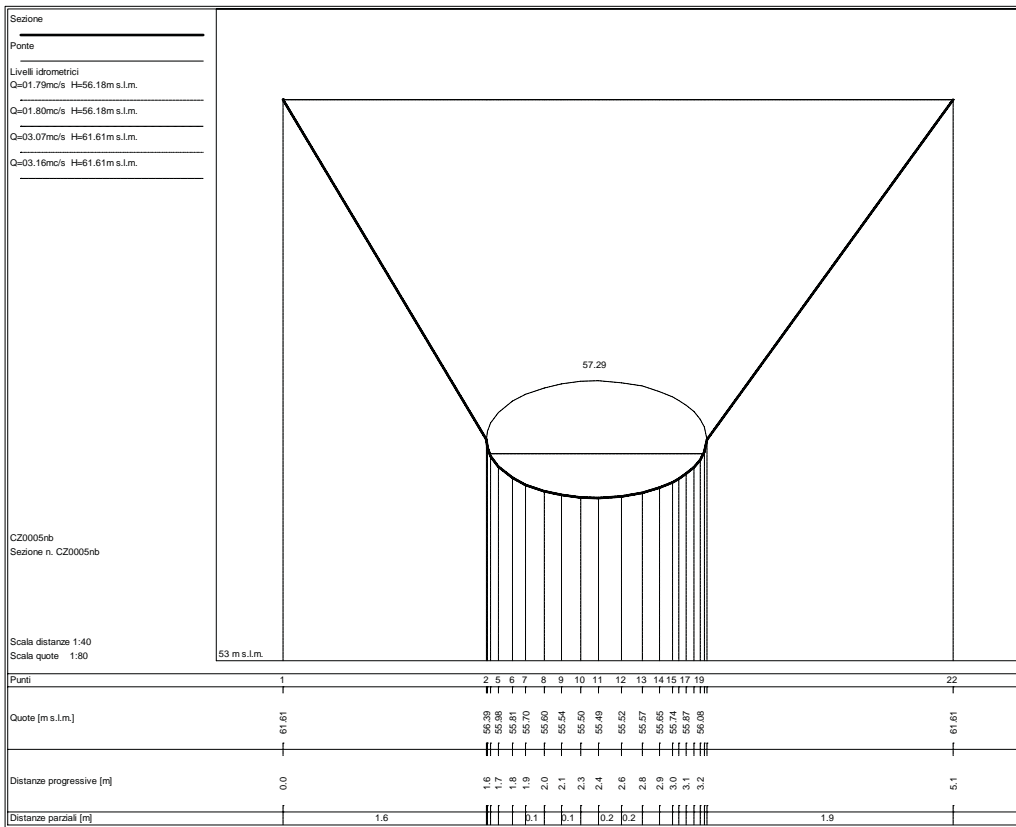

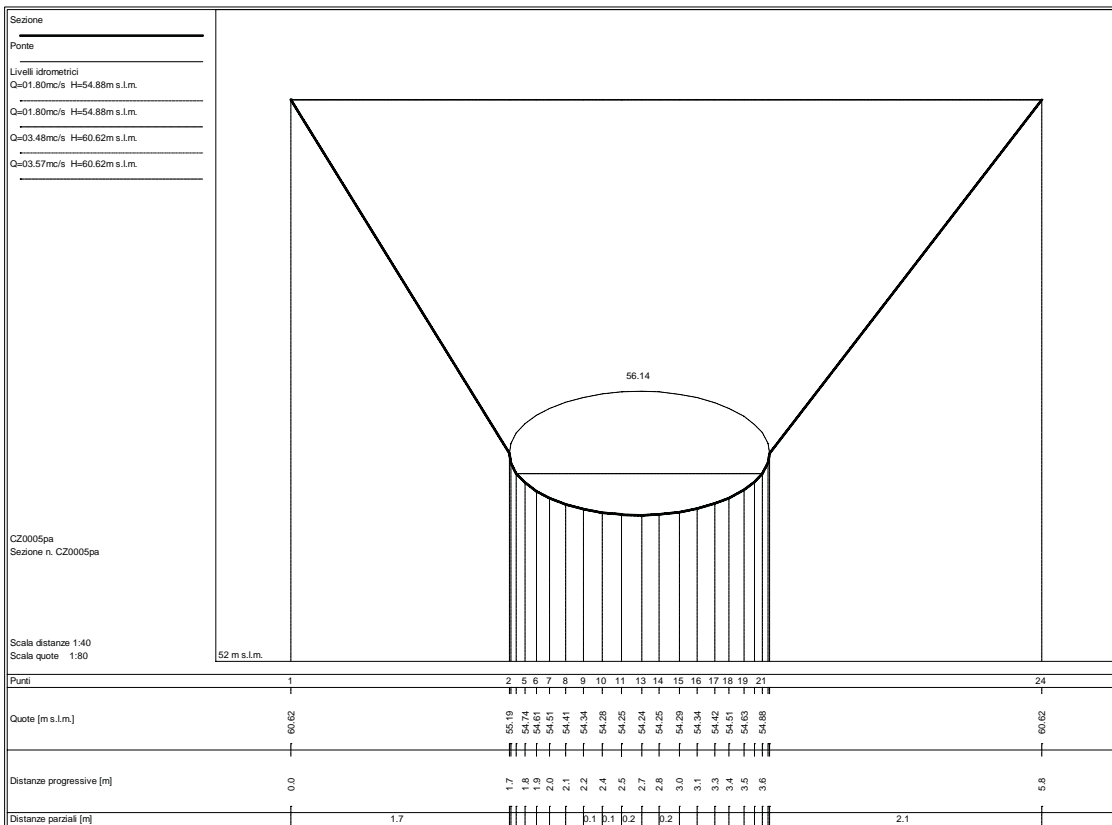
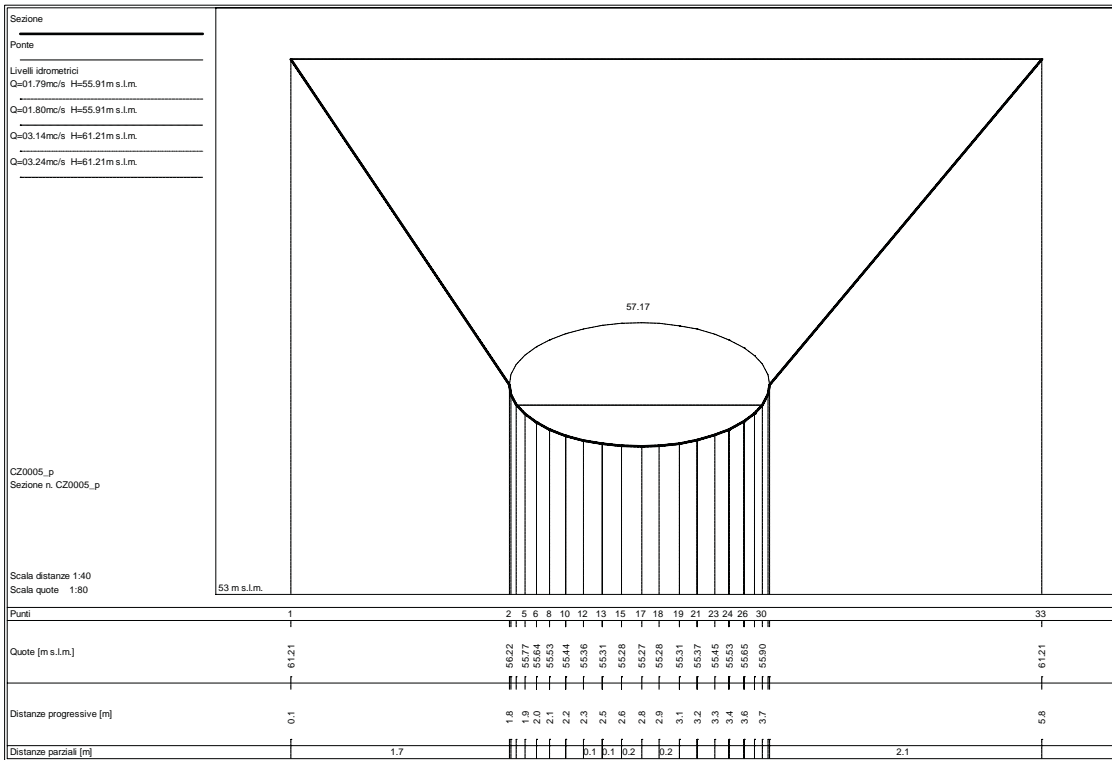

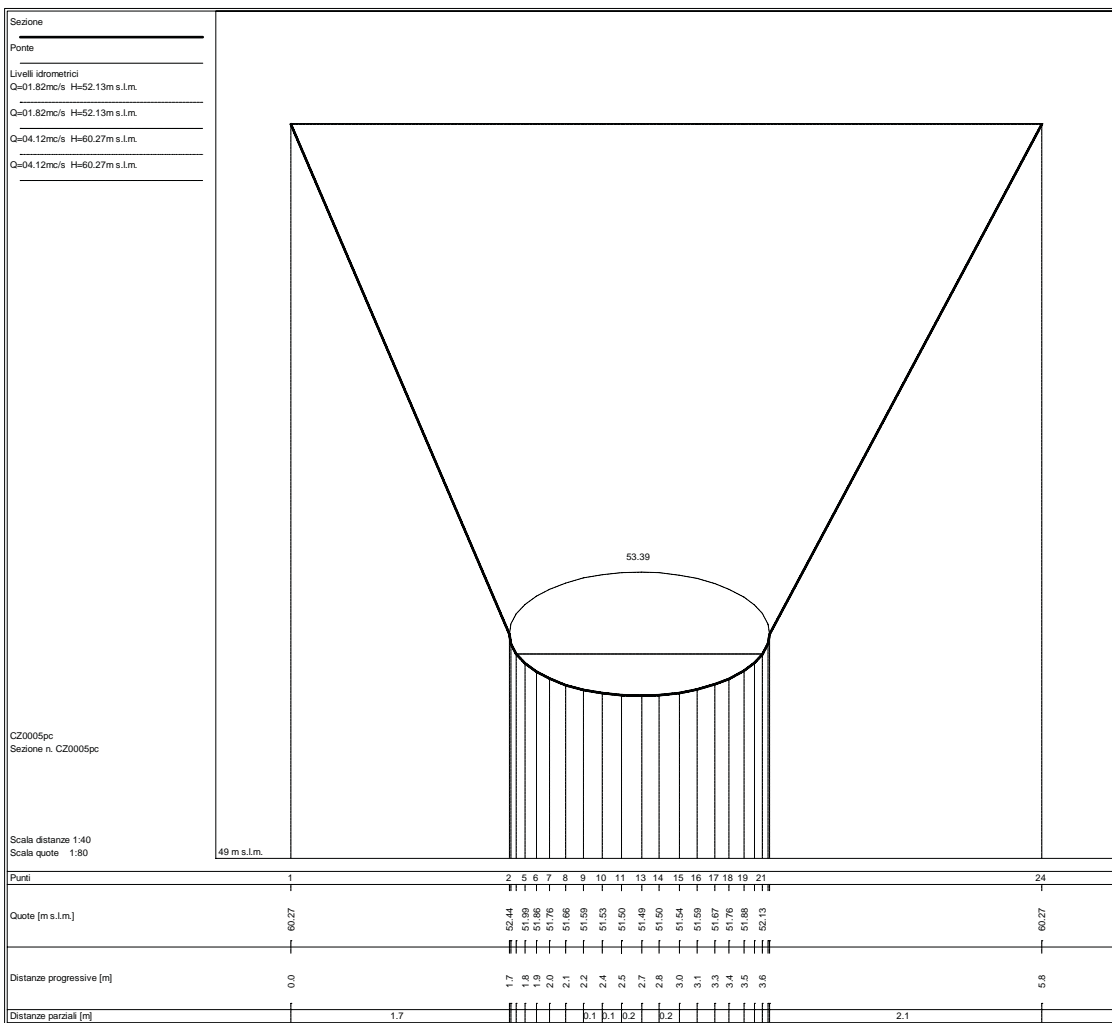
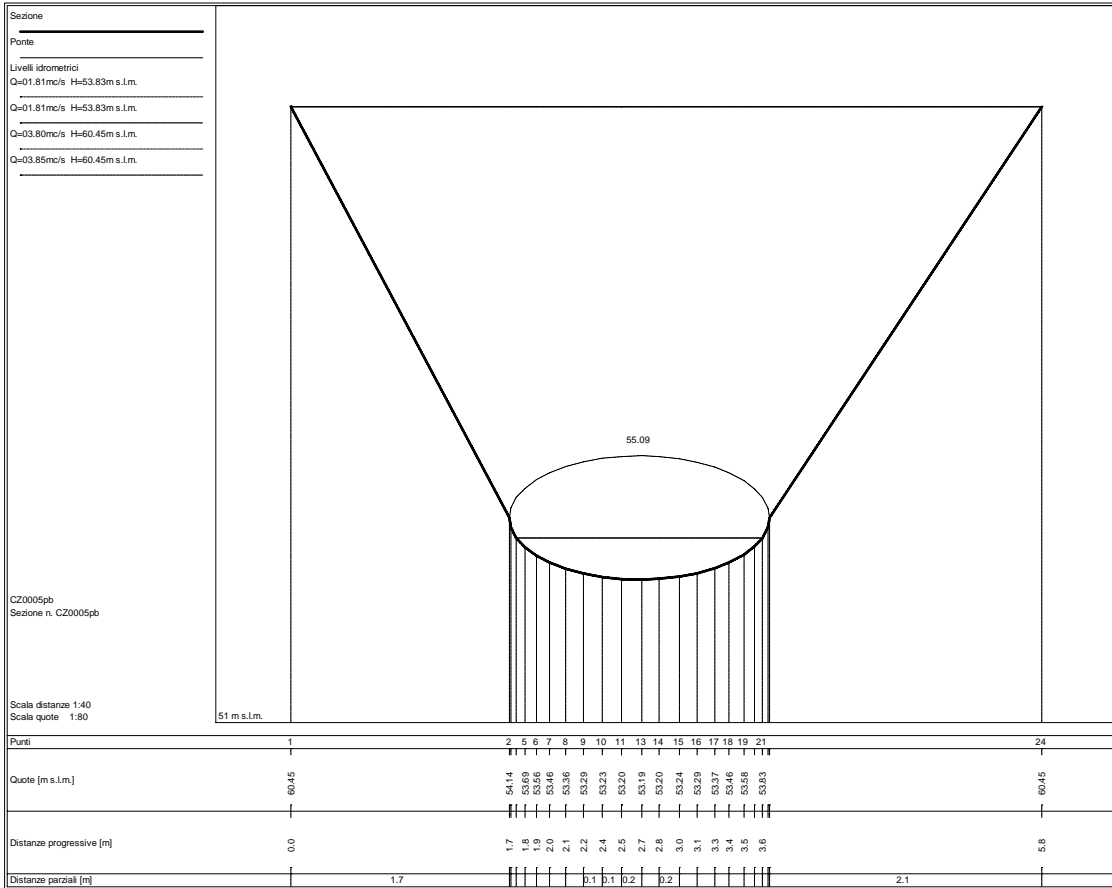

Sezione
 Ponte
 Livelli idrometrici
 Q=01.82mc/s H=50.50m s.l.m.
 Q=01.82mc/s H=50.51m s.l.m.
 Q=04.29mc/s H=59.77m s.l.m.
 Q=04.36mc/s H=59.77m s.l.m.

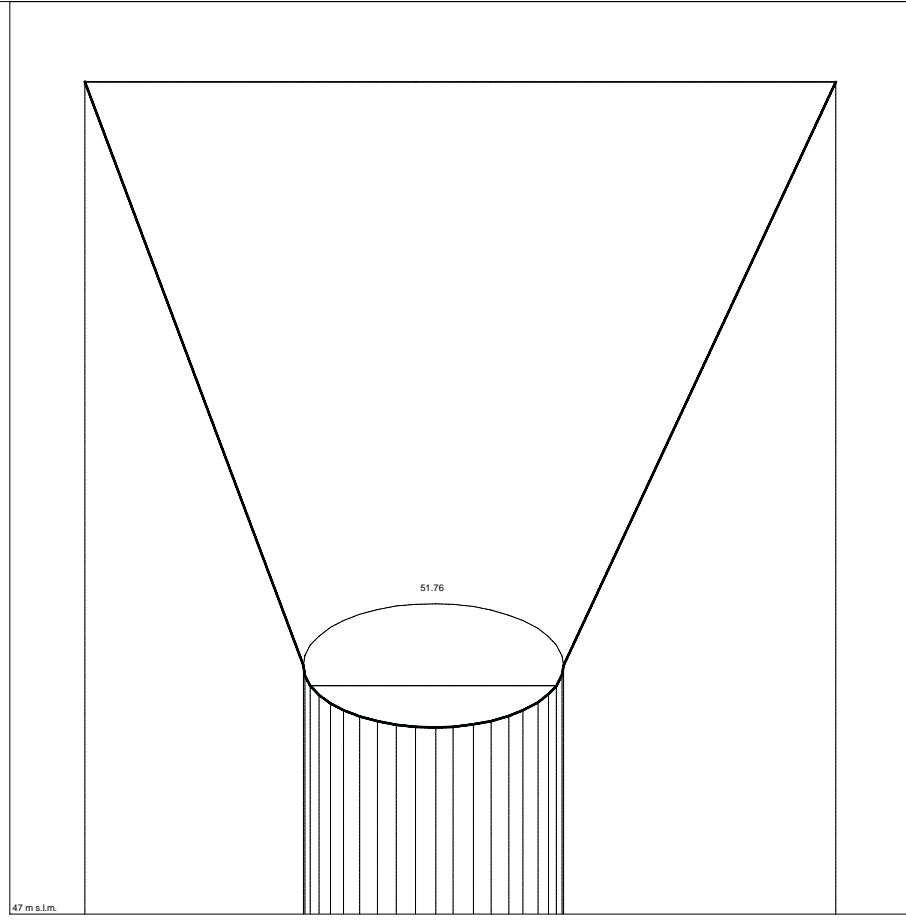

CZ0005pd
 Sezione n. CZ0005pd

Scala distanze 1:40
 Scala quote 1:80

Punti	1	2	3	4	5	6	7	8	9	10	11	13	14	15	16	17	18	19	21	24
Quote [m s.l.m.]	59.77	50.81	50.96	50.96	50.23	50.13	50.03	49.96	49.90	49.87	49.86	49.86	49.91	49.96	50.04	50.13	50.25	50.50	59.77	
Distanze progressive [m]	0.0	1.7	1.6	1.9	2.0	2.1	2.2	2.4	2.5	2.7	2.8	3.0	3.1	3.3	3.4	3.5	3.6	5.8		
Distanze parziali [m]		1.7						0.1	0.2	0.2	0.2	0.2	0.2					2.1		

Sezione
 Ponte
 Livelli idrometrici
 Q=01.82mc/s H=49.43m s.l.m.
 Q=01.83mc/s H=49.44m s.l.m.
 Q=04.47mc/s H=55.29m s.l.m.
 Q=04.56mc/s H=55.29m s.l.m.

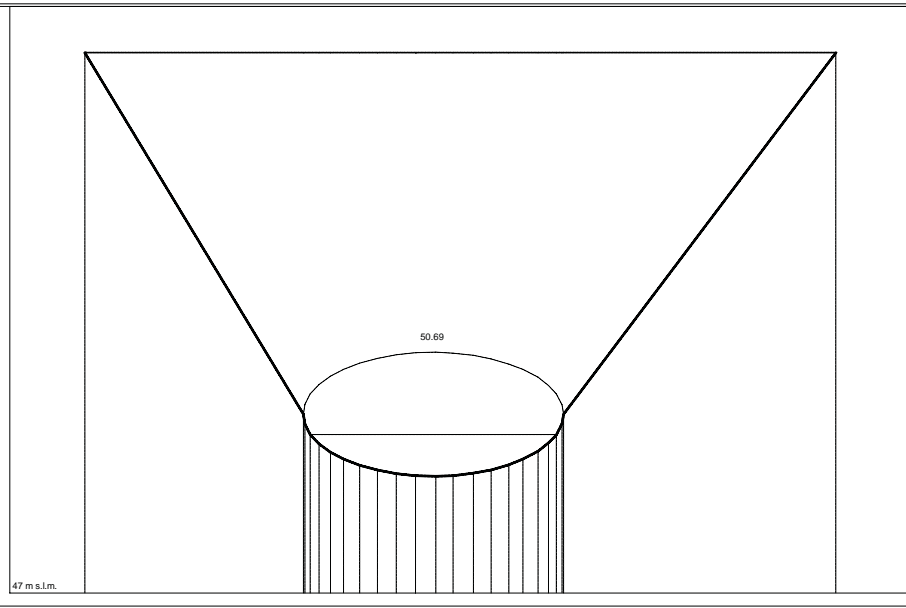

CZ0005pe
 Sezione n. CZ0005pe

Scala distanze 1:40
 Scala quote 1:80

Punti	1	2	3	4	5	6	7	8	9	10	11	13	14	15	16	17	18	19	21	24
Quote [m s.l.m.]	55.29	49.74	49.79	49.79	49.16	49.06	48.96	48.89	48.83	48.80	48.79	48.80	48.84	48.89	48.97	49.06	49.18	49.43	55.29	
Distanze progressive [m]	0.0	1.7	1.8	1.9	2.0	2.1	2.2	2.4	2.5	2.7	2.8	3.0	3.1	3.3	3.4	3.5	3.6	5.8		
Distanze parziali [m]		1.7						0.1	0.2	0.2	0.2	0.2	0.2					2.1		

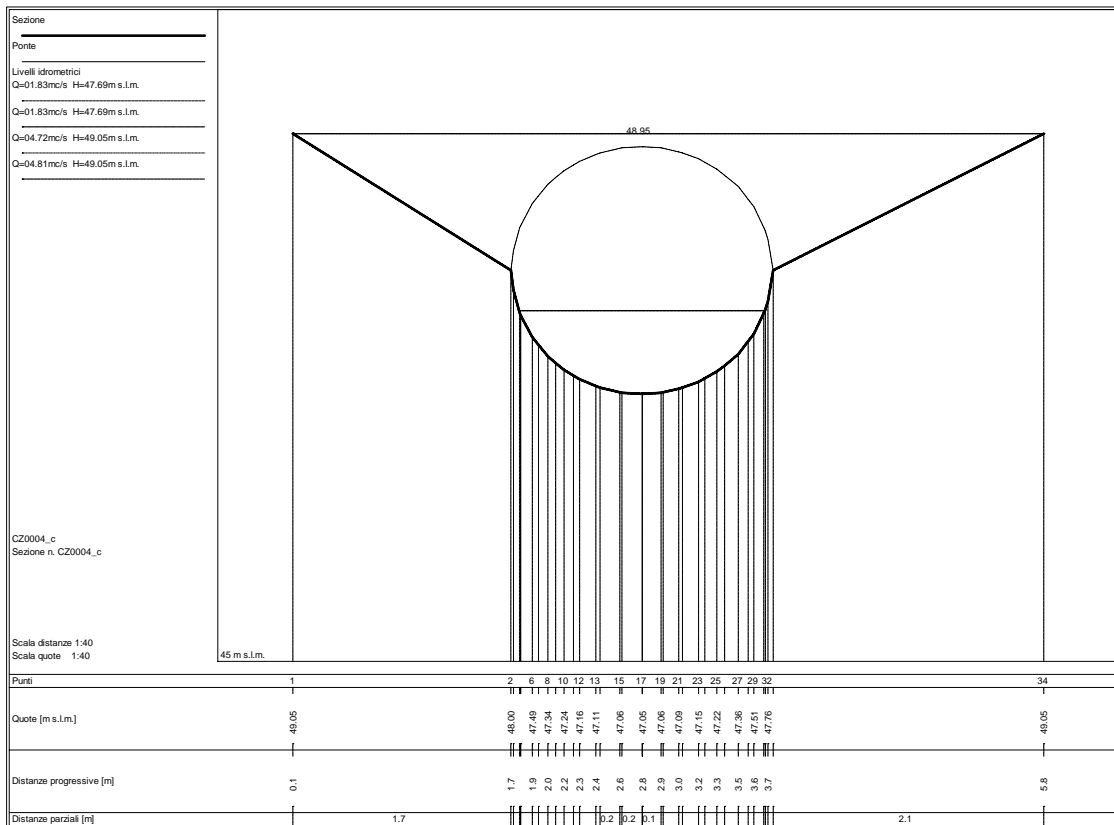
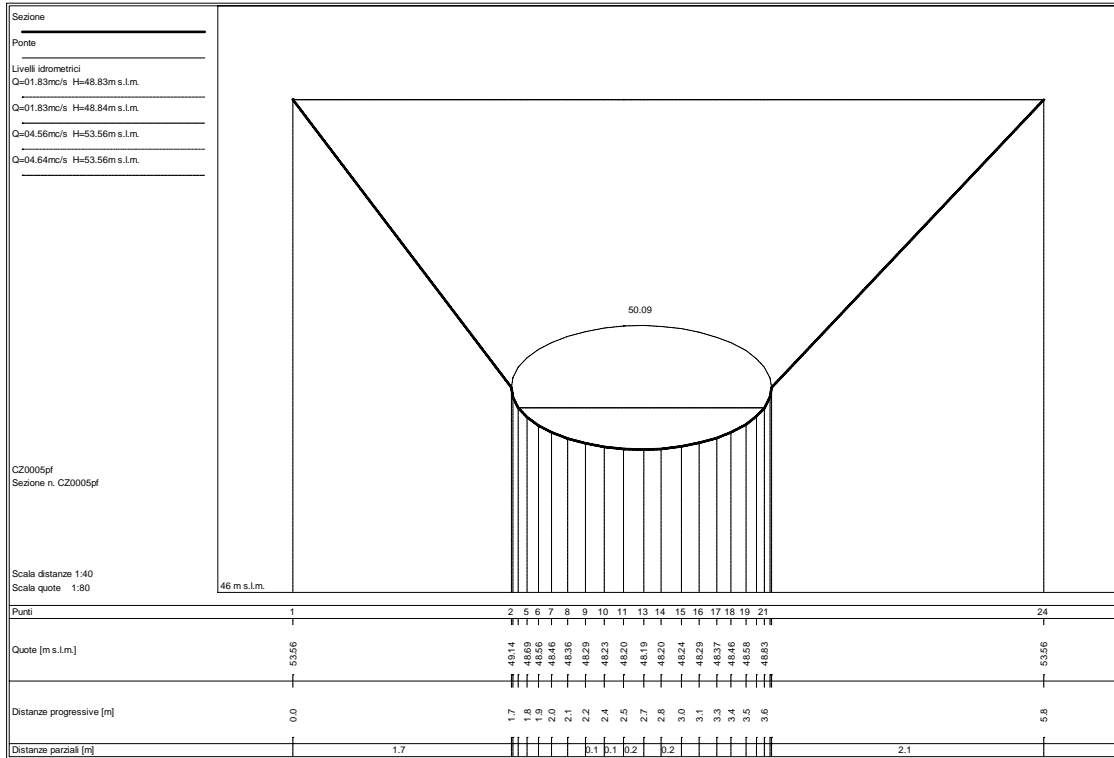

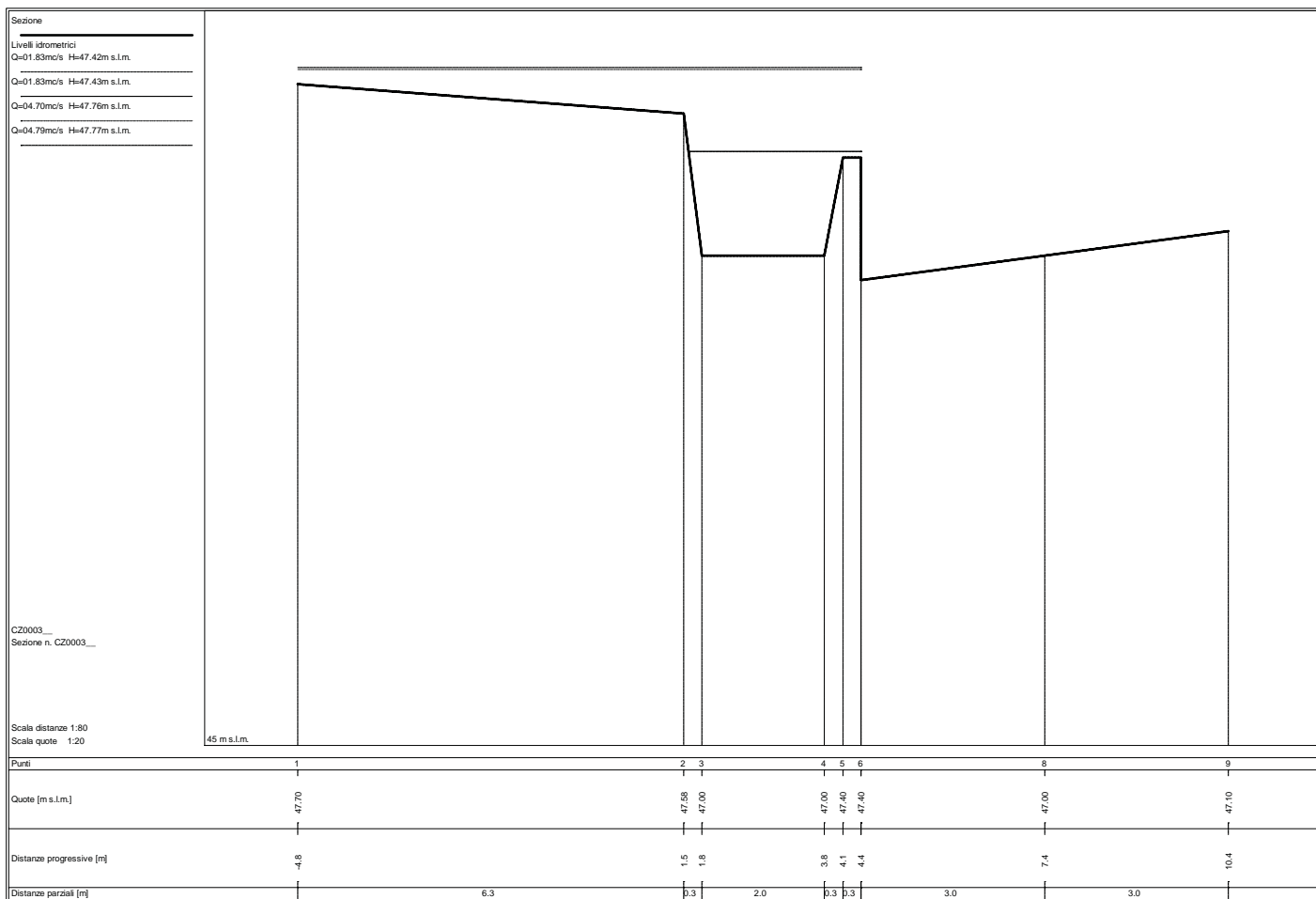
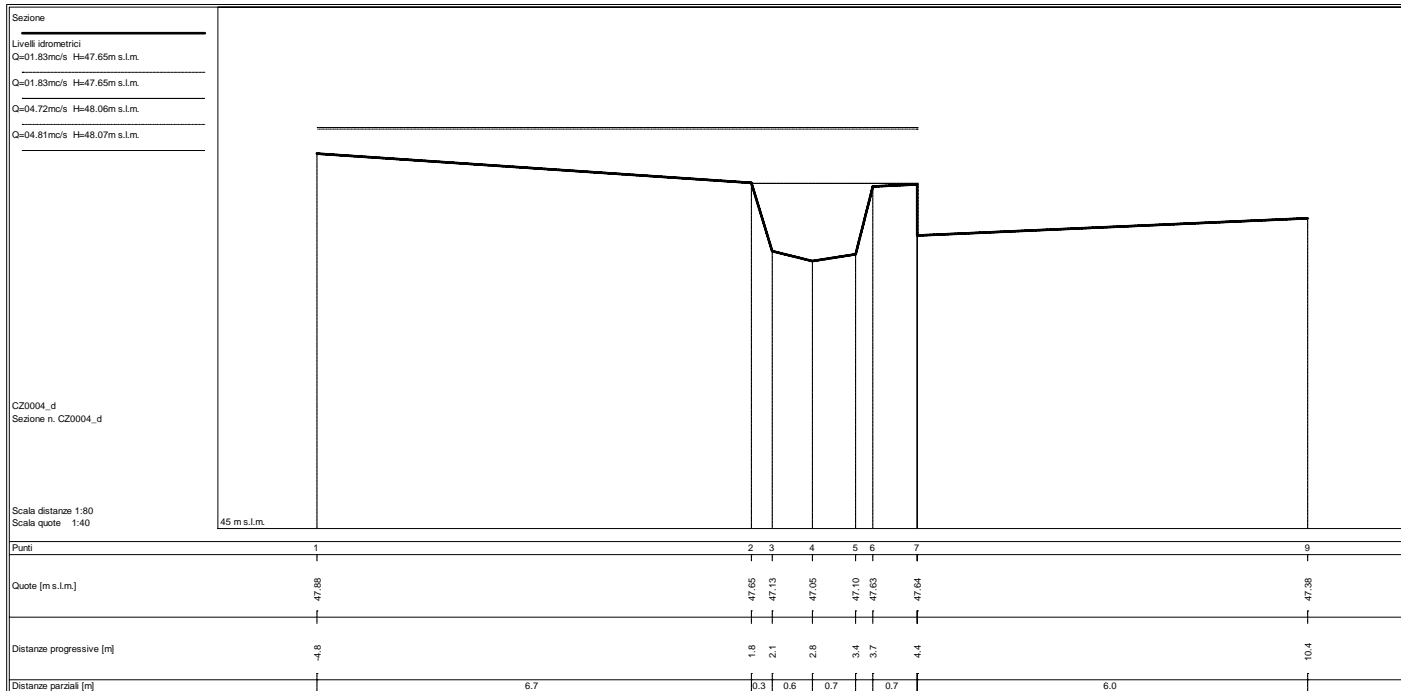

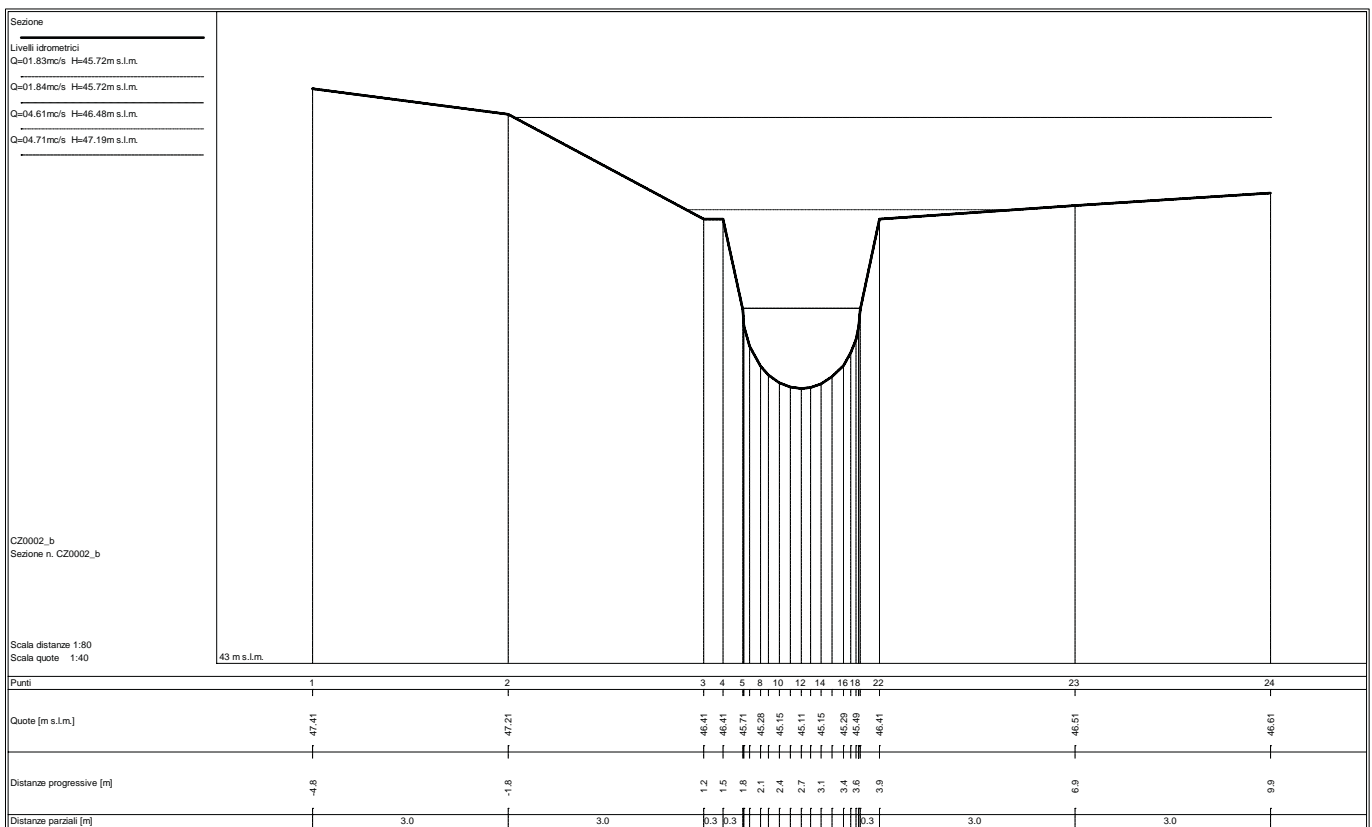
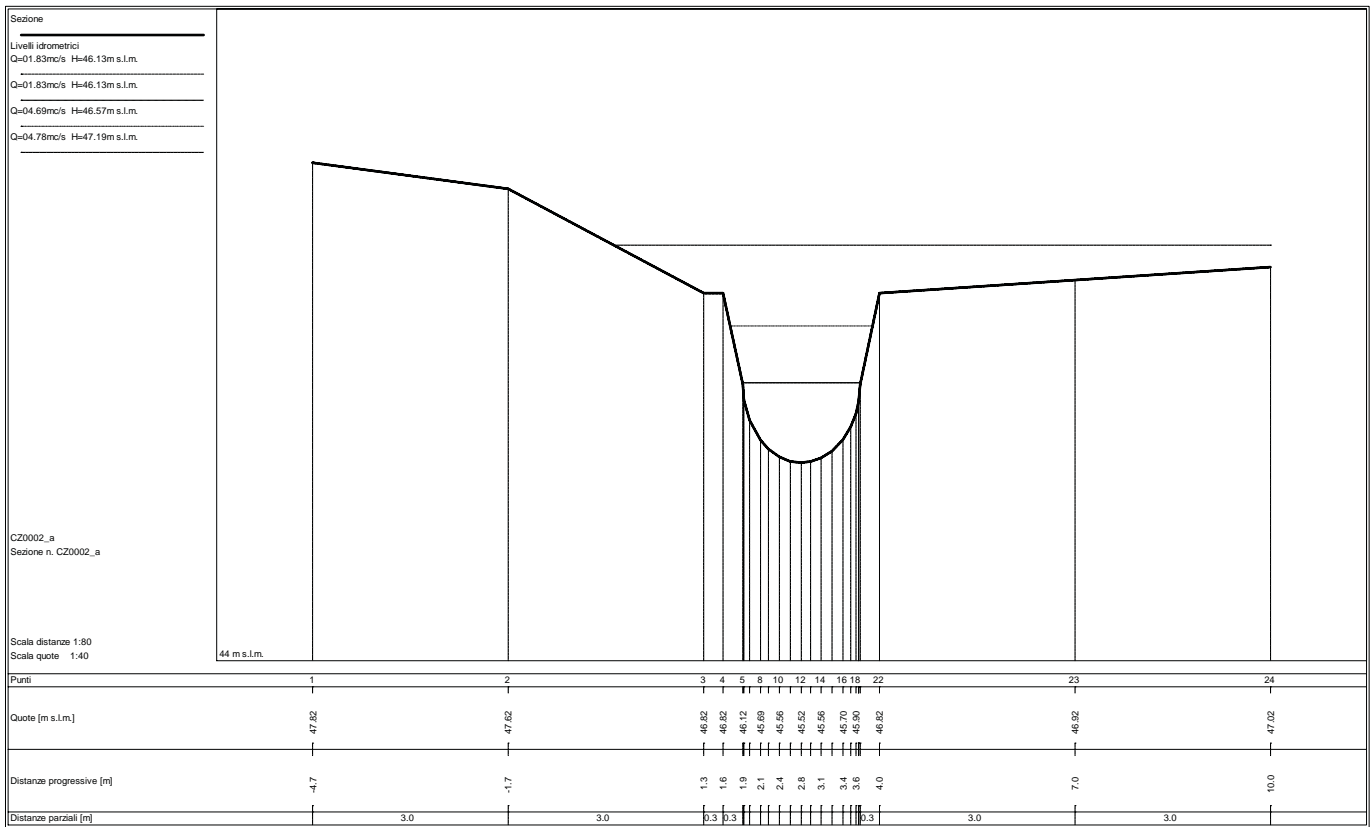

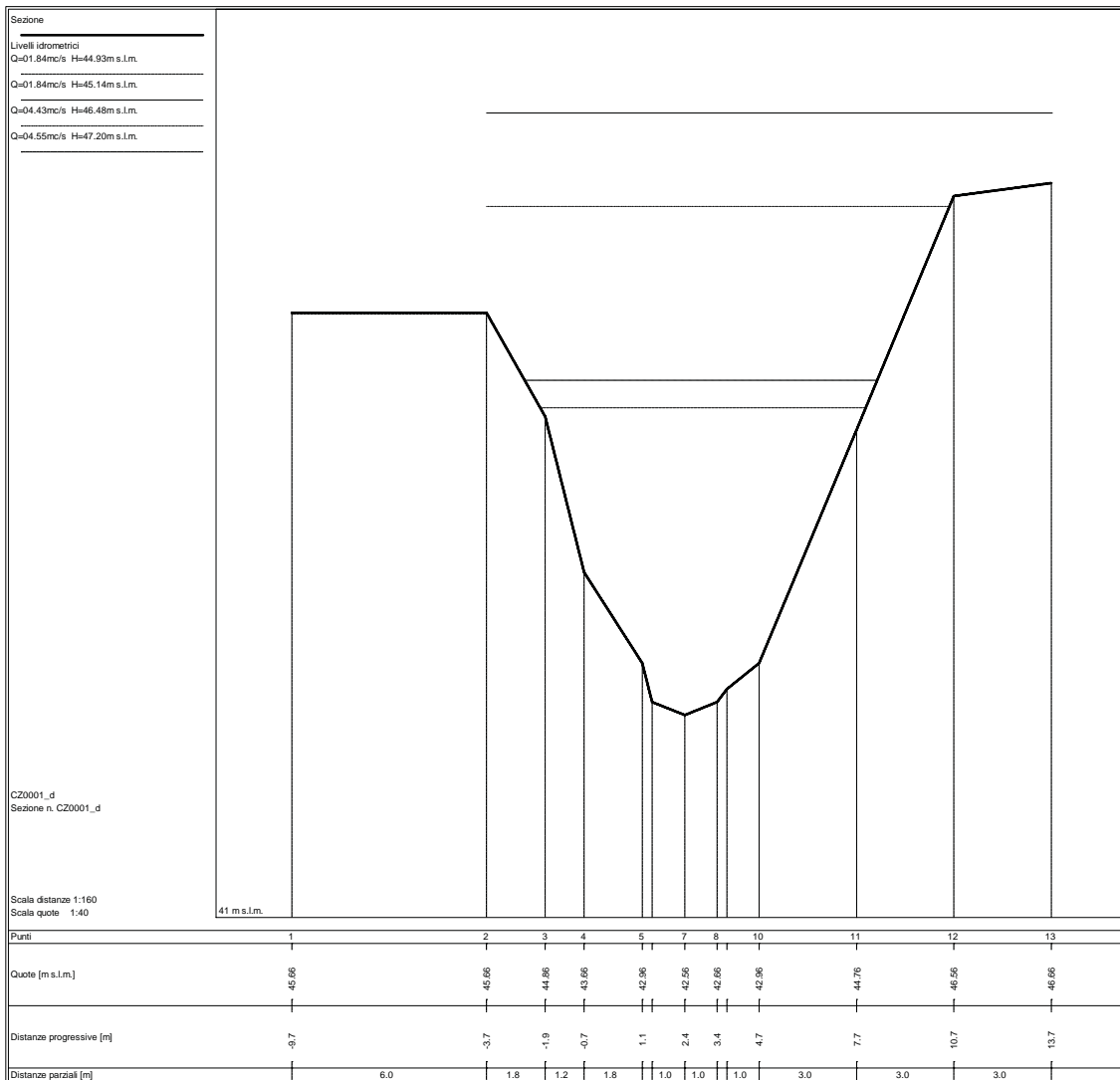
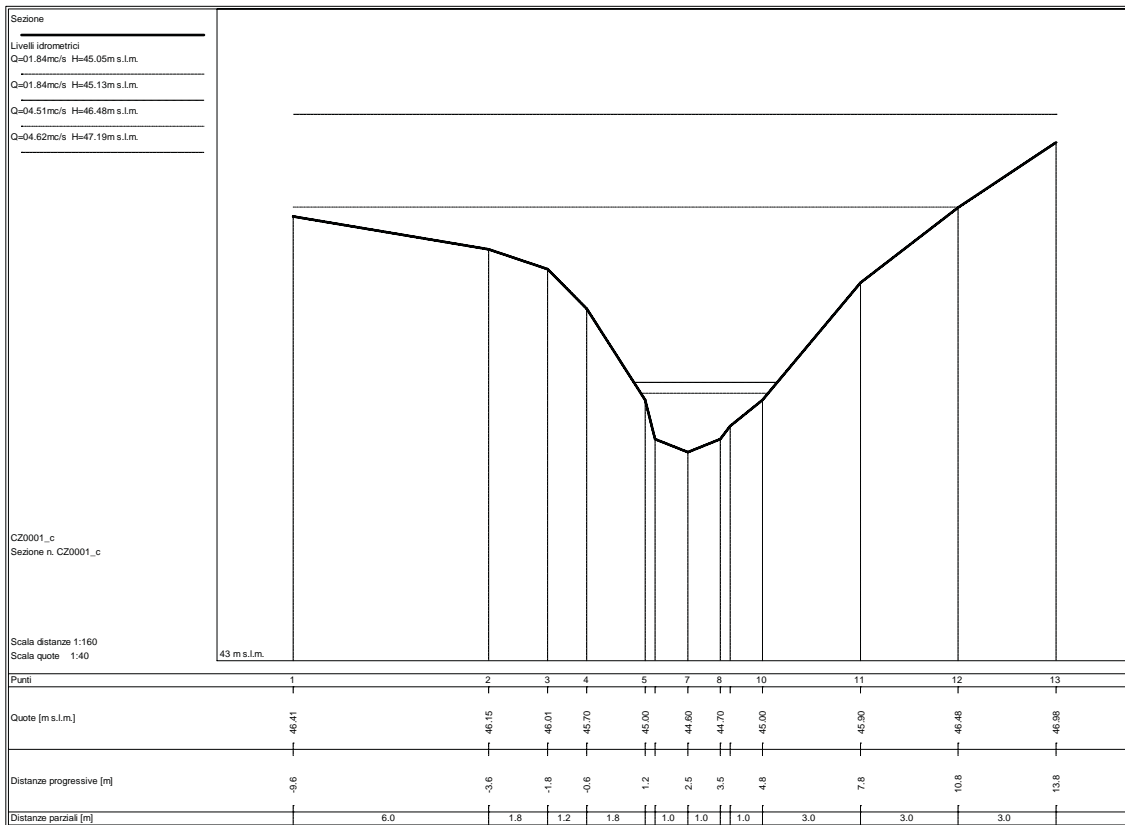

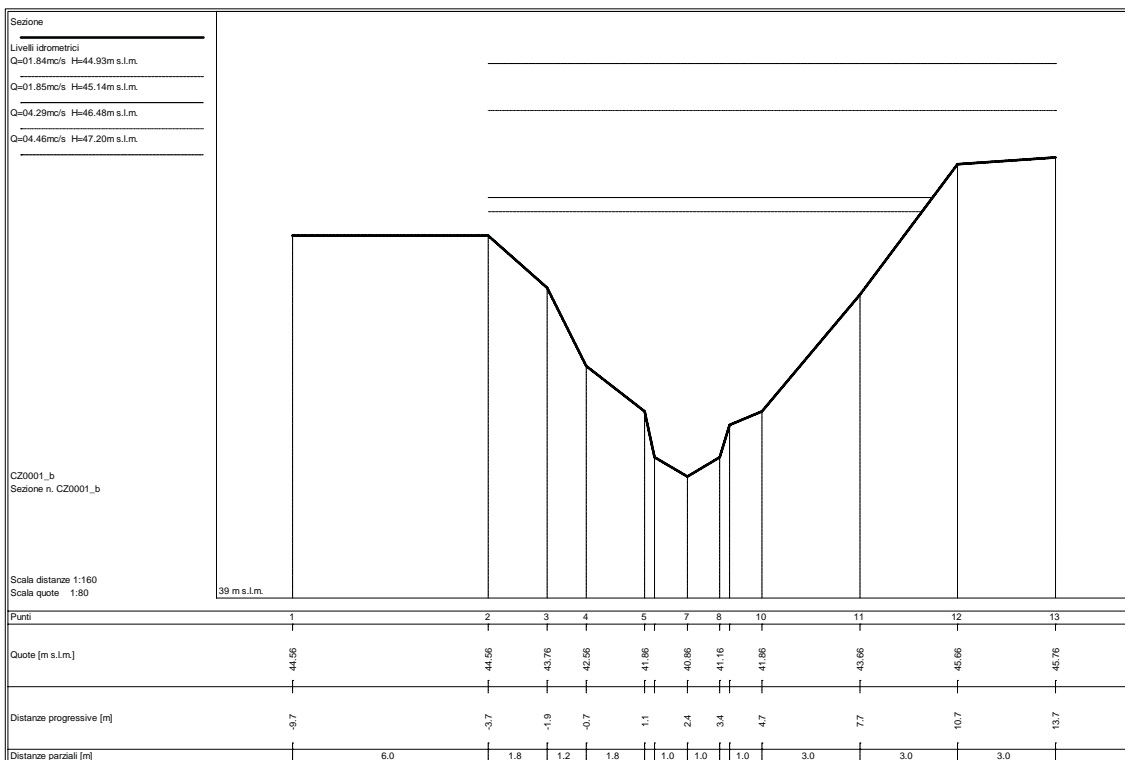
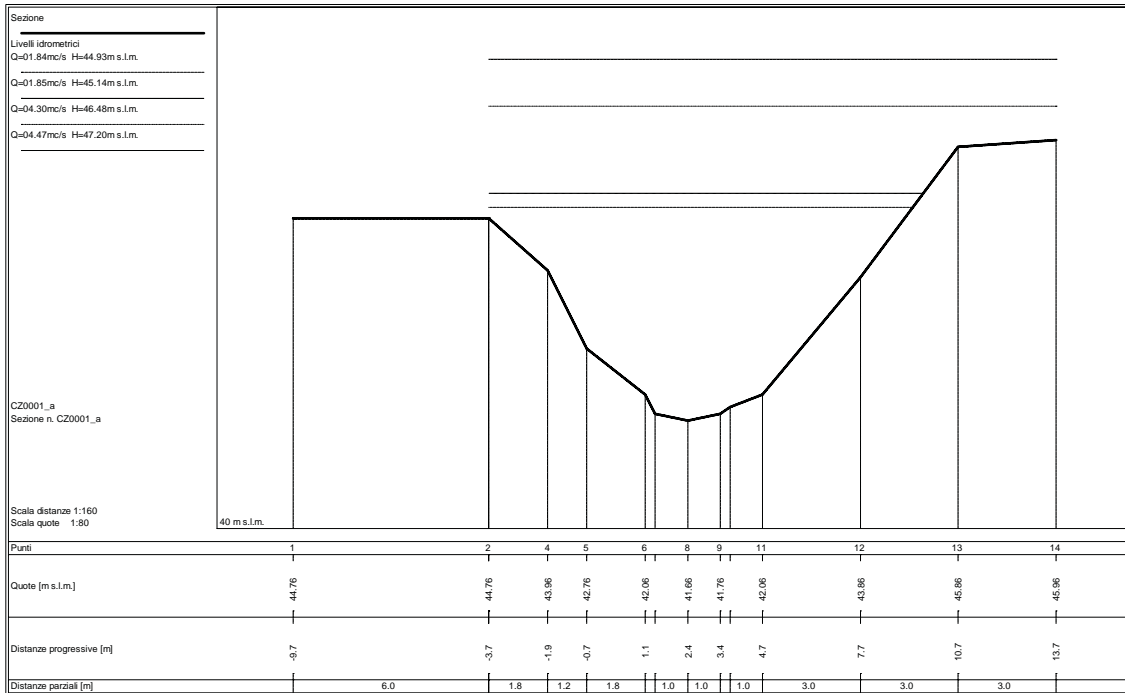

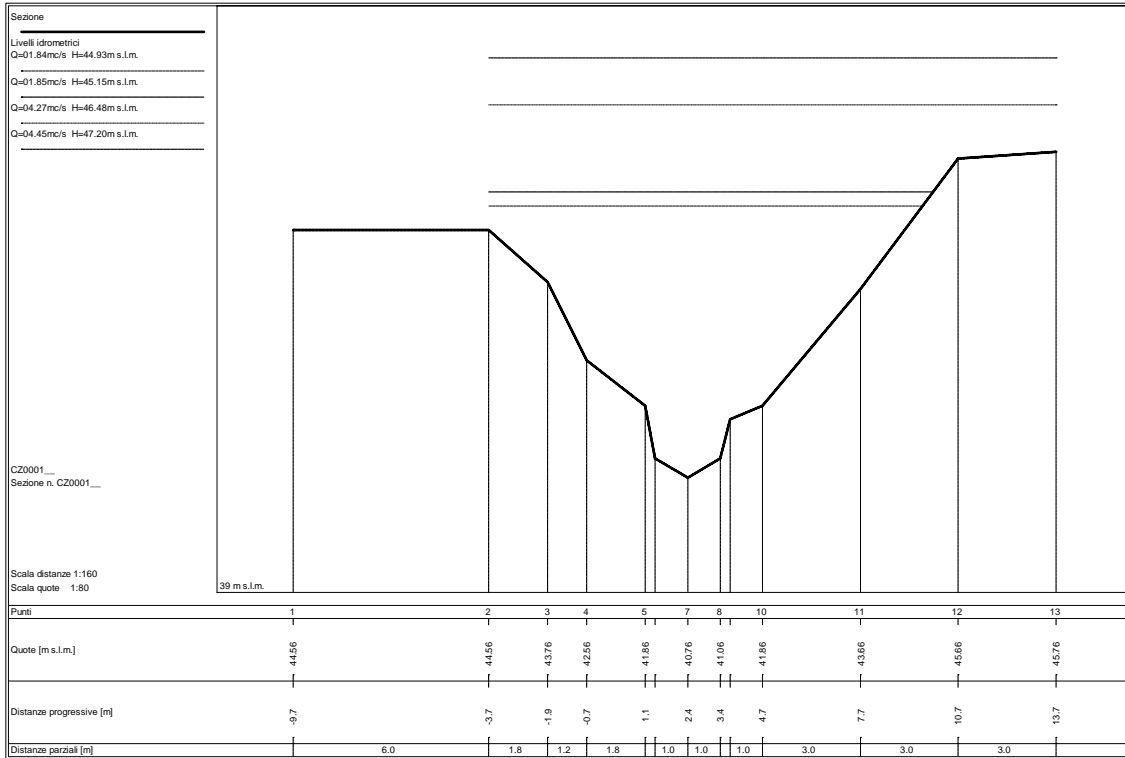

STATO ATTUALE
Sezioni fluviali fosso Ruotino

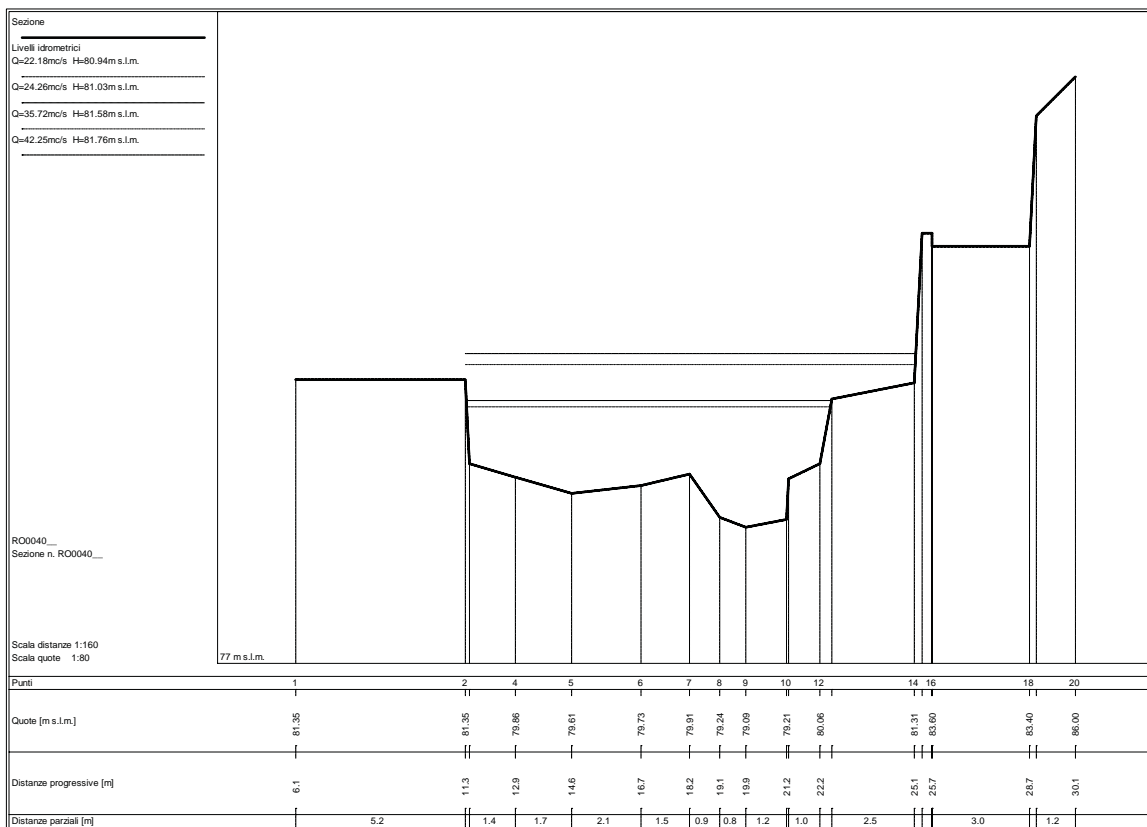
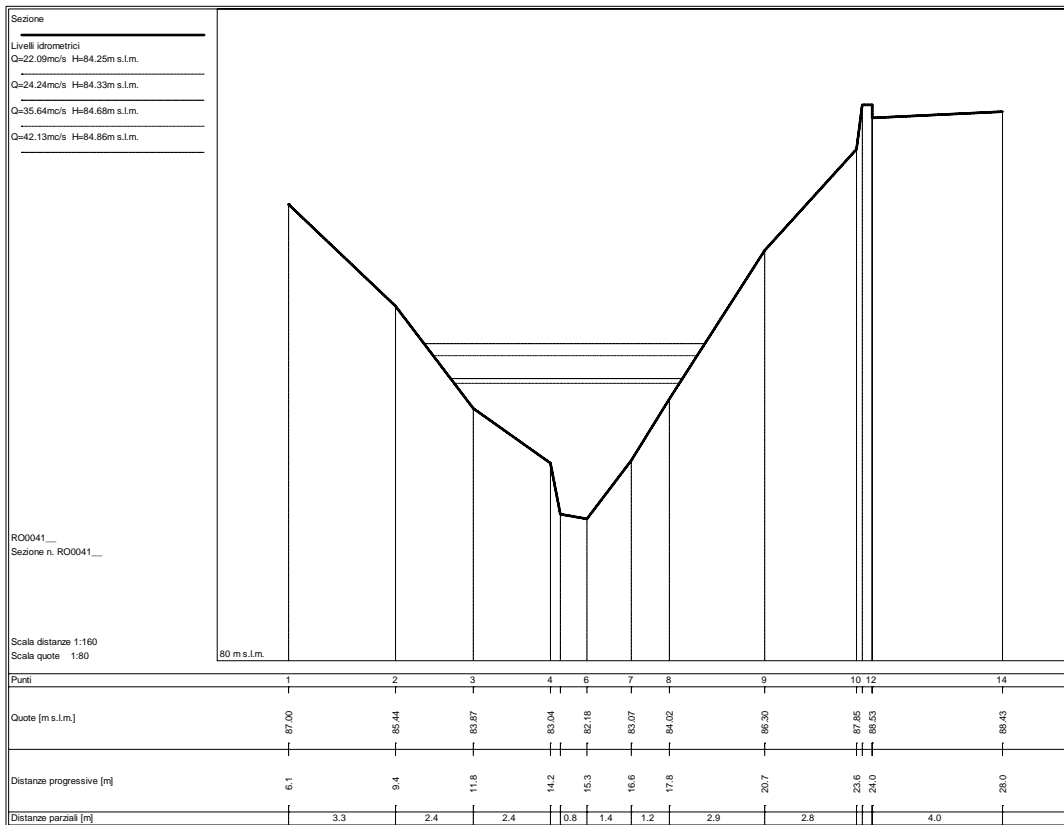

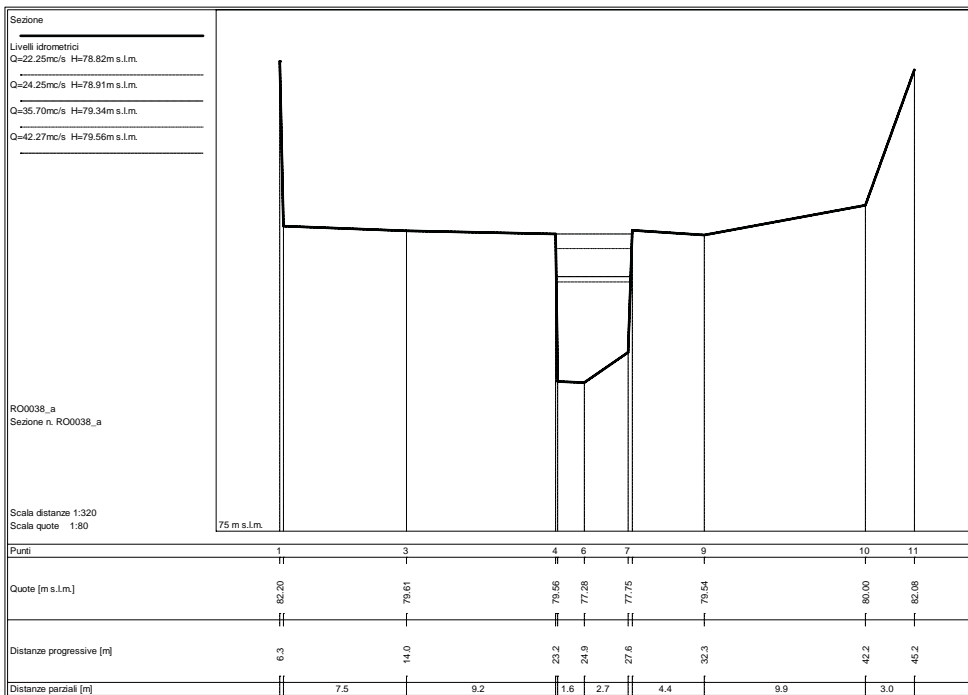
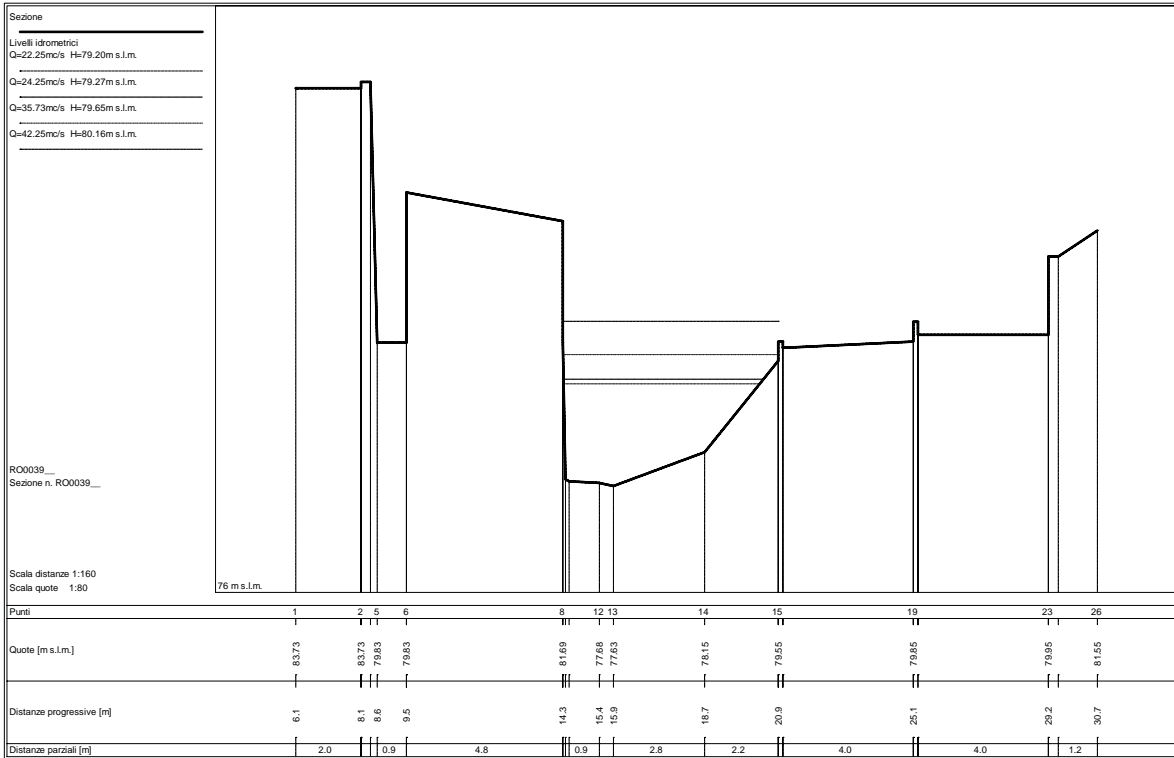

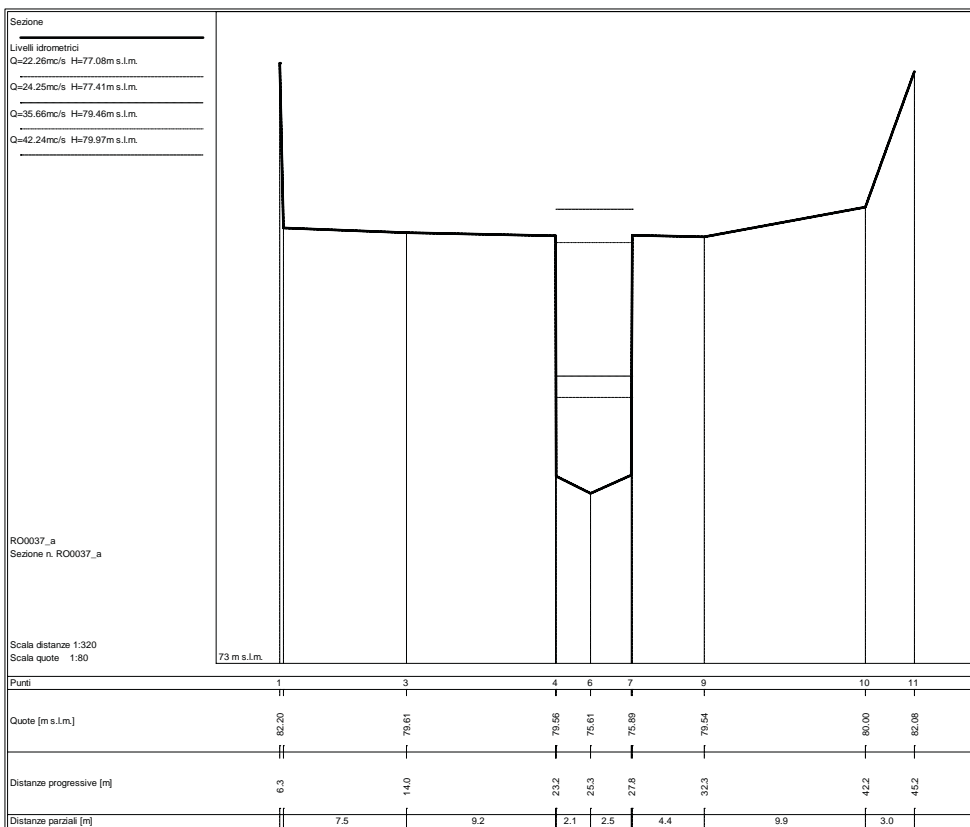
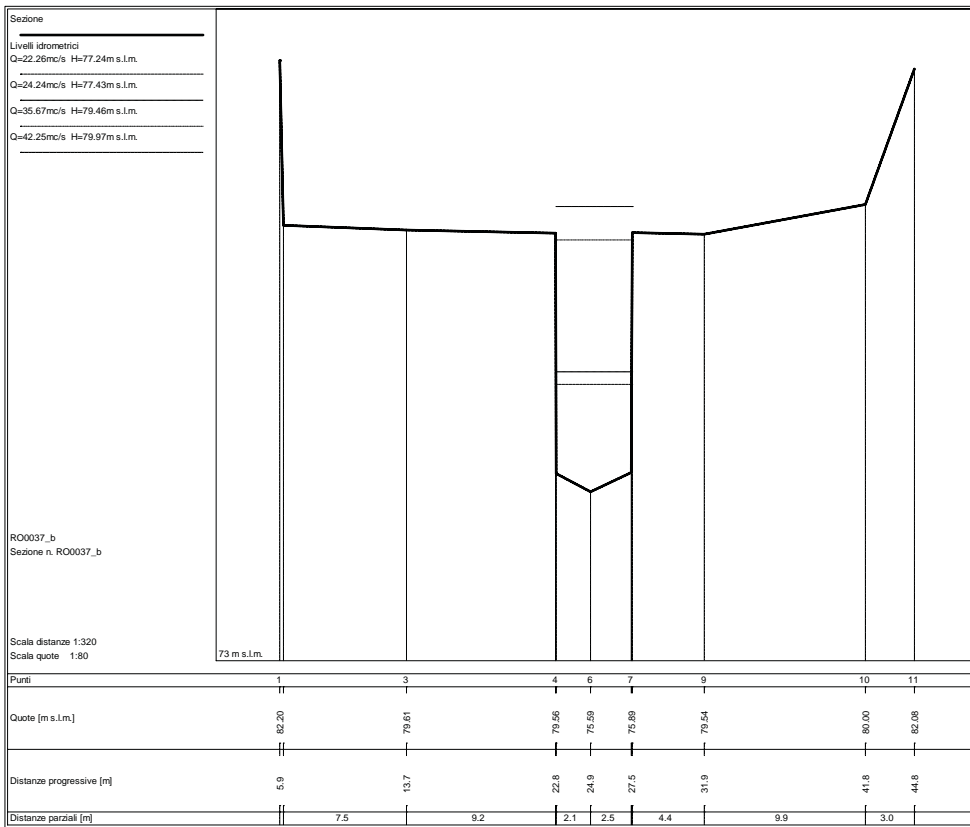

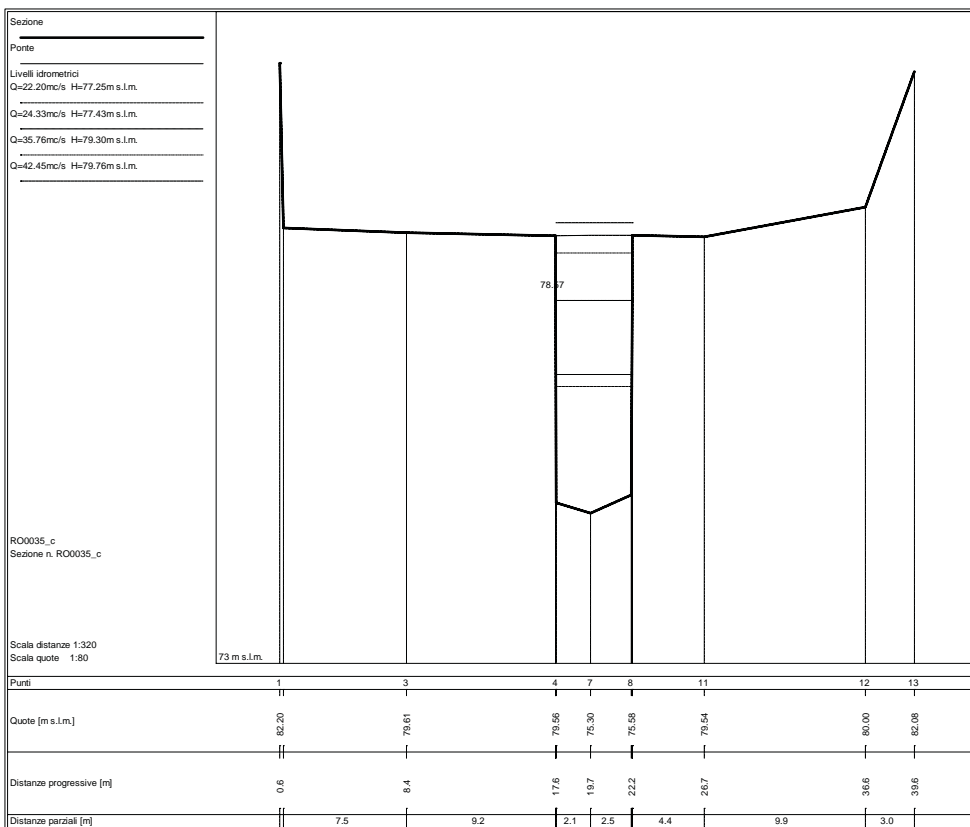
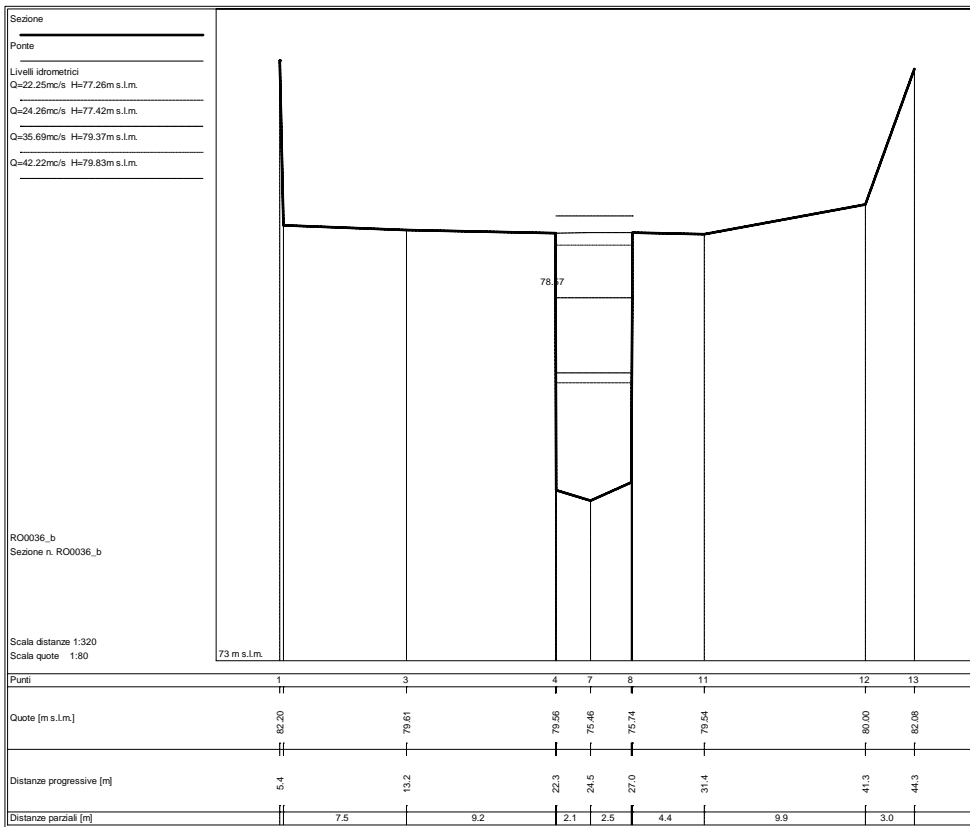

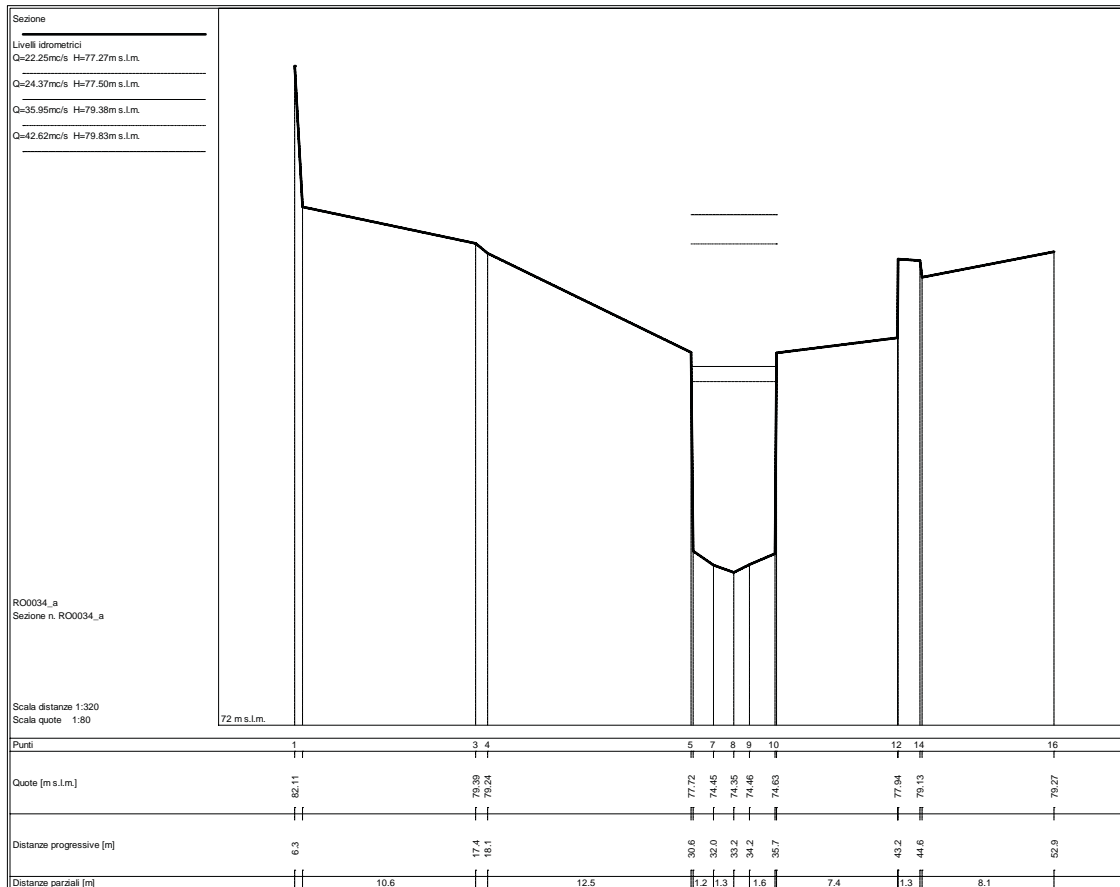
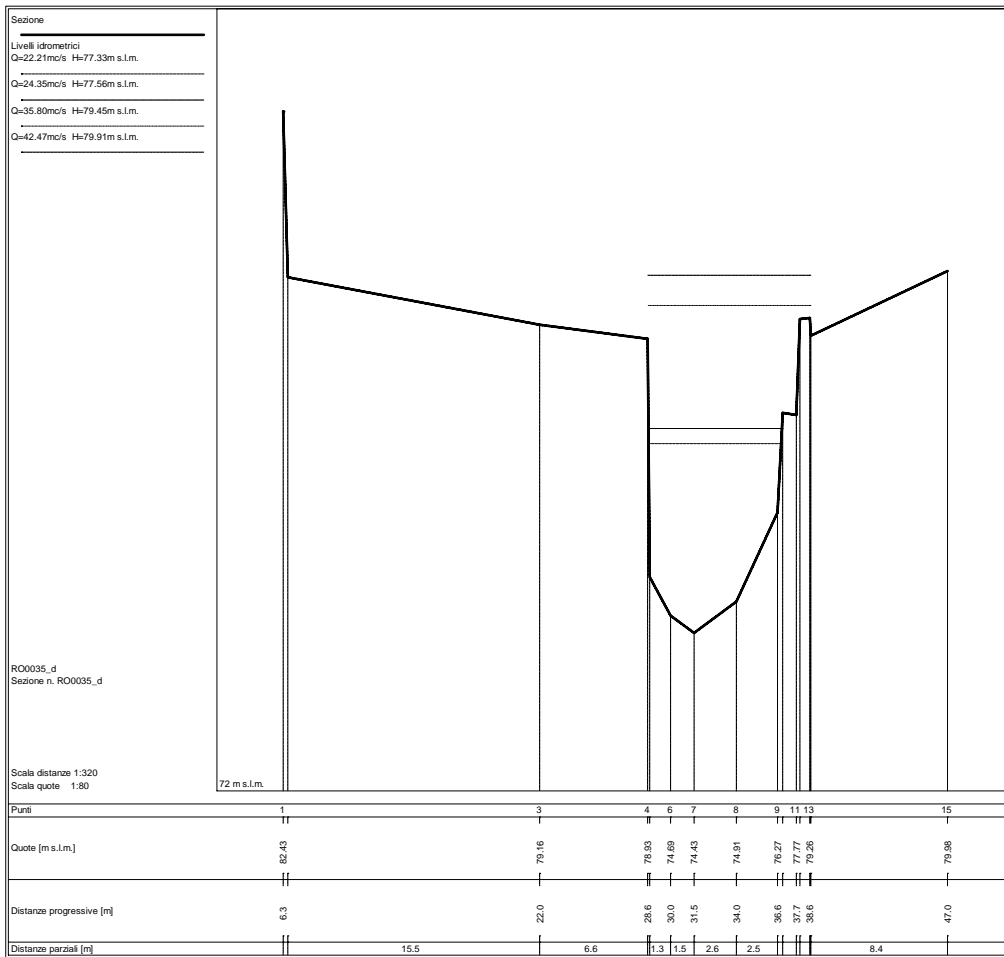

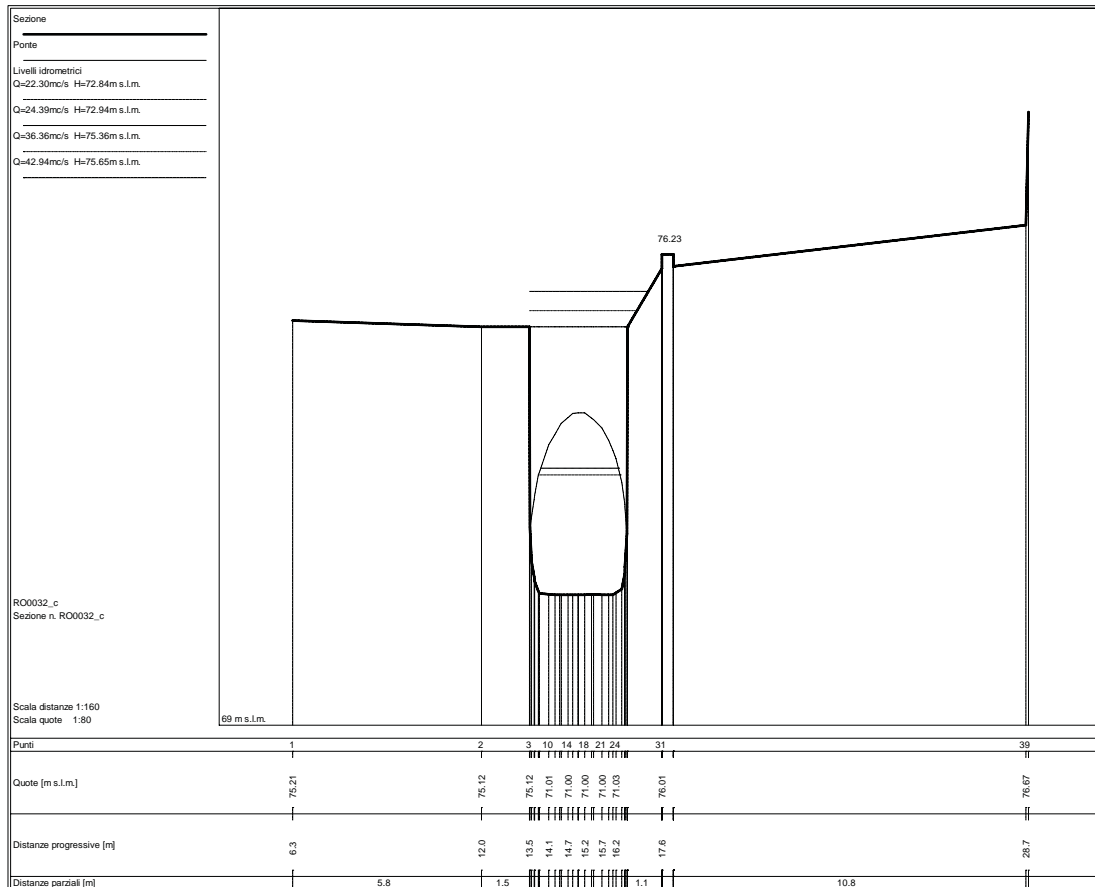
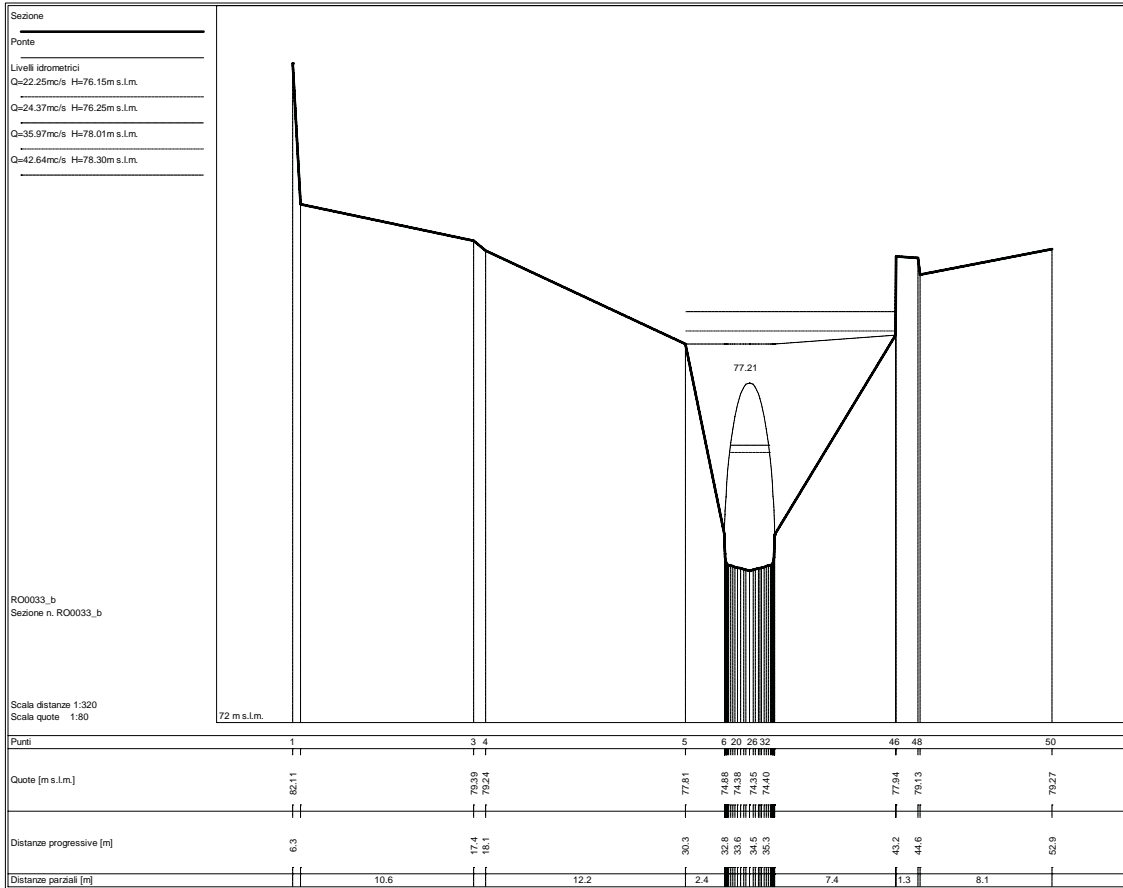

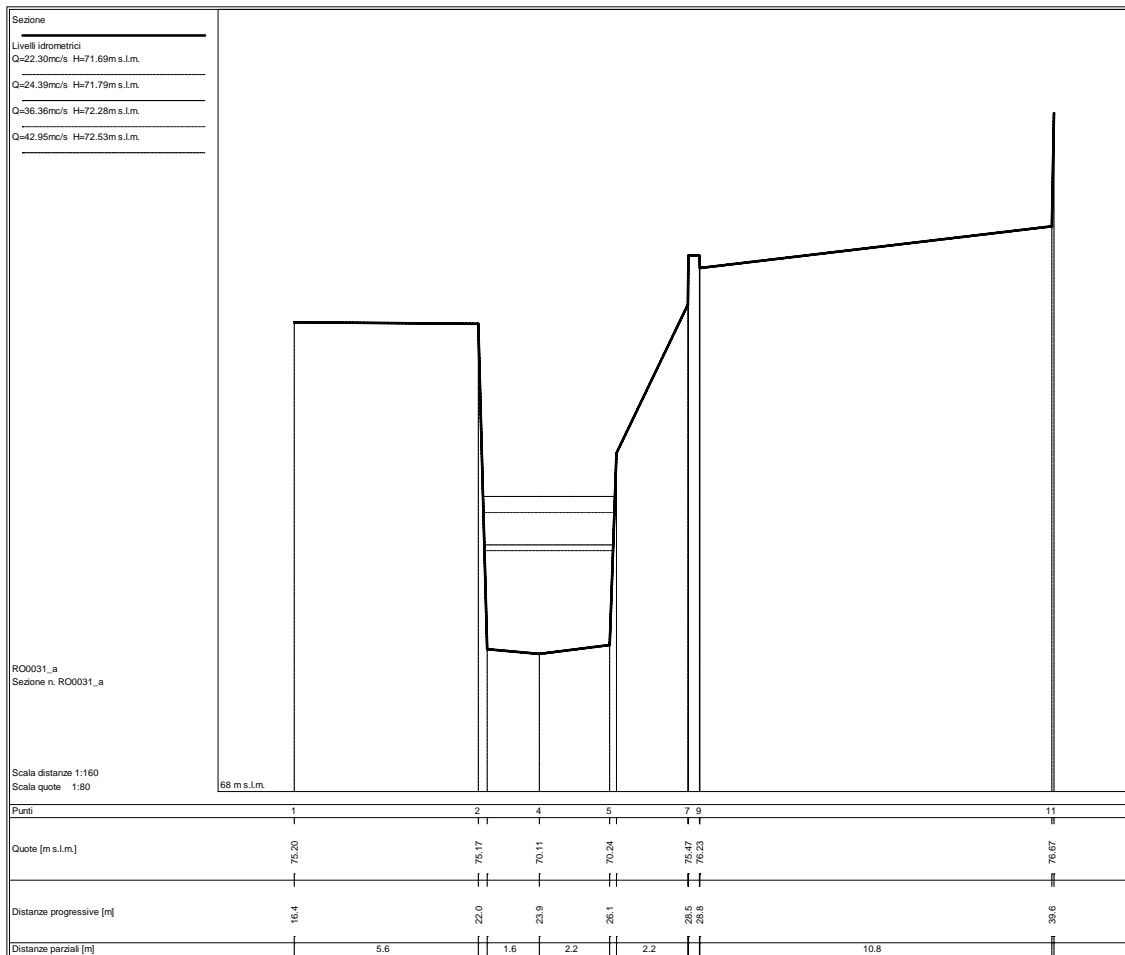
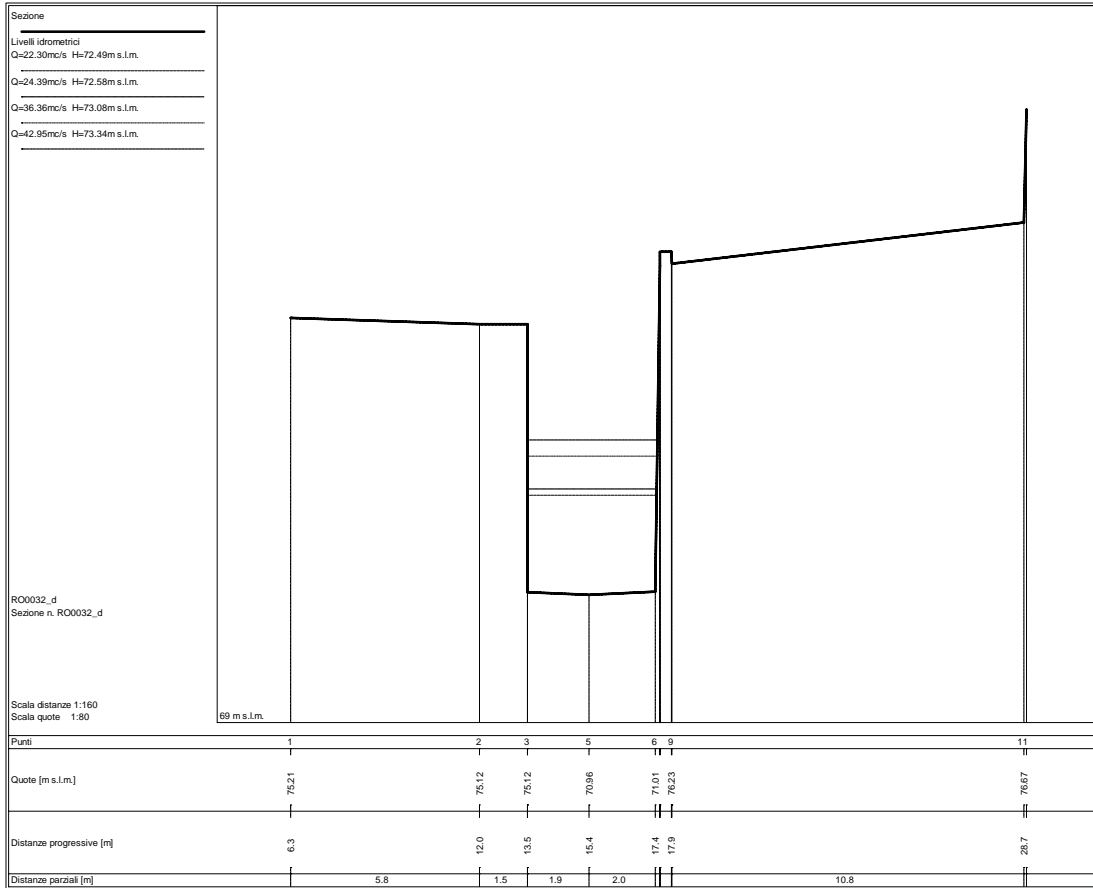

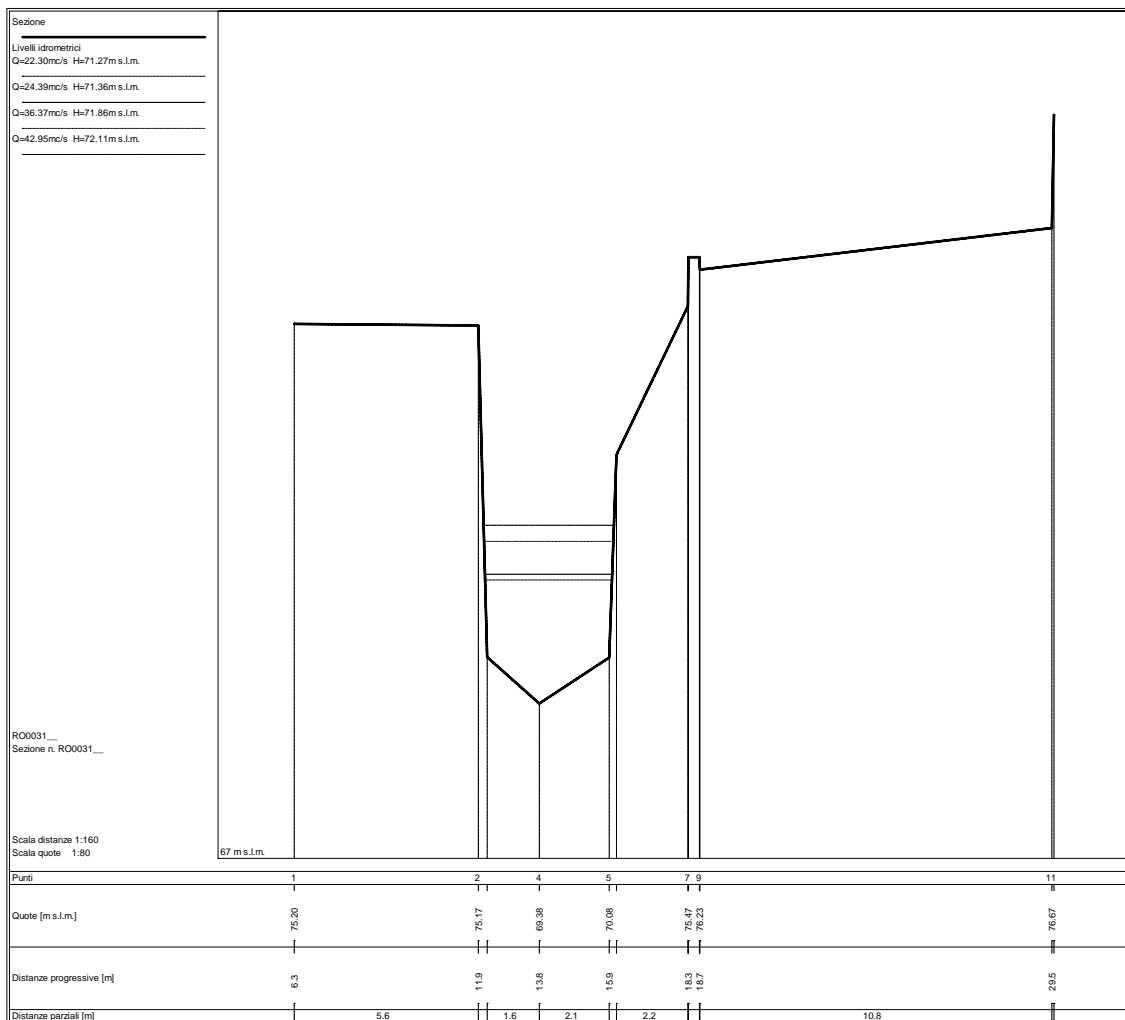
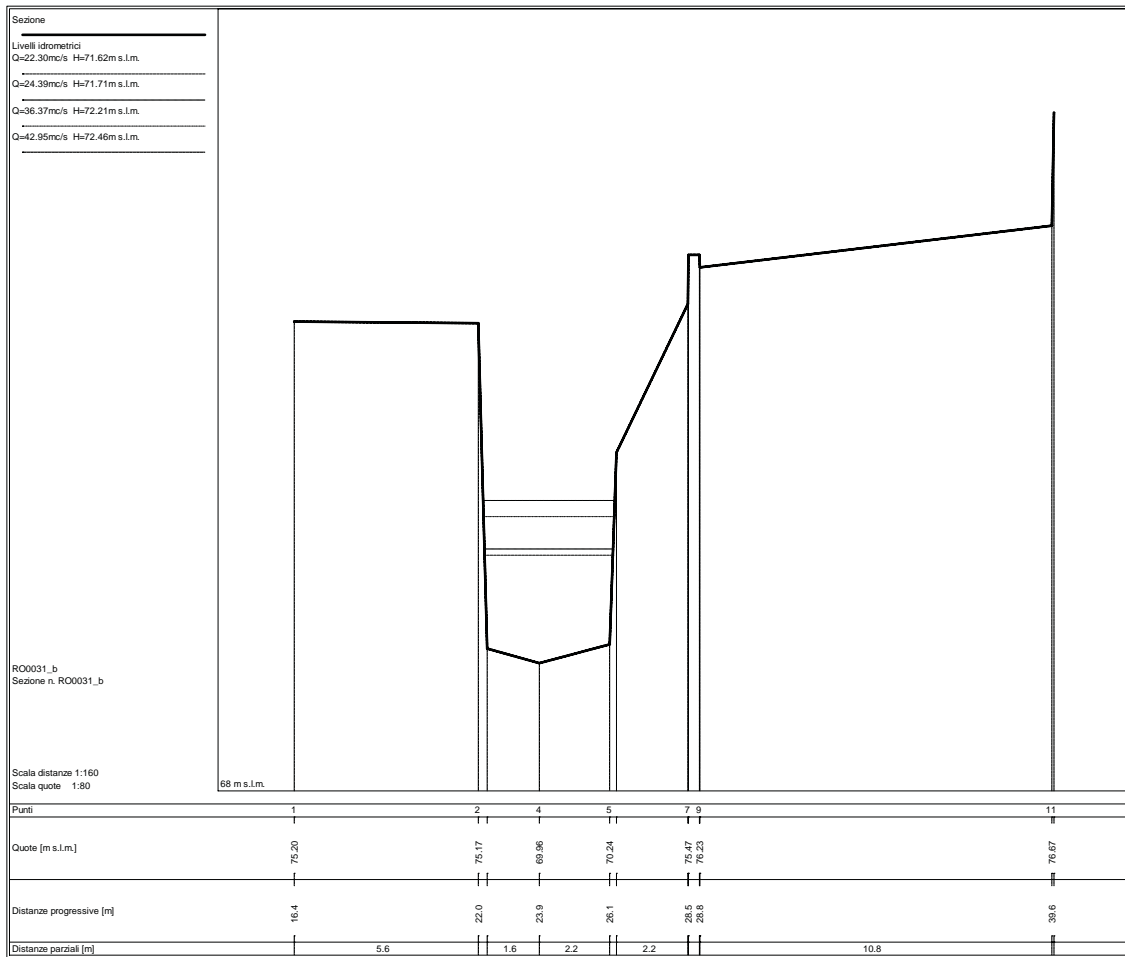

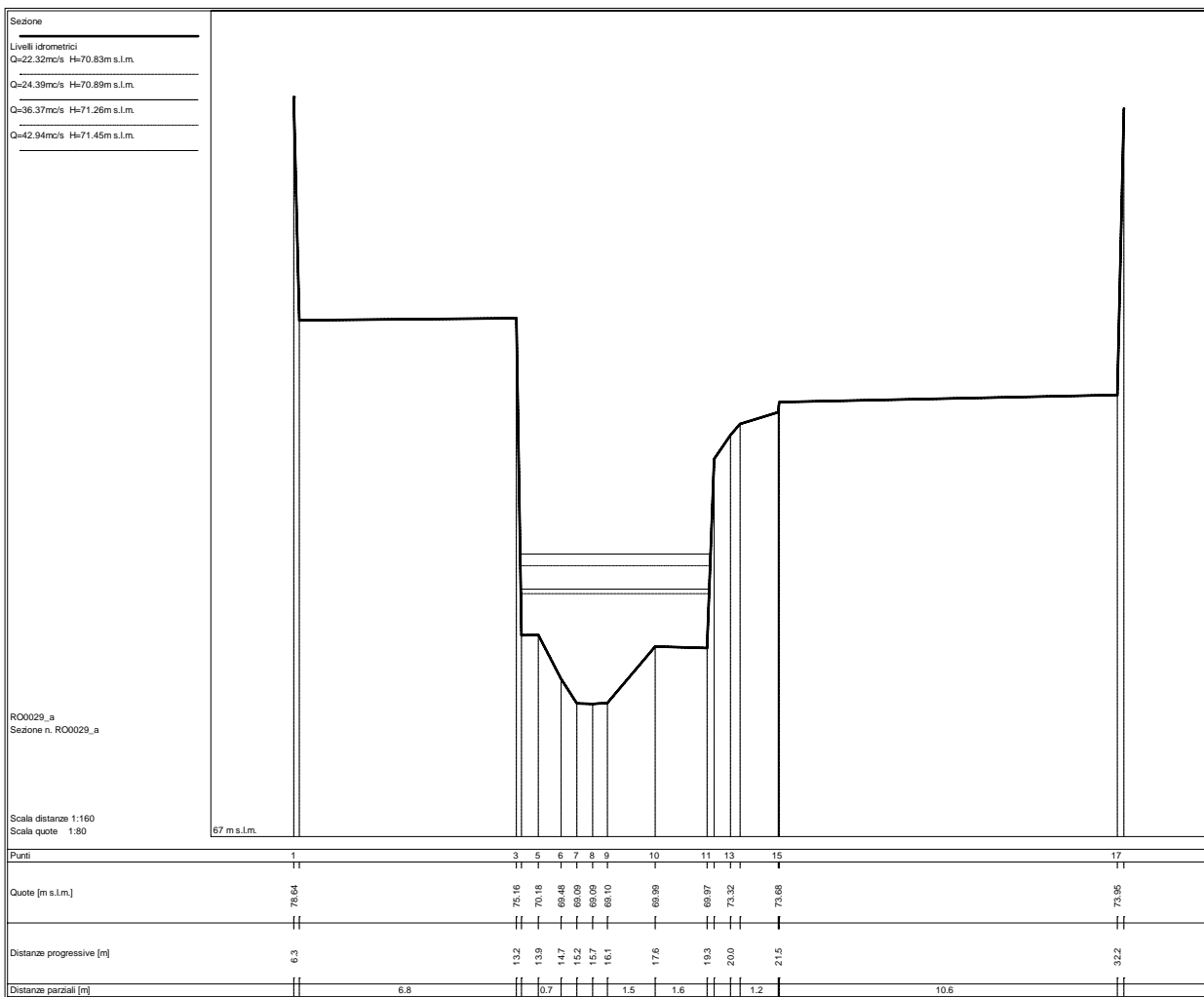
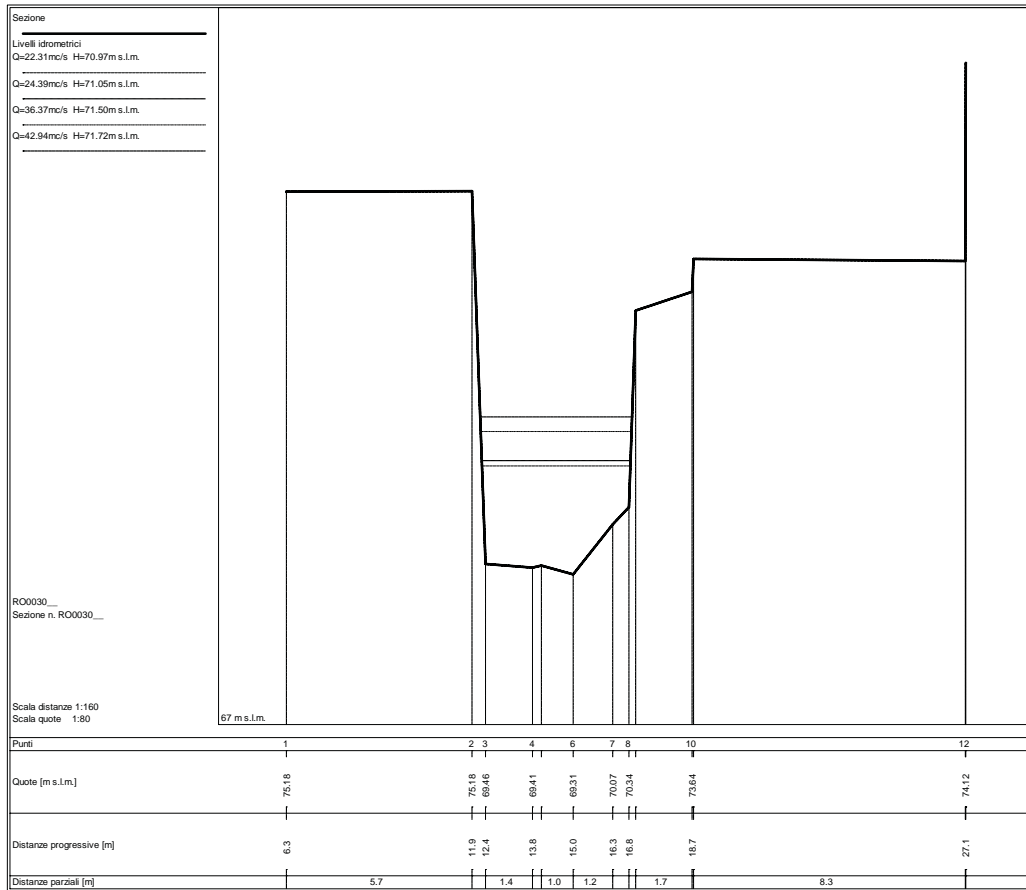

Sezione
 Livelli idrometrici
 Q=22.32m³/s H=70.06m s.l.m.
 Q=24.39m³/s H=70.14m s.l.m.
 Q=36.37m³/s H=70.51m s.l.m.
 Q=42.94m³/s H=70.70m s.l.m.

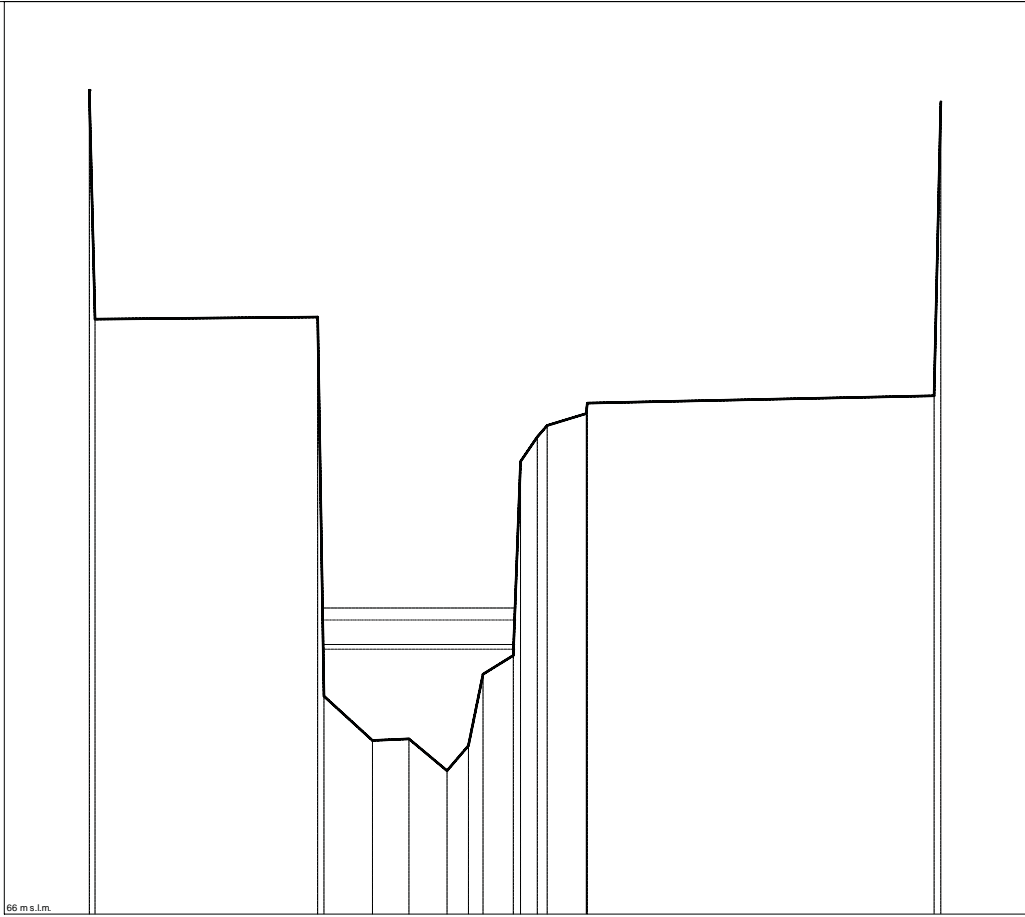

RO0028_a
 Sezione n. RO0028_a

Scala distanze 1:160
 Scala quote 1:80

66 m s.l.m.

Punti	1	3	5	6	7	8	9	10	12	14	16
Quote [m s.l.m.]	76.64	75.16	68.66	68.69	68.20	68.68	69.68	69.97	73.32	73.68	73.95
Distanze progressive [m]	2.6	9.6	11.3	12.4	13.6	14.2	14.7	15.6	16.3	17.8	26.5
Distanze parziali [m]		6.8	1.5	1.1	1.2	0.7	0.9			1.2	10.6

Sezione
 Livelli idrometrici
 Q=22.32m³/s H=70.06m s.l.m.
 Q=24.39m³/s H=70.13m s.l.m.
 Q=36.37m³/s H=70.50m s.l.m.
 Q=42.94m³/s H=70.69m s.l.m.

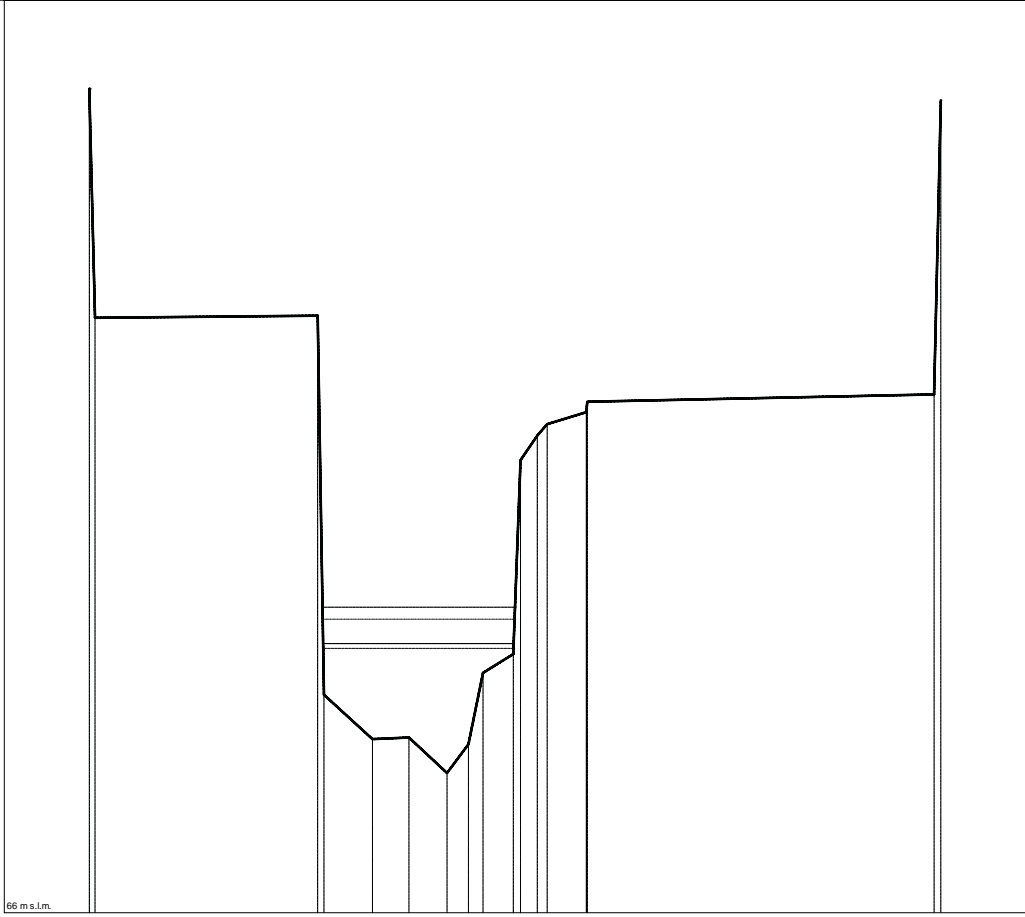

RO0028
 Sezione n. RO0028

Scala distanze 1:160
 Scala quote 1:80

66 m s.l.m.

Punti	1	3	5	6	7	8	9	10	12	14	16
Quote [m s.l.m.]	76.64	75.16	68.66	68.69	68.15	68.68	69.68	69.97	73.32	73.68	73.95
Distanze progressive [m]	6.3	13.2	14.9	16.1	17.2	17.9	18.3	18.3	20.0	21.5	32.2
Distanze parziali [m]		6.8	1.5	1.1	1.2	0.7	0.9			1.2	10.6

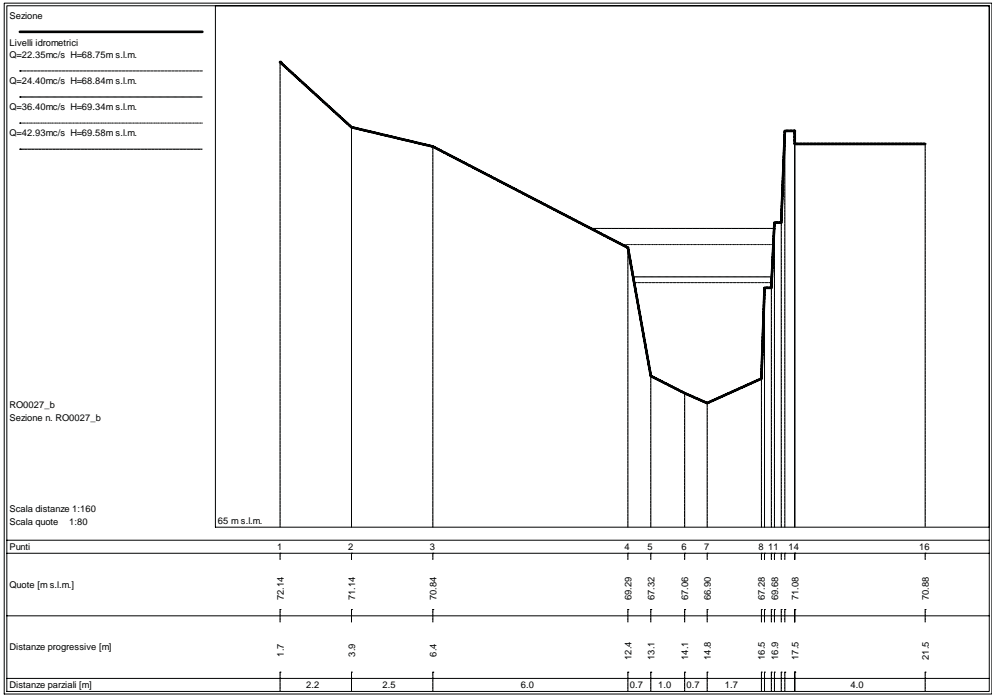
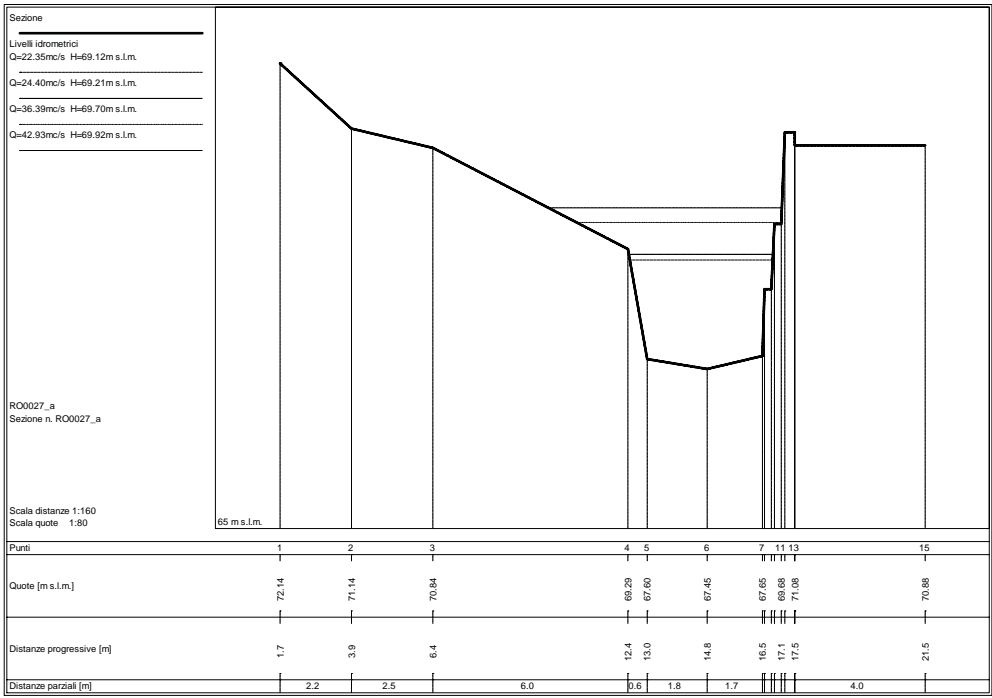

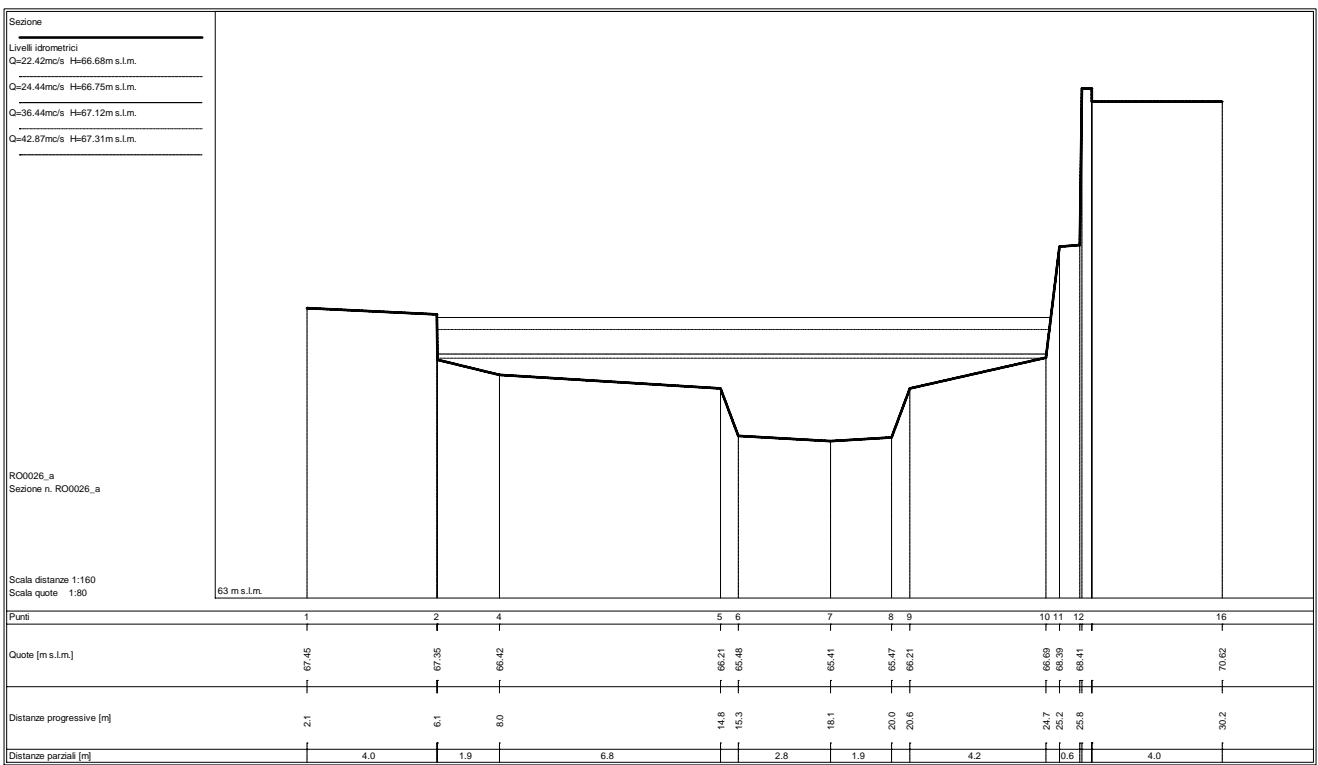
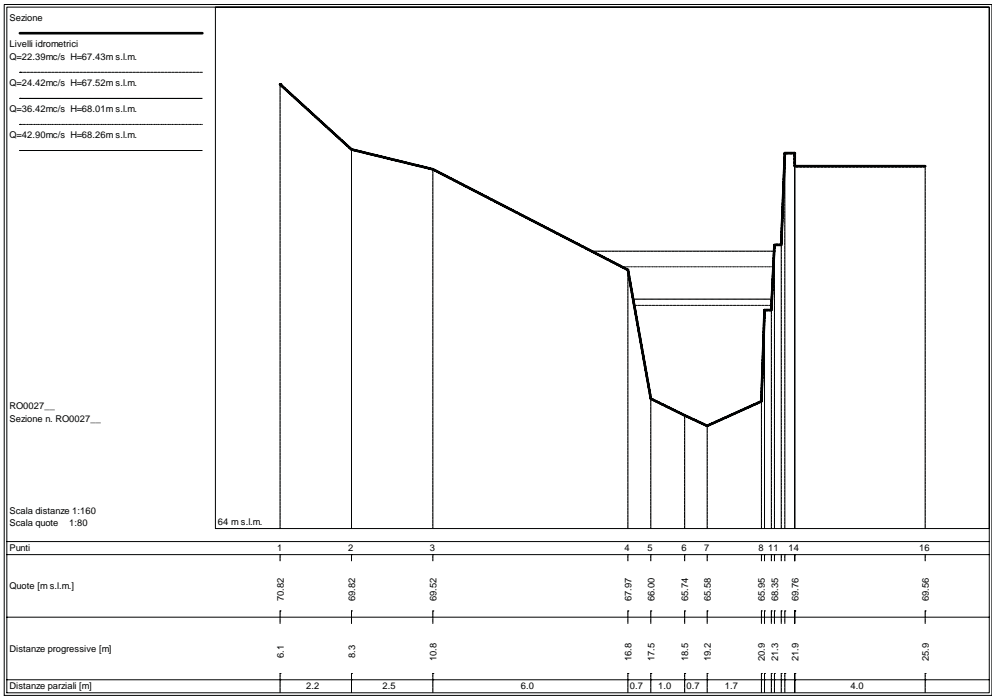

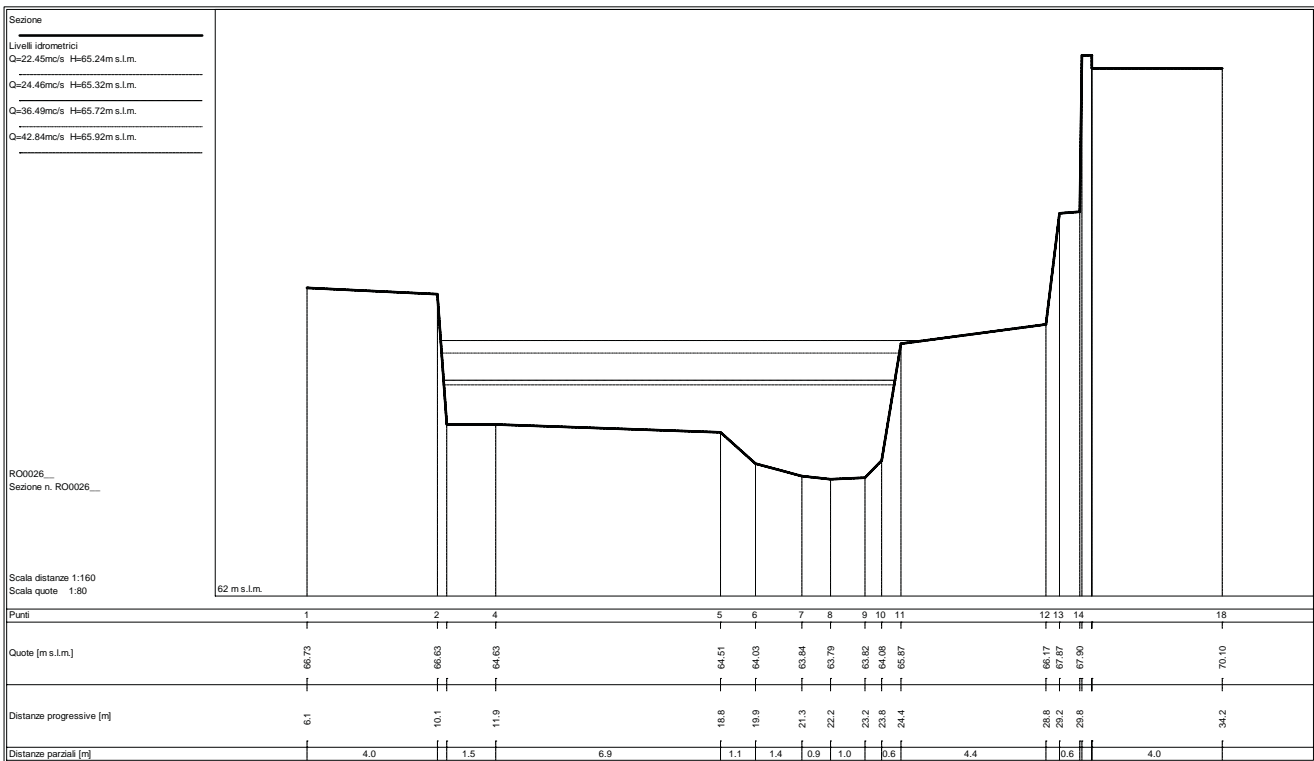
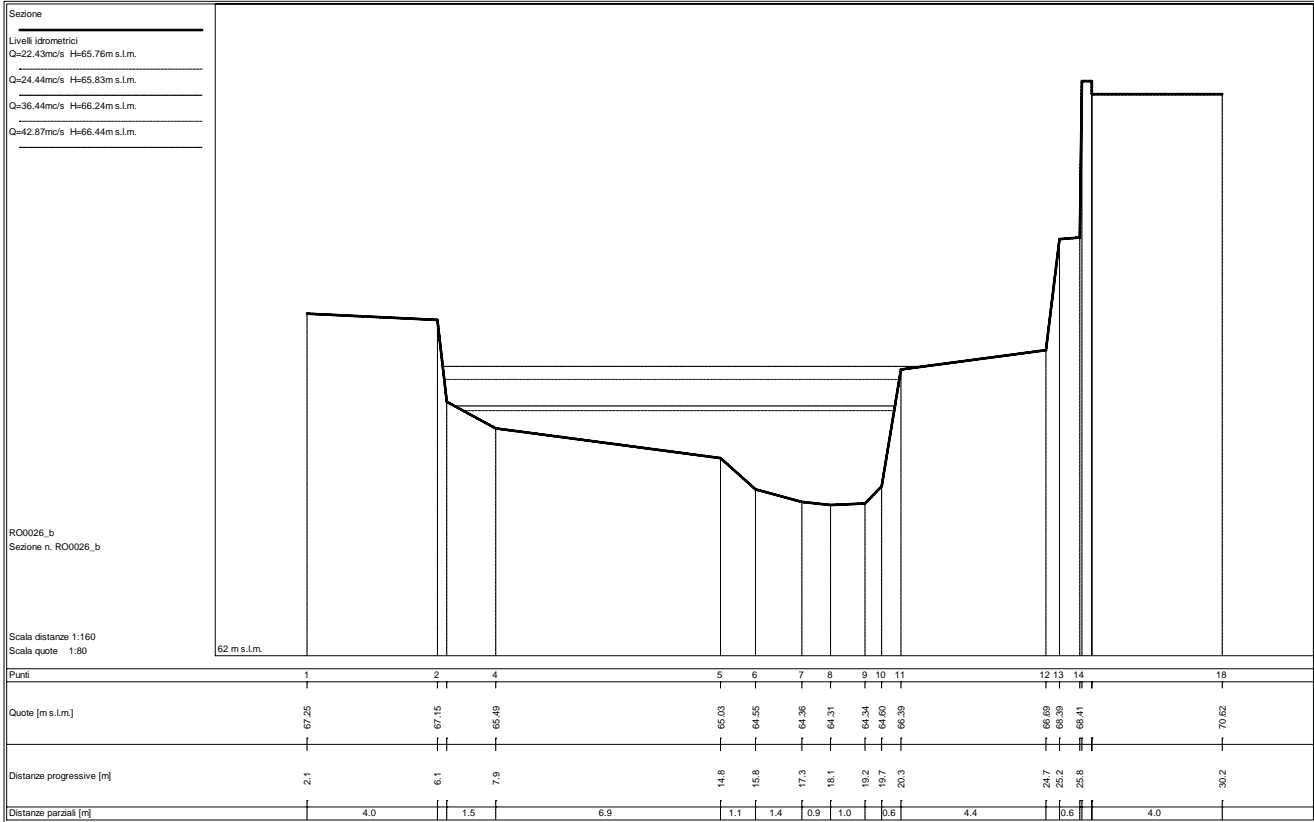

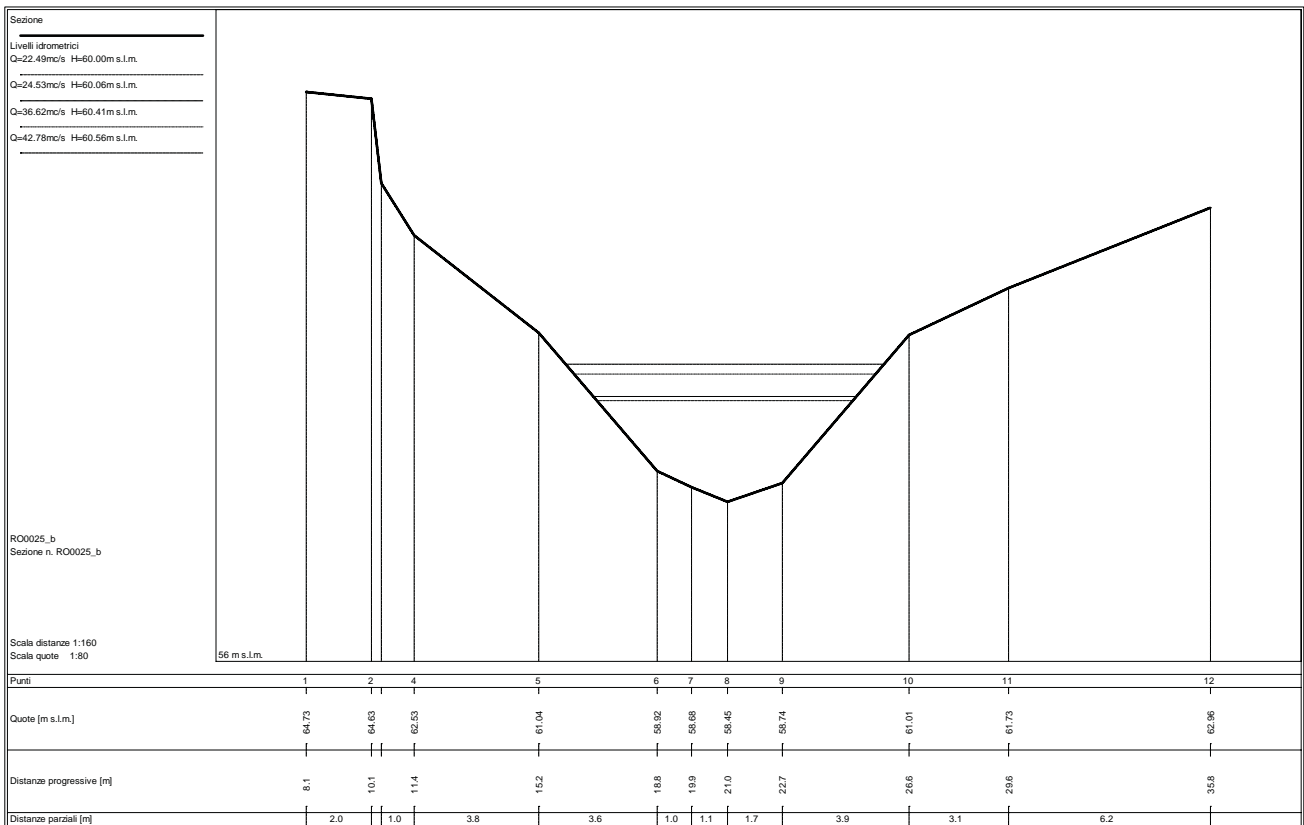
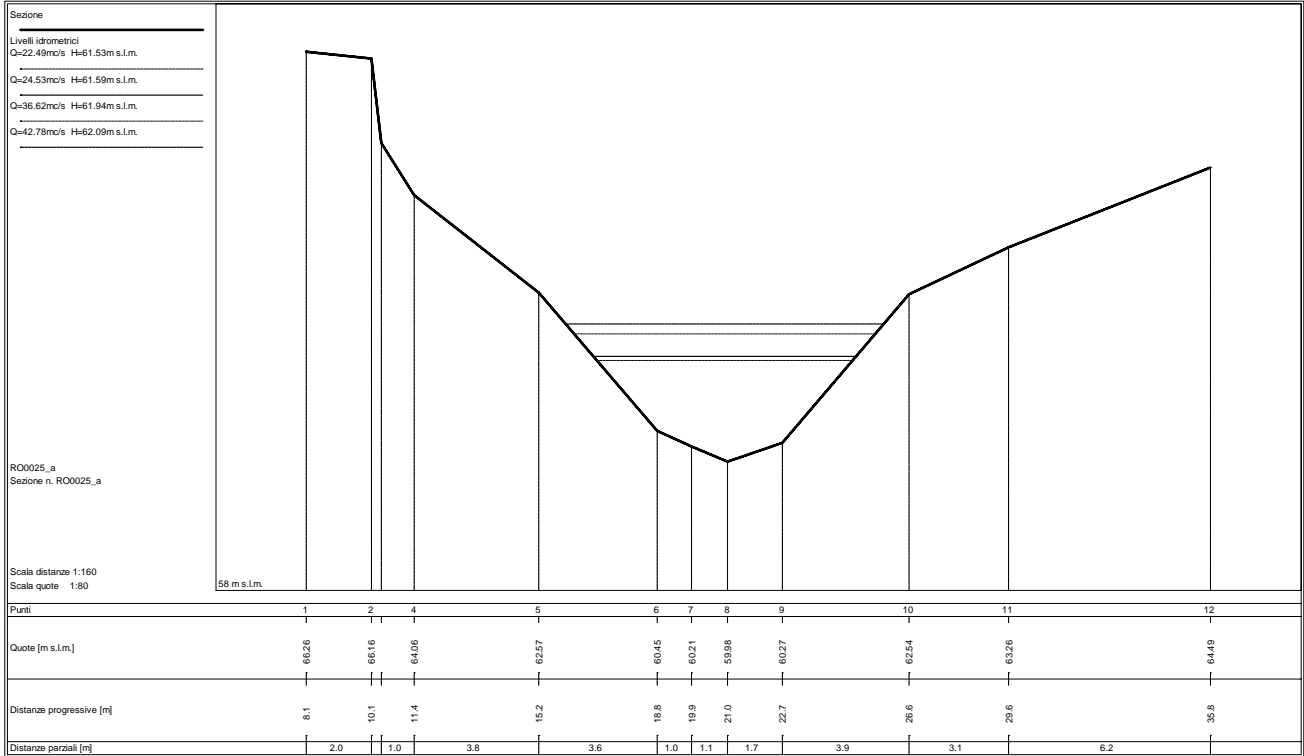

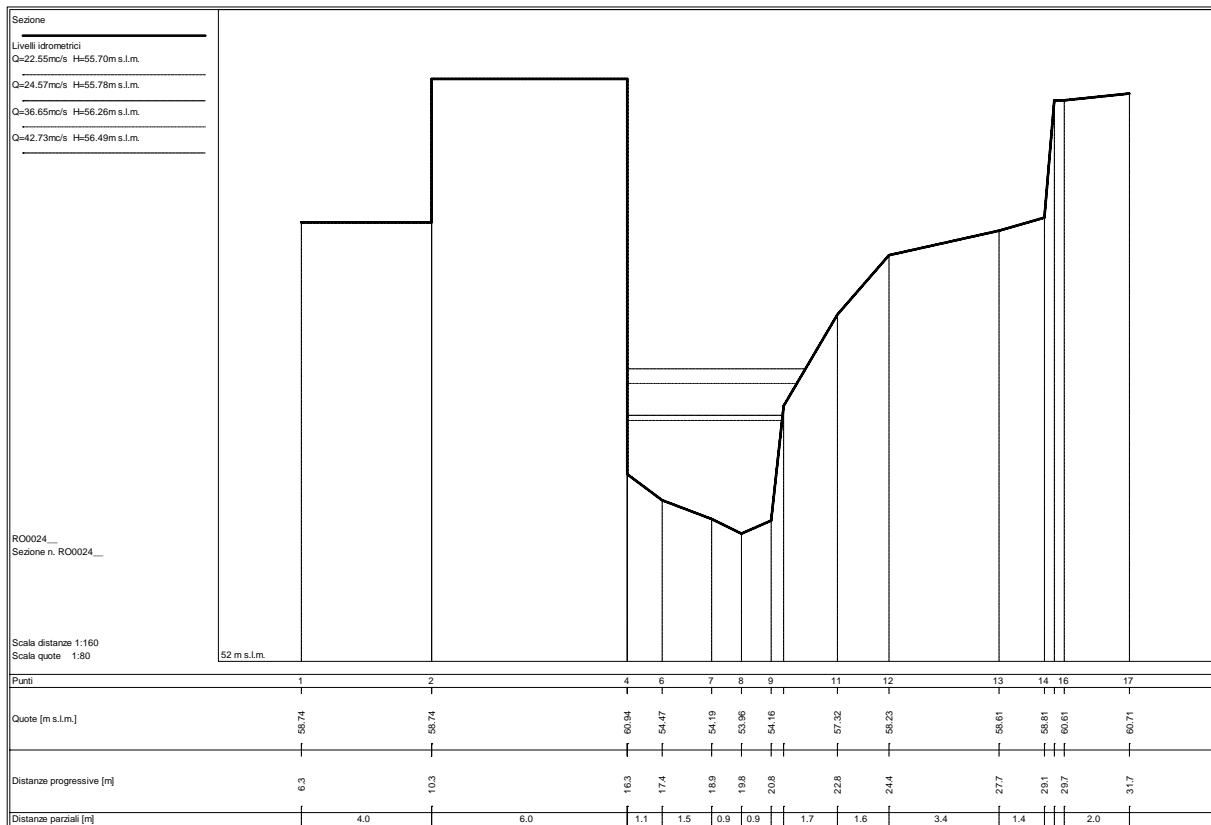
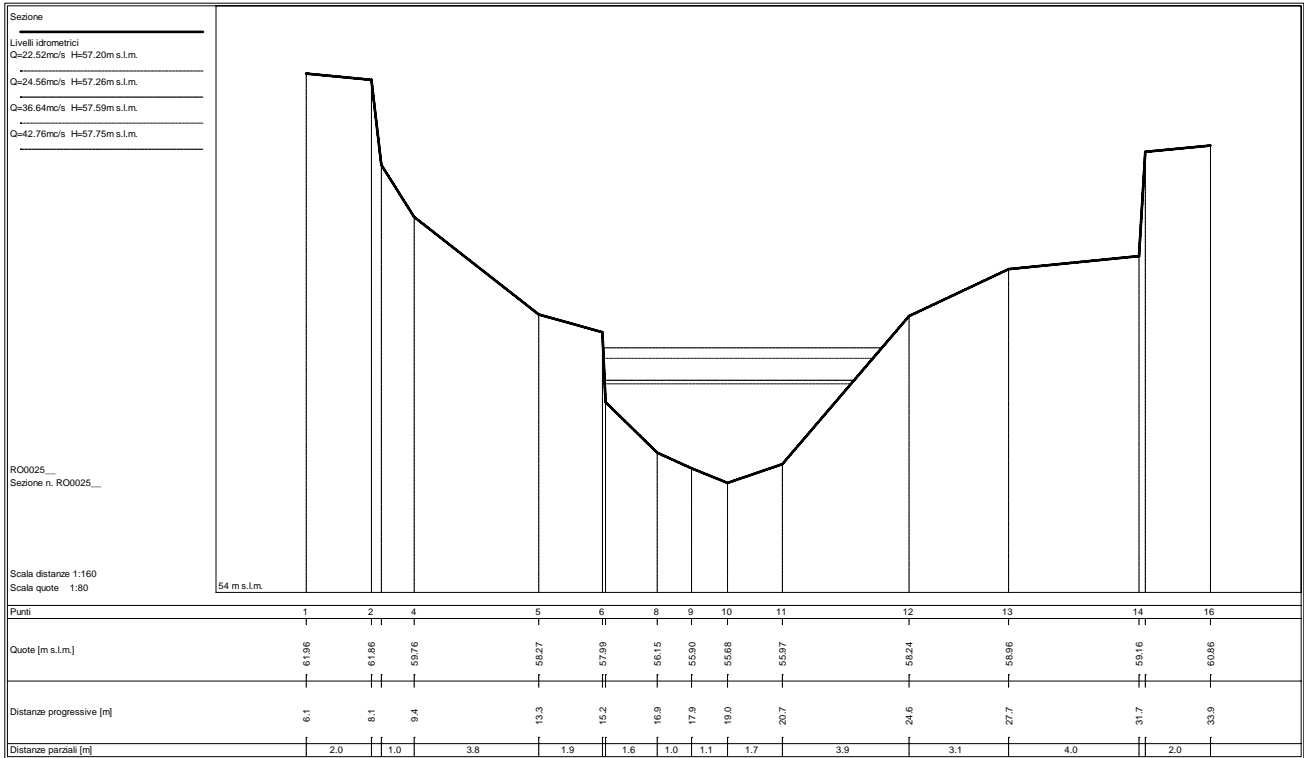

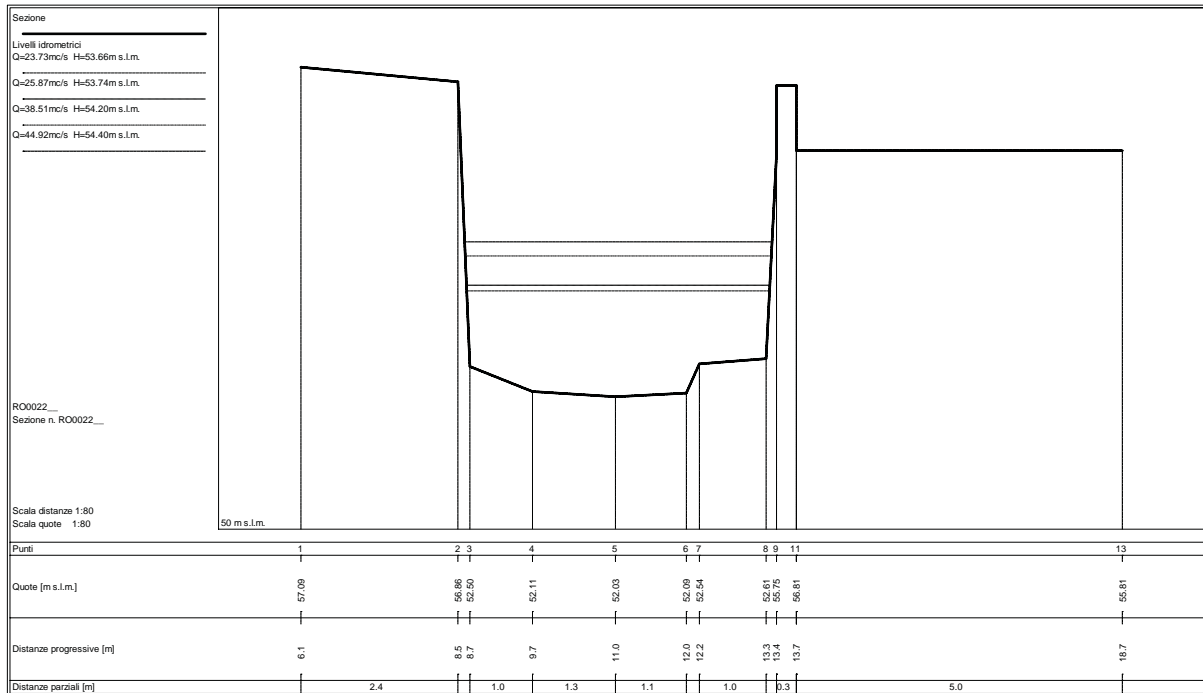
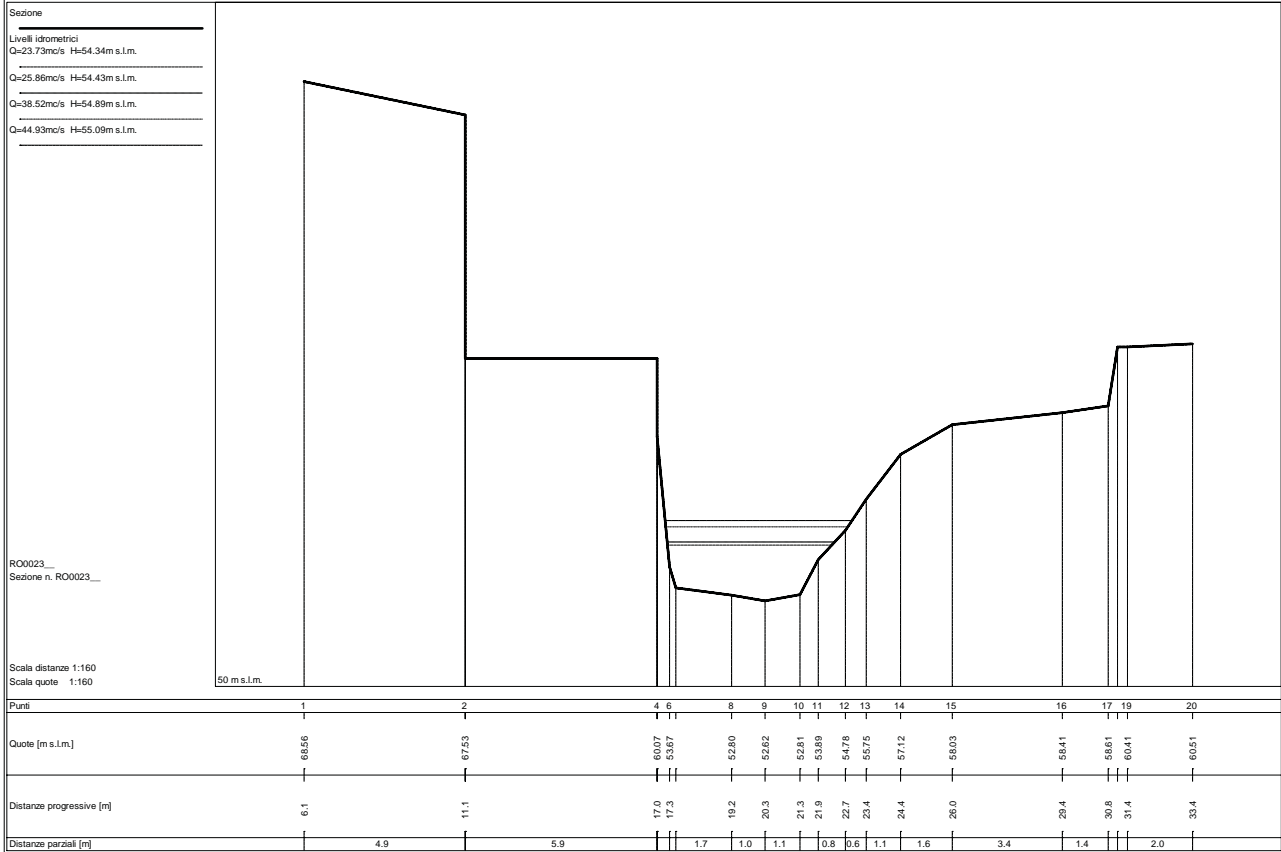

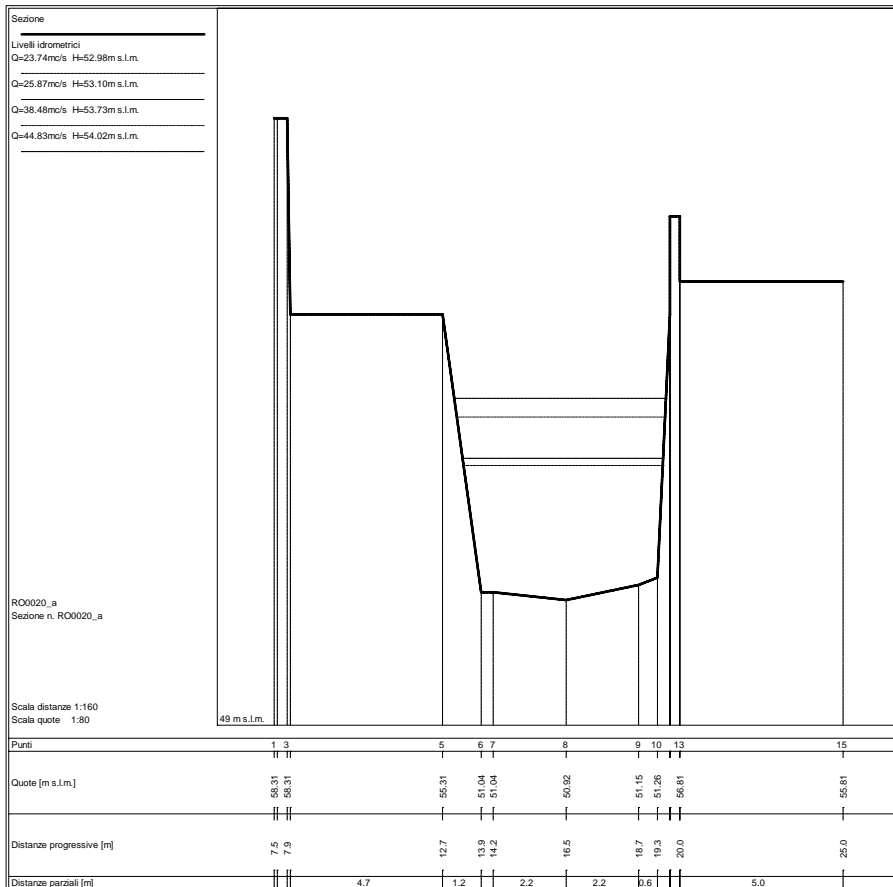
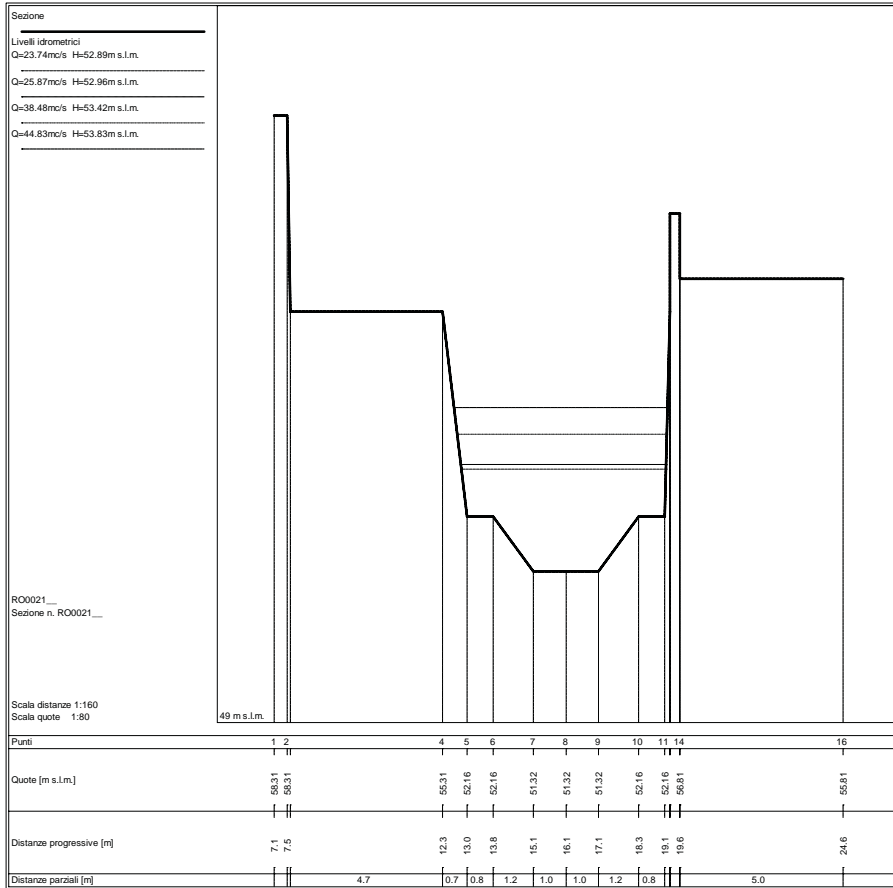

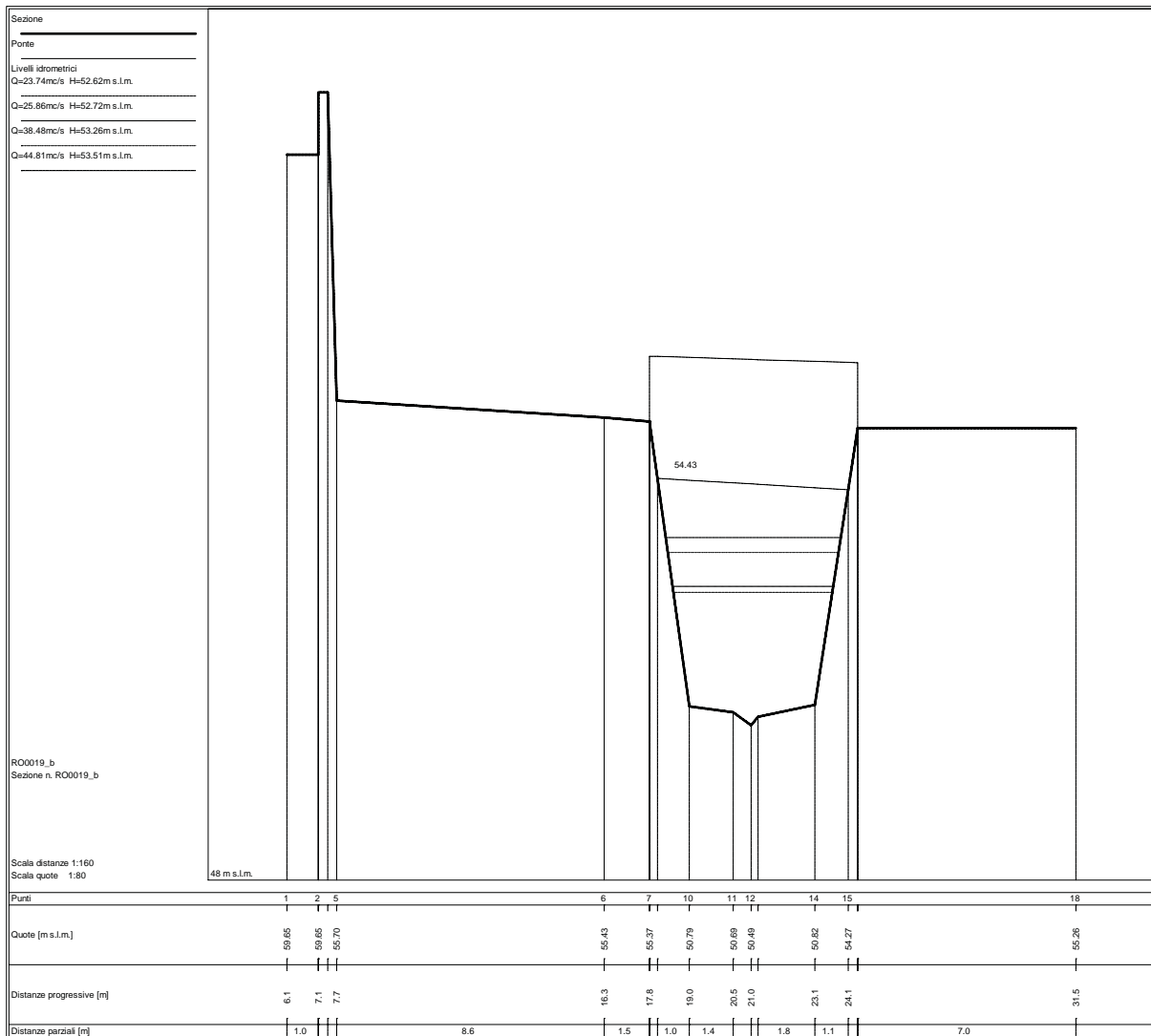
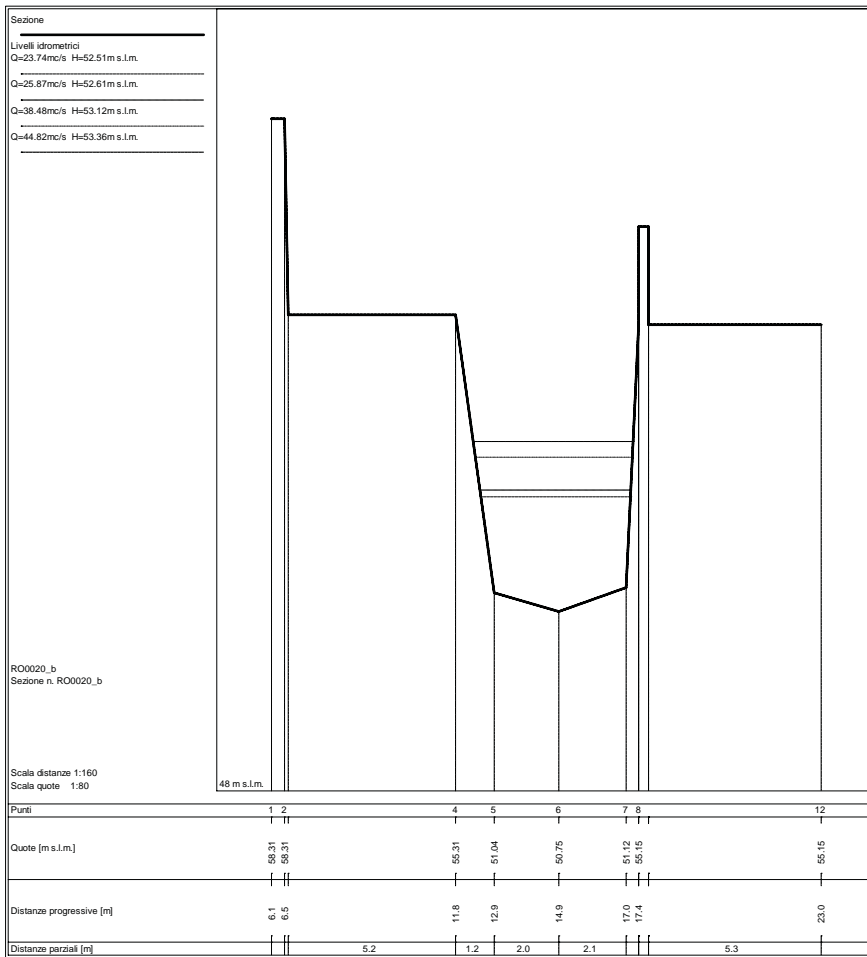

Sezione
 Ponte
 Livelli idrometrici
 Q=23.74m³/s H=52.21m s.l.m.
 Q=25.87m³/s H=52.29m s.l.m.
 Q=38.47m³/s H=52.76m s.l.m.
 Q=44.81m³/s H=52.97m s.l.m.

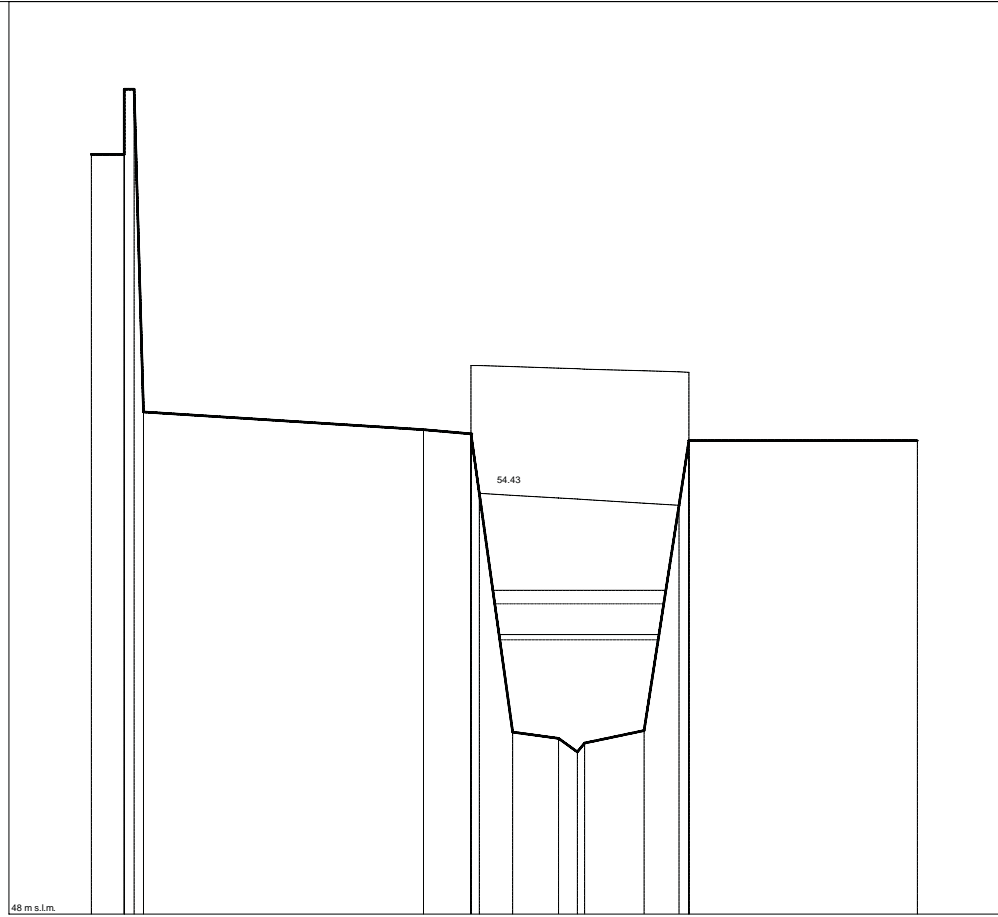

RO0019_c
 Sezione n. RO0019_c

Scala distanze 1:160
 Scala quote 1:80

Punti	1	2	5	6	7	10	11	12	14	15	18
Quote [m s.l.m.]	59.85	59.85	55.70	55.43	55.37	50.79	50.89	50.49	50.82	54.27	55.28
Distanze progressive [m]	6.1	7.1	7.7	16.3	17.8	19.0	20.5	21.0	23.1	24.1	31.5
Distanze parziali [m]	1.0			8.6	1.5	1.0	1.4		1.8	1.1	7.0

Sezione
 Livelli idrometrici
 Q=23.74m³/s H=52.01m s.l.m.
 Q=25.87m³/s H=52.09m s.l.m.
 Q=38.47m³/s H=52.56m s.l.m.
 Q=44.81m³/s H=52.77m s.l.m.

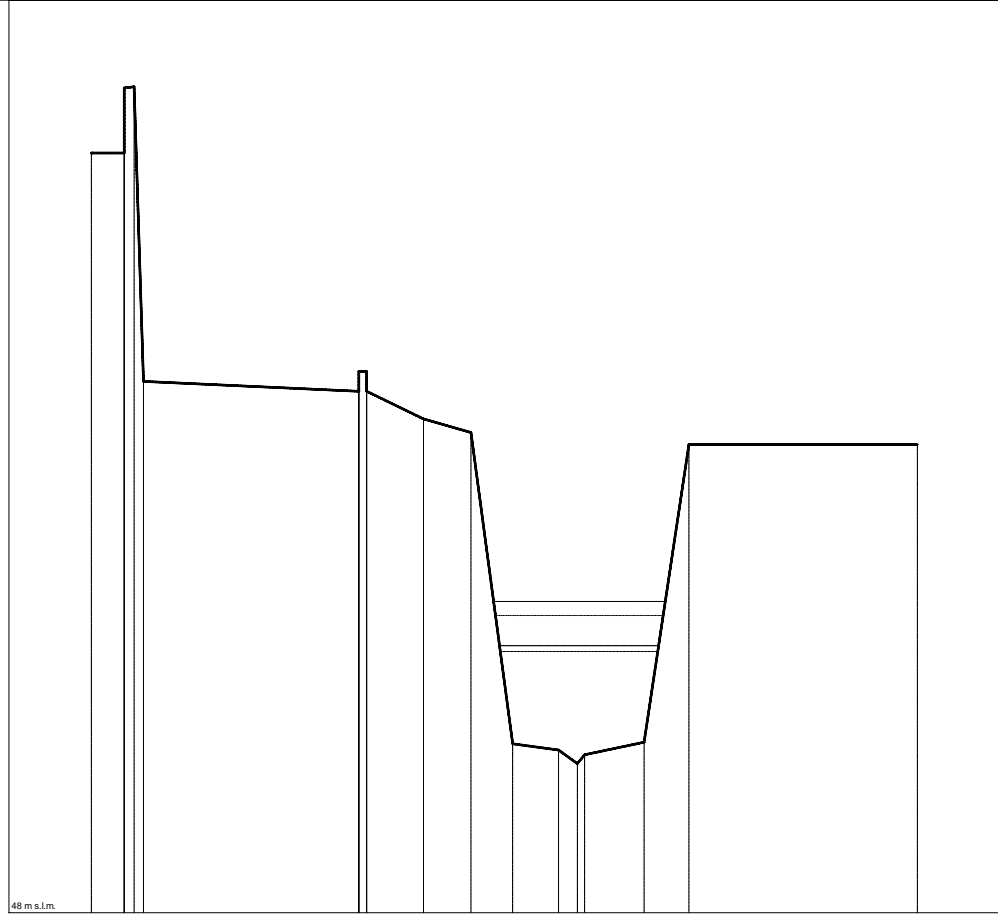

RO0018_d
 Sezione n. RO0018_d

Scala distanze 1:160
 Scala quote 1:80

Punti	1	2	5	6	10	11	12	13	14	16	17	18
Quote [m s.l.m.]	59.85	59.85	56.15	56.00	55.57	55.37	50.59	50.49	50.29	50.62	55.18	55.18
Distanze progressive [m]	6.1	7.1	7.7	14.3	16.3	17.8	19.0	20.5	21.0	23.1	24.5	31.5
Distanze parziali [m]	1.0			6.6	1.7	1.5	1.3	1.4		1.8	1.4	7.0

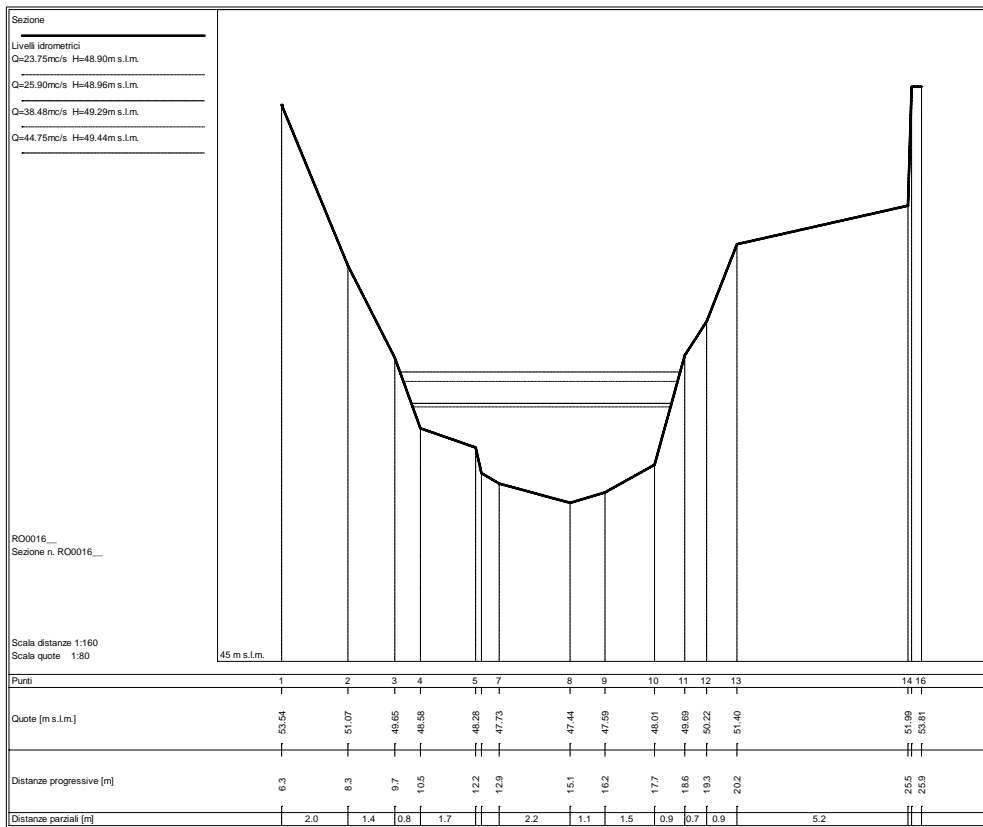
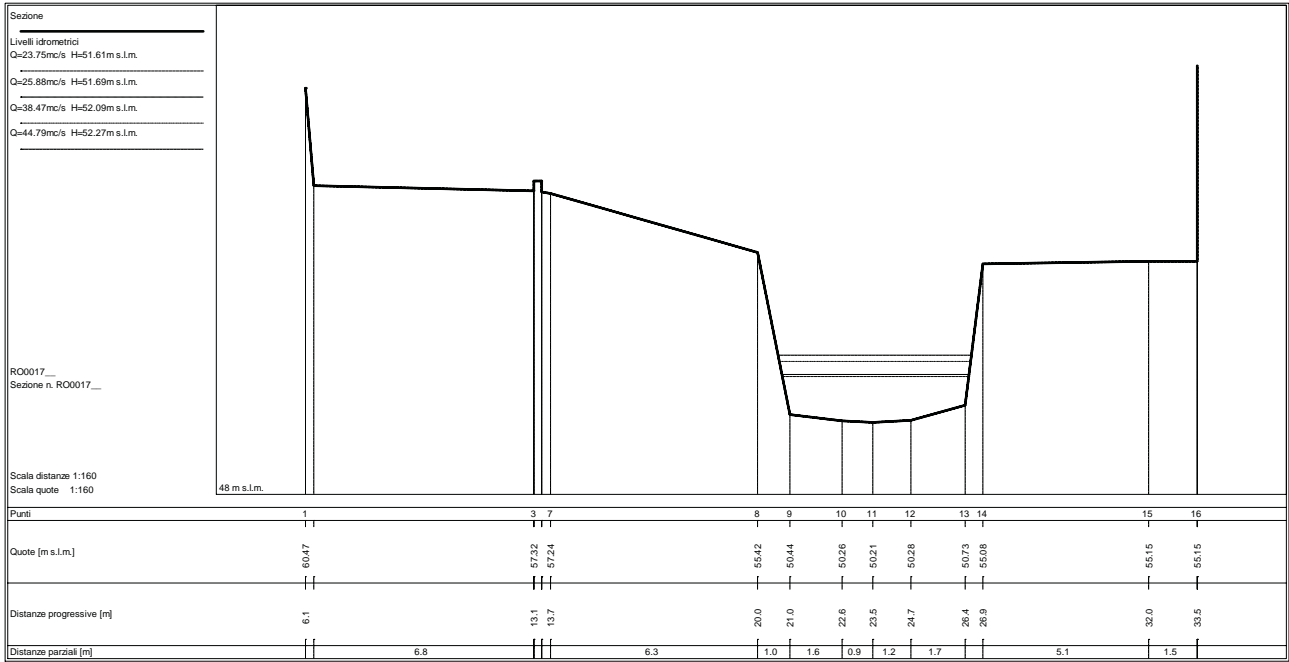

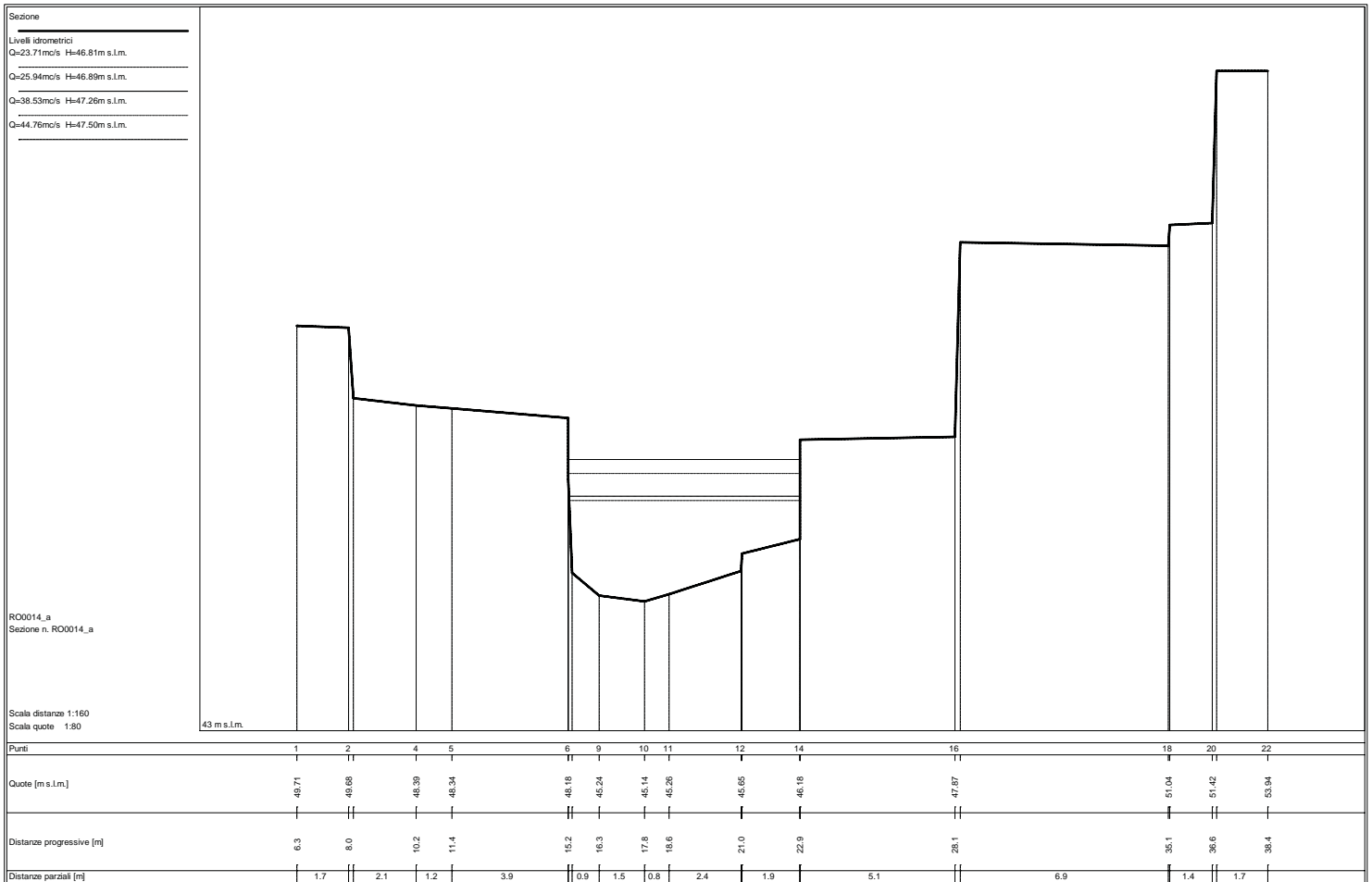
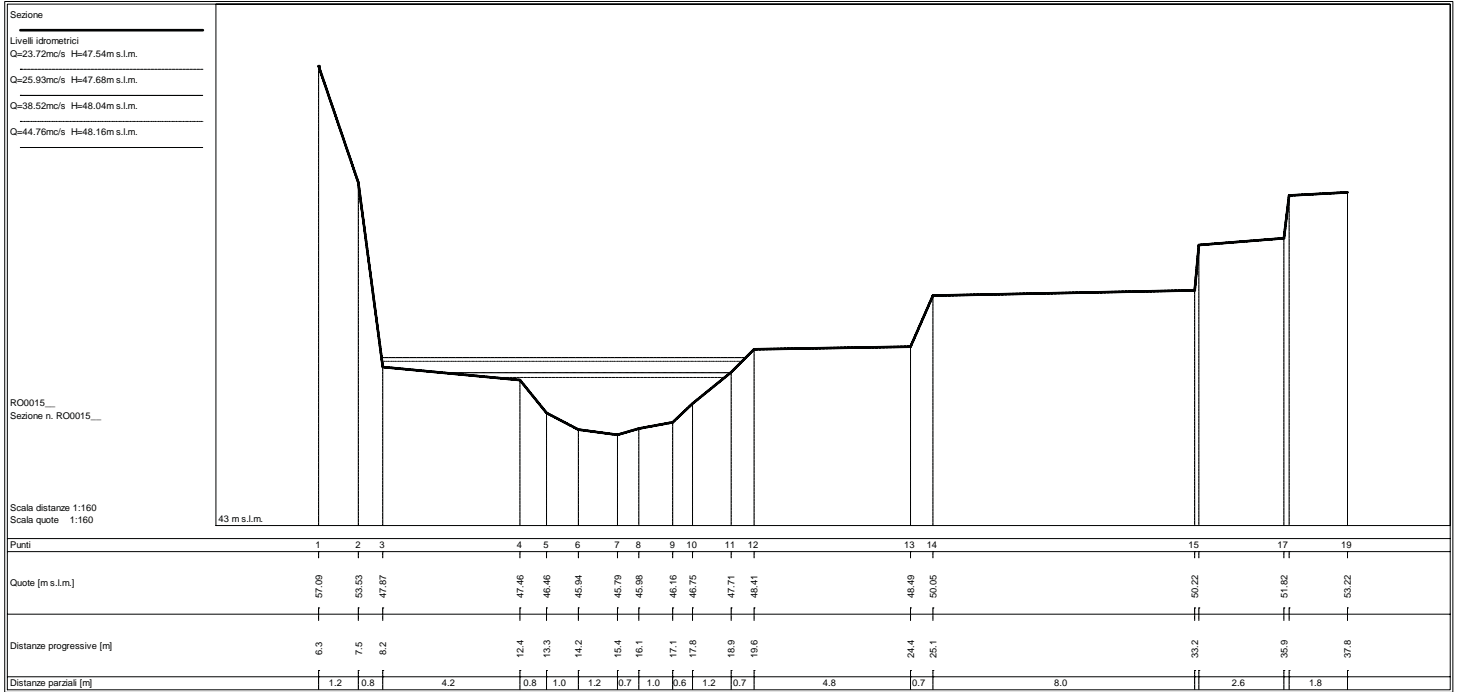

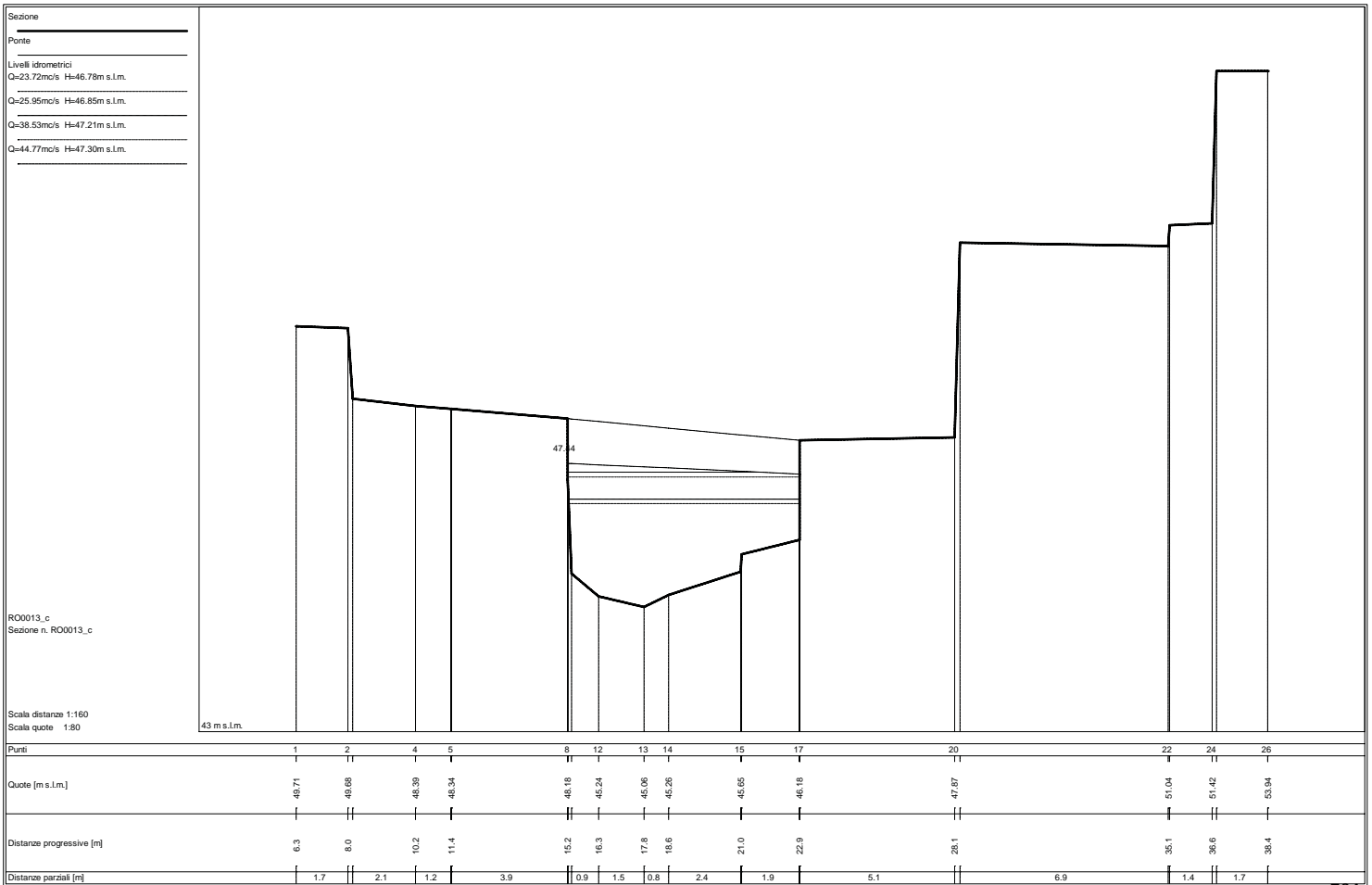
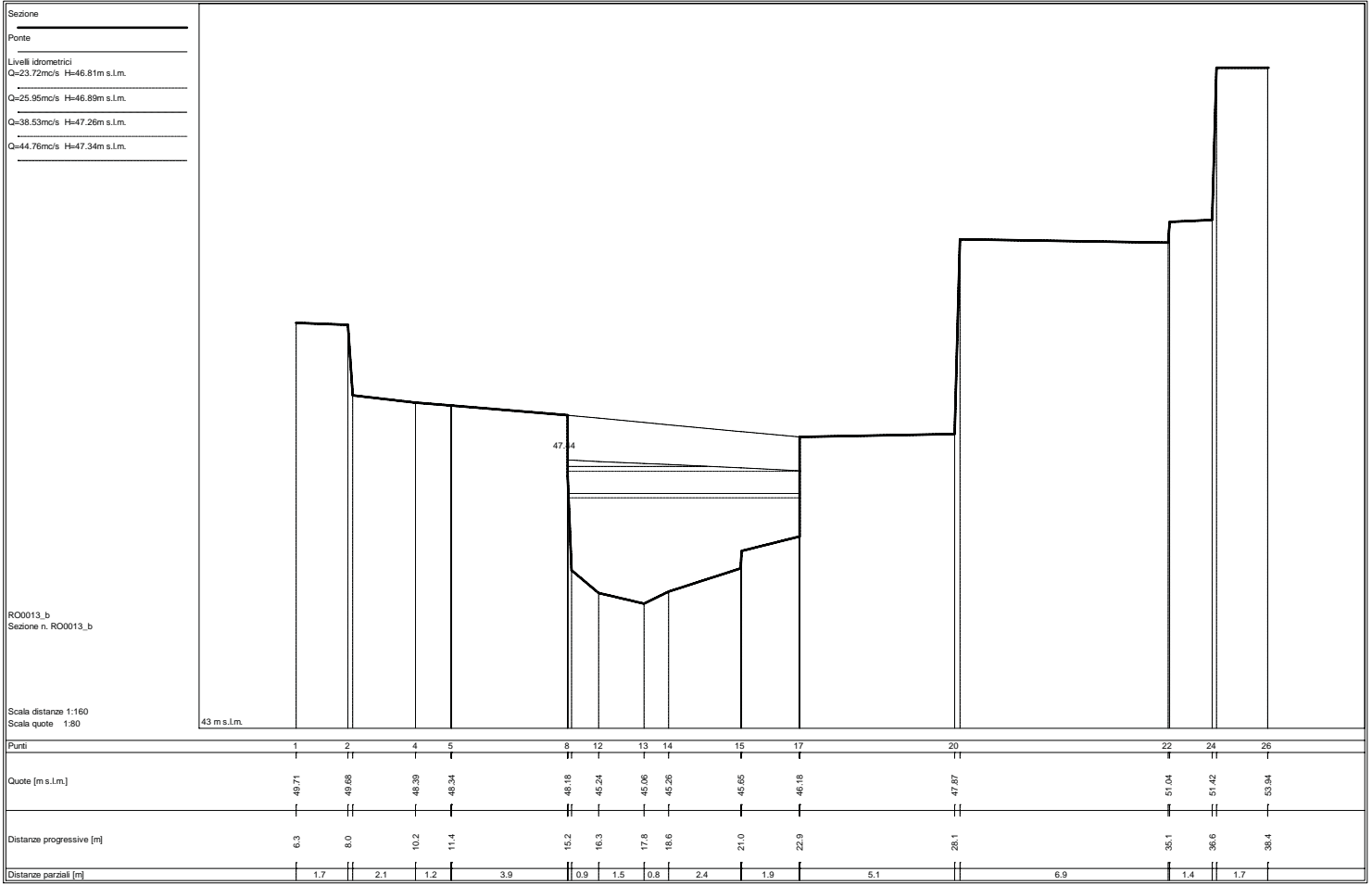

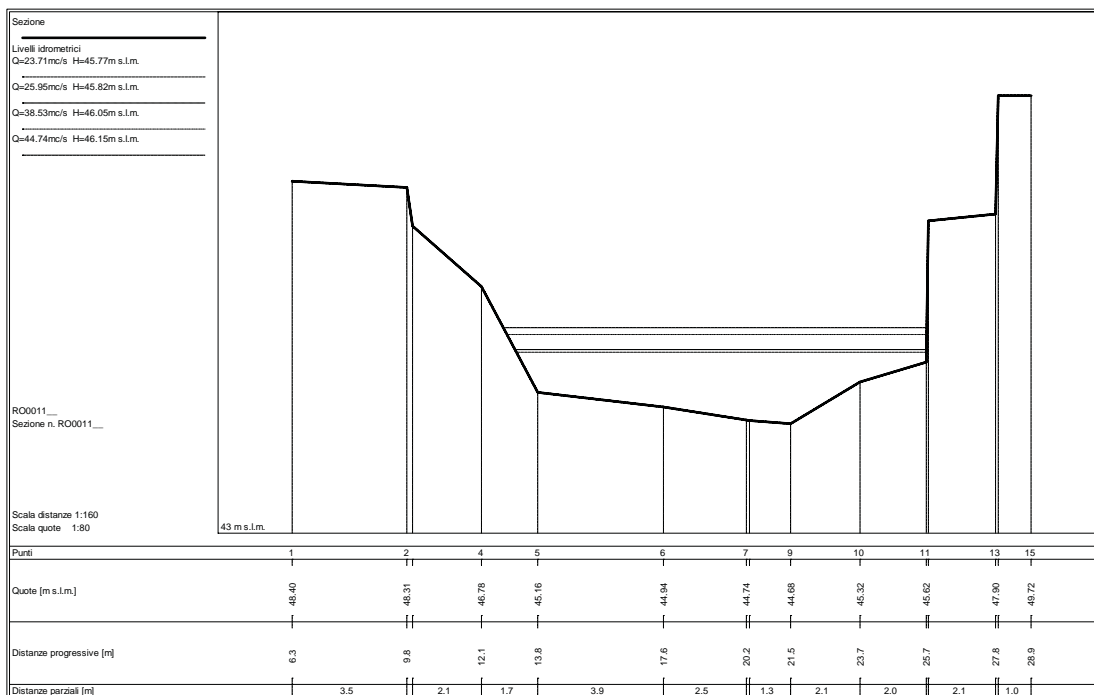
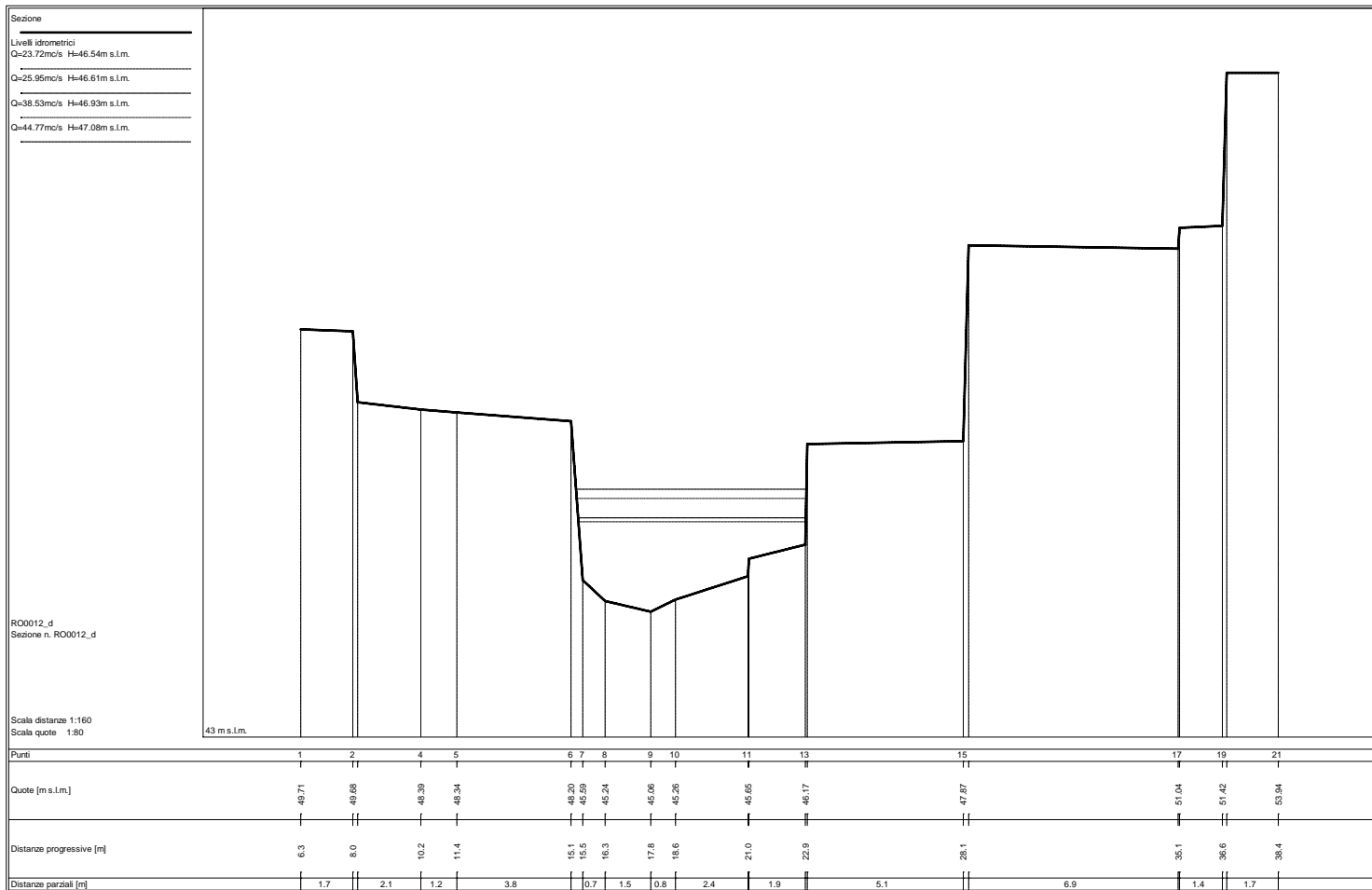

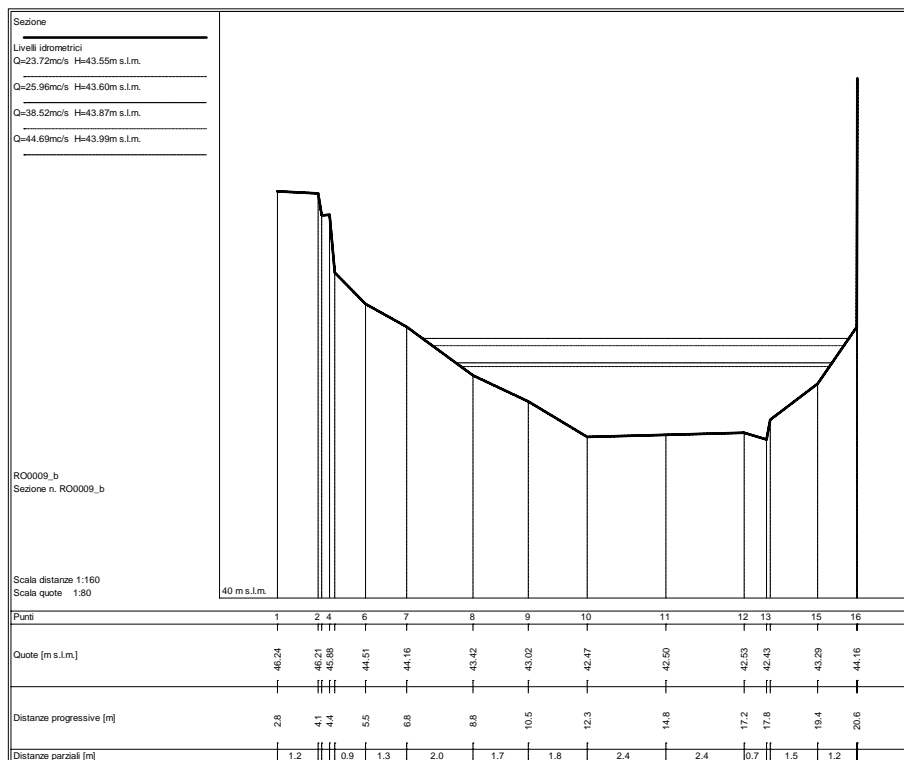
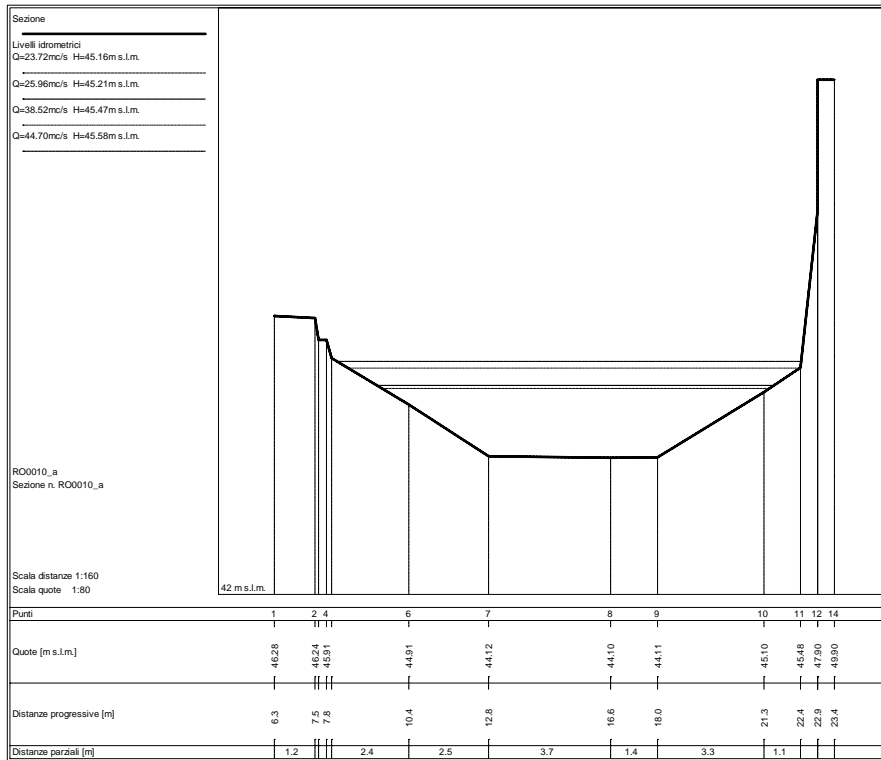

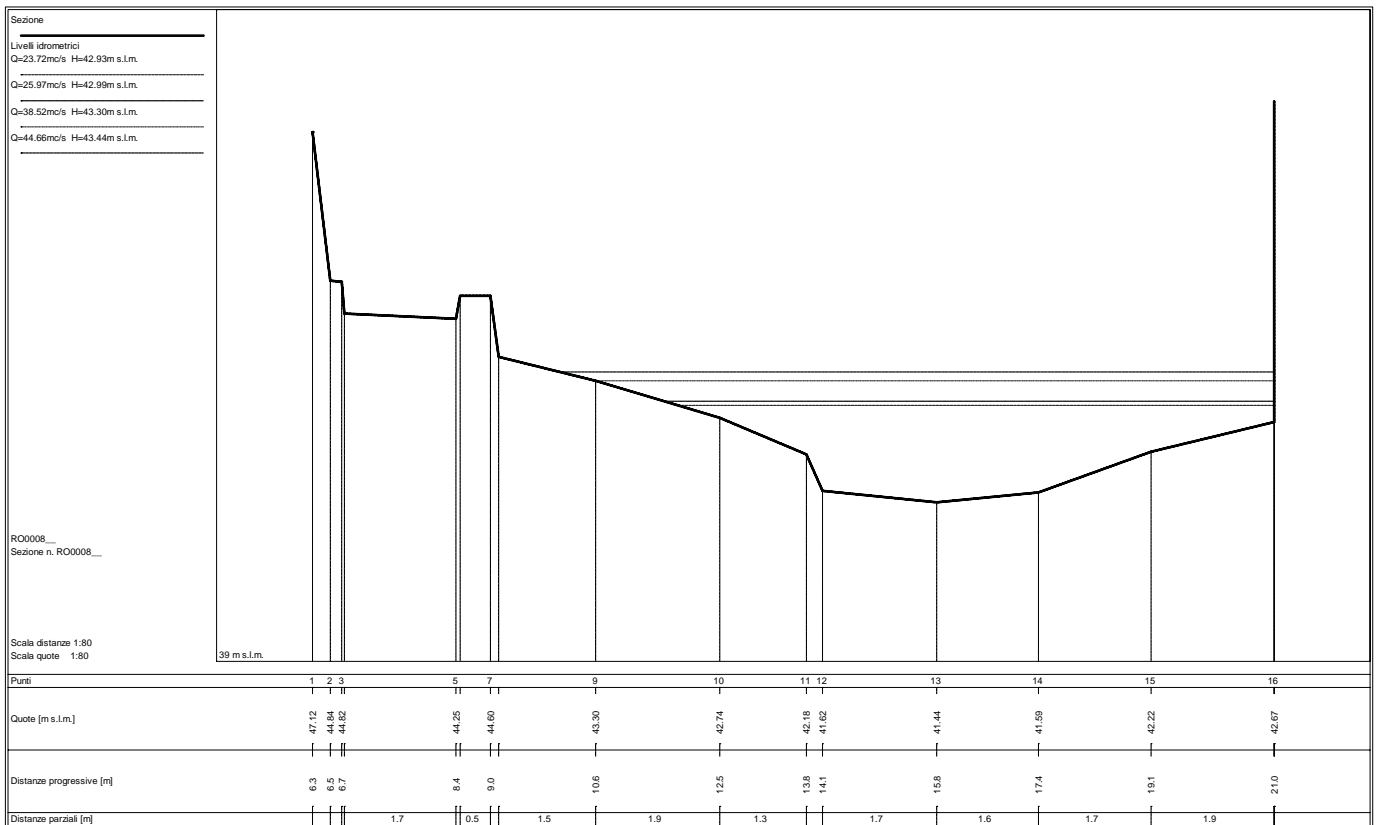
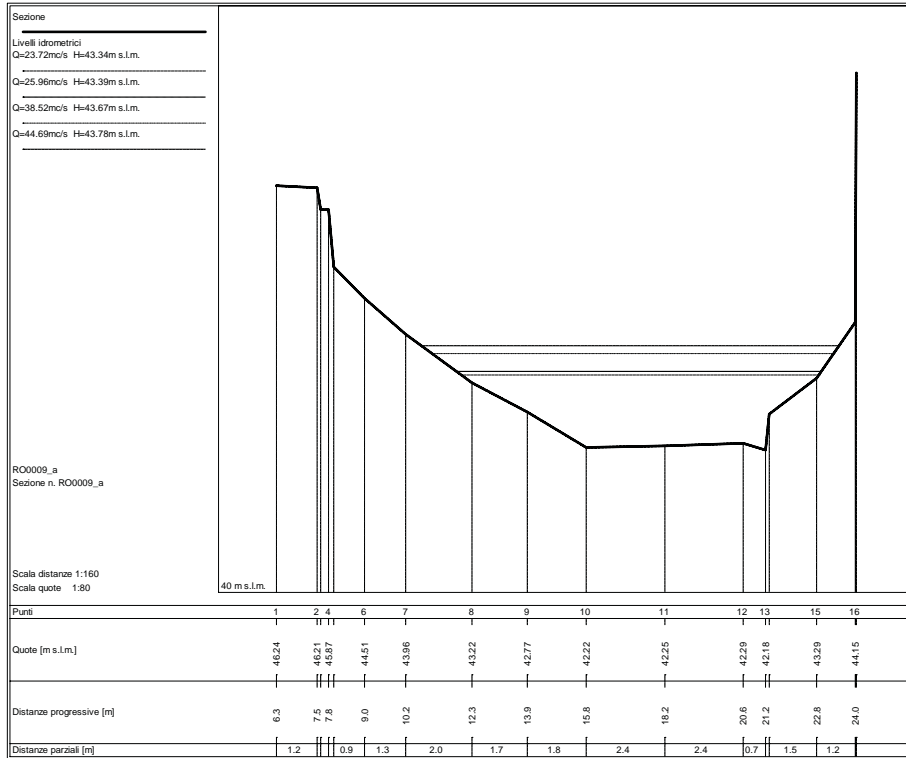

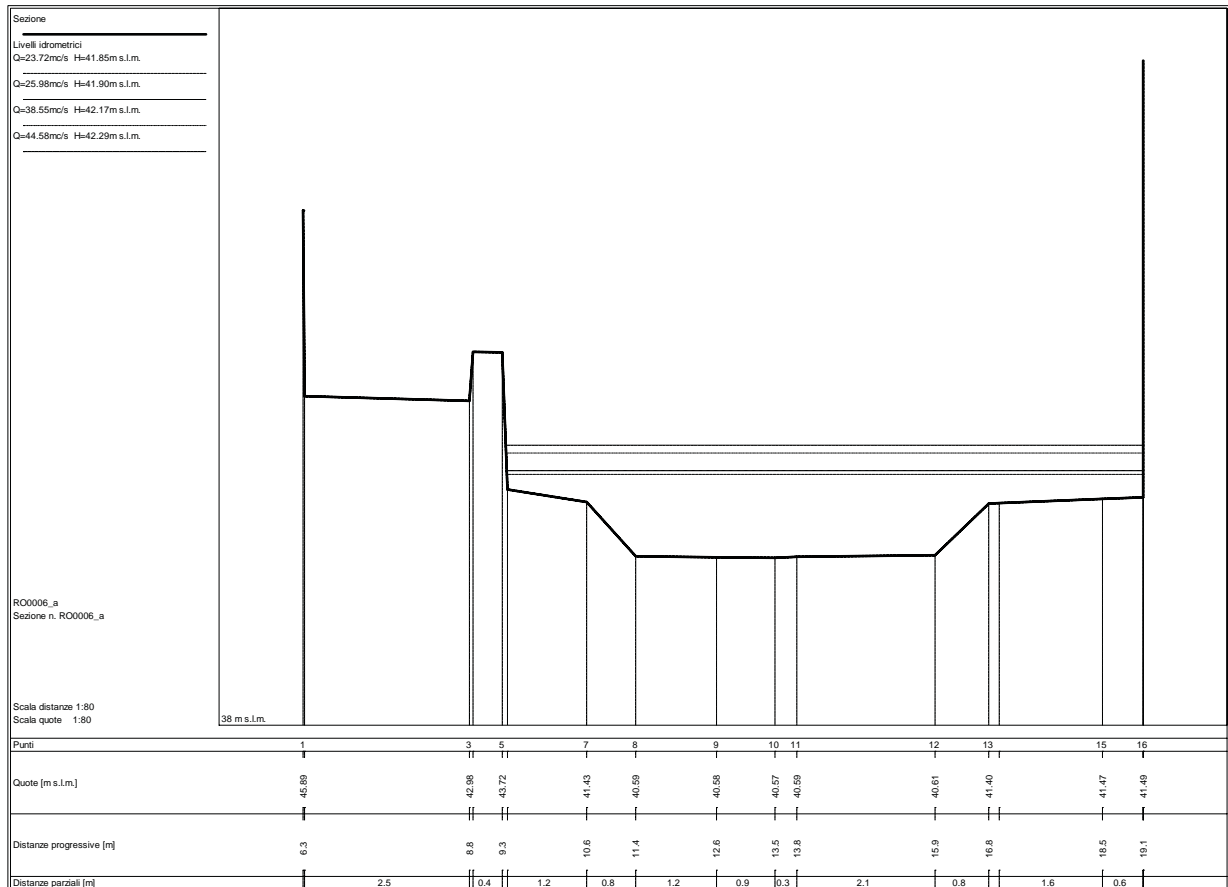
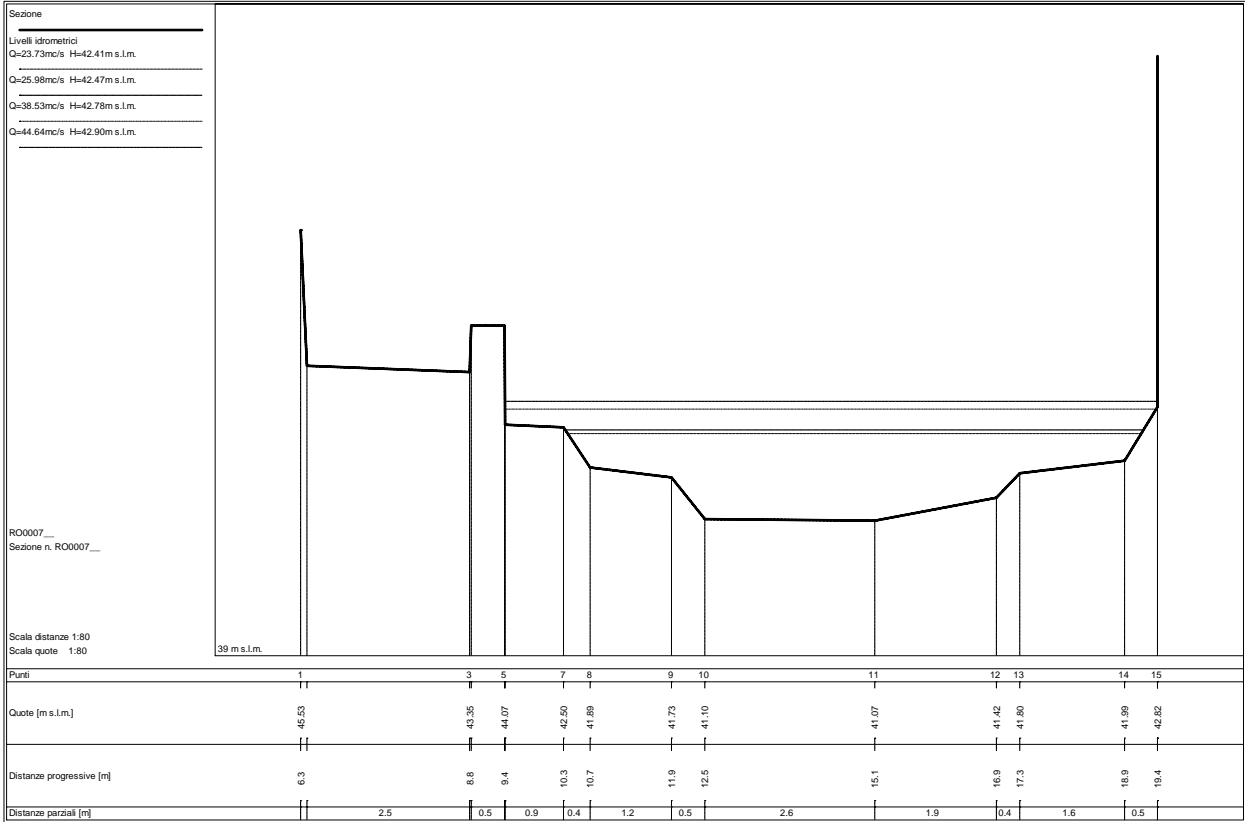

Sezione
 Livelli idrometrici
 Q=23.72m³/s H=40.21m s.l.m.
 Q=25.98m³/s H=40.33m s.l.m.
 Q=38.55m³/s H=41.11m s.l.m.
 Q=44.57m³/s H=41.42m s.l.m.

RO0005_a
 Sezione n. RO0005_a

Scala distanze 1:80
 Scala quote 1:80

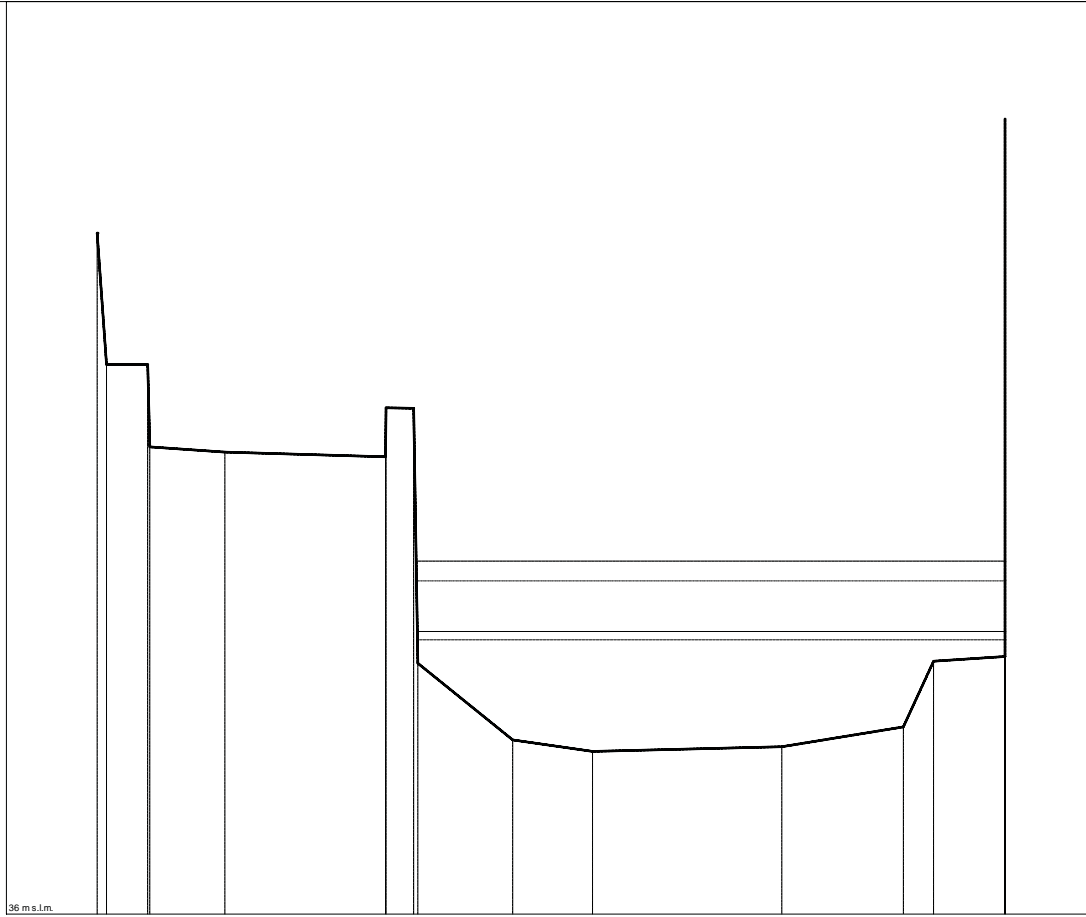

Punti	1	3	5	6	8	10	11	12	13	14	15
Quote [m s.l.m.]	46.44	44.43	43.09	43.02	43.76	38.67	38.50	38.57	38.87	39.88	39.95
Distanze progressive [m]	0.6	1.4	2.6	5.0	5.5	7.0	8.2	11.1	13.0	13.5	14.6
Distanze parziali [m]	0.6	1.1	2.5	0.4	1.5	1.2	2.9	1.9	0.5	1.1	

Sezione
 Livelli idrometrici
 Q=23.73m³/s H=40.20m s.l.m.
 Q=25.98m³/s H=40.35m s.l.m.
 Q=38.52m³/s H=41.11m s.l.m.
 Q=44.56m³/s H=41.42m s.l.m.

RO0005_b
 Sezione n. RO0005_b

Scala distanze 1:80
 Scala quote 1:80

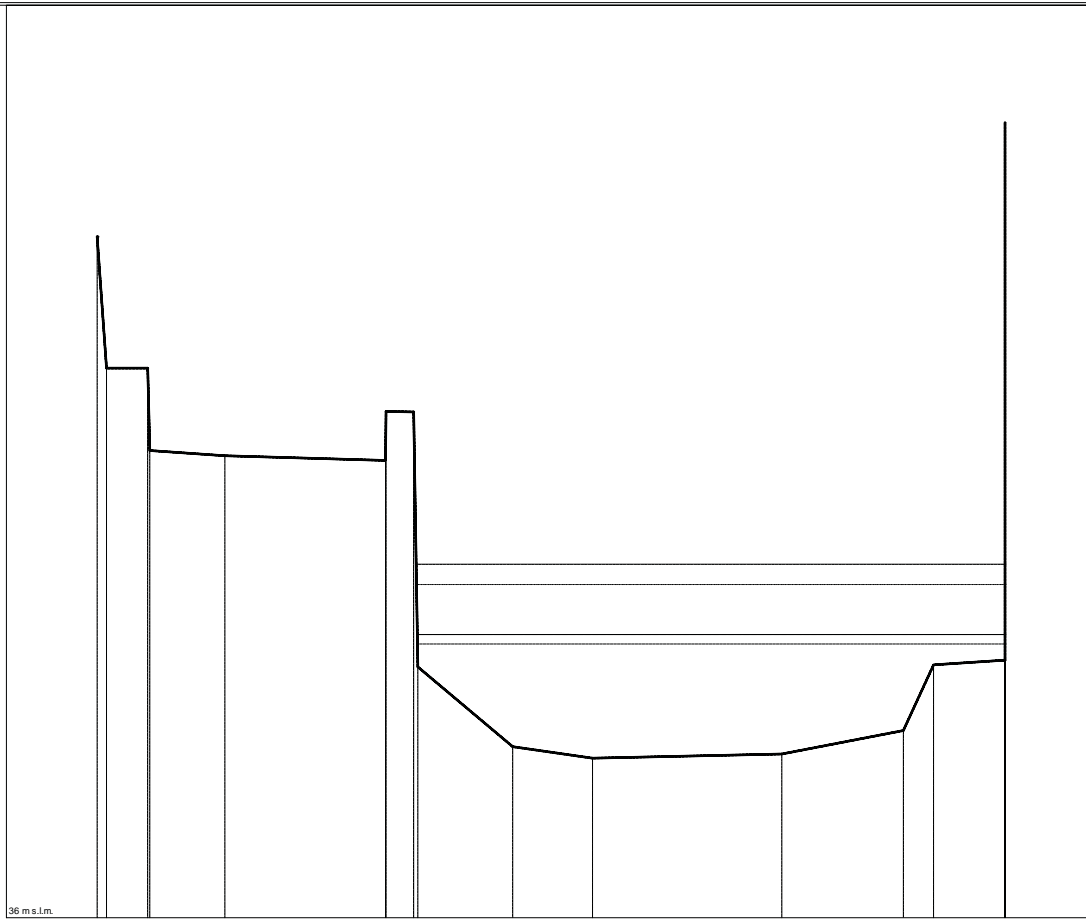

Punti	1	3	5	6	8	10	11	12	13	14	15
Quote [m s.l.m.]	46.44	44.43	43.09	43.02	43.76	38.62	38.45	38.51	38.87	39.88	39.95
Distanze progressive [m]	6.3	7.0	8.2	10.7	11.1	12.6	13.8	16.8	18.6	19.1	20.2
Distanze parziali [m]	0.6	1.1	2.5	0.4	1.5	1.2	2.9	1.9	0.5	1.1	

Sezione
 Livelli idrometrici
 Q=23.72mc/s H=40.21m s.l.m.
 Q=25.97mc/s H=40.34m s.l.m.
 Q=38.47mc/s H=41.03m s.l.m.
 Q=44.59mc/s H=41.37m s.l.m.

RO0004_
 Sezione n. RO0004_

Scala distanze 1:80
 Scala quote 1:80

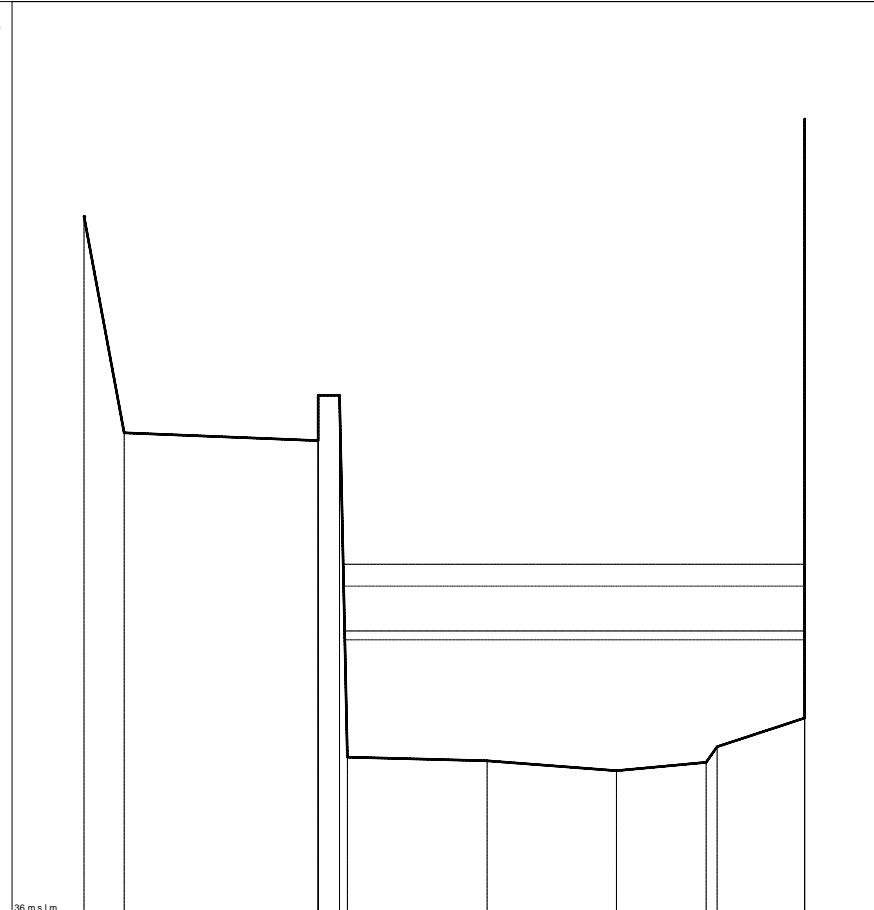

Punti	1	2	3	5	7	8	9	11
Quote [m s.l.m.]	46.71	43.38	43.26	43.96	38.35	38.20	38.33	39.01
Distanze progressive [m]	6.3	6.9	9.8	10.2	12.4	14.4	15.8	17.3
Distanze parziali [m]	0.6	3.0	0.3	2.1	2.0	1.4	1.3	

Sezione
 Livelli idrometrici
 Q=23.70mc/s H=40.08m s.l.m.
 Q=25.97mc/s H=40.21m s.l.m.
 Q=38.48mc/s H=41.02m s.l.m.
 Q=44.60mc/s H=41.35m s.l.m.

RO0003_a
 Sezione n. RO0003_a

Scala distanze 1:80
 Scala quote 1:80

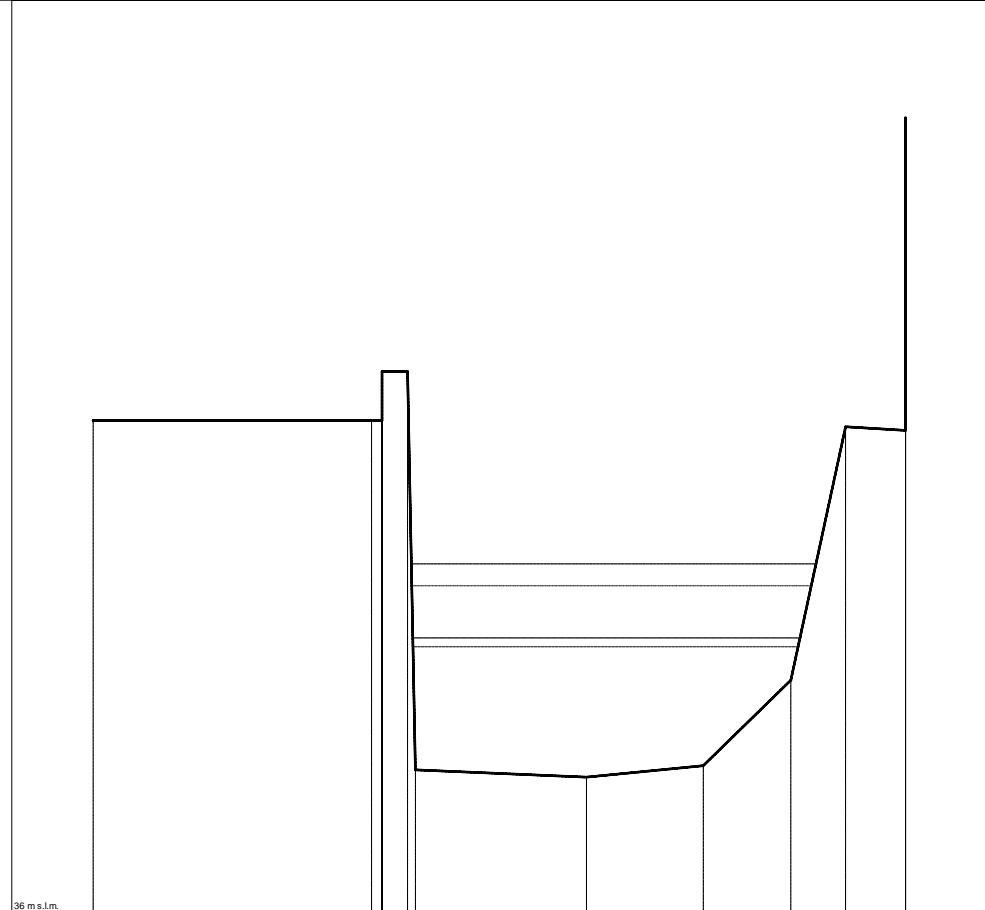

Punti	1	2	5	7	8	9	10	11
Quote [m s.l.m.]	43.55	43.55	44.31	38.08	38.25	39.57	43.46	43.40
Distanze progressive [m]	6.3	10.5	11.1	13.8	15.6	17.0	17.8	18.7
Distanze parziali [m]		4.3	0.4	2.6	1.8	1.3	0.8	0.9

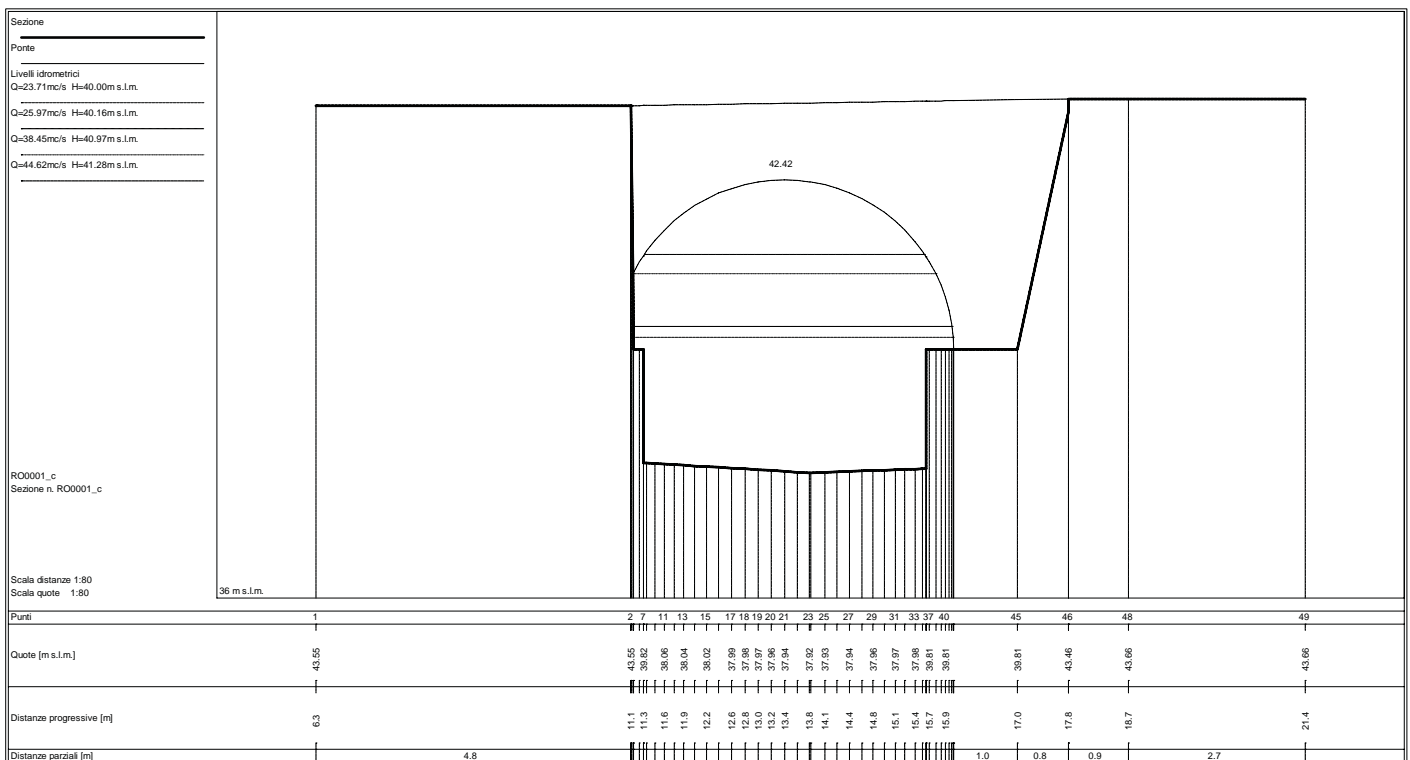
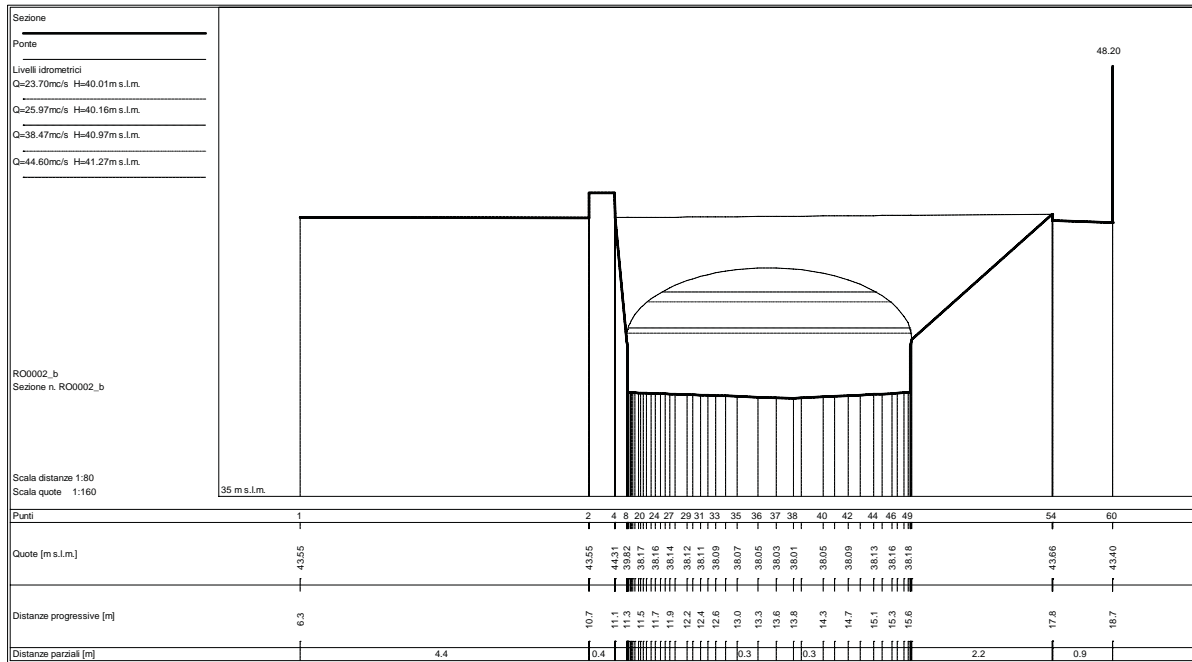

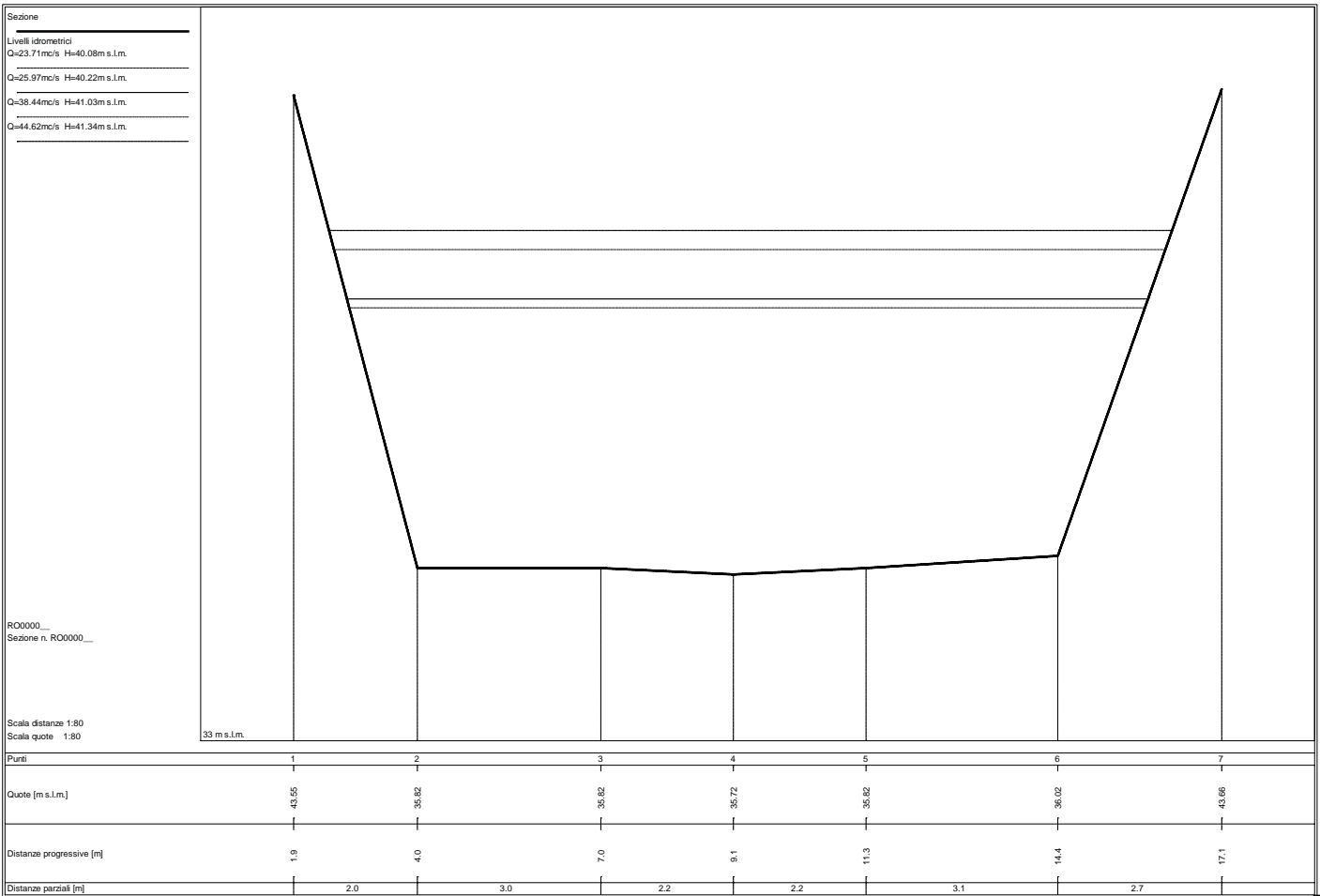
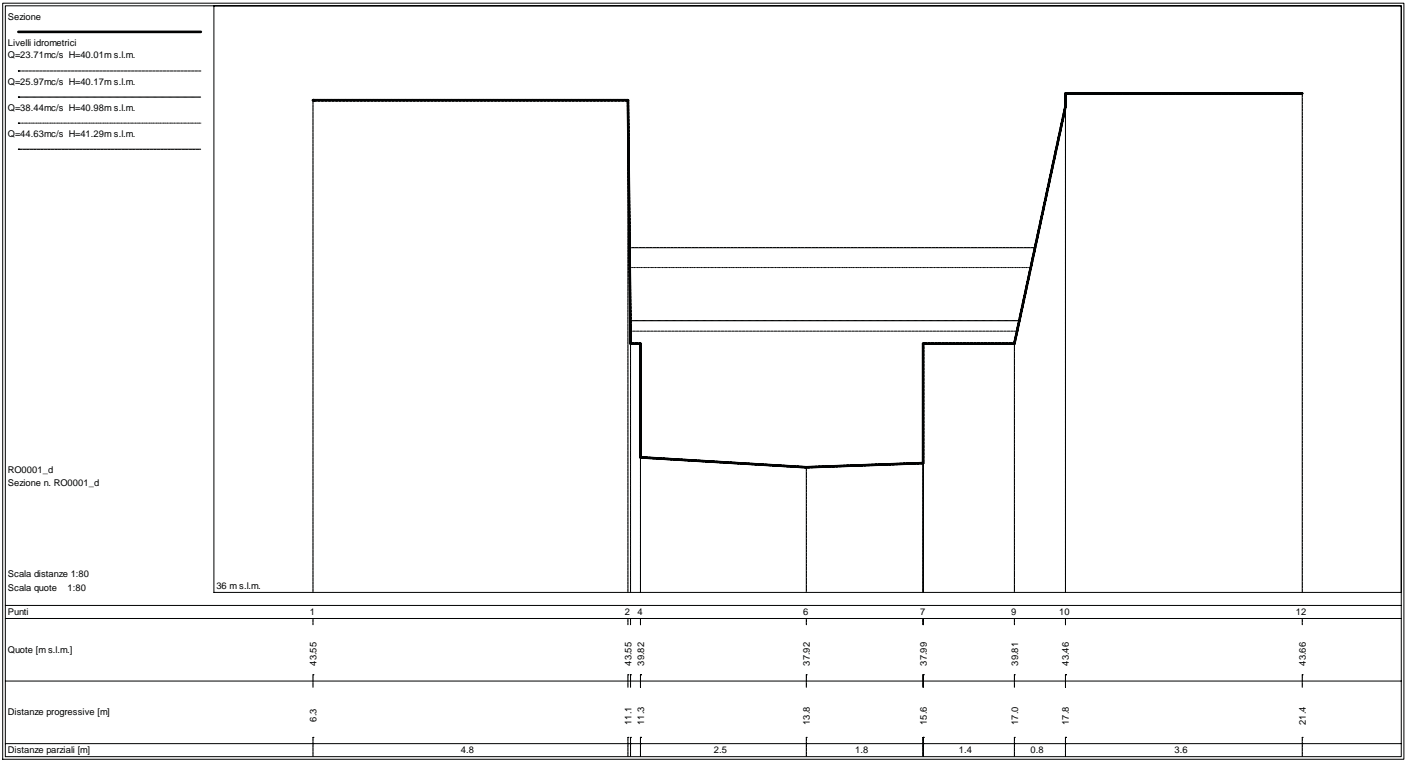

STATO ATTUALE

Sezioni fluviali fosso Magliano – MG_2

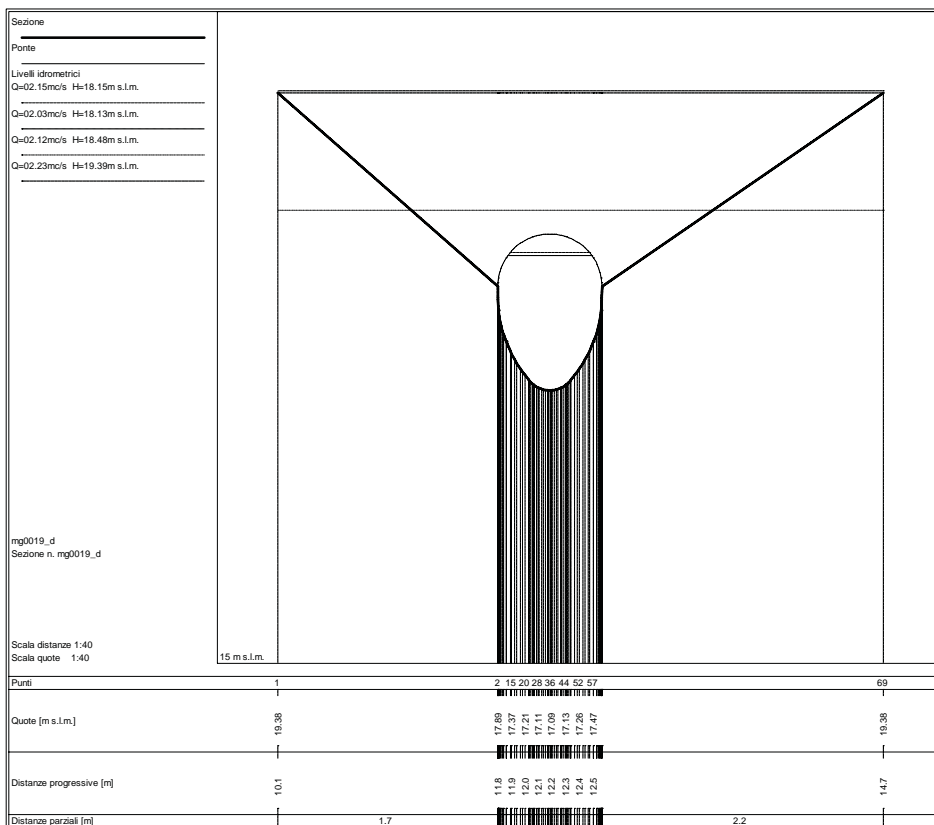
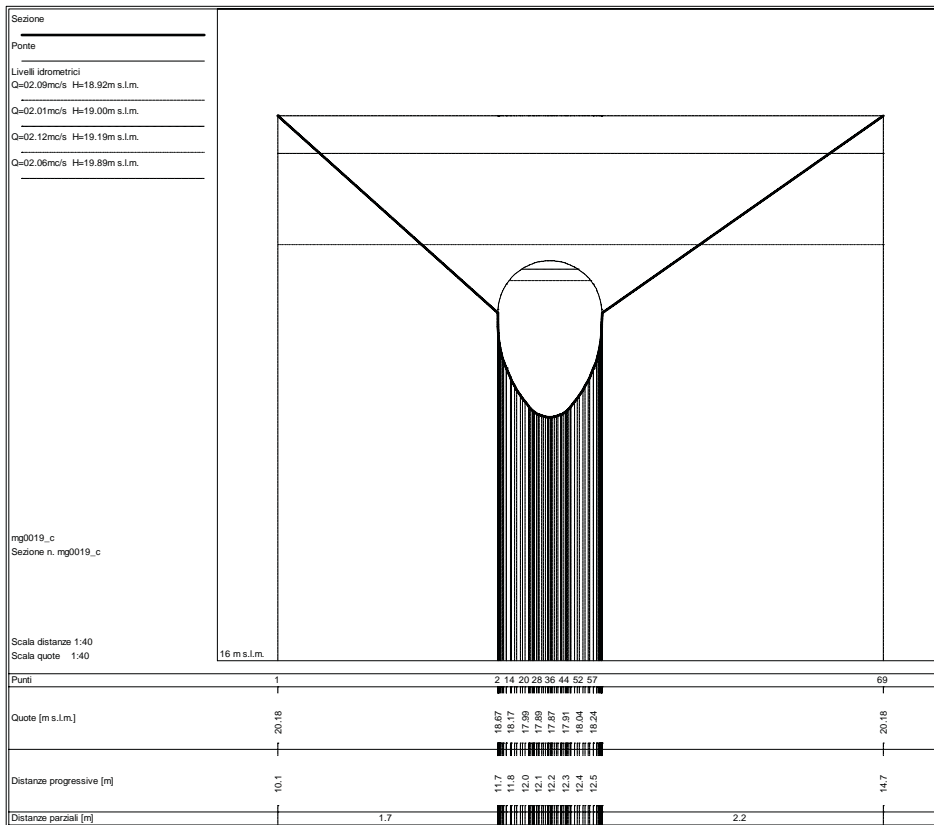

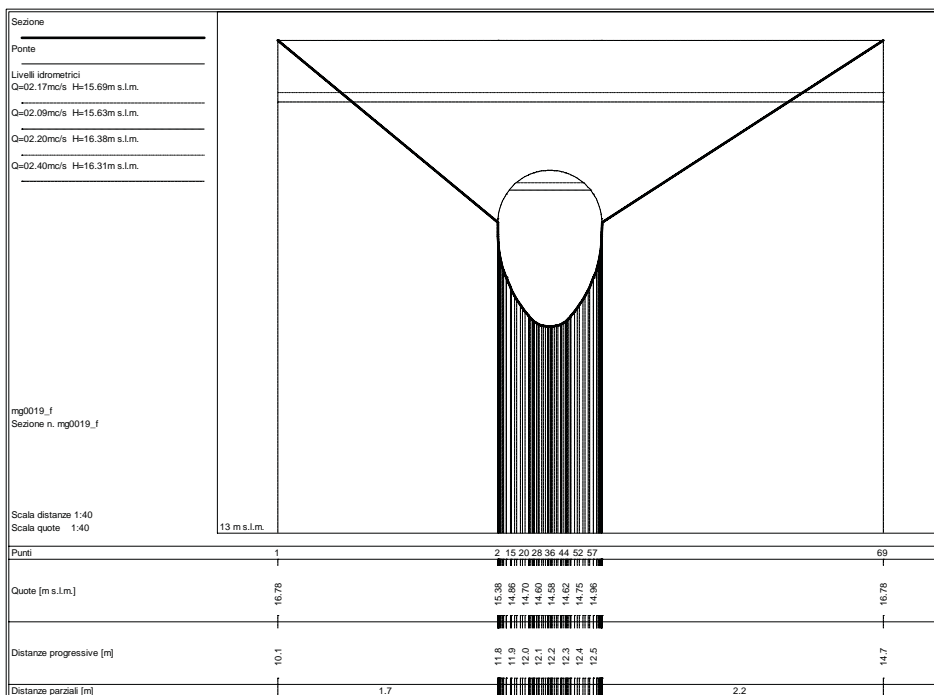
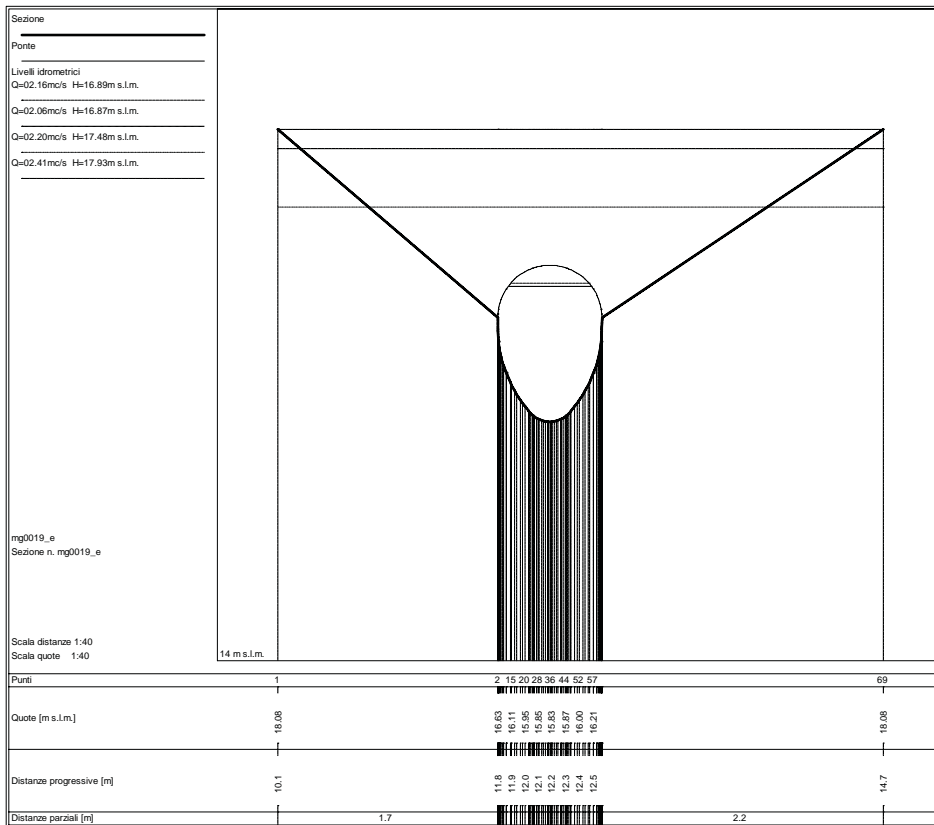

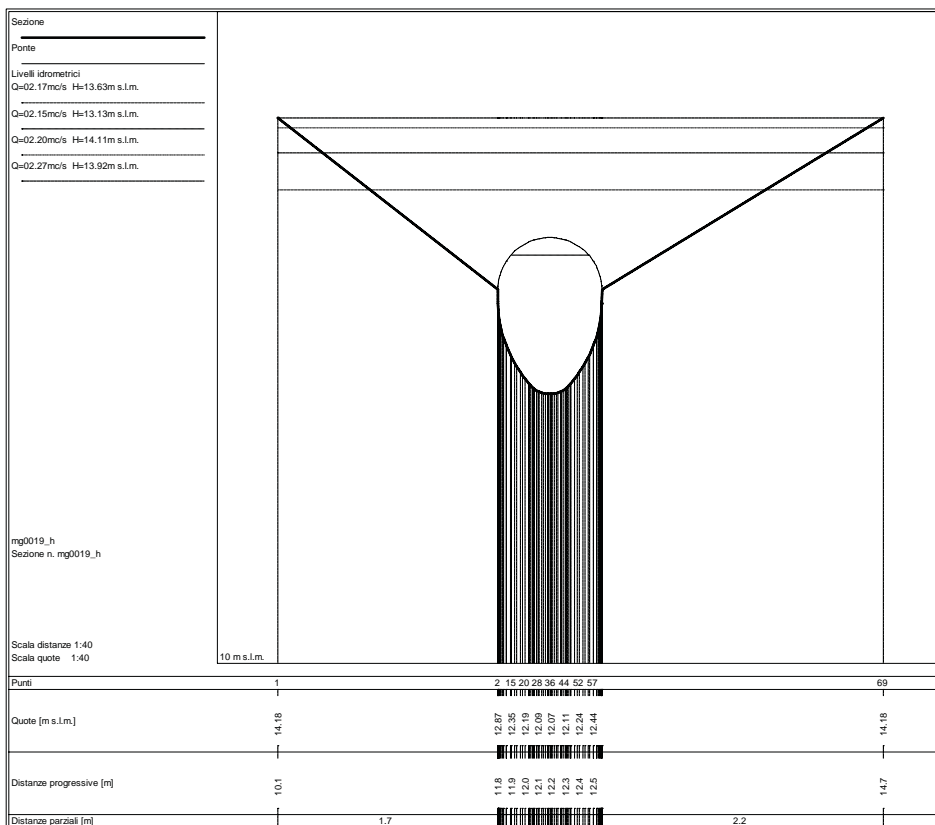
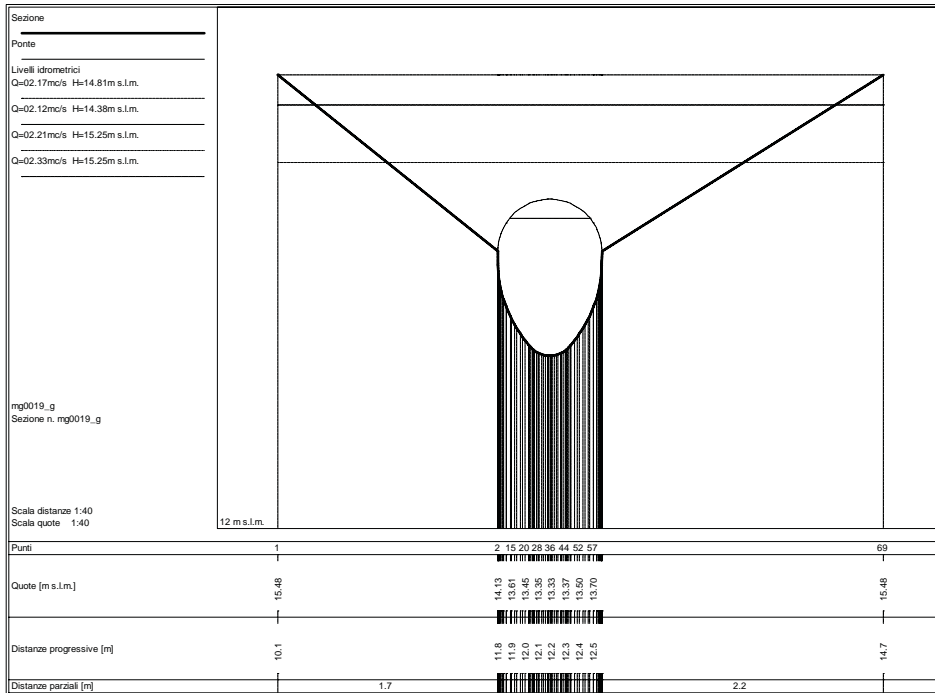

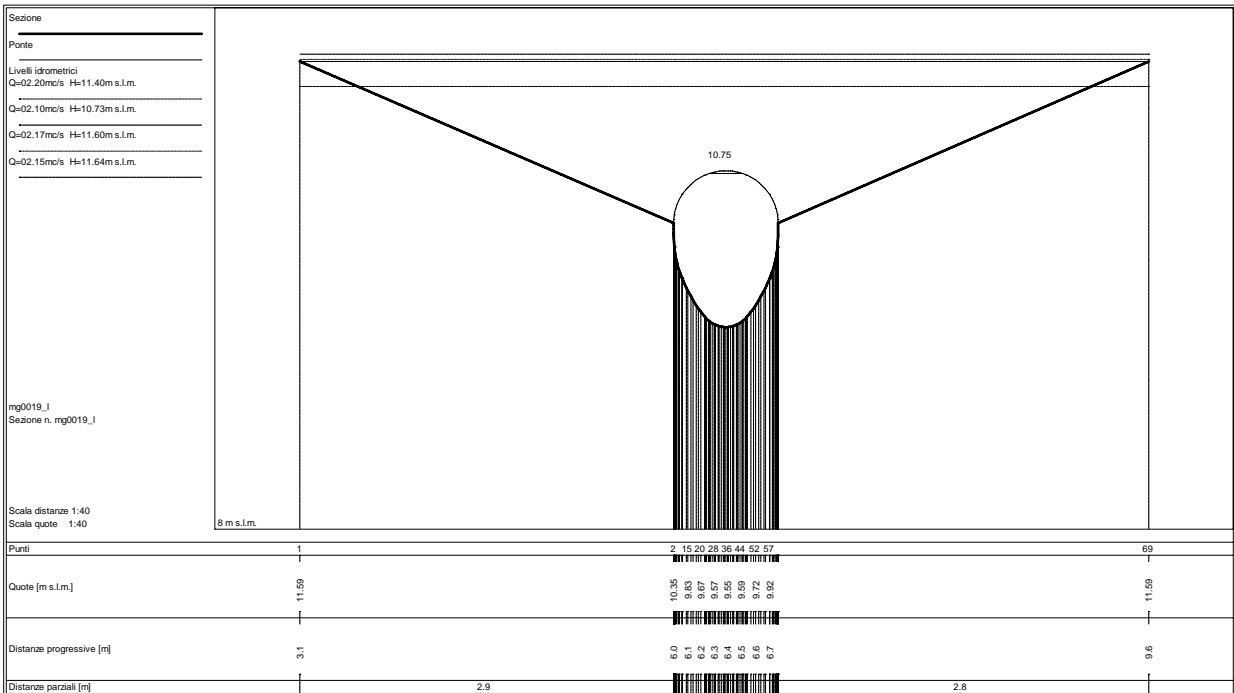
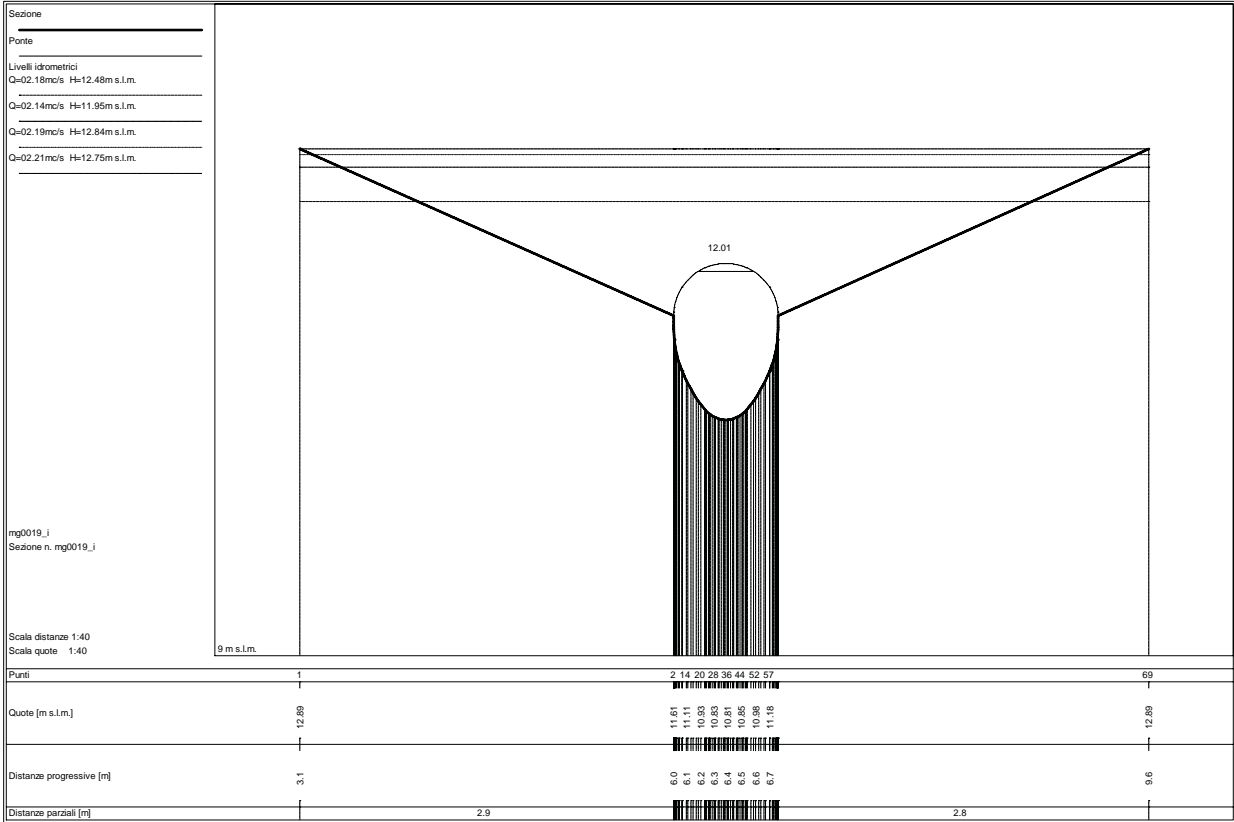

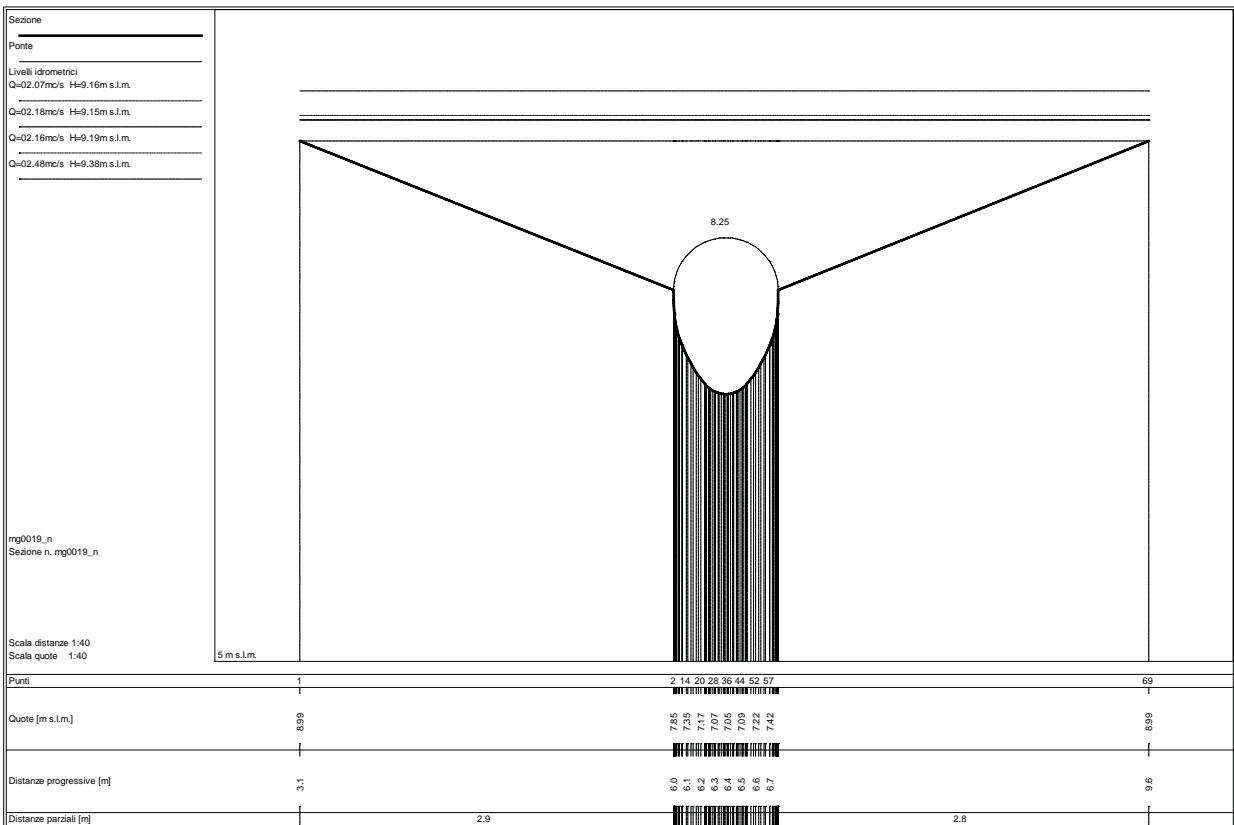
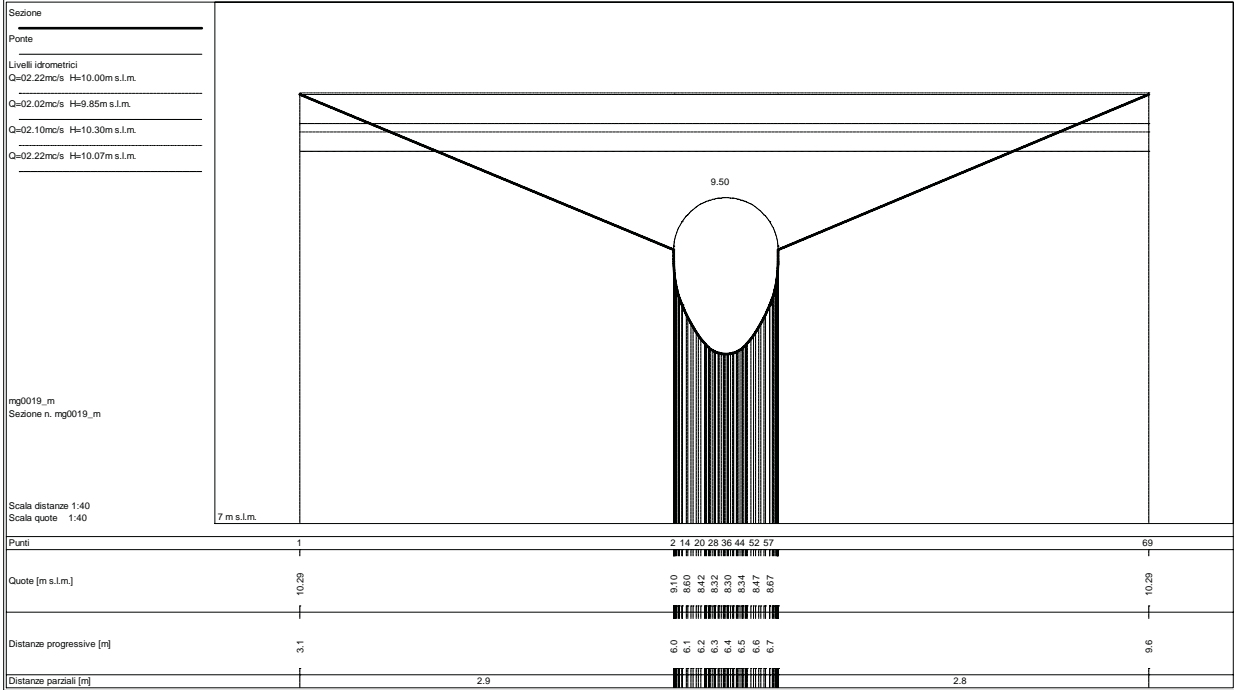

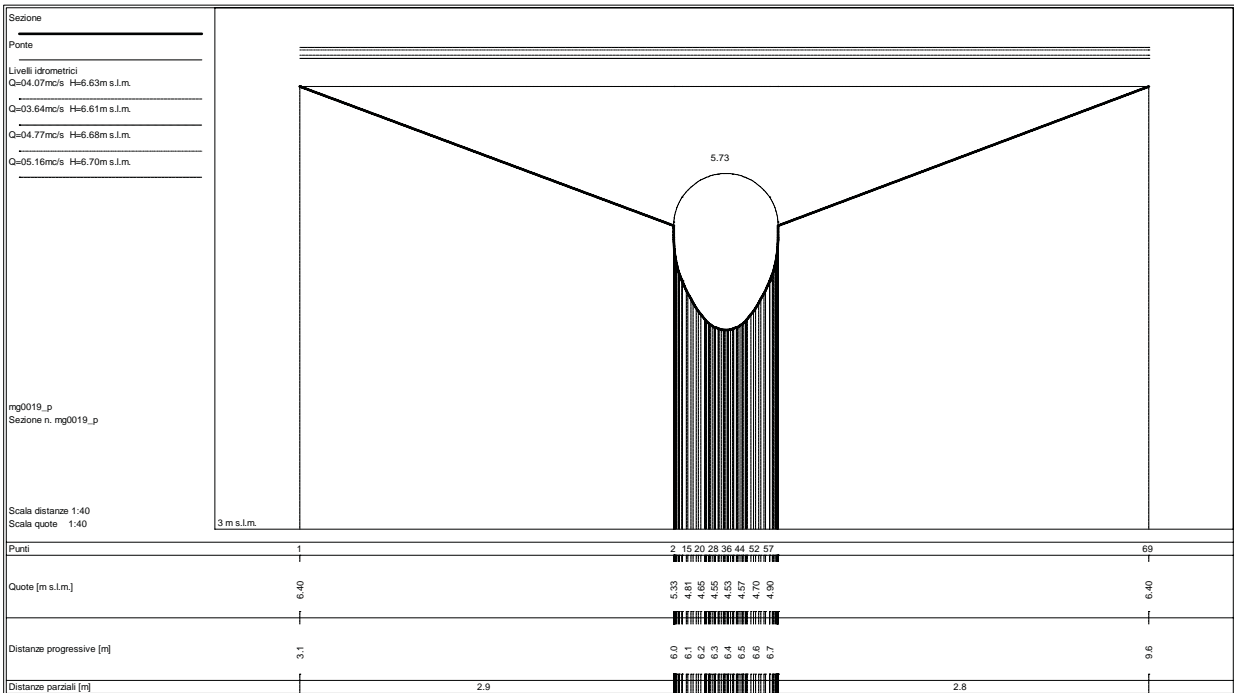
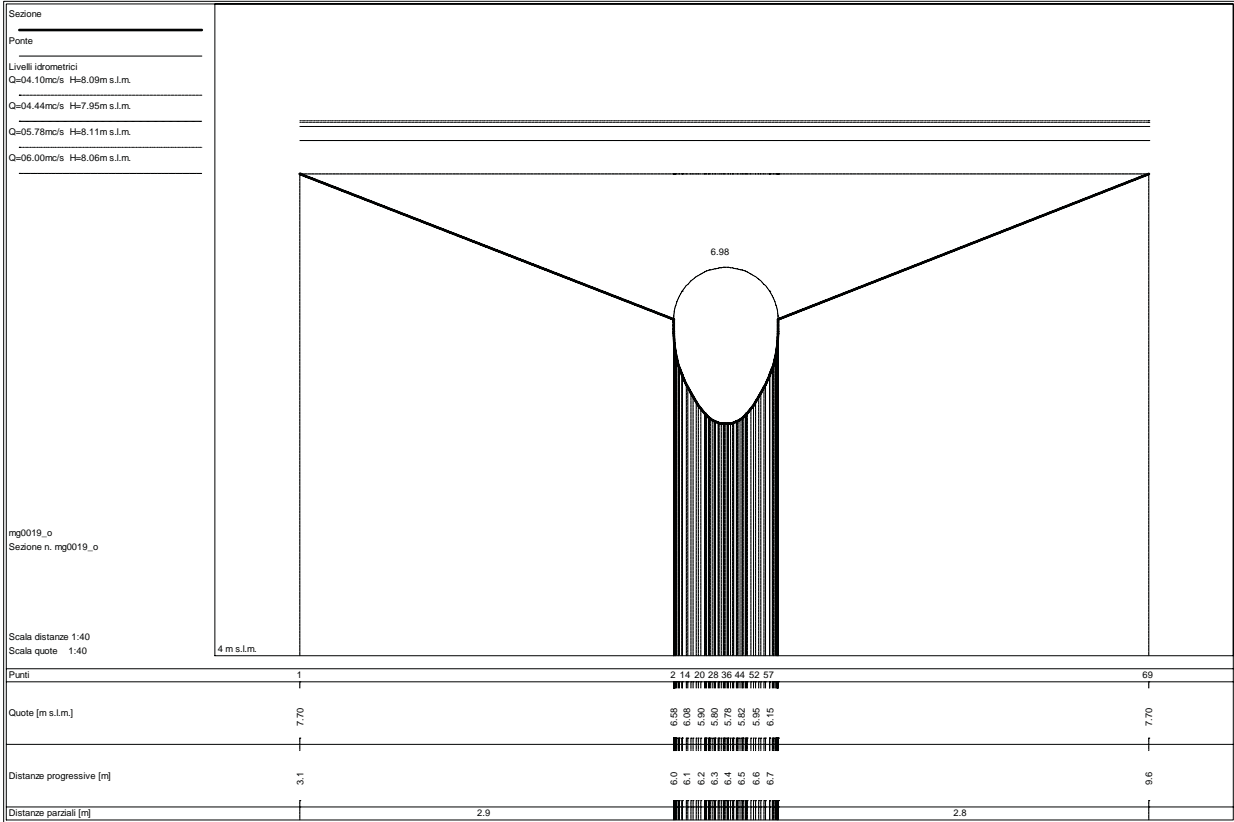

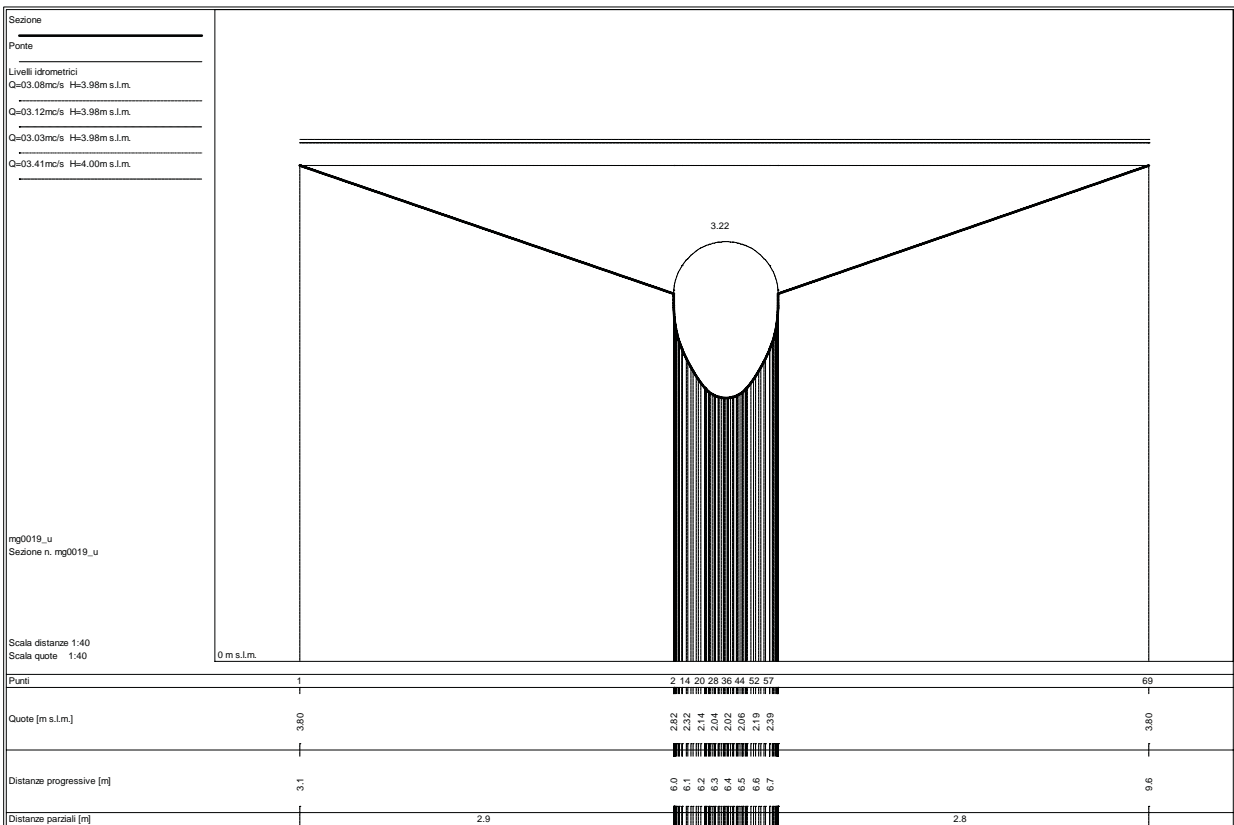
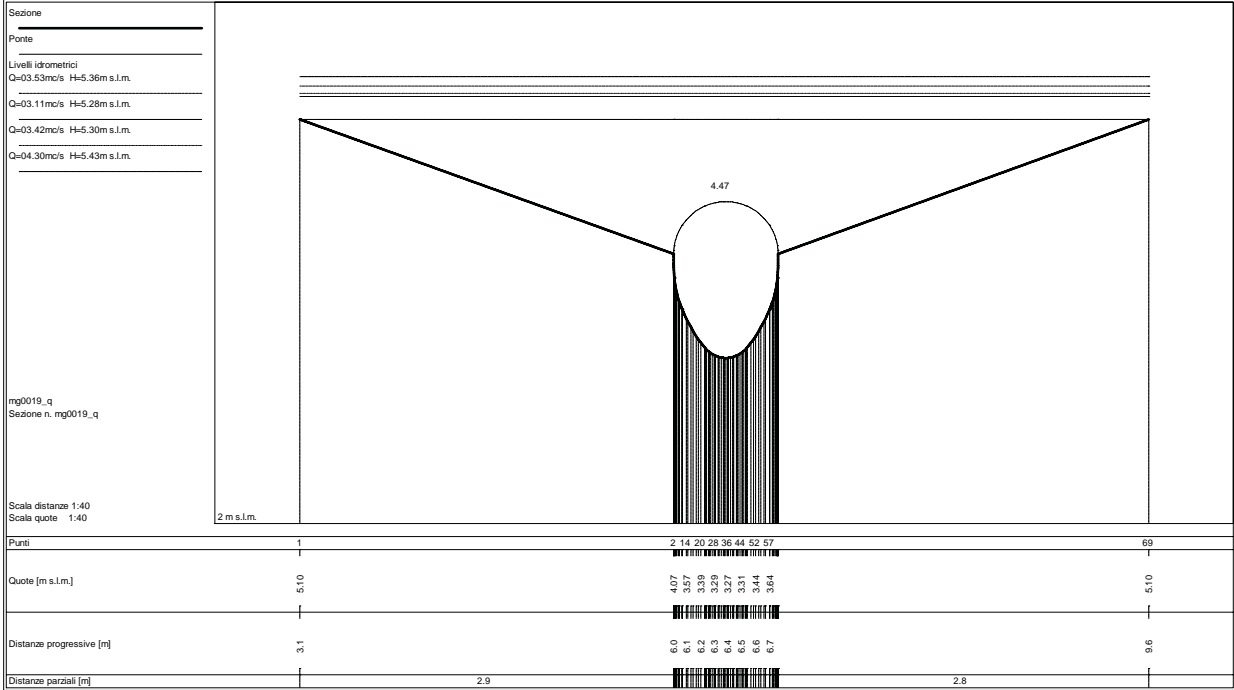

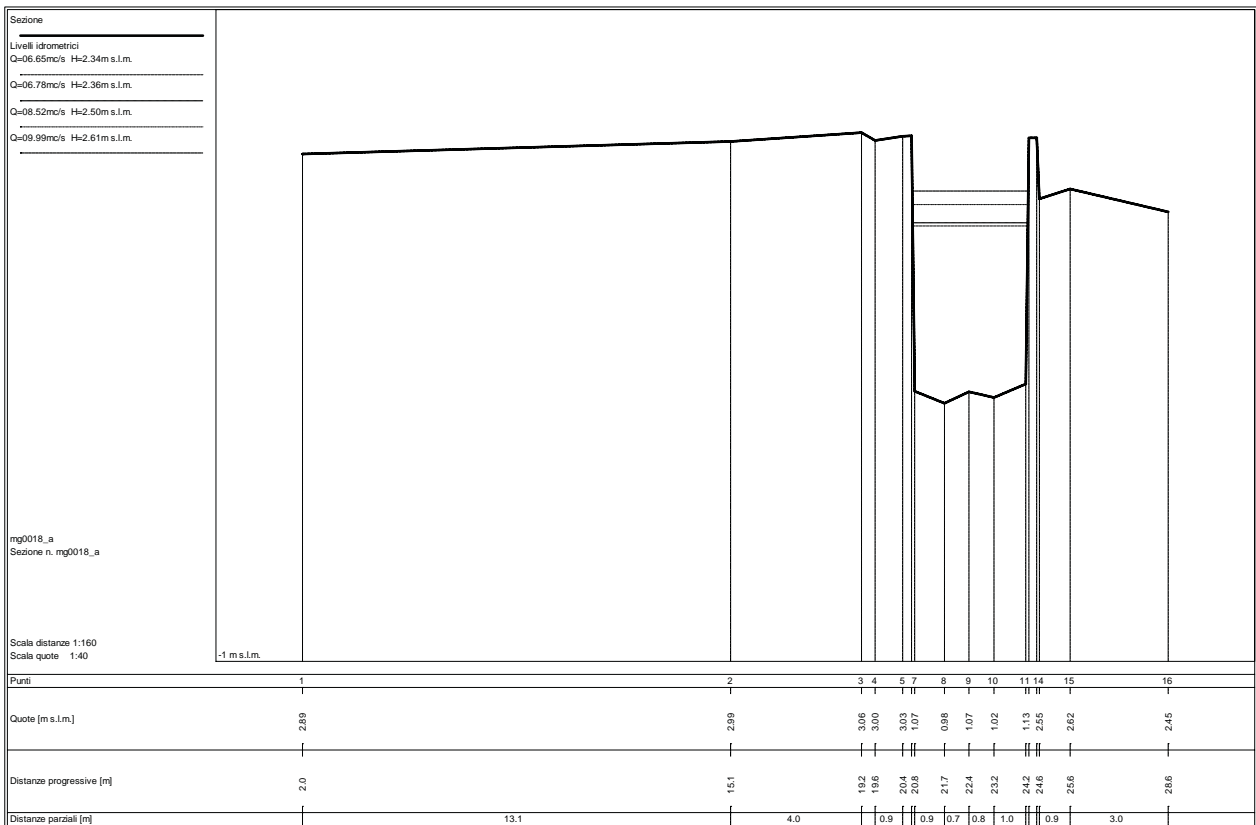
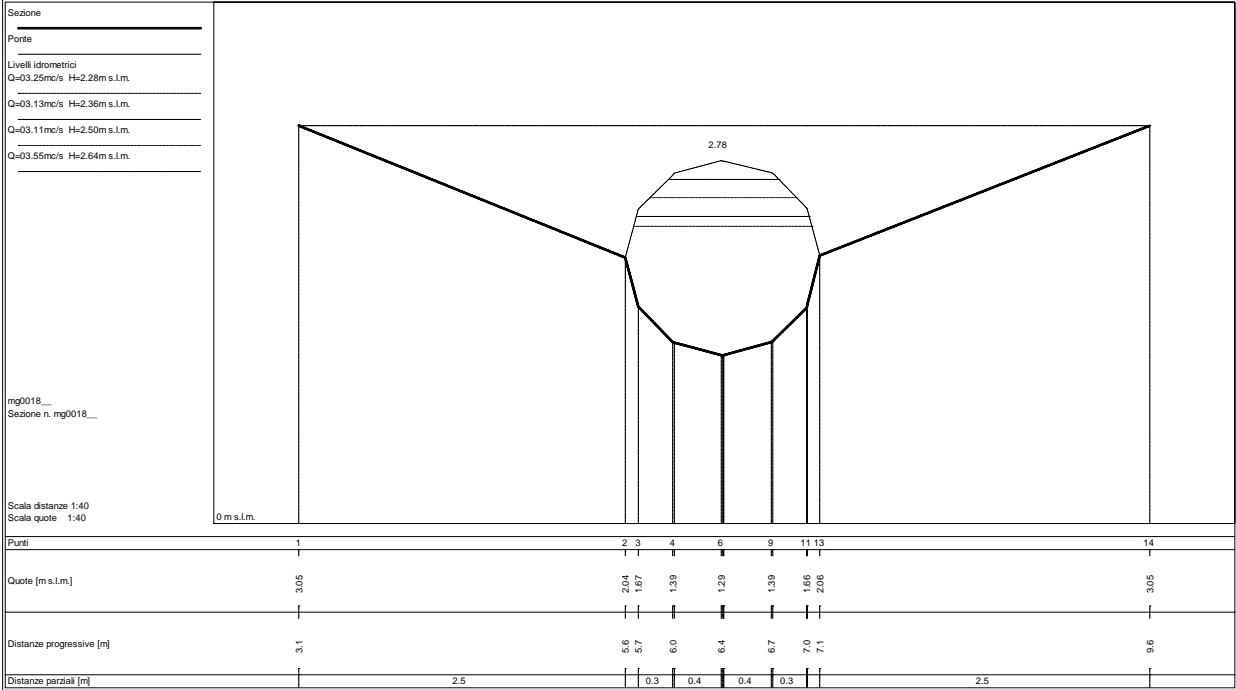

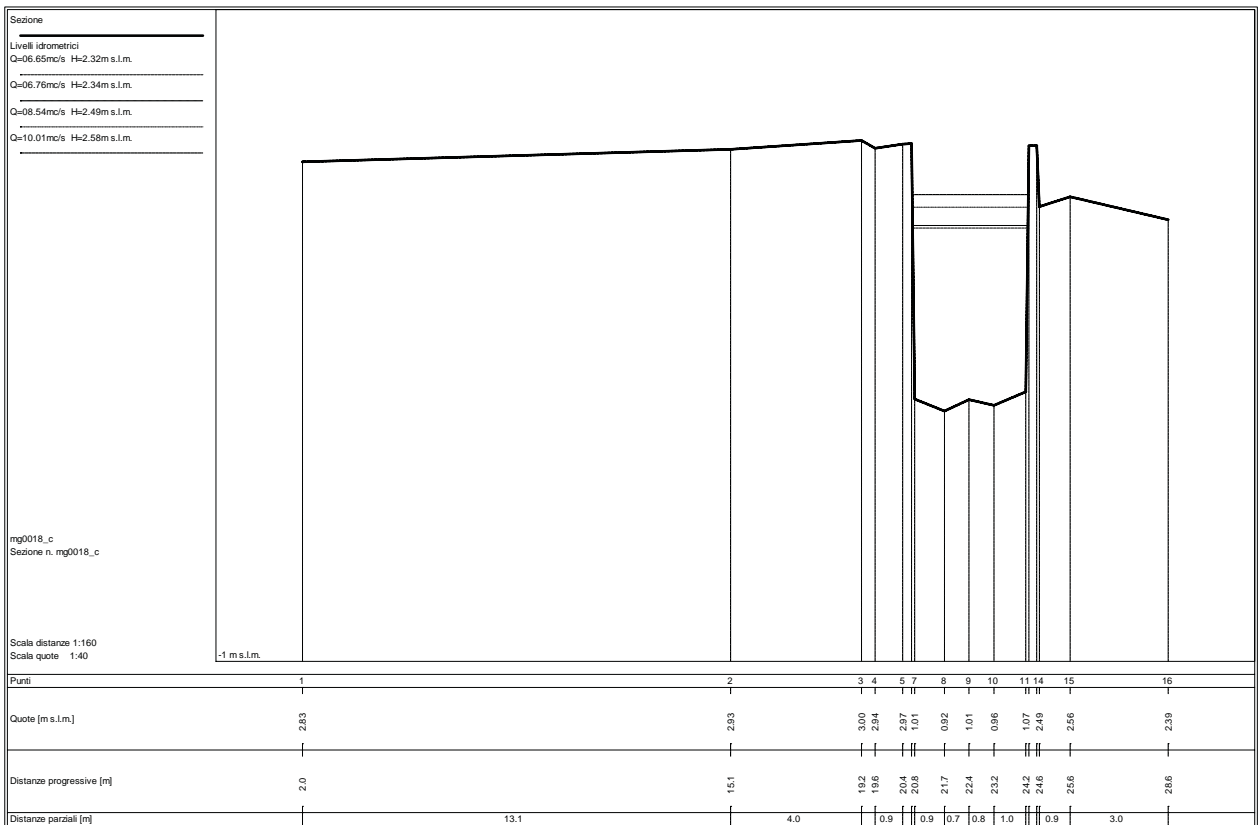
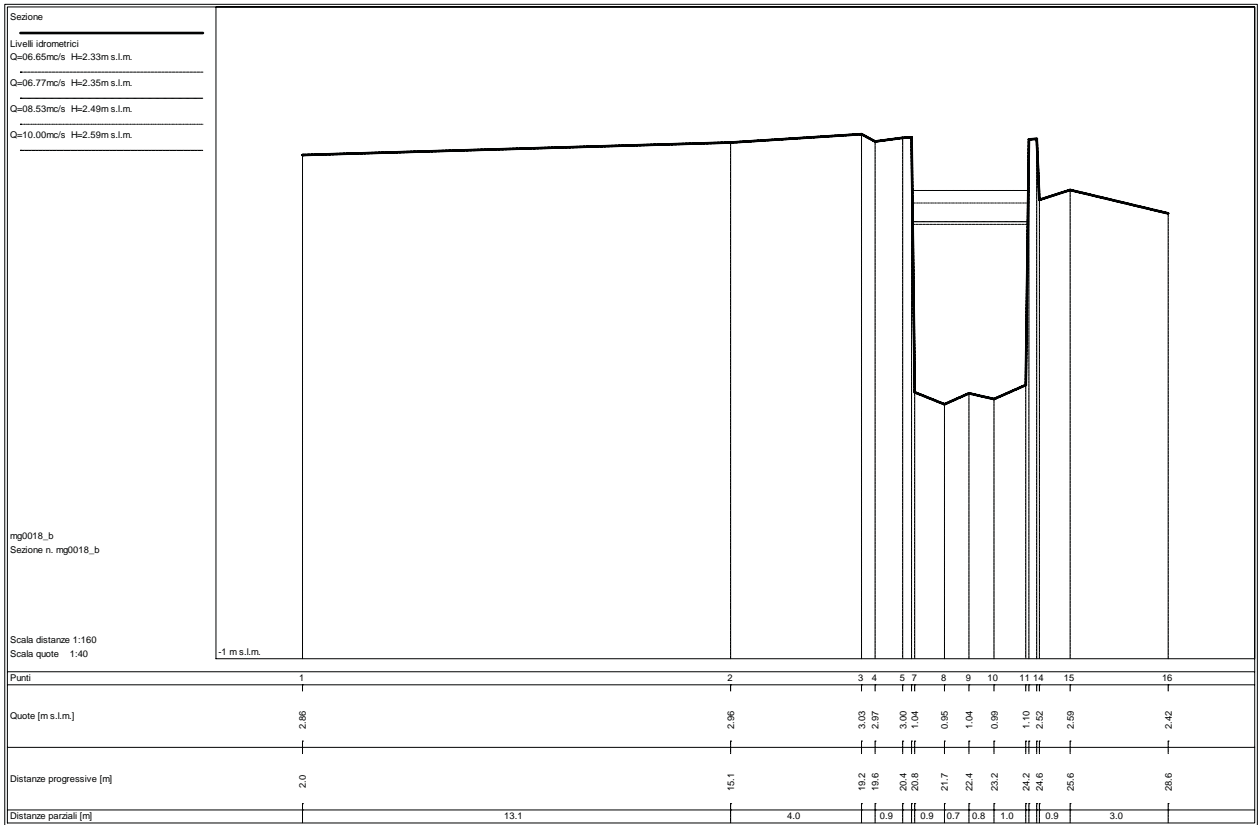

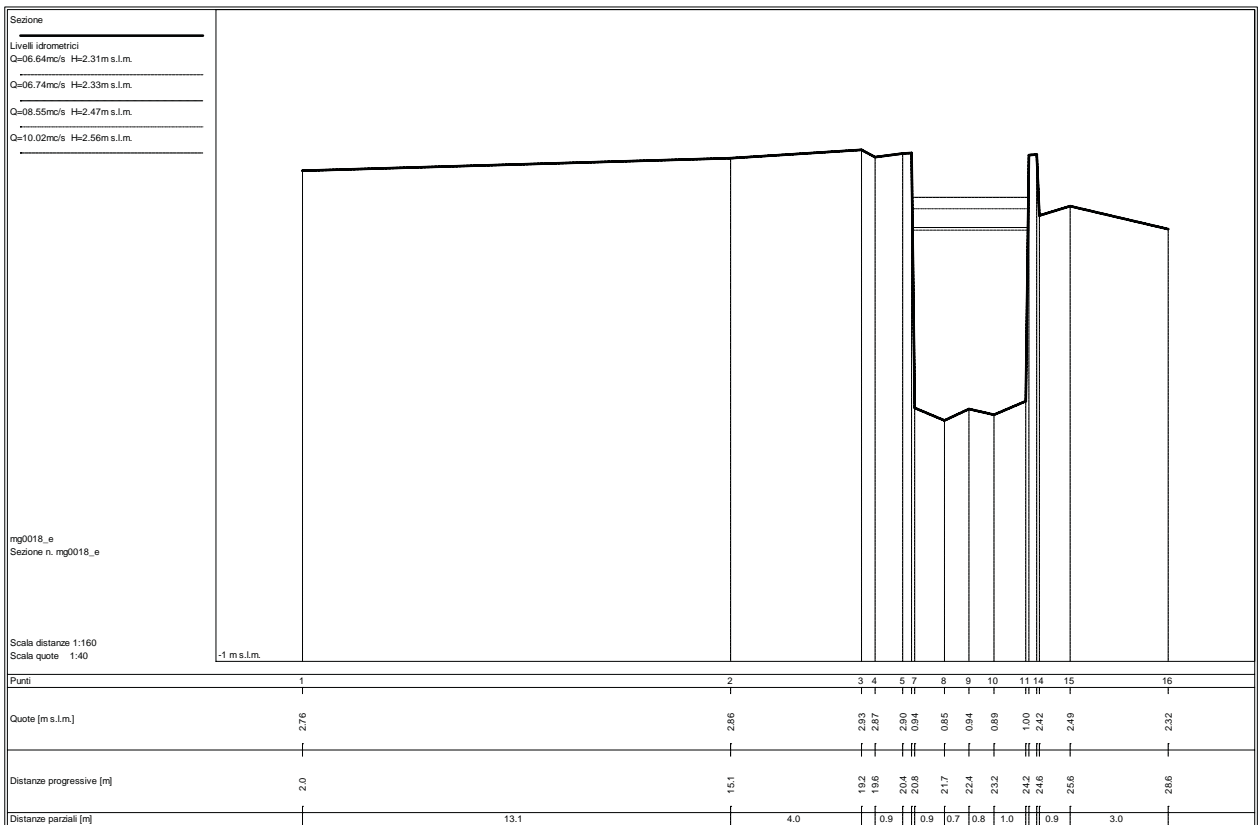
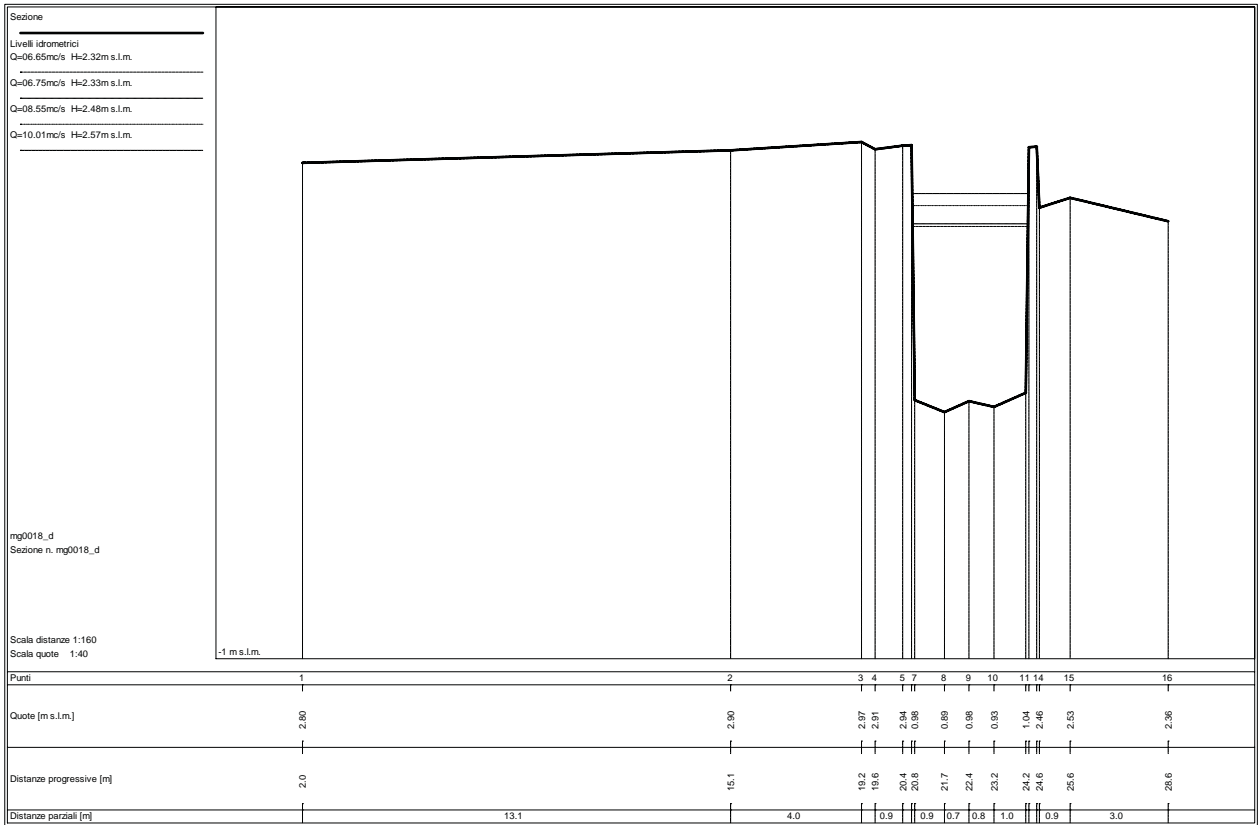

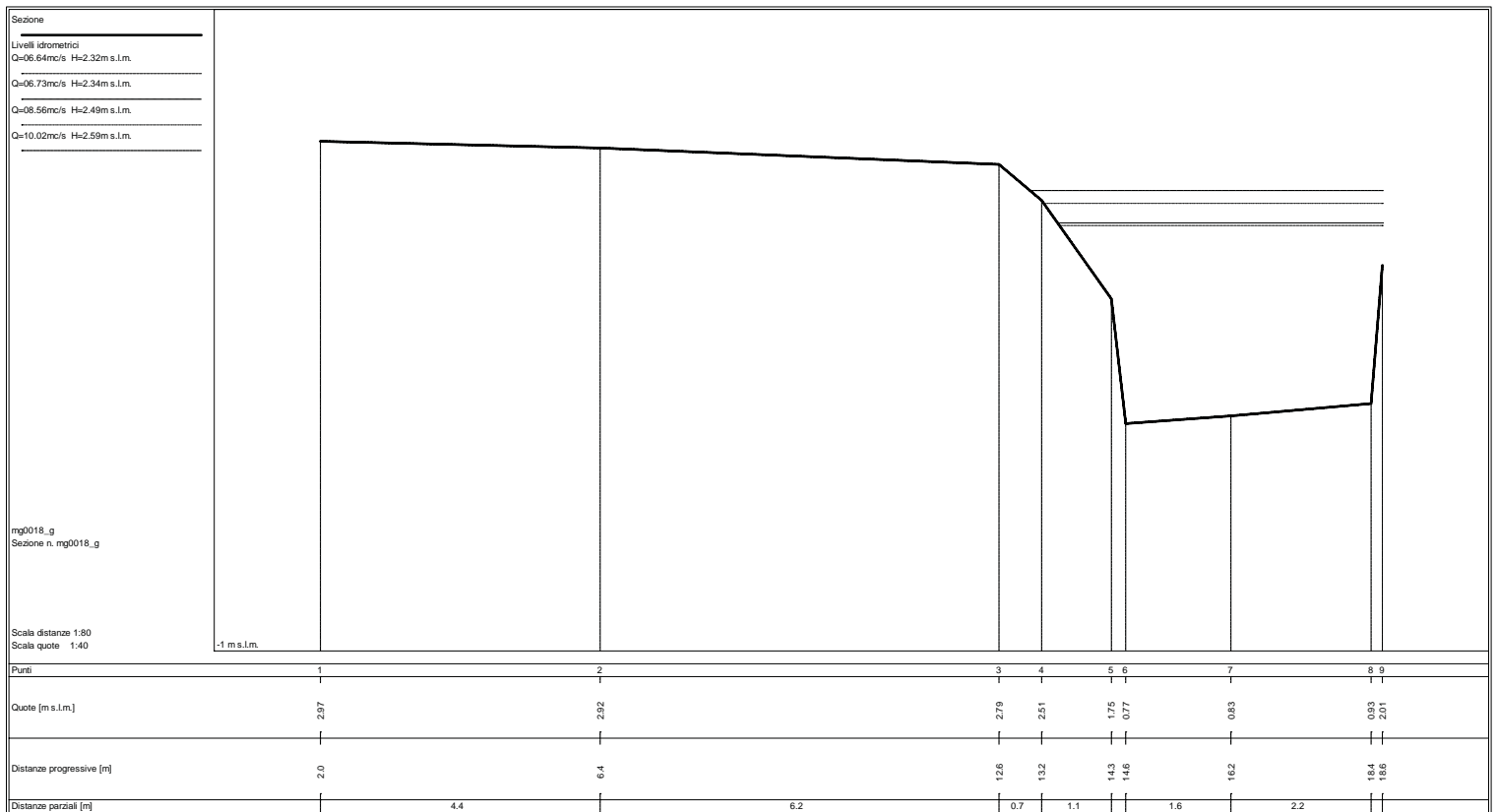
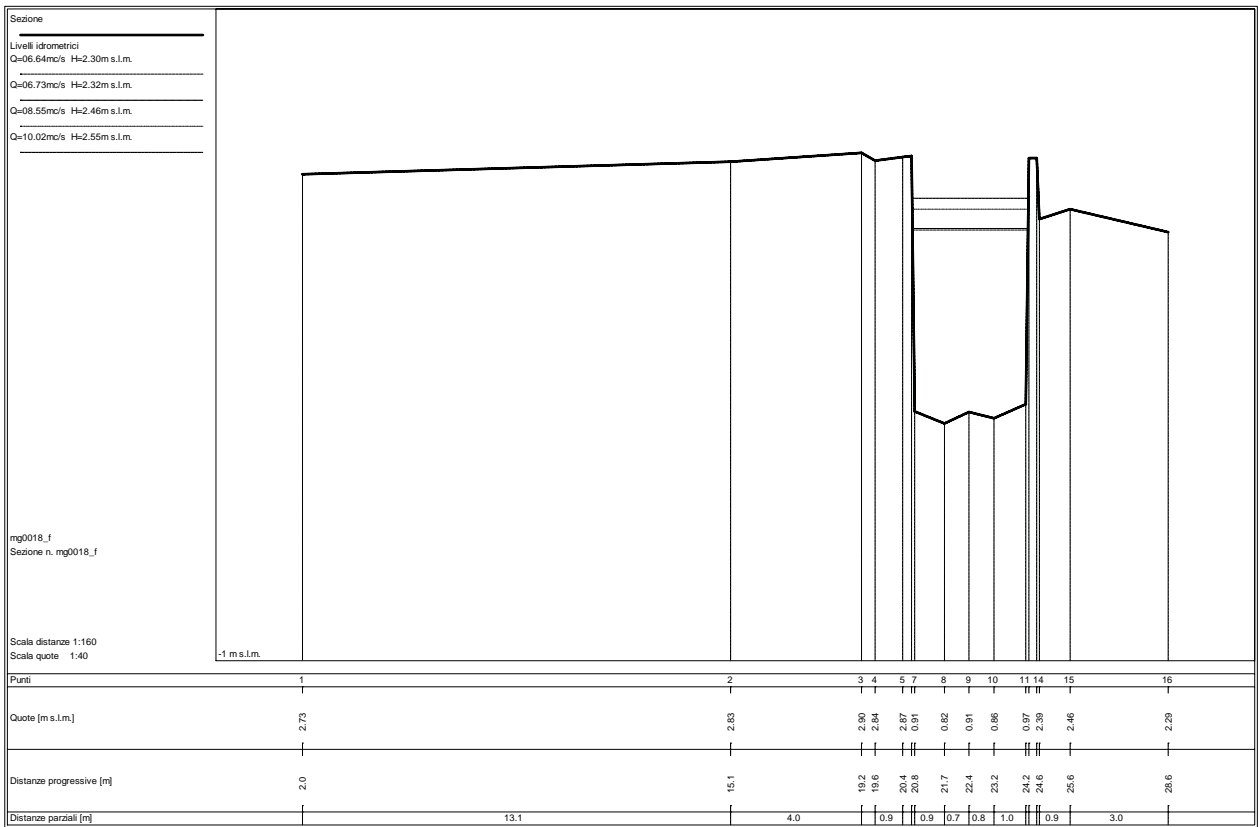

STATO ATTUALE

Sezioni fluviali fosso Magliano – MG_3

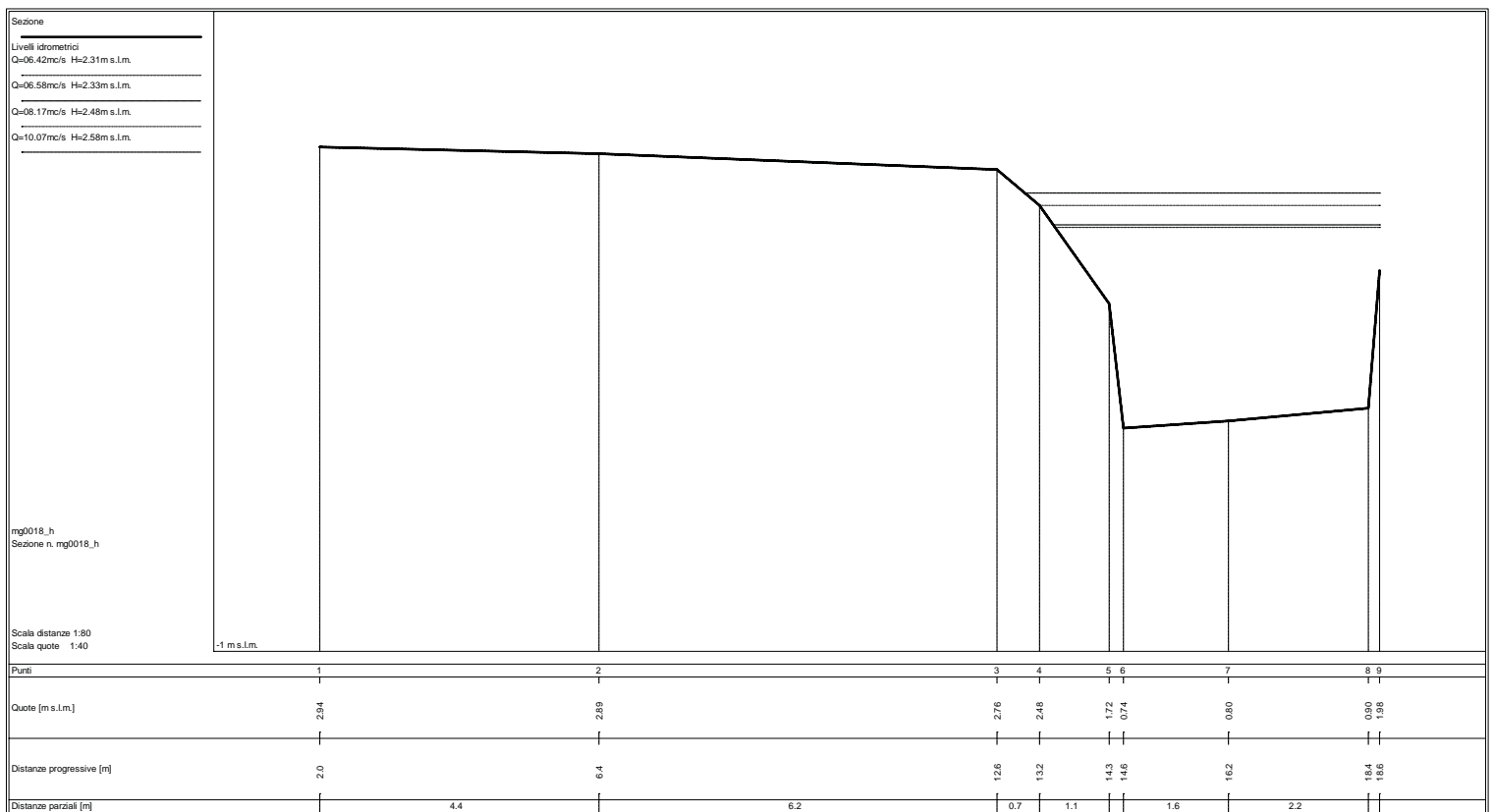
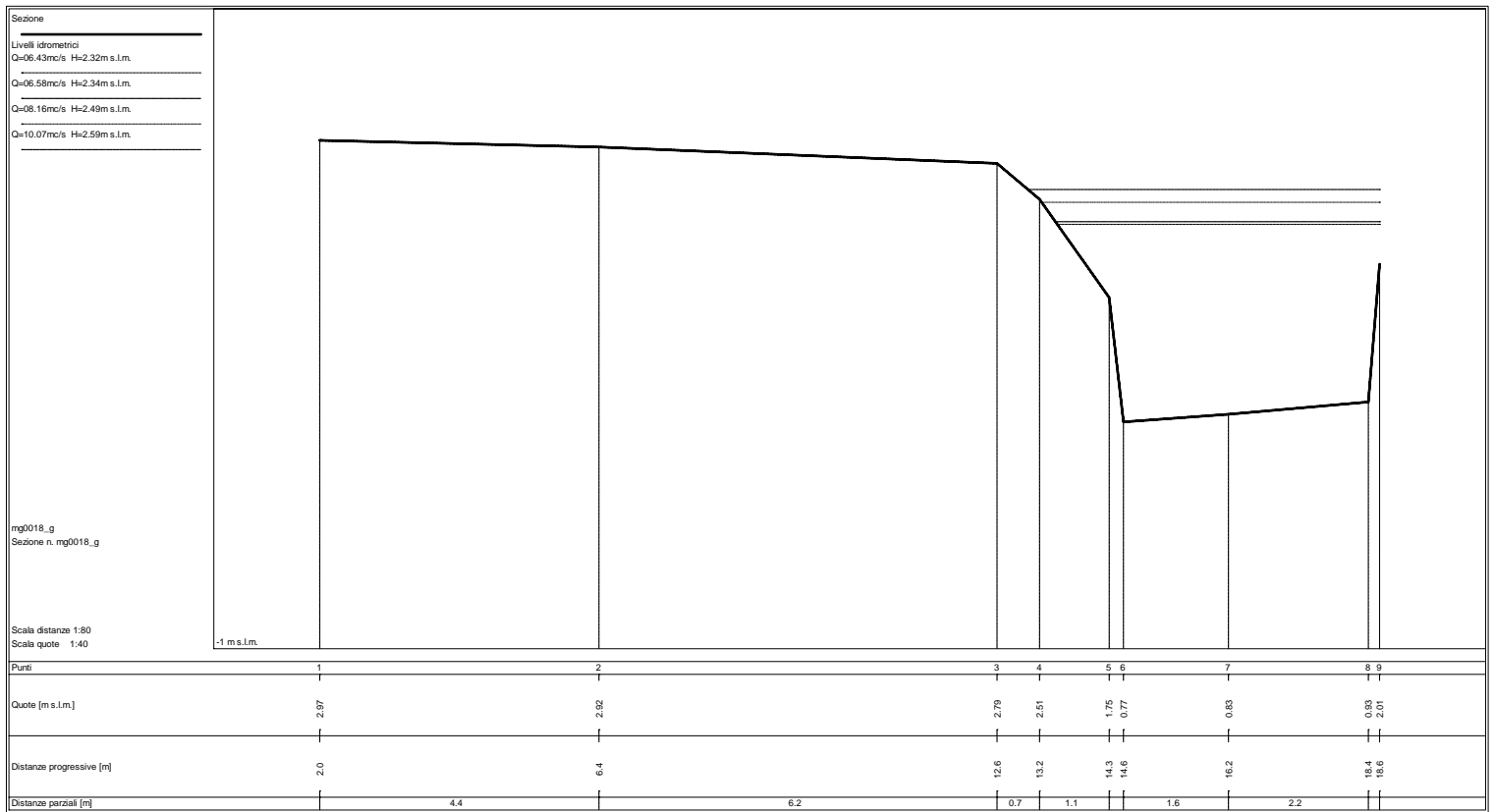

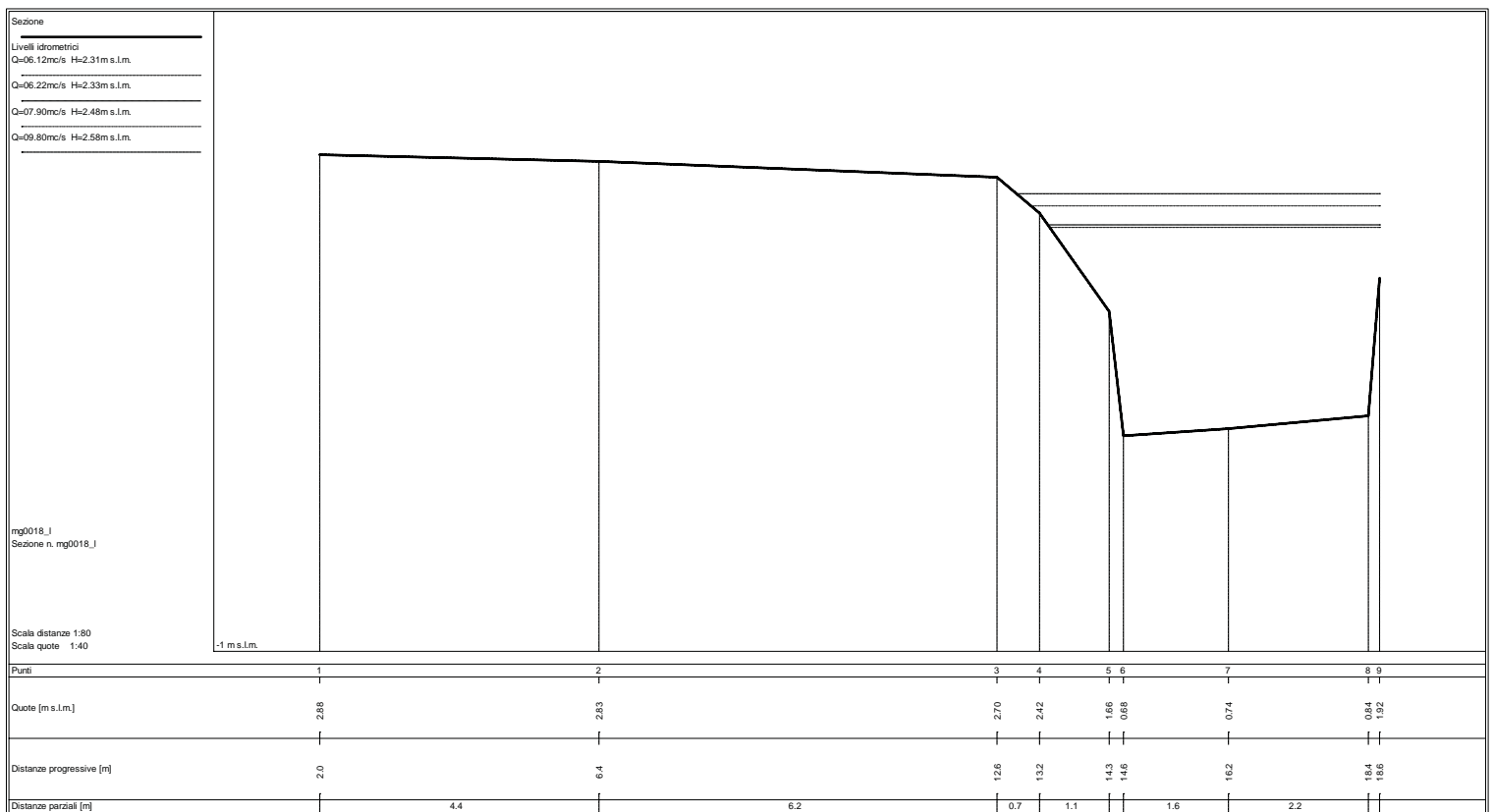
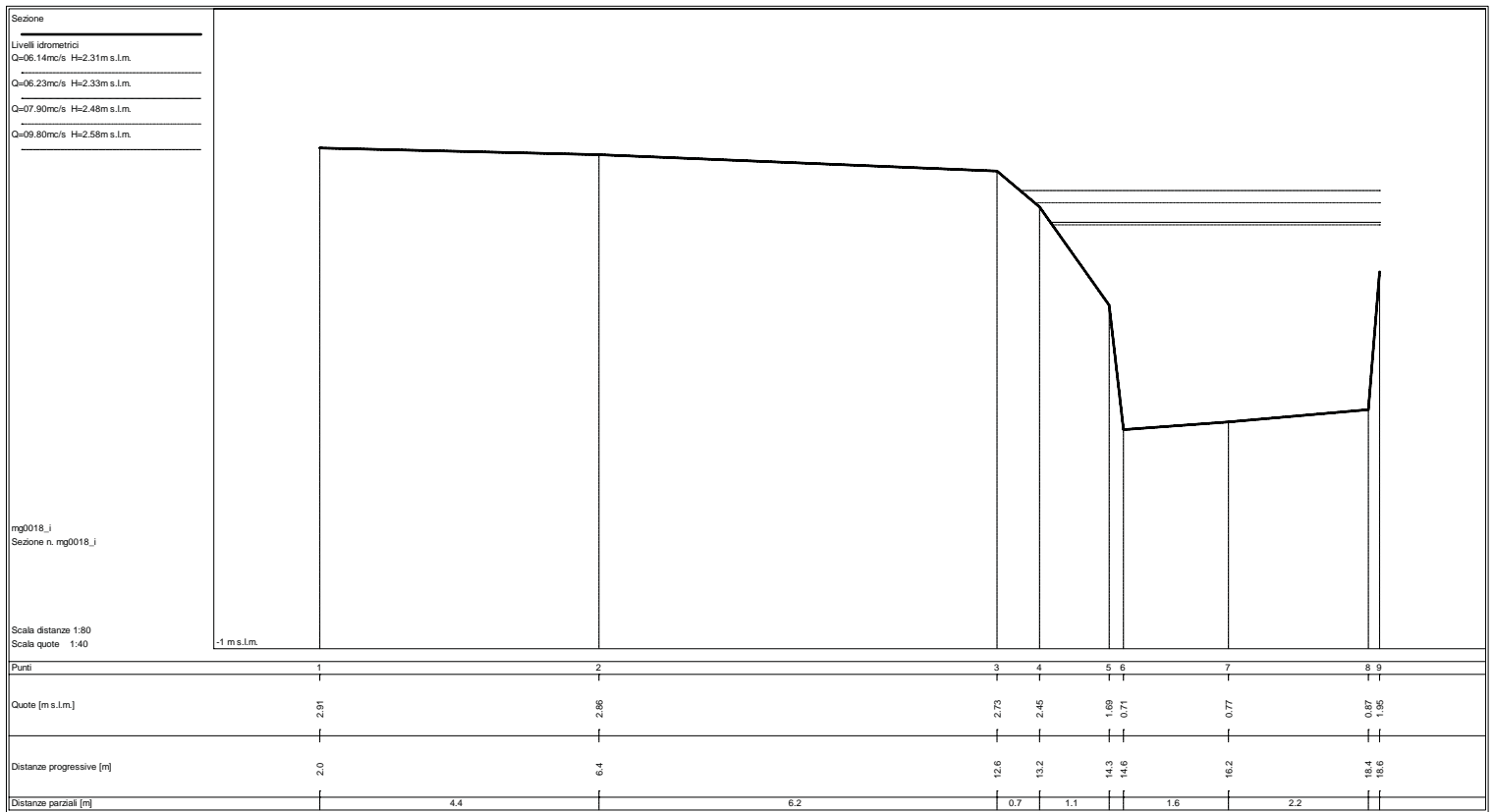

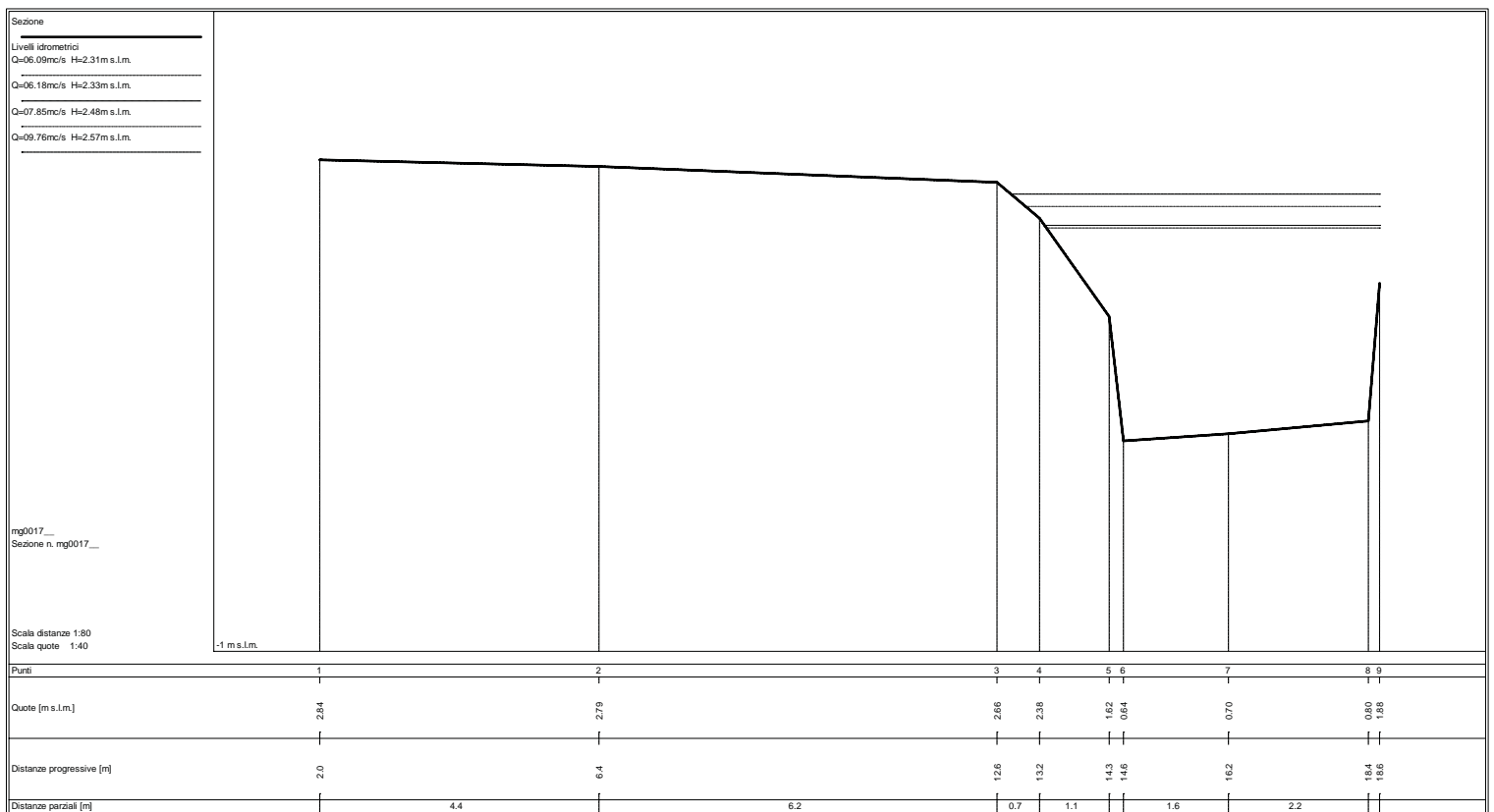
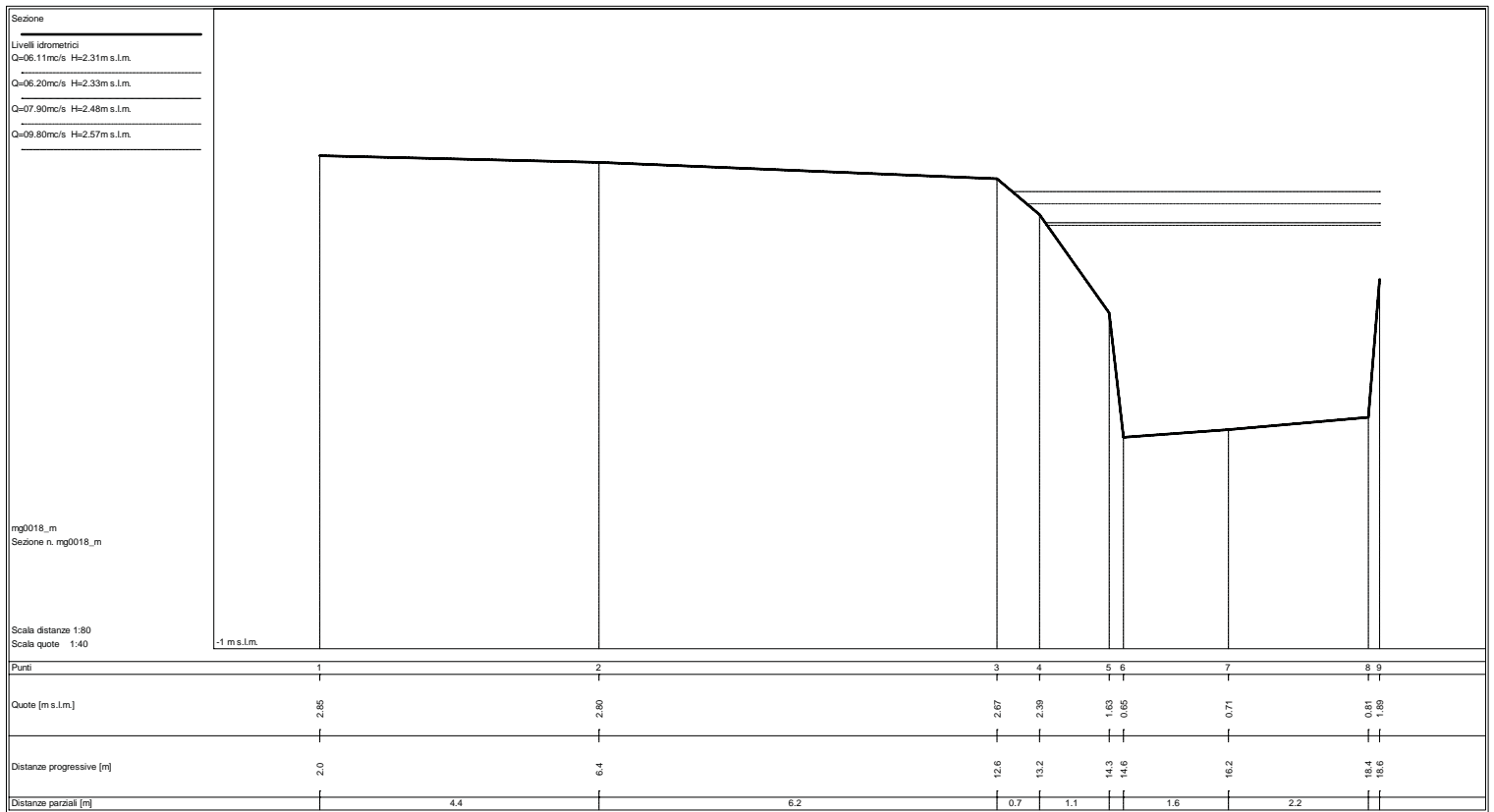

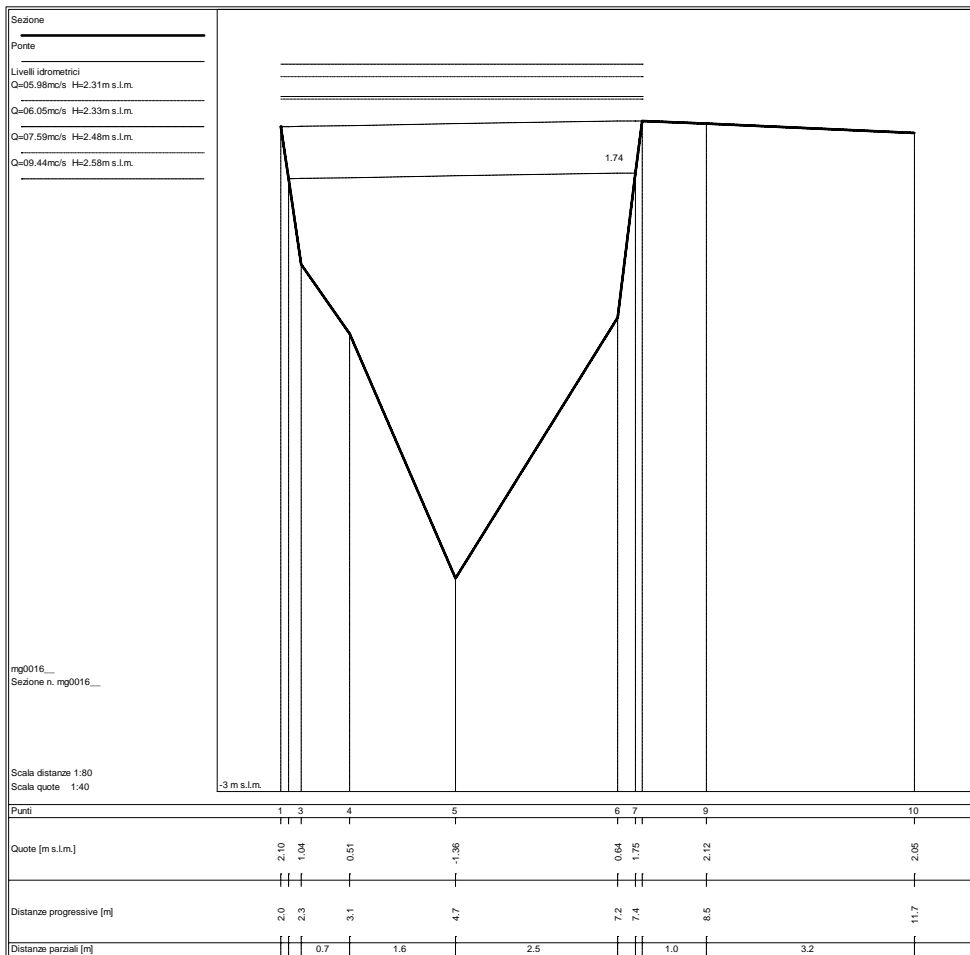
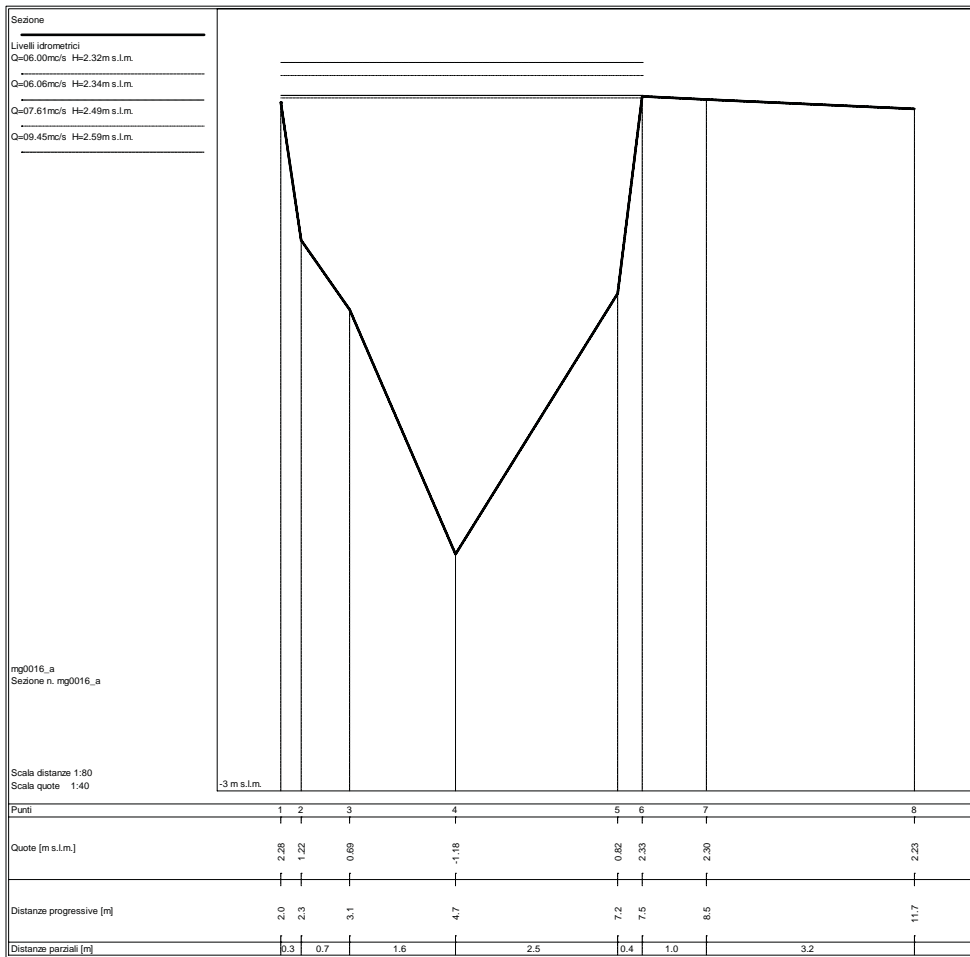

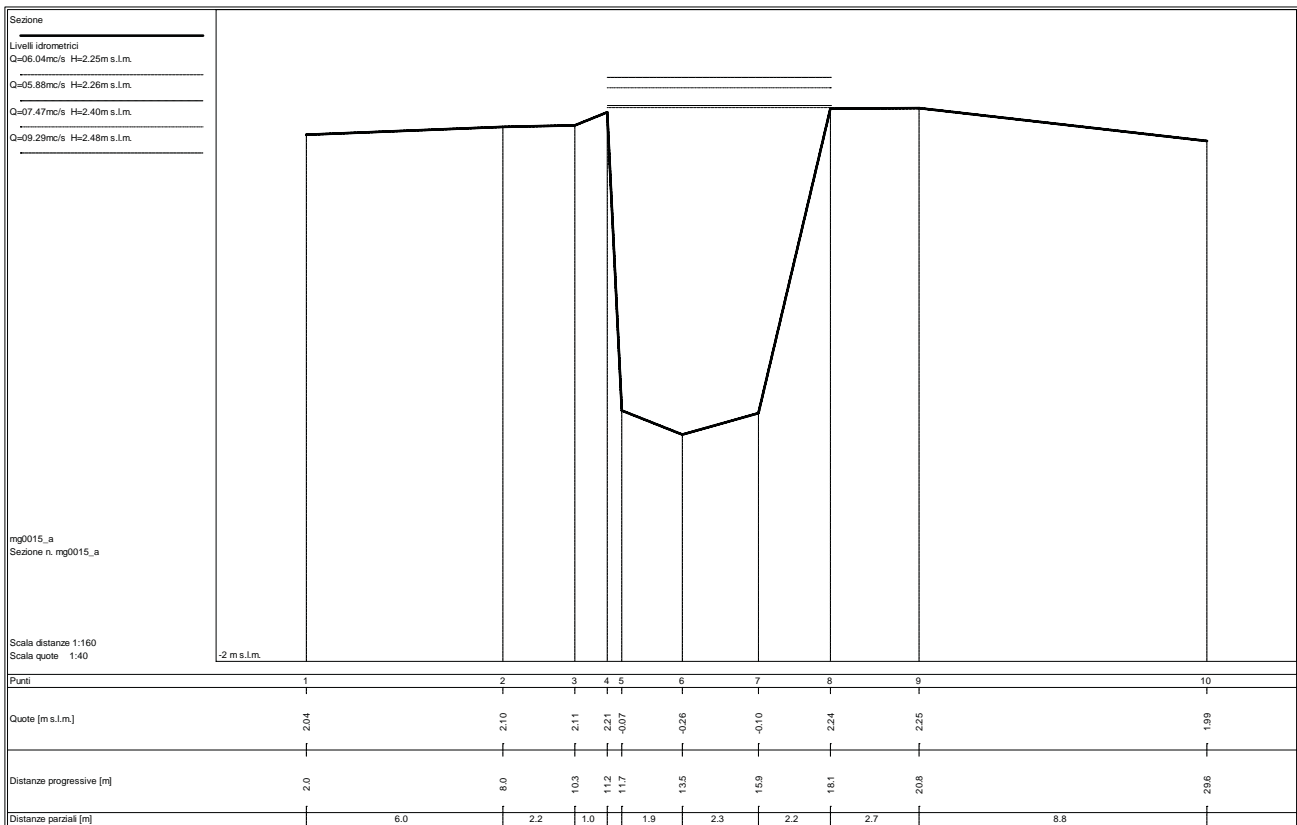
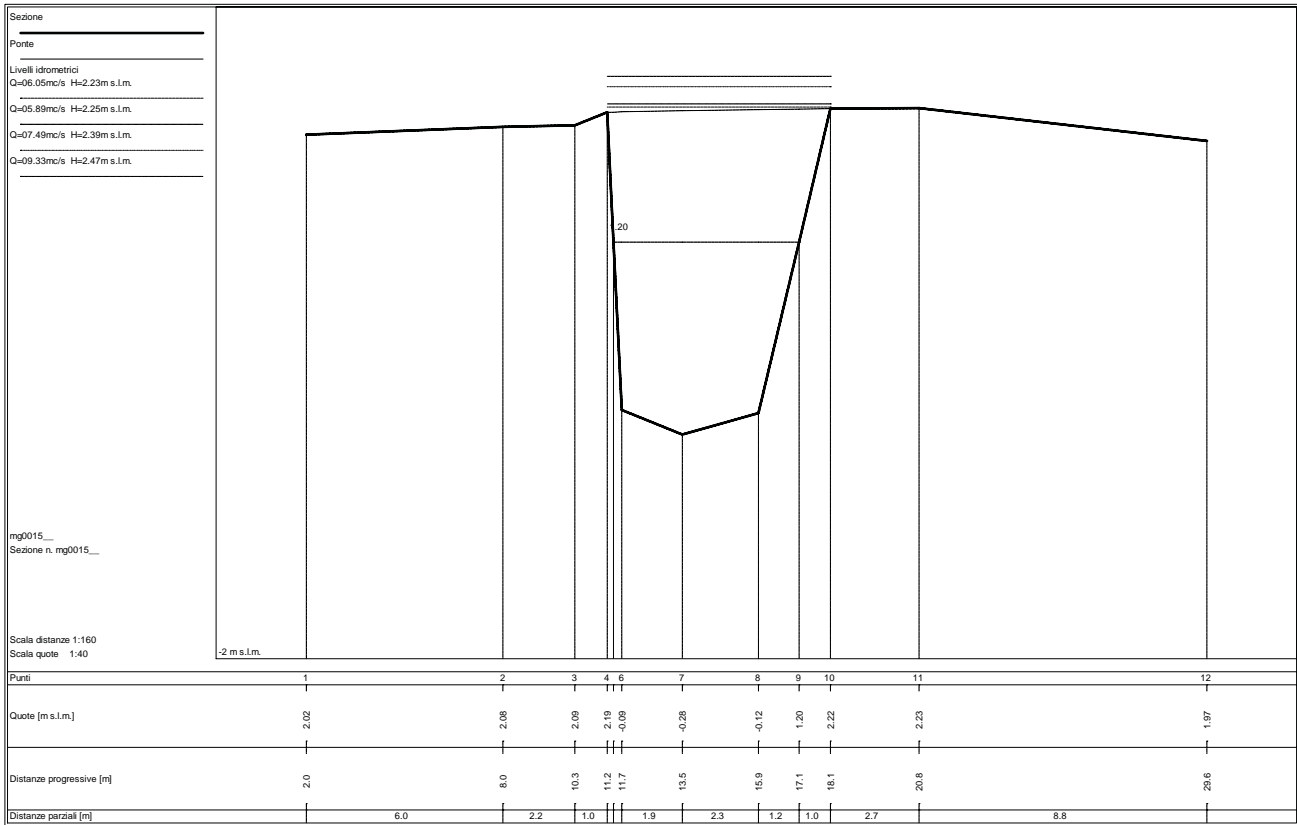

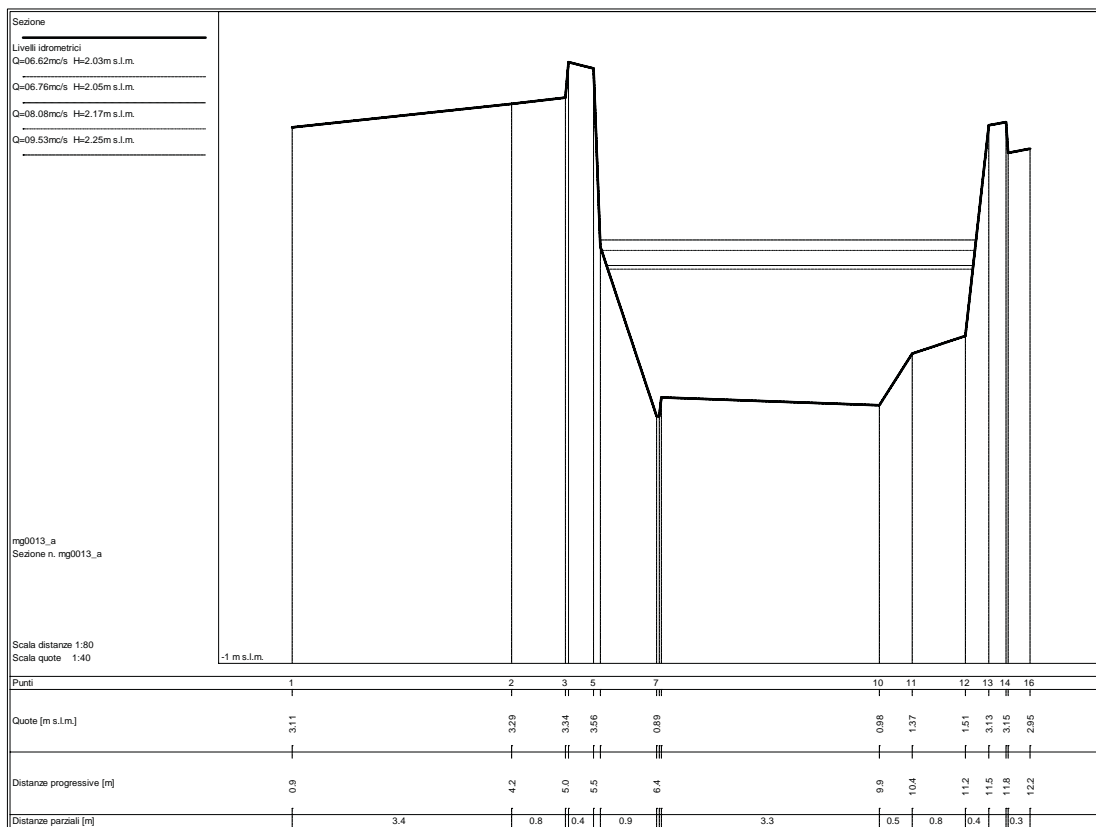
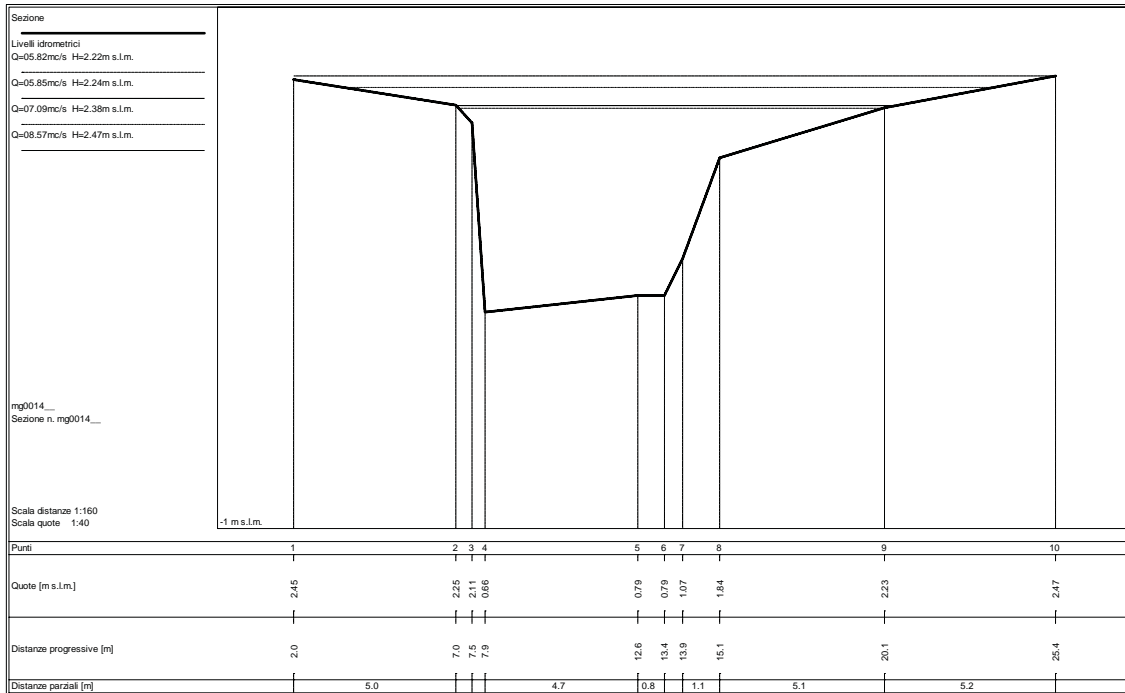

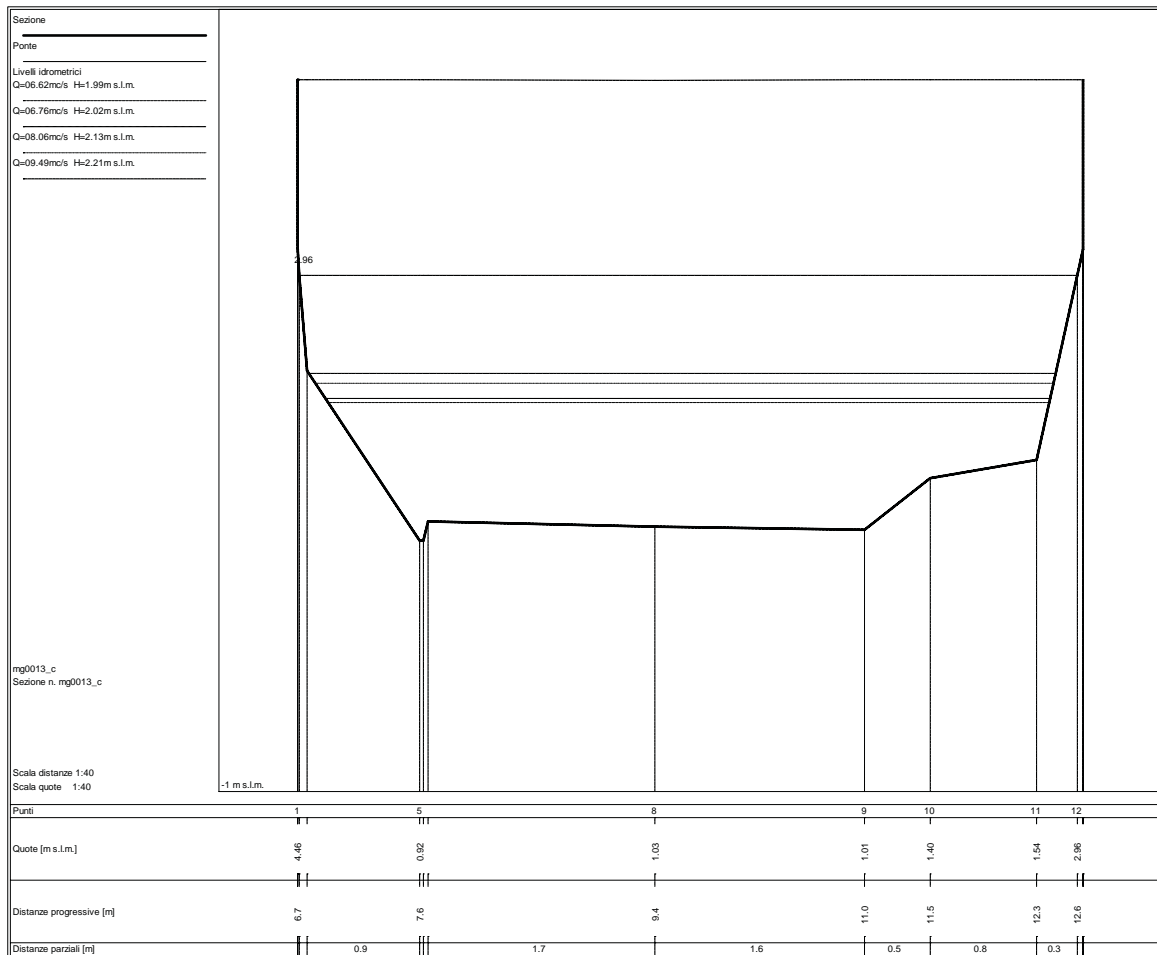
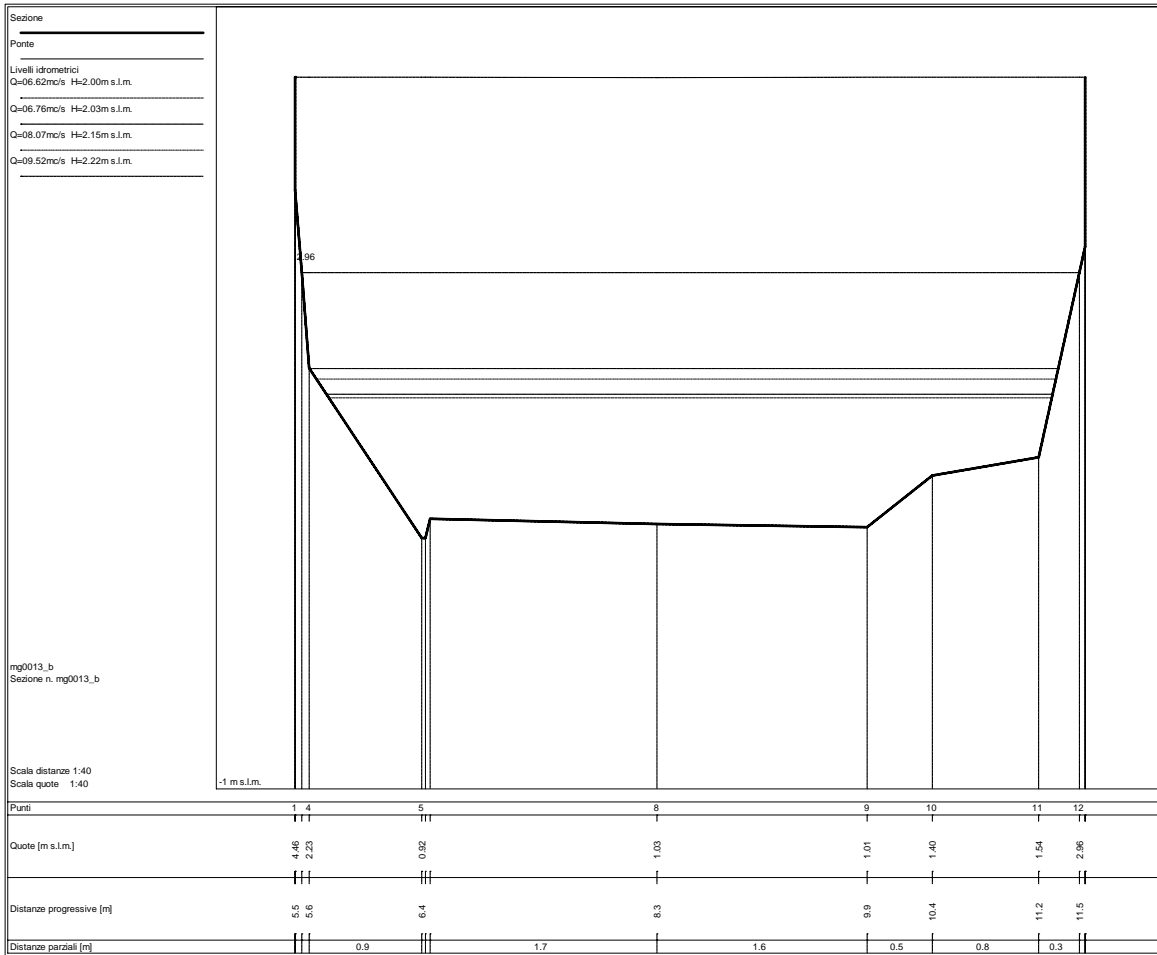

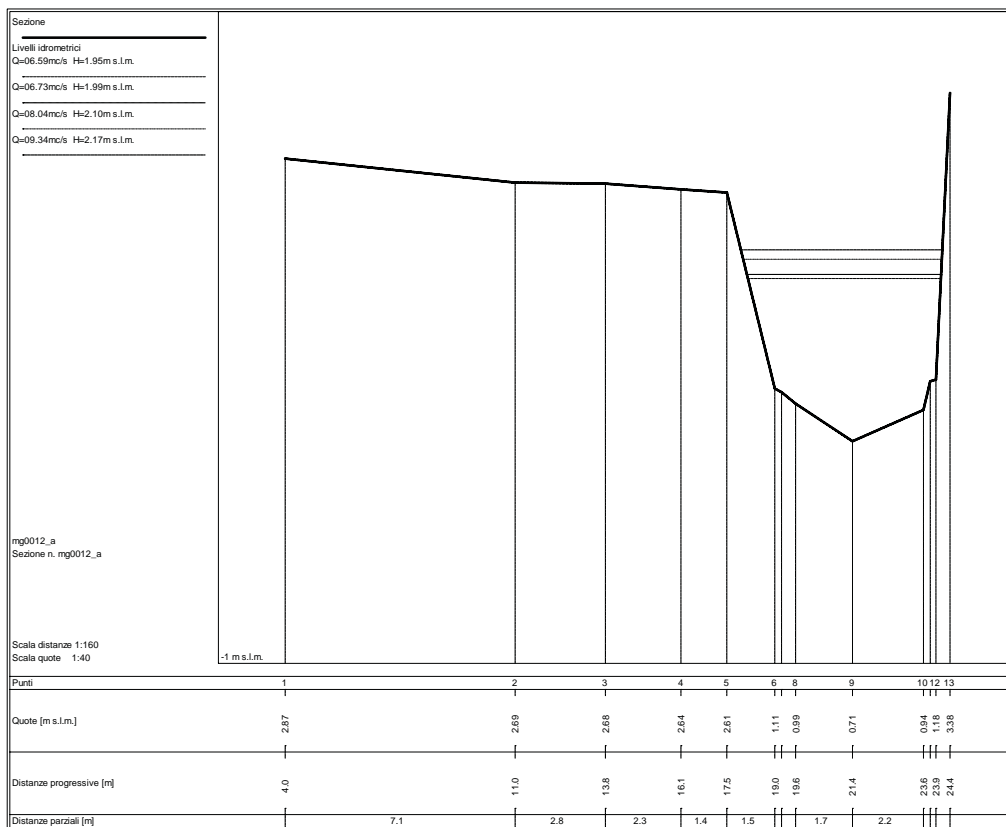
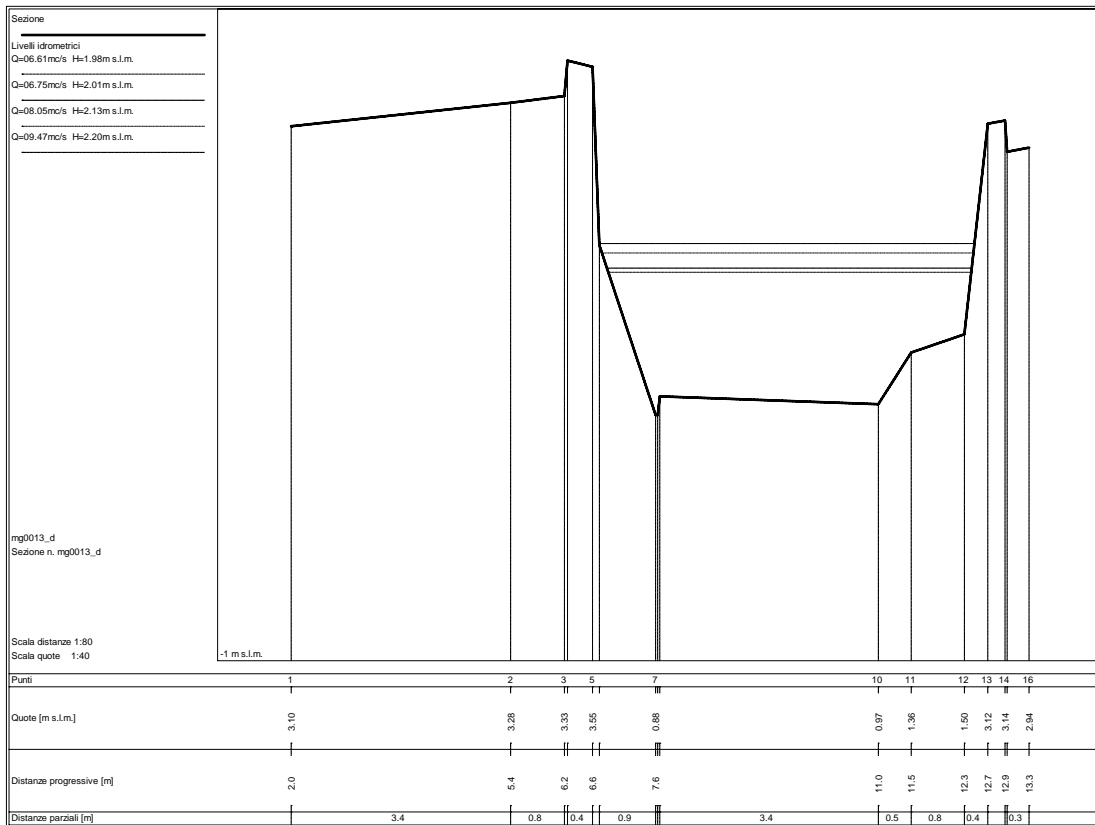

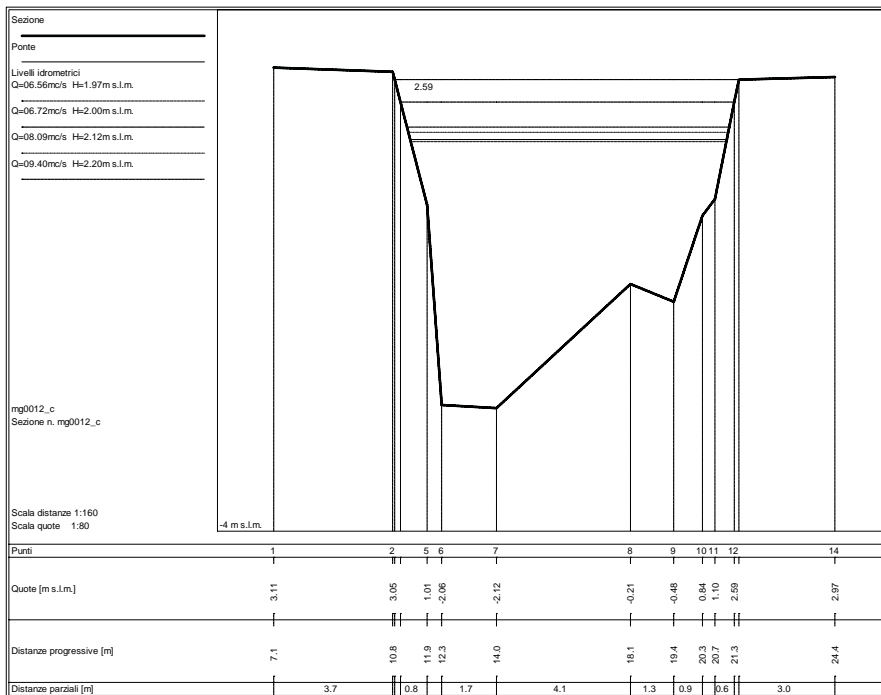
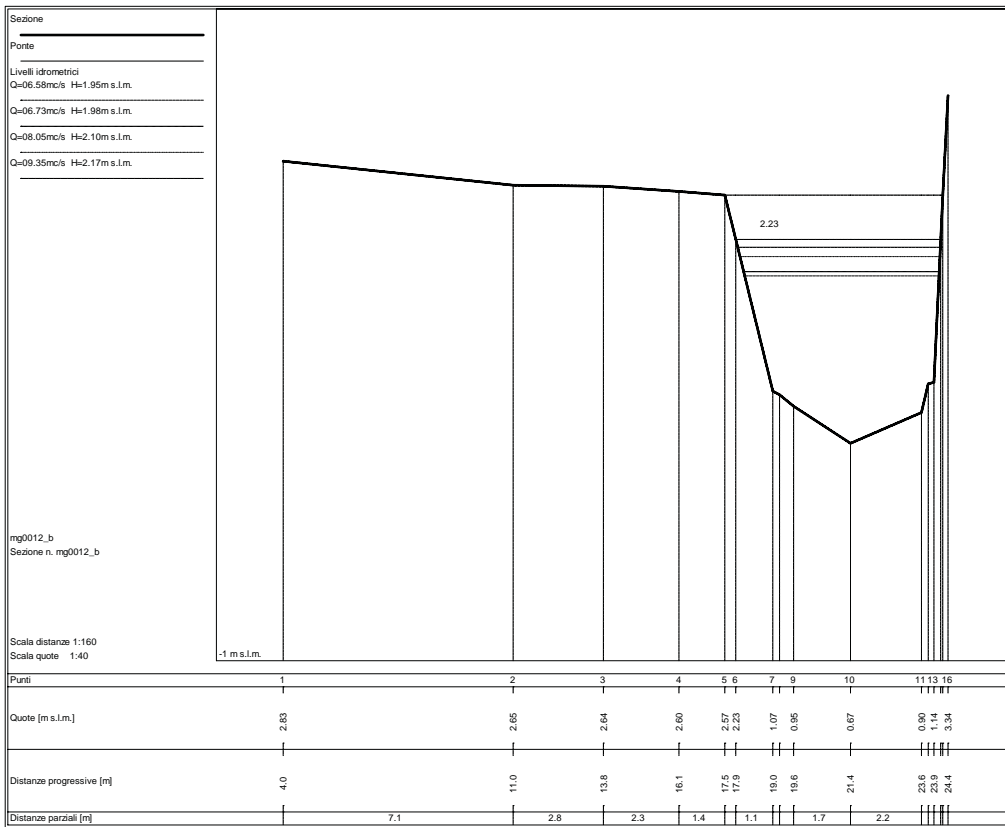

STATO ATTUALE

Sezioni fluviali fosso Magliano – MG_4

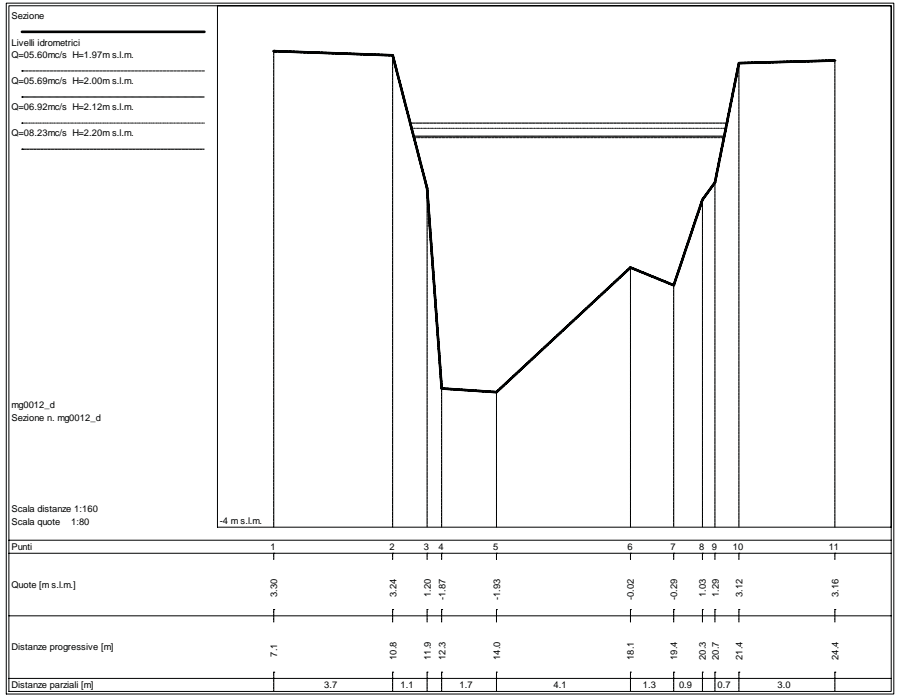
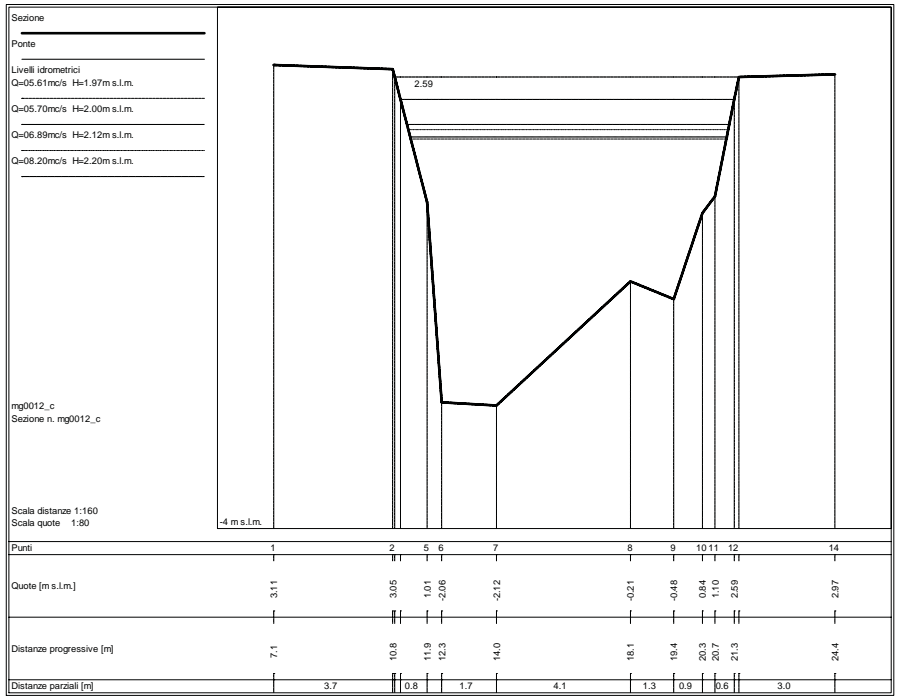

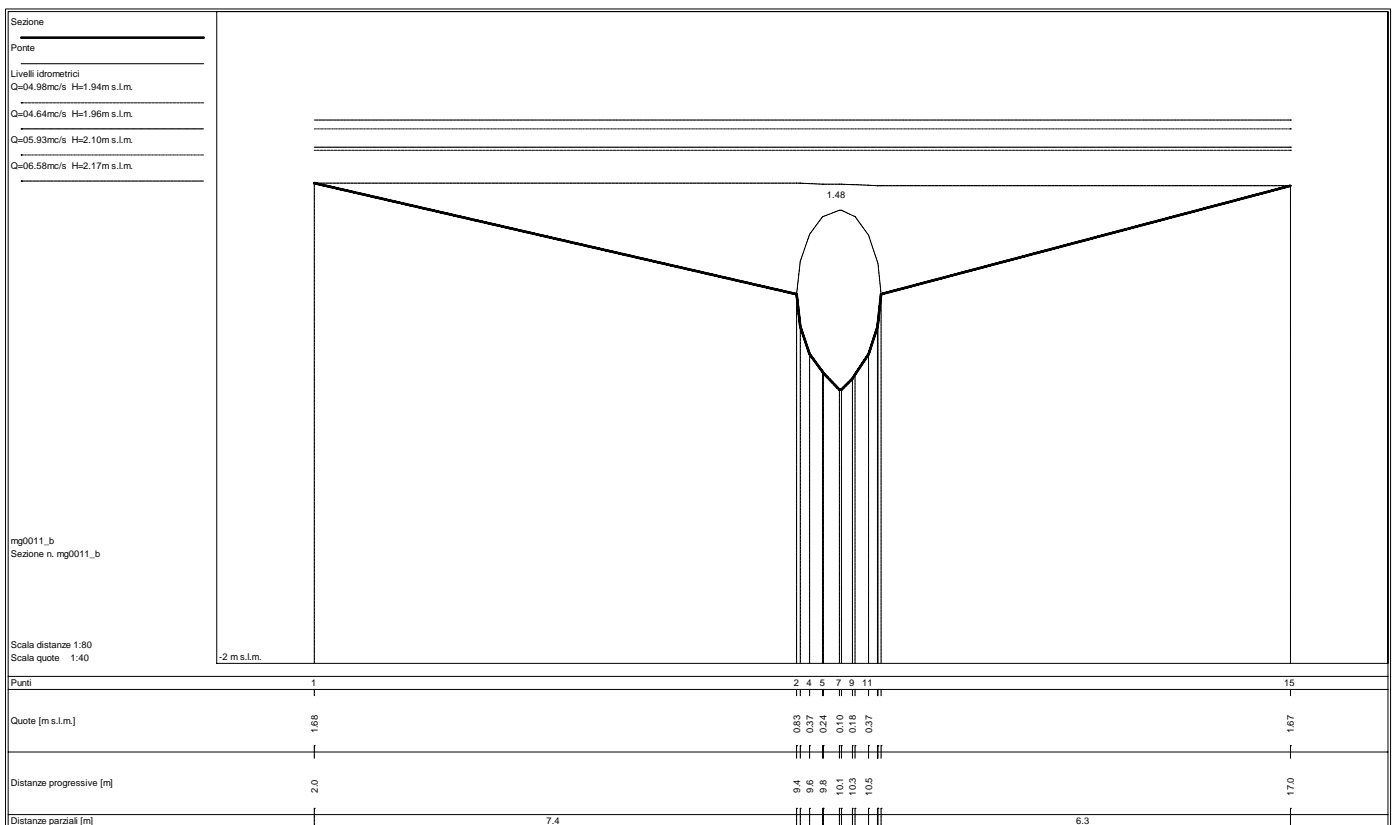
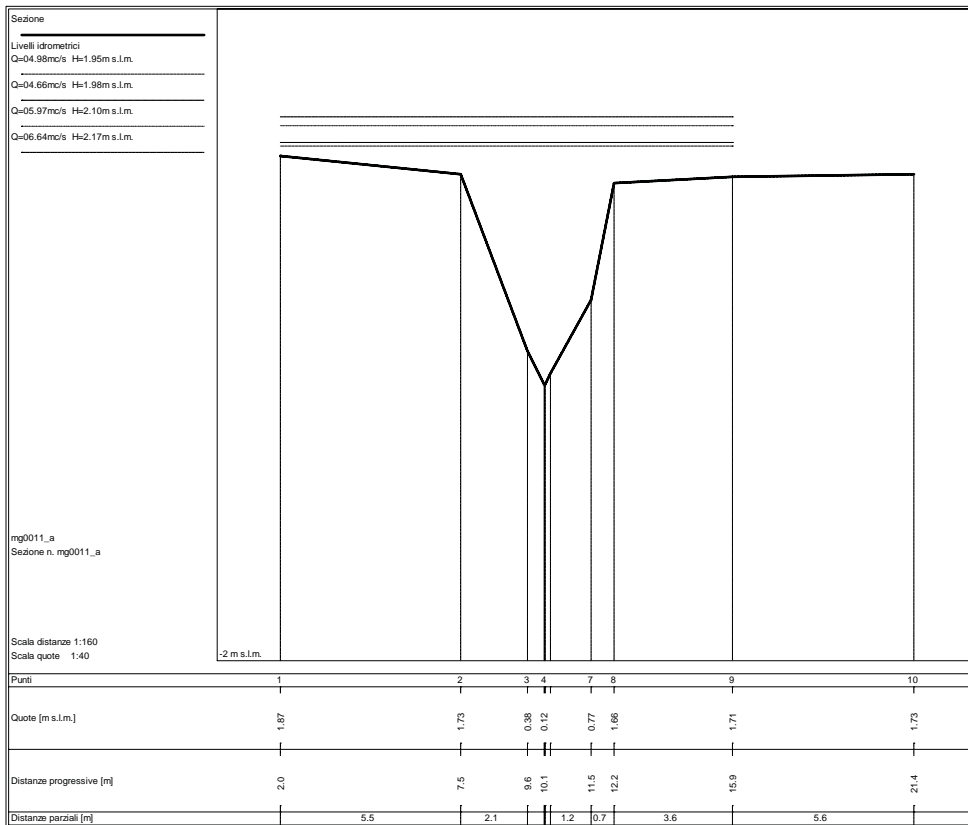

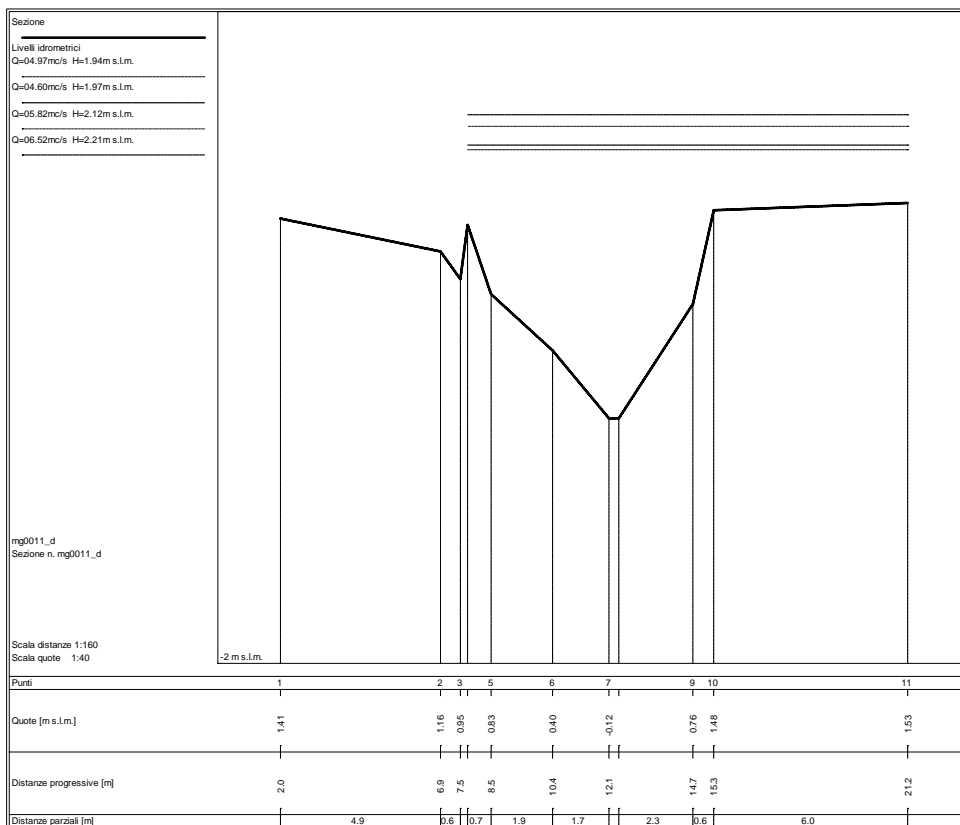
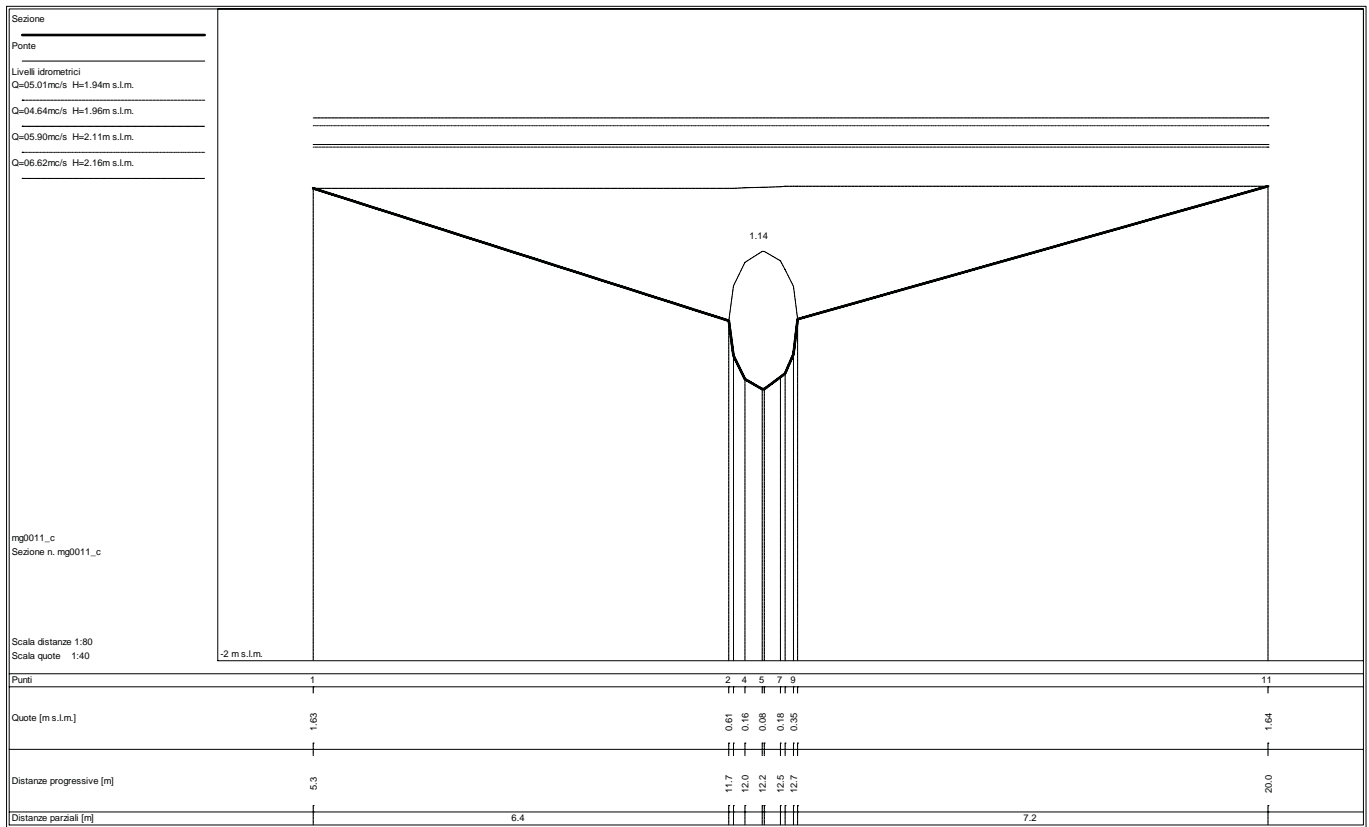

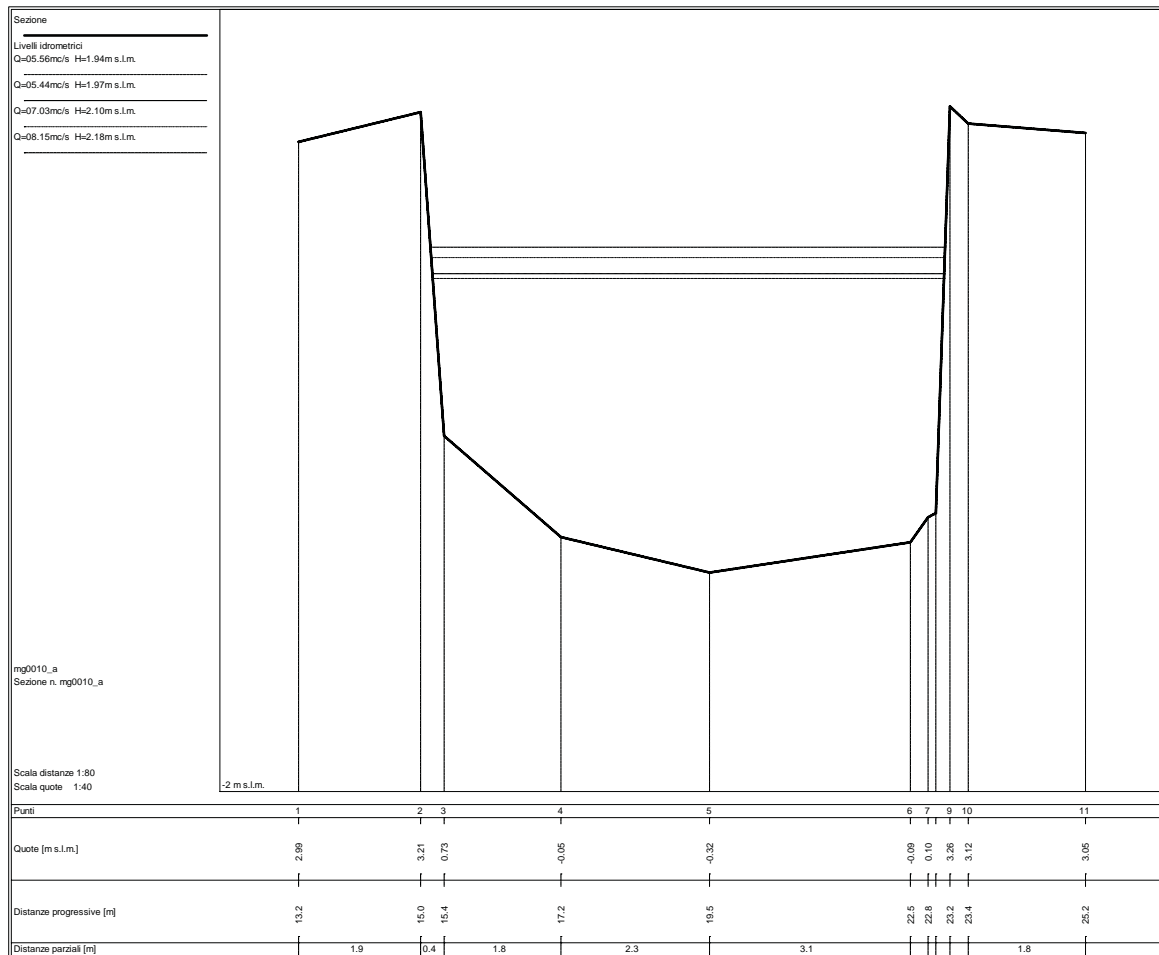
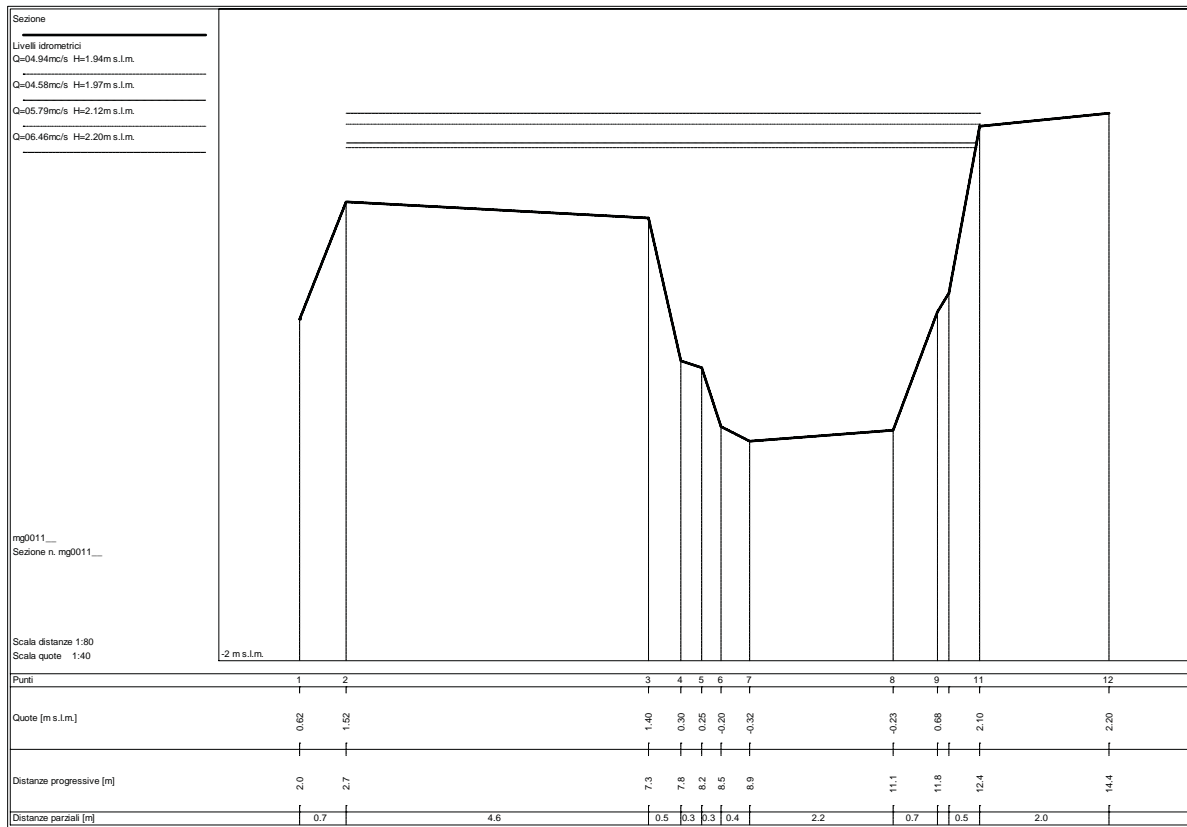

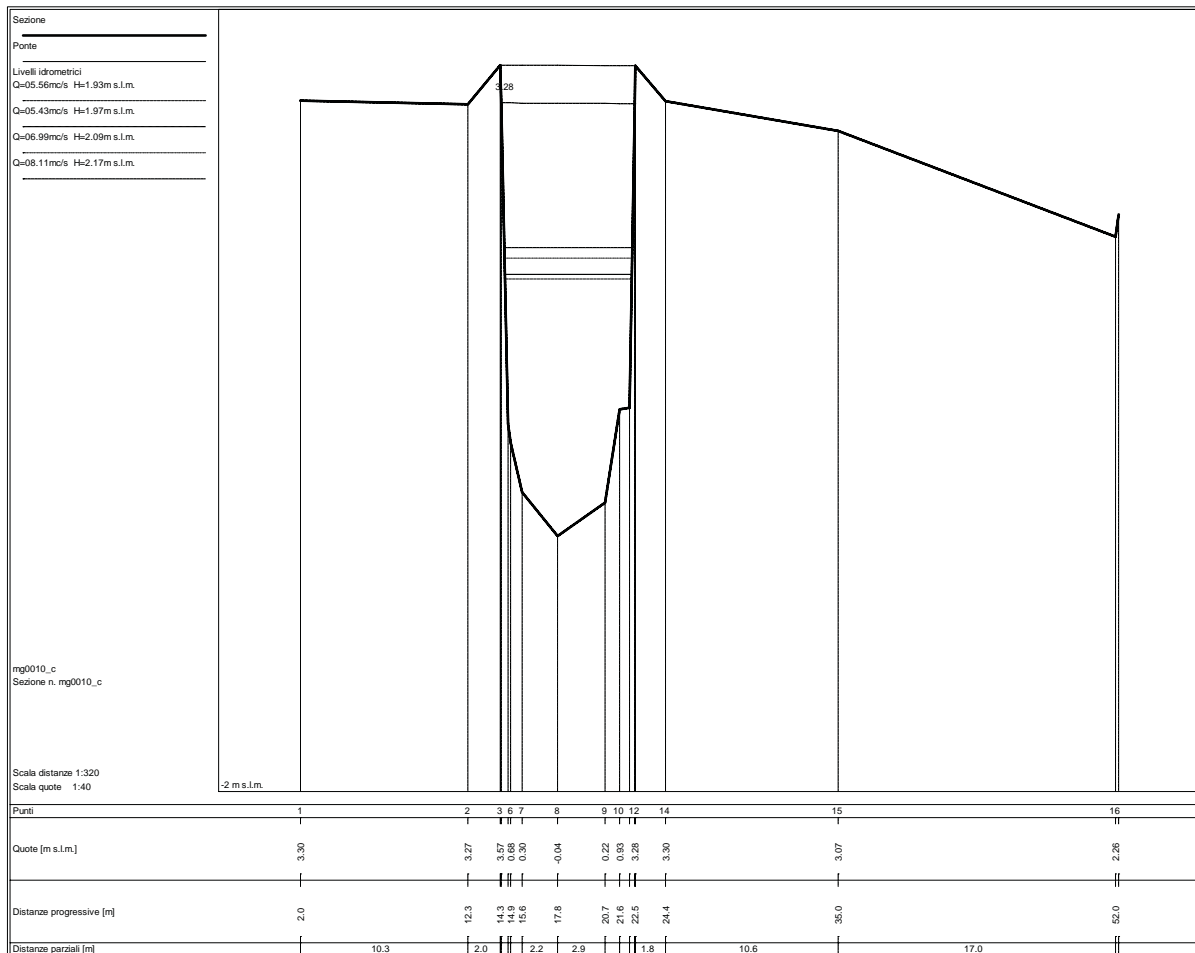
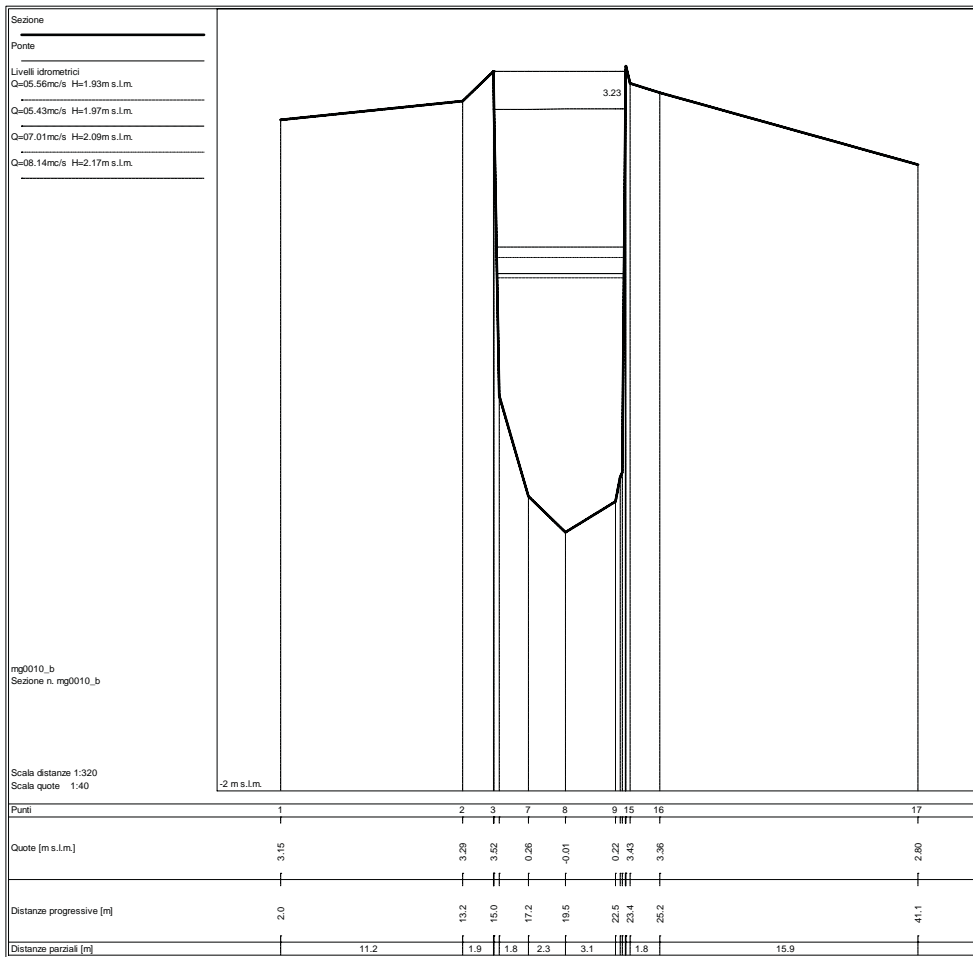

Sezione

 Livelli idrometrici
 Q=05.56mc/s H=1.93m s.L.m.

 Q=05.42mc/s H=1.97m s.L.m.

 Q=06.97mc/s H=2.09m s.L.m.

 Q=08.09mc/s H=2.17m s.L.m.

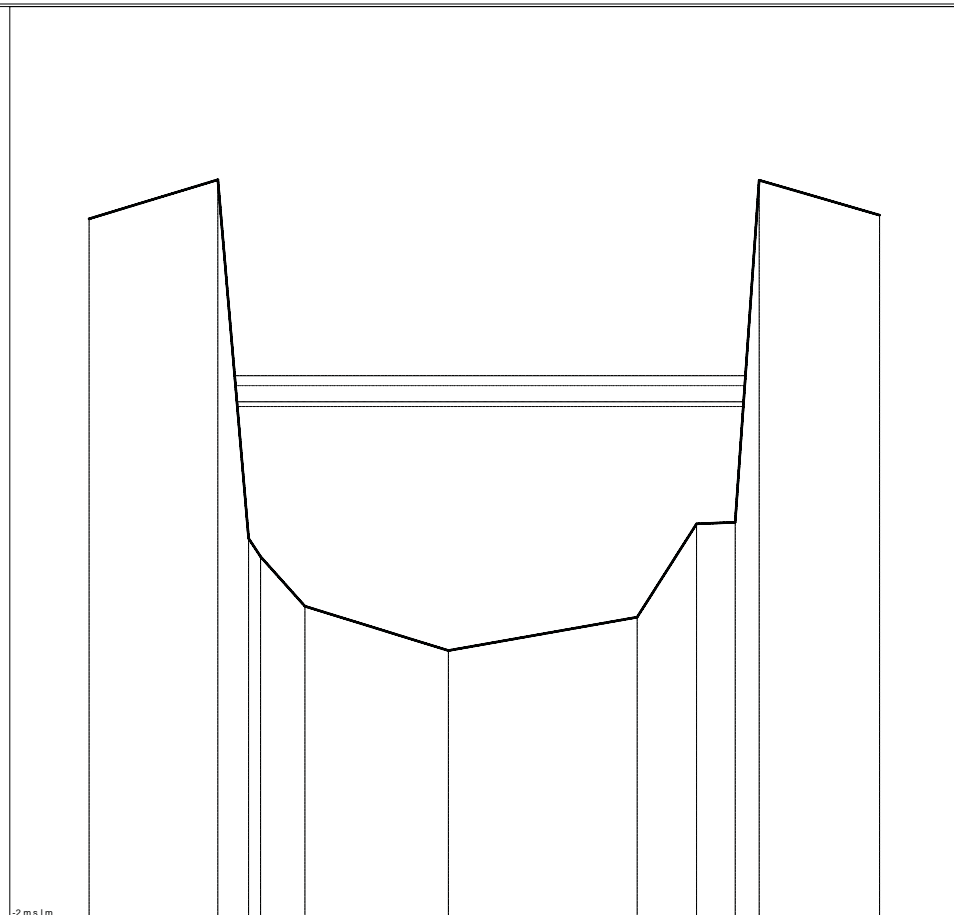

mg0010_d
 Sezione n. mg0010_d

Scala distanze 1:80
 Scala quote 1:40

Punti	1	2	3	4	5	6	7	8	9	10	11
Quote [m s.L.m.]	3.37	3.67	0.95	0.78	0.40	0.06	0.32	1.03	1.05	3.67	3.40
Distanze progressive [m]	12.3	14.3	14.7	14.9	15.6	17.8	20.7	21.6	22.2	22.6	24.4
Distanze parziali [m]		2.0	0.5	0.7	2.2	2.9	0.9	0.6	0.4	1.8	

Sezione

 Livelli idrometrici
 Q=05.45mc/s H=1.90m s.L.m.

 Q=05.30mc/s H=1.92m s.L.m.

 Q=06.51mc/s H=2.03m s.L.m.

 Q=07.60mc/s H=2.11m s.L.m.

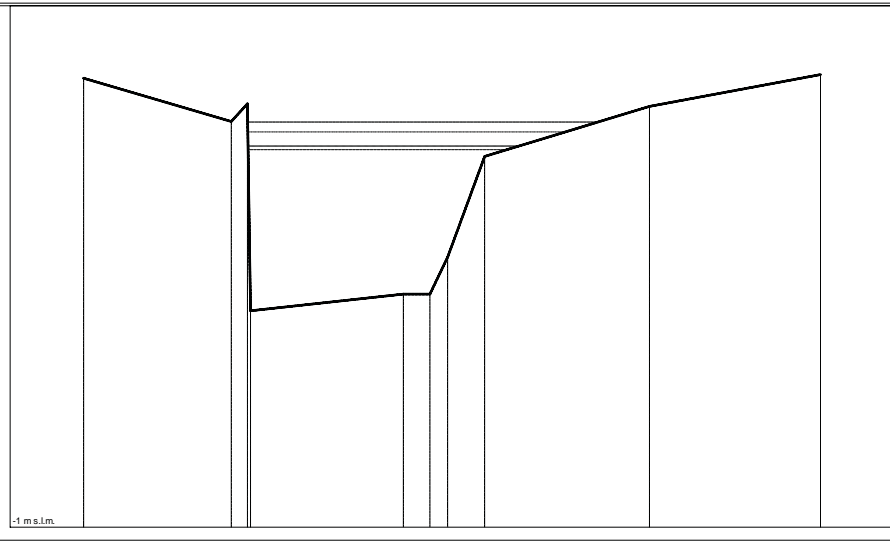

mg0009_...
 Sezione n. mg0009_...

Scala distanze 1:160
 Scala quote 1:40

Punti	1	2	3	5	6	7	8	9	10
Quote [m s.L.m.]	2.45	2.11	2.25	0.79	0.79	1.07	1.84	2.23	2.47
Distanze progressive [m]	2.0	6.5	7.0	11.8	12.6	13.2	14.3	19.4	24.6
Distanze parziali [m]		4.5	0.5	4.7	0.8	1.1	5.1	5.2	

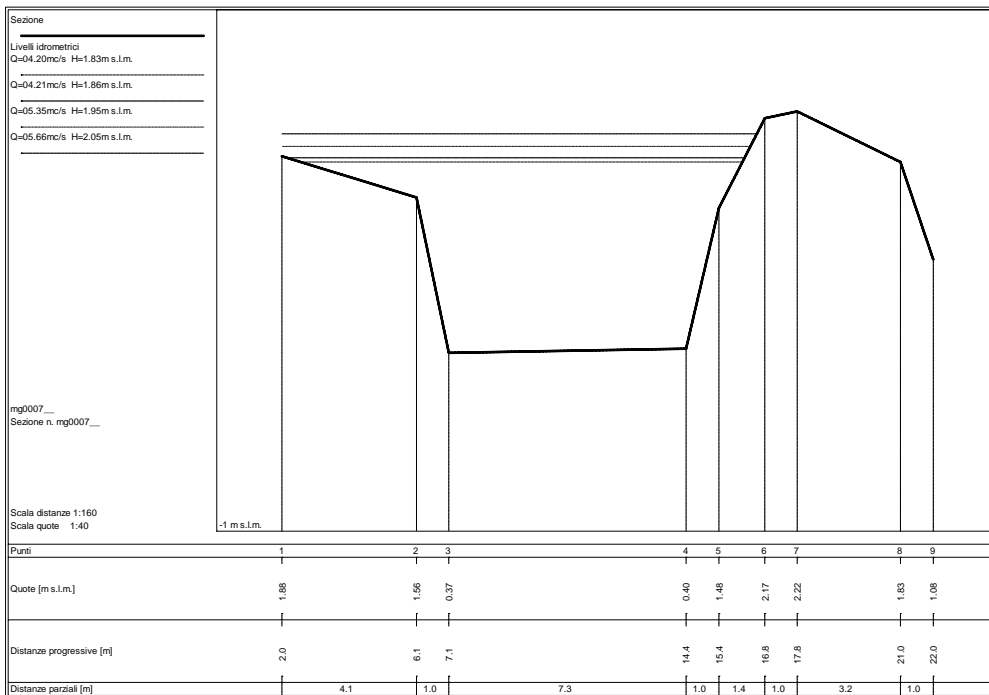
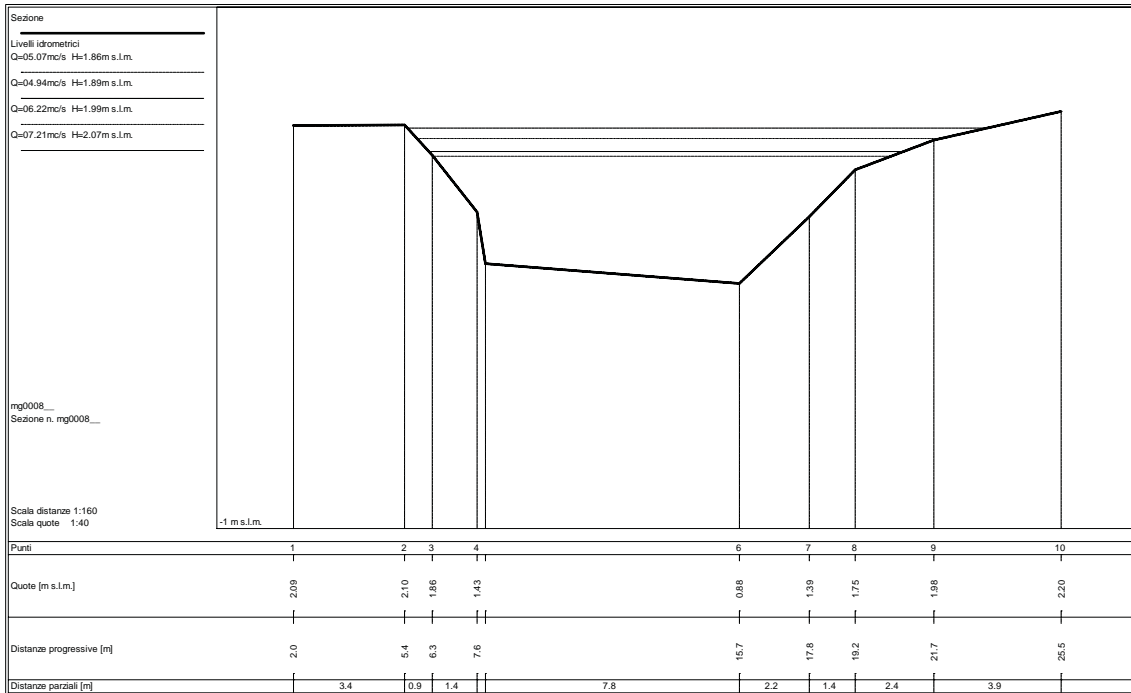

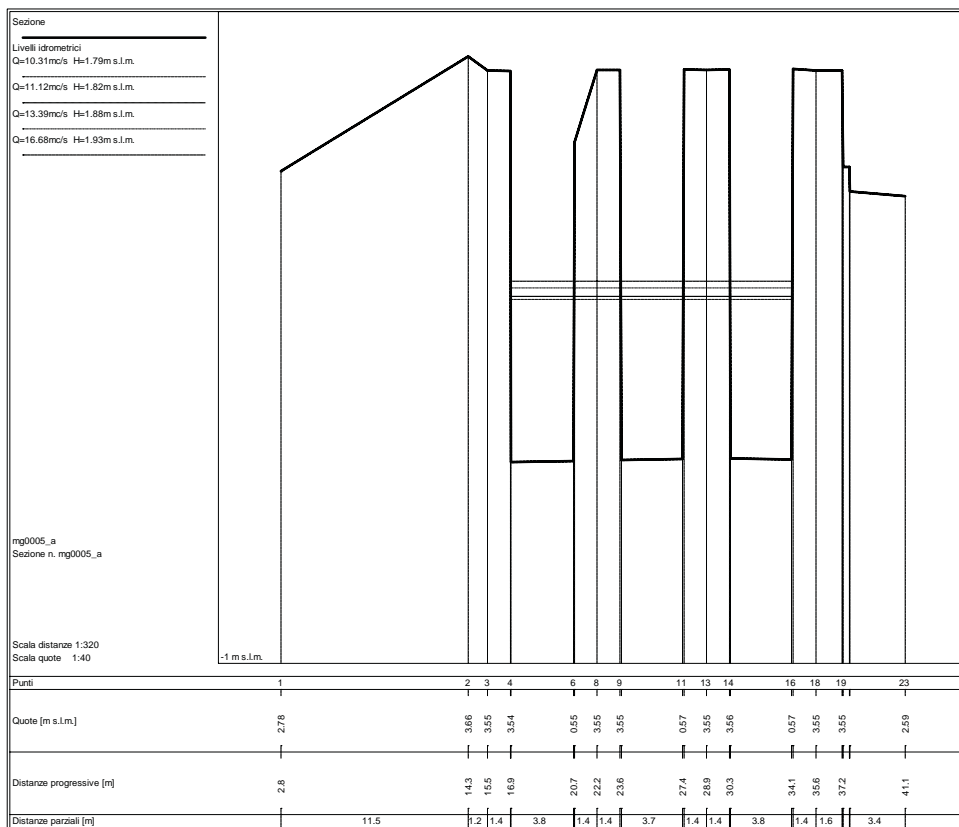
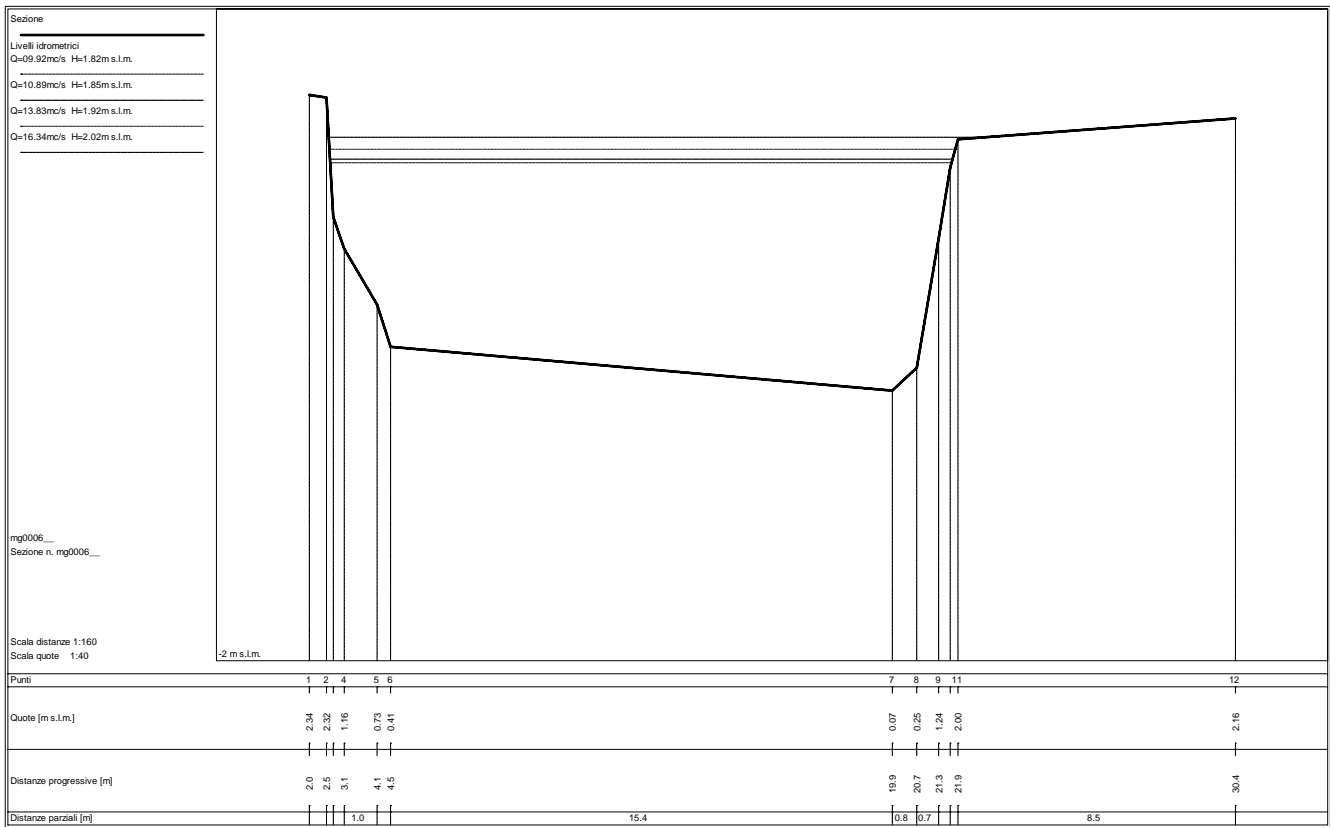

STATO ATTUALE

Sezioni fluviali fosso Magliano – MG_5

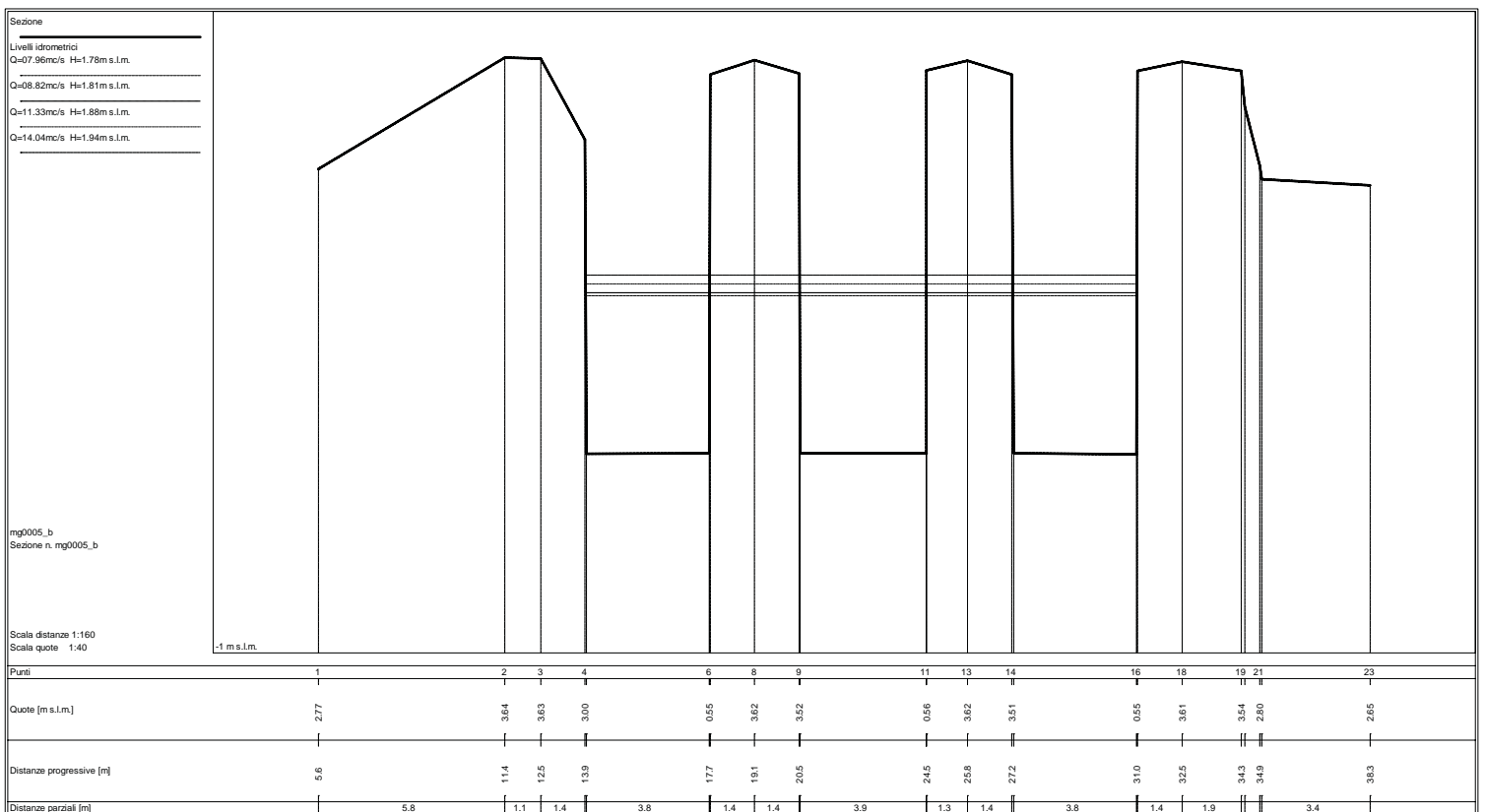
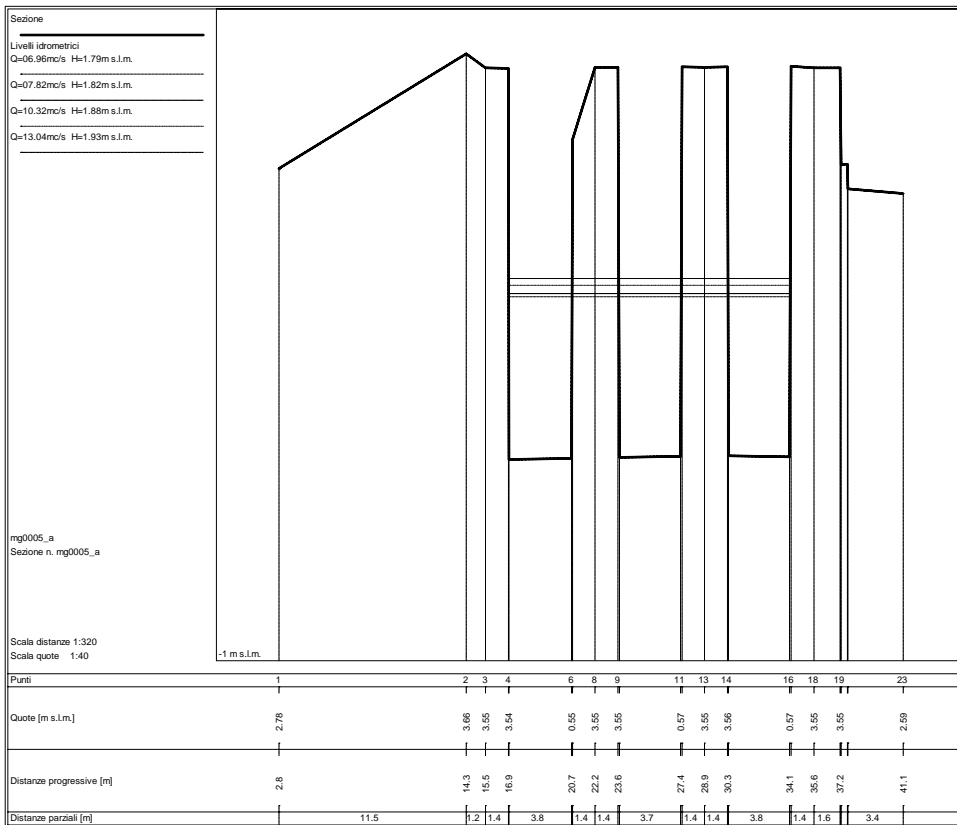

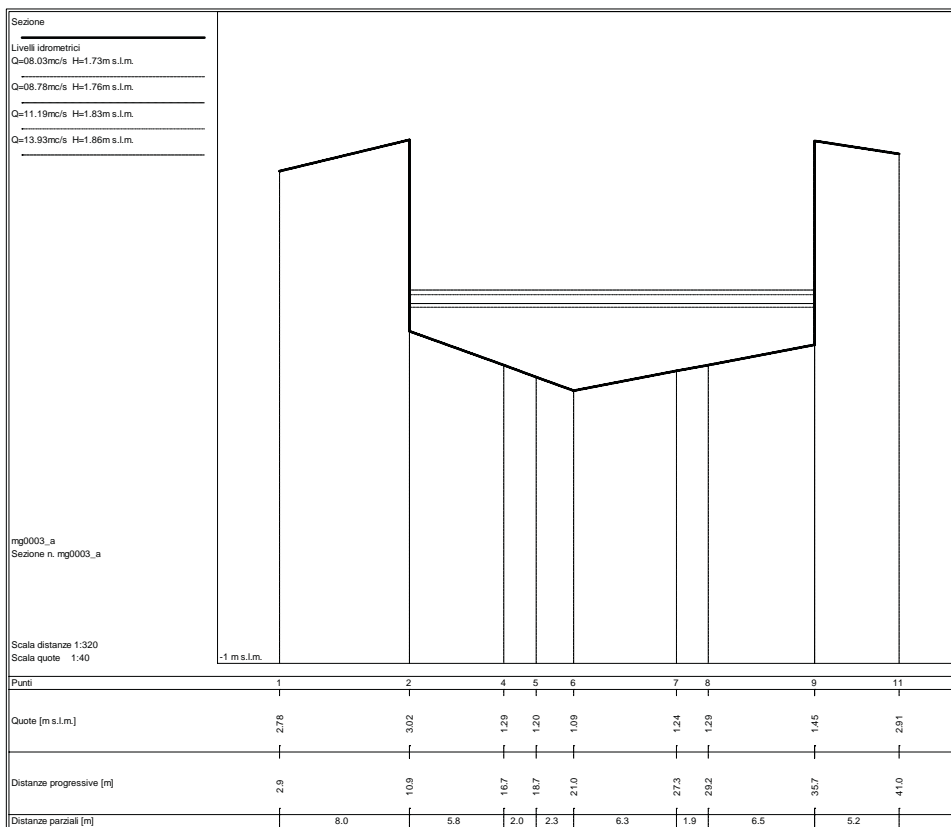
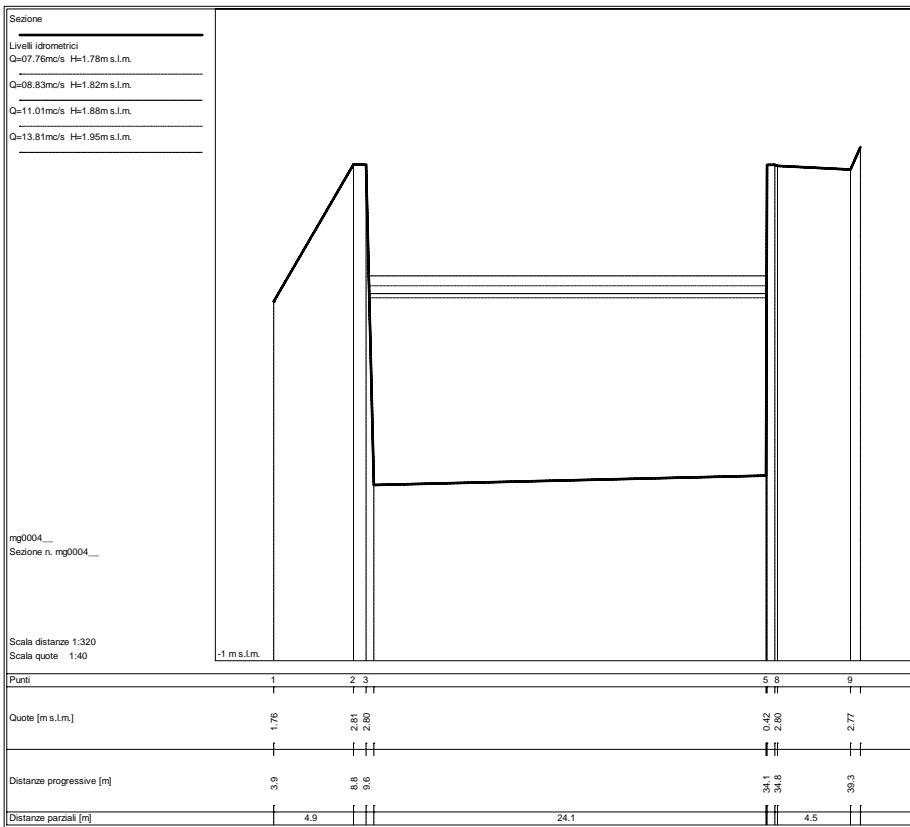

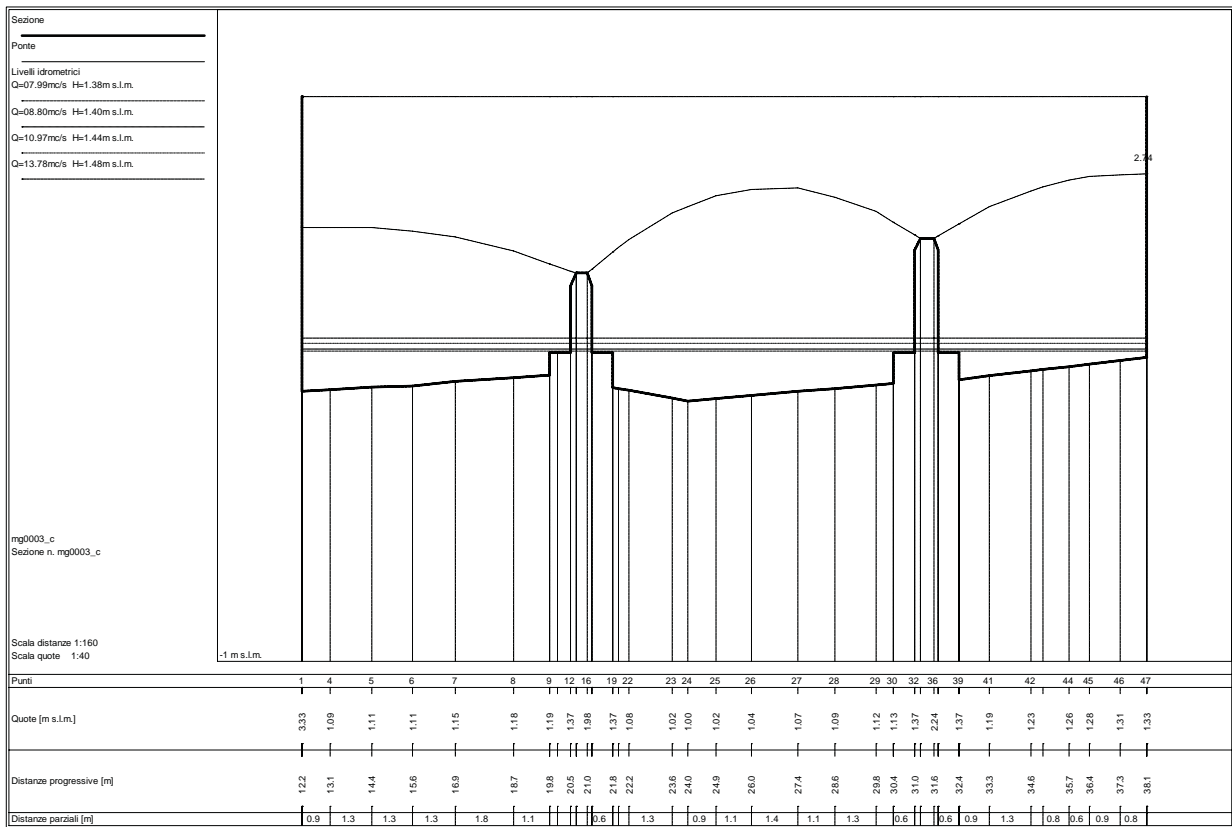
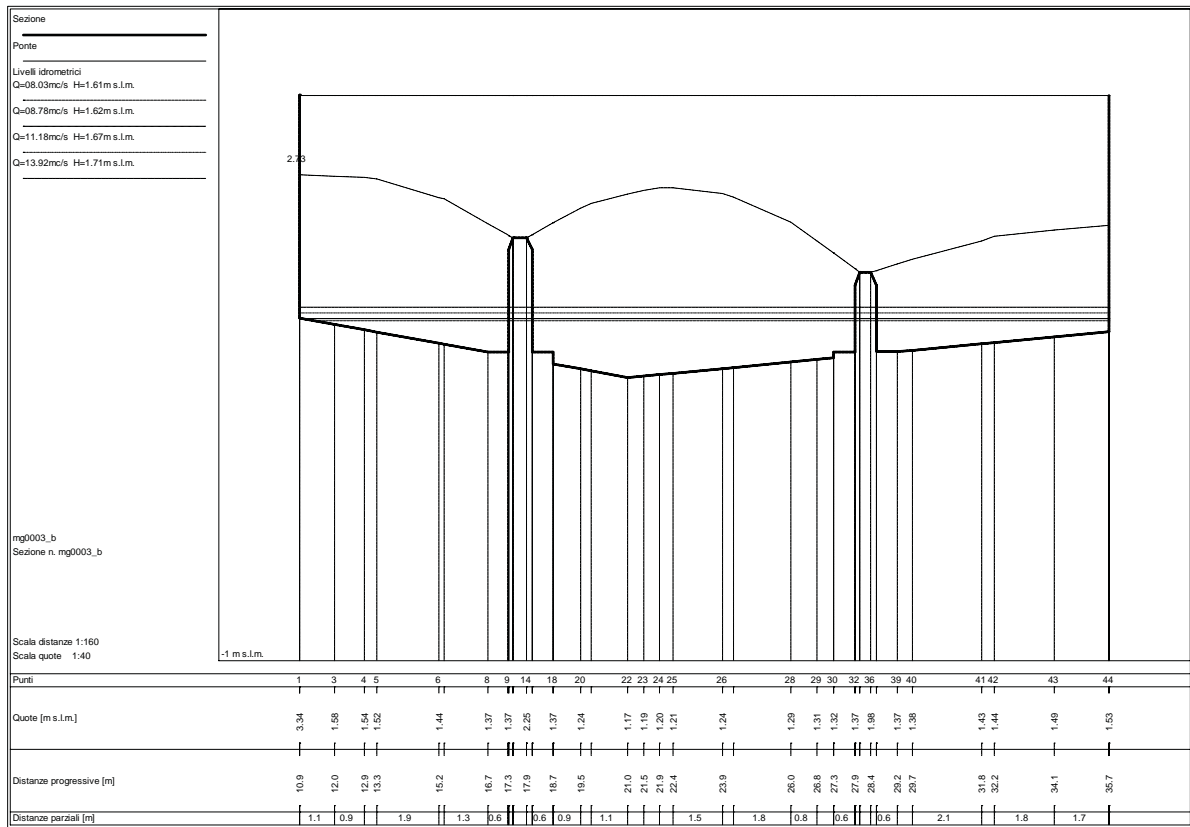

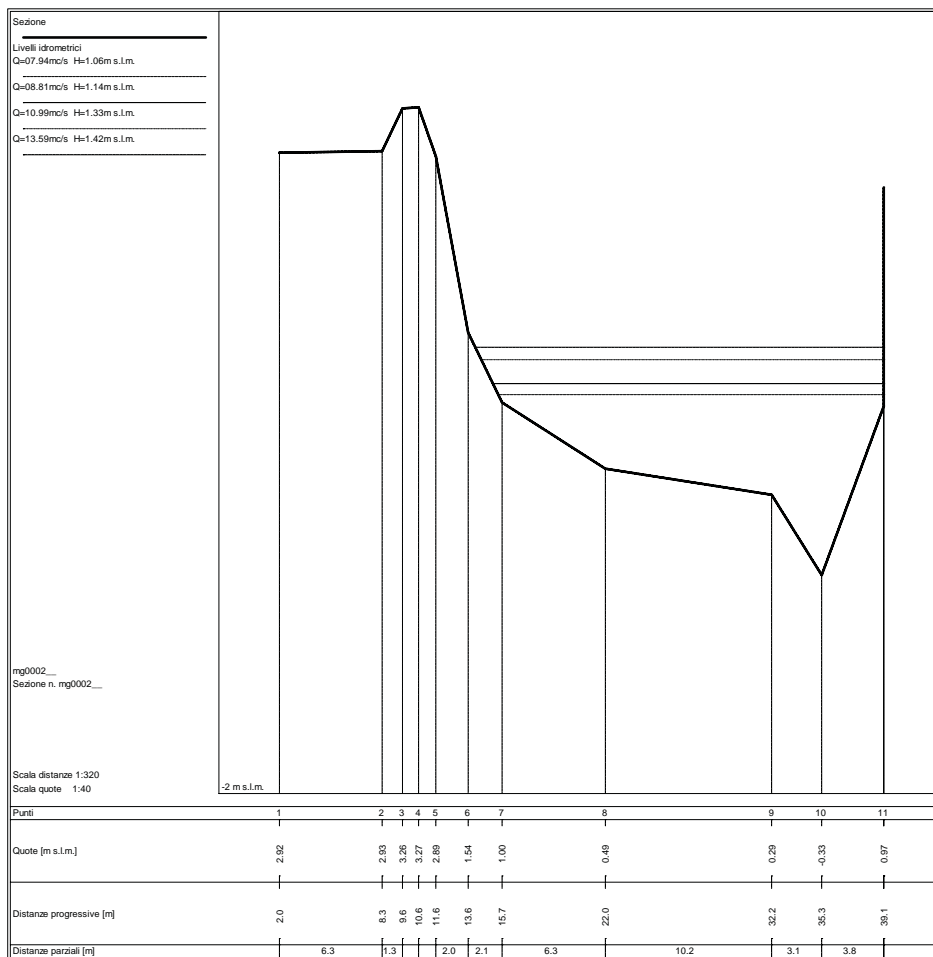
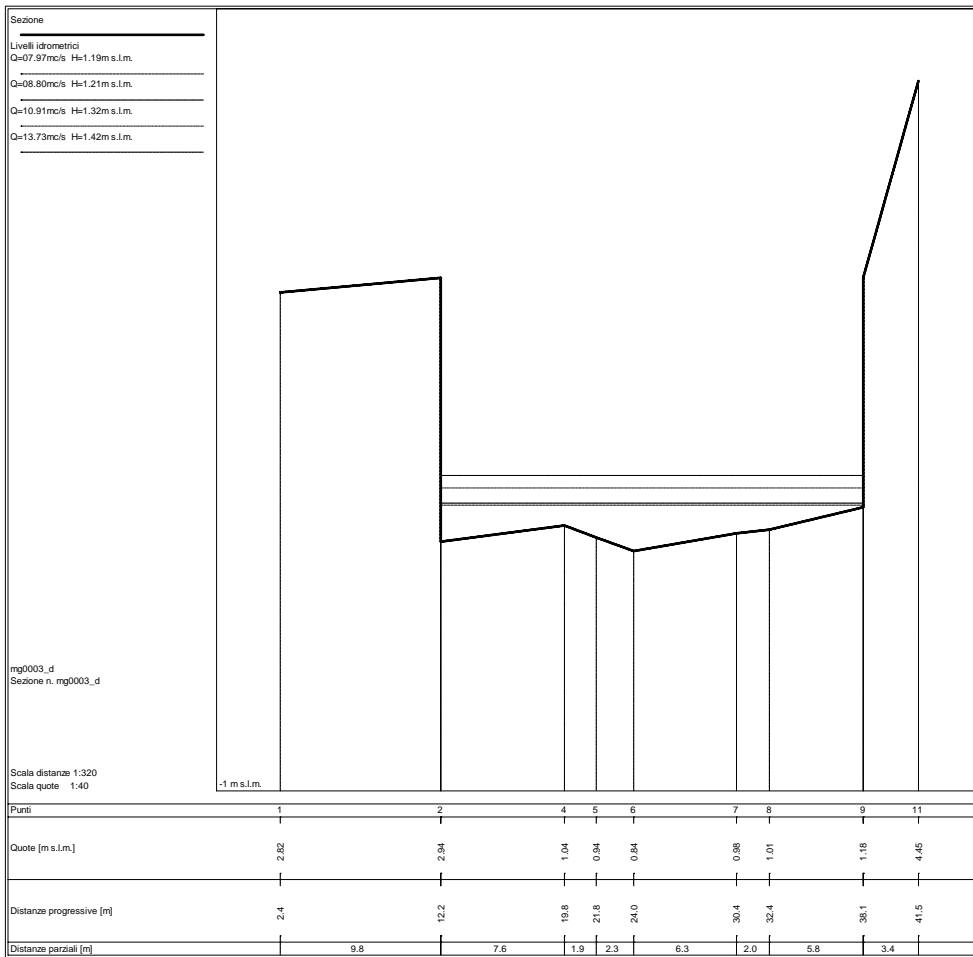

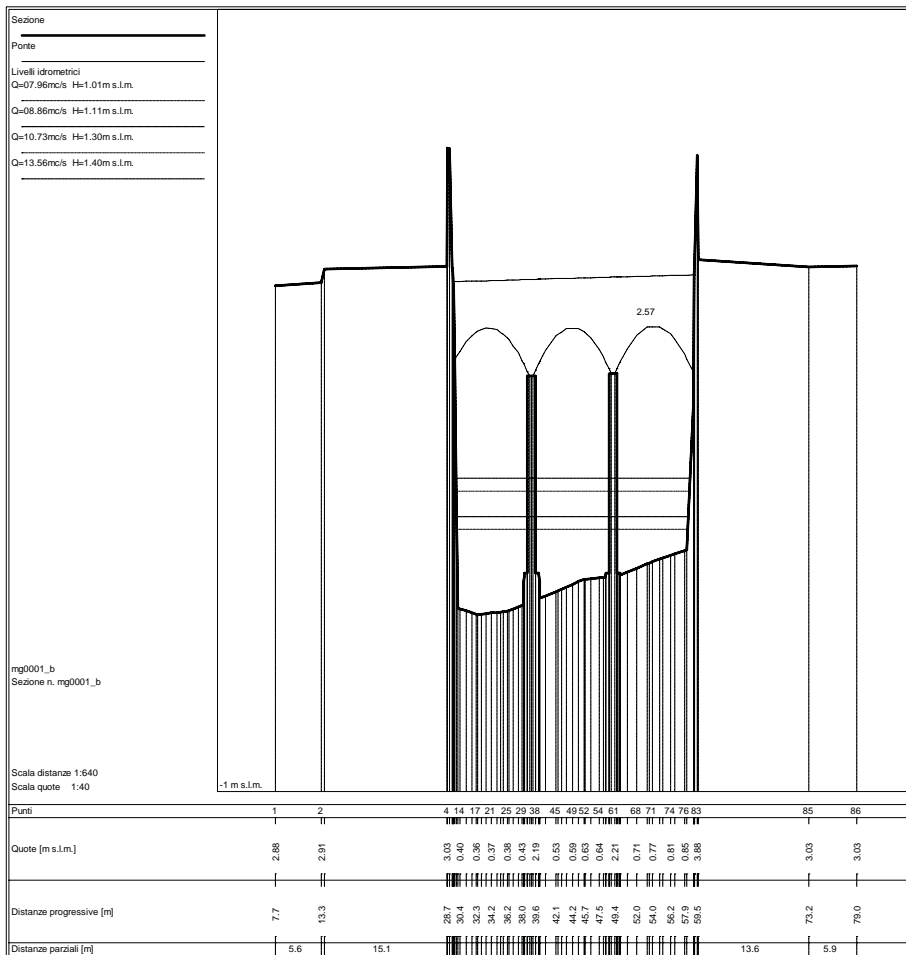
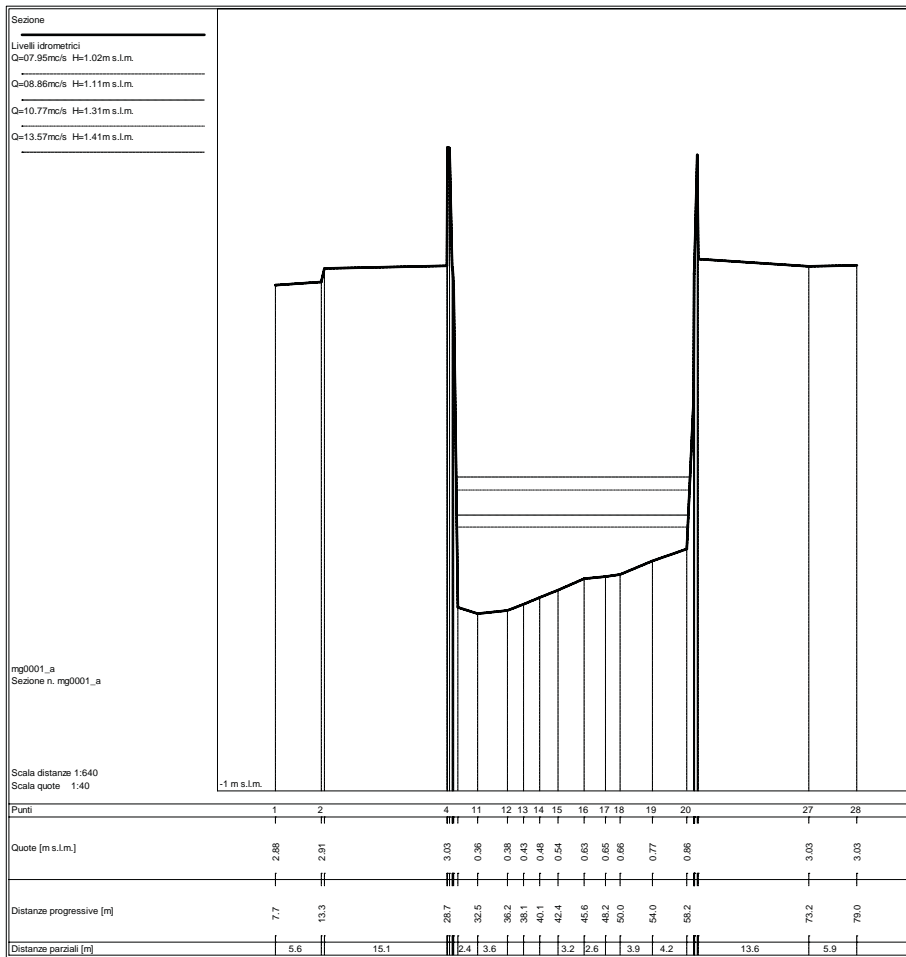

Sezione
 Ponte
 Livelli idrometrici
 Q=07.90mc/s H=1.00m s.Lm.
 Q=08.85mc/s H=1.10m s.Lm.
 Q=10.73mc/s H=1.30m s.Lm.
 Q=13.42mc/s H=1.40m s.Lm.

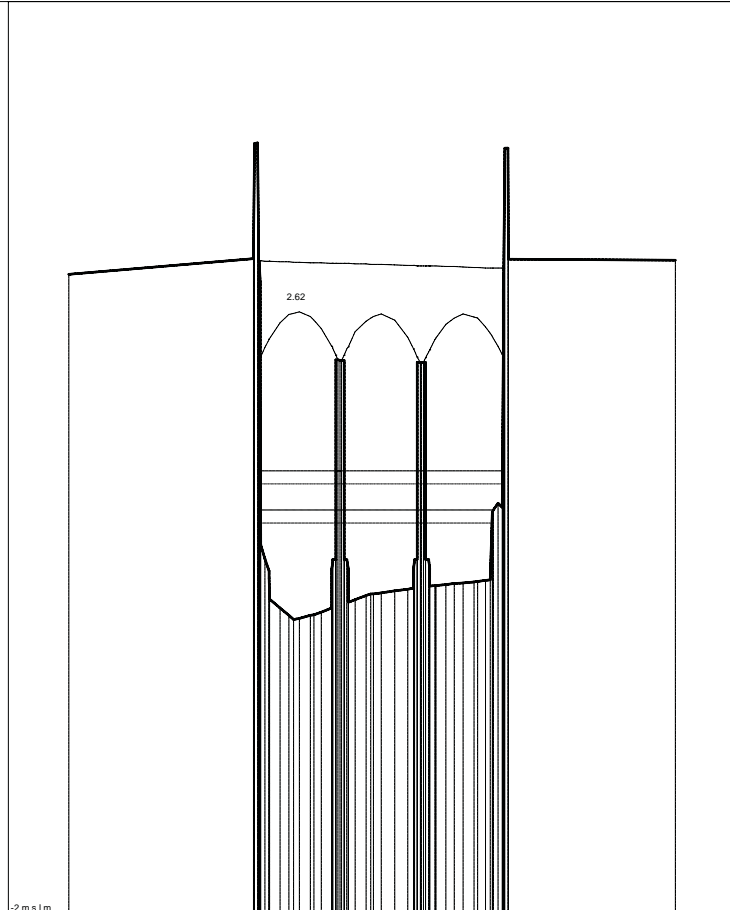

mg0001_c
 Sezione n. mg0001_c

Scala distanze 1:640
 Scala quote 1:40

Punti	1	2	12	16	19	22	33	37	40	41	42	49	56	59	61	64	69	76
Quote [m s.Lm.]	2.91	3.03	0.63	0.29	0.29	0.35	0.72	0.44	0.47	0.48	0.48	0.49	0.52	0.52	0.55	0.56	2.28	3.02
Distanze progressive [m]	3.0	25.6	27.5	30.0	32.6	35.3	37.1	38.5	41.3	43.0	44.6	46.3	47.9	50.3	52.7	54.7	56.3	77.5
Distanze parziali [m]		22.6																20.5

Sezione
 Livelli idrometrici
 Q=07.91mc/s H=1.00m s.Lm.
 Q=08.88mc/s H=1.10m s.Lm.
 Q=10.76mc/s H=1.30m s.Lm.
 Q=13.53mc/s H=1.40m s.Lm.

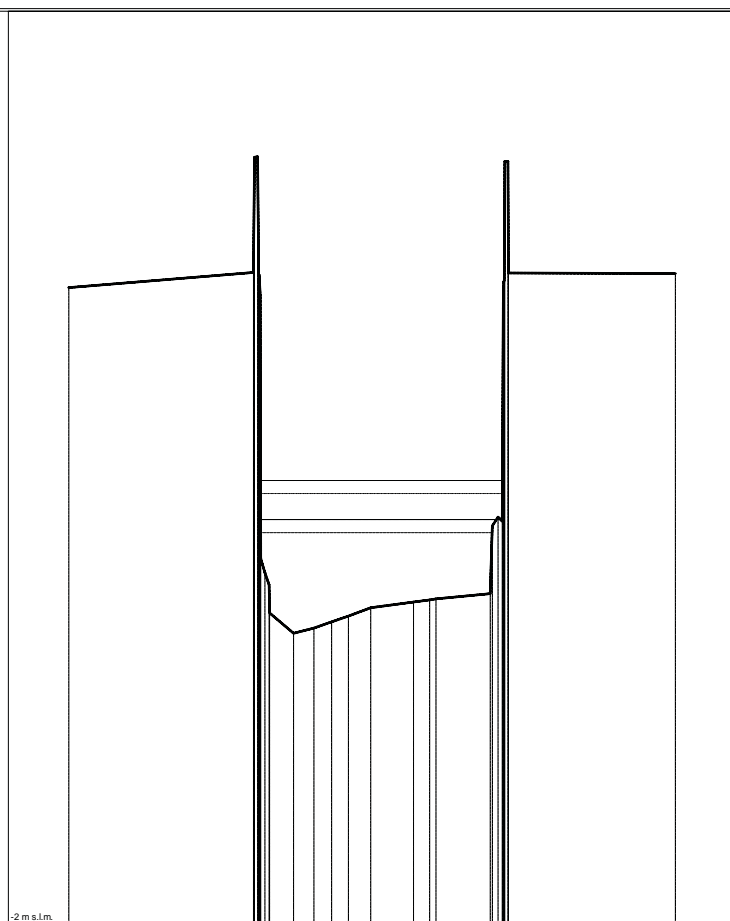

mg0001_d
 Sezione n. mg0001_d

Scala distanze 1:640
 Scala quote 1:40

Punti	1	2	9	12	13	14	15	16	17	18	20	24	30
Quote [m s.Lm.]	2.88	3.00	0.69	0.23	0.27	0.32	0.36	0.43	0.47	0.48	0.53	2.76	2.89
Distanze progressive [m]	3.0	25.6	27.1	30.6	33.0	35.3	37.3	40.1	45.3	47.3	54.7	56.3	77.5
Distanze parziali [m]		22.6	3.0	2.4		2.8		5.2			6.6		20.5

STATO ATTUALE

Sezioni fluviali canale delle Grondini – Grondini_01

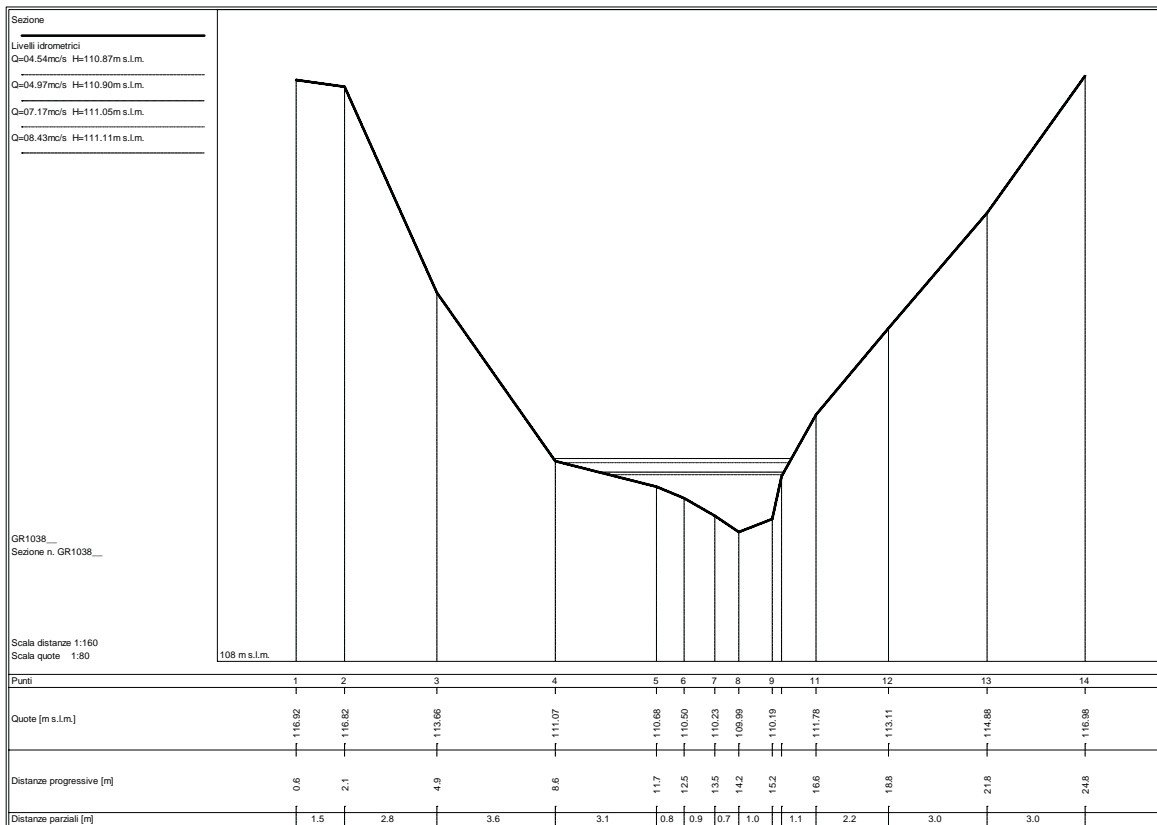
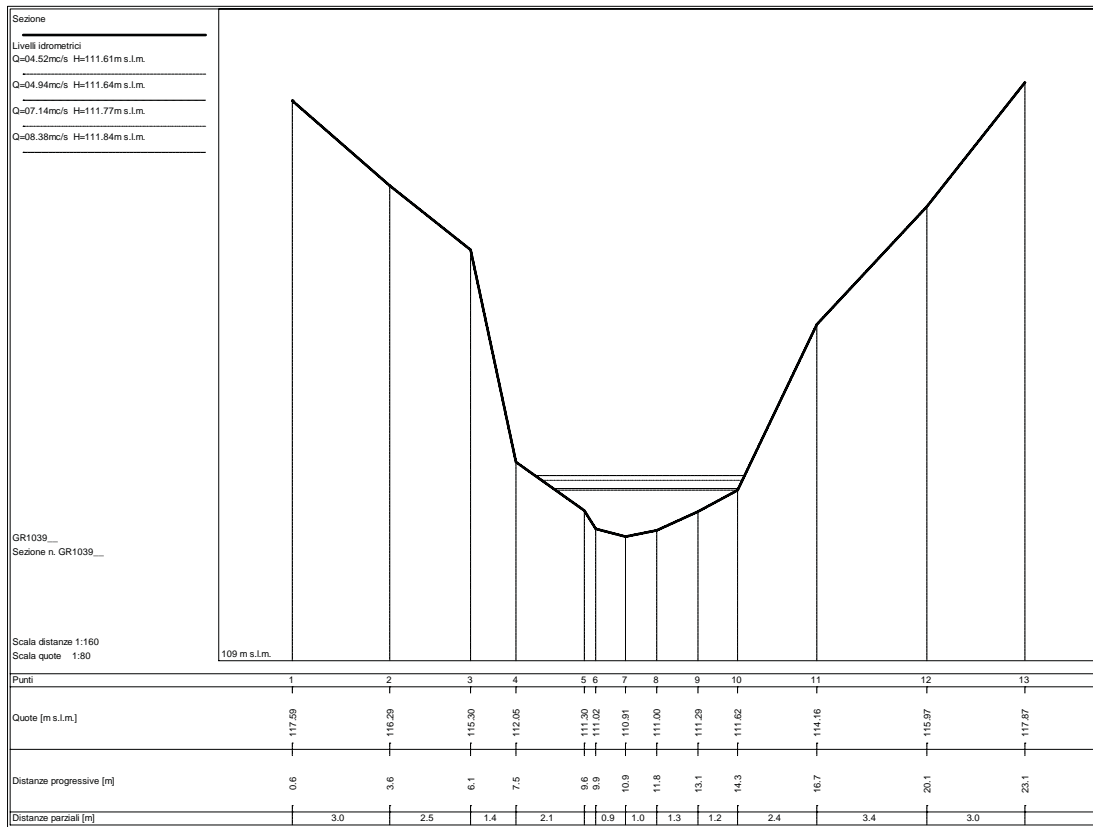

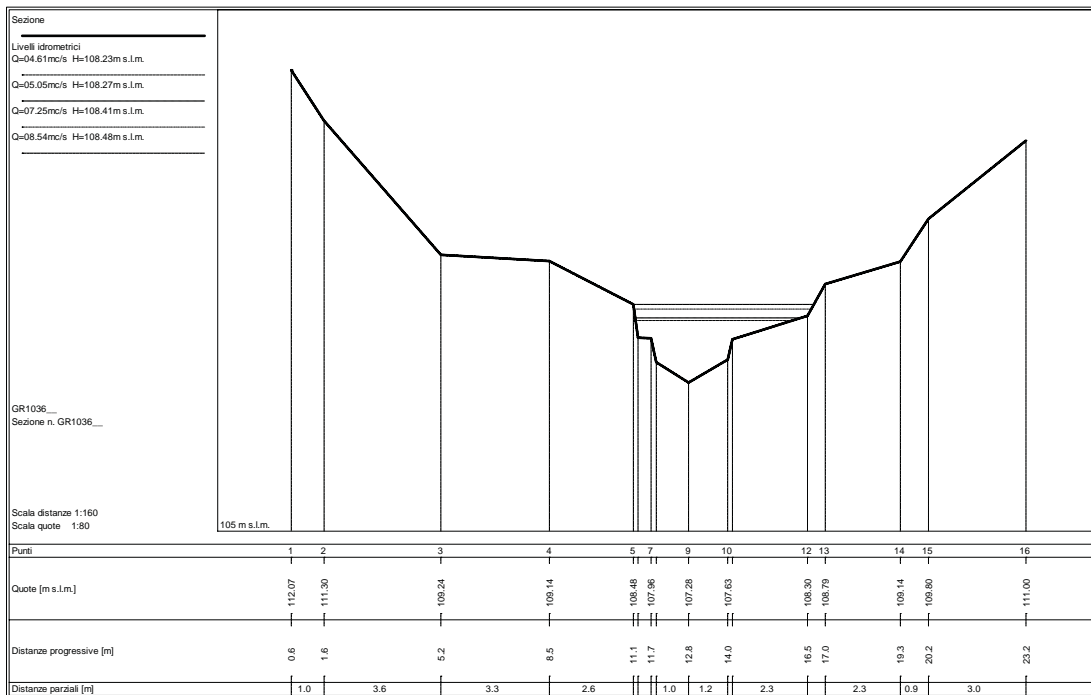
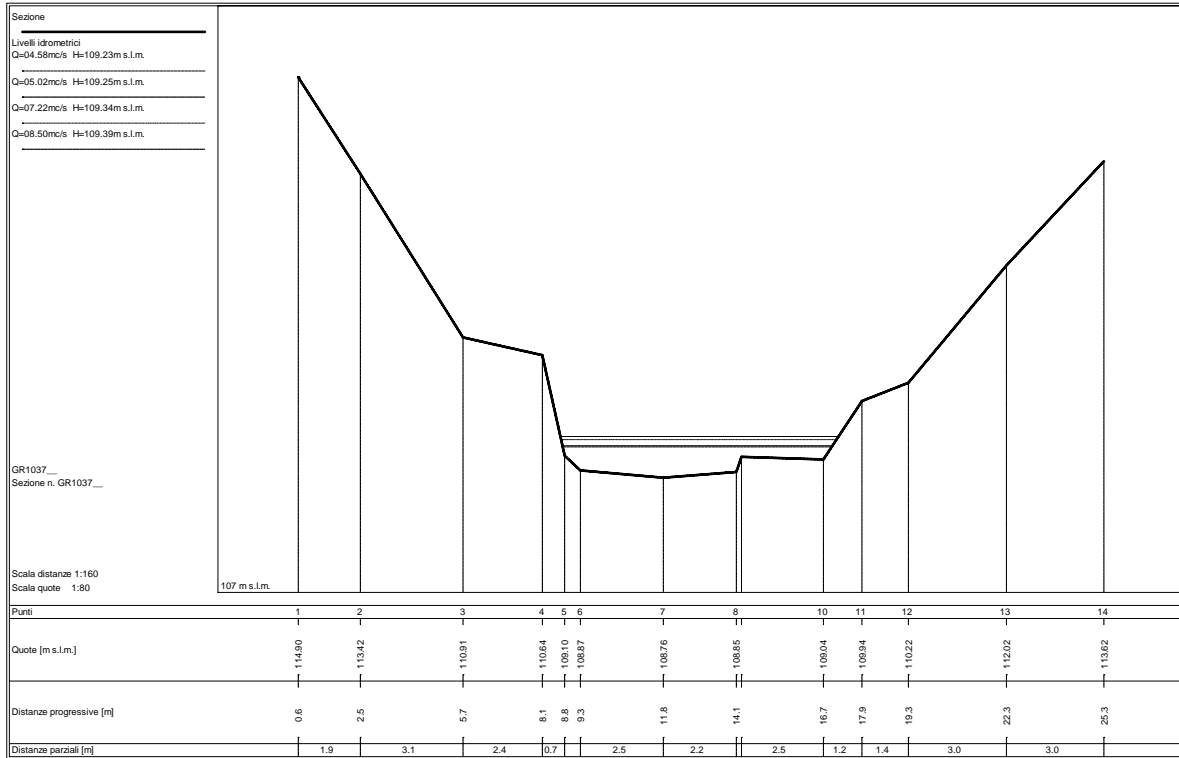

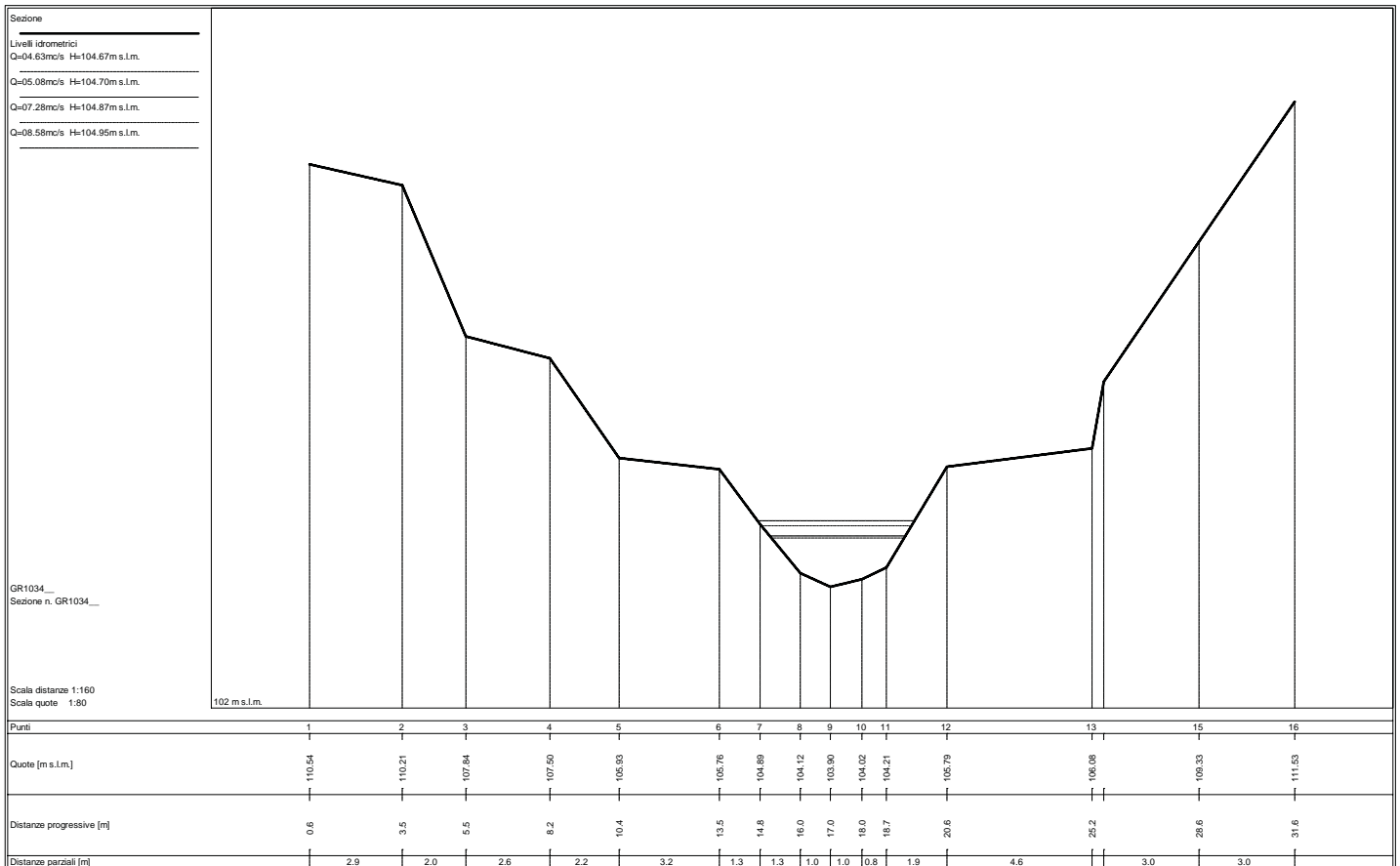
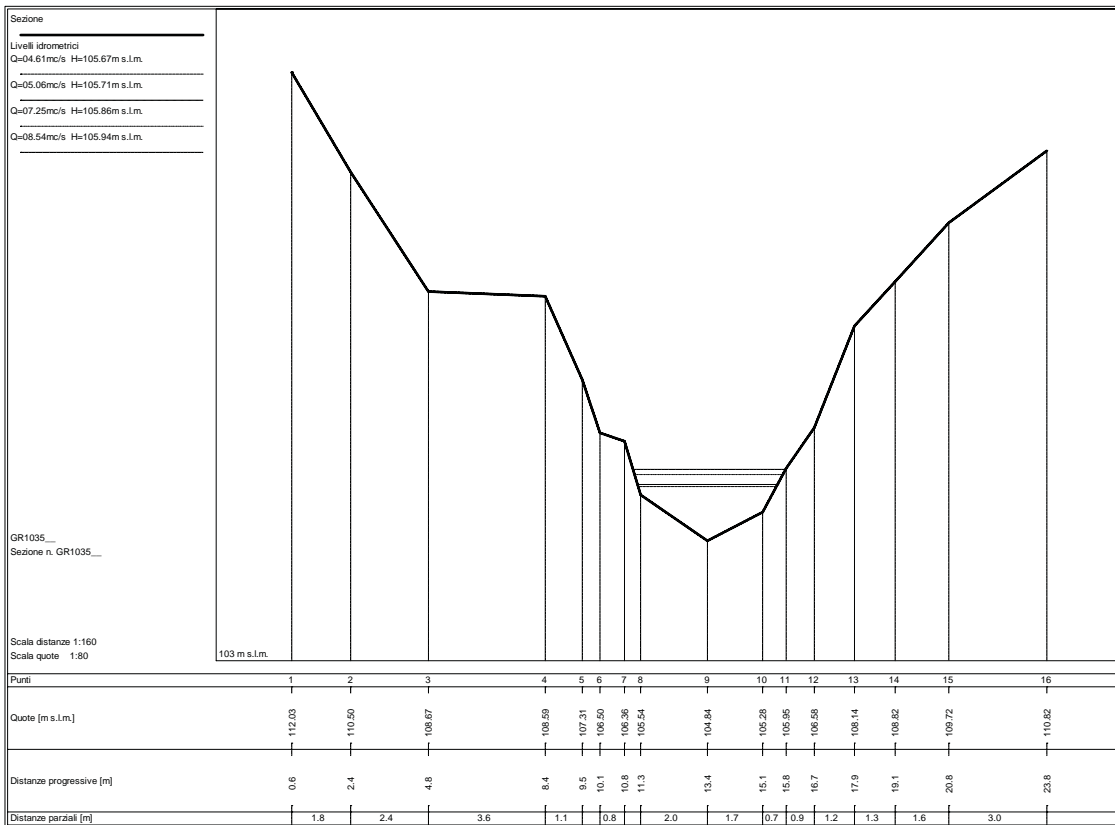

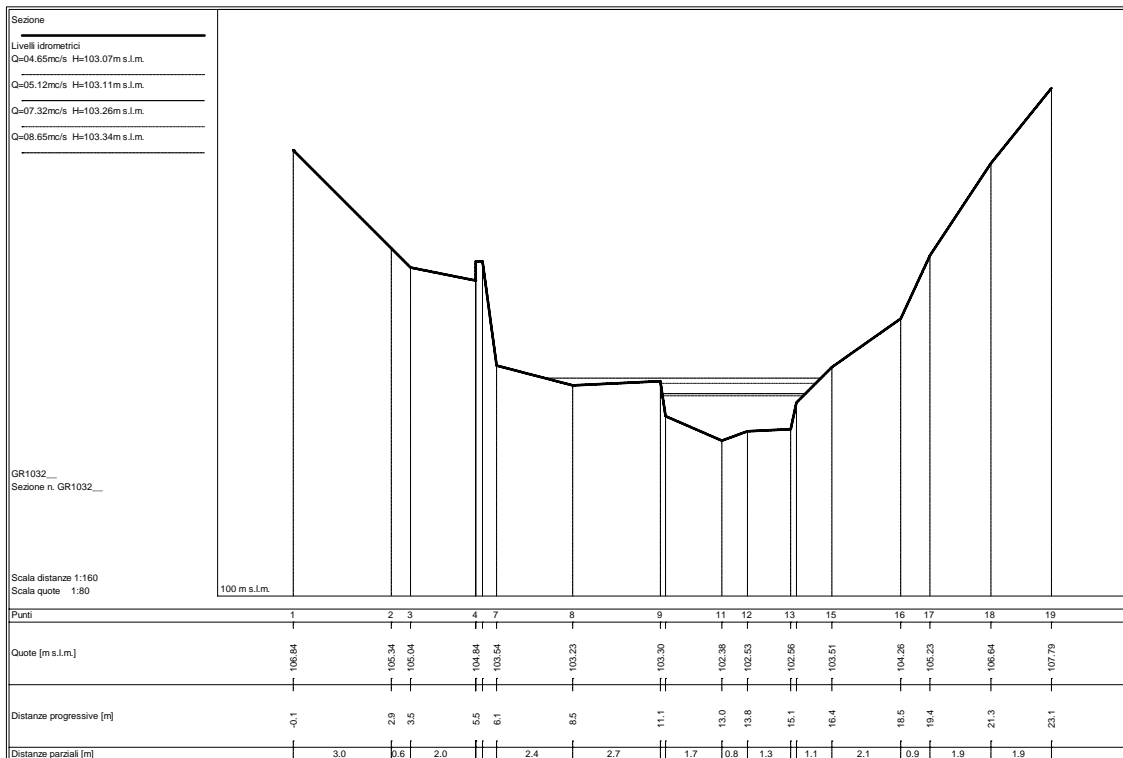
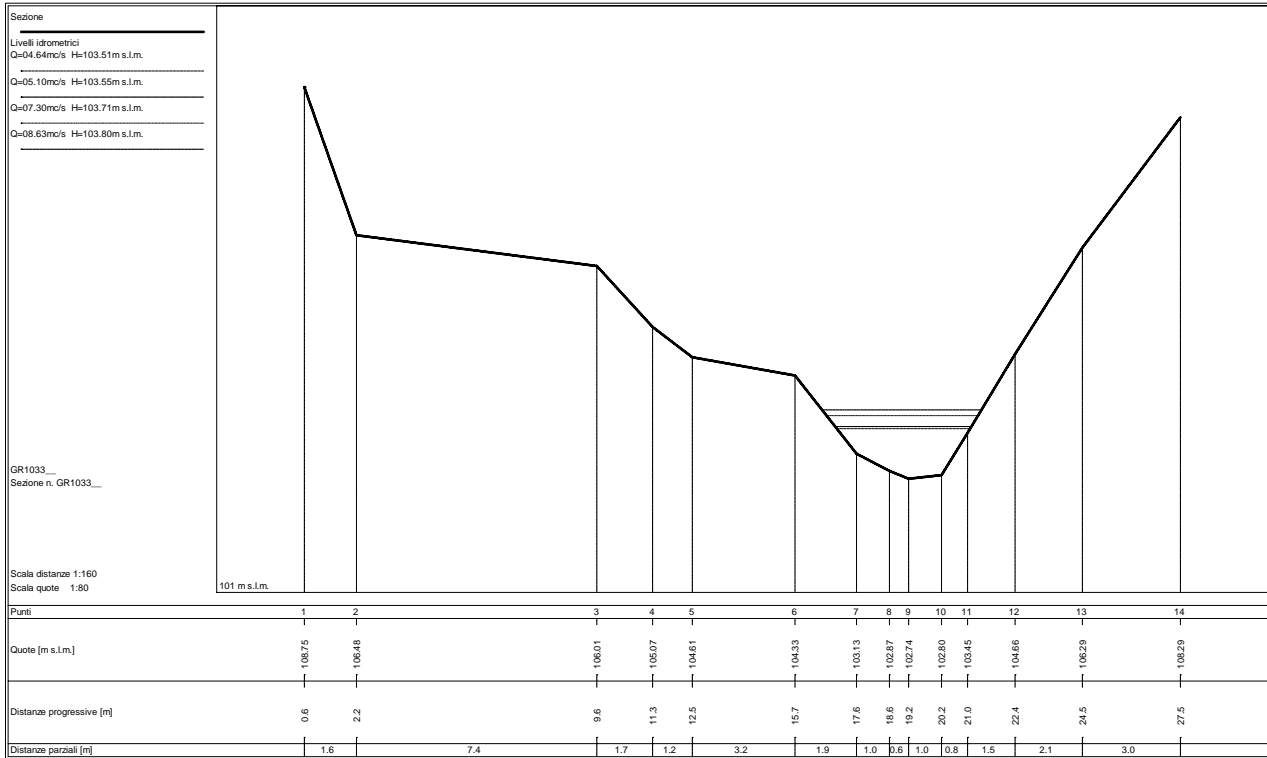

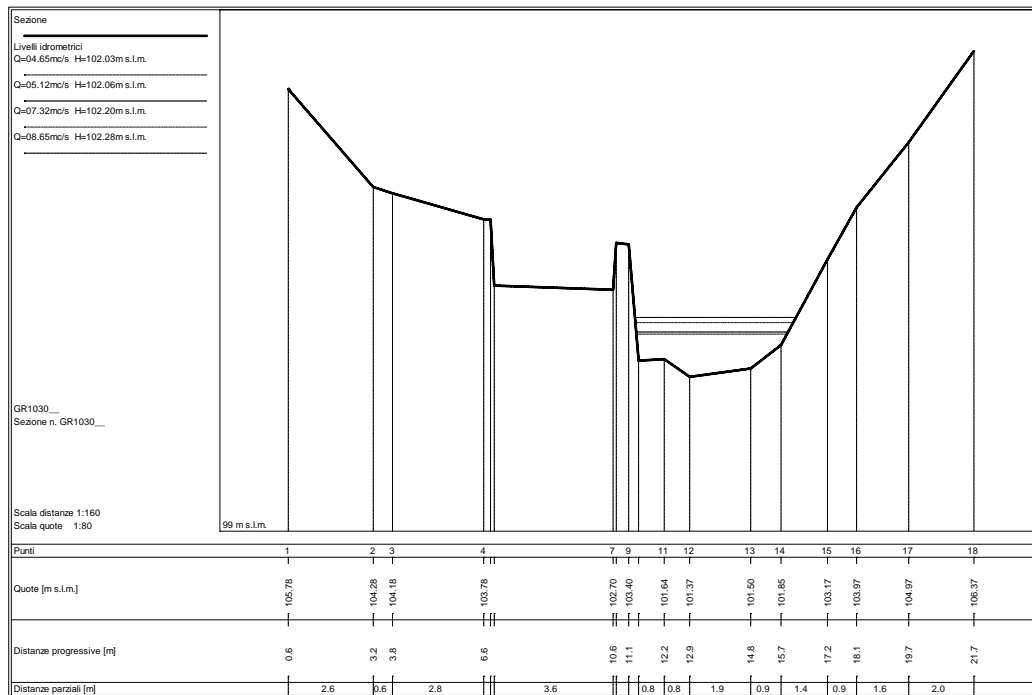
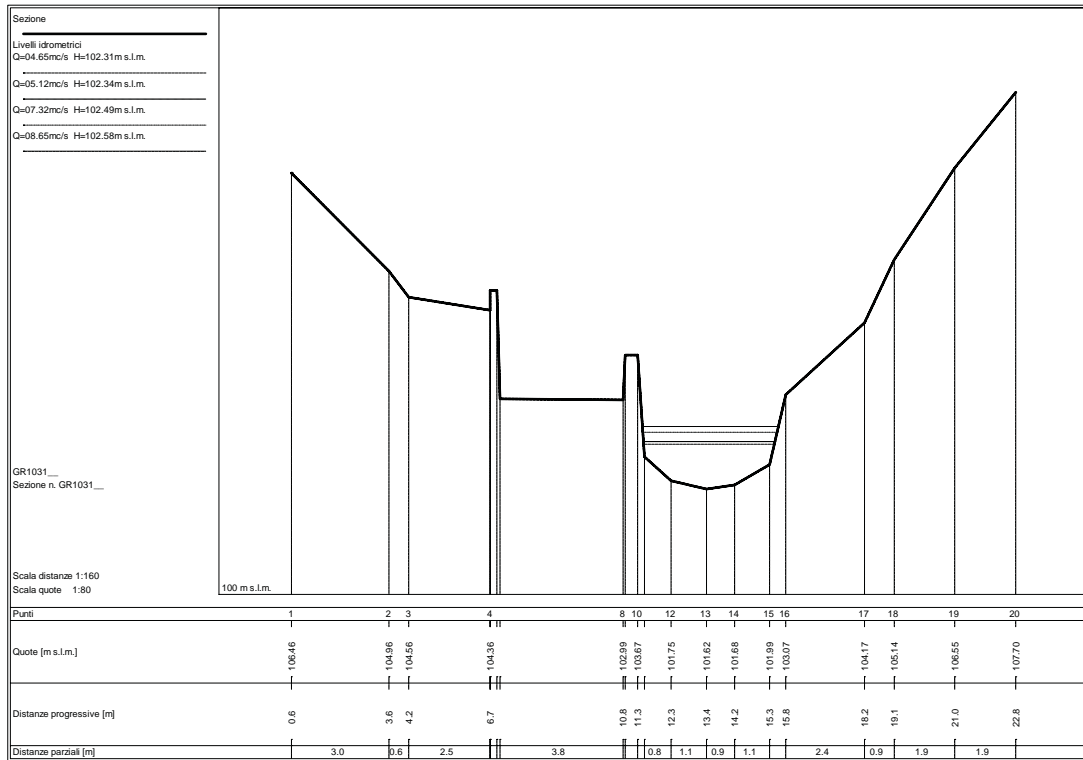

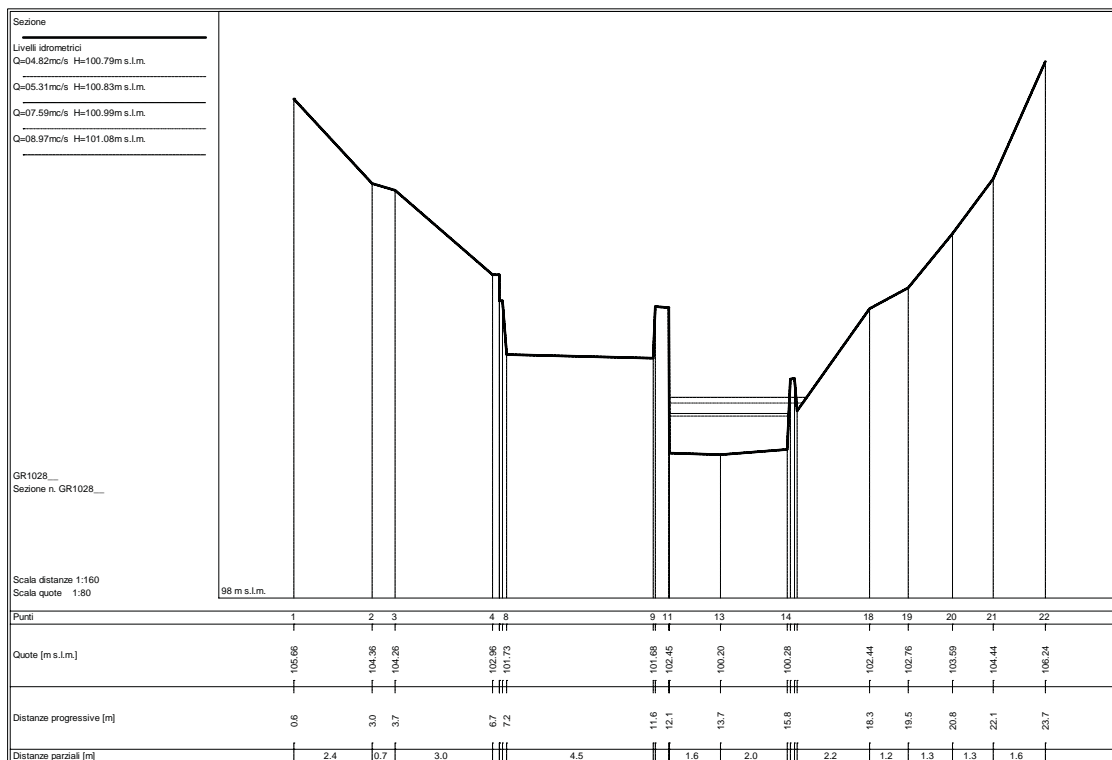
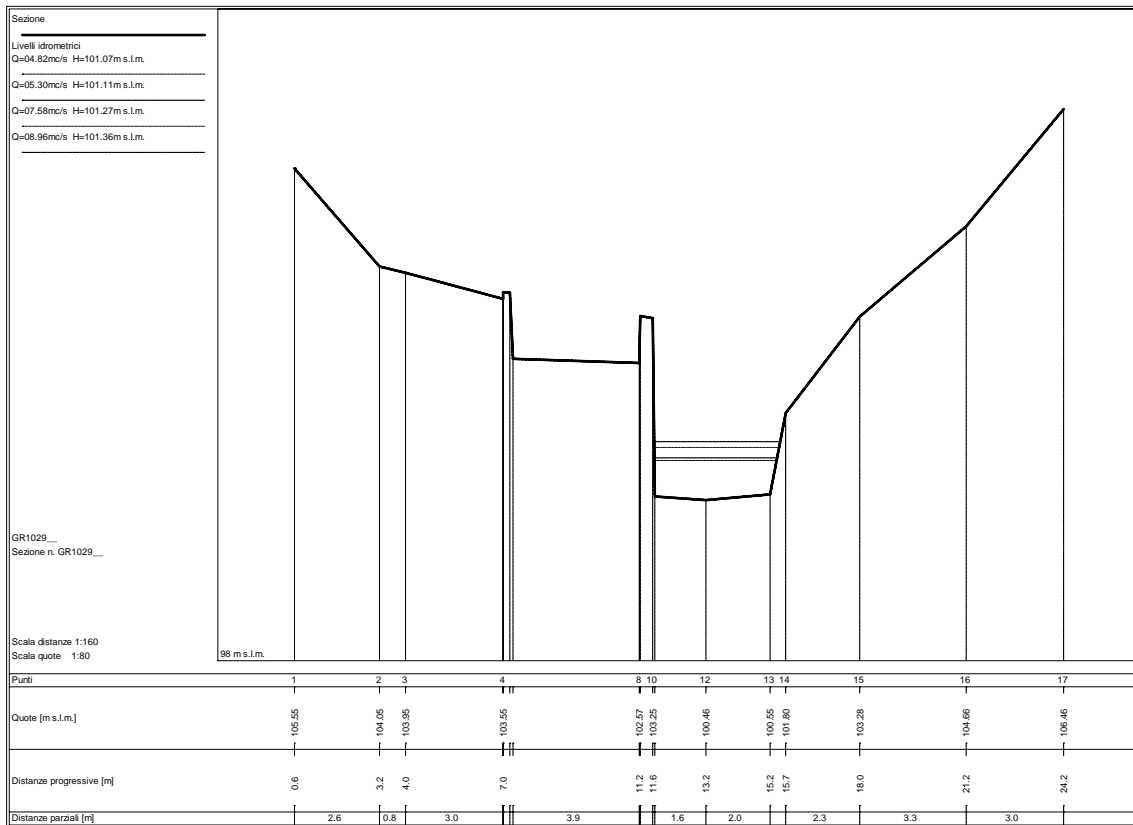

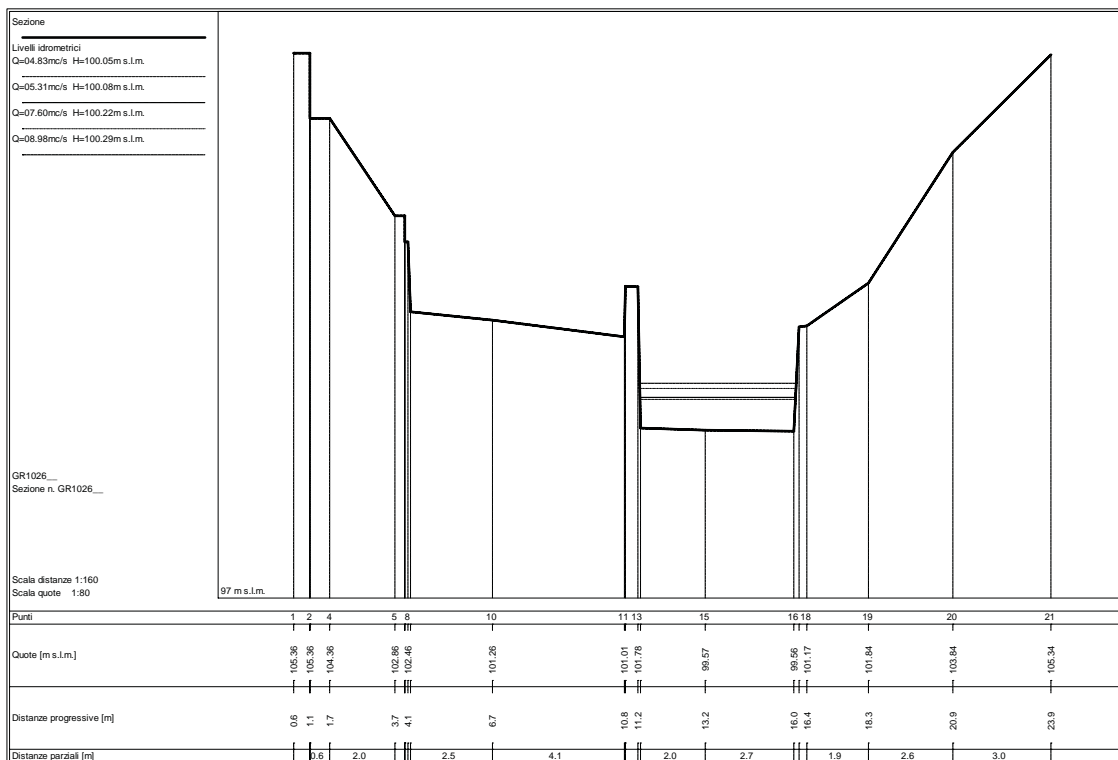
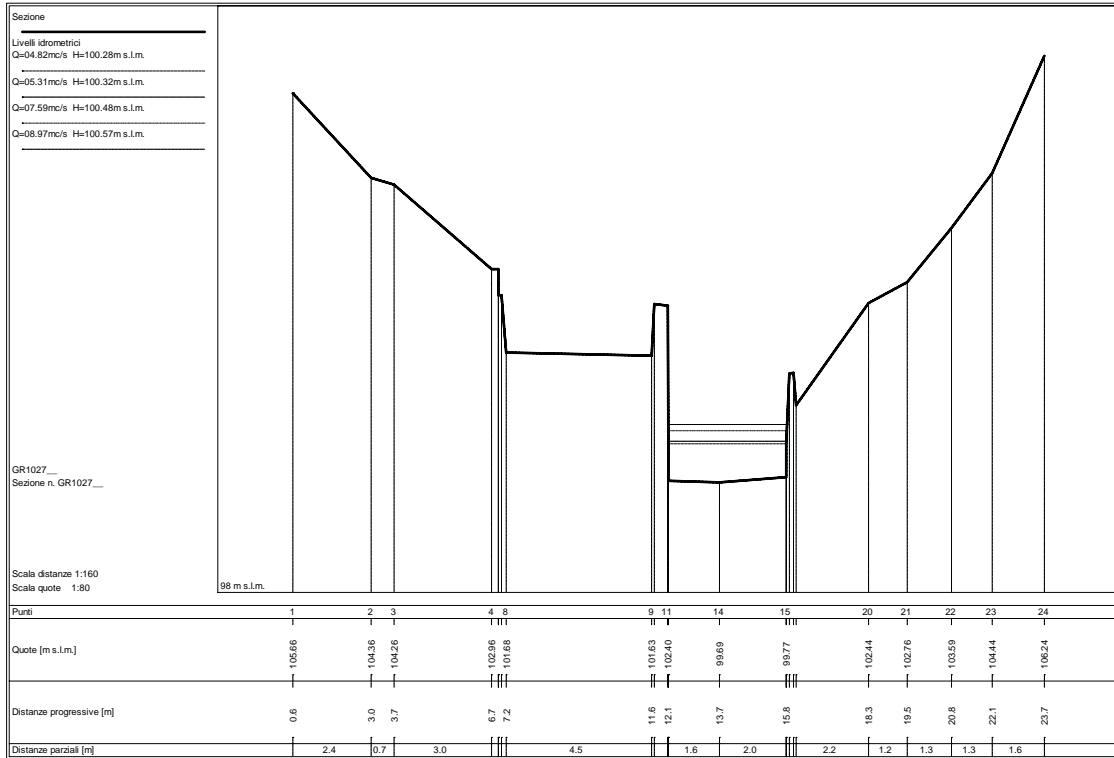

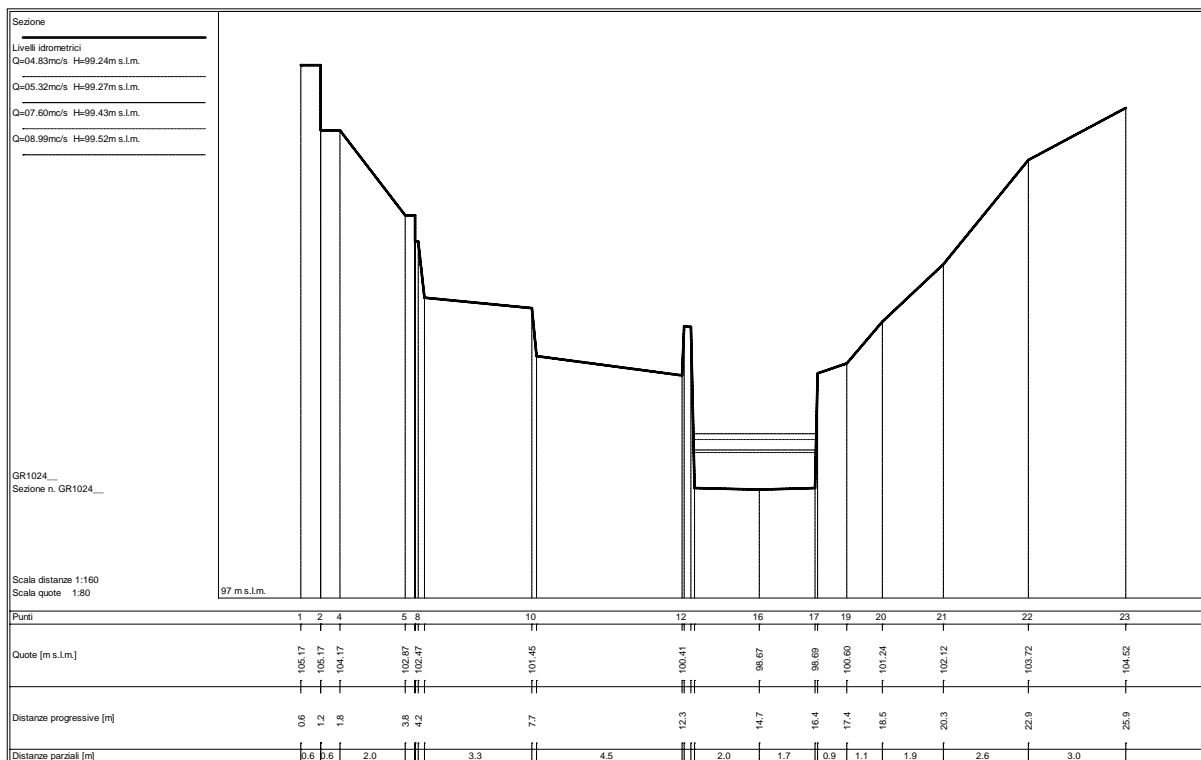
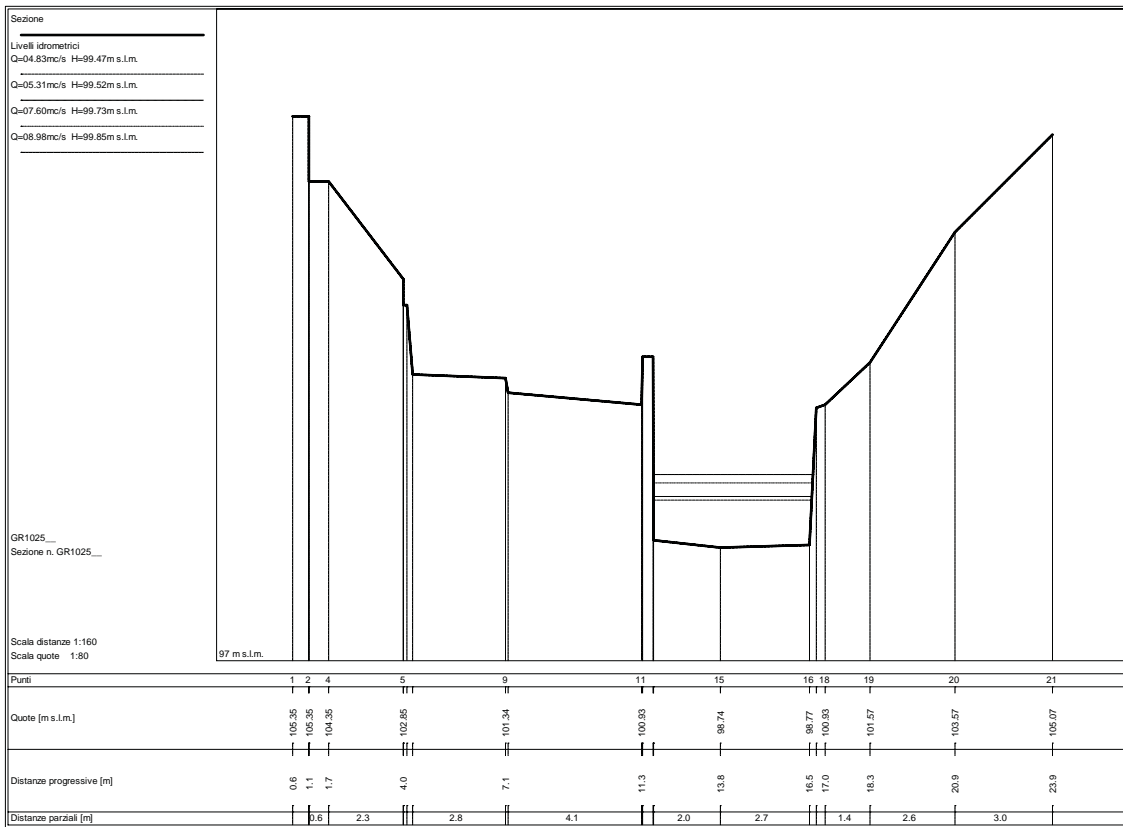

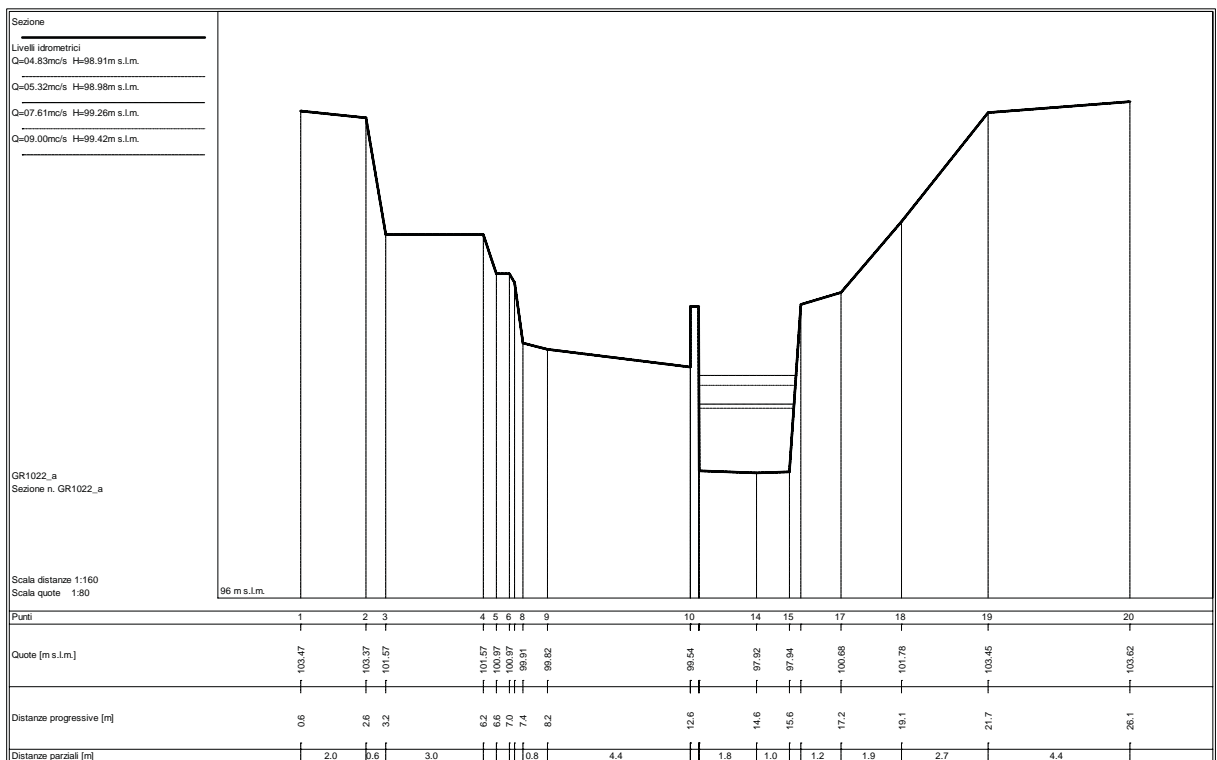
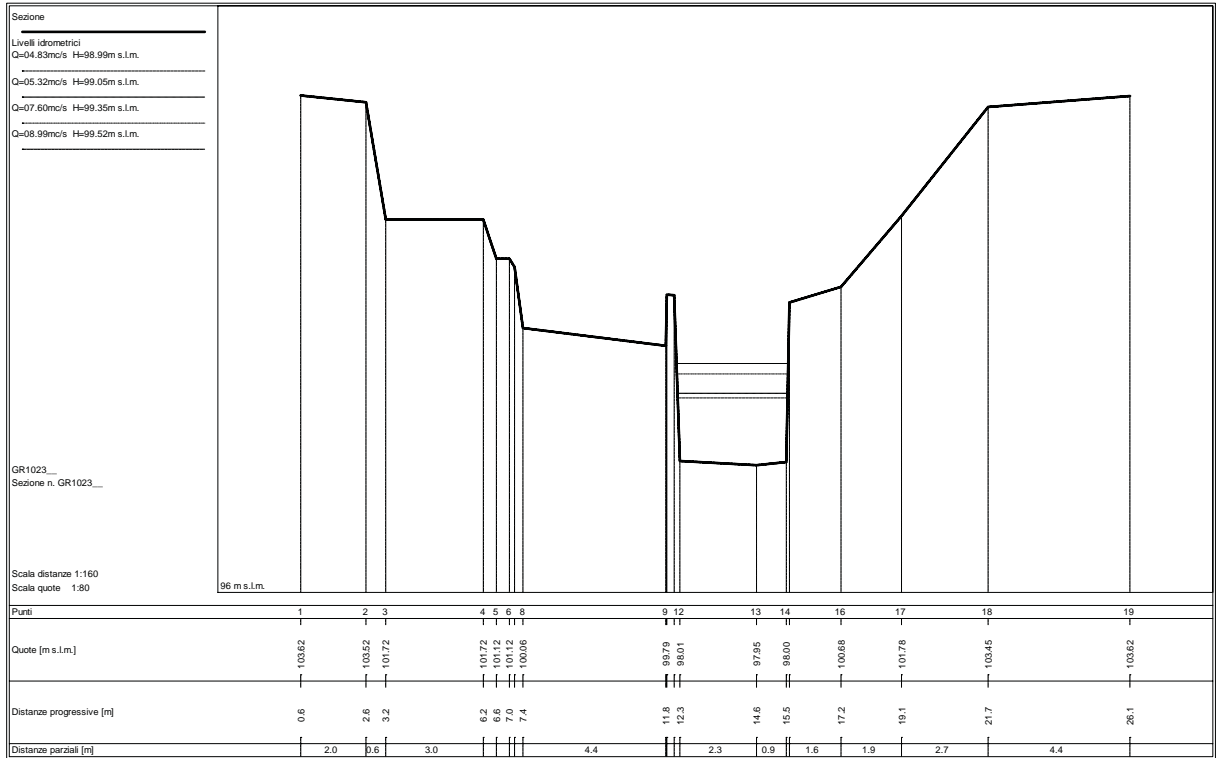

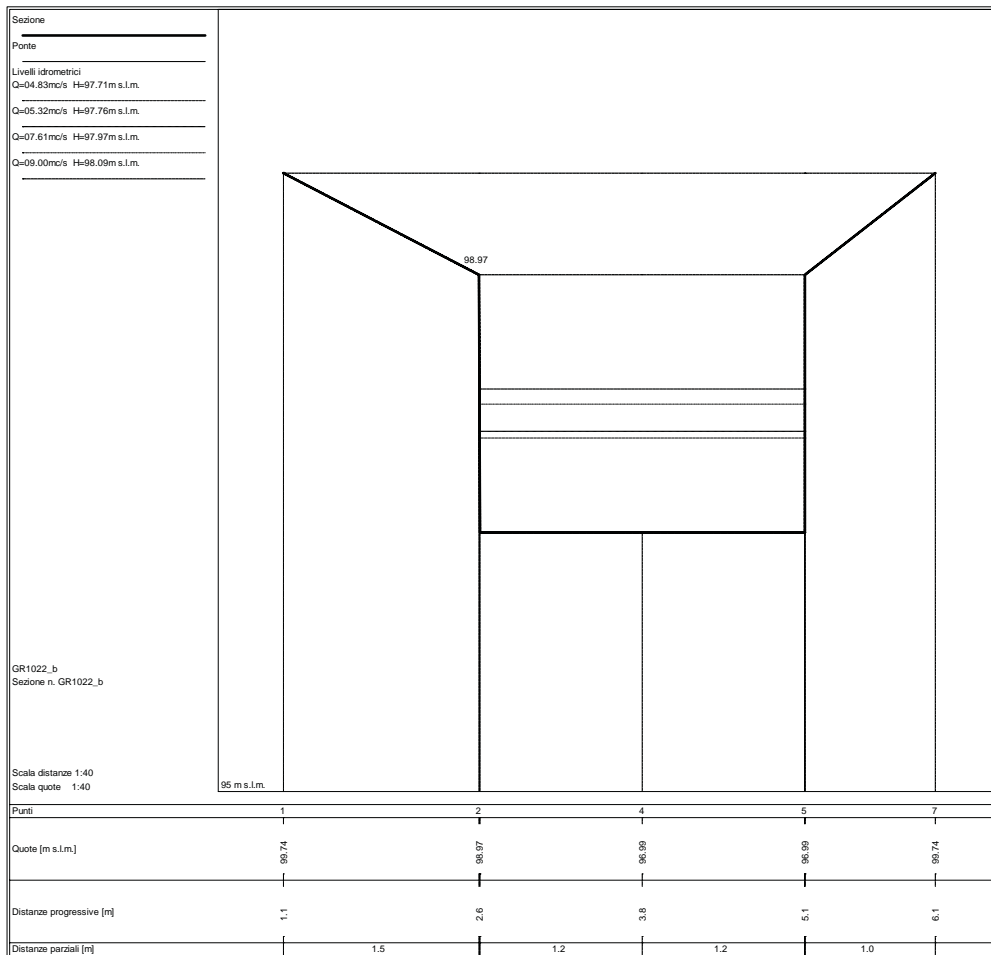
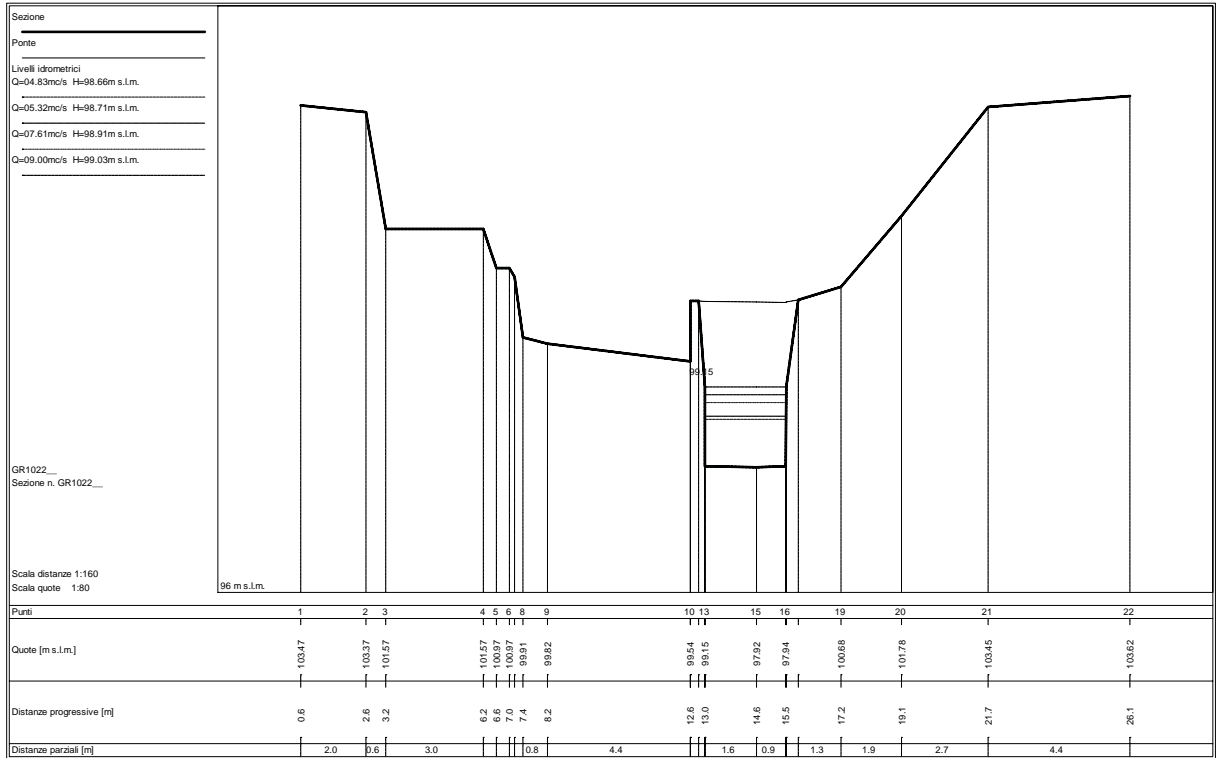

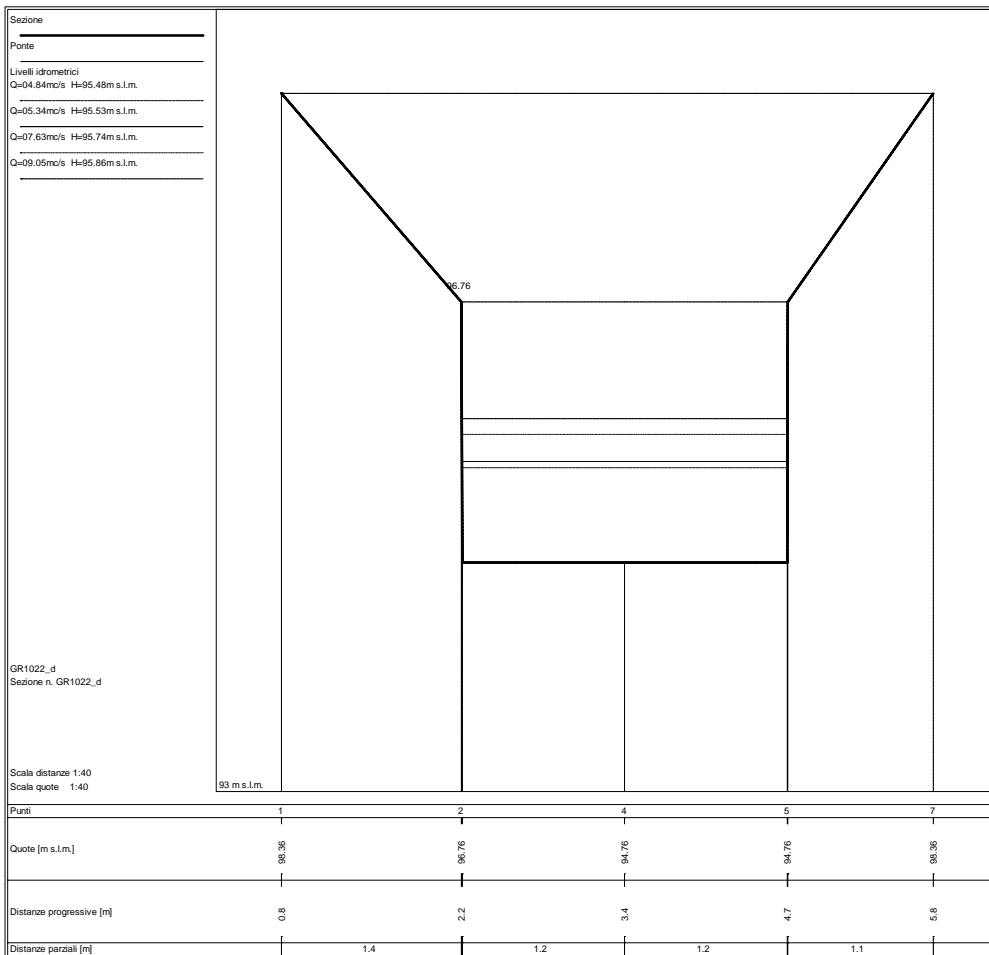
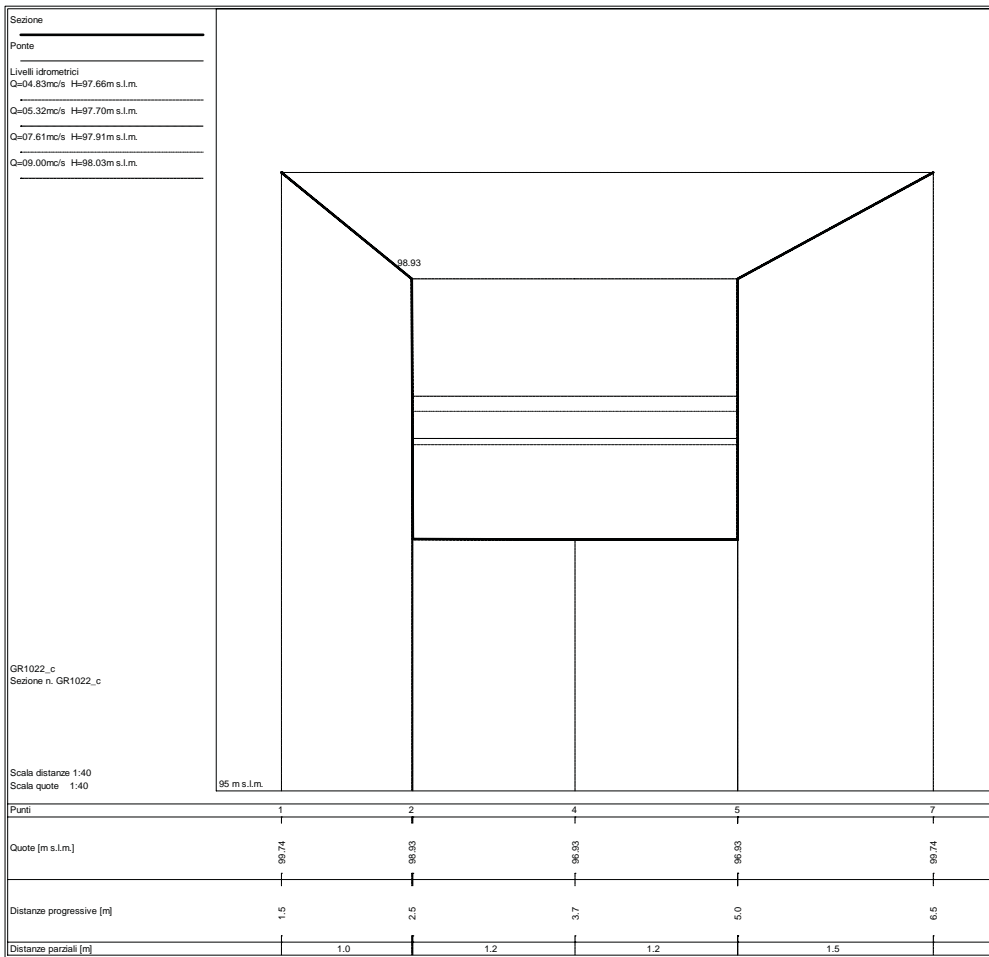

Sezione
 Ponte
 Livelli idrometrici
 Q=04.84mc/s H=94.84m s.l.m.
 Q=05.34mc/s H=94.87m s.l.m.
 Q=07.63mc/s H=95.09m s.l.m.
 Q=09.05mc/s H=95.27m s.l.m.

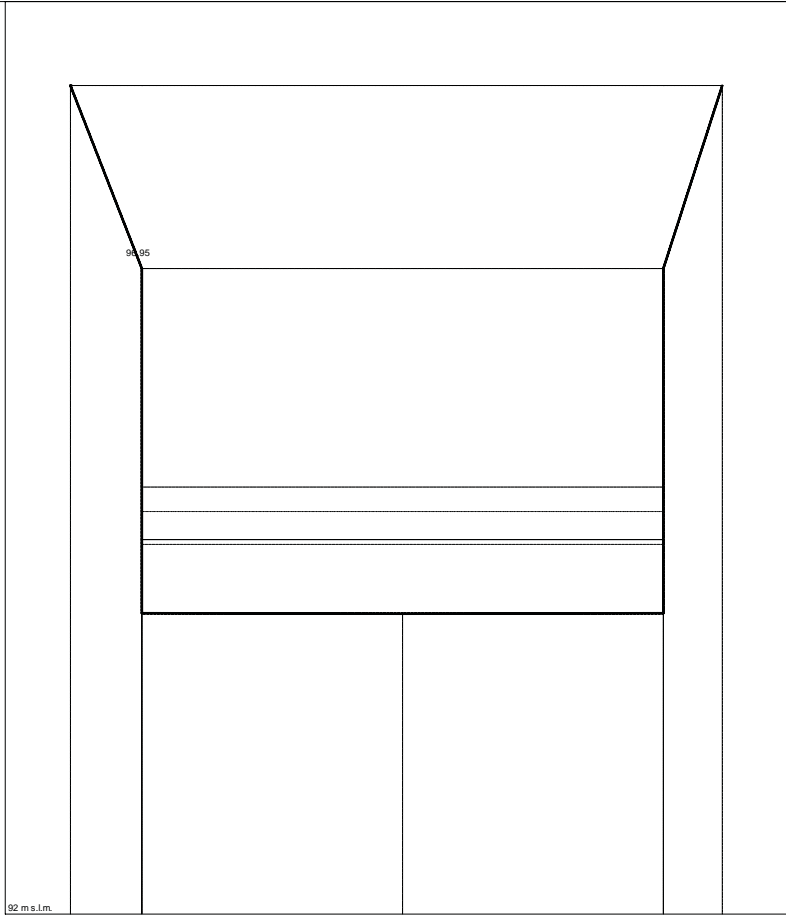

GR1022_e
 Sezione n. GR1022_e

Scala distanze 1:40
 Scala quote 1:40

Punti	1	2	4	5	7
Quote [m s.l.m.]	98.36	96.95	94.30	94.31	98.36
Distanze progressive [m]	0.9	1.5	3.5	5.5	5.9
Distanze parziali [m]	0.5	2.0	2.0	0.5	

Sezione
 Ponte
 Livelli idrometrici
 Q=04.84mc/s H=94.78m s.l.m.
 Q=05.34mc/s H=94.85m s.l.m.
 Q=07.63mc/s H=95.12m s.l.m.
 Q=09.05mc/s H=95.28m s.l.m.

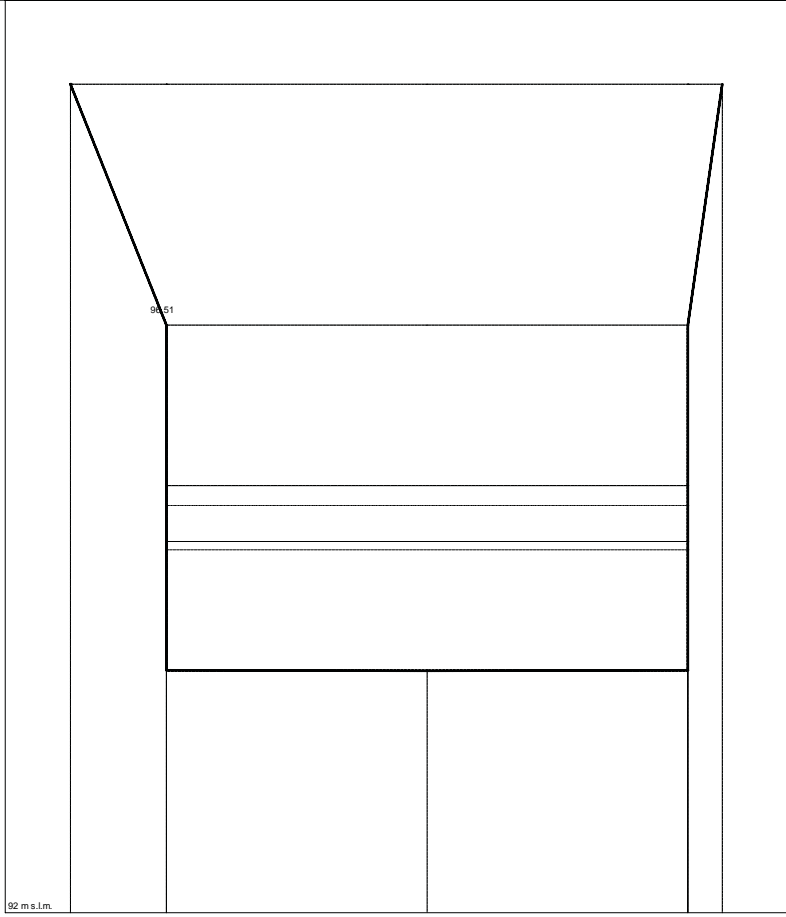

GR1022_f
 Sezione n. GR1022_f

Scala distanze 1:40
 Scala quote 1:40

Punti	1	2	4	5	7
Quote [m s.l.m.]	98.36	96.51	93.86	93.86	98.36
Distanze progressive [m]	0.8	1.6	3.6	5.6	5.8
Distanze parziali [m]	0.7	2.0	2.0	0.3	

Sezione
 Ponte
 Livelli idrometrici
 Q=04.84mc/s H=94.48m s.l.m.
 Q=05.34mc/s H=94.52m s.l.m.
 Q=07.63mc/s H=94.70m s.l.m.
 Q=09.05mc/s H=94.81m s.l.m.

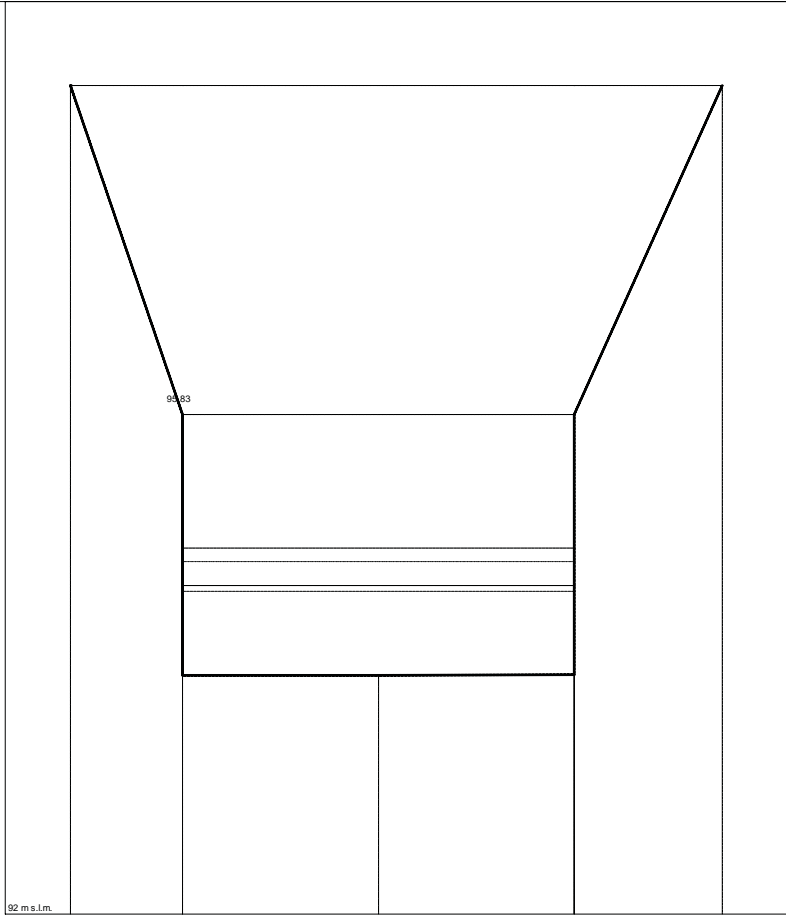

GR1022_g
 Sezione n. GR1022_g

Scala distanze 1:40
 Scala quote 1:40

Punti	1	2	4	5	7
Quote [m s.l.m.]	98.36	95.83	93.83	93.83	98.36
Distanze progressive [m]	0.8	1.7	3.2	4.7	5.8
Distanze parziali [m]		0.9	1.5	1.5	1.1

Sezione
 Ponte
 Livelli idrometrici
 Q=04.84mc/s H=93.10m s.l.m.
 Q=05.35mc/s H=93.15m s.l.m.
 Q=07.63mc/s H=93.38m s.l.m.
 Q=09.07mc/s H=93.51m s.l.m.

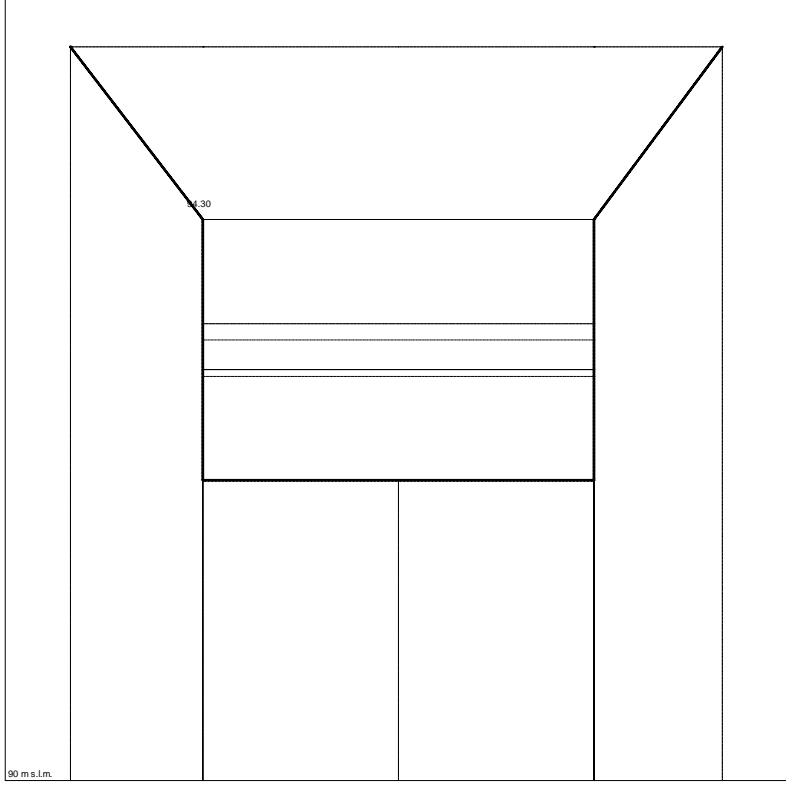

GR1022_h
 Sezione n. GR1022_h

Scala distanze 1:40
 Scala quote 1:40

Punti	1	2	4	5	7
Quote [m s.l.m.]	95.63	94.30	92.30	92.31	95.63
Distanze progressive [m]	1.0	2.0	3.5	5.0	6.0
Distanze parziali [m]		1.0	1.5	1.5	1.0

STATO ATTUALE

Sezioni fluviali canale delle Grondini – Grondini_02

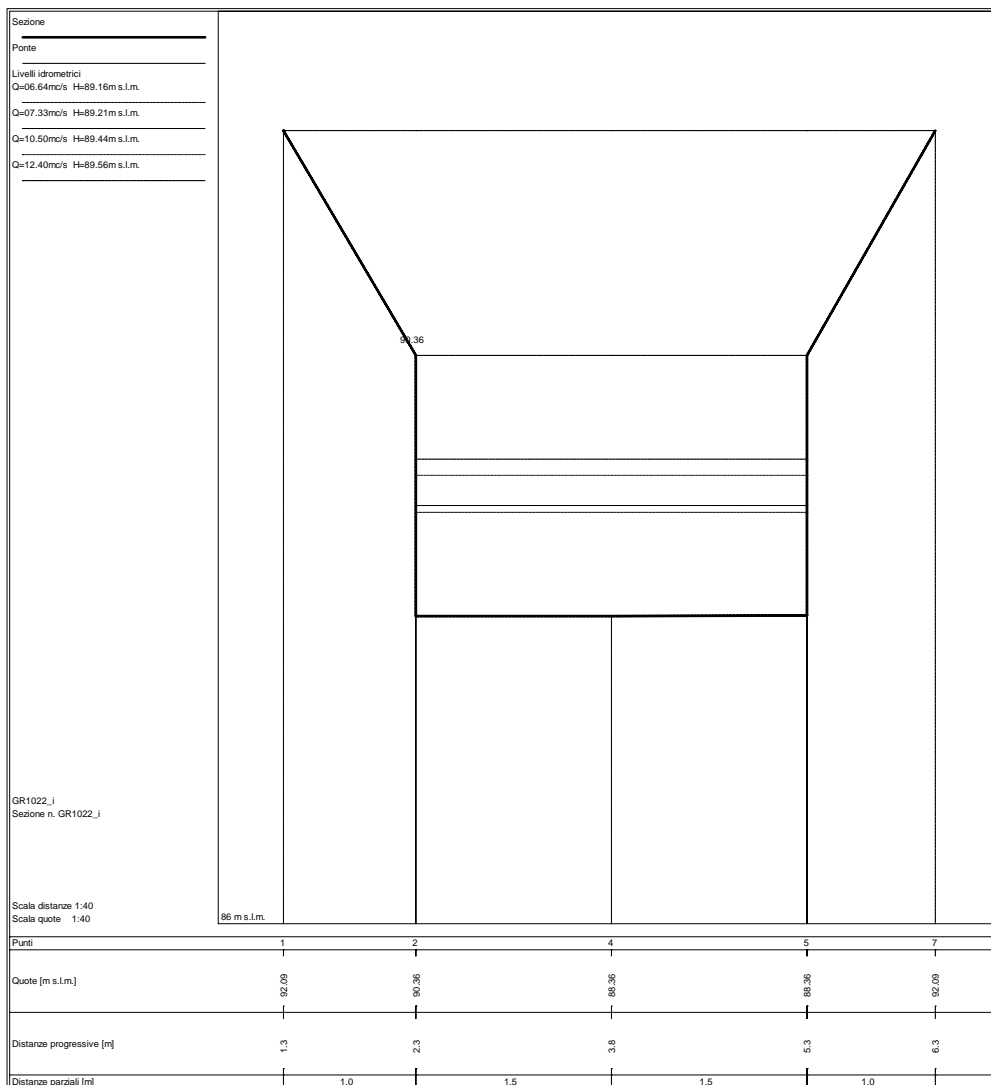
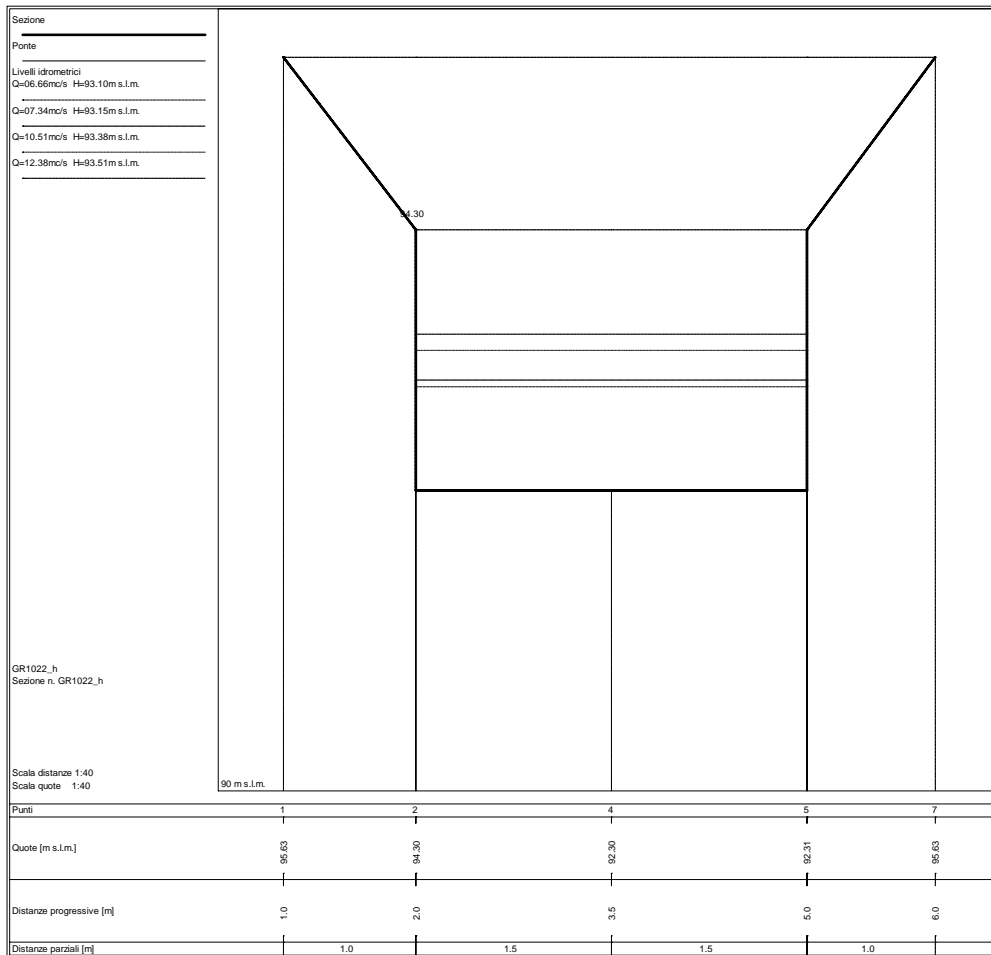

Sezione
 Ponte
 Livelli idrometrici
 Q=06.63mc/s H=86.88m s.l.m.
 Q=07.33mc/s H=86.94m s.l.m.
 Q=10.49mc/s H=87.17m s.l.m.
 Q=12.41mc/s H=87.29m s.l.m.

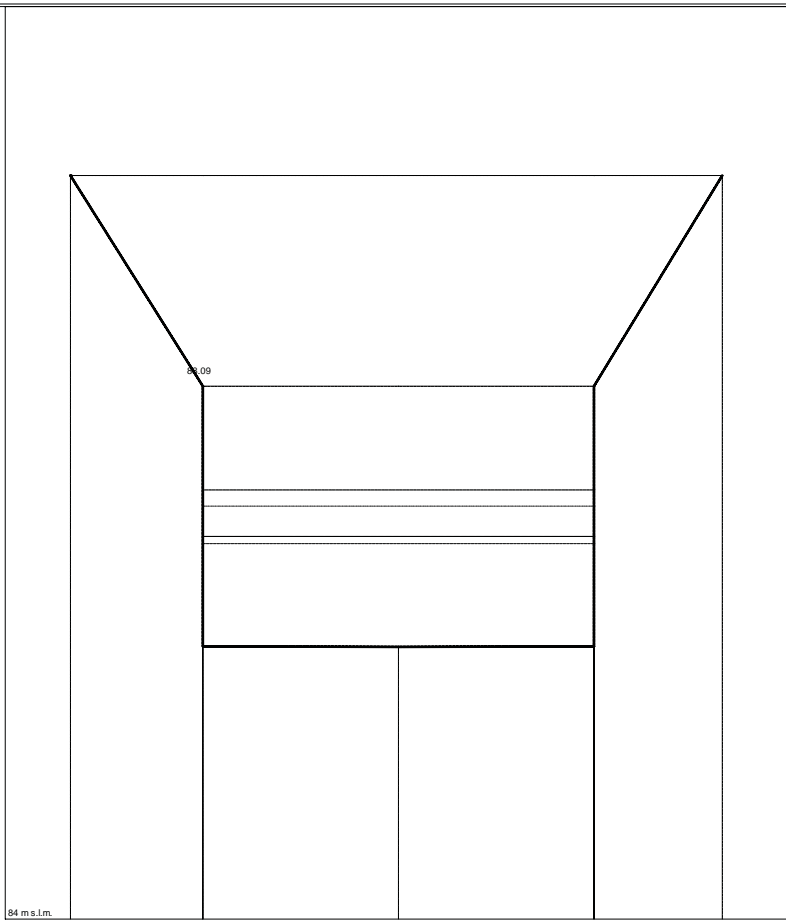

GR1022_I
 Sezione n. GR1022_I

Scala distanze 1:40
 Scala quote 1:40

Punti	1	2	4	5	7
Quote [m s.l.m.]	86.70	86.09	86.09	86.09	86.70
Distanze progressive [m]	1.2	2.2	3.7	5.2	6.2
Distanze parziali [m]		1.0	1.5	1.5	1.0

Sezione
 Ponte
 Livelli idrometrici
 Q=06.60mc/s H=83.26m s.l.m.
 Q=07.31mc/s H=83.32m s.l.m.
 Q=10.47mc/s H=83.55m s.l.m.
 Q=12.42mc/s H=83.67m s.l.m.

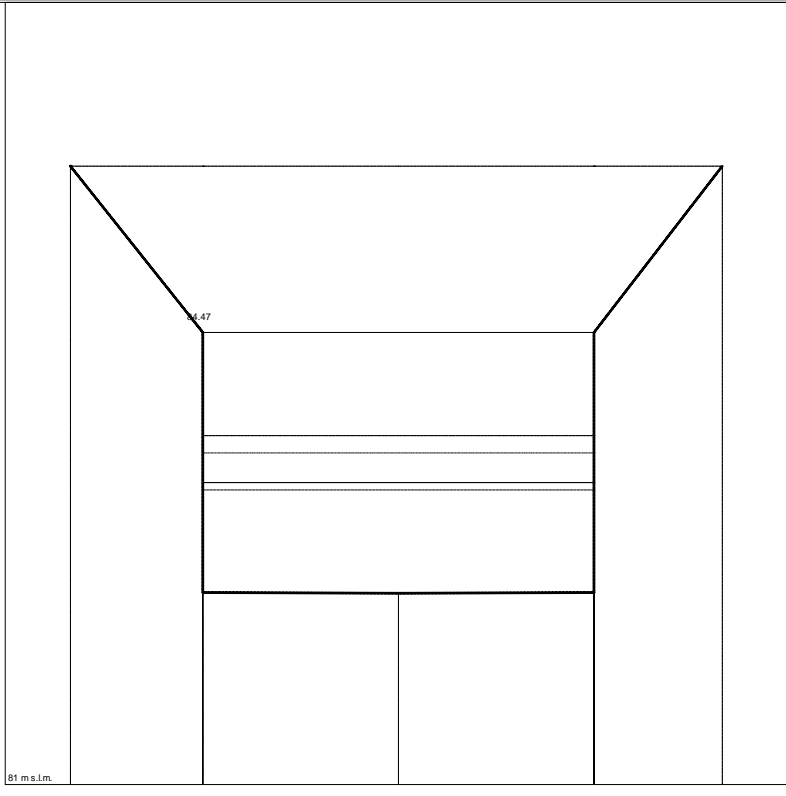

GR1022_m
 Sezione n. GR1022_m

Scala distanze 1:40
 Scala quote 1:40

Punti	1	2	4	5	7
Quote [m s.l.m.]	85.74	84.47	82.47	82.47	85.74
Distanze progressive [m]	0.5	1.5	3.0	4.5	5.5
Distanze parziali [m]		1.0	1.5	1.5	1.0

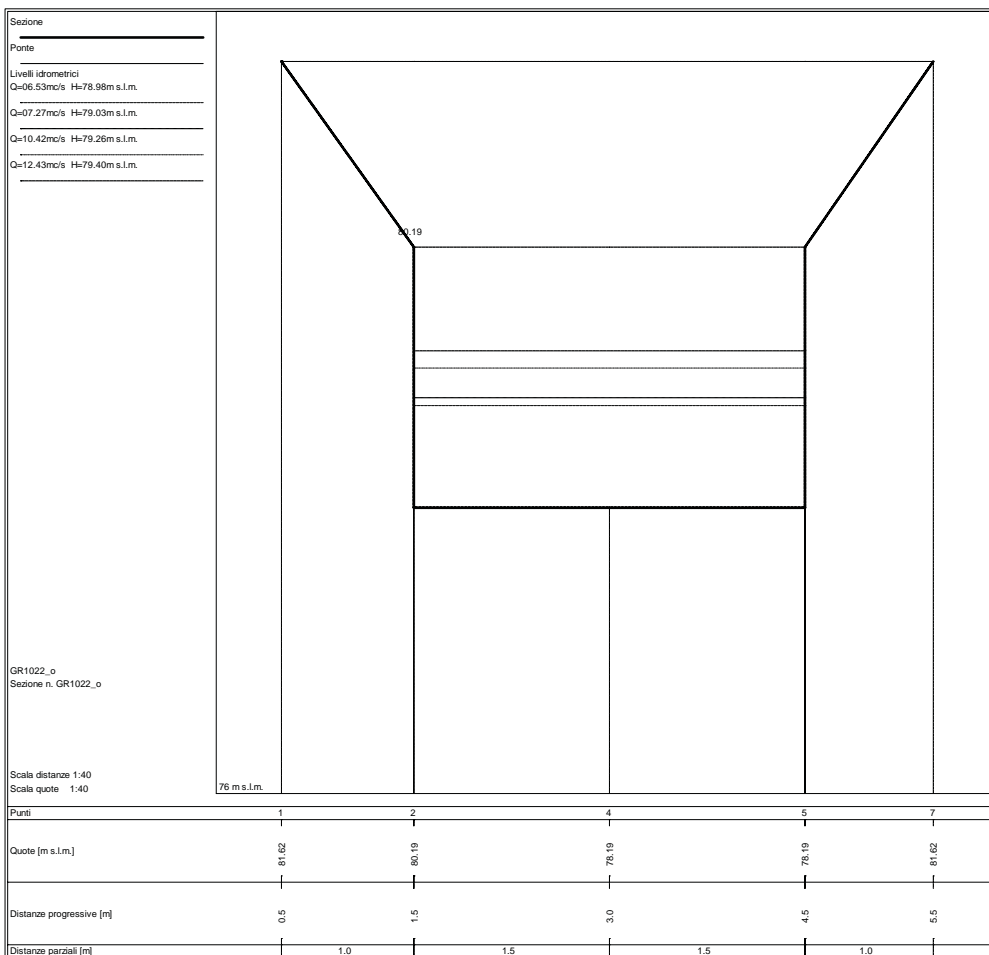
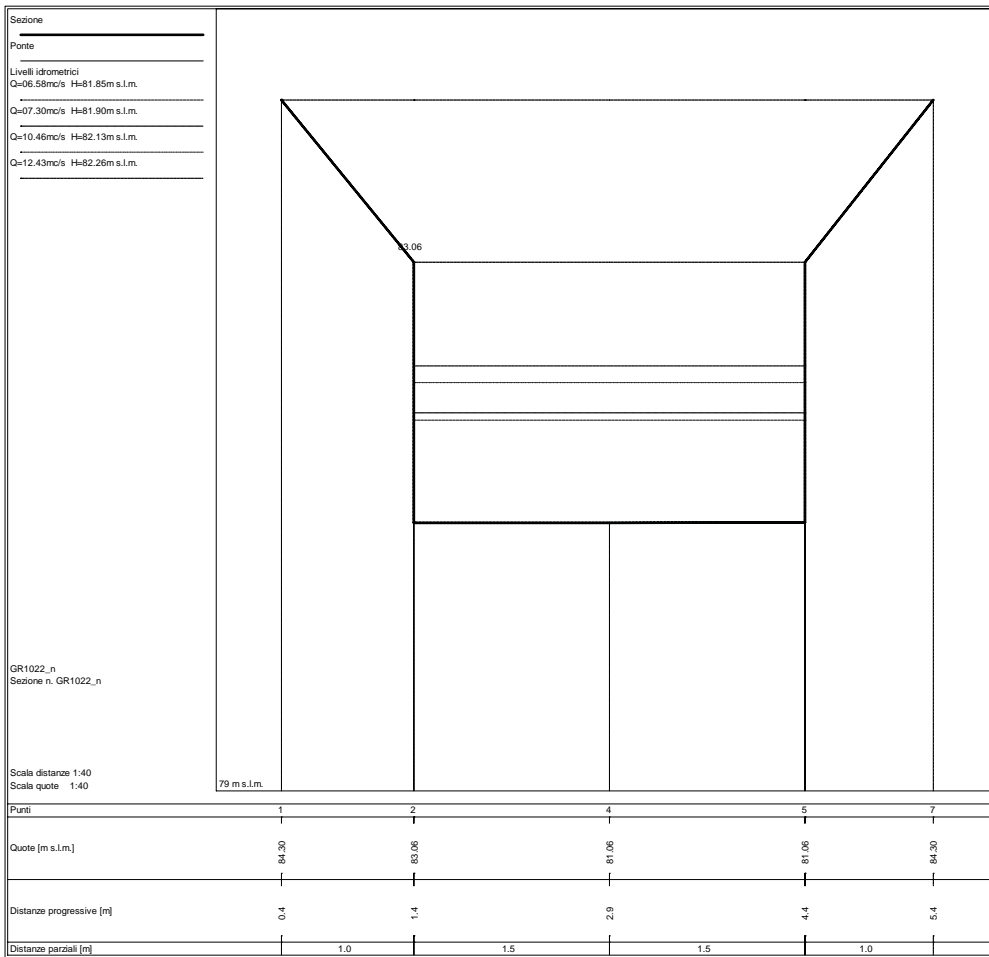

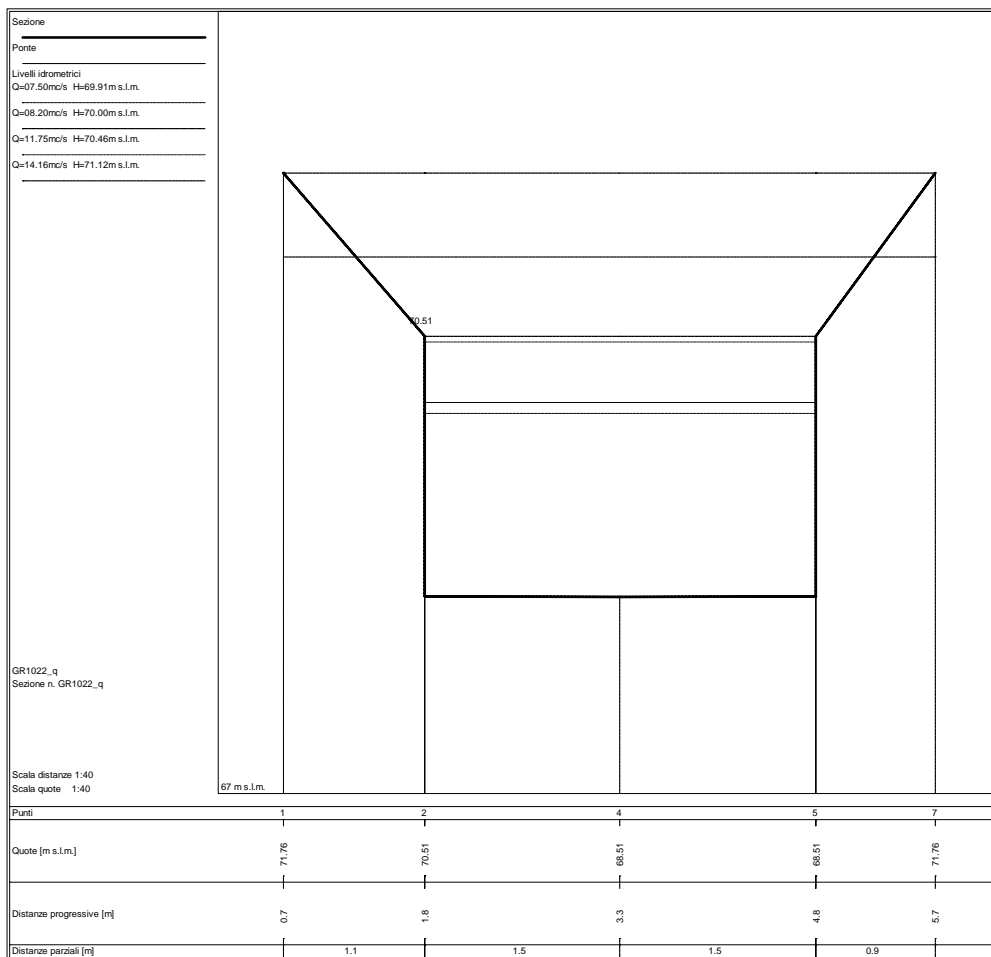
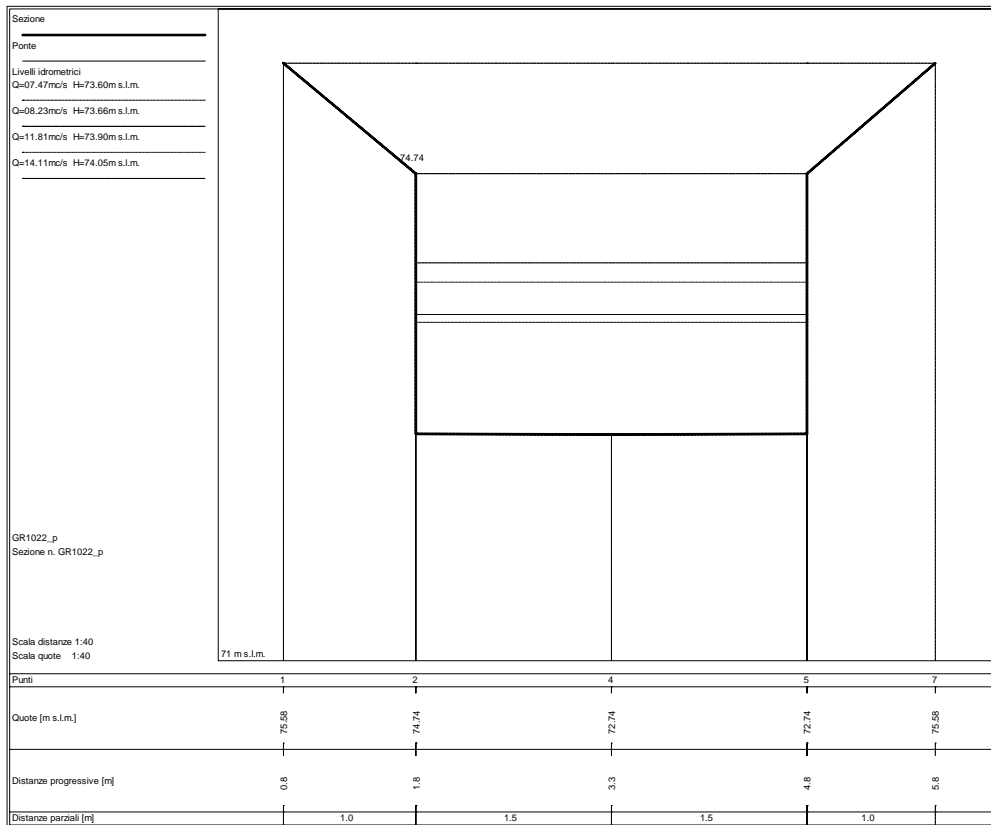

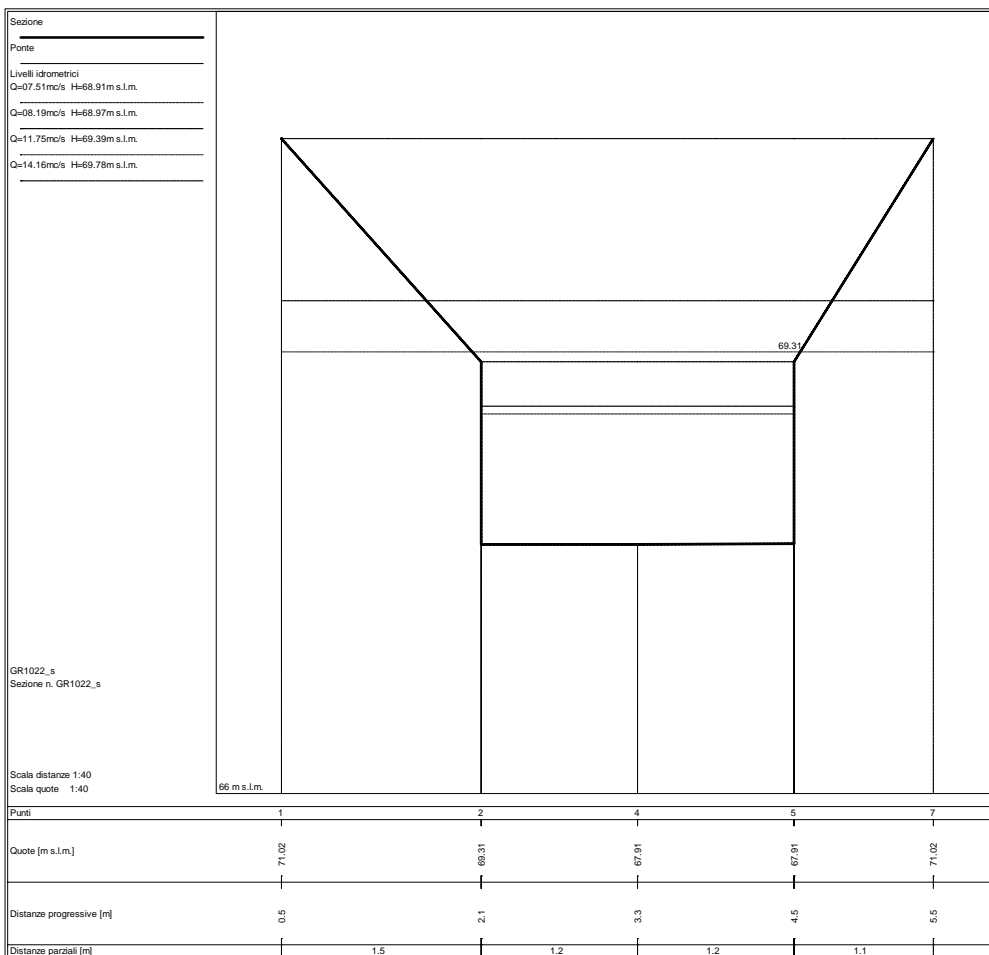
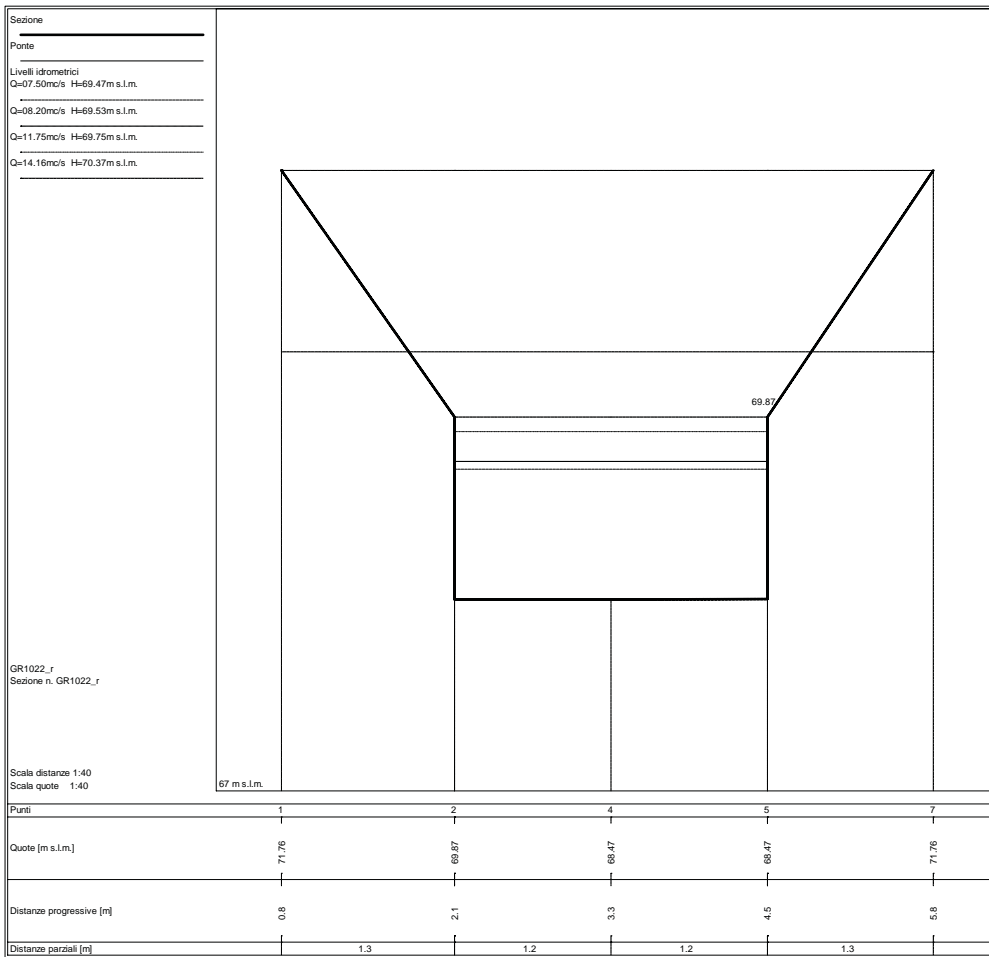

Sezione
 Ponte
 Livelli idrometrici
 Q=07.51mc/s H=68.60m s.l.m.
 Q=08.19mc/s H=68.68m s.l.m.
 Q=11.75mc/s H=69.45m s.l.m.
 Q=14.17mc/s H=69.77m s.l.m.

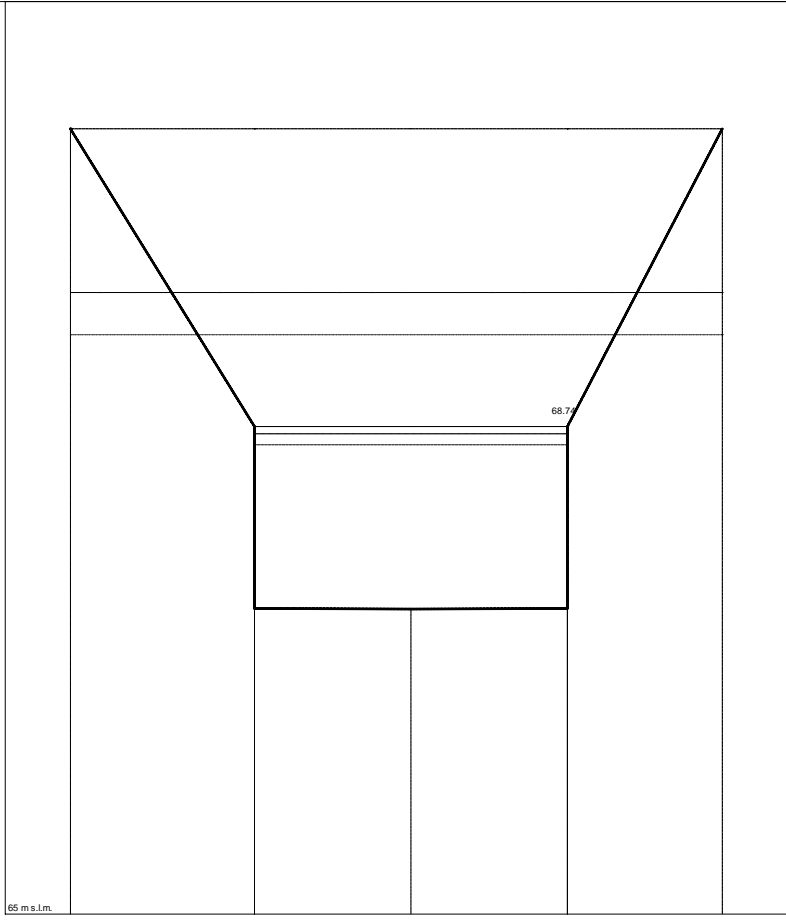

GR1022_1
 Sezione n. GR1022_1

Scala distanze 1:40
 Scala quote 1:40

Punti	1	2	4	5	7
Quote [m s.l.m.]	71.02	68.74	67.34	67.34	71.02
Distanze progressive [m]	0.5	1.9	3.1	4.3	5.5
Distanze parziali [m]		1.4	1.2	1.2	1.2

Sezione
 Ponte
 Livelli idrometrici
 Q=07.50mc/s H=68.52m s.l.m.
 Q=08.18mc/s H=68.60m s.l.m.
 Q=11.75mc/s H=69.15m s.l.m.
 Q=14.17mc/s H=69.58m s.l.m.

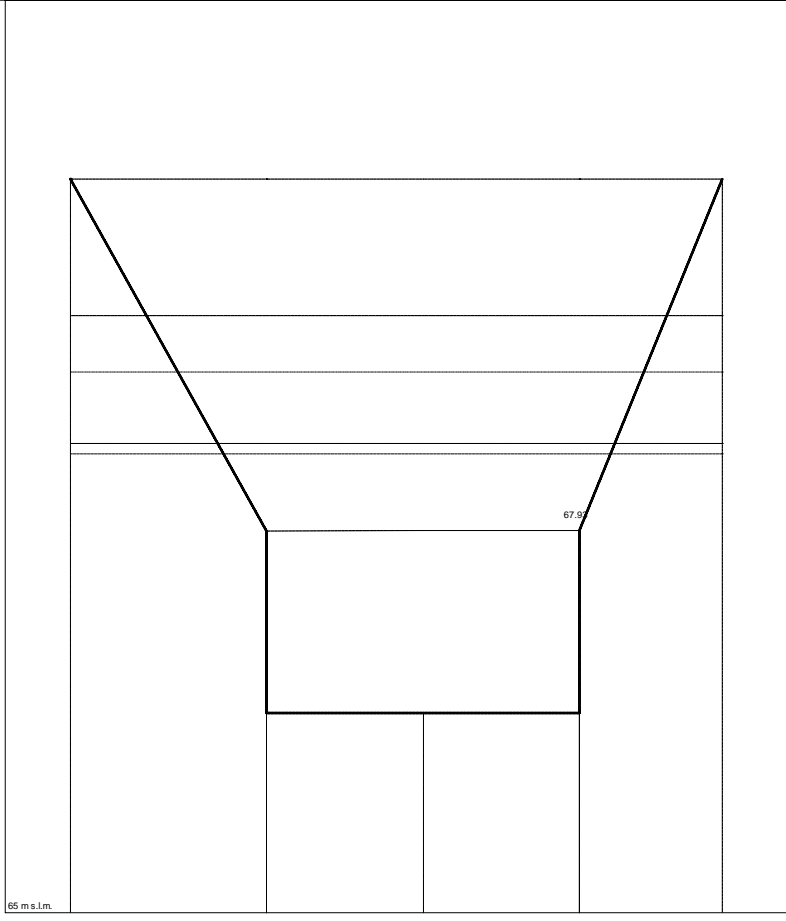

GR1022_u
 Sezione n. GR1022_u

Scala distanze 1:40
 Scala quote 1:40

Punti	1	2	4	5	7
Quote [m s.l.m.]	70.83	67.93	66.53	66.53	70.83
Distanze progressive [m]	0.9	2.4	3.6	4.8	5.9
Distanze parziali [m]		1.5	1.2	1.2	1.1

Sezione
 Ponte
 Livelli idrometrici
 Q=07.50mc/s H=67.91m s.l.m.
 Q=08.18mc/s H=68.00m s.l.m.
 Q=11.75mc/s H=68.26m s.l.m.
 Q=14.17mc/s H=68.34m s.l.m.

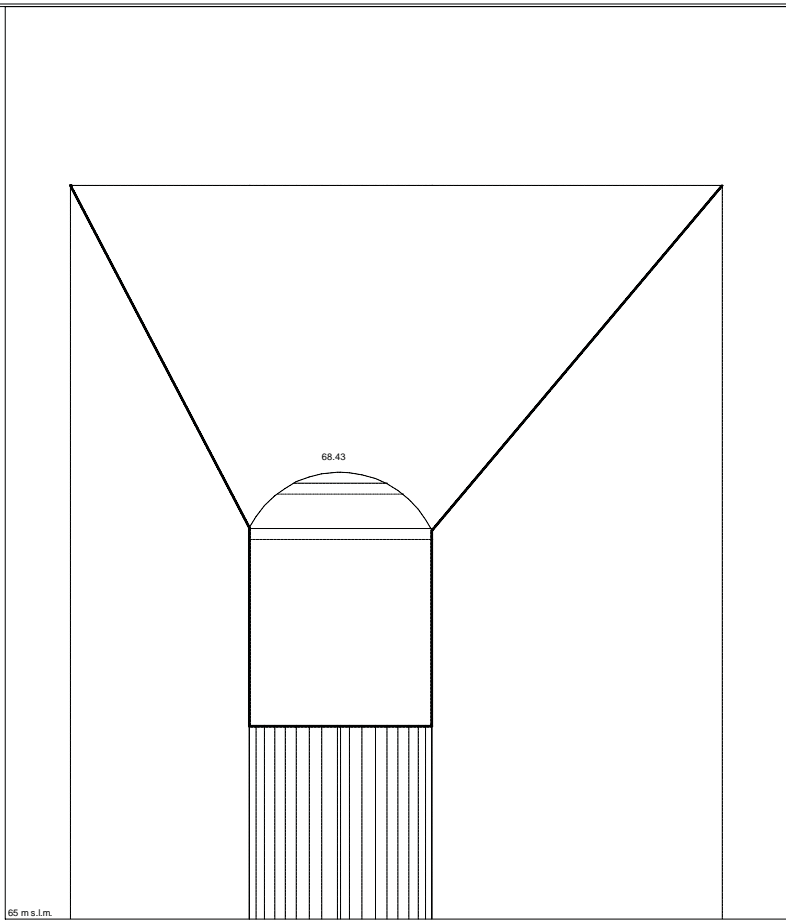

GR1022_v
 Sezione n. GR1022_v

Scala distanze 1:40
 Scala quote 1:40

Punti	1	2	5	7	8	9	11	14	15	17	19	21	23
Quote [m s.l.m.]	70.63	68.00	66.48	66.48	66.48	66.48	66.48	66.48	66.48	66.48	66.48	66.48	70.63
Distanze progressive [m]	0.8	2.2	2.3	2.4	2.5	2.6	2.8	3.0	3.1	3.3	3.5	3.6	5.8
Distanze parziali [m]		1.4											2.2

Sezione
 Ponte
 Livelli idrometrici
 Q=07.52mc/s H=66.11m s.l.m.
 Q=08.16mc/s H=66.19m s.l.m.
 Q=11.76mc/s H=66.46m s.l.m.
 Q=14.21mc/s H=66.54m s.l.m.

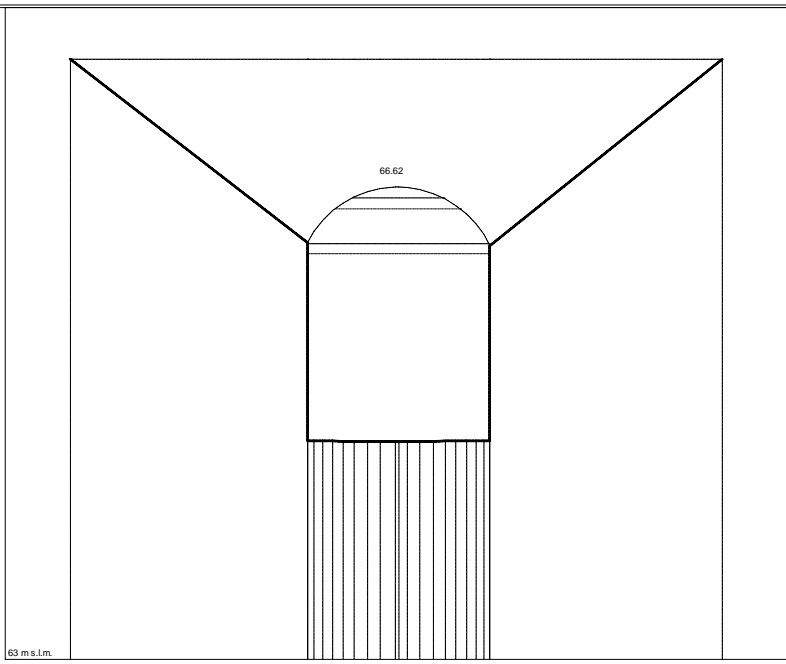

GR1022_z
 Sezione n. GR1022_z

Scala distanze 1:40
 Scala quote 1:40

Punti	1	2	5	7	8	9	11	14	15	17	19	21	23
Quote [m s.l.m.]	67.61	66.20	64.68	64.67	64.67	64.67	64.67	64.67	64.67	64.68	64.68	64.68	67.61
Distanze progressive [m]	1.0	2.8	2.9	3.1	3.2	3.3	3.5	3.7	3.8	4.0	4.1	4.2	6.0
Distanze parziali [m]		1.8											1.8

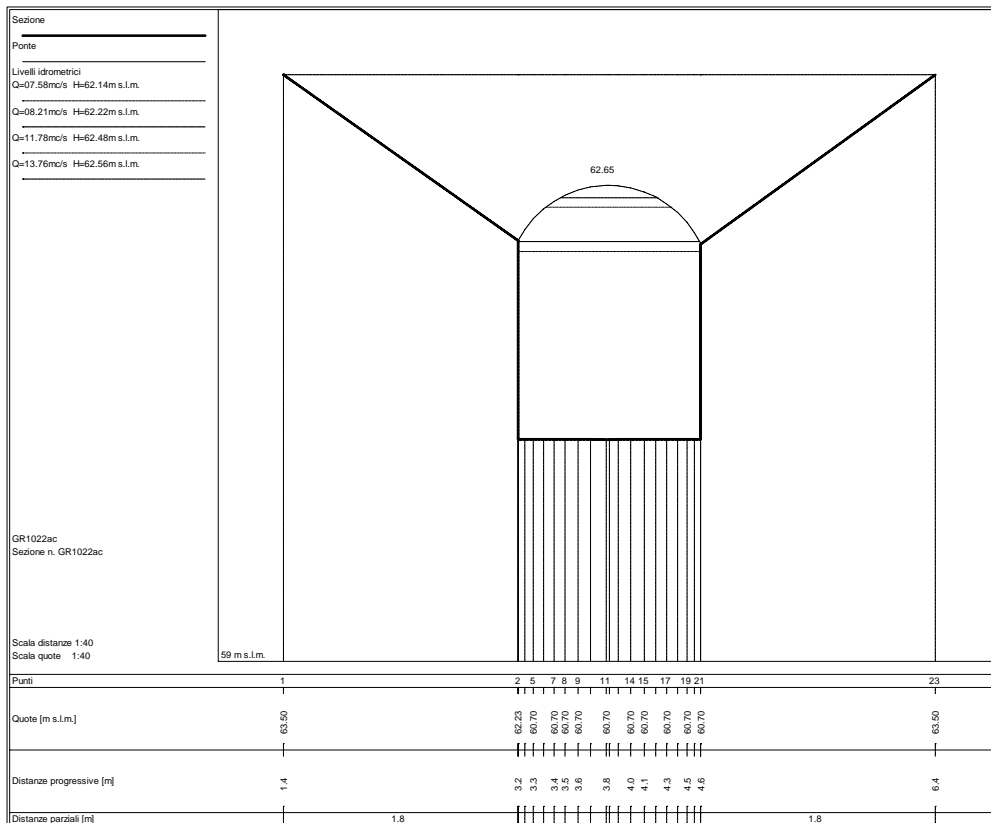
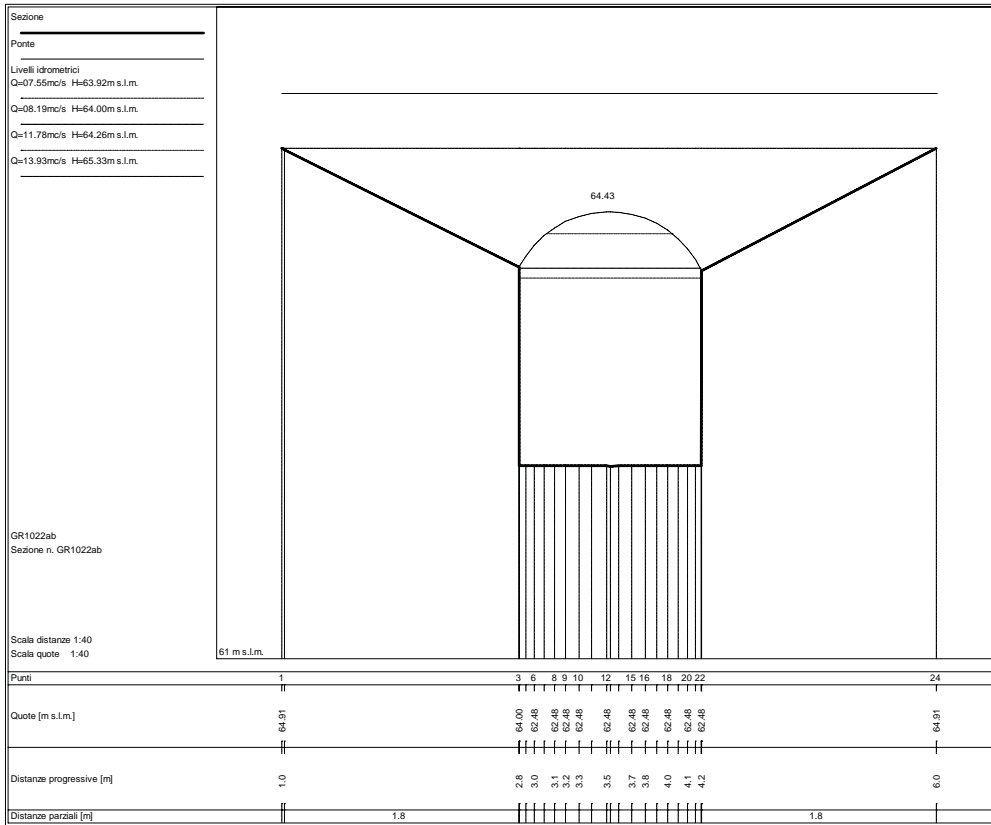

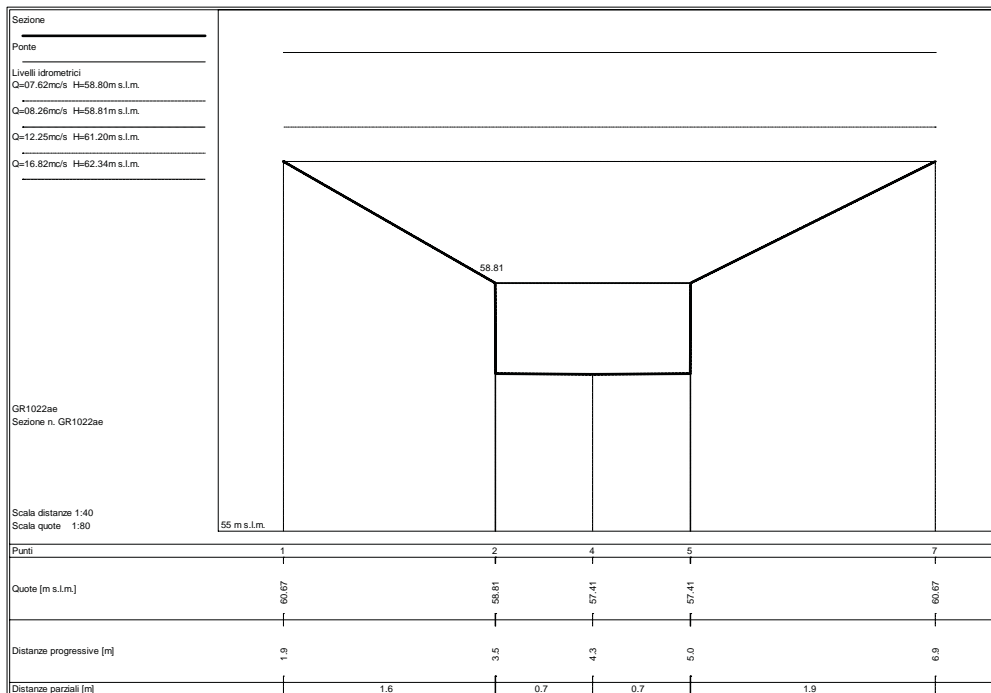
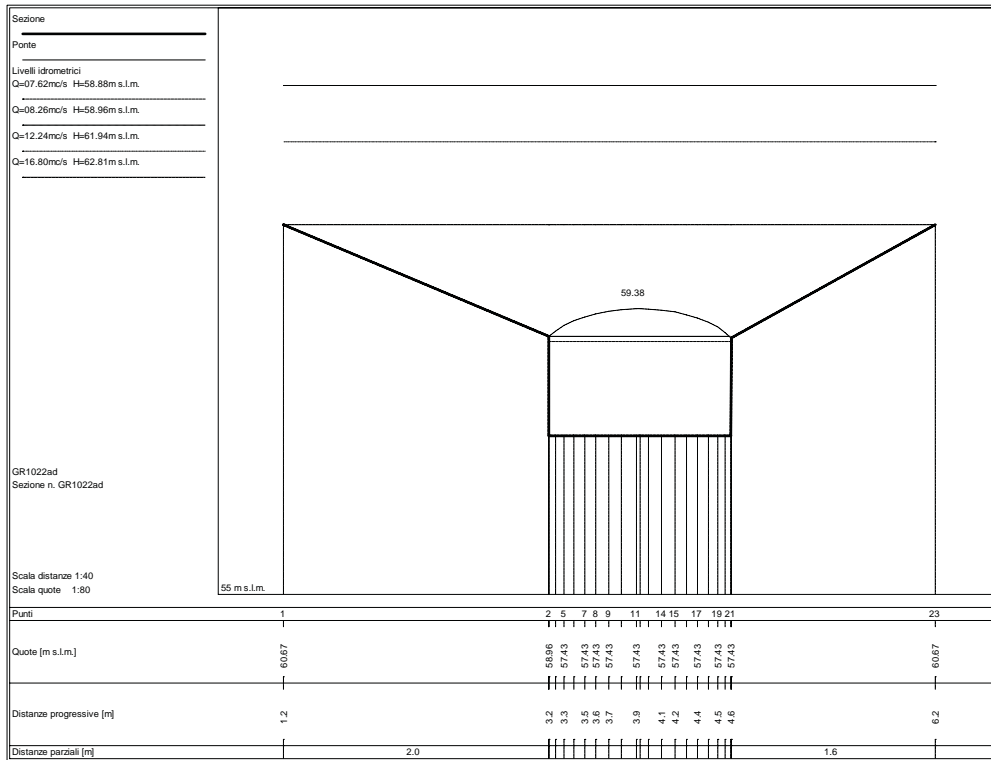

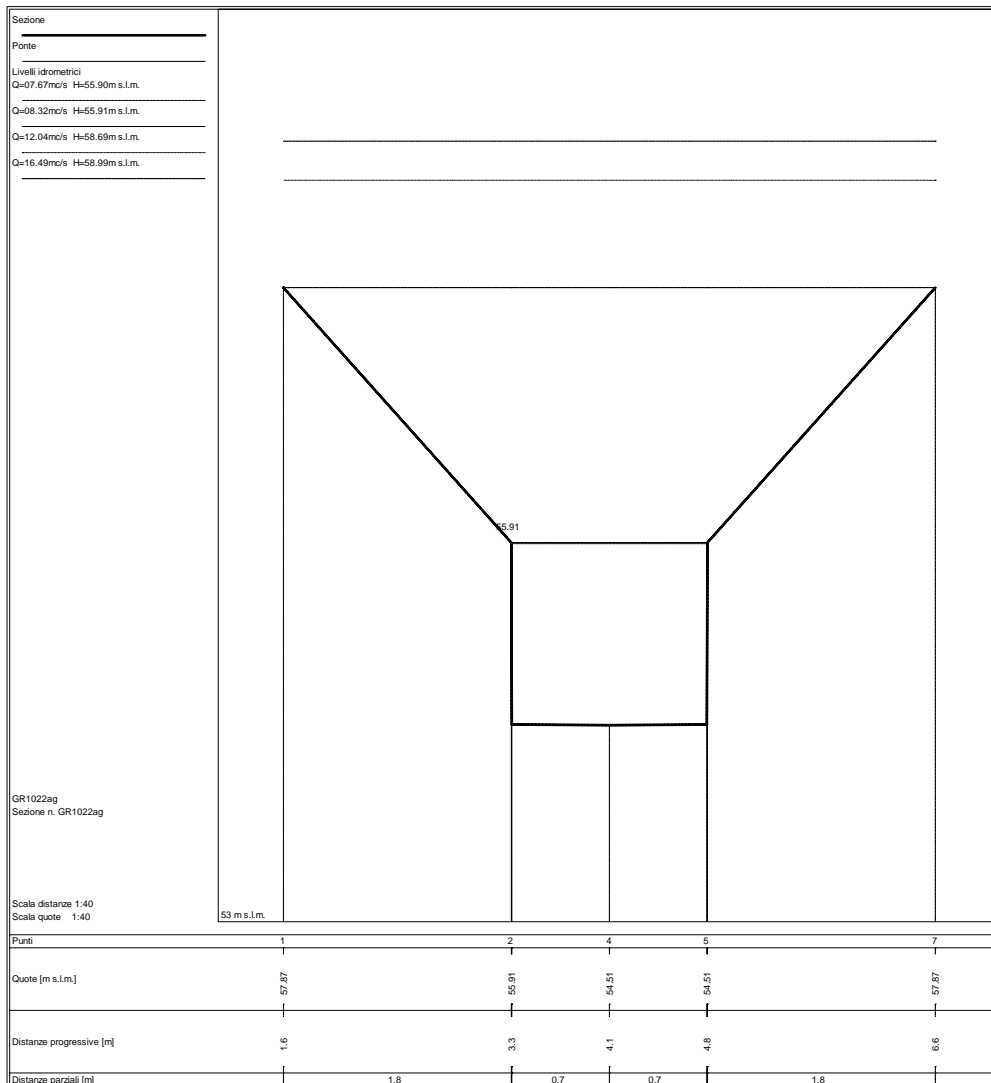
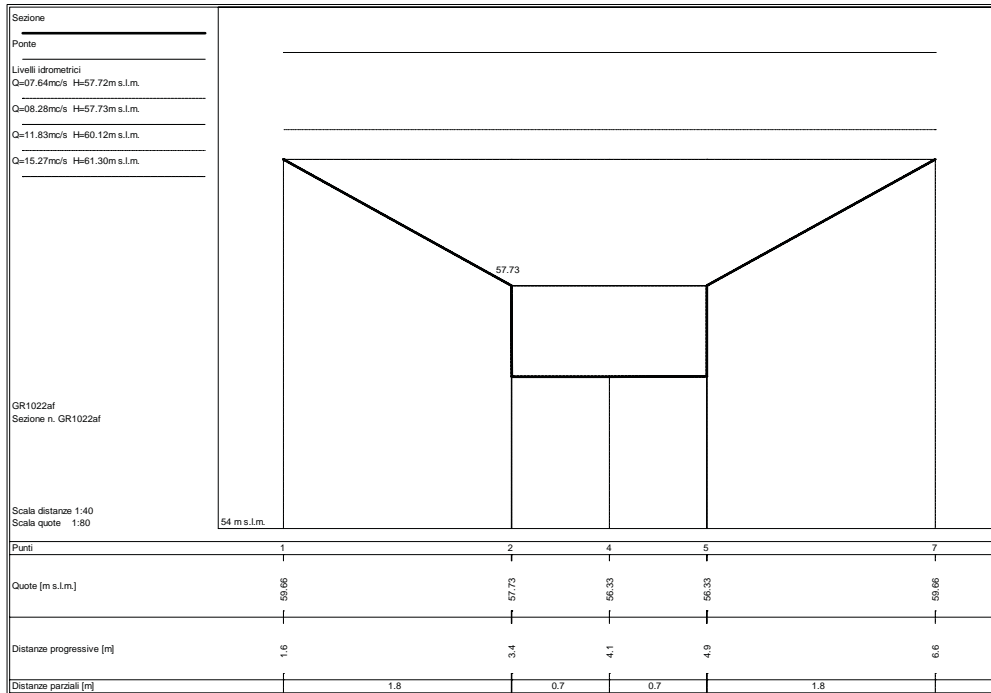

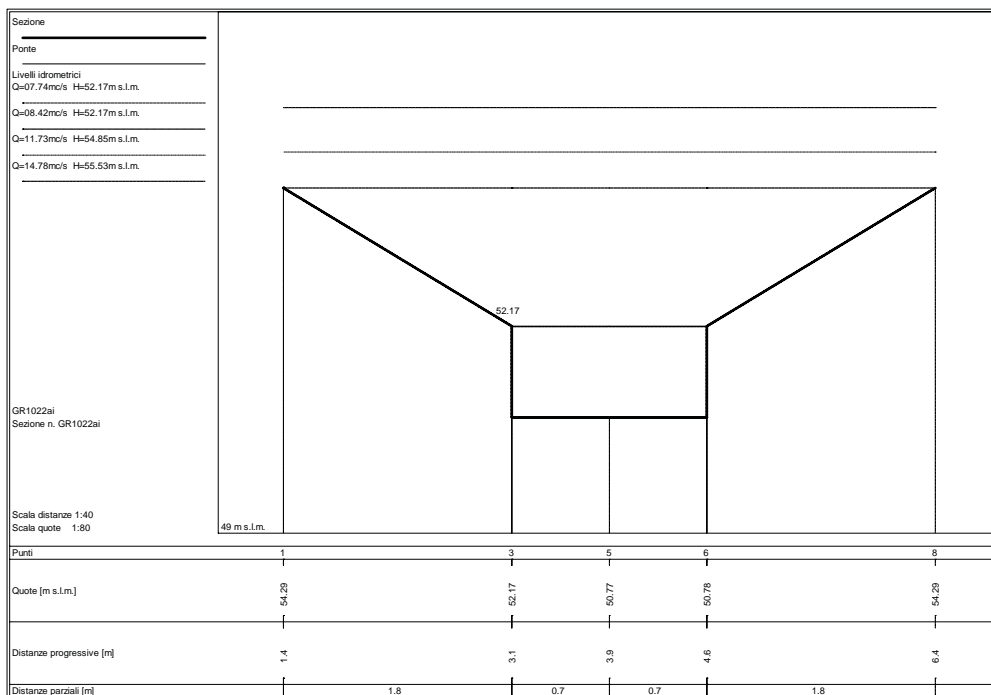
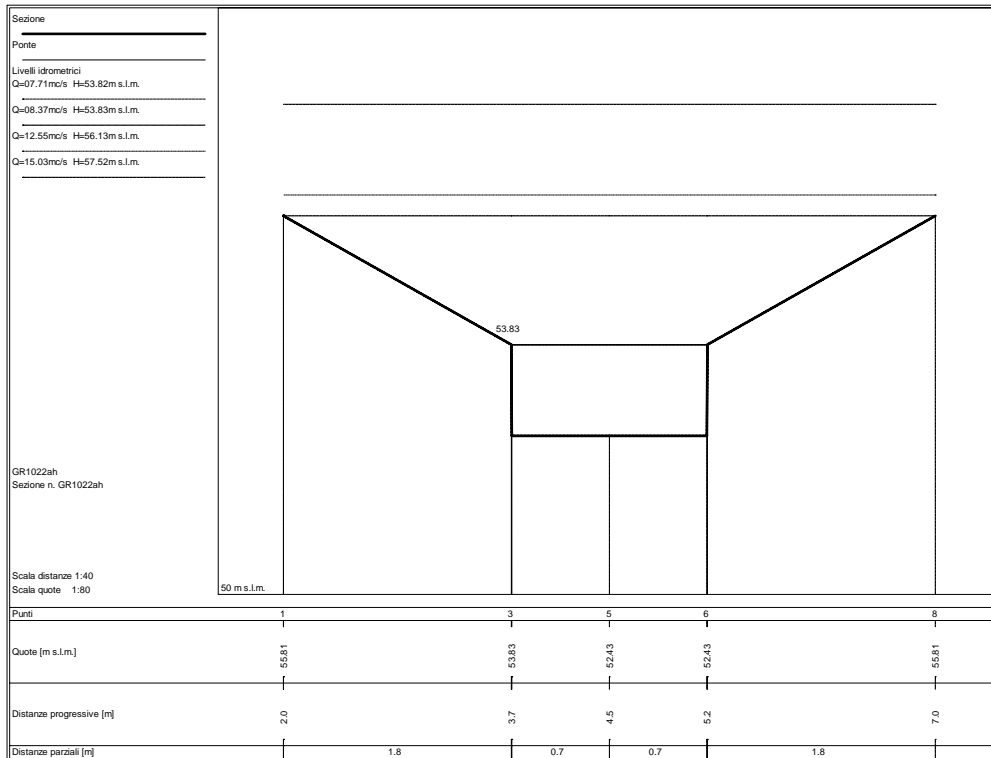

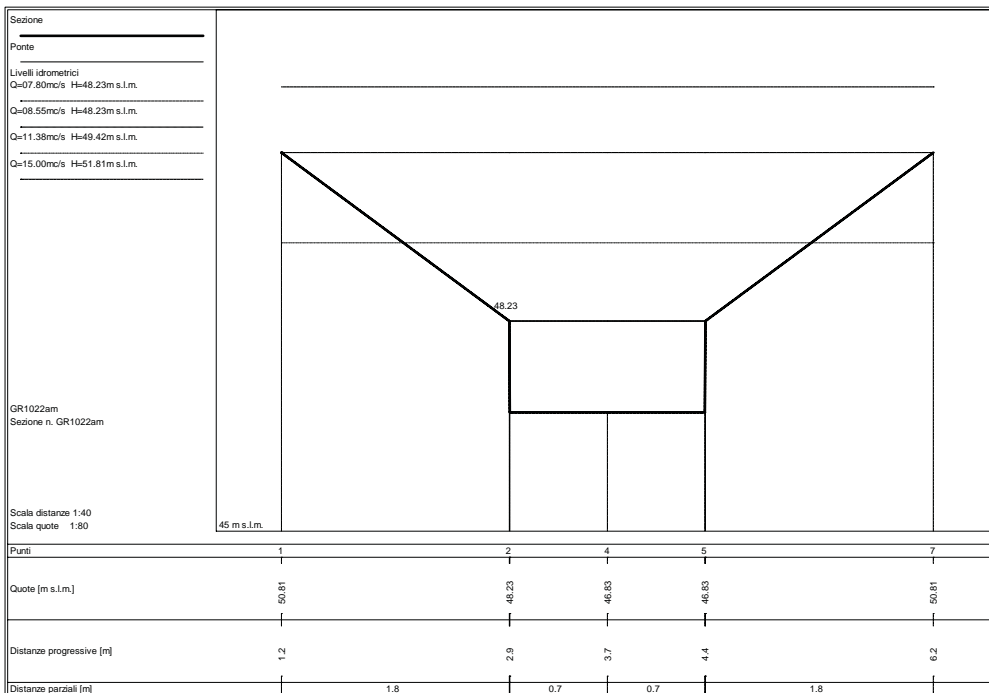
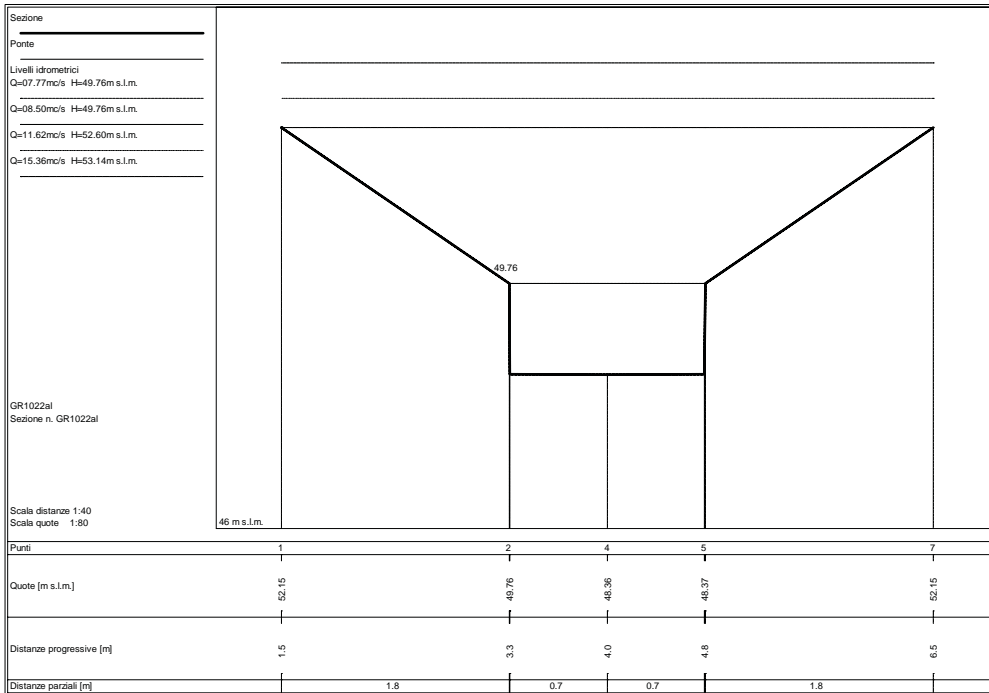

Sezione
 Ponte
 Livelli idrometrici
 Q=07.83mc/s H=46.20m s.l.m.
 Q=08.62mc/s H=46.20m s.l.m.
 Q=11.40mc/s H=46.20m s.l.m.
 Q=14.68mc/s H=49.34m s.l.m.

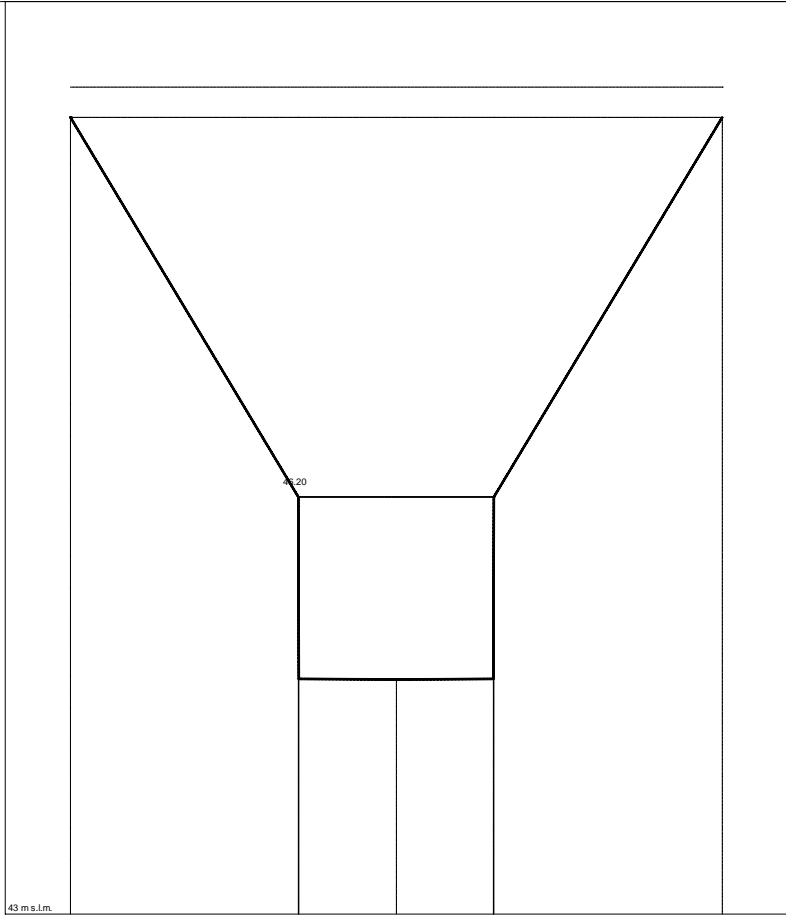

GR1022an
 Sezione n. GR1022an

Scala distanze 1:40
 Scala quote 1:40

Punti	1	2	4	5	7
Quote [m s.l.m.]	49.11	46.20	44.80	44.81	49.11
Distanze progressive [m]	0.5	2.2	3.0	3.7	5.5
Distanze parziali [m]		1.8	0.7	0.7	1.8

Sezione
 Ponte
 Livelli idrometrici
 Q=07.85mc/s H=44.81m s.l.m.
 Q=08.67mc/s H=44.81m s.l.m.
 Q=11.42mc/s H=44.81m s.l.m.
 Q=14.26mc/s H=47.80m s.l.m.

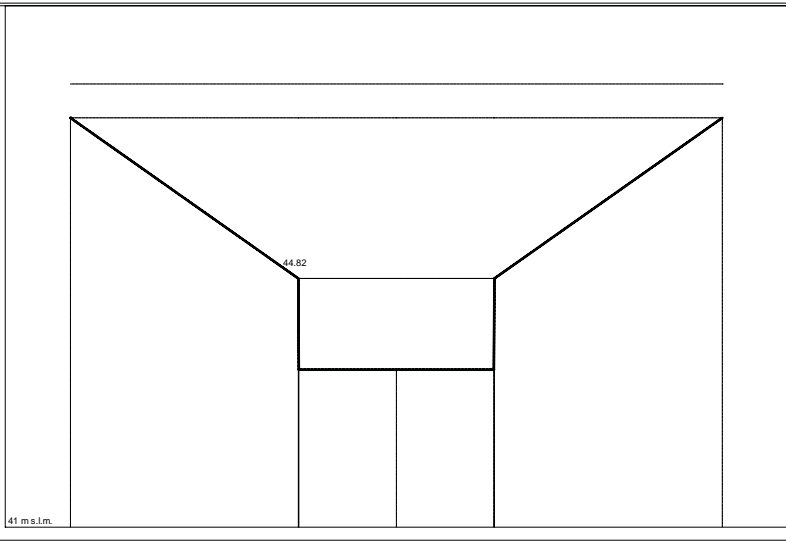

GR1022ao
 Sezione n. GR1022ao

Scala distanze 1:40
 Scala quote 1:80

Punti	1	2	4	5	7
Quote [m s.l.m.]	47.28	44.82	43.42	43.42	47.28
Distanze progressive [m]	0.5	2.2	3.0	3.7	5.5
Distanze parziali [m]		1.8	0.7	0.7	1.8

Sezione
 Ponte
 Livelli idrometrici
 Q=08.65mc/s H=43.71m s.l.m.
 Q=09.55mc/s H=43.71m s.l.m.
 Q=12.68mc/s H=43.71m s.l.m.
 Q=15.38mc/s H=46.25m s.l.m.

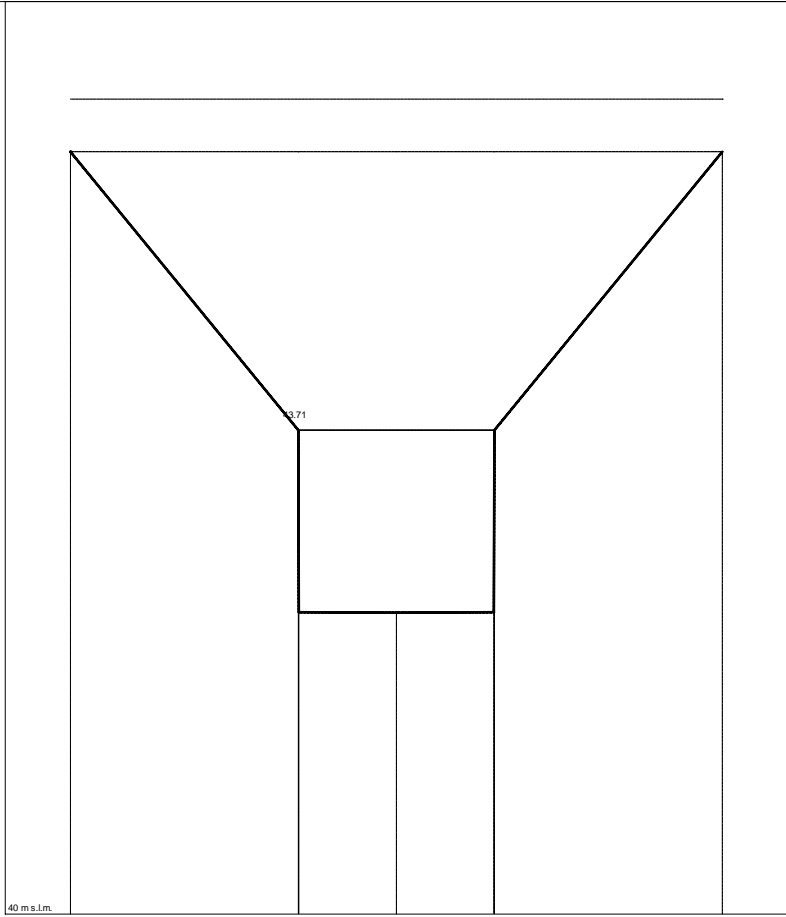

GR1022ap
 Sezione n. GR1022ap

Scala distanze 1:40
 Scala quote 1:40

Punti	1	2	4	5	7
Quote [m s.l.m.]	45.85	43.71	42.31	42.32	45.85
Distanze progressive [m]	0.3	2.1	2.8	3.6	5.3
Distanze parziali [m]		1.8	0.7	0.7	1.8

Sezione
 Ponte
 Livelli idrometrici
 Q=08.68mc/s H=42.24m s.l.m.
 Q=09.58mc/s H=42.24m s.l.m.
 Q=12.74mc/s H=42.24m s.l.m.
 Q=15.16mc/s H=43.62m s.l.m.

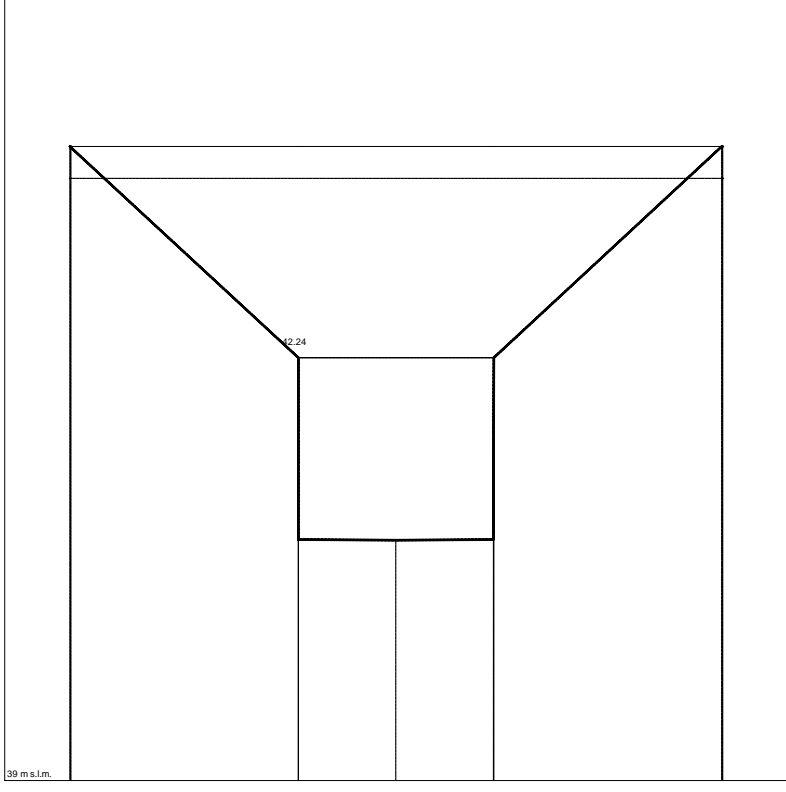

GR1022aq
 Sezione n. GR1022aq

Scala distanze 1:40
 Scala quote 1:40

Punti	1	3	5	6	8
Quote [m s.l.m.]	43.86	42.24	40.84	40.85	43.86
Distanze progressive [m]	0.8	2.5	3.3	4.0	5.8
Distanze parziali [m]		1.7	0.7	0.7	1.8

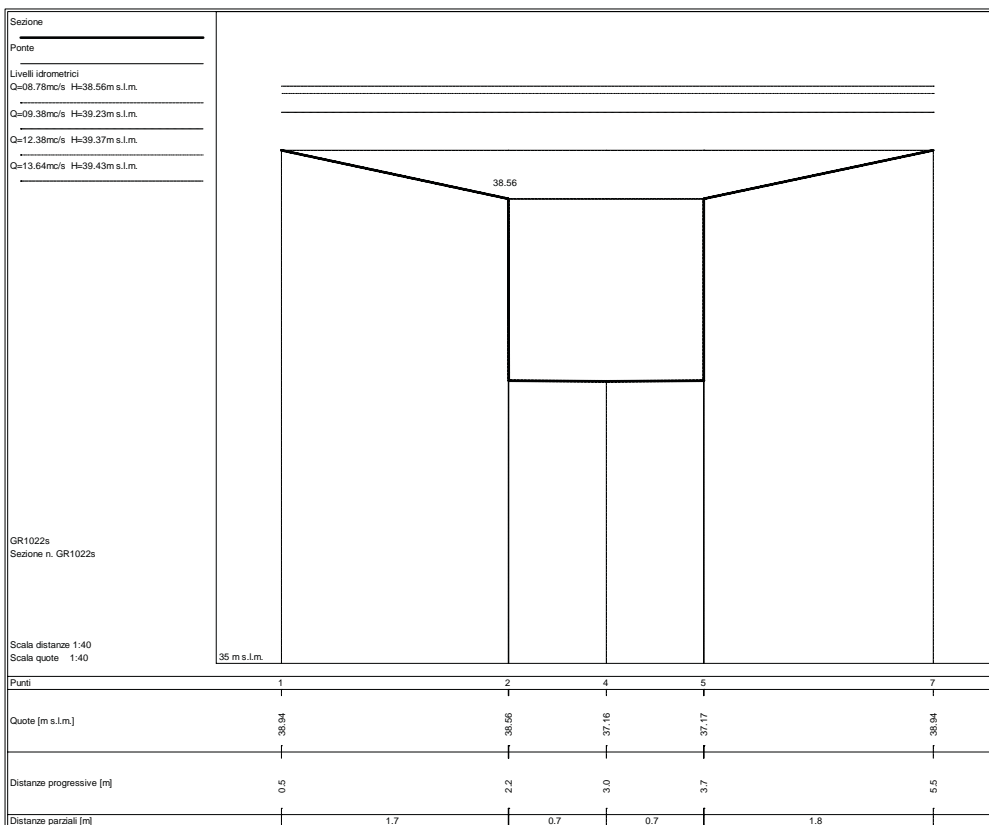
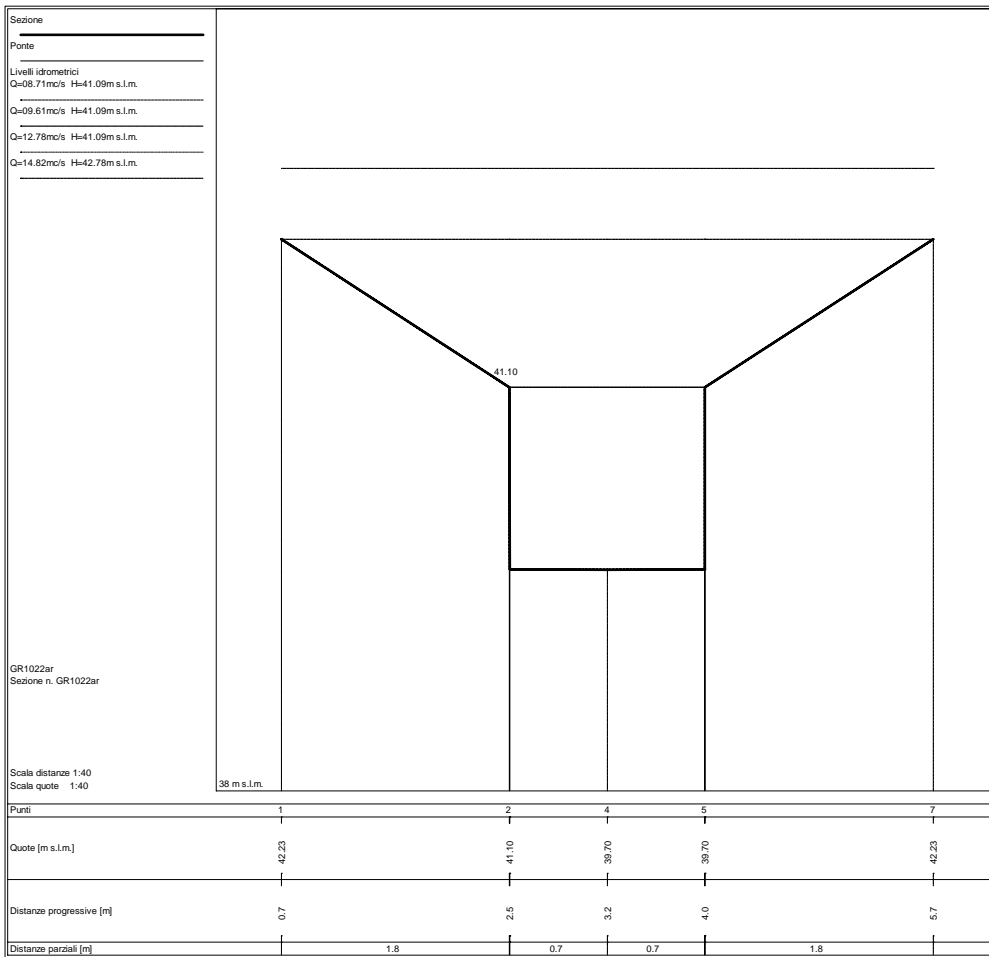

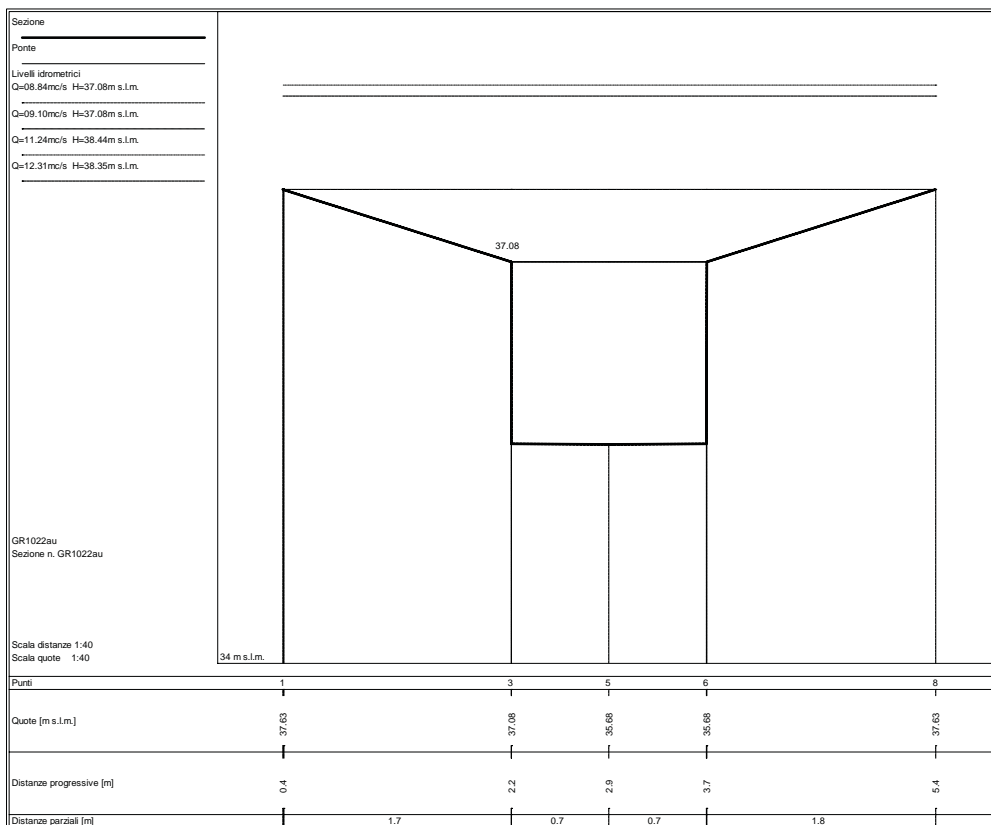
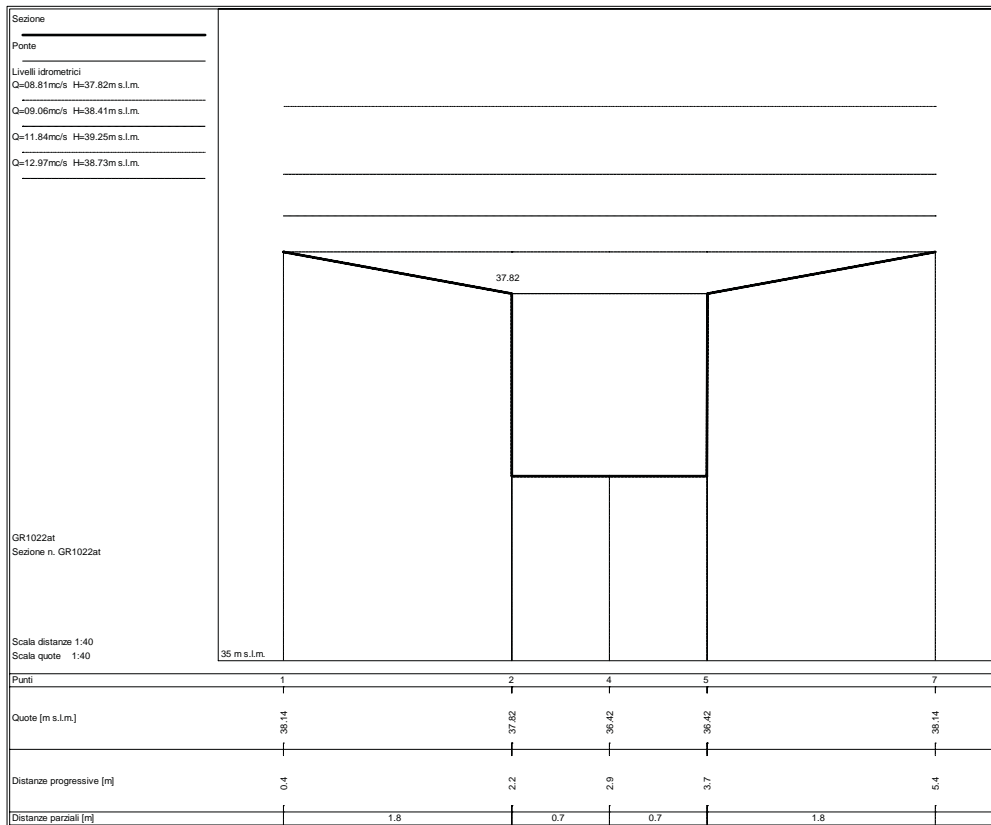

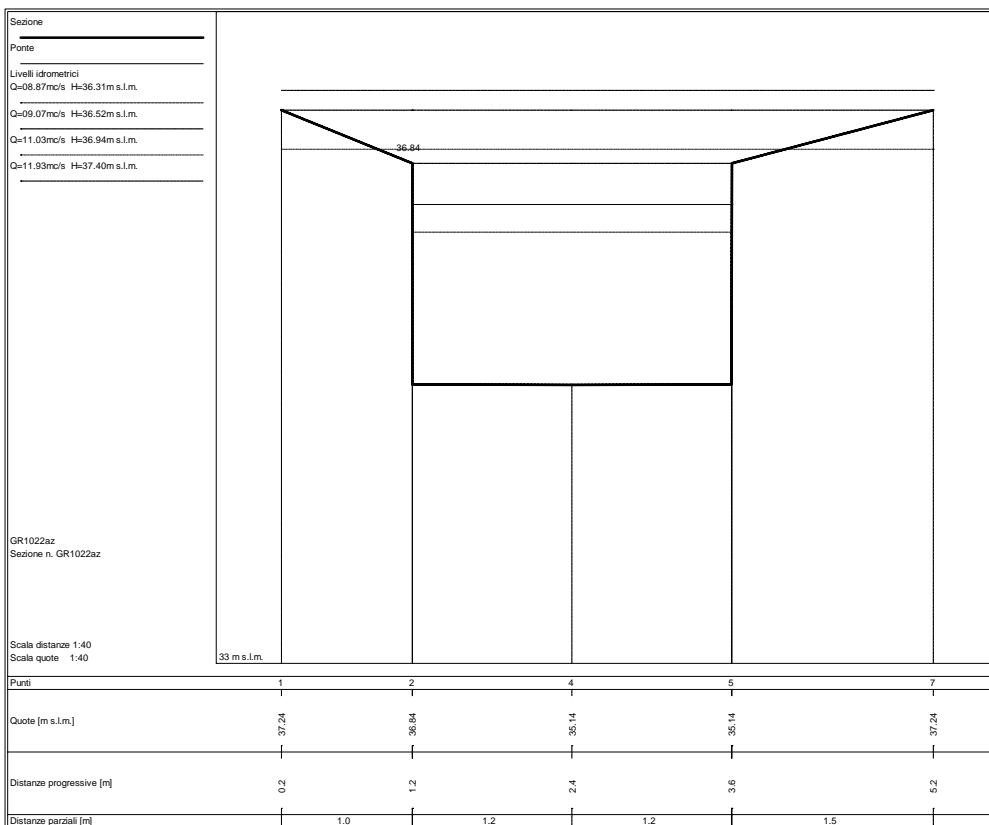
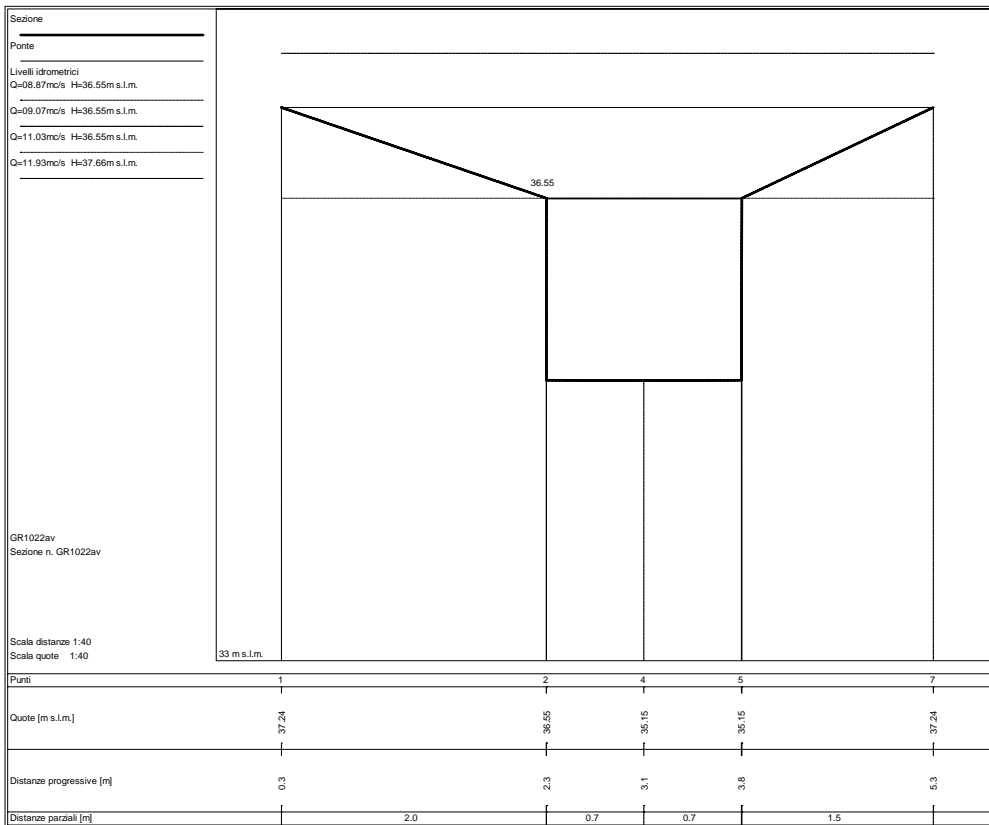

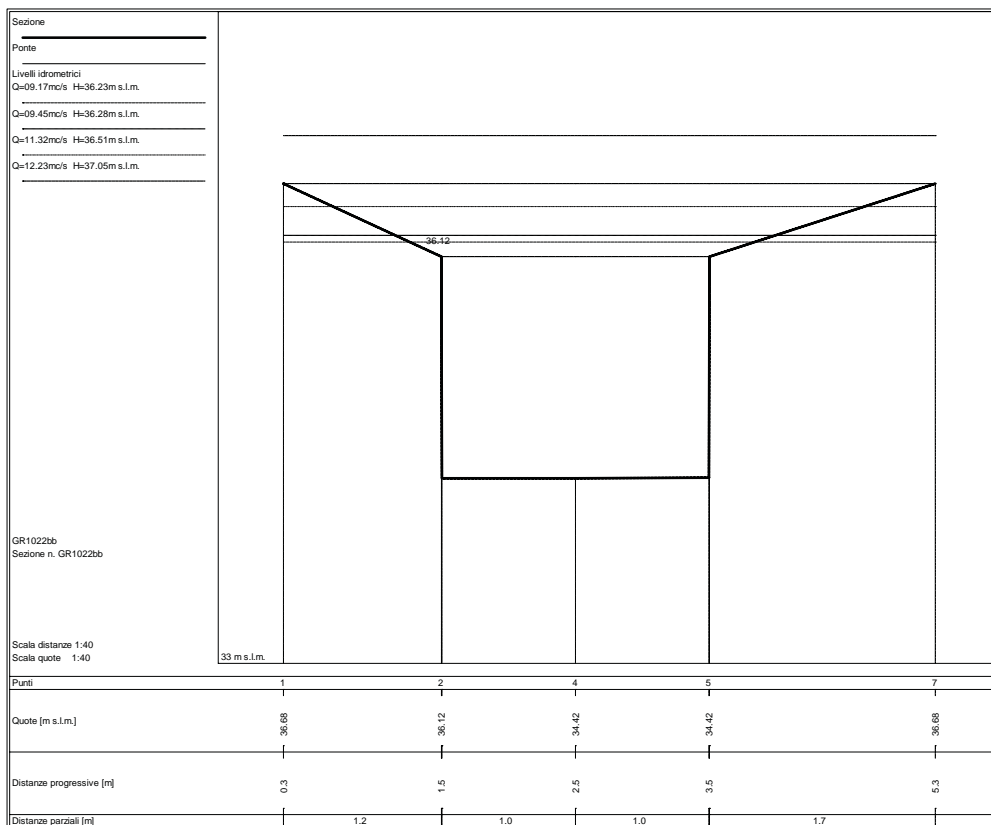
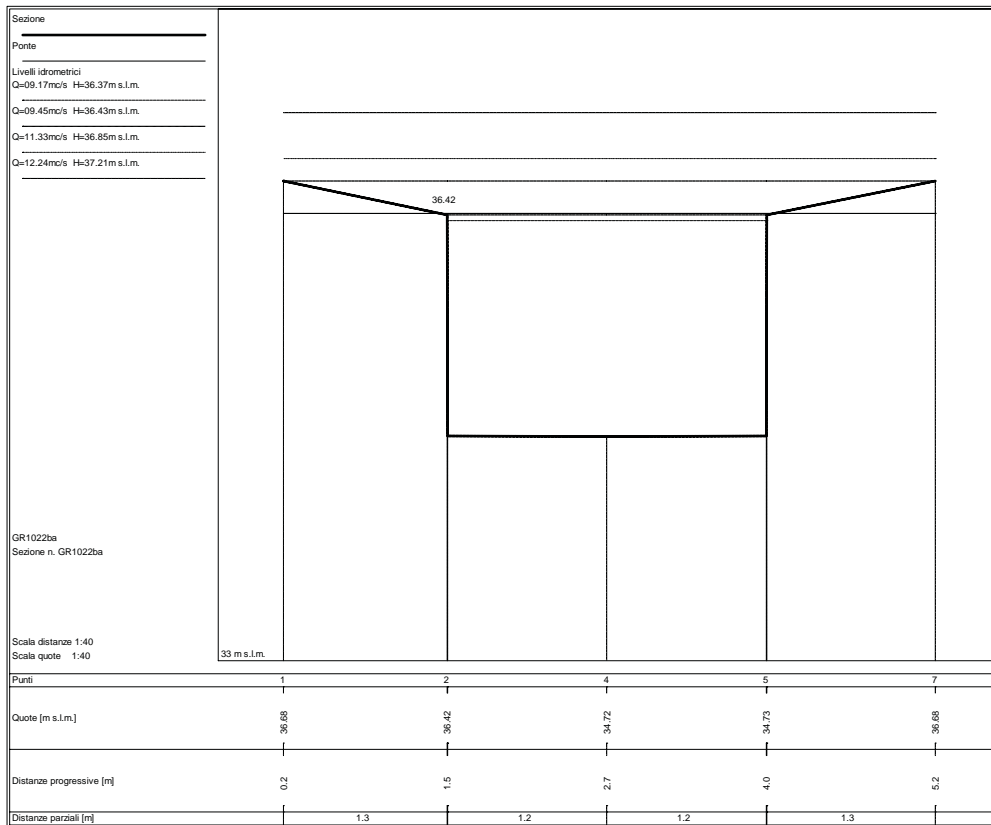

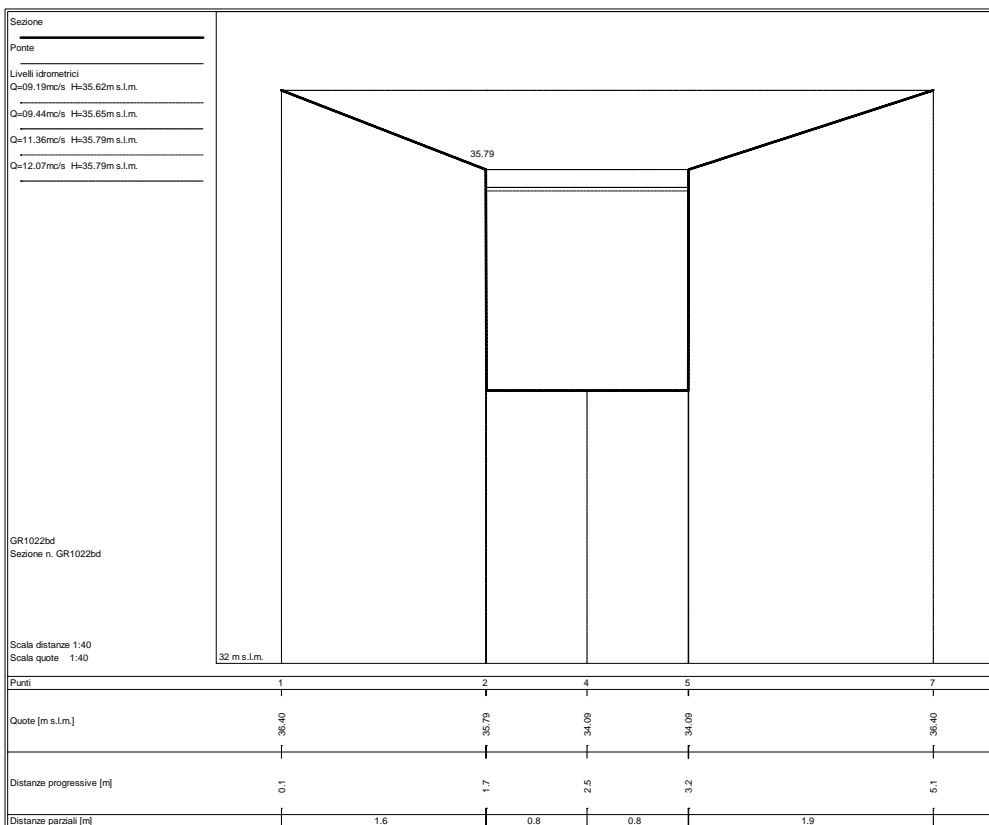
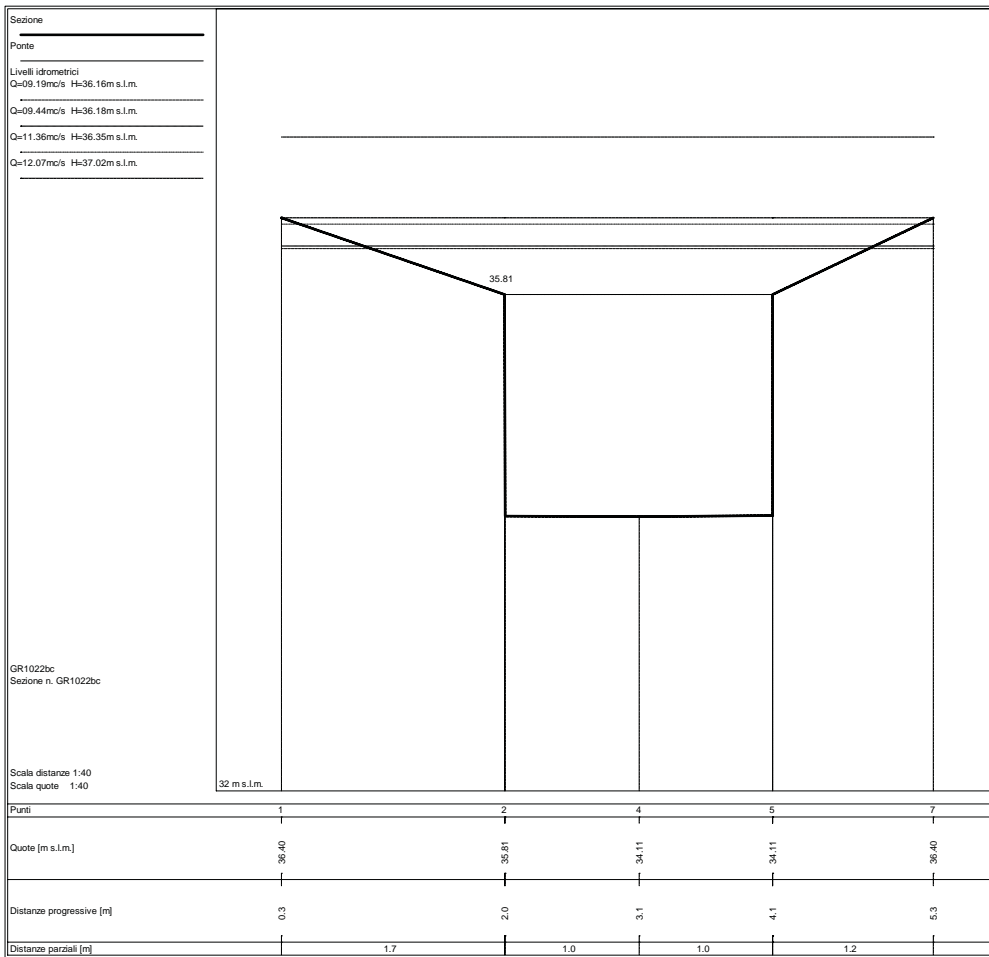

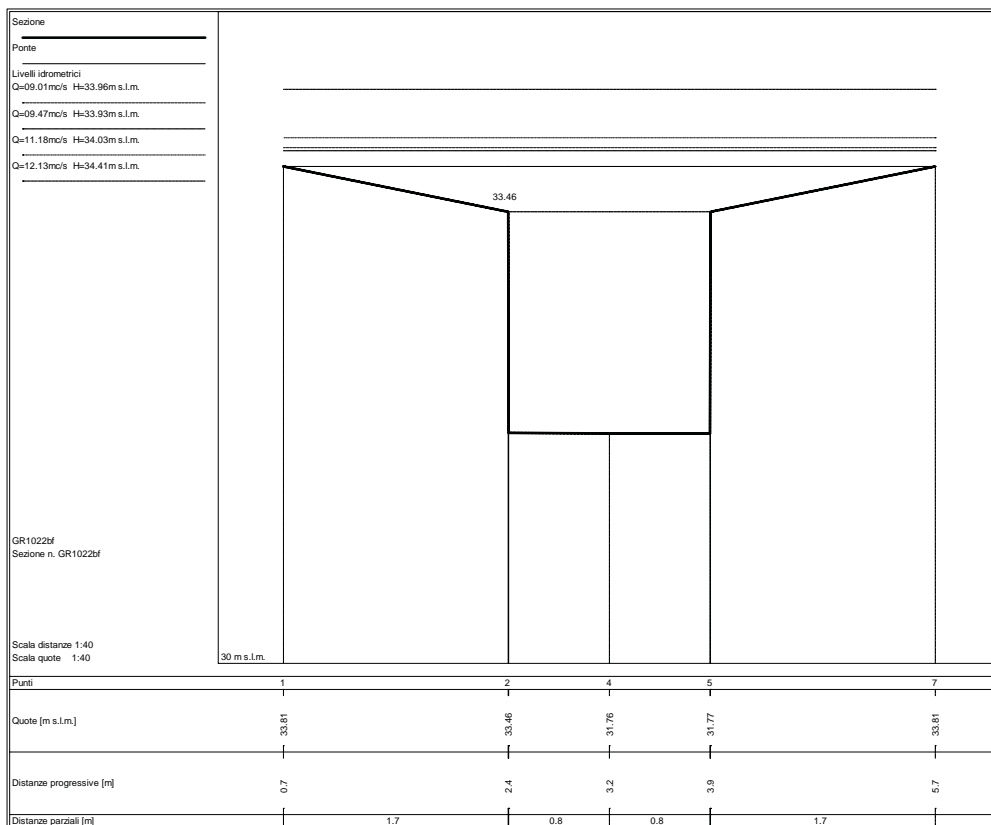
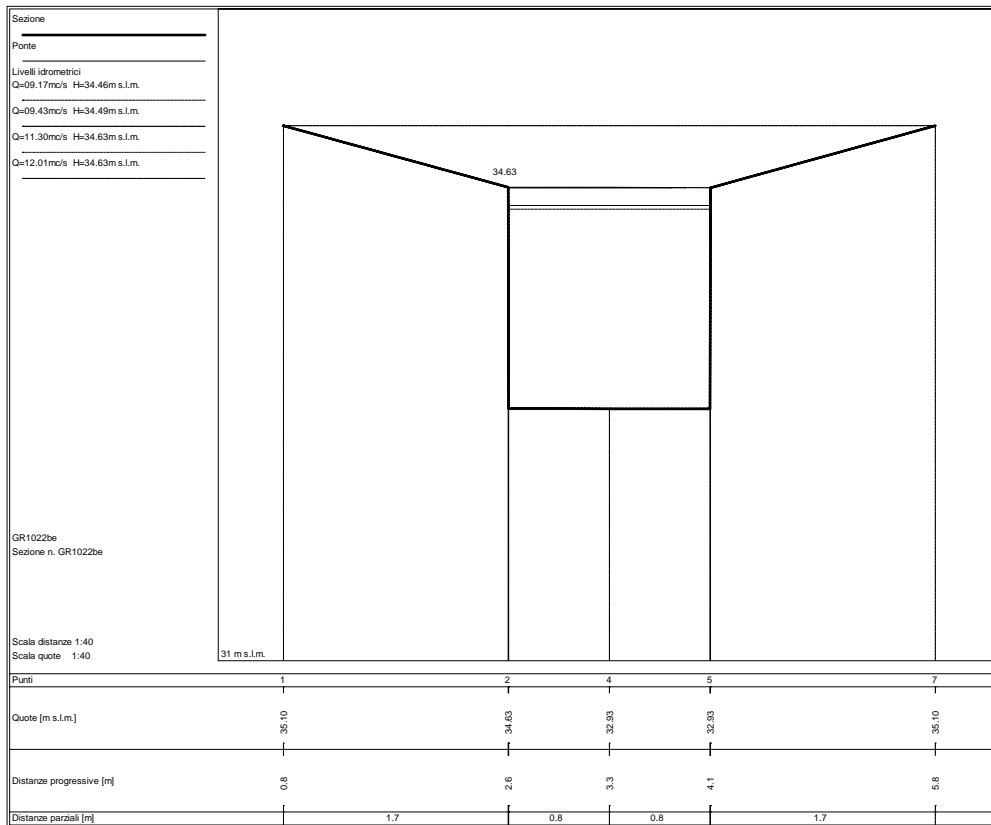

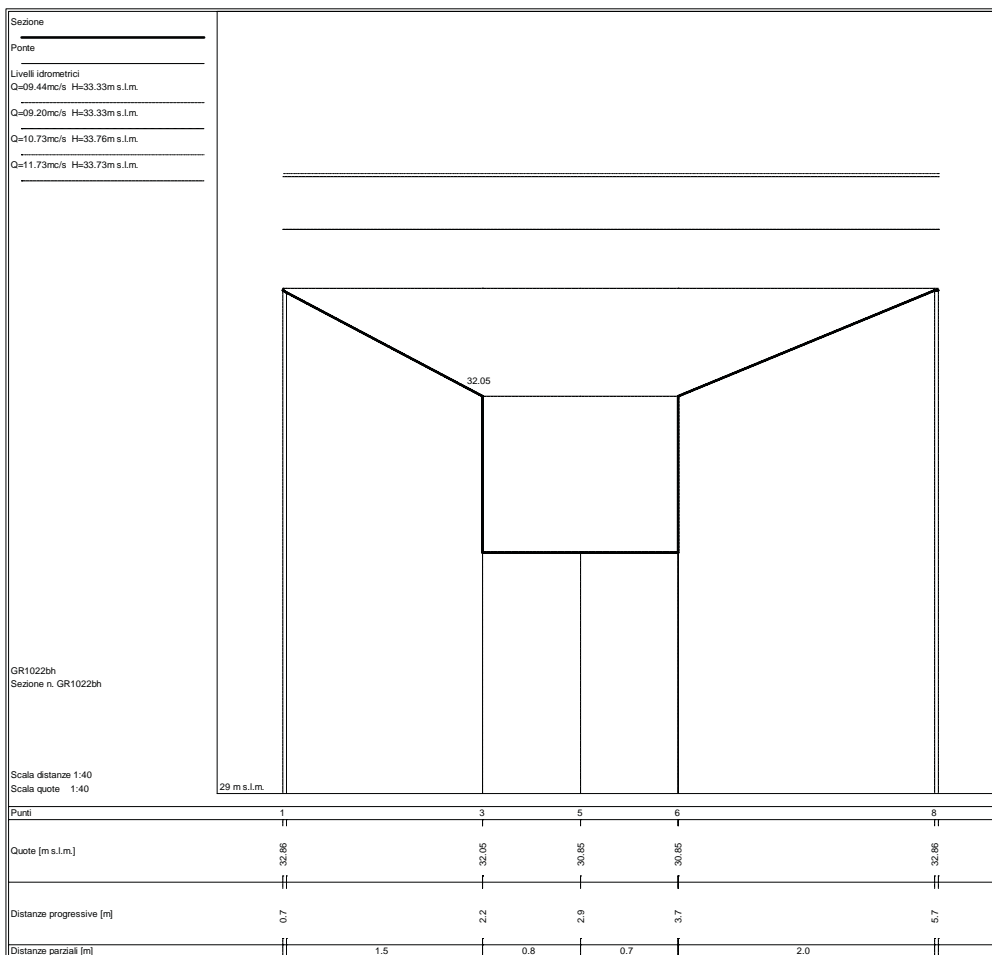
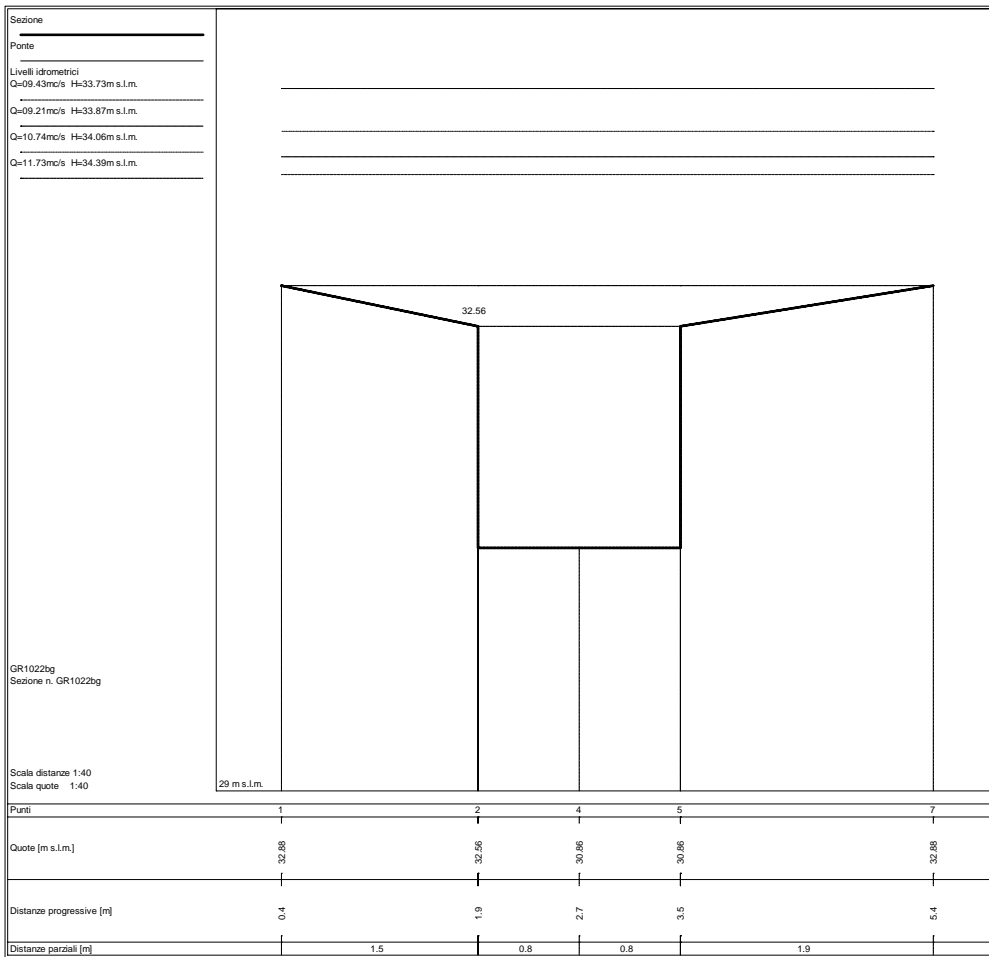

Sezione
 Ponte
 Livelli idrometrici
 Q=08.60mc/s H=33.43m s.l.m.
 Q=08.33mc/s H=33.41m s.l.m.
 Q=10.56mc/s H=33.54m s.l.m.
 Q=11.91mc/s H=33.71m s.l.m.

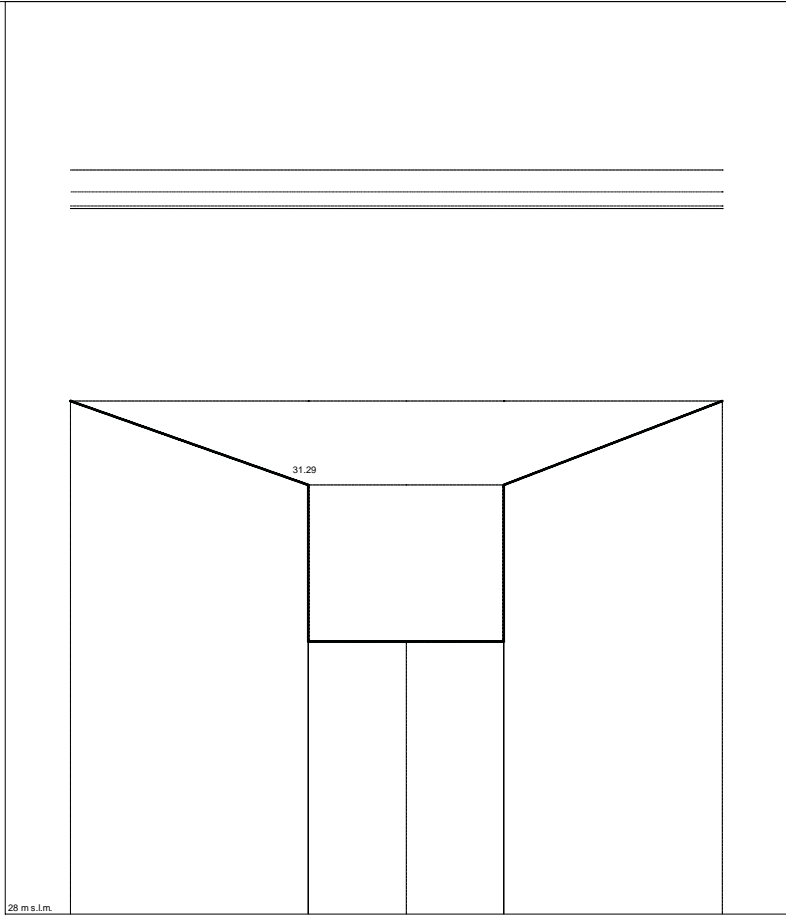

GR1022bi
 Sezione n. GR1022bi

Scala distanze 1:40
 Scala quote 1:40

Punti	1	2	4	5	7
Quote [m s.l.m.]	31.94	31.29	30.09	30.09	31.94
Distanze progressive [m]	0.6	2.4	3.2	3.9	5.6
Distanze parziali [m]		1.8	0.8	0.7	1.7

Sezione
 Ponte
 Livelli idrometrici
 Q=08.57mc/s H=33.43m s.l.m.
 Q=08.30mc/s H=33.41m s.l.m.
 Q=10.55mc/s H=33.54m s.l.m.
 Q=11.92mc/s H=33.69m s.l.m.

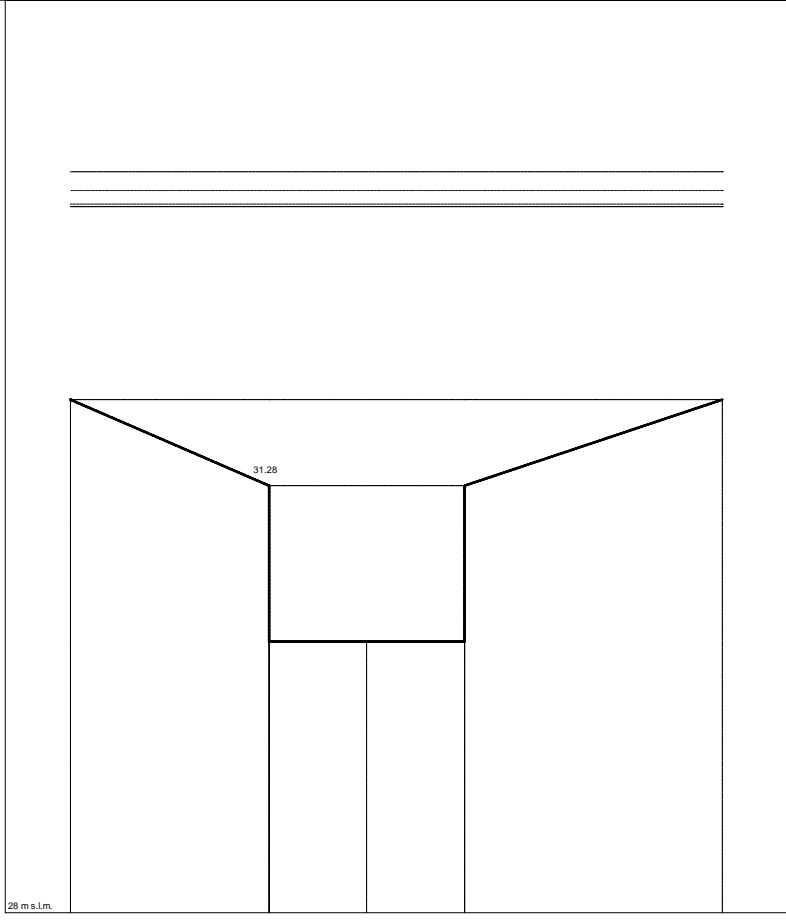

GR1022bi
 Sezione n. GR1022bi

Scala distanze 1:40
 Scala quote 1:40

Punti	1	2	4	5	7
Quote [m s.l.m.]	31.94	31.28	30.08	30.08	31.94
Distanze progressive [m]	0.5	2.0	2.7	3.5	5.5
Distanze parziali [m]		1.5	0.7	0.7	2.0

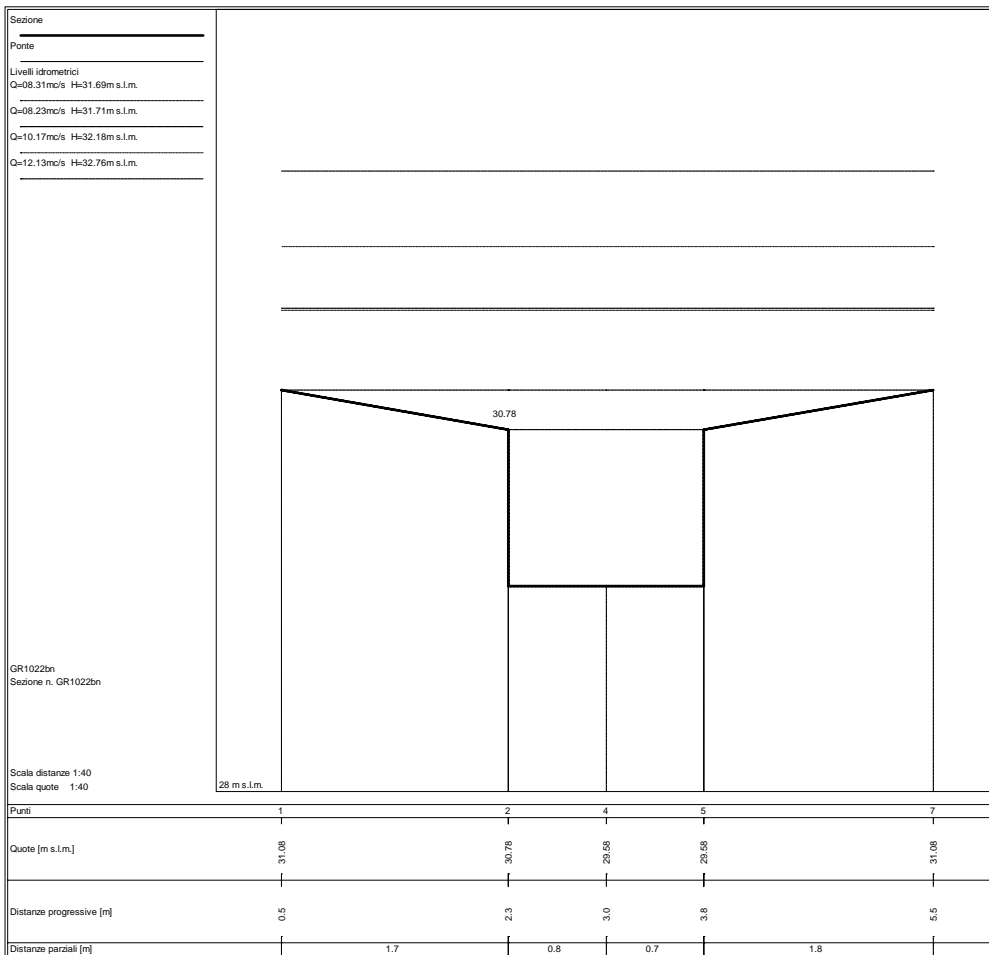
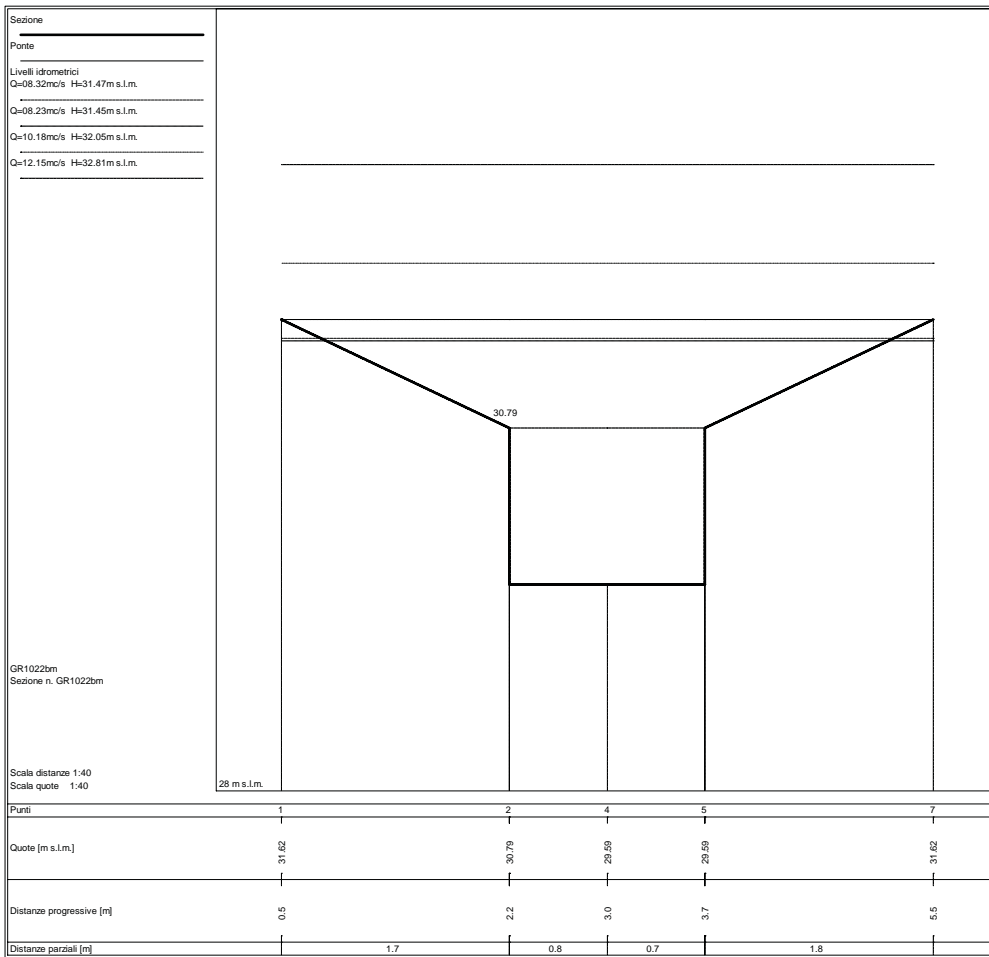

Sezione
 Ponte
 Livelli idrometrici
 Q=07.86mc/s H=31.32m s.l.m.
 Q=07.53mc/s H=31.38m s.l.m.
 Q=09.54mc/s H=32.19m s.l.m.
 Q=10.87mc/s H=32.79m s.l.m.

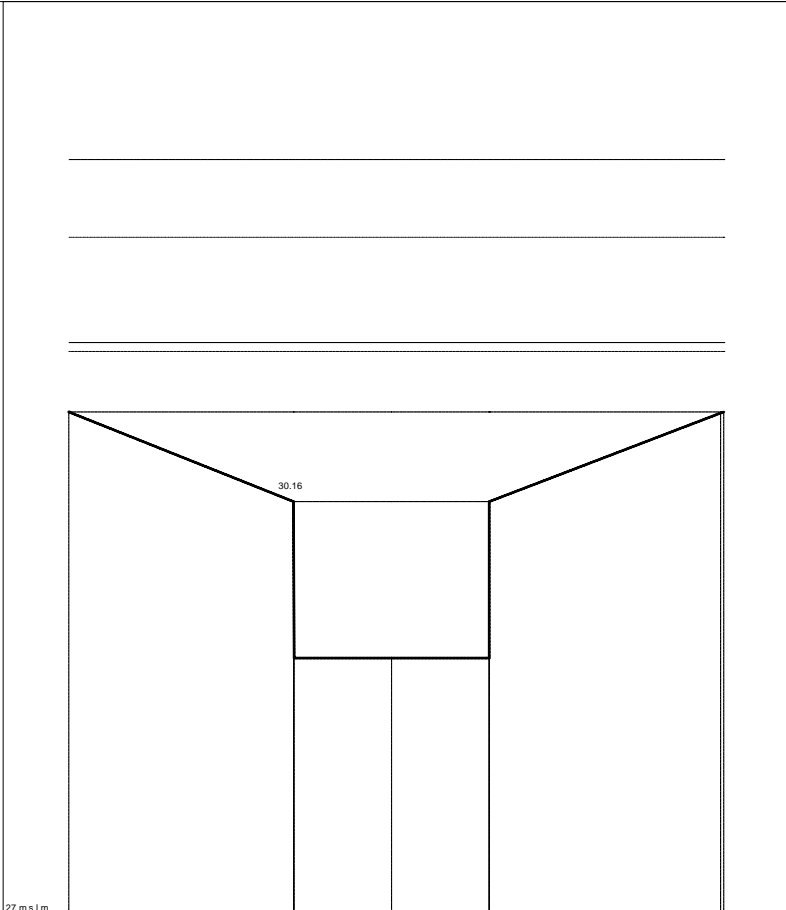

GR1022bo
 Sezione n. GR1022bo

Scala distanze 1:40
 Scala quote 1:40

Punti	1	2	4	5	7
Quote [m s.l.m.]	30.85	30.16	28.96	28.96	30.84
Distanze progressive [m]	0.6	2.4	3.1	3.9	5.6
Distanze parziali [m]		1.7	0.8	0.7	1.8

Sezione
 Ponte
 Livelli idrometrici
 Q=06.95mc/s H=31.25m s.l.m.
 Q=06.50mc/s H=31.23m s.l.m.
 Q=08.26mc/s H=31.96m s.l.m.
 Q=09.76mc/s H=32.63m s.l.m.

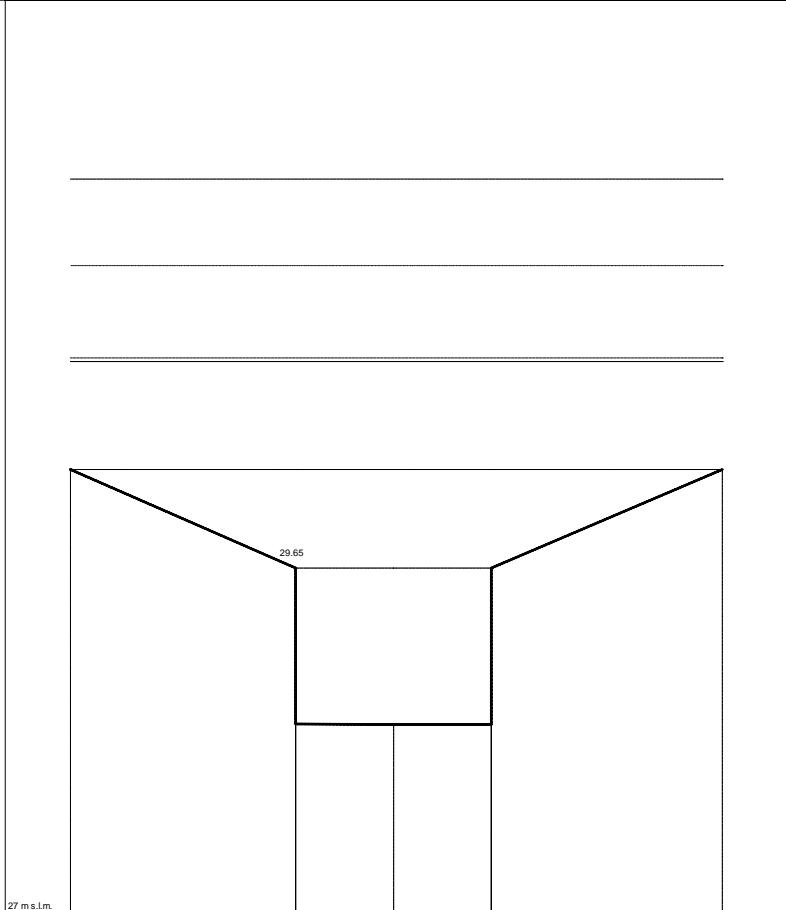

GR1022bp
 Sezione n. GR1022bp

Scala distanze 1:40
 Scala quote 1:40

Punti	1	2	4	5	7
Quote [m s.l.m.]	30.40	29.65	28.45	28.45	30.40
Distanze progressive [m]	0.6	2.3	3.0	3.8	5.6
Distanze parziali [m]		1.7	0.8	0.7	1.8

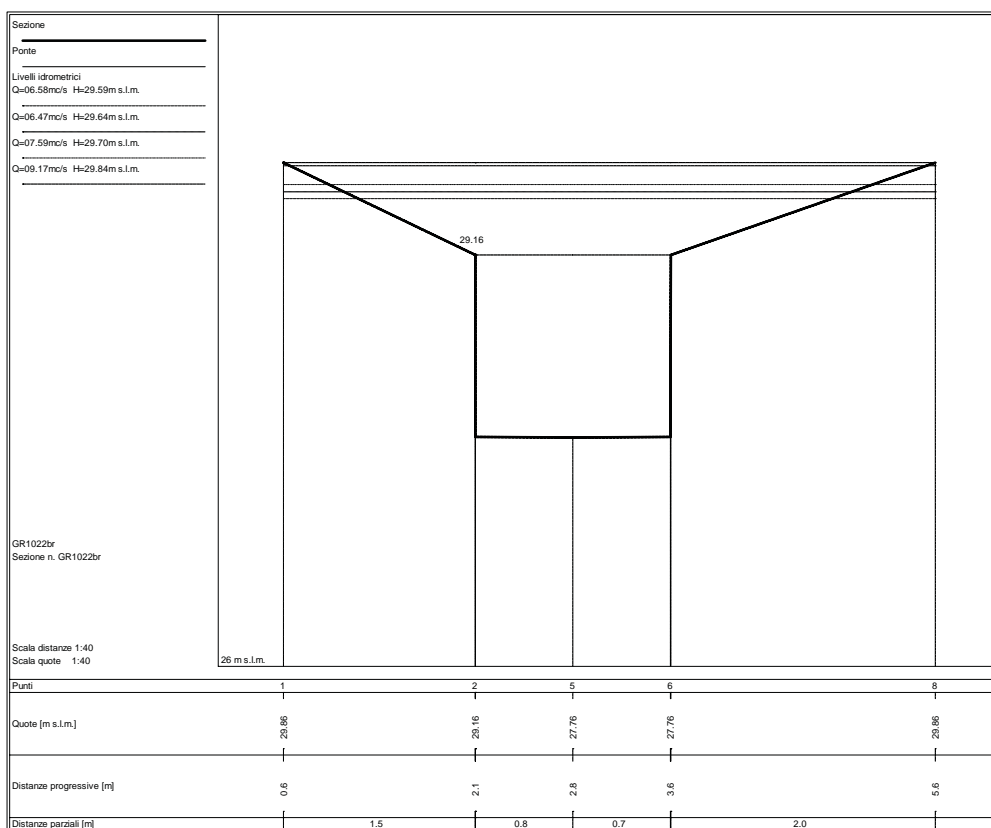
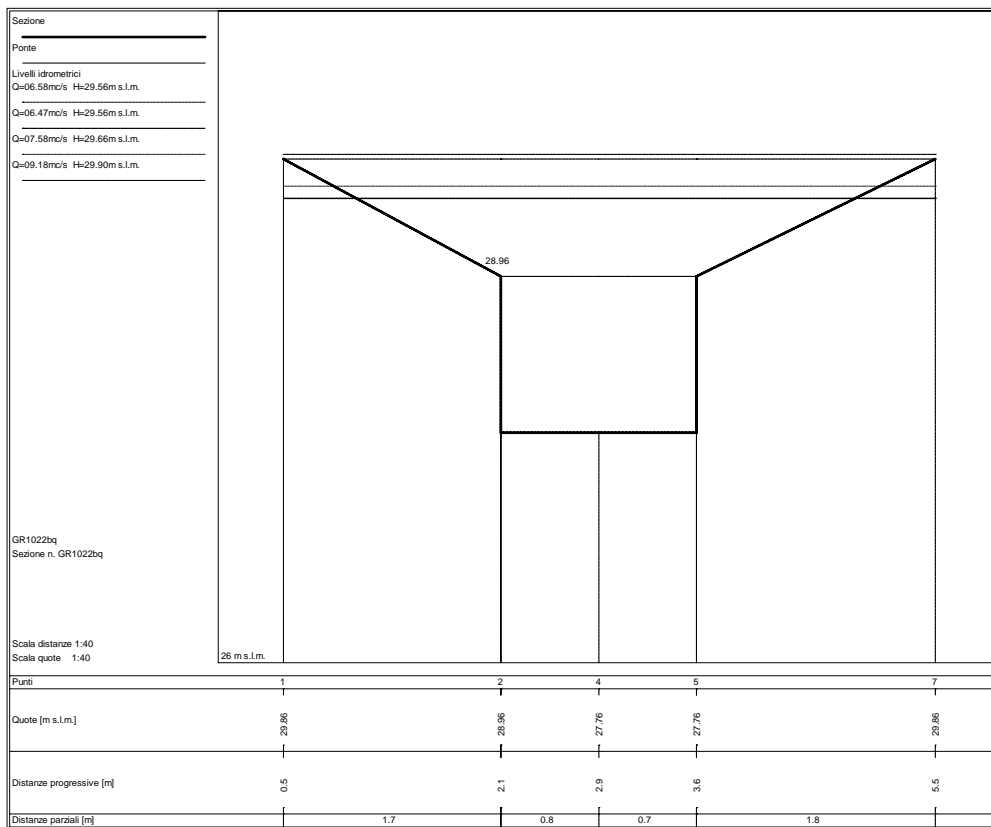

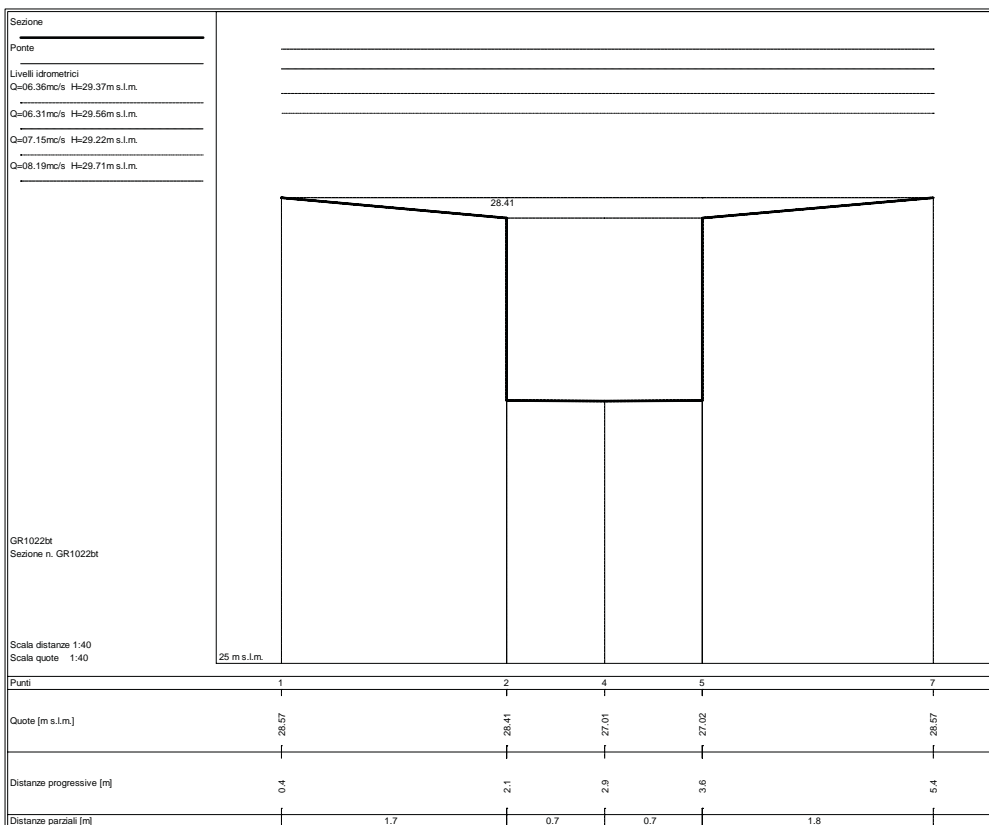
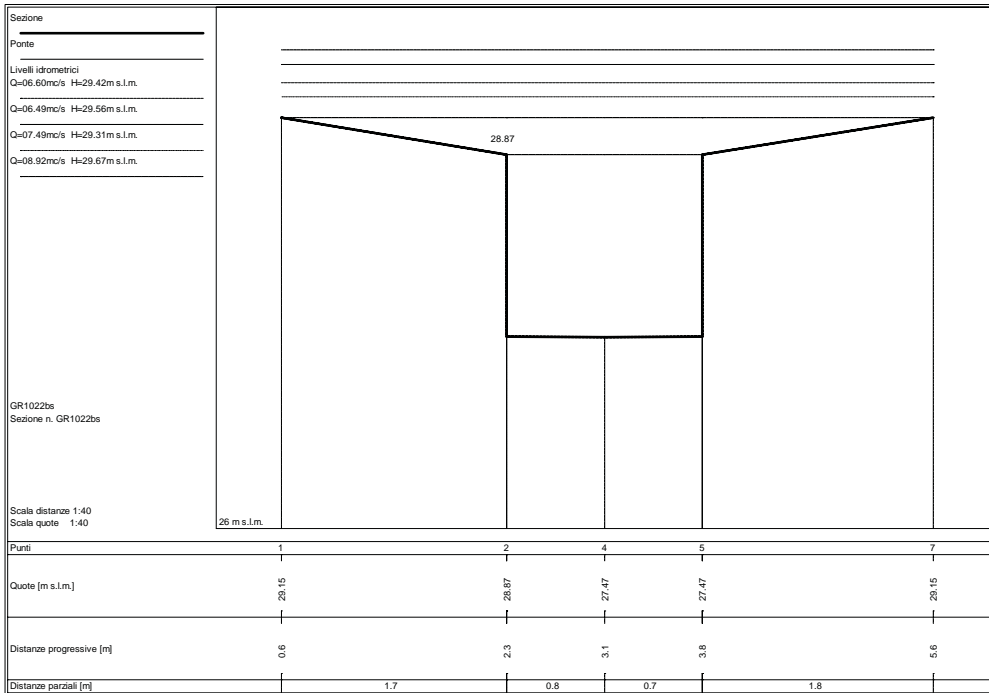

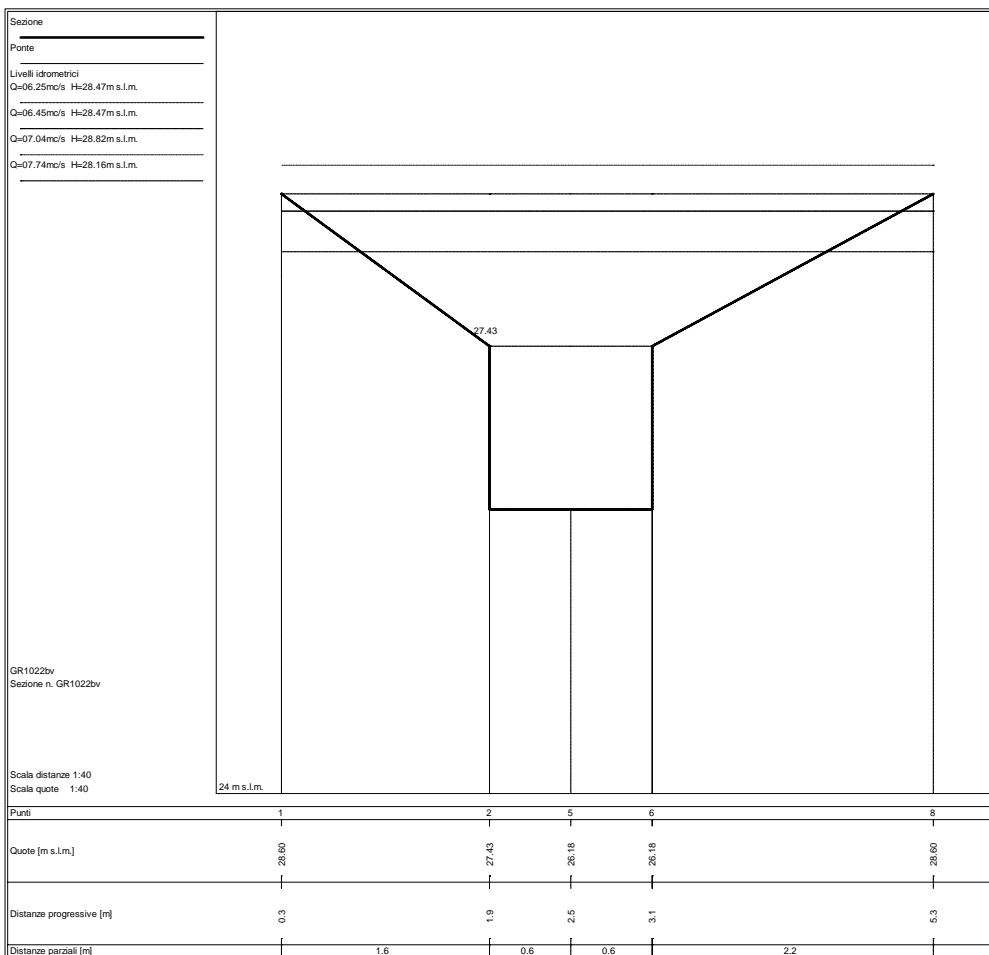
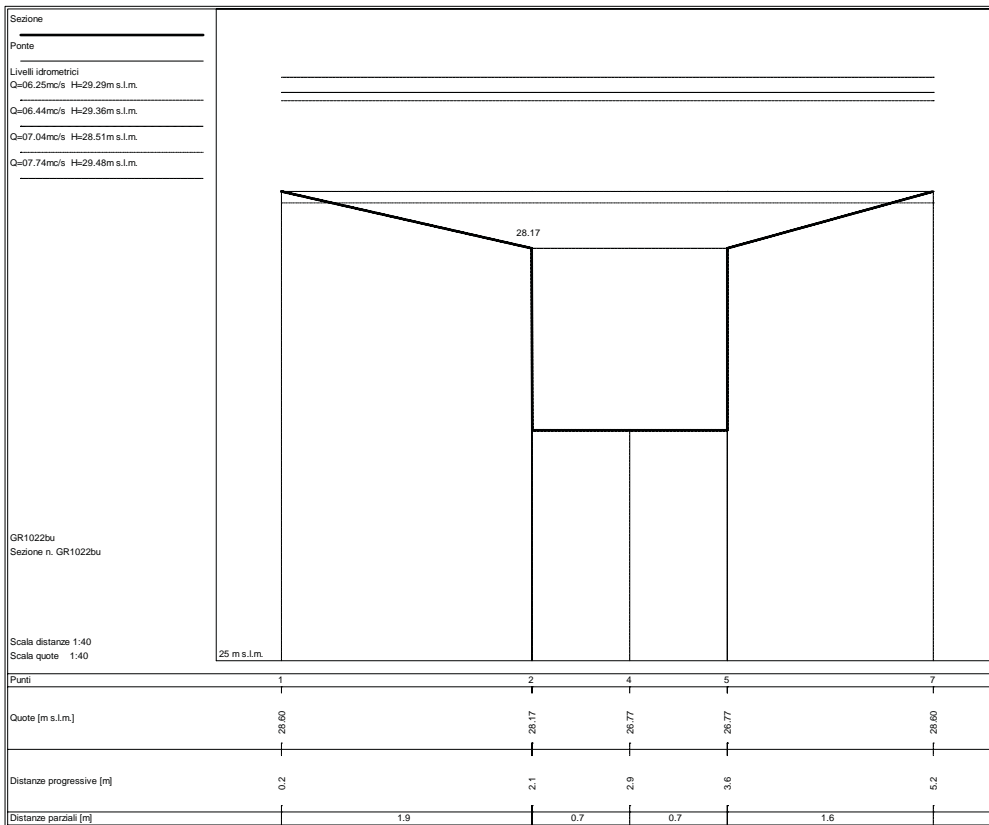

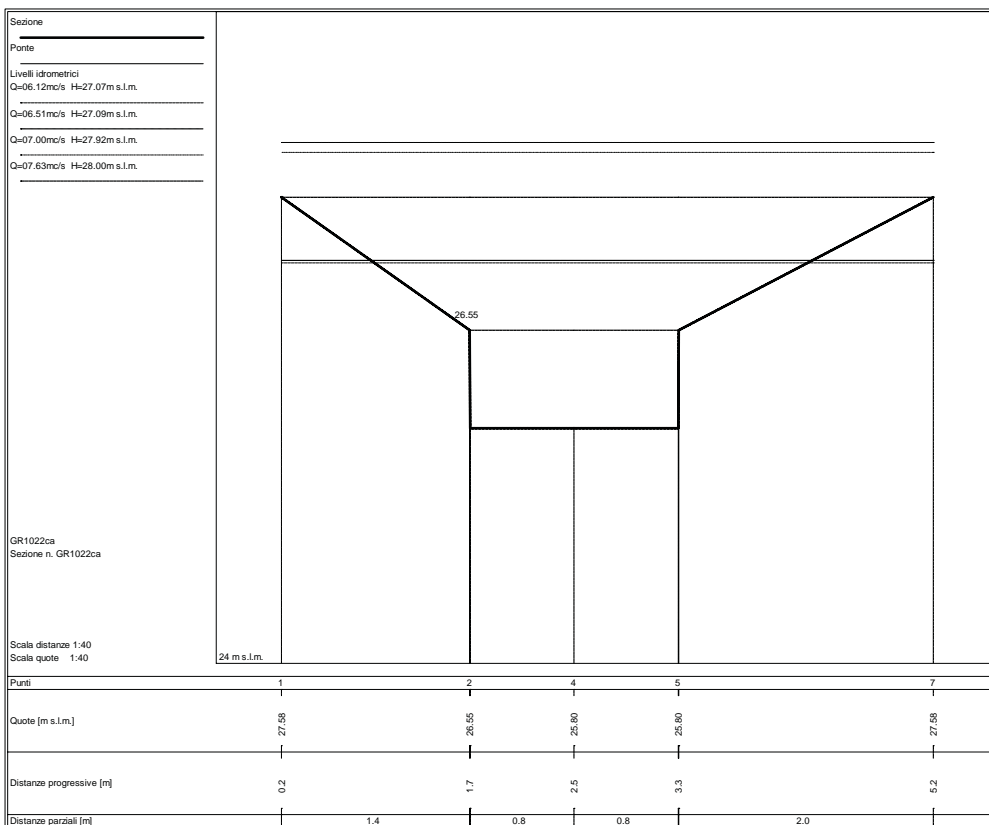
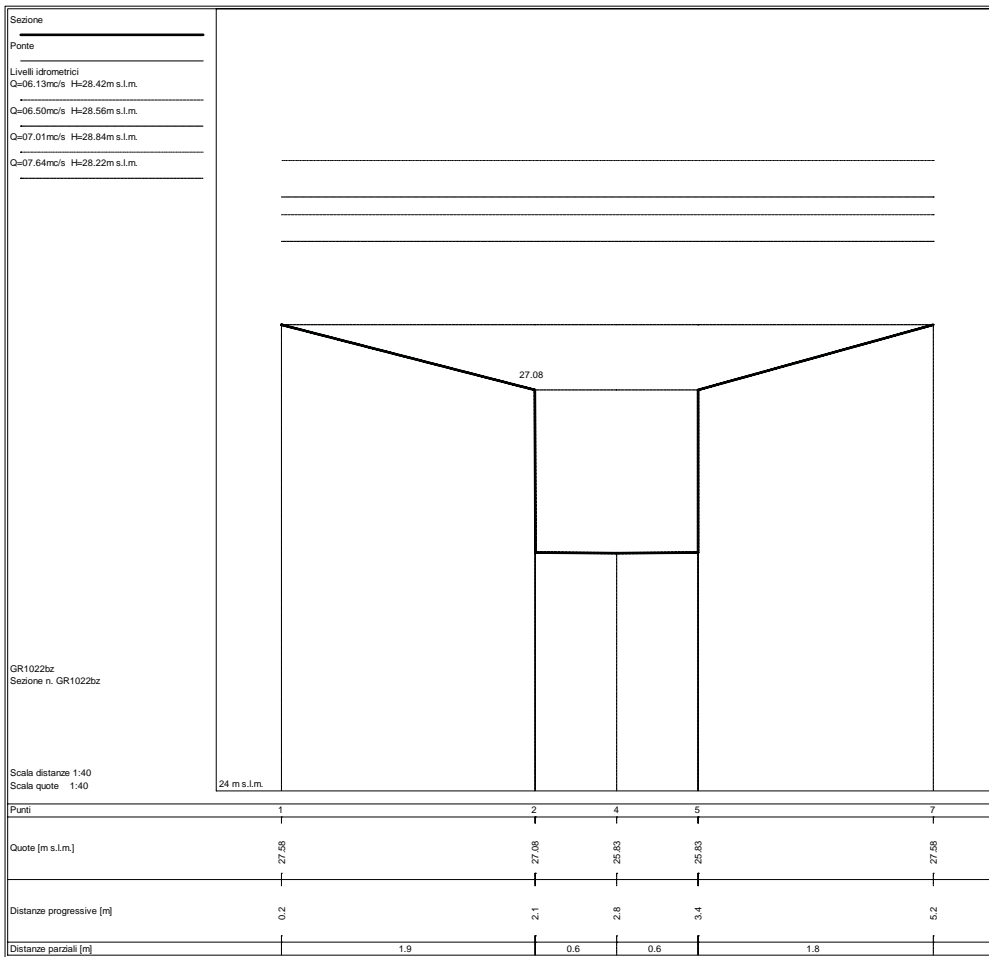

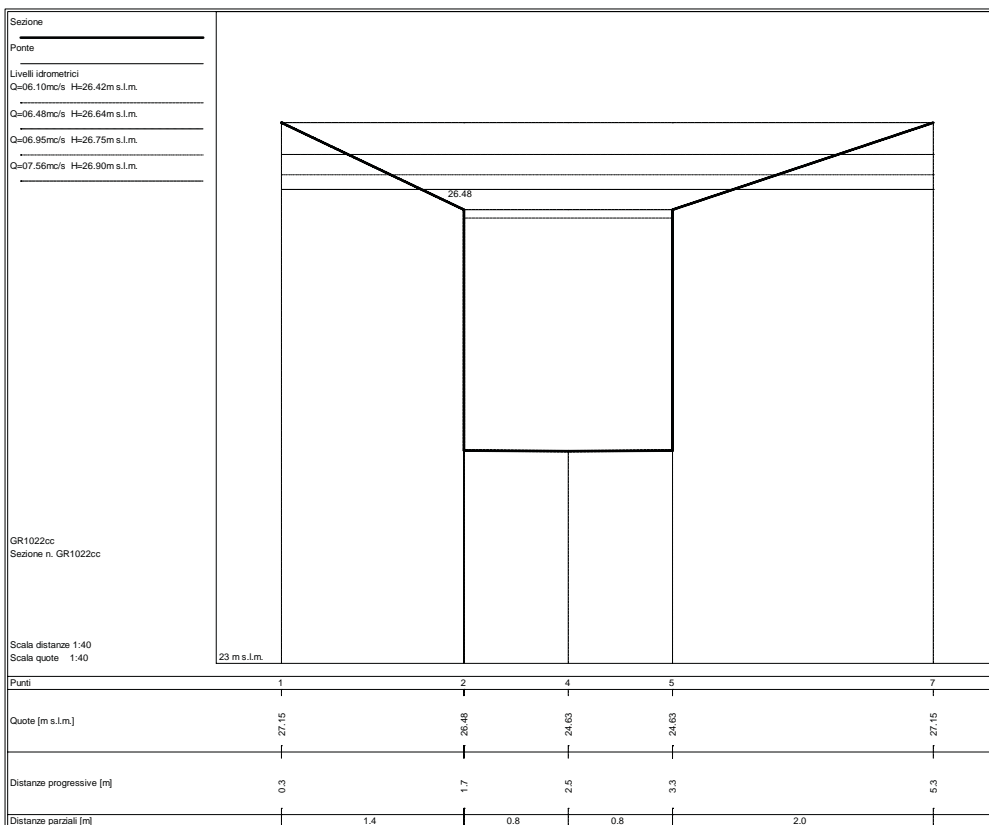
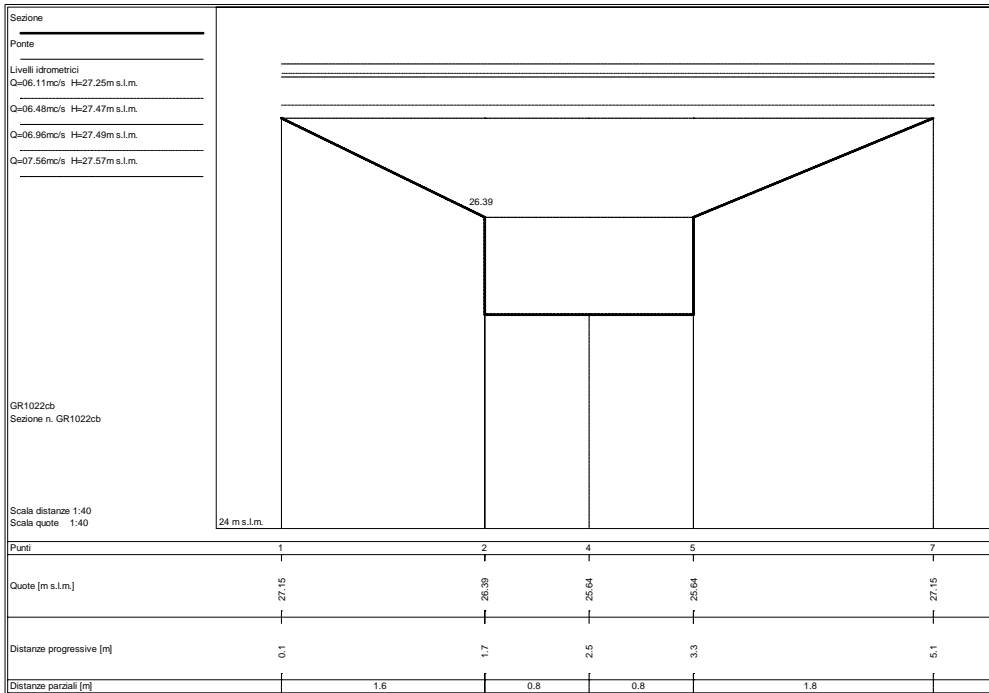

STATO ATTUALE

Sezioni fluviali canale delle Grondini – Grondini_03

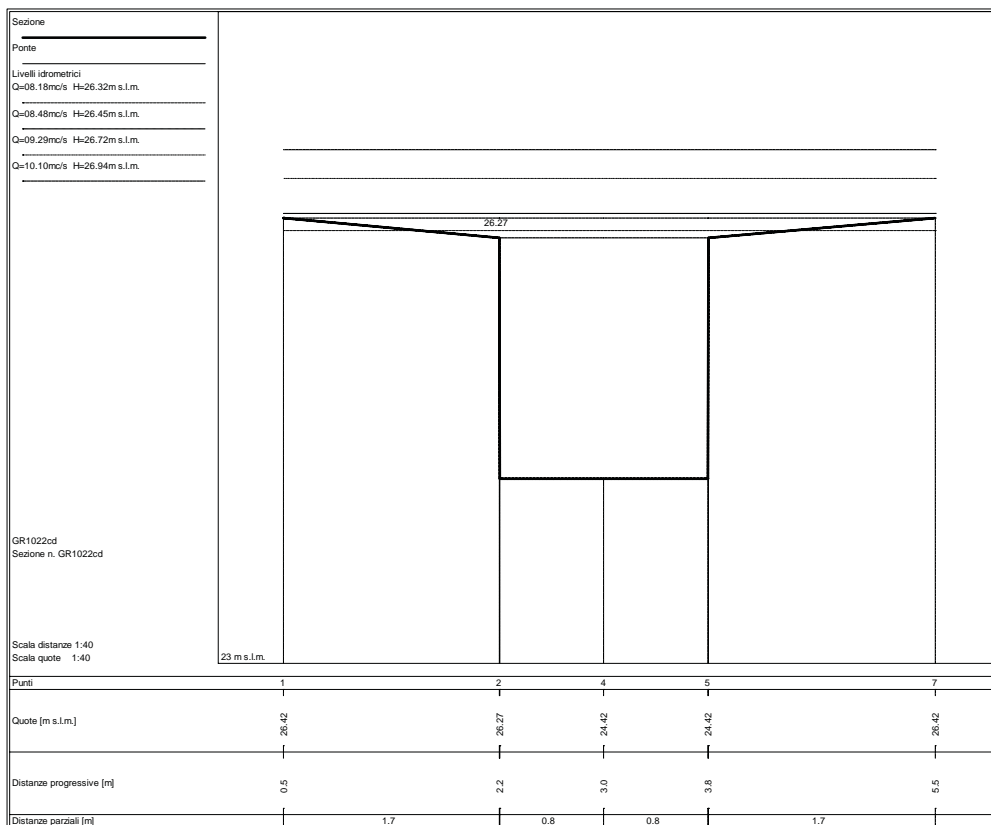
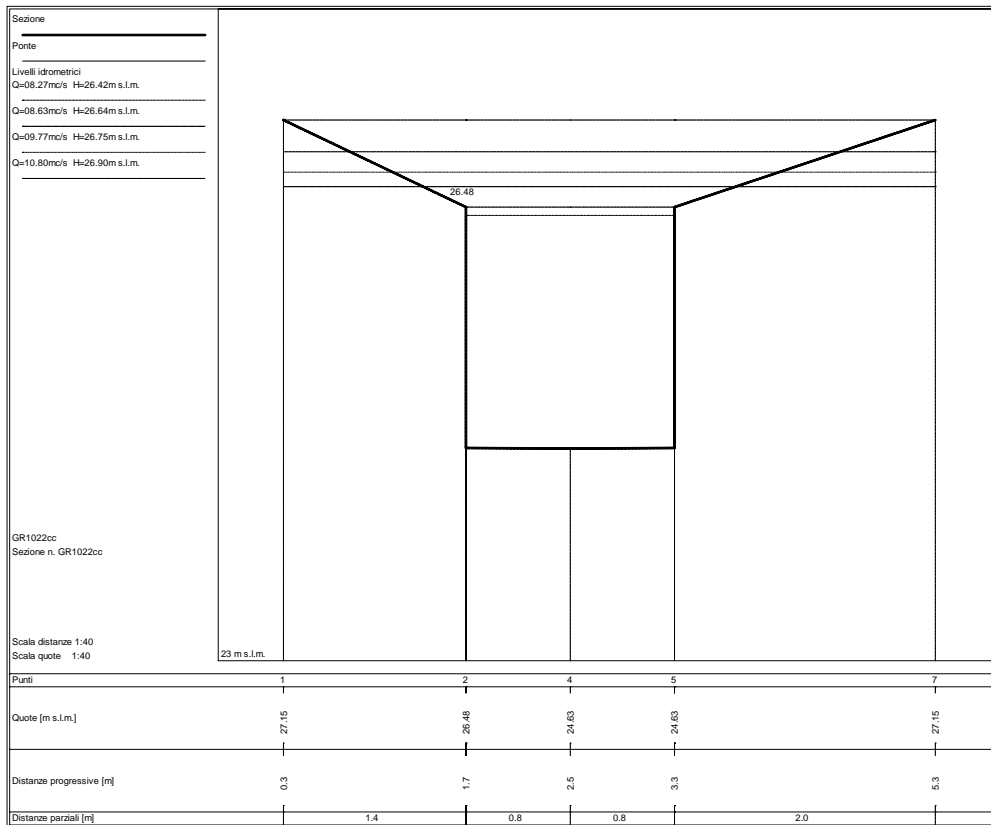

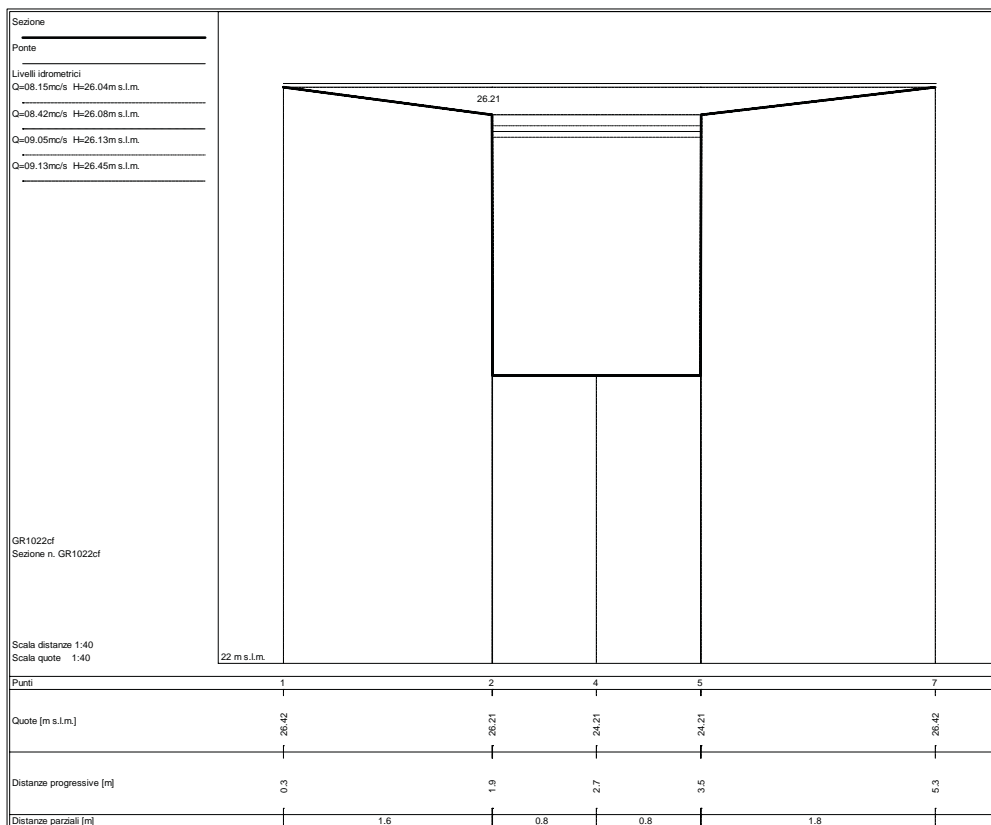
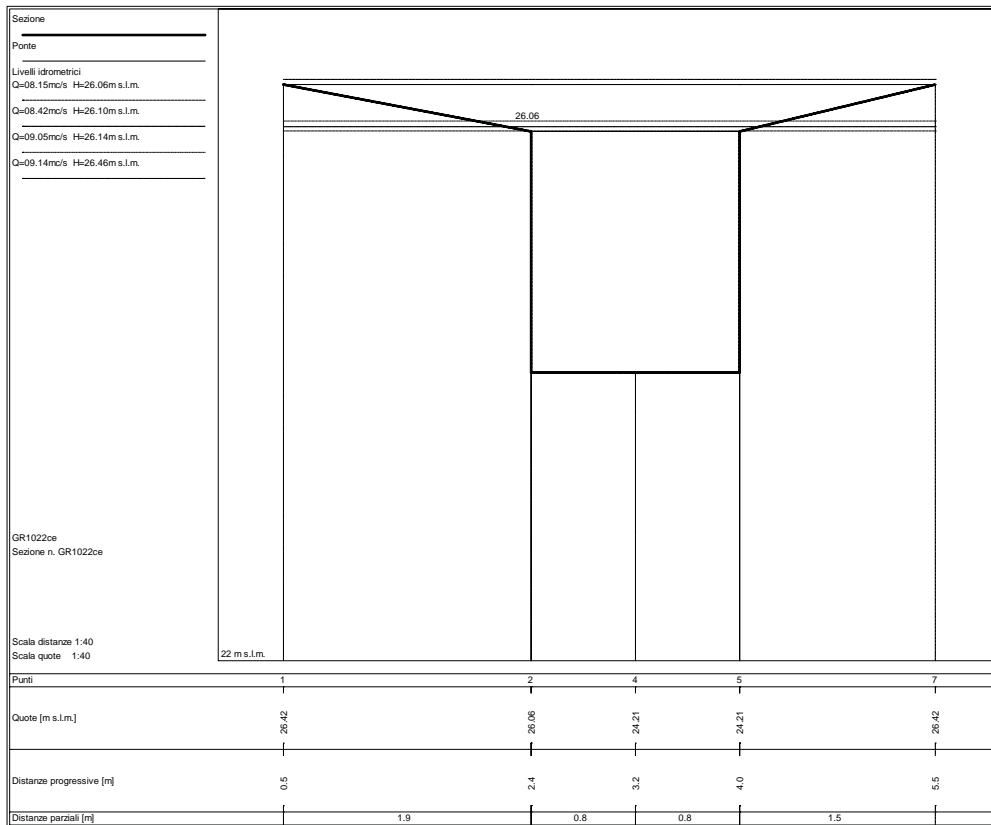

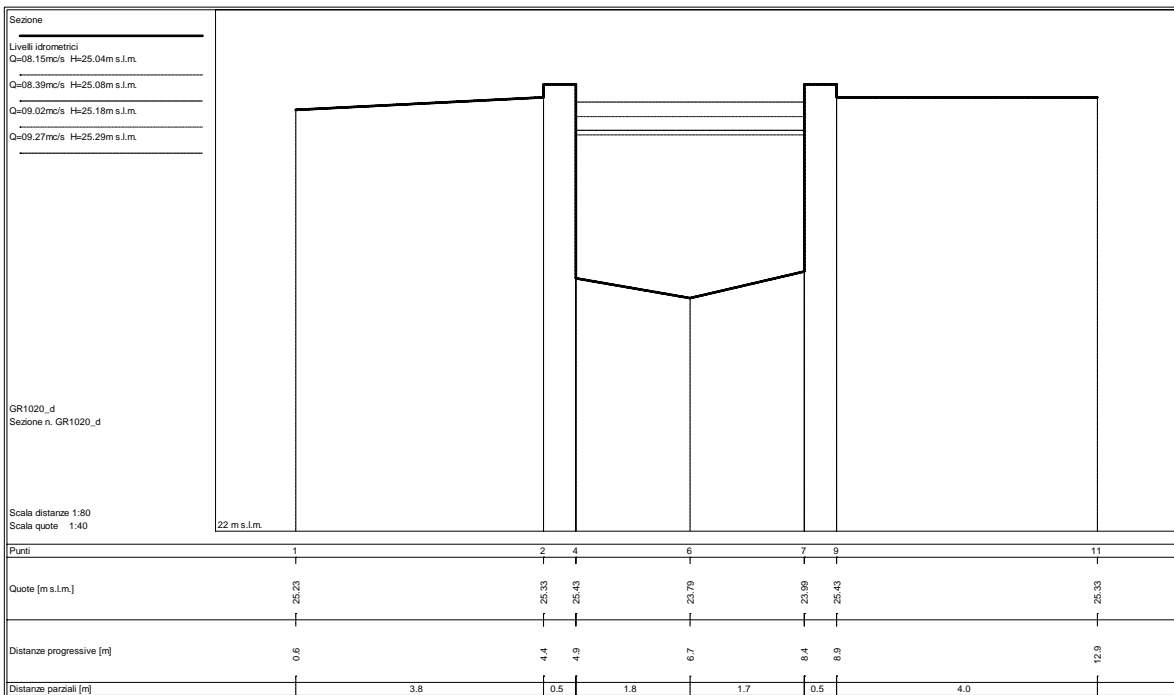
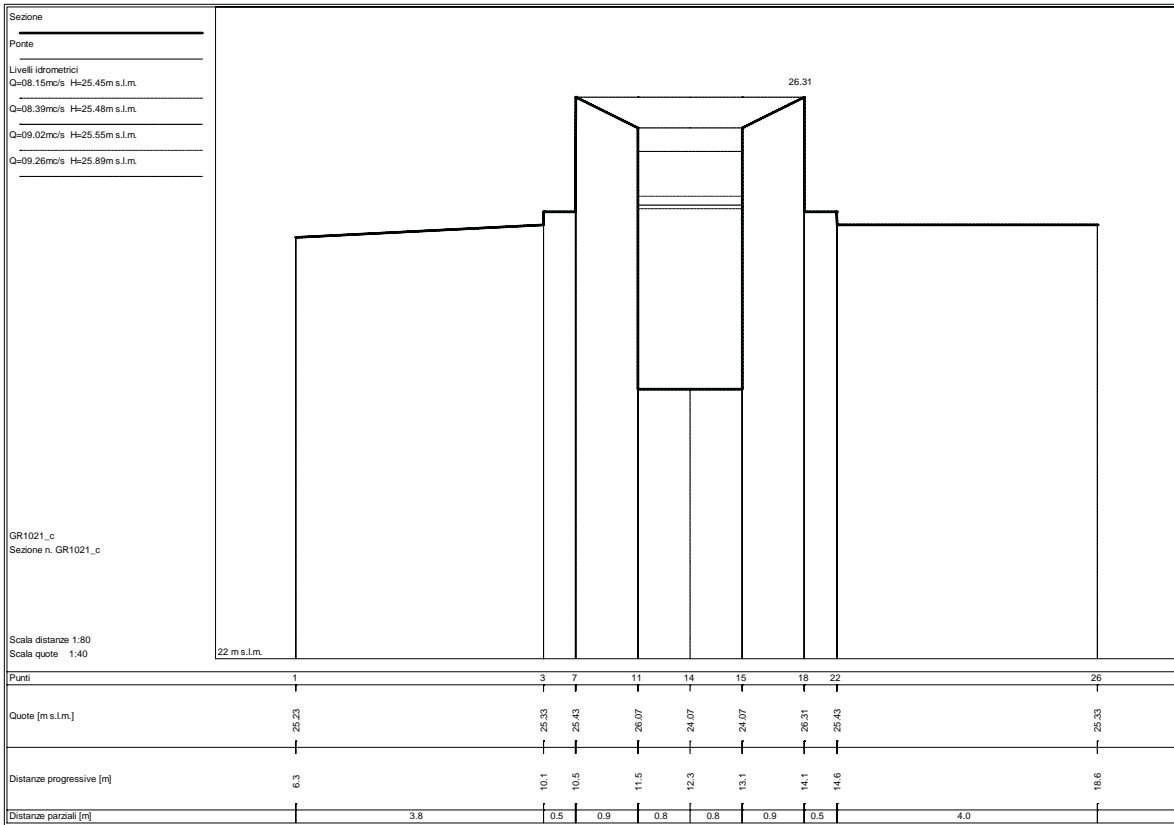

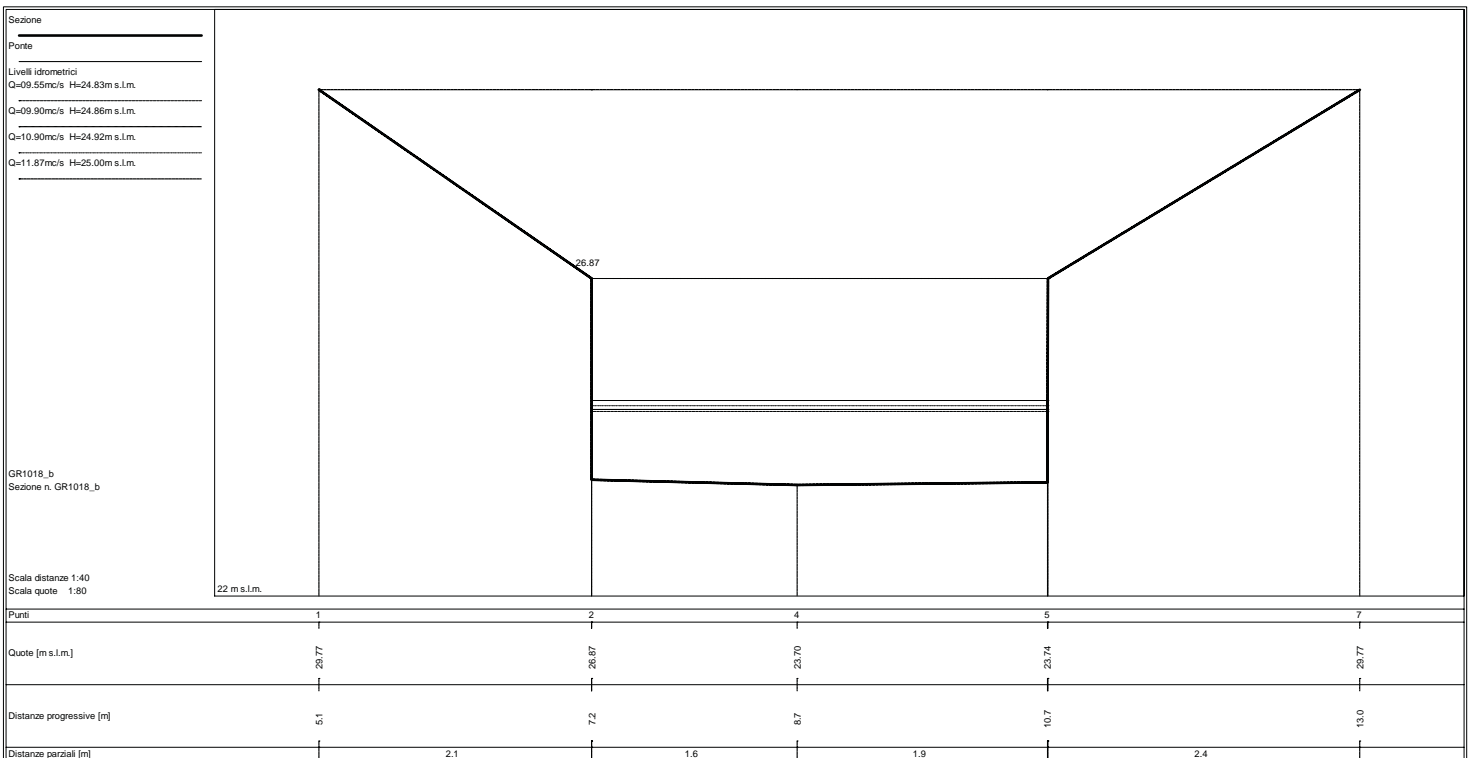
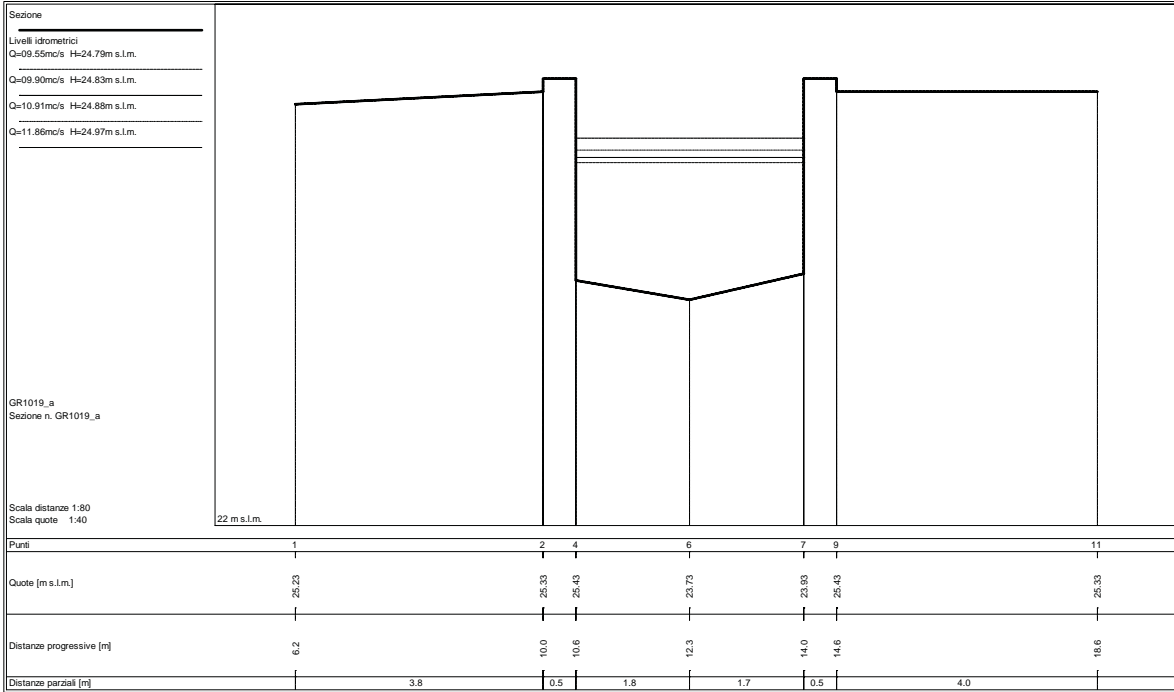

Sezione

Ponte

Livelli idrometrici

Q=09.55mc/s H=24.81m s.l.m.

Q=09.90mc/s H=24.84m s.l.m.

Q=10.88mc/s H=24.90m s.l.m.

Q=11.89mc/s H=24.98m s.l.m.

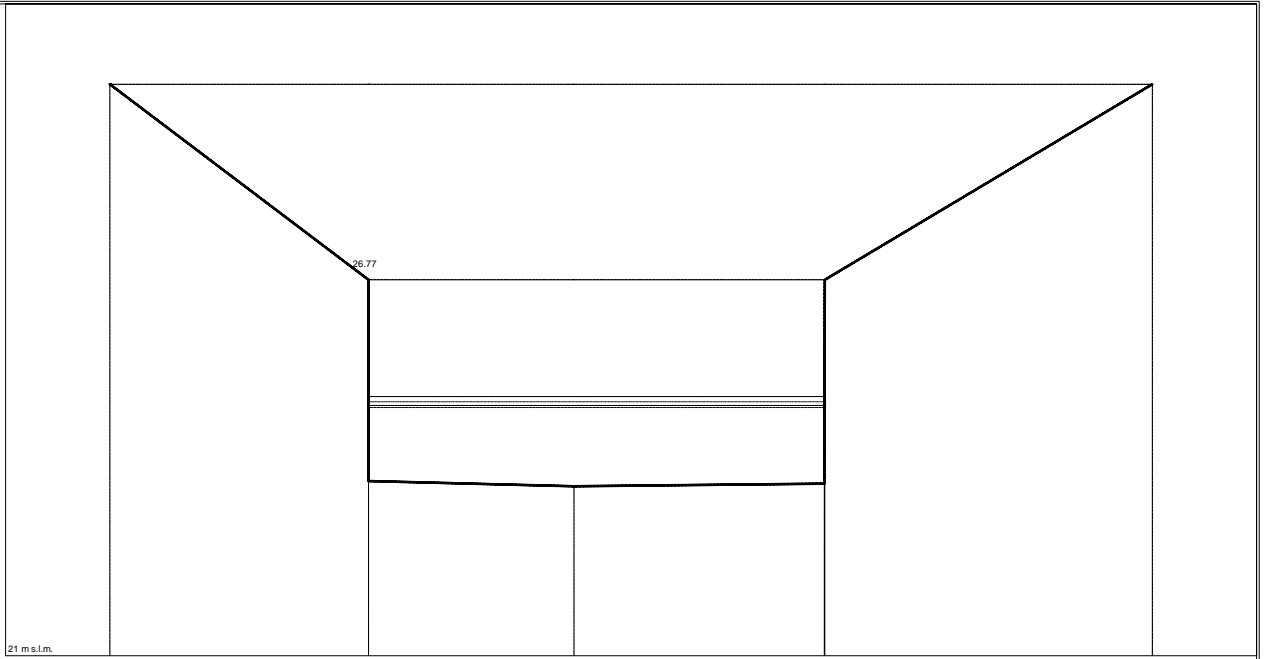

GR1017_c
Sezione n. GR1017_c

Scala distanze 1:40
Scala quote 1:80

Punti	1	2	4	5	7
Quote [m s.l.m.]	29.77	26.77	23.60	23.64	29.77
Distanze progressive [m]	5.2	7.2	8.7	10.7	13.2
Distanze parziali [m]		2.0	1.6	1.9	2.5

Sezione

Ponte

Livelli idrometrici

Q=09.55mc/s H=24.54m s.l.m.

Q=09.91mc/s H=24.56m s.l.m.

Q=10.86mc/s H=24.62m s.l.m.

Q=11.91mc/s H=24.69m s.l.m.

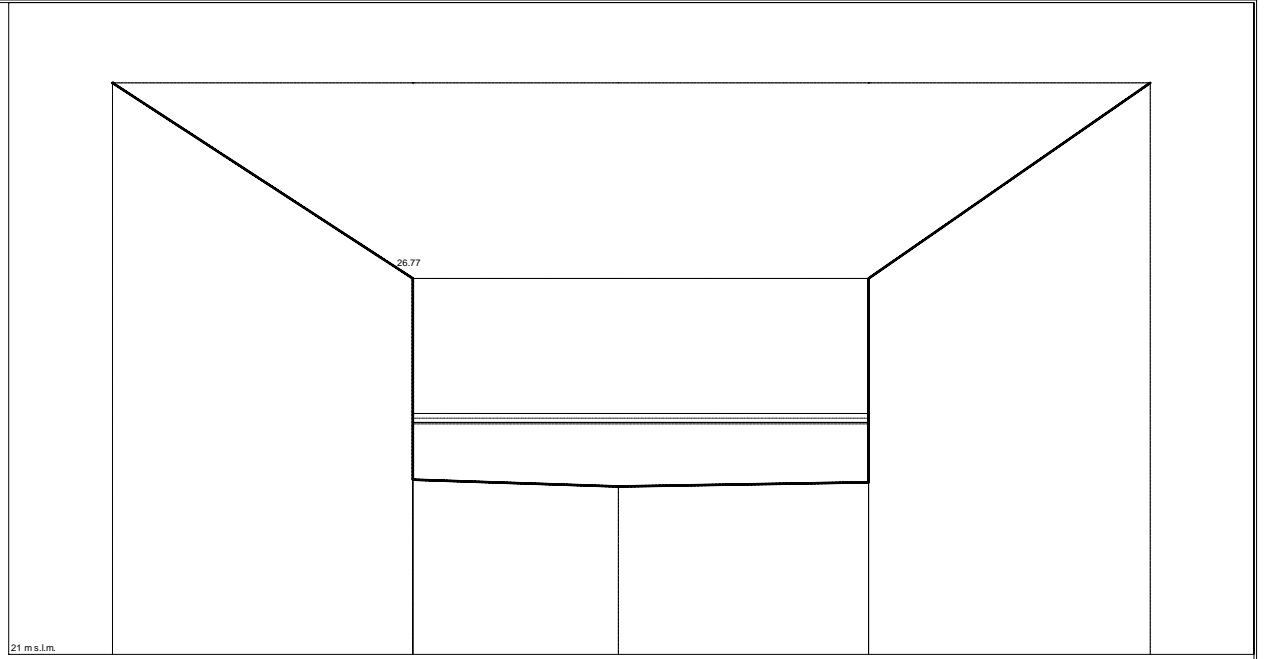

GR1016_d
Sezione n. GR1016_d

Scala distanze 1:40
Scala quote 1:80

Punti	1	2	4	5	7
Quote [m s.l.m.]	29.77	26.77	23.56	23.64	29.77
Distanze progressive [m]	4.9	7.2	8.7	10.7	12.8
Distanze parziali [m]		2.3	1.6	1.9	2.2

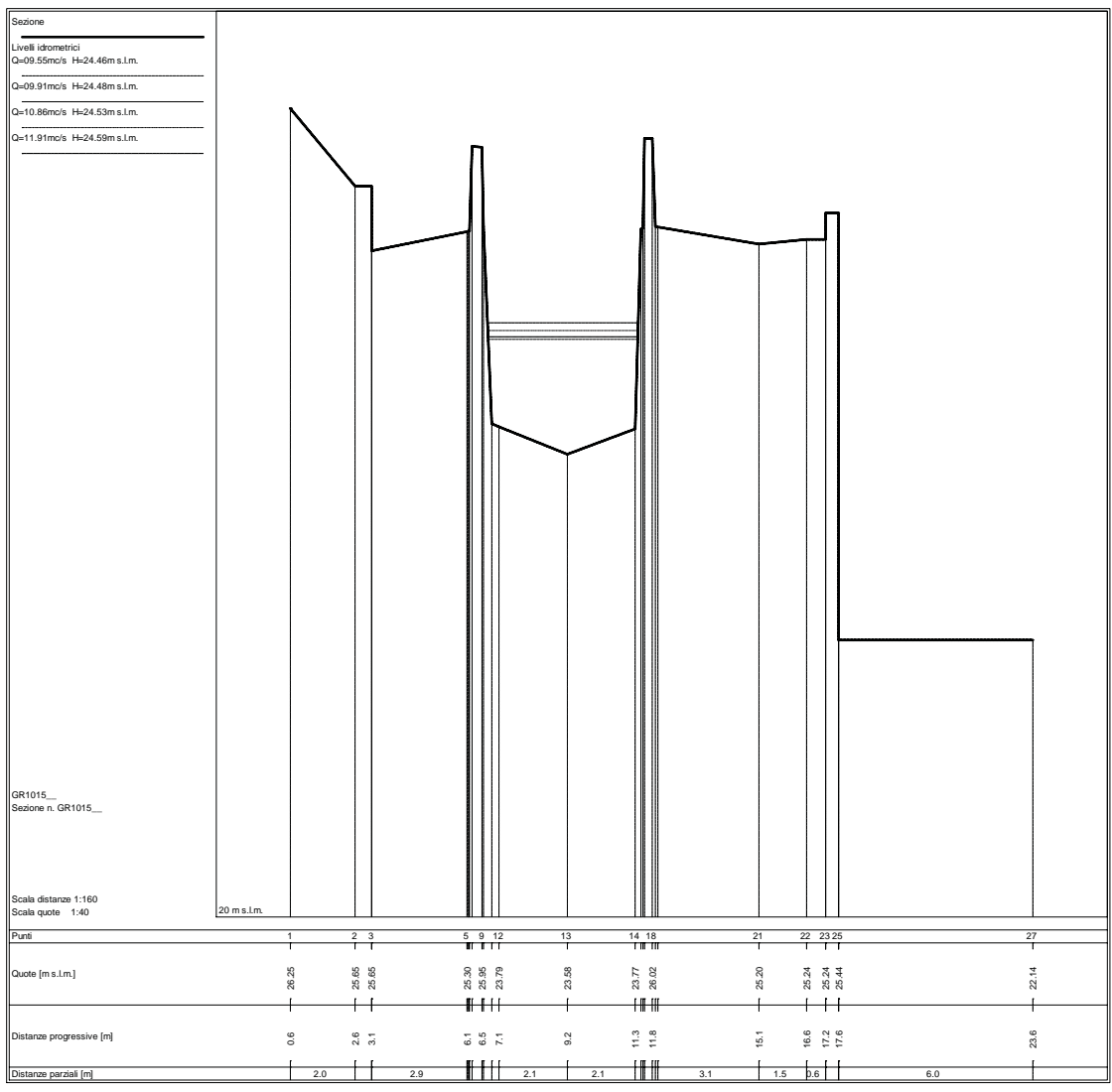
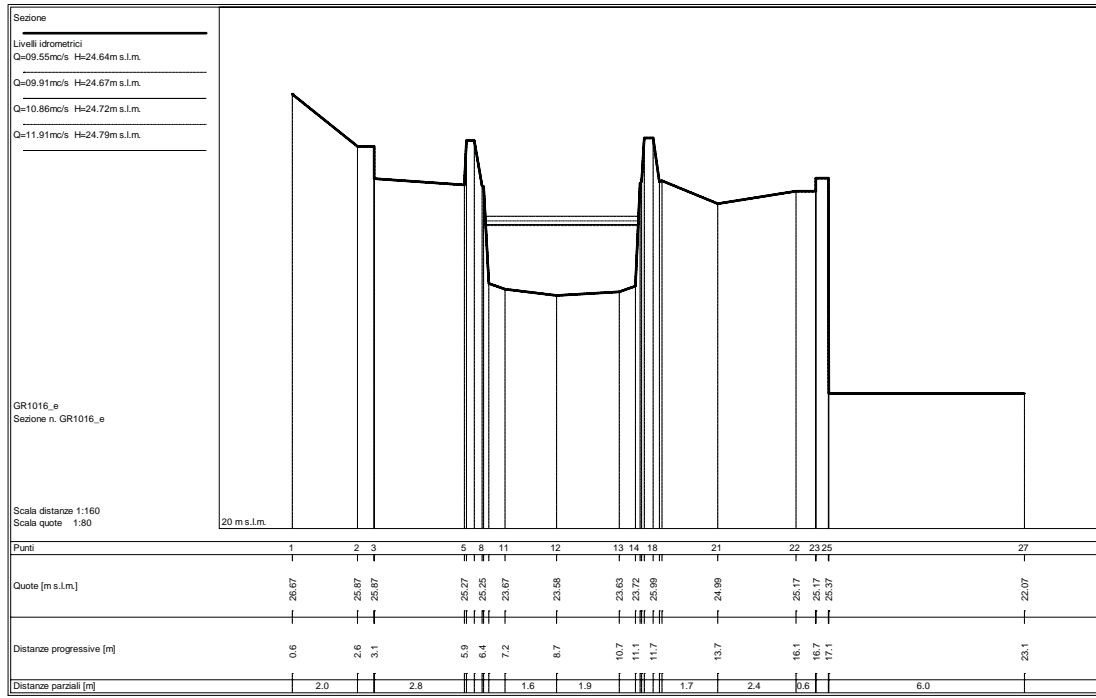

Sezione
 Livelli idrometrici
 Q=09.55mc/s H=24.47m s.L.m.
 Q=09.91mc/s H=24.43m s.L.m.
 Q=10.85mc/s H=24.86m s.L.m.
 Q=11.91mc/s H=24.54m s.L.m.

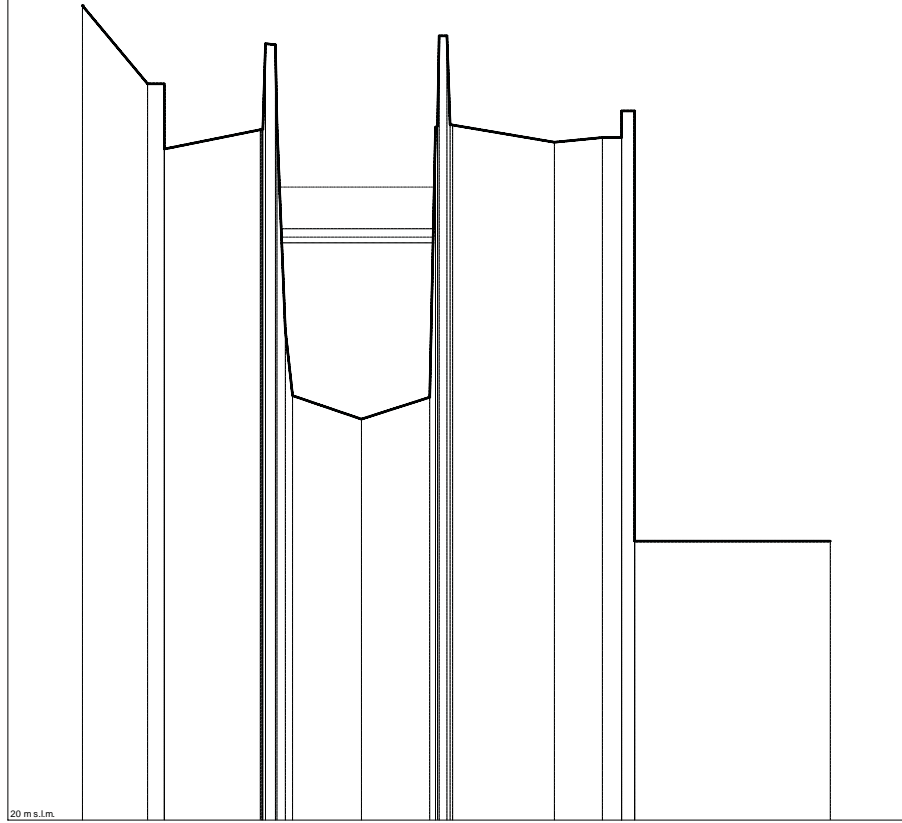

GR1014_
 Sezione n. GR1014_

Scala distanze 1:160
 Scala quote 1:40

20 m s.l.m.

Punti	1	2	3	5	9	12	13	14	18	21	22	23	25	27			
Quote [m s.l.m.]		26.25		25.65	25.65		23.08	23.24	26.02		25.20		25.24	25.24	22.14		
Distanze progressive [m]	0.6		2.6	3.1		6.1	6.5	7.1		9.2	11.3	11.8	15.1	16.6	17.2	17.6	23.6
Distanze parziali [m]		2.0			2.9			2.1	2.1		3.1		1.5	0.6		6.0	

Sezione
 Livelli idrometrici
 Q=09.54mc/s H=24.48m s.L.m.
 Q=09.92mc/s H=24.46m s.L.m.
 Q=10.80mc/s H=24.84m s.L.m.
 Q=11.90mc/s H=24.57m s.L.m.

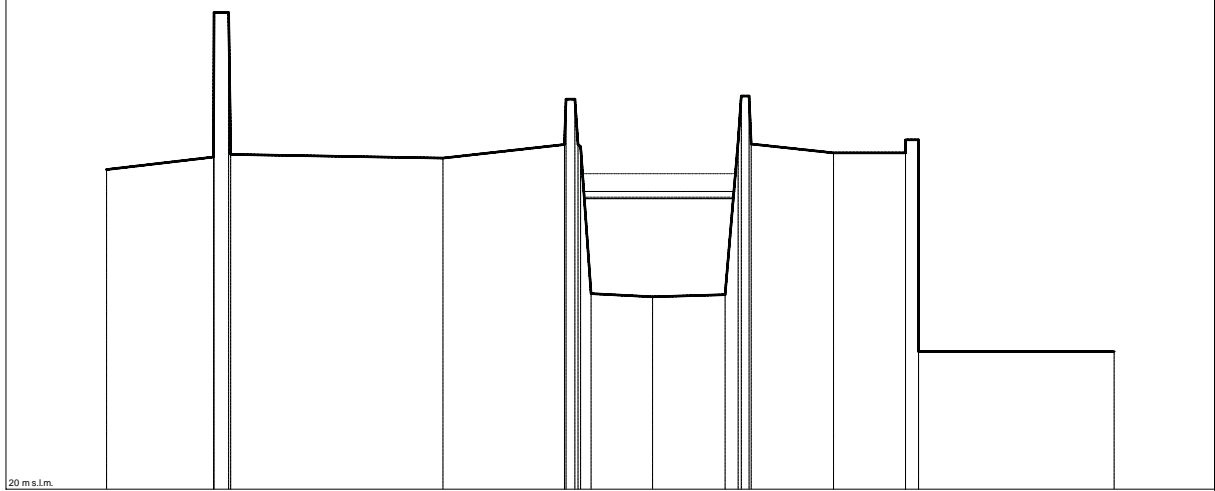

GR1013_
 Sezione n. GR1013_

Scala distanze 1:160
 Scala quote 1:80

20 m s.l.m.

Punti	1	2	4	6	7	9	12	13	14	15	18	19	20	22	24				
Quote [m s.l.m.]	24.90		25.10	27.31		25.08		22.96	25.20	25.09	23.00		25.09	25.29	25.16	25.16	25.36	22.11	
Distanze progressive [m]	0.6		3.9	4.4		10.9		14.7	15.0	15.5		17.4	19.6	20.4	20.4	22.9	25.1	25.5	31.5
Distanze parziali [m]		3.3			6.5		3.7		1.9	2.2		2.5	2.2		6.0				

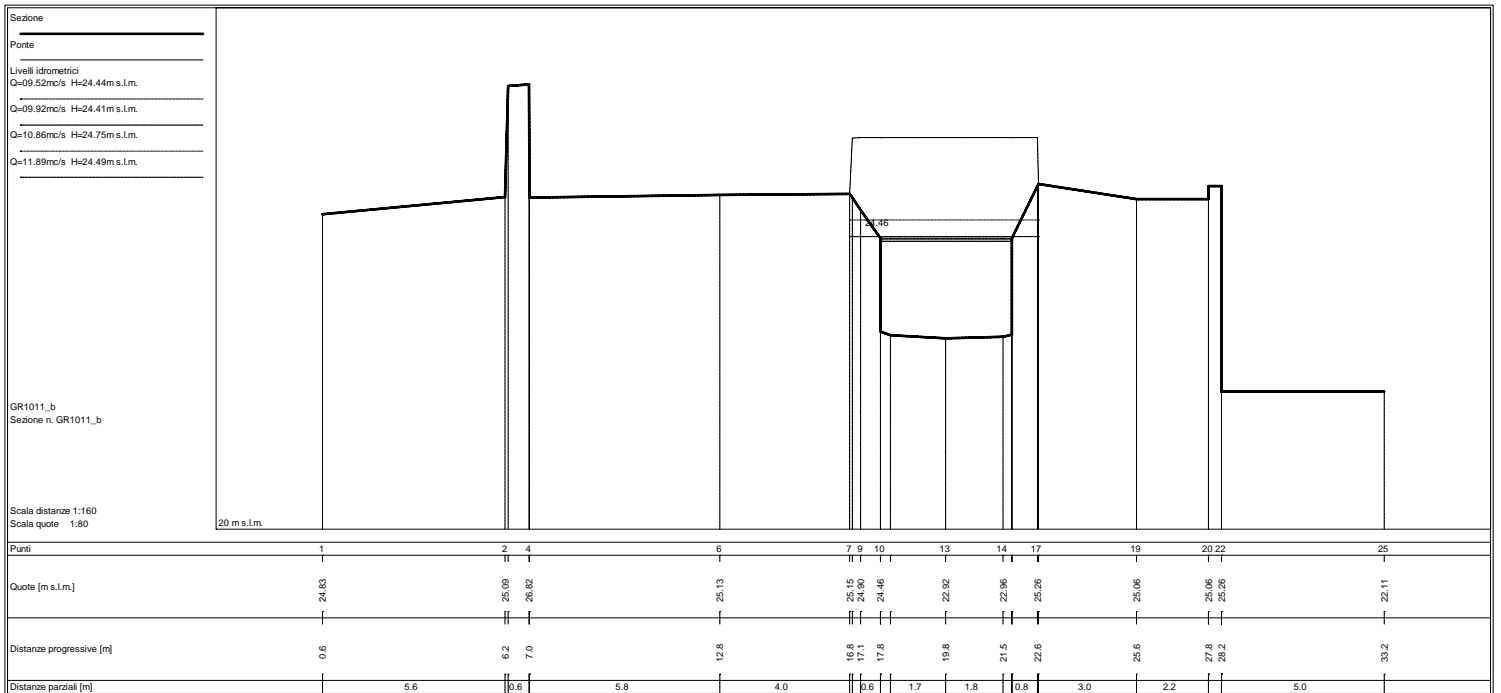
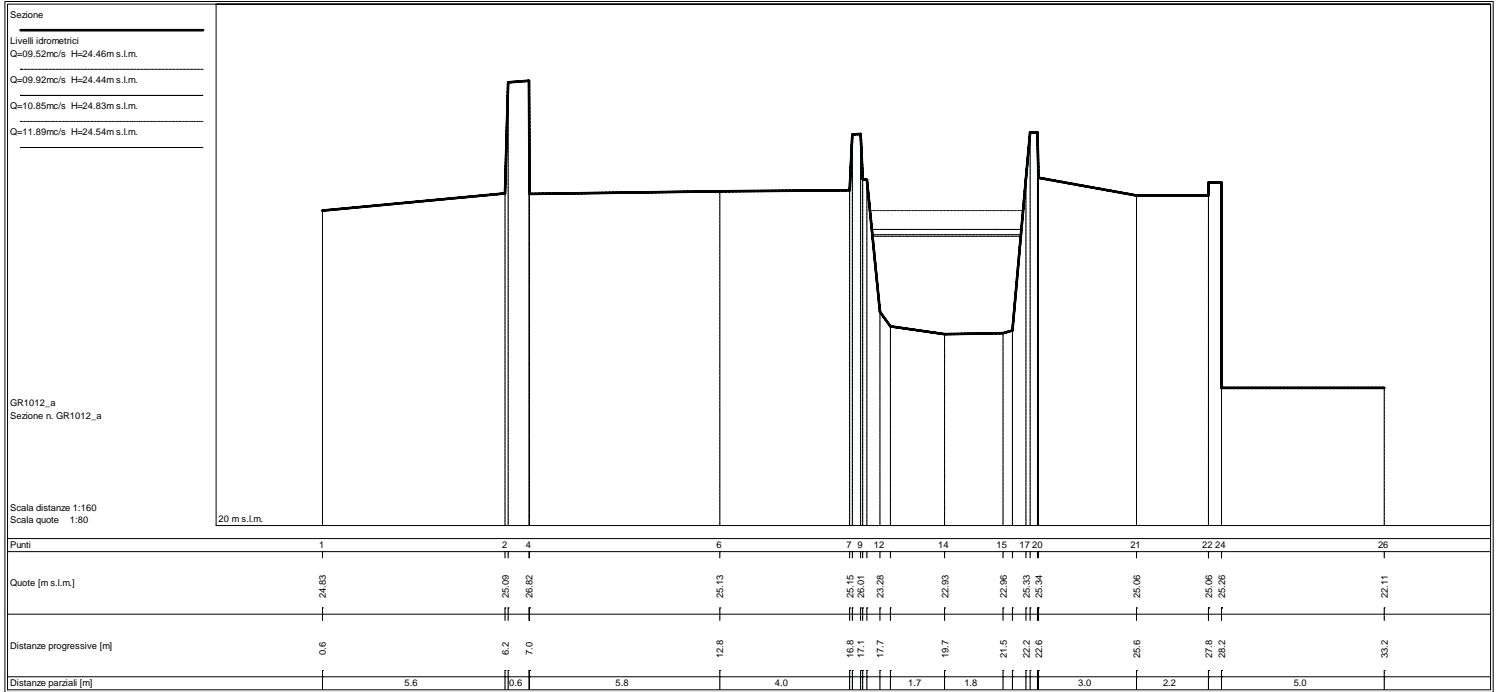

Sezione
 Ponte
 Livelli idrometrici
 Q=09.52mc/s H=24.43m s.l.m.
 Q=09.94mc/s H=24.40m s.l.m.
 Q=10.98mc/s H=24.73m s.l.m.
 Q=11.81mc/s H=24.46m s.l.m.

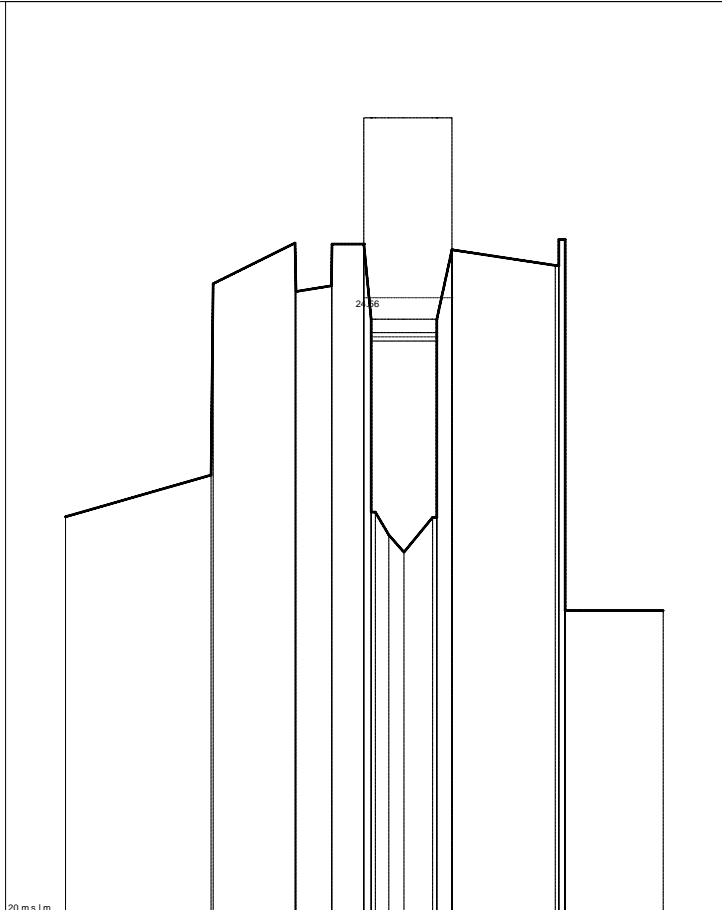

GR1010_a
 Sezione n. GR1010_a

Scala distanze 1:320
 Scala quote 1:40

20 m s.l.m.

Punti	1	2	4	6	8	13	14	15	18	20	26
Quote [m s.l.m.]	23.05	23.37	25.15	24.82	25.14	22.81	22.78	23.04	25.10	24.98	22.33
Distanze progressive [m]	0.6	9.6	14.7	16.9	18.9	20.5	21.4	23.2	24.3	30.7	37.3
Distanze parziali [m]		8.9	5.0	2.2	1.9	1.7	1.7	2.2	6.4	6.0	

Sezione
 Ponte
 Livelli idrometrici
 Q=09.52mc/s H=24.33m s.l.m.
 Q=09.94mc/s H=24.27m s.l.m.
 Q=10.98mc/s H=24.65m s.l.m.
 Q=11.81mc/s H=24.32m s.l.m.

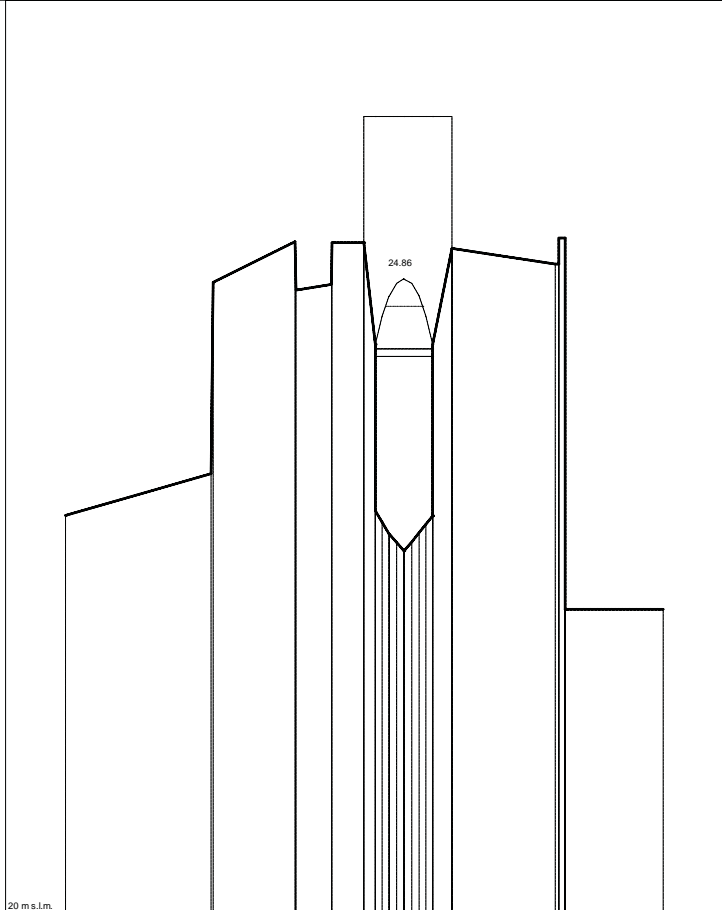

GR1010_b
 Sezione n. GR1010_b

Scala distanze 1:320
 Scala quote 1:40

20 m s.l.m.

Punti	1	2	4	6	8	13	16	19	21	26	28	34
Quote [m s.l.m.]	23.05	23.37	25.15	24.82	25.14	23.00	22.84	22.85	22.88	25.10	24.98	22.33
Distanze progressive [m]	0.6	9.6	14.7	16.9	18.9	20.1	21.0	21.9	22.8	24.3	30.7	37.3
Distanze parziali [m]		8.9	5.0	2.2	1.9	1.2	0.9	0.9	0.9	6.4	6.0	

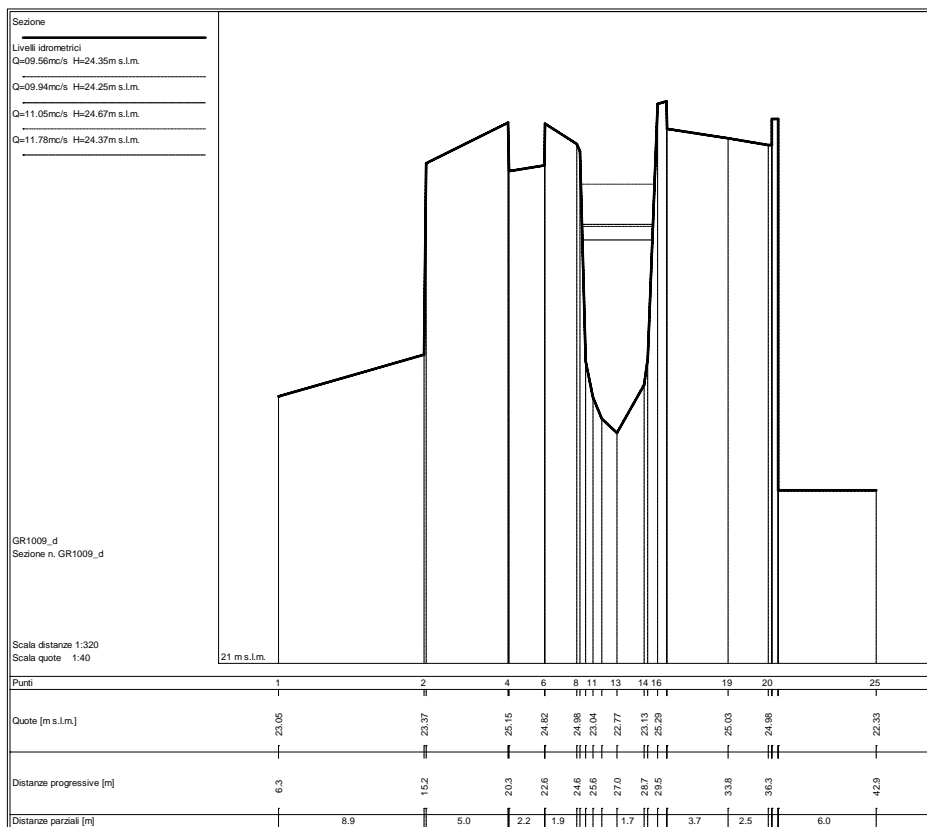
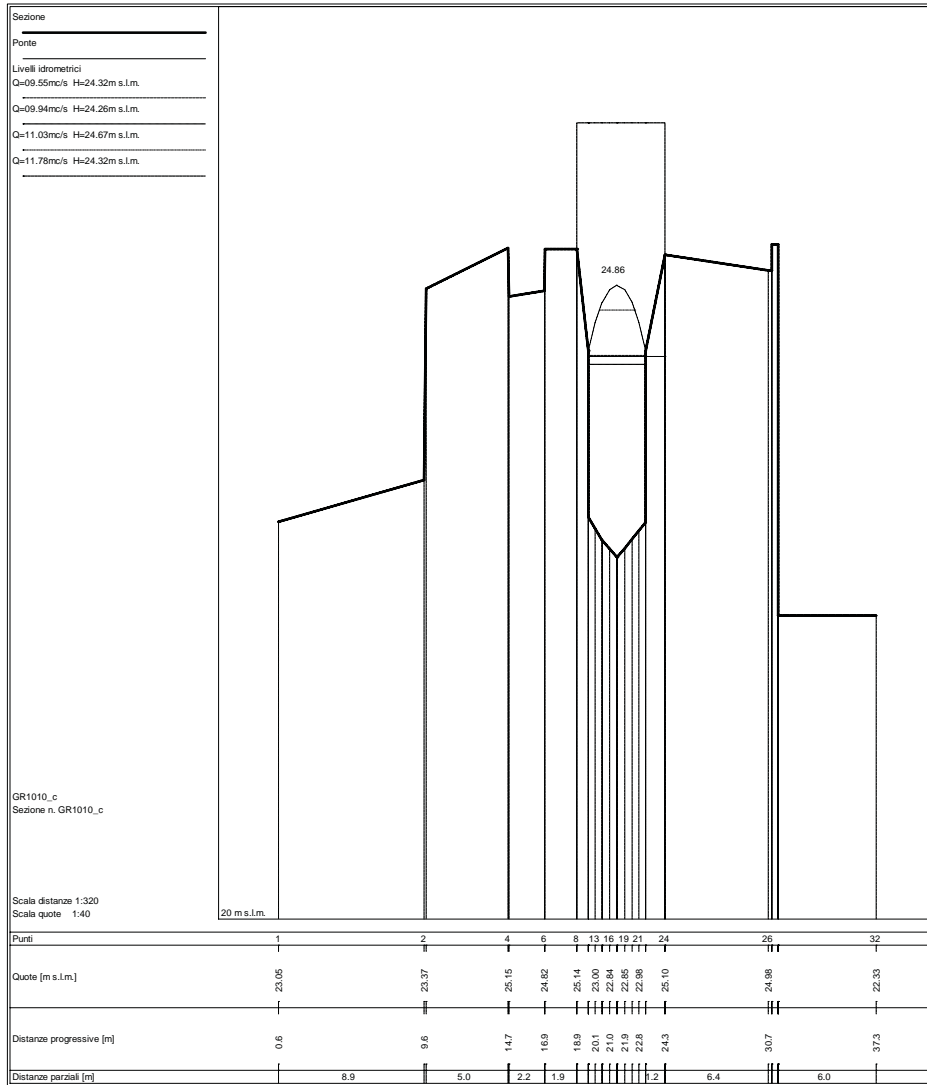

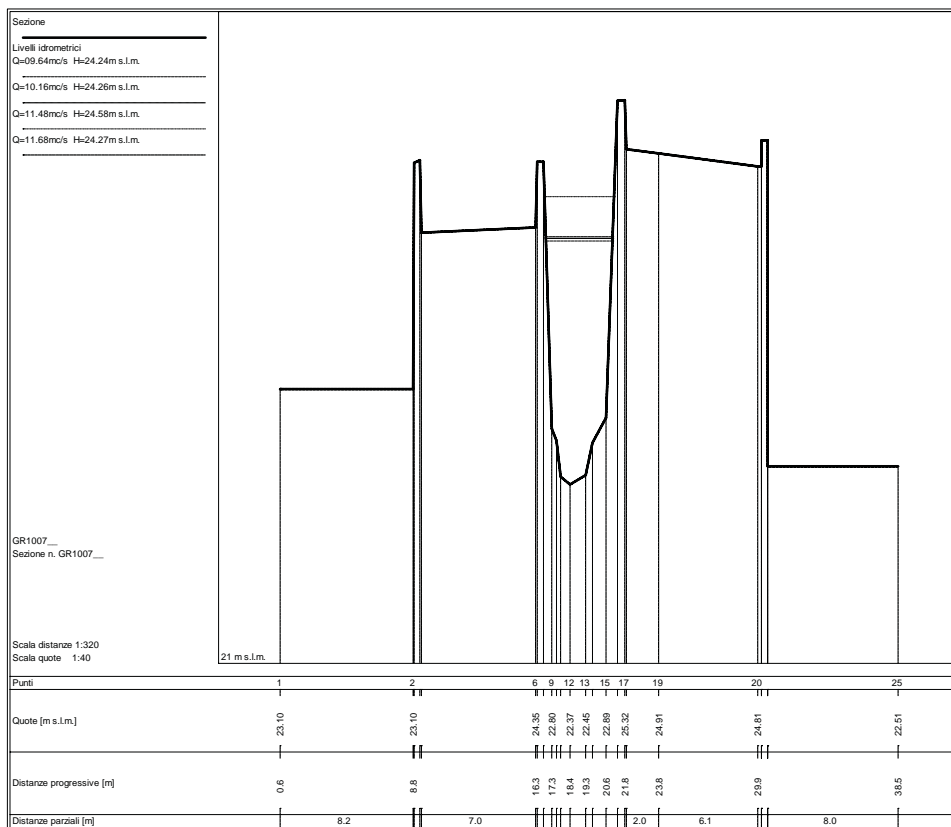
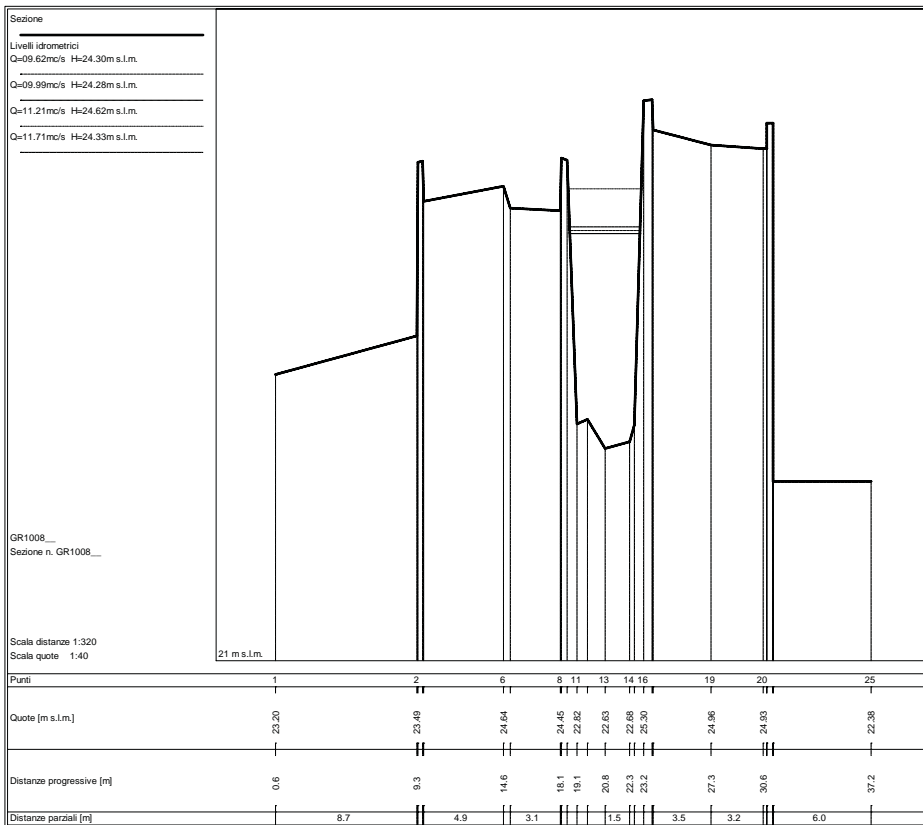

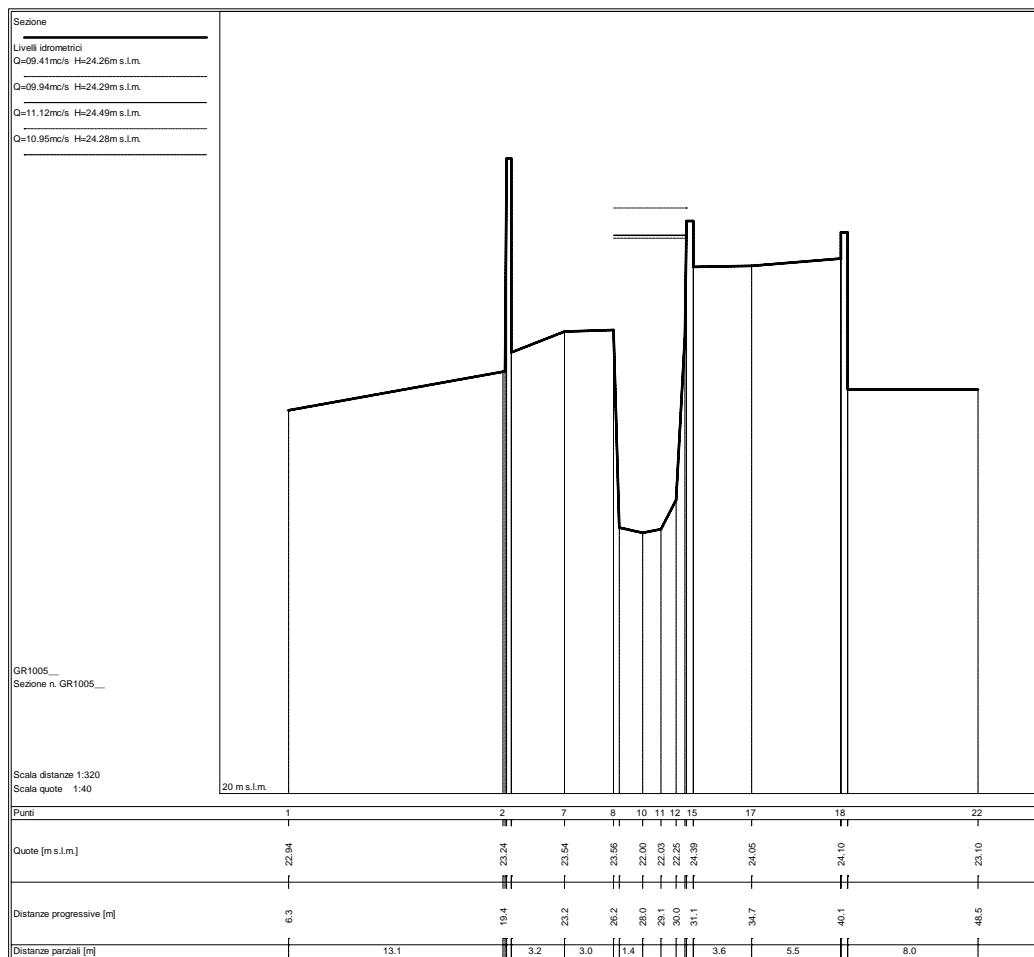
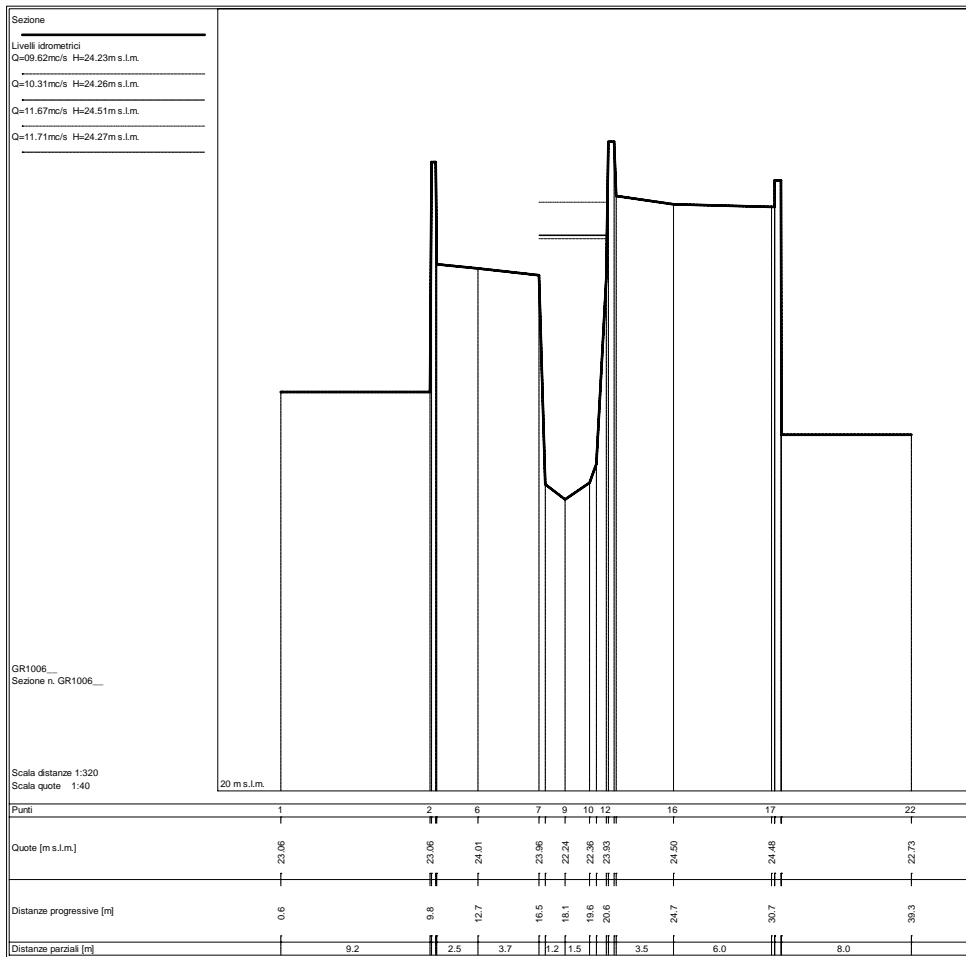

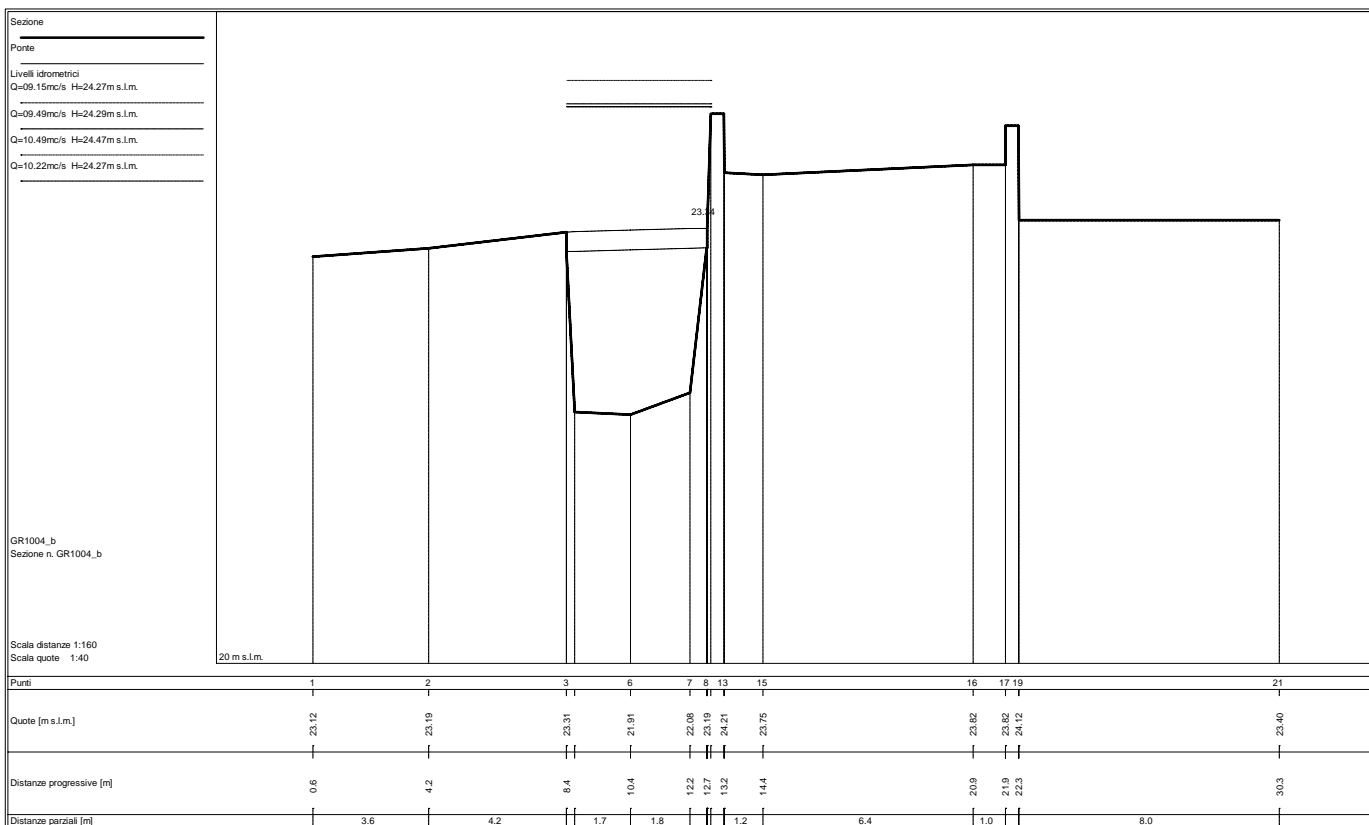
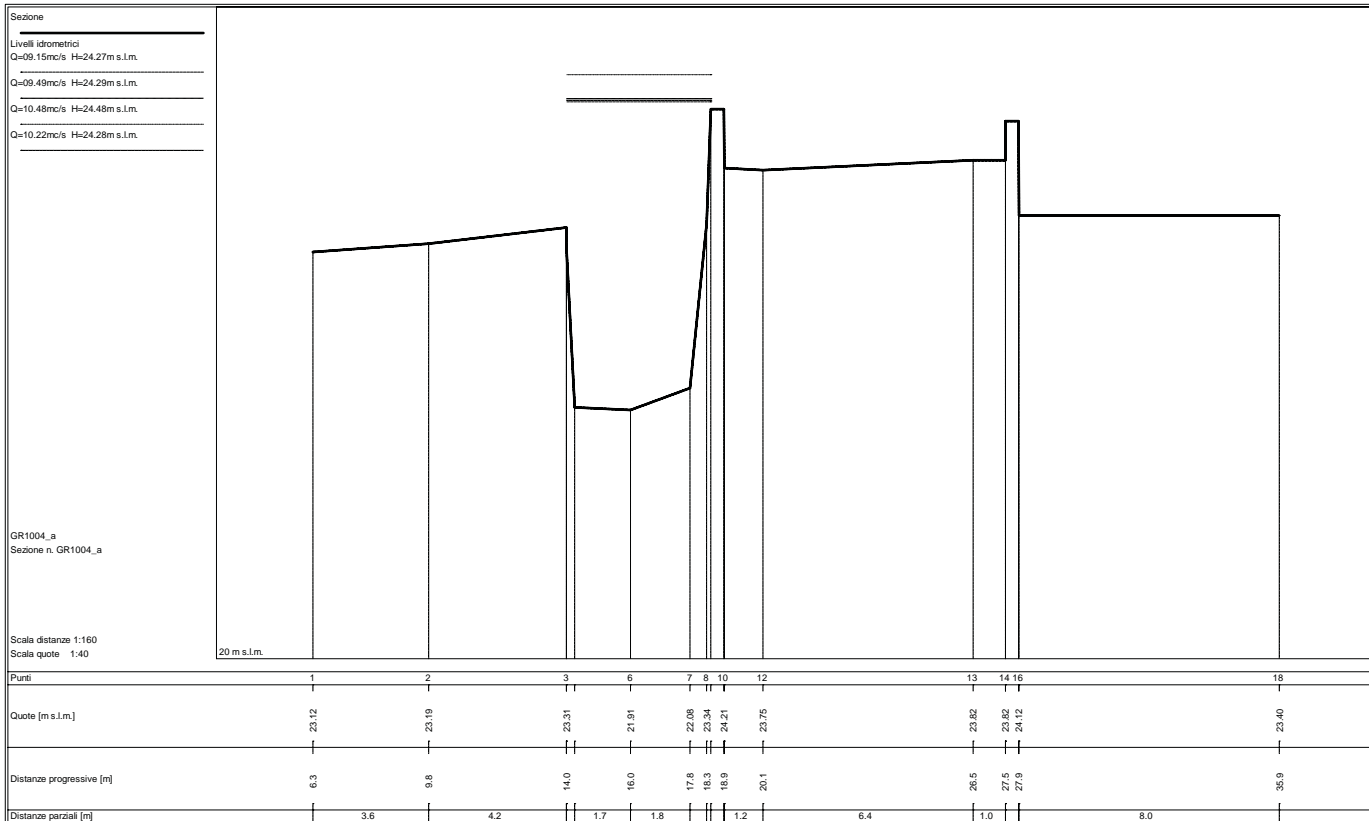

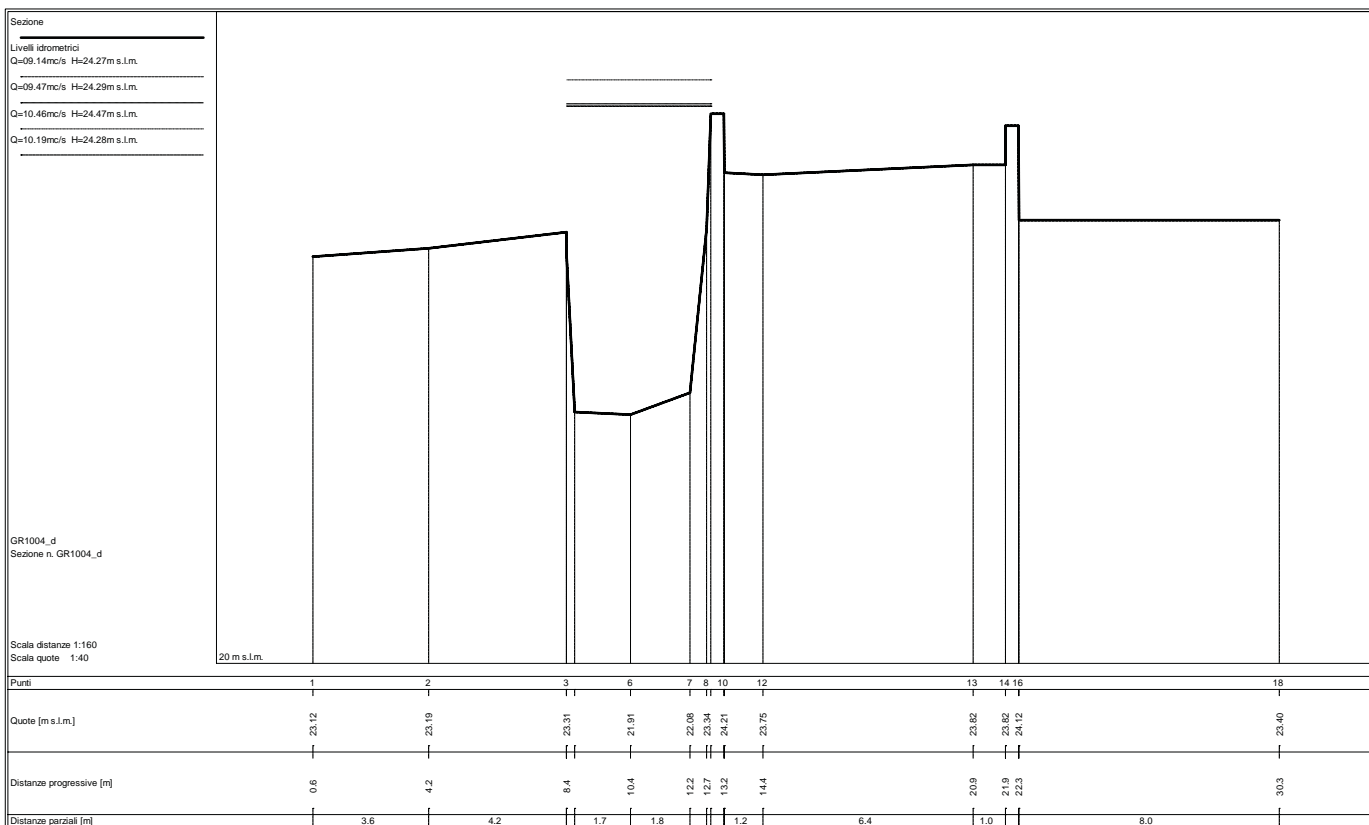
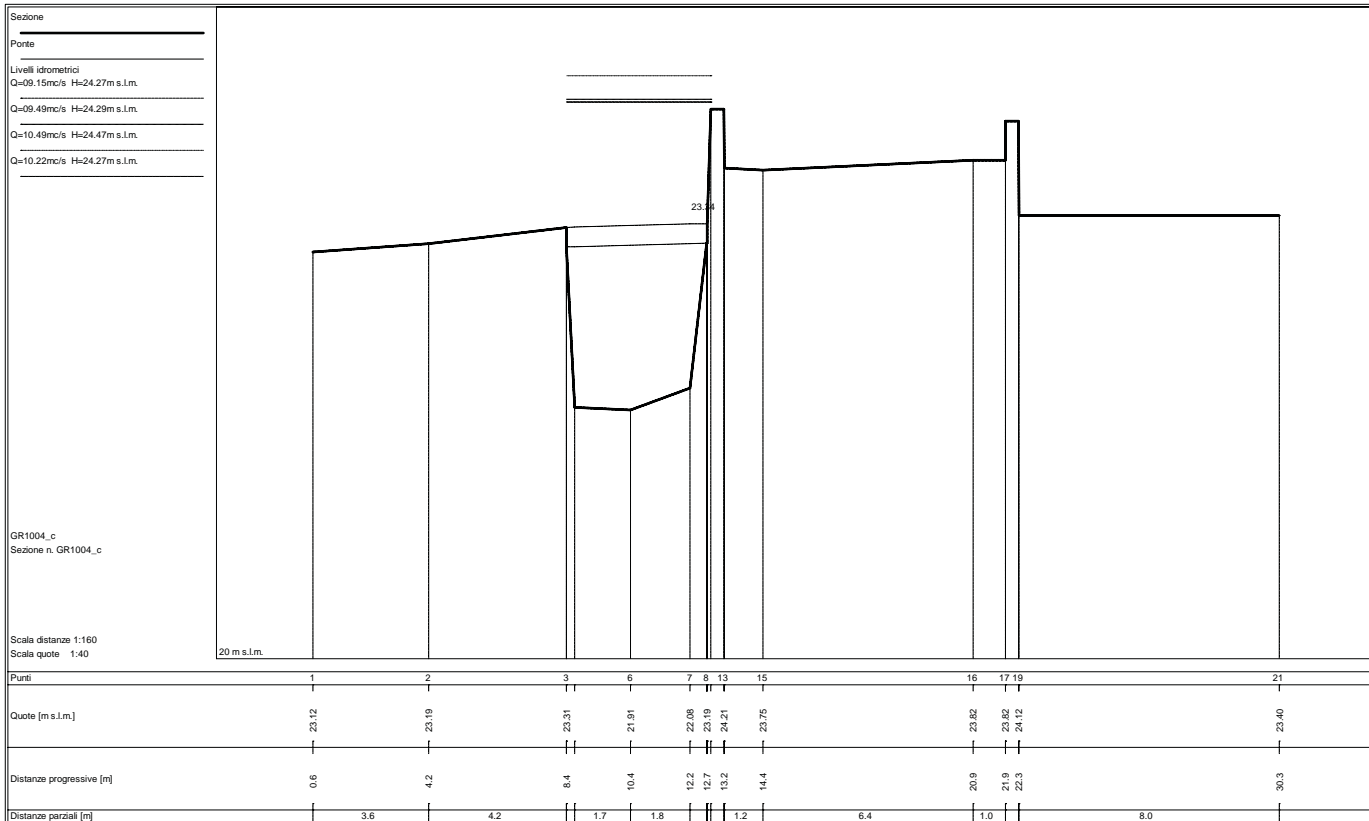

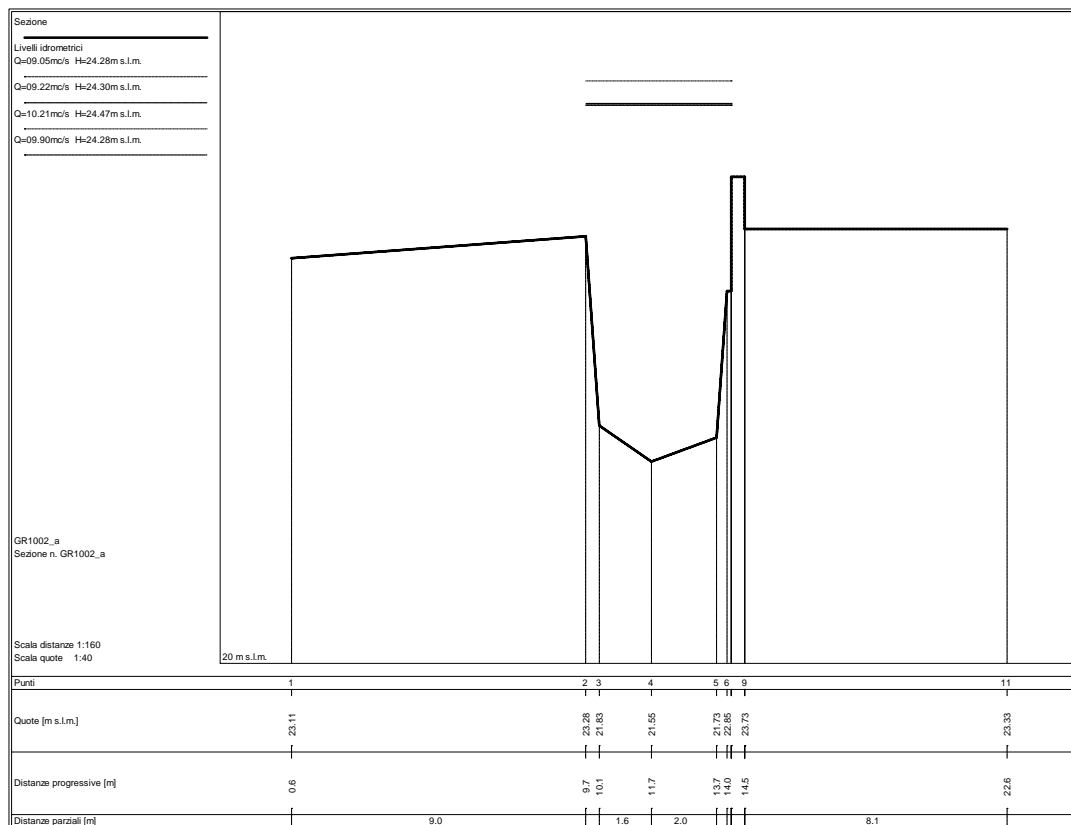
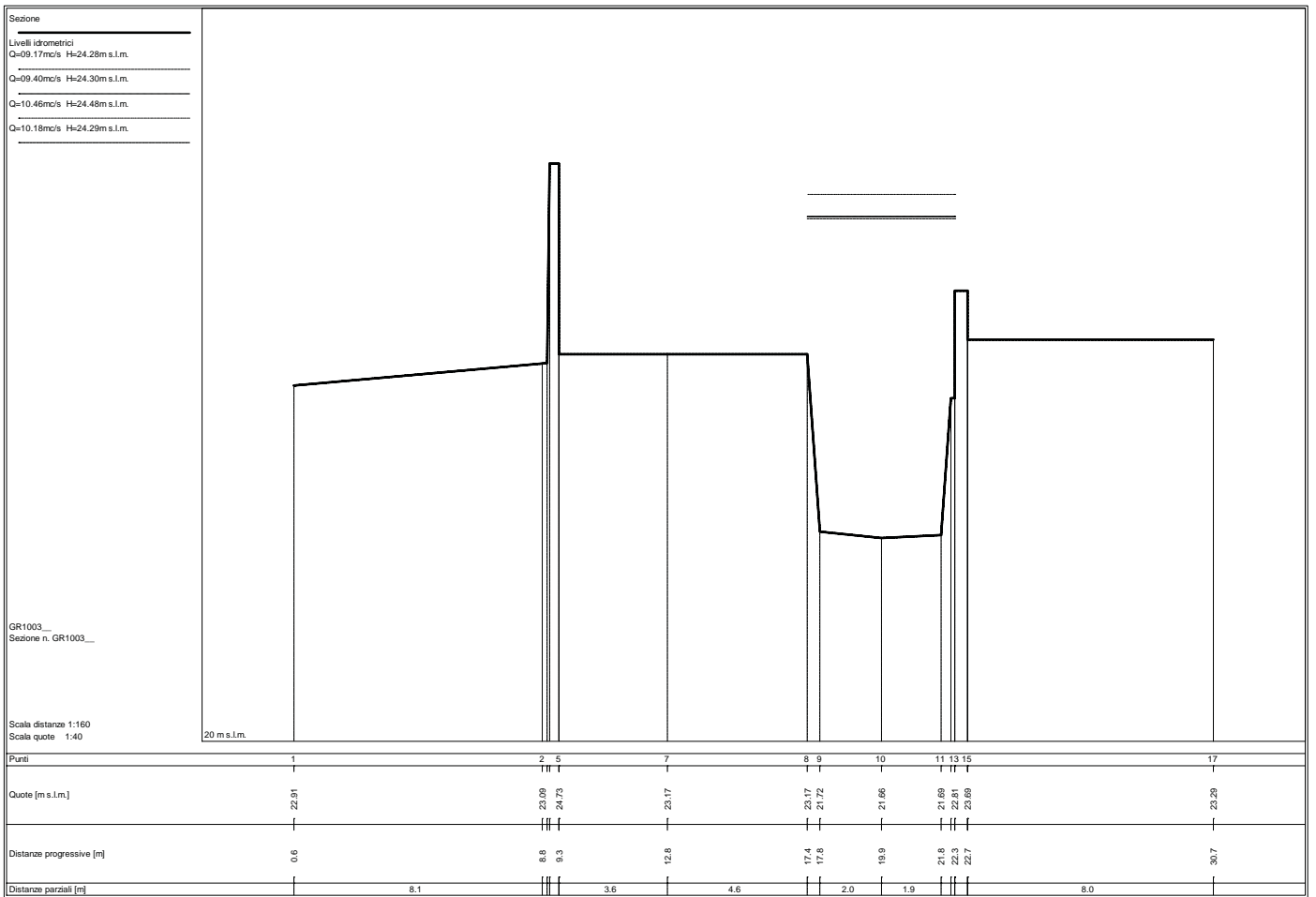

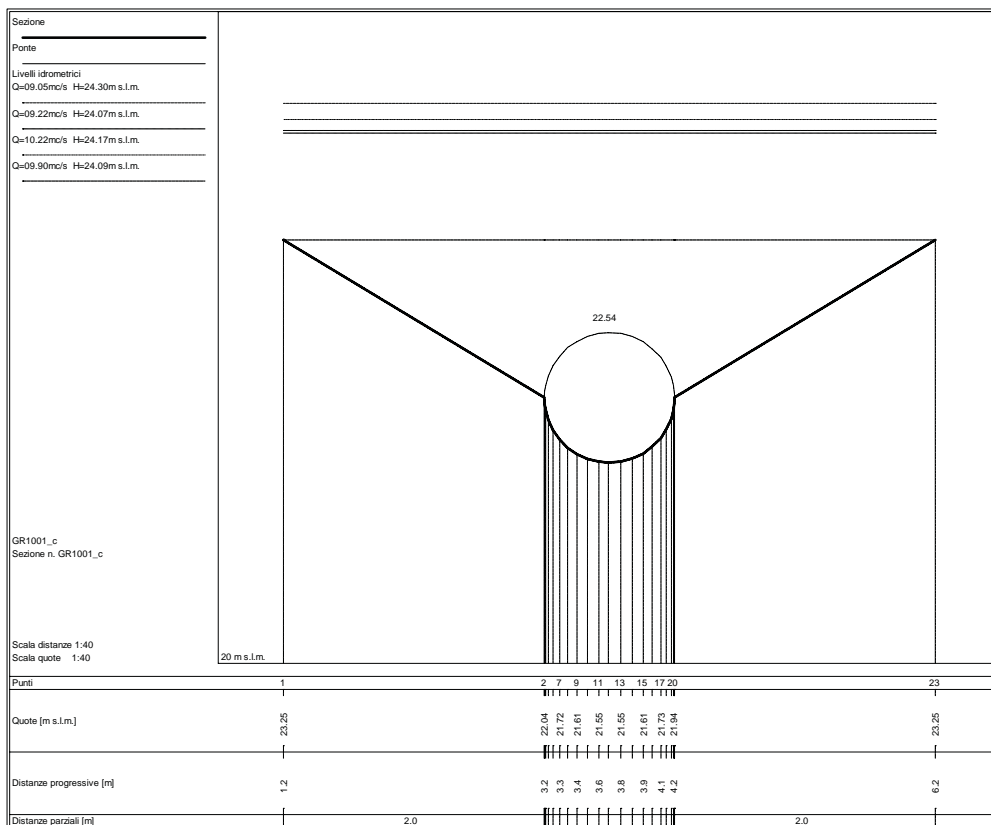
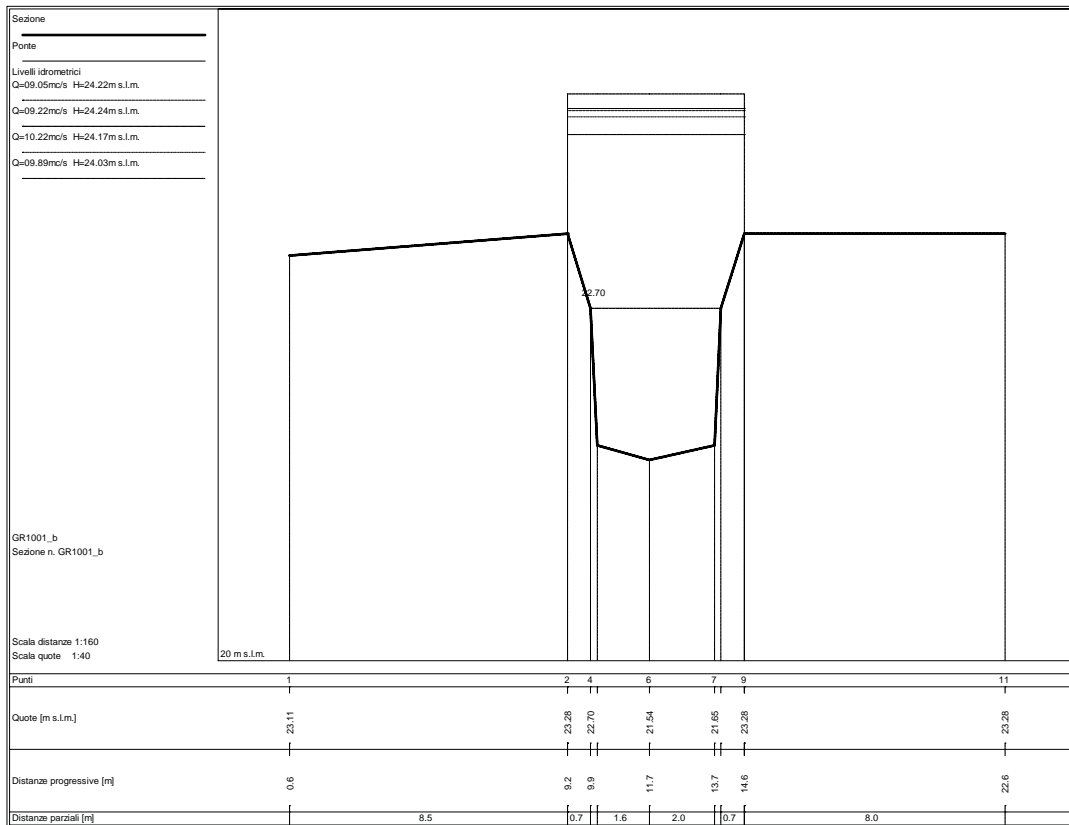

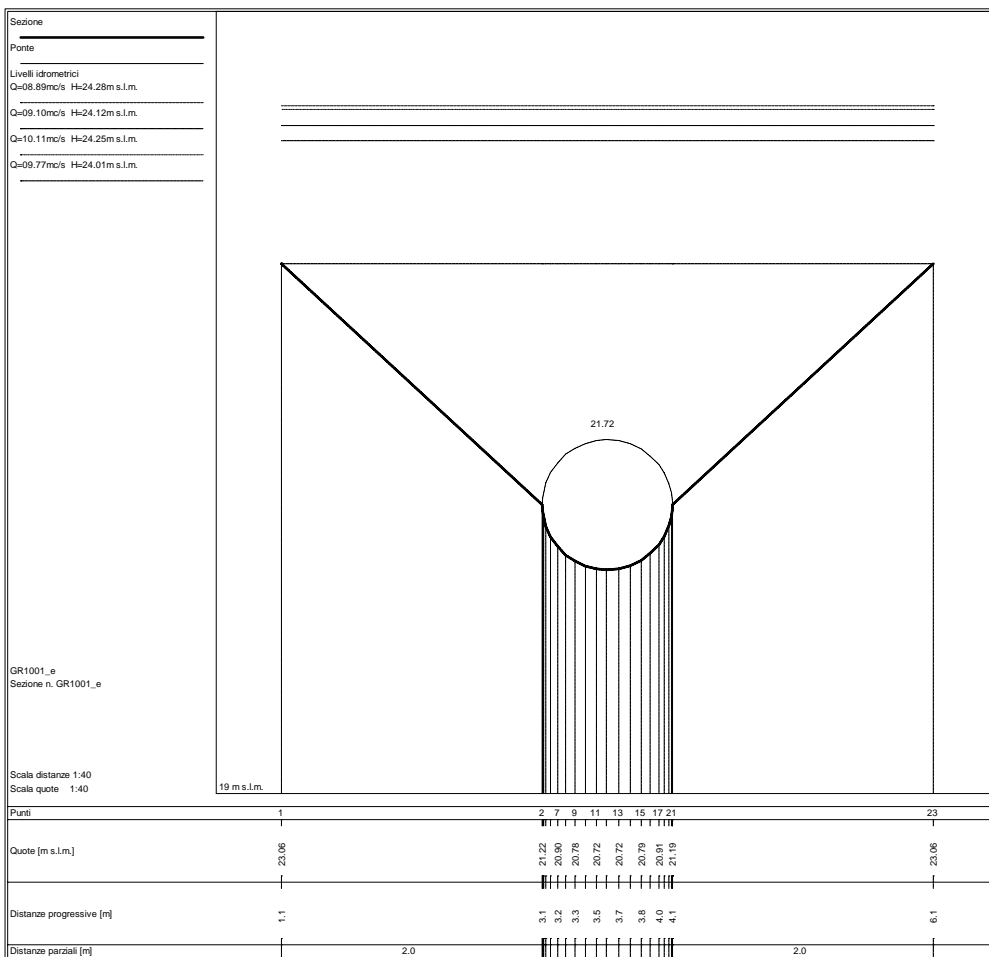
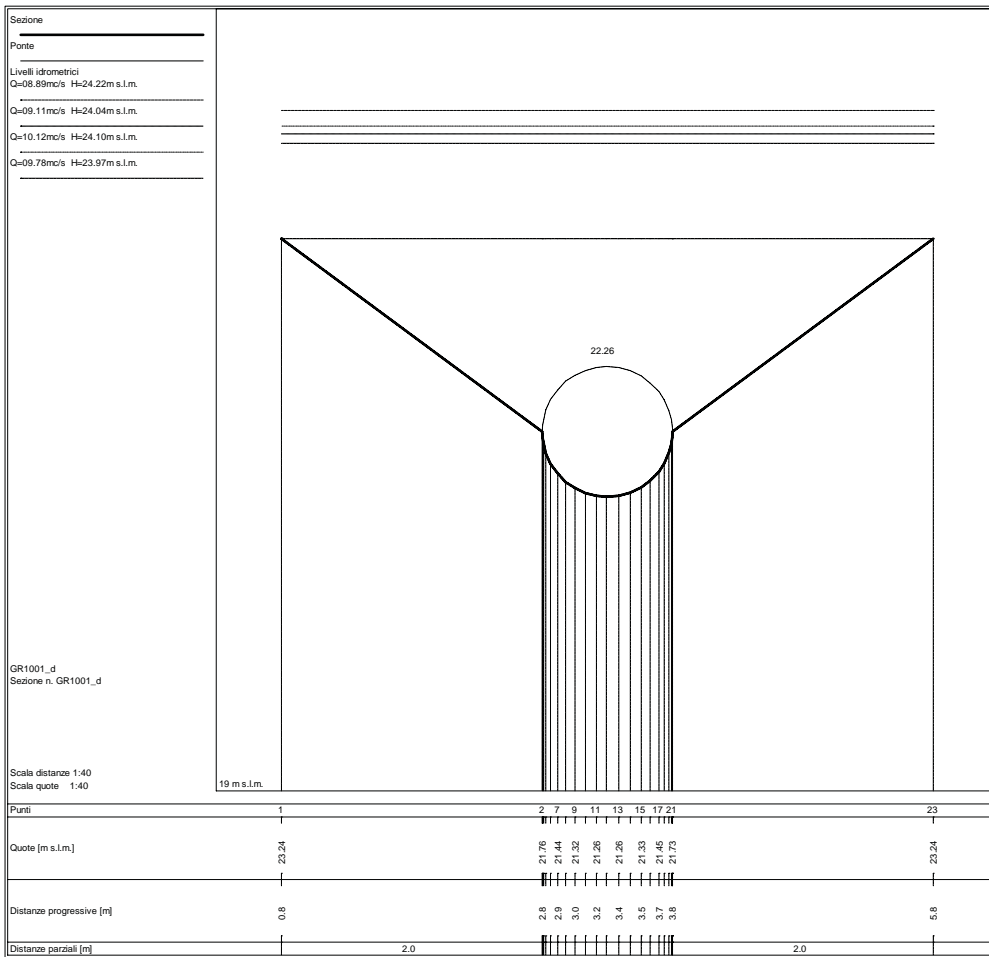

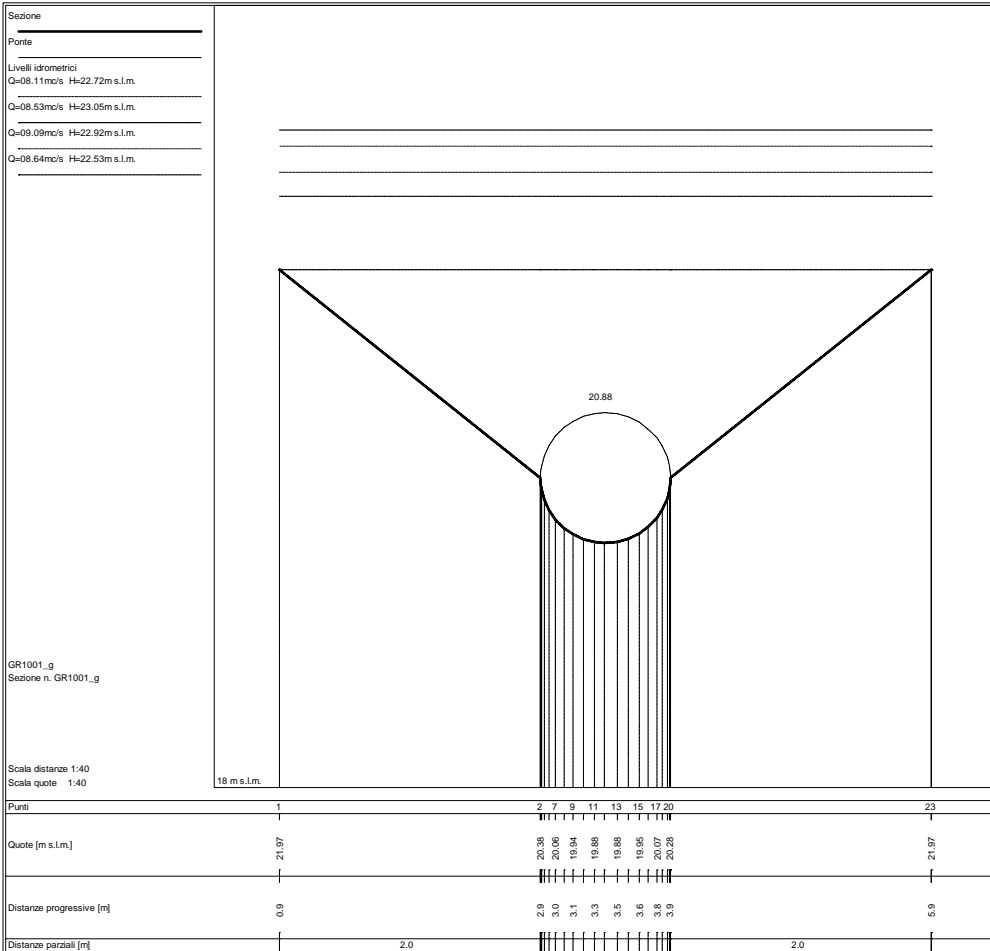
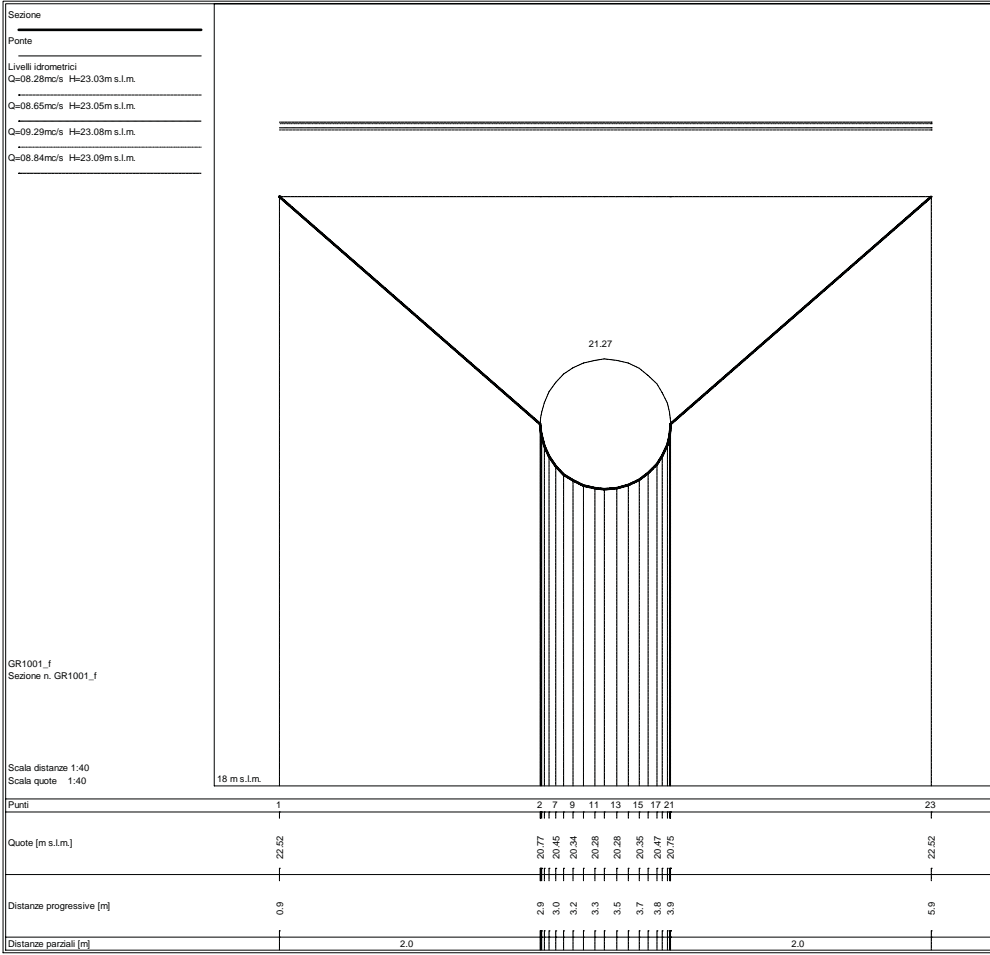

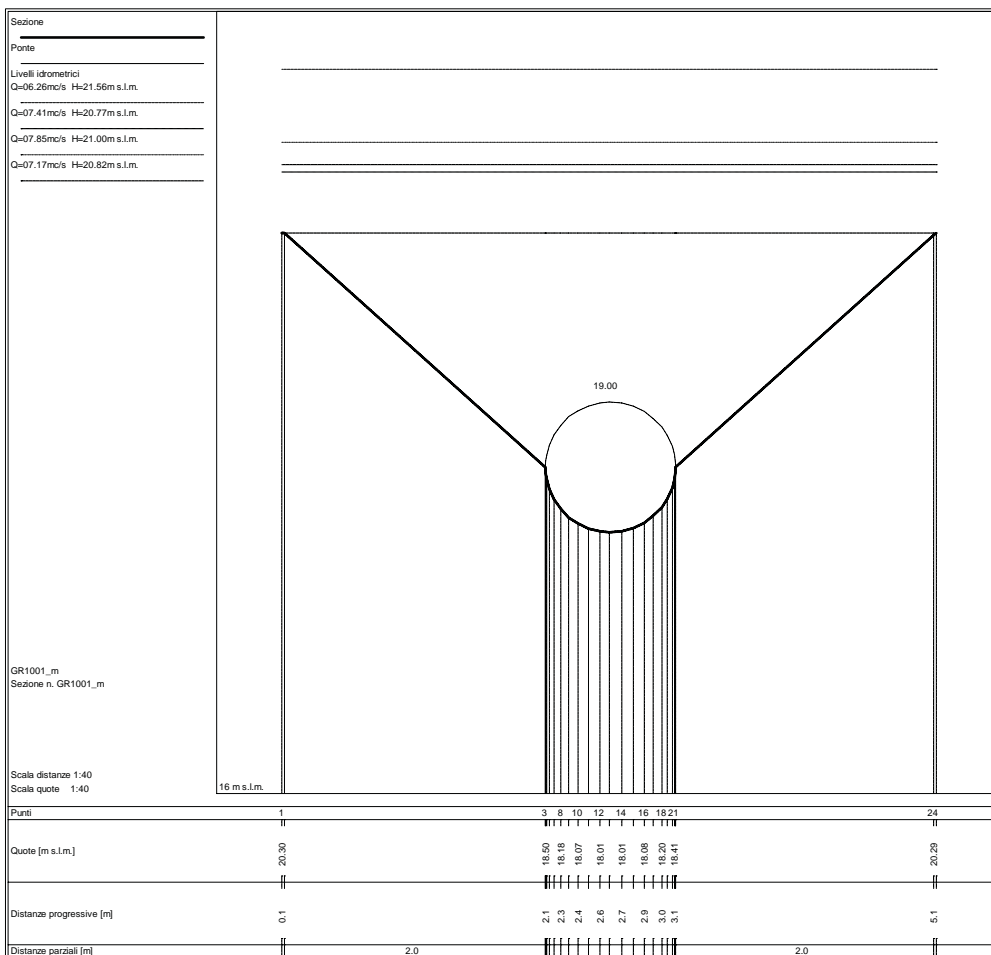
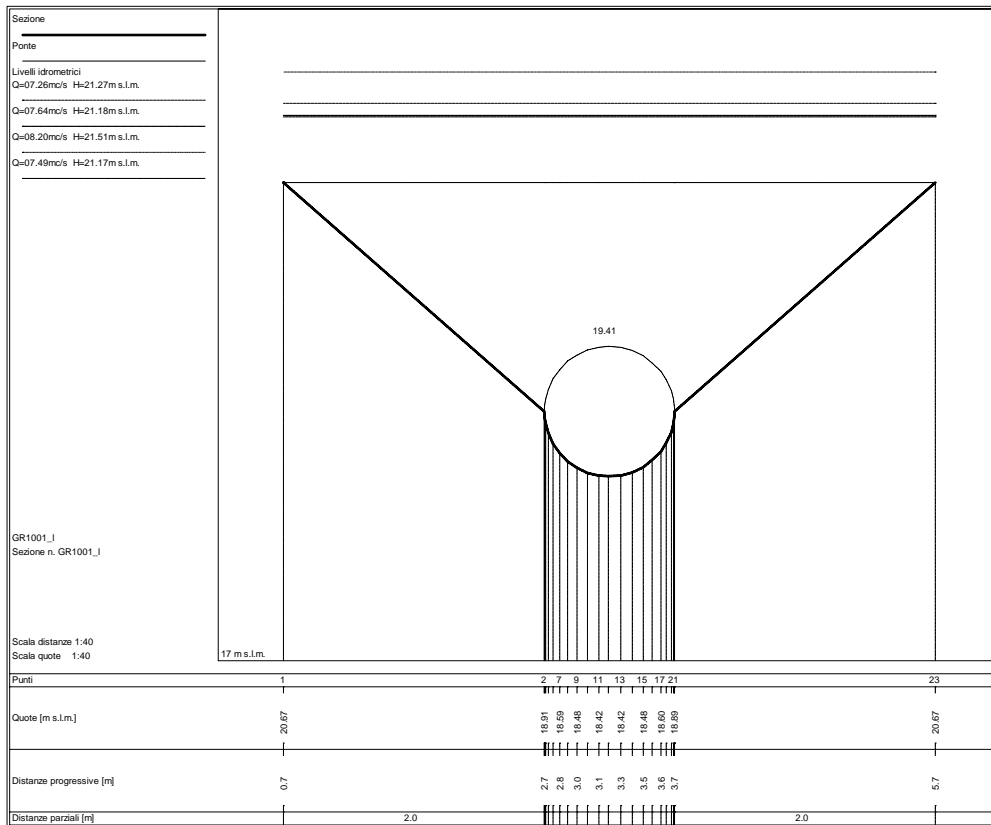

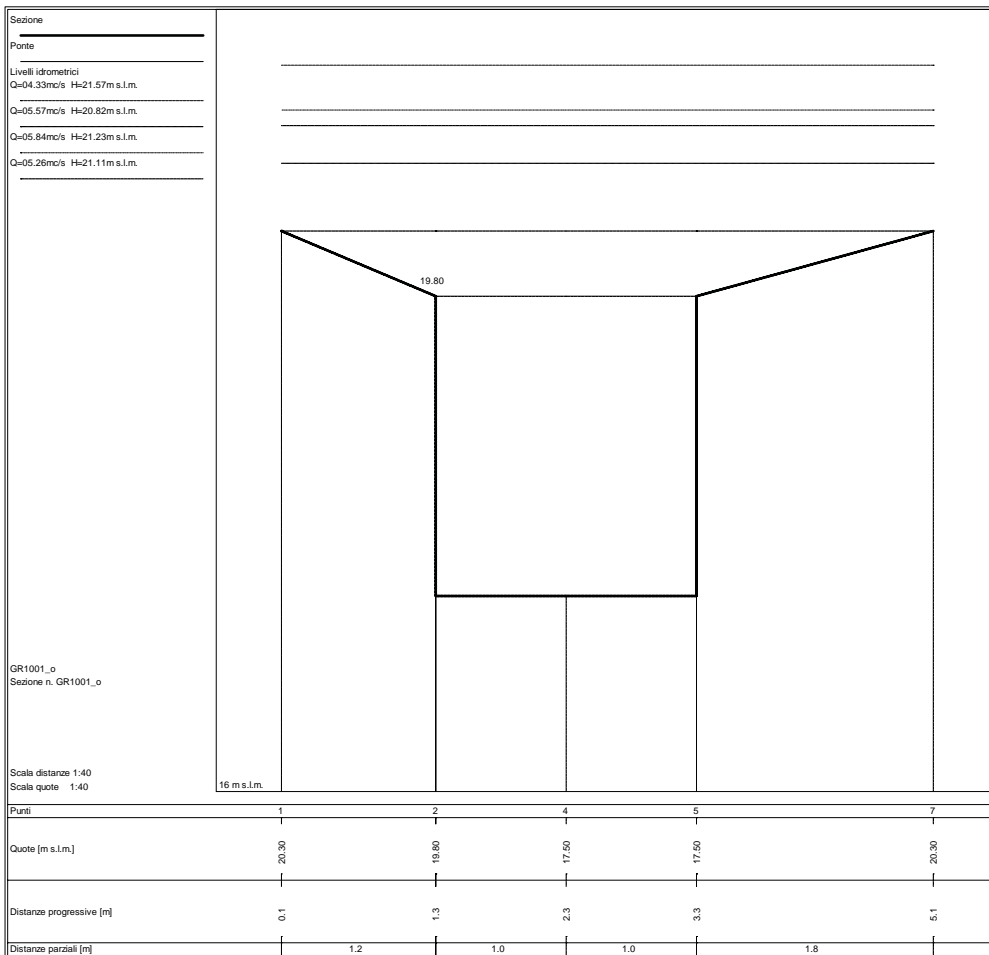
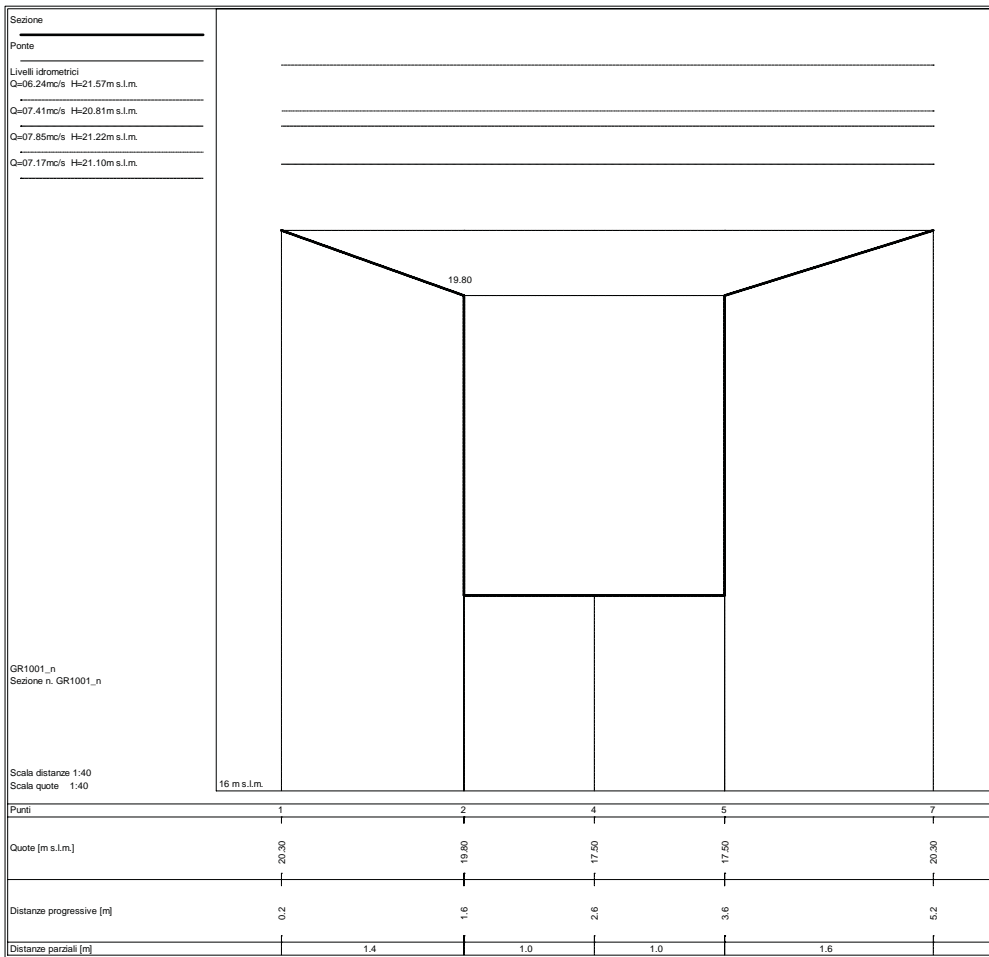

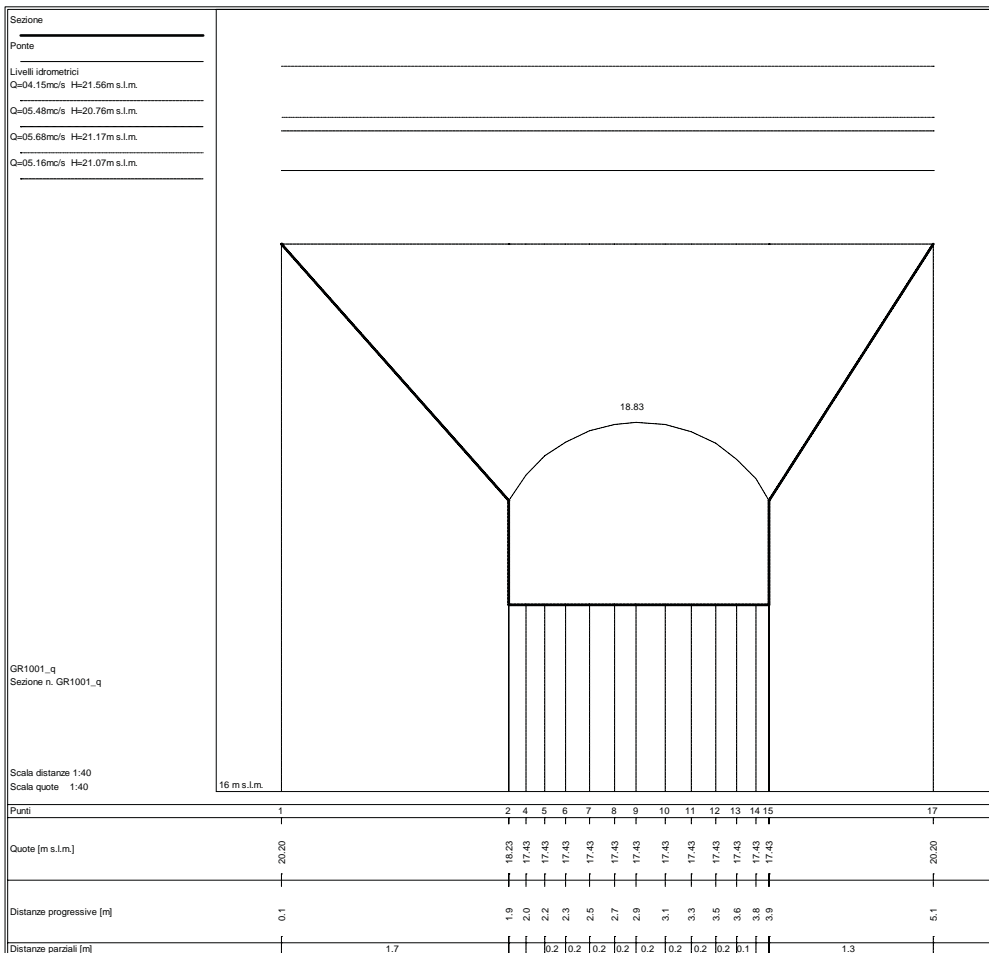
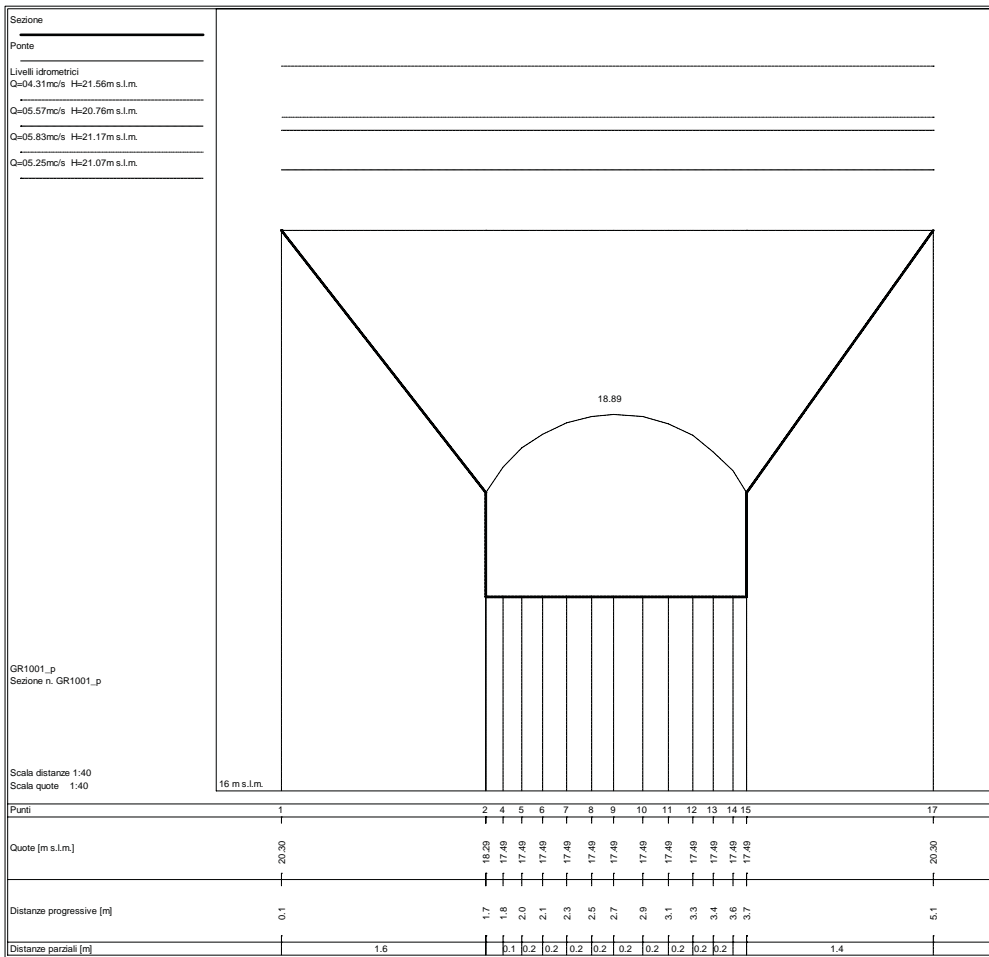

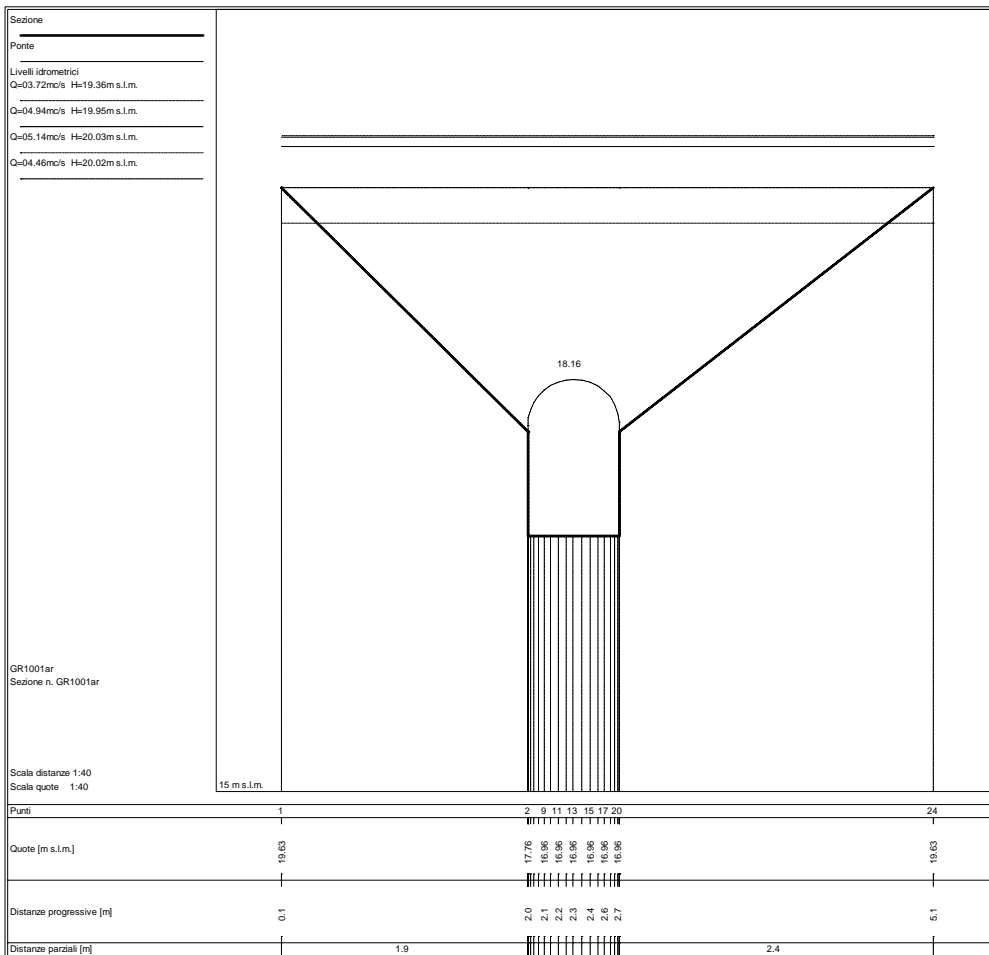
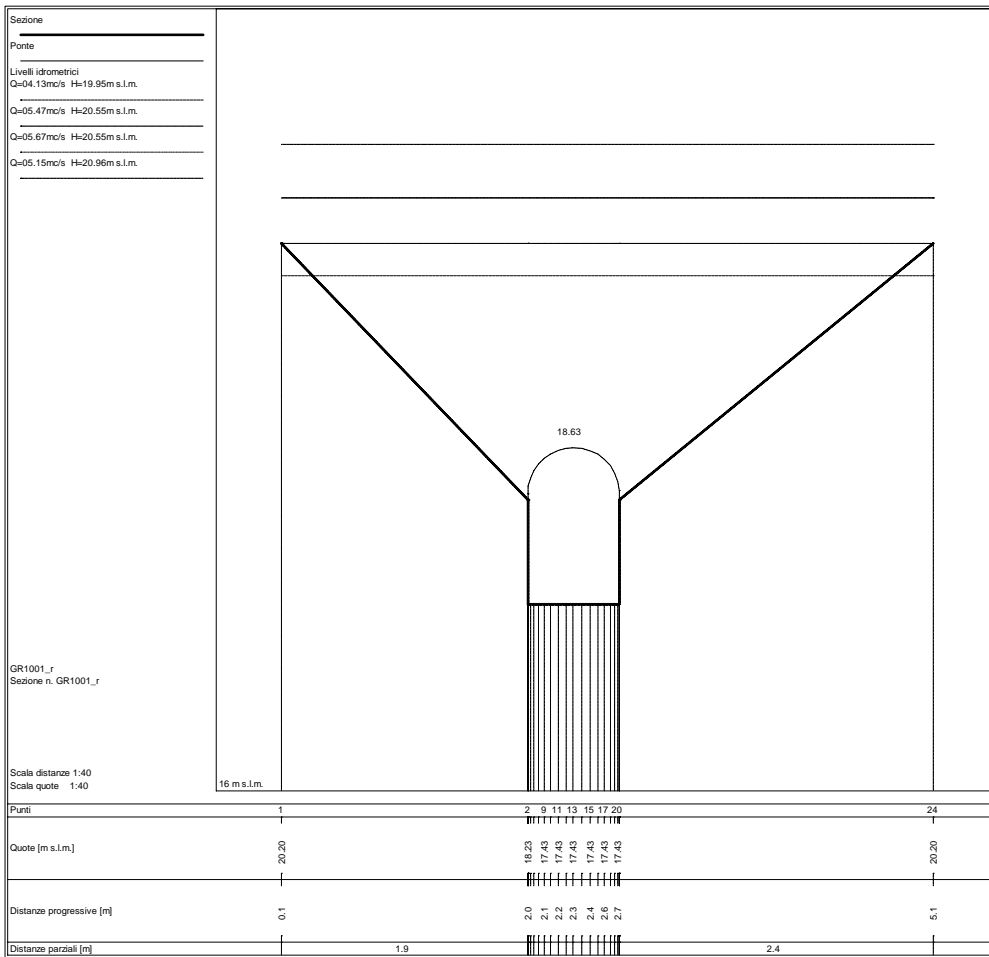

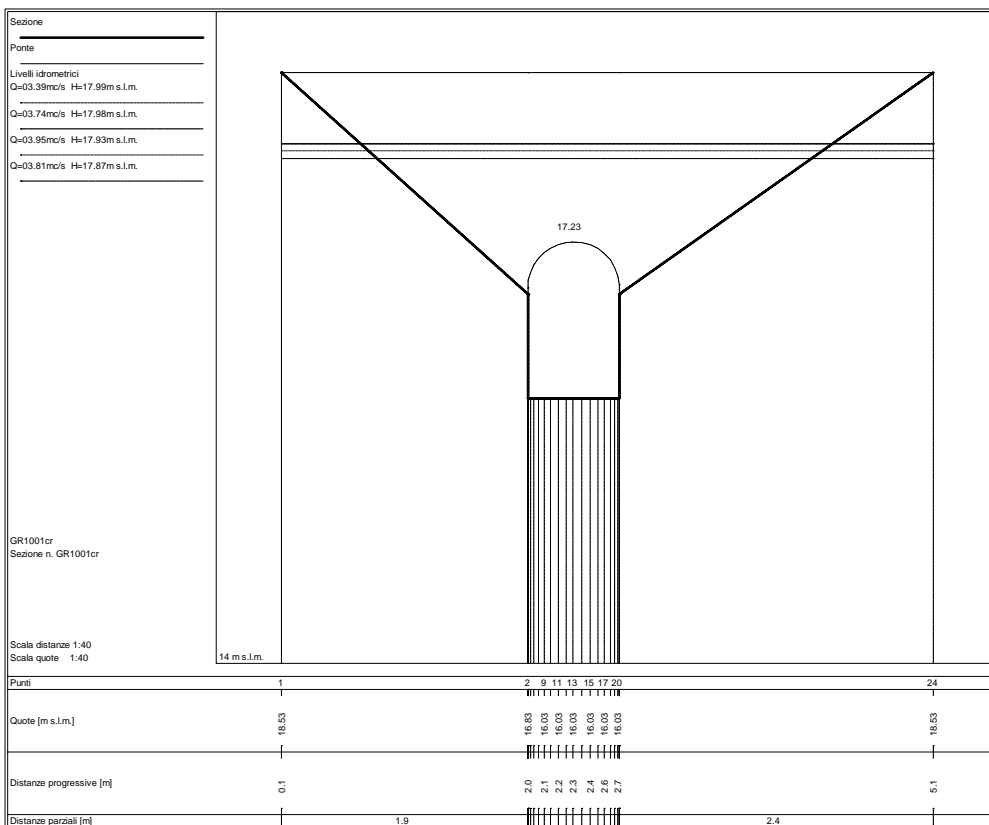
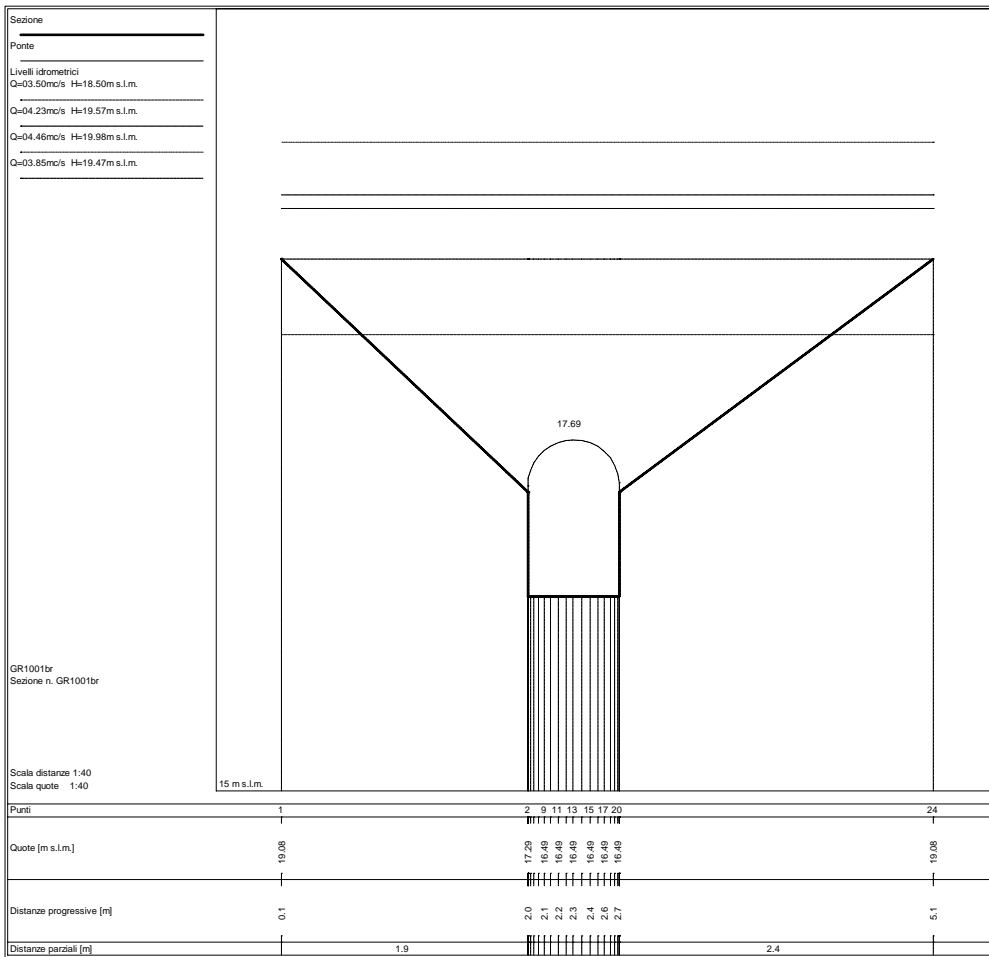

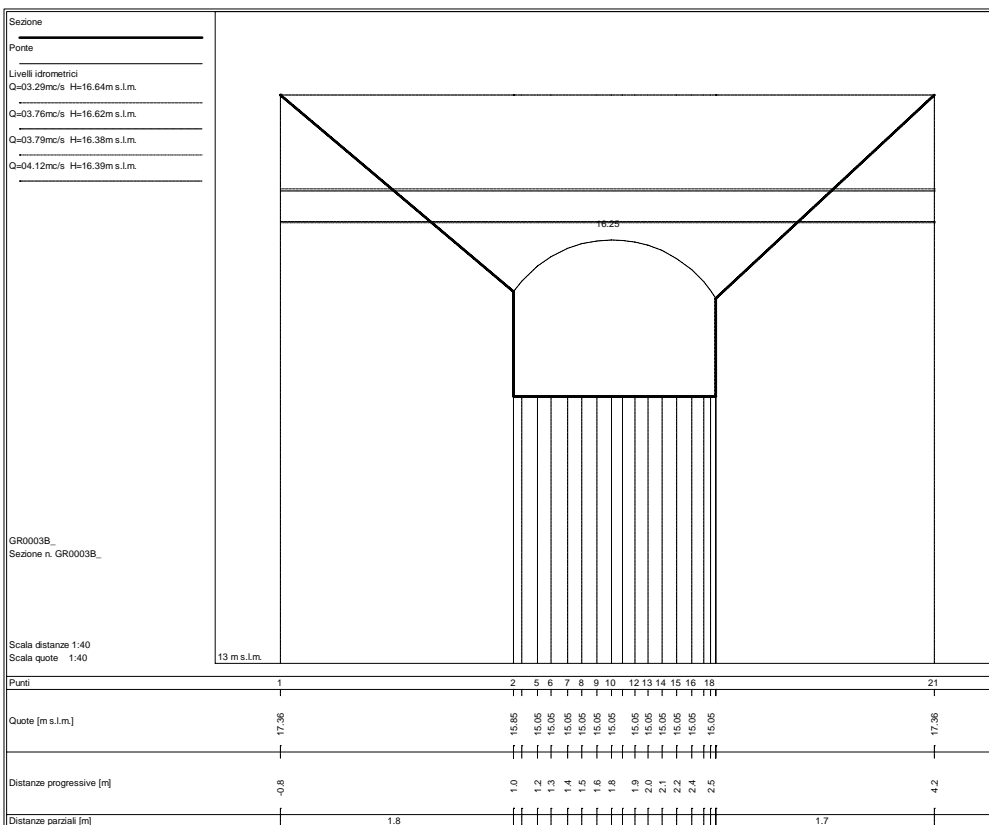
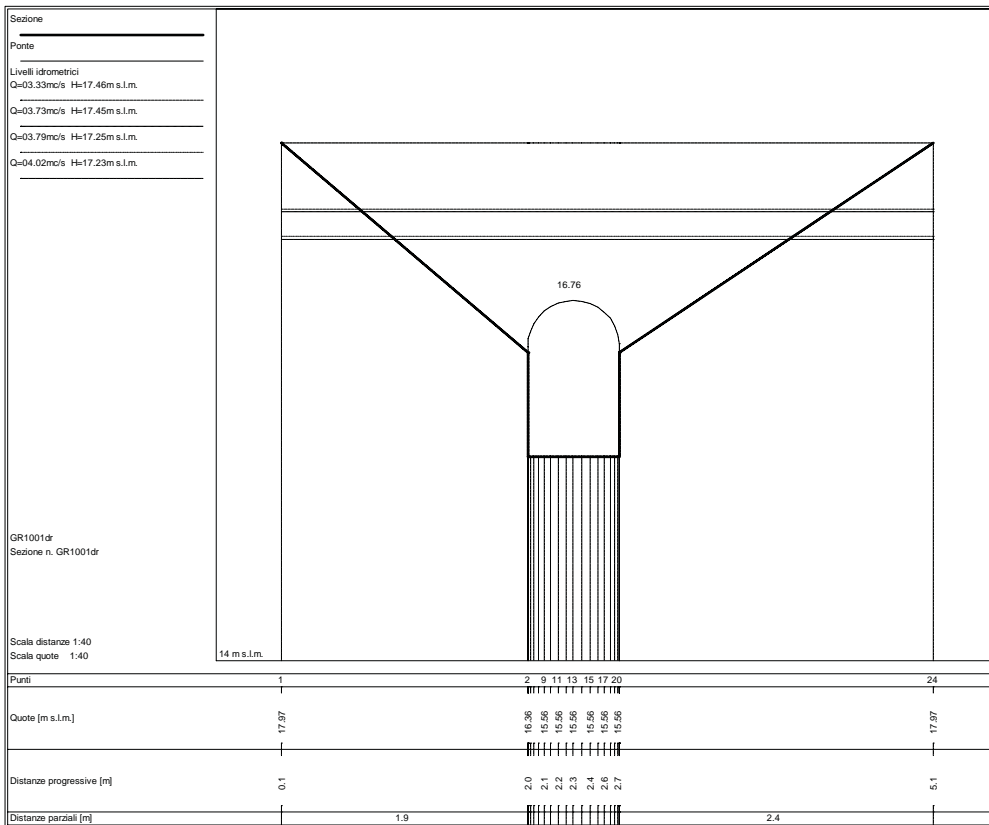

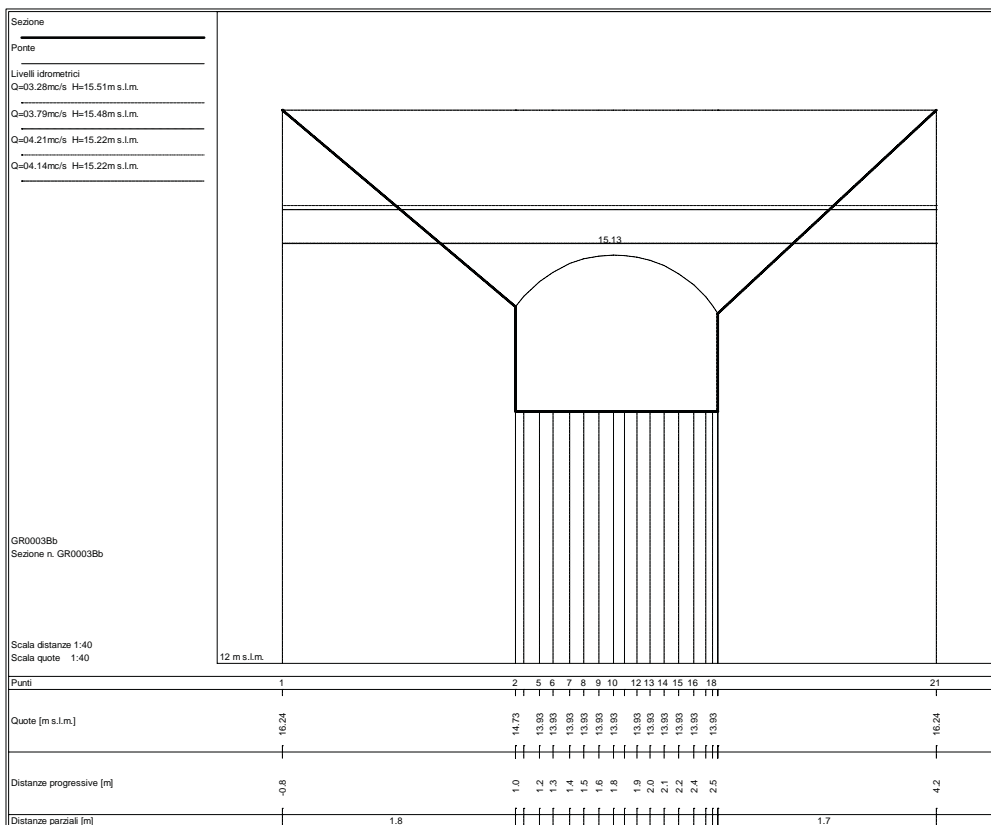
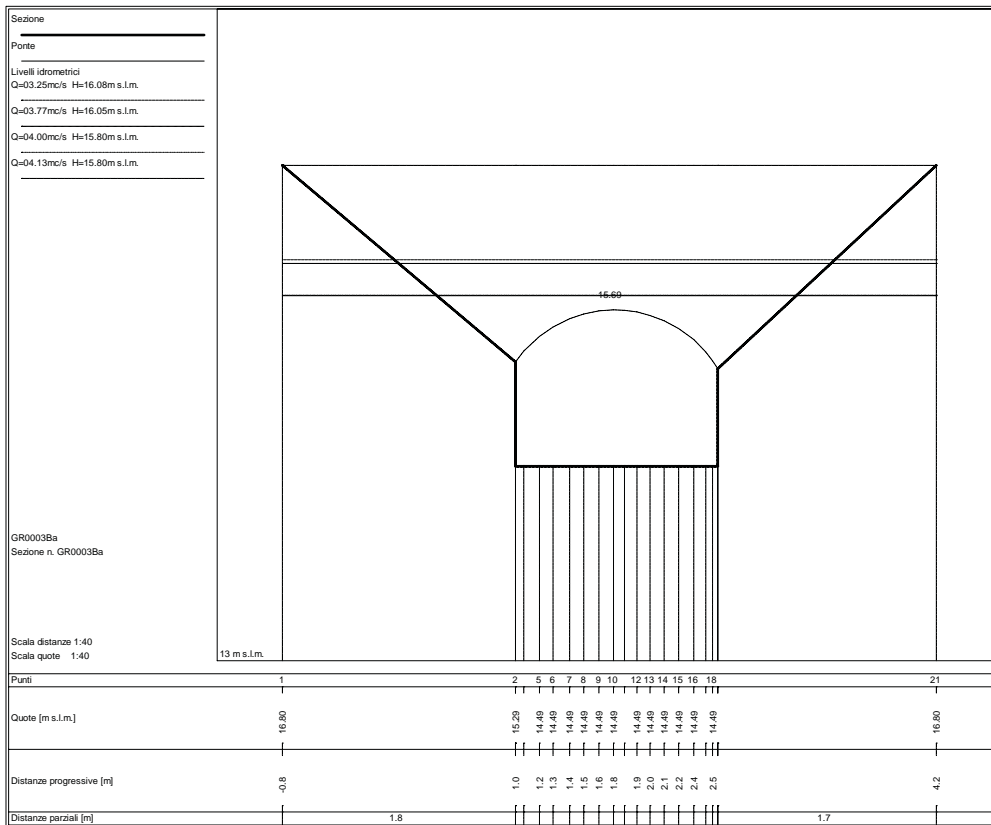

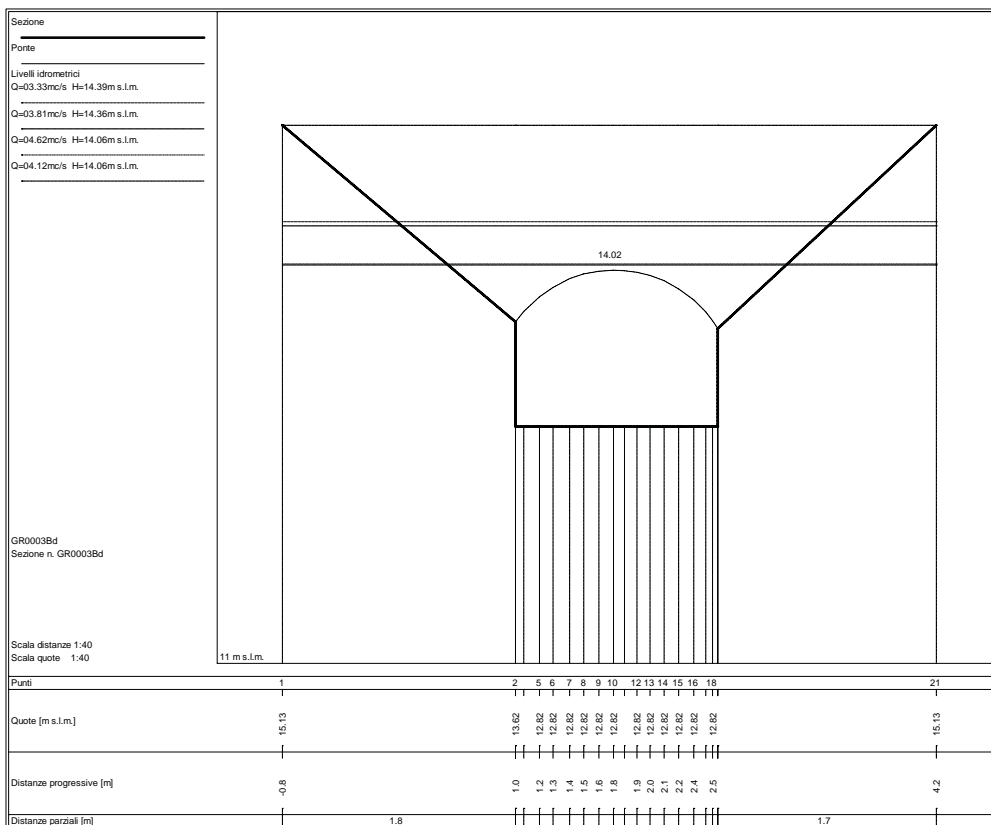
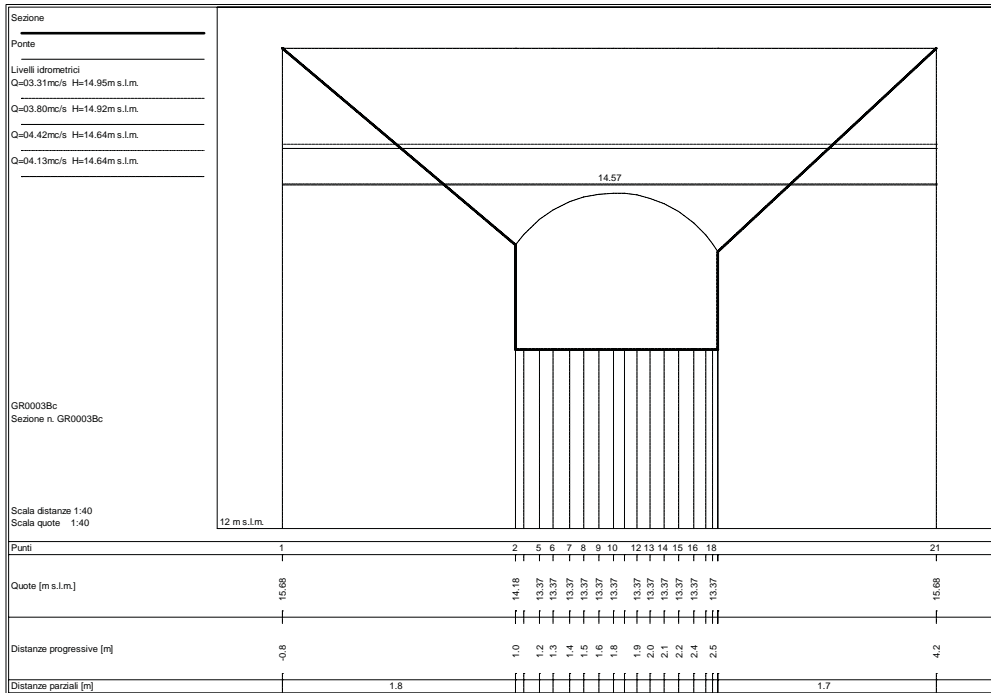

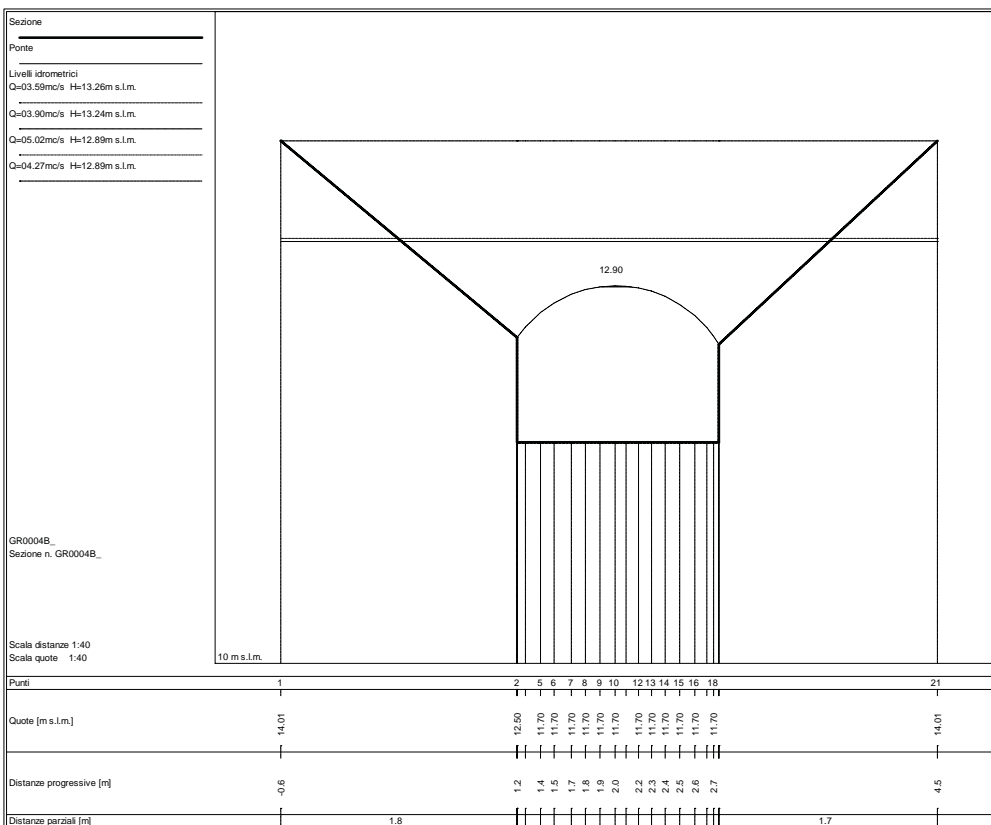
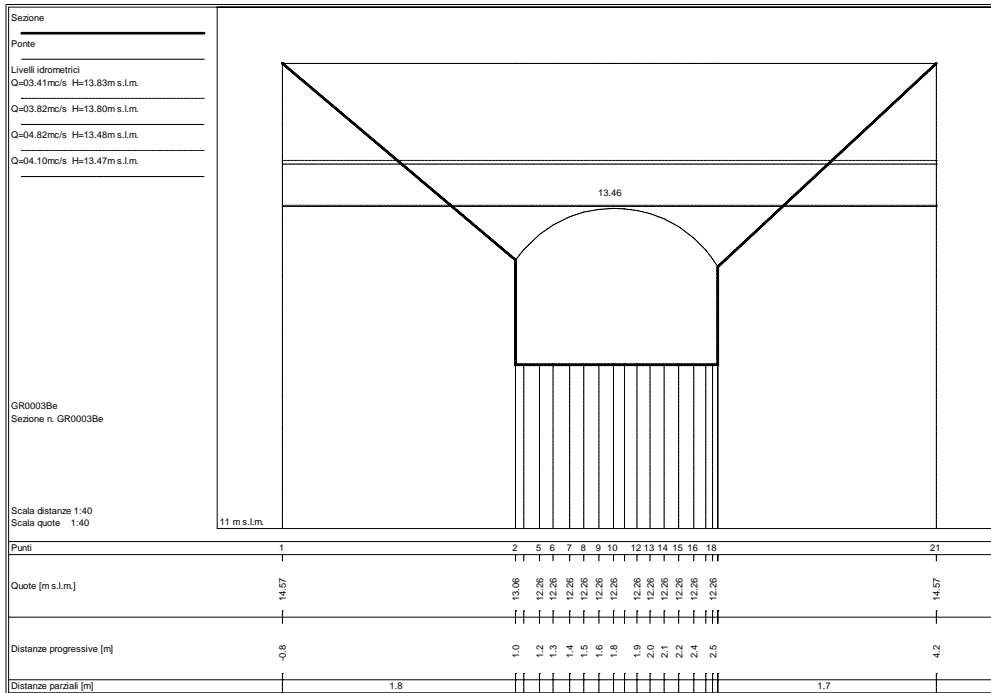

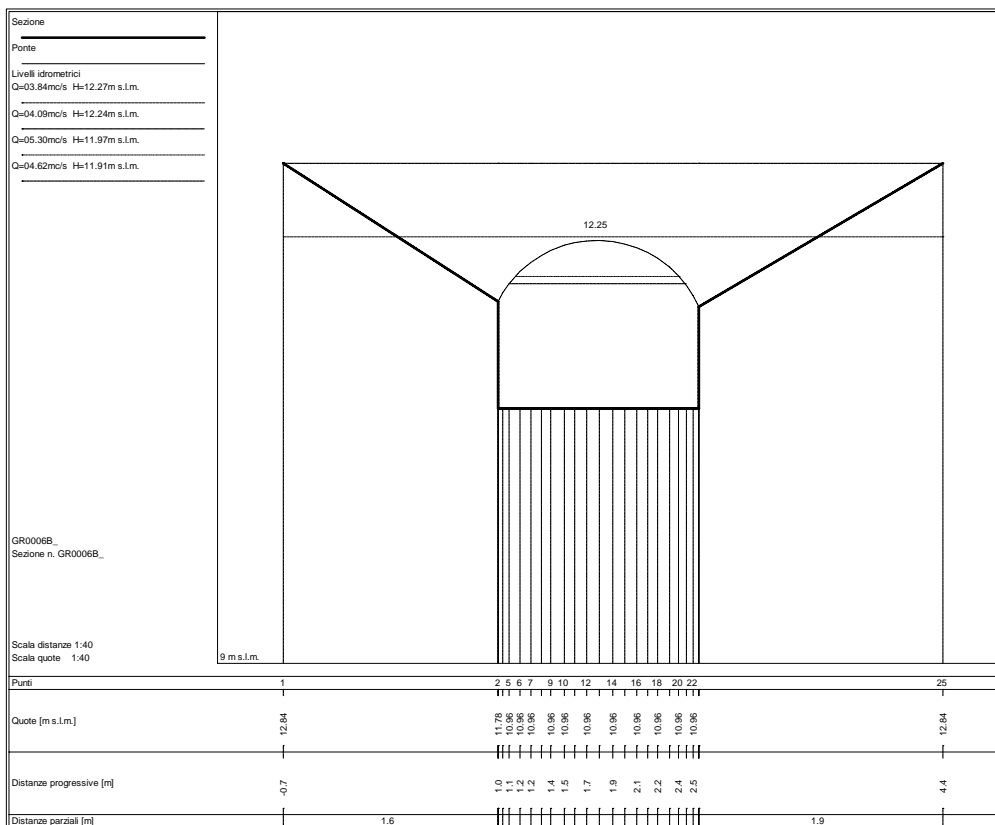
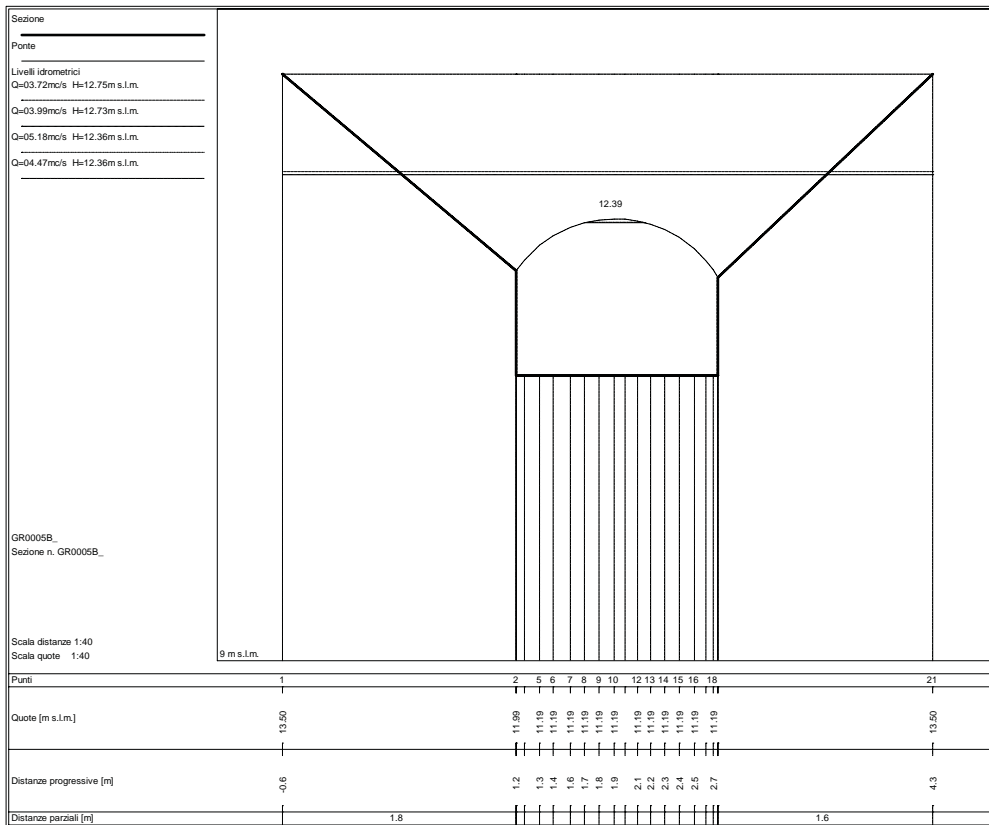

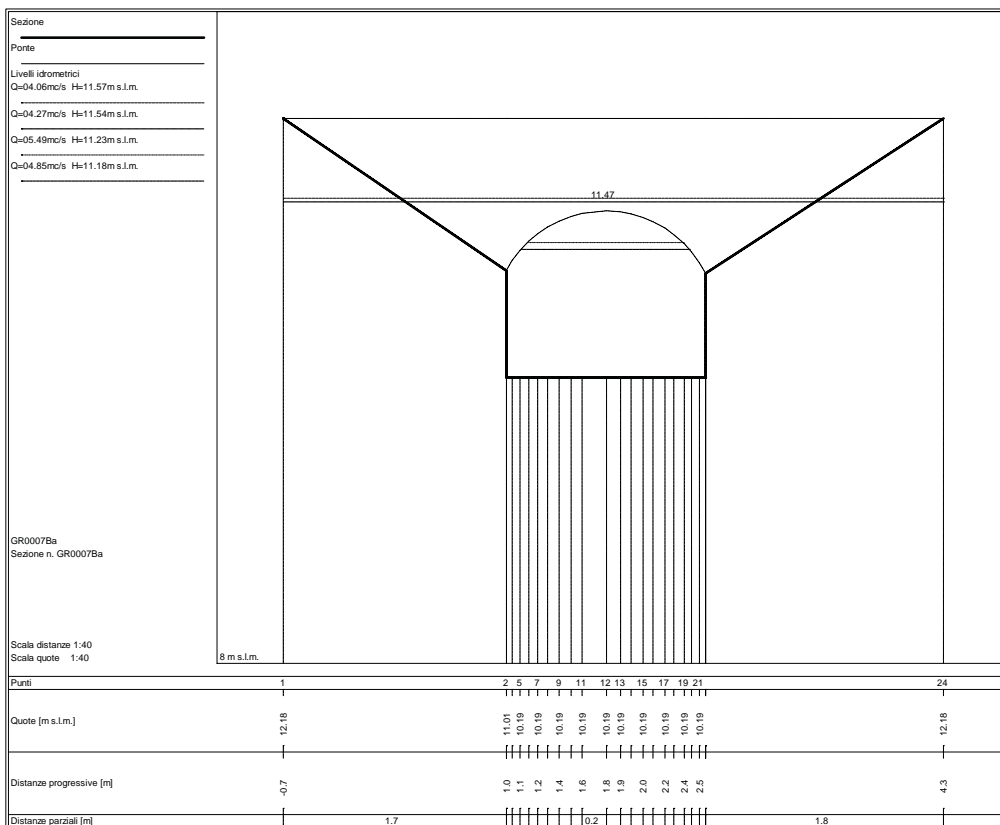
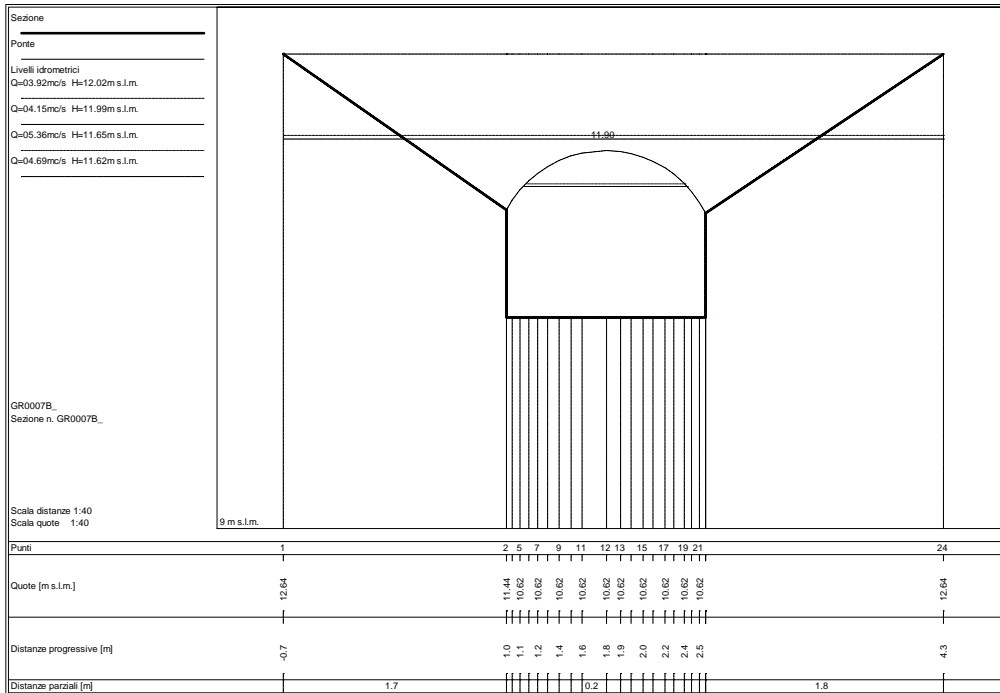

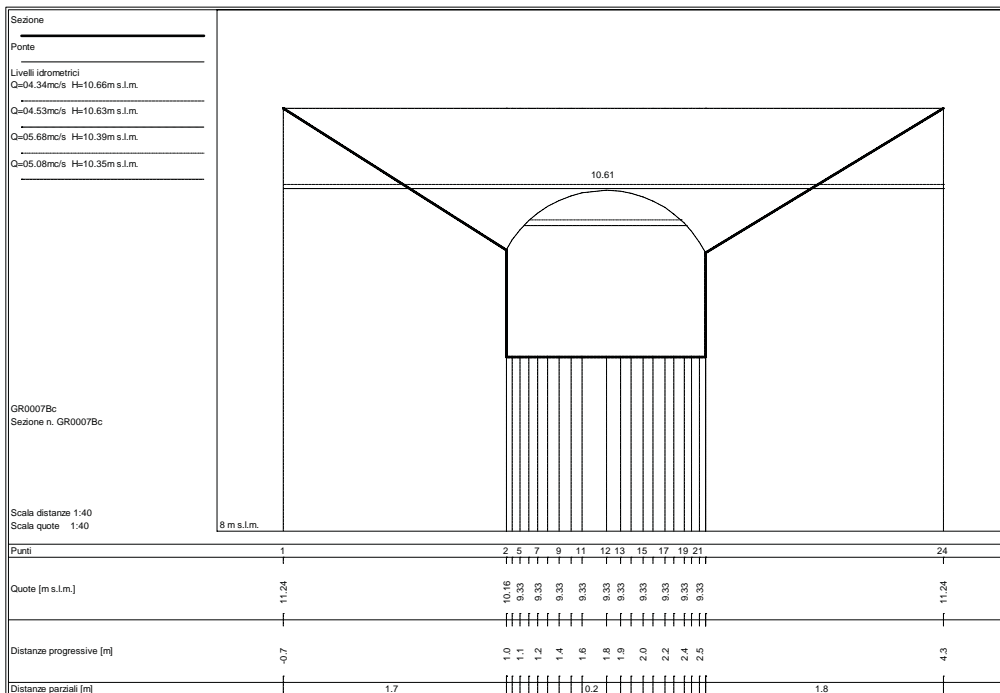
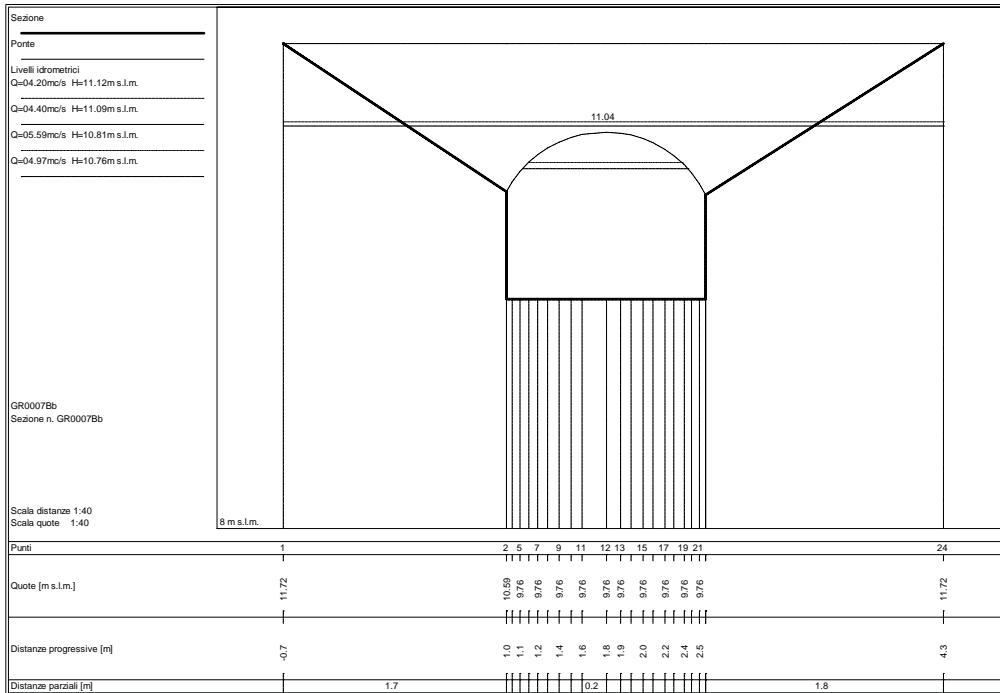

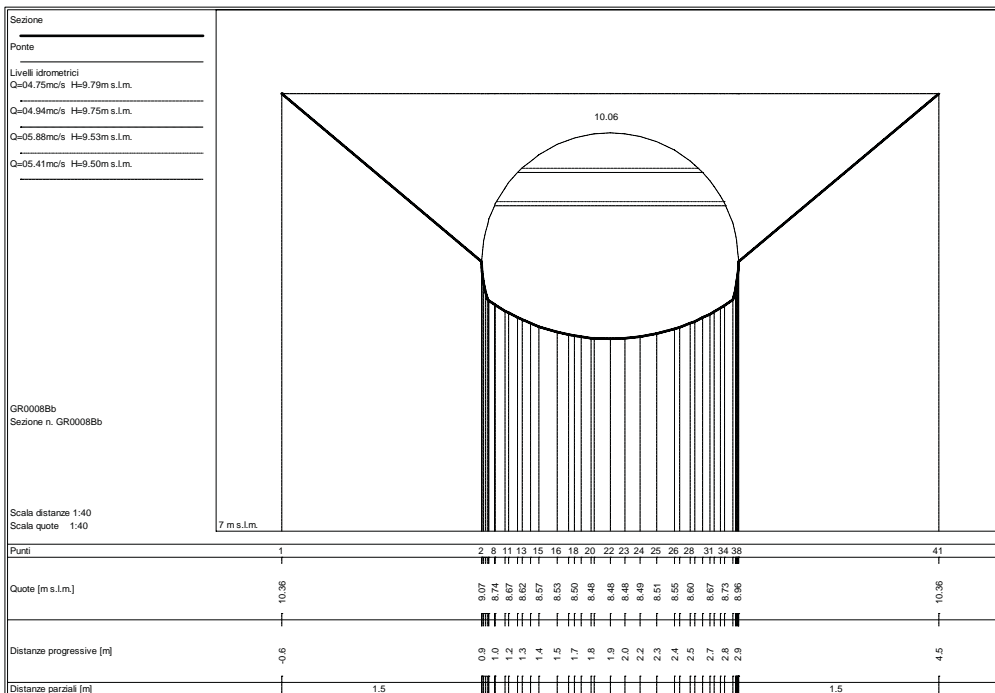
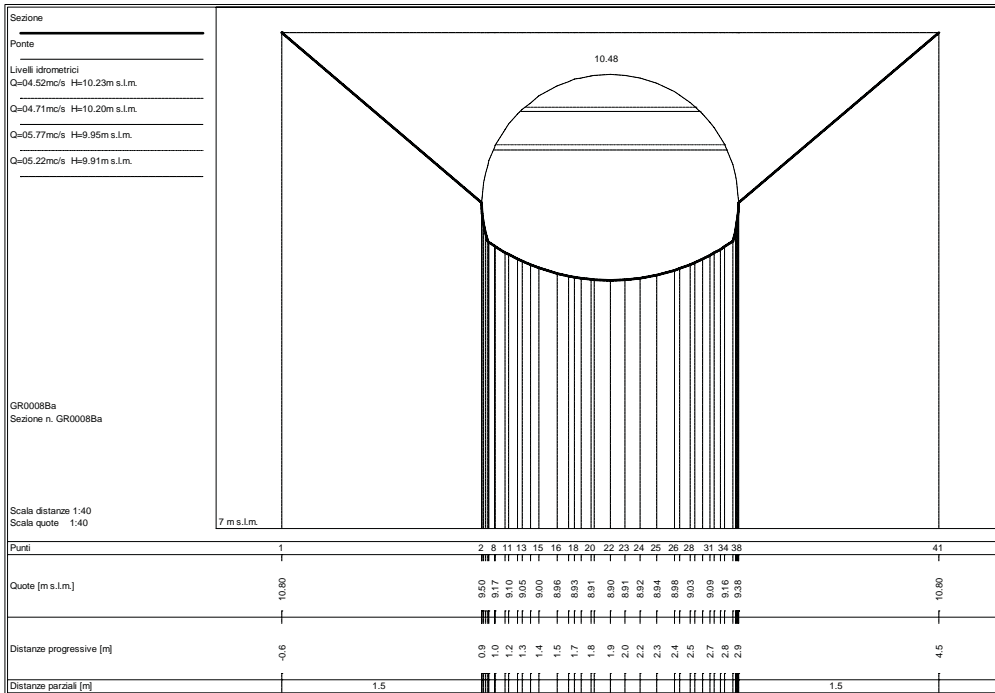

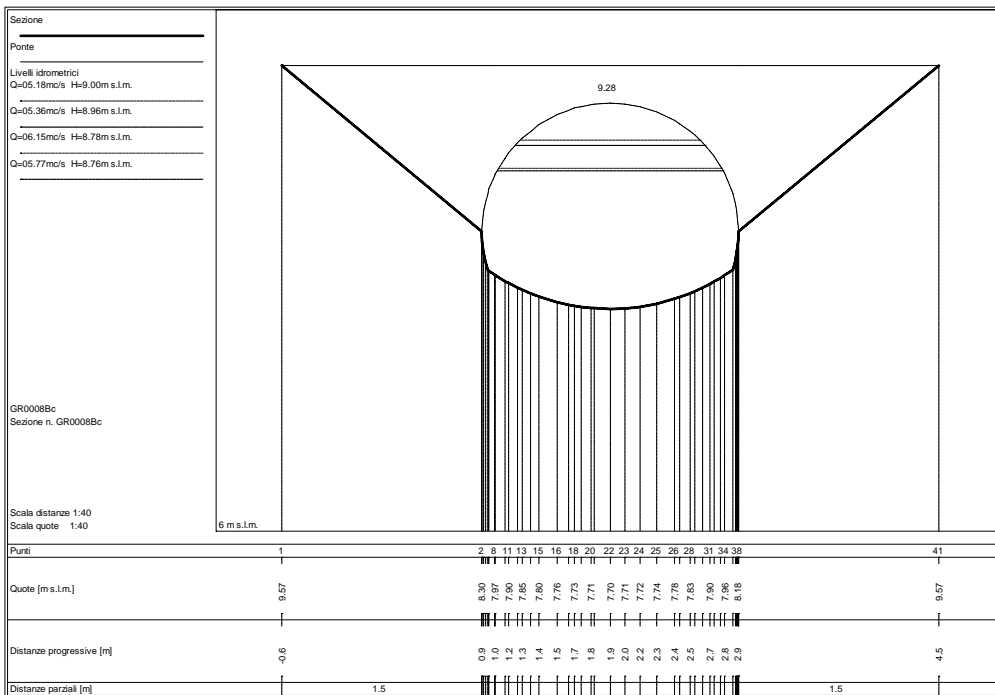
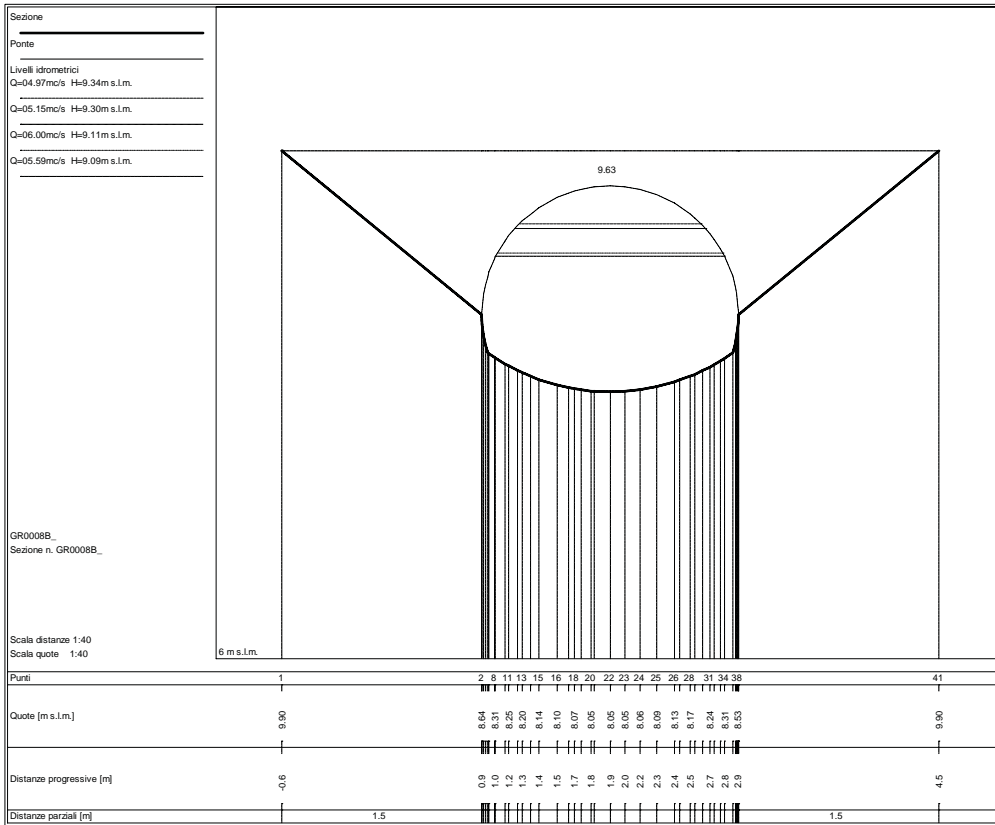

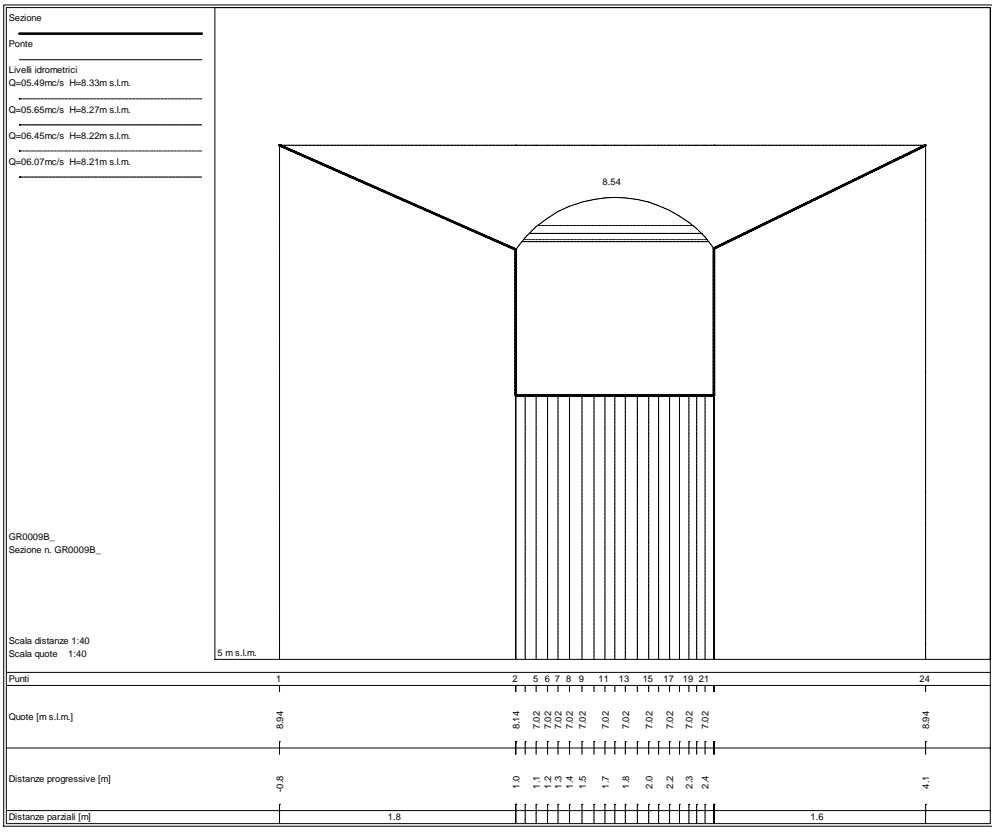
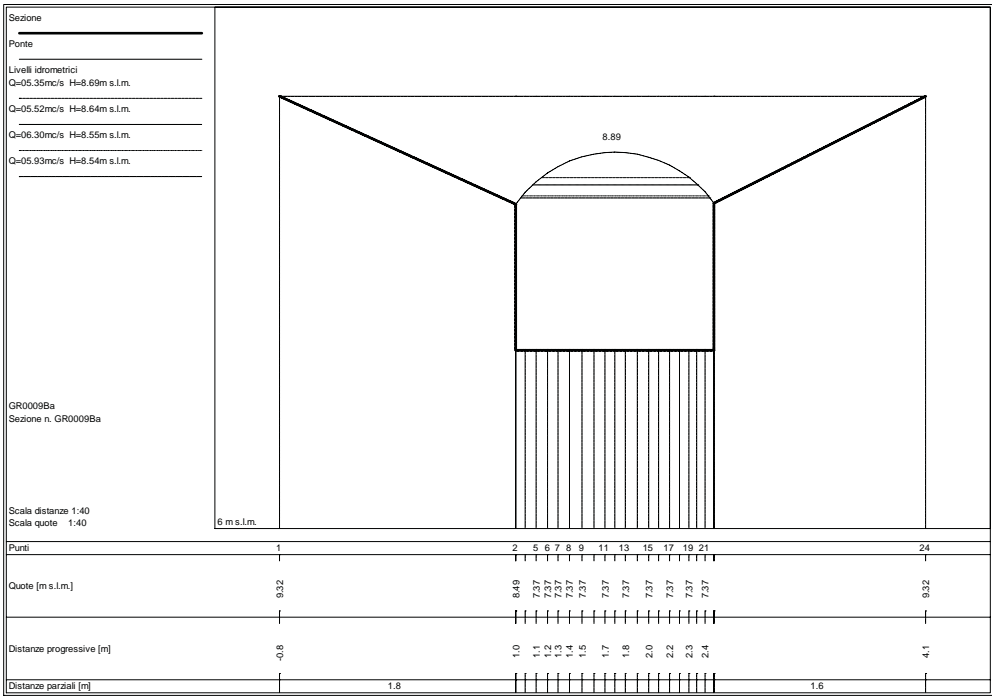

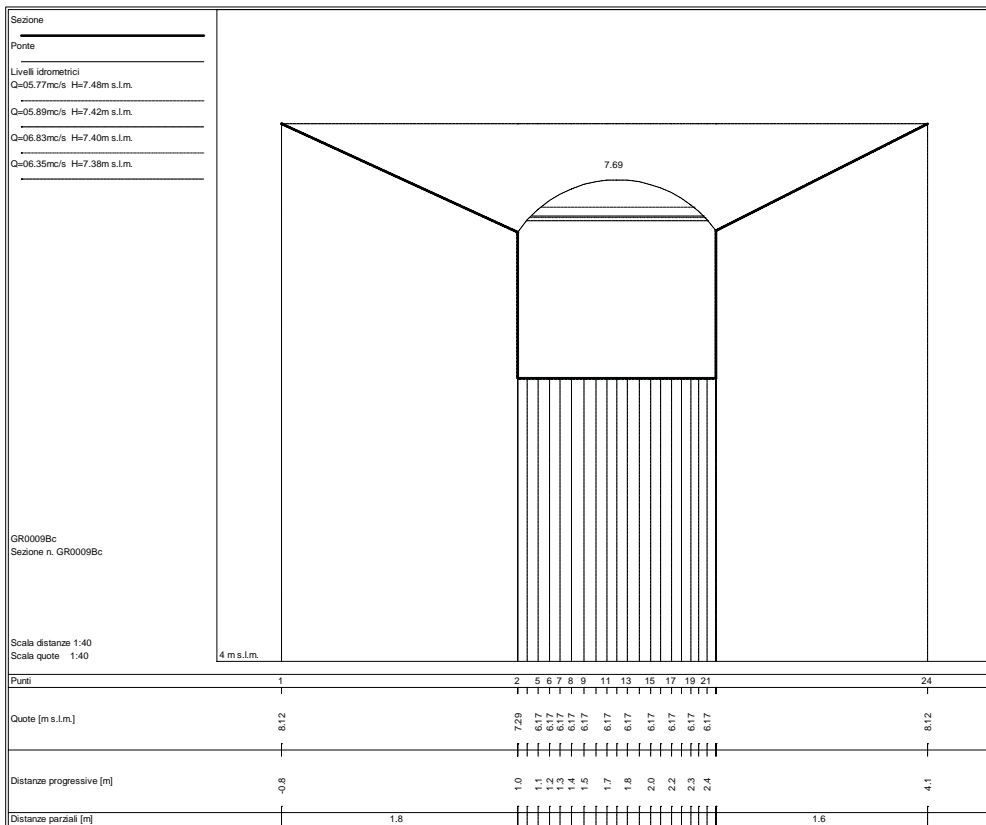
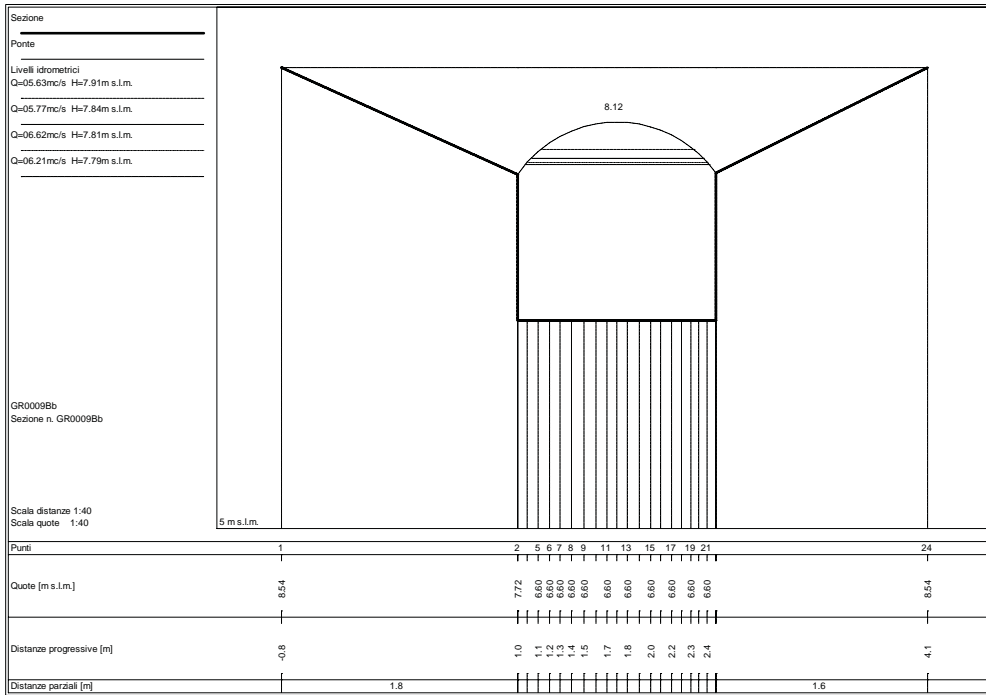

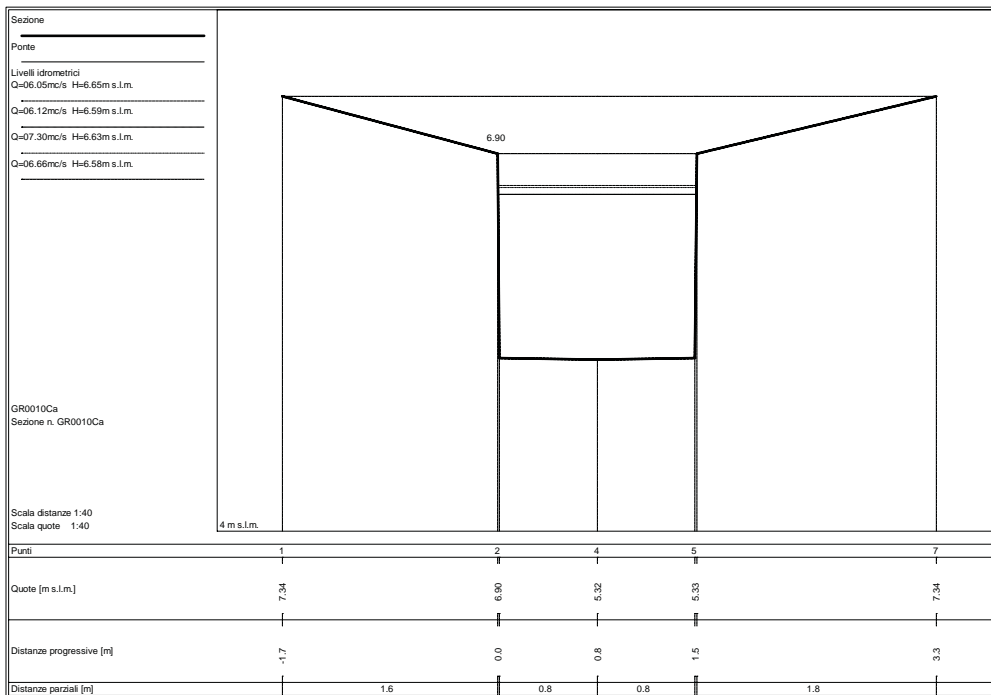
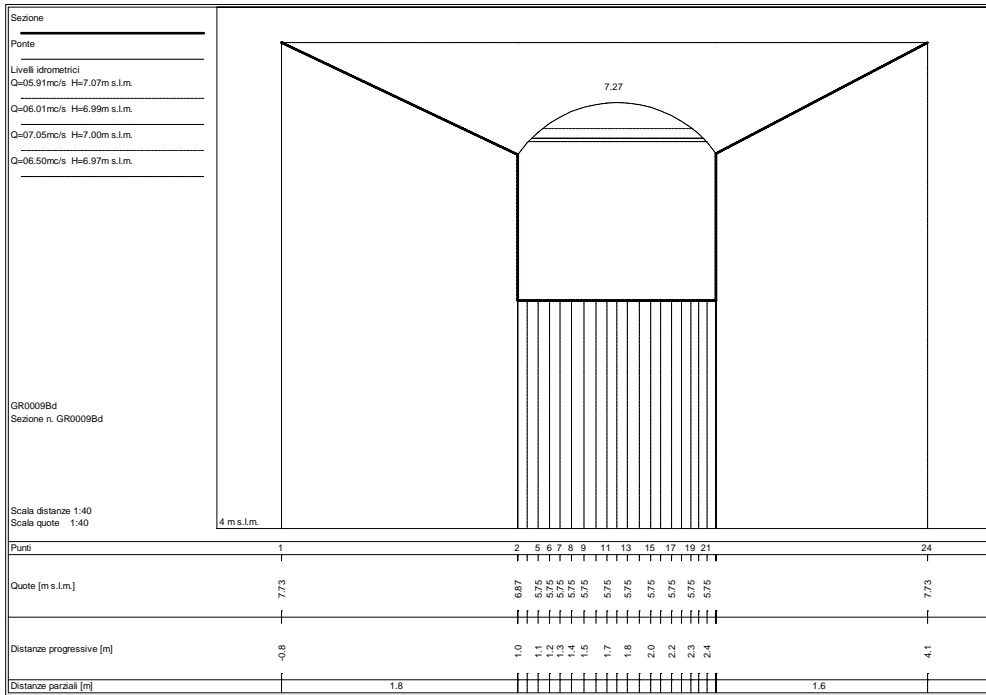

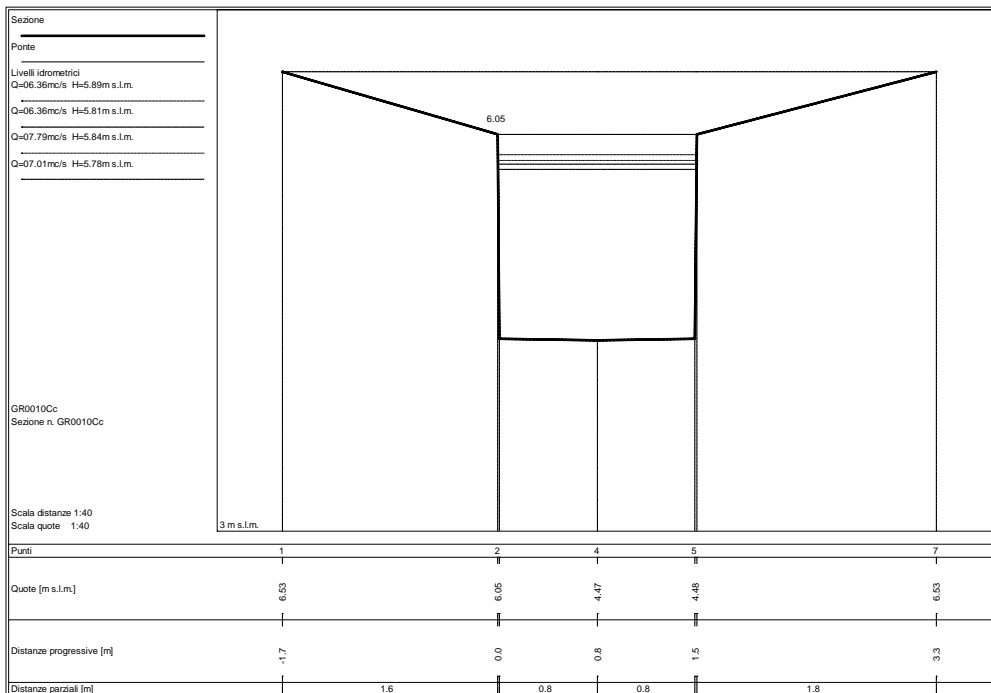
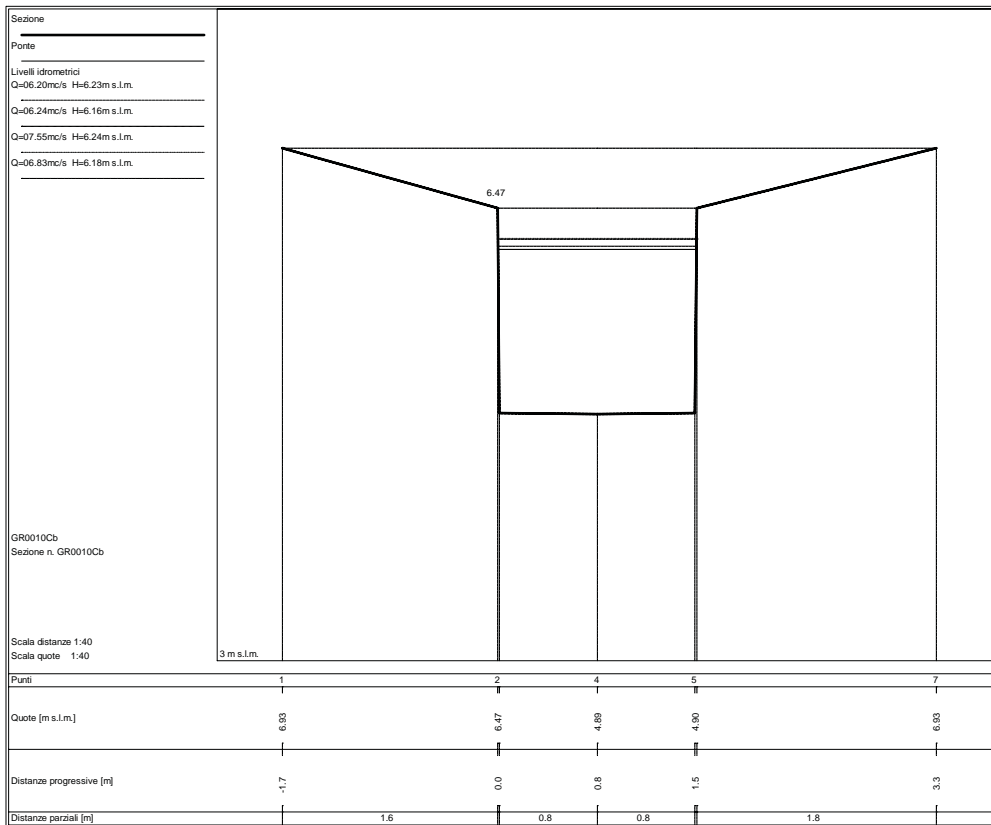

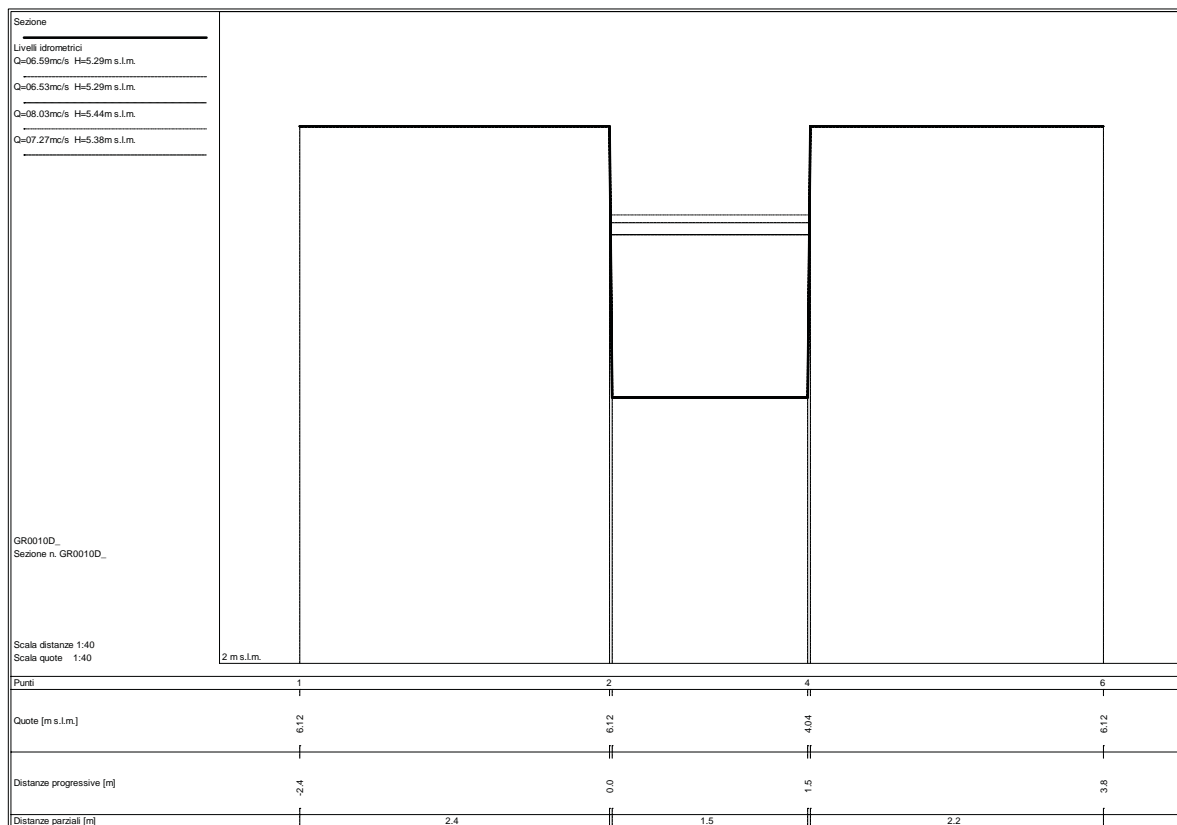
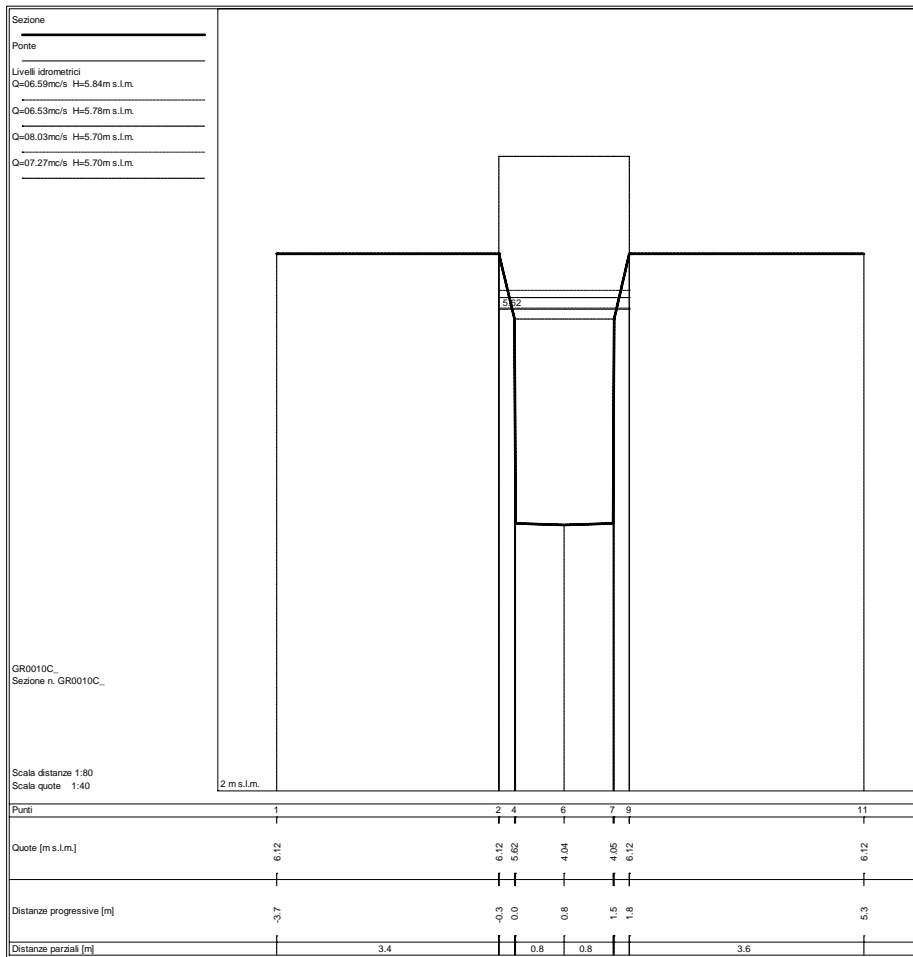

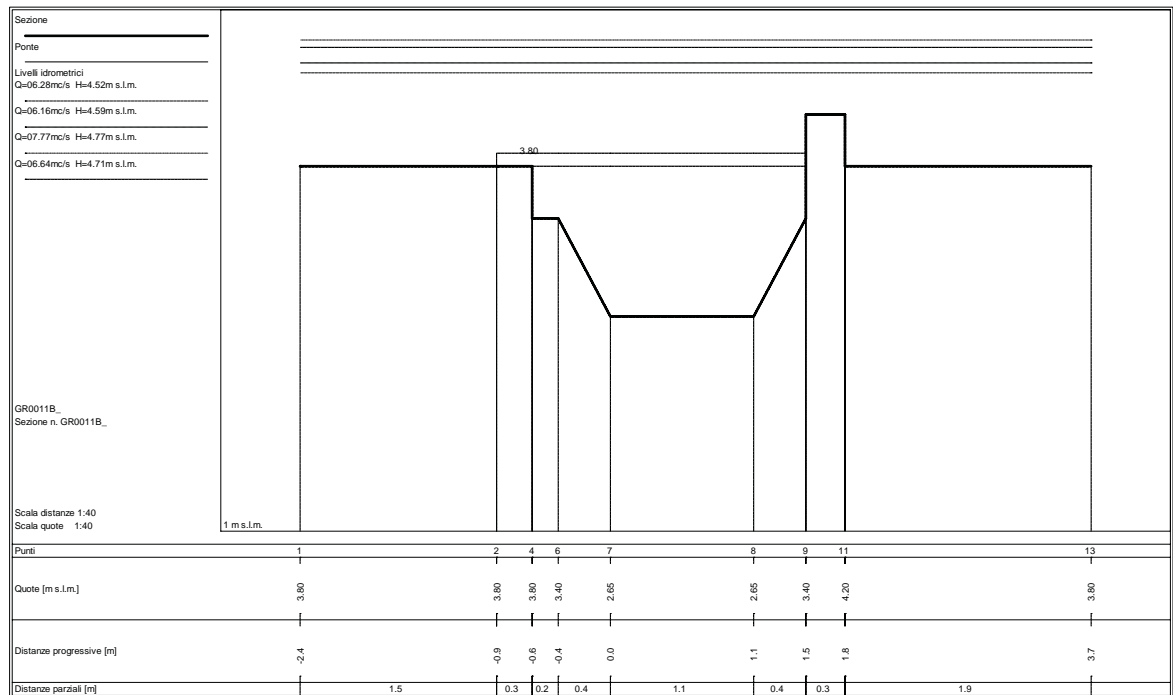
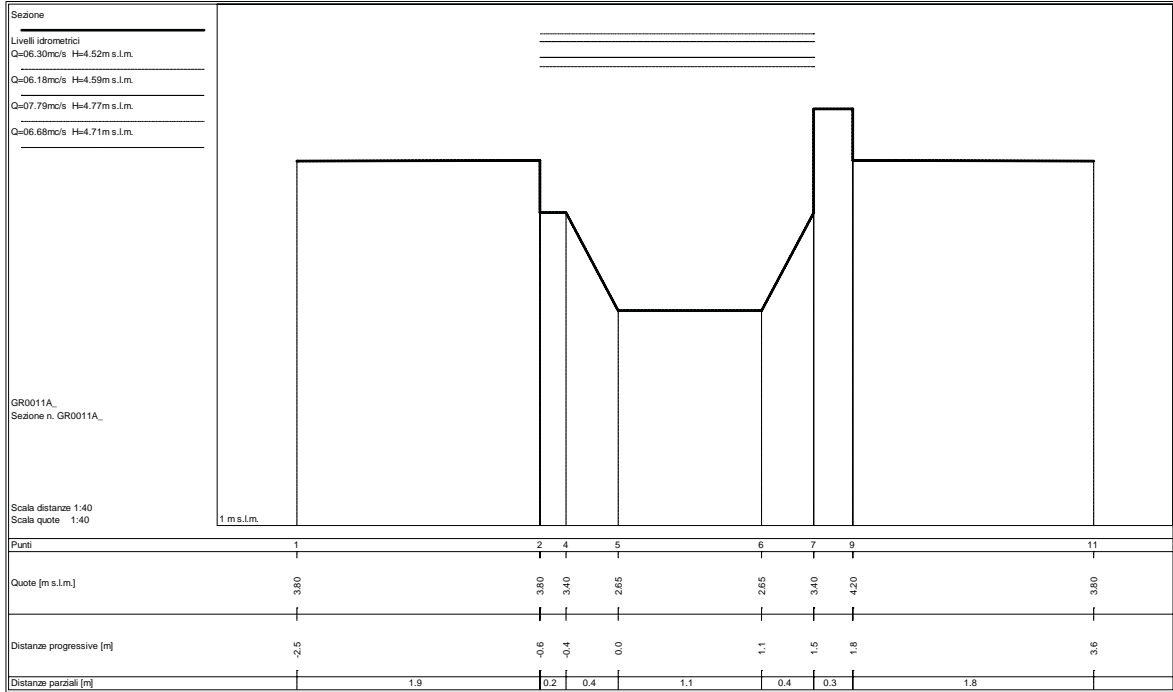

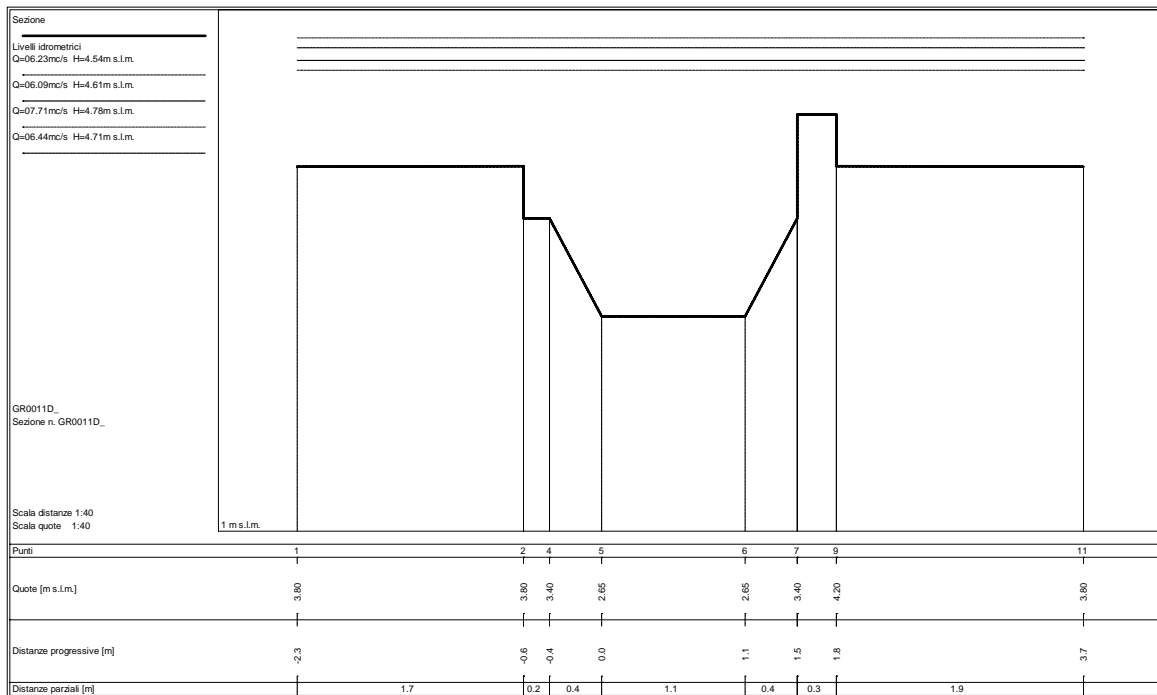
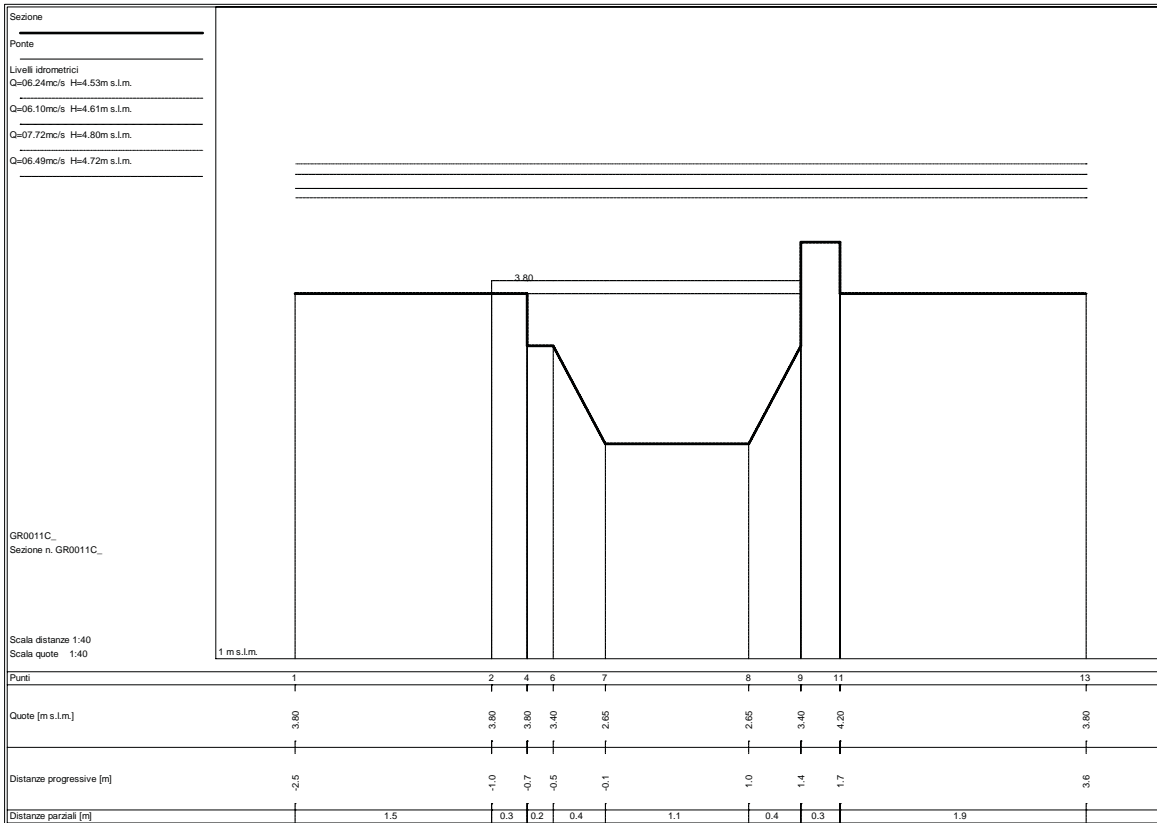

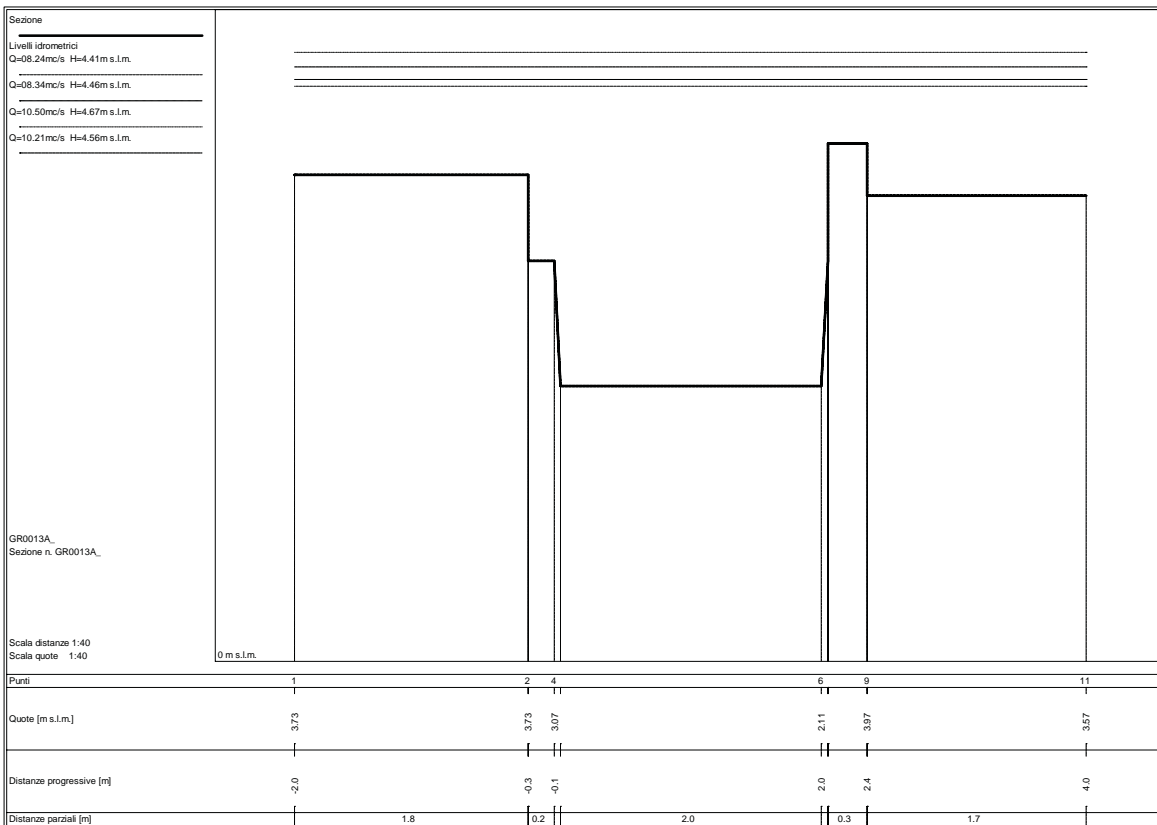
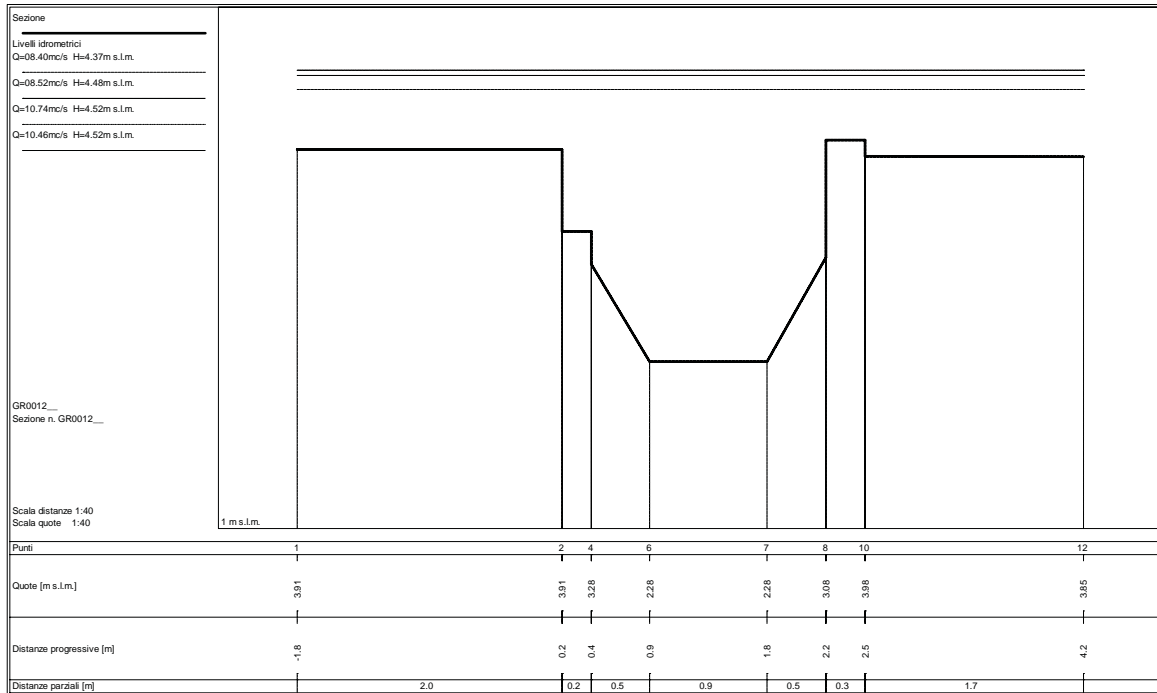

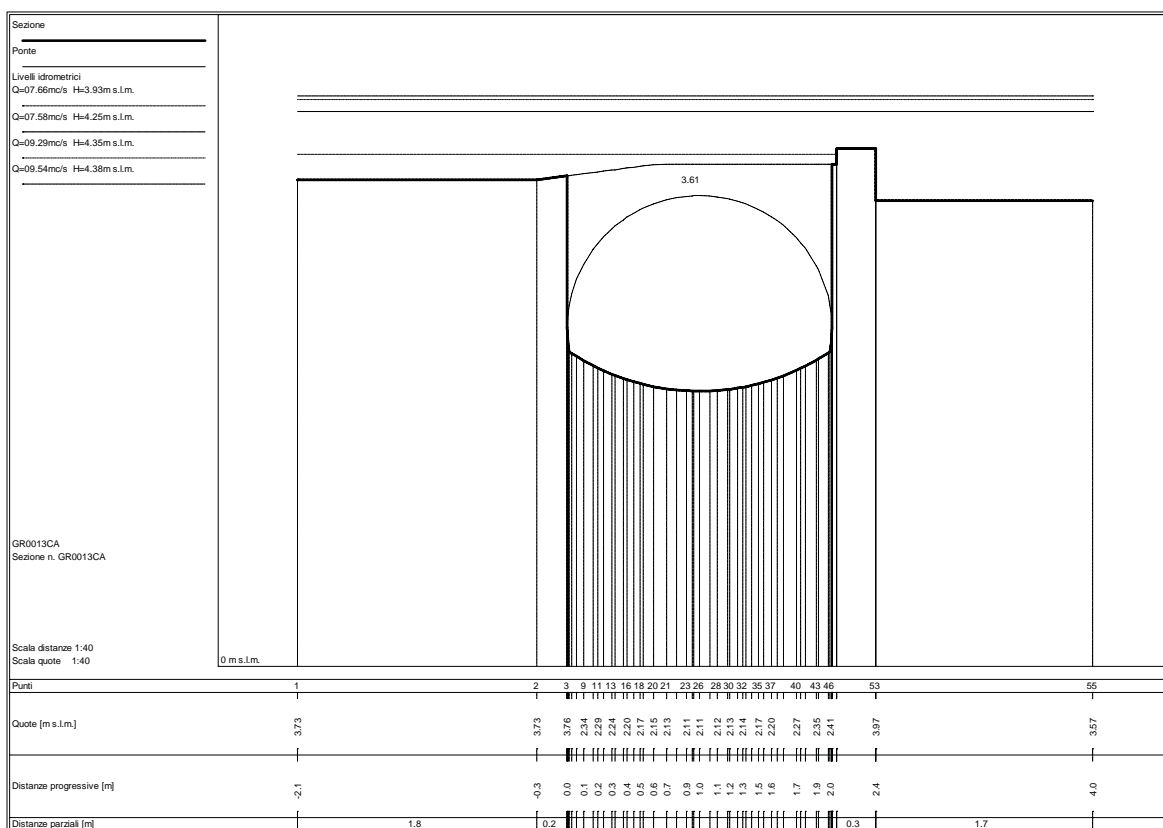
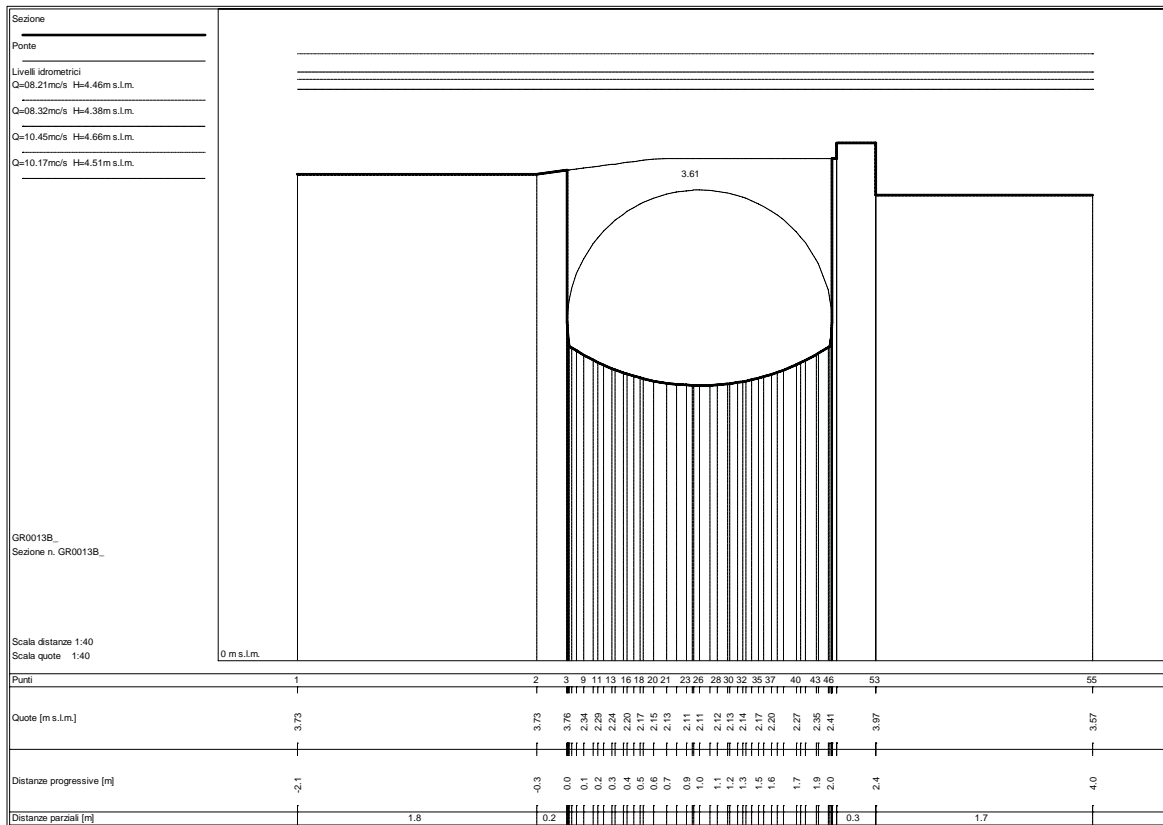

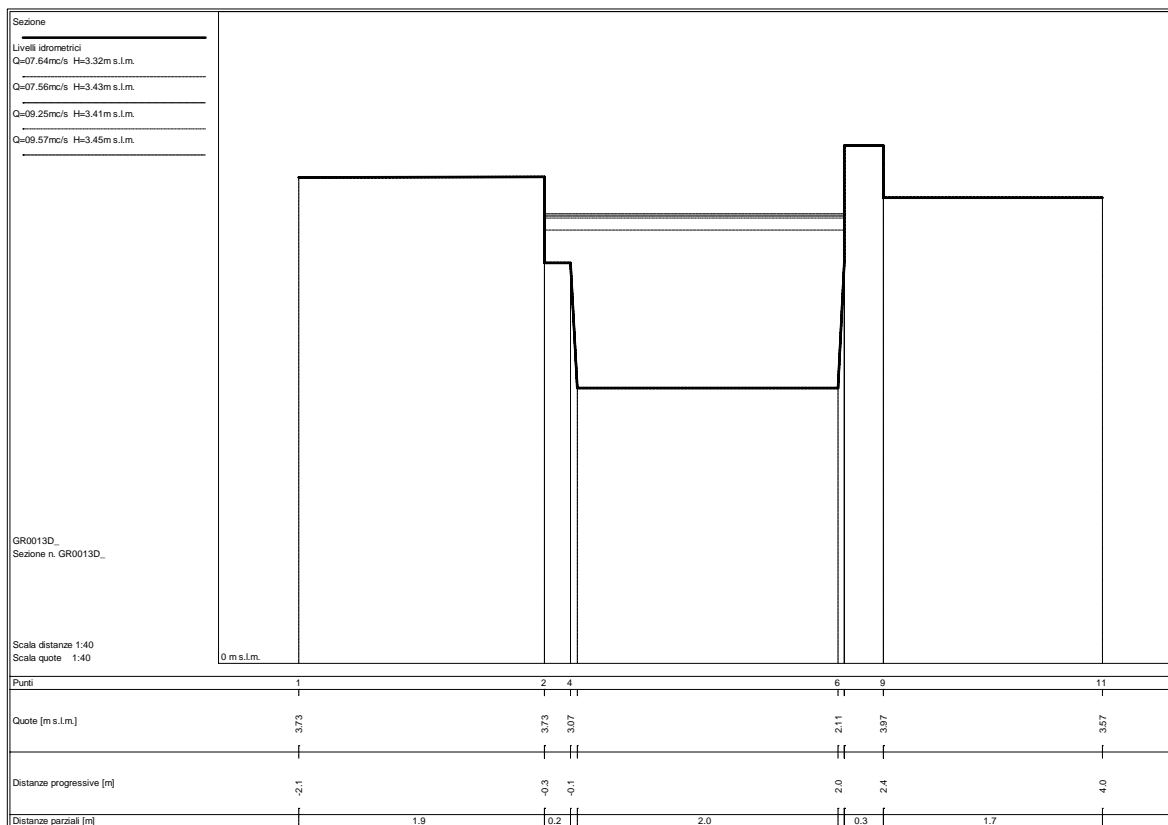
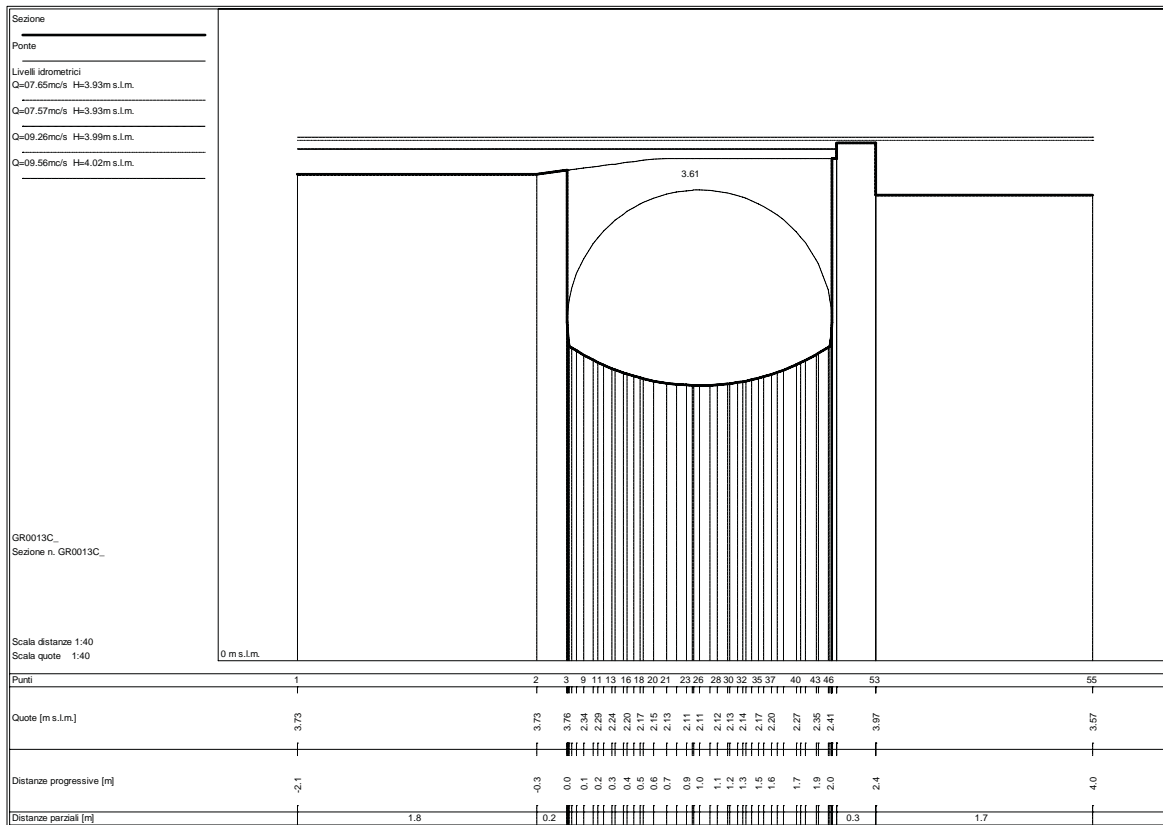

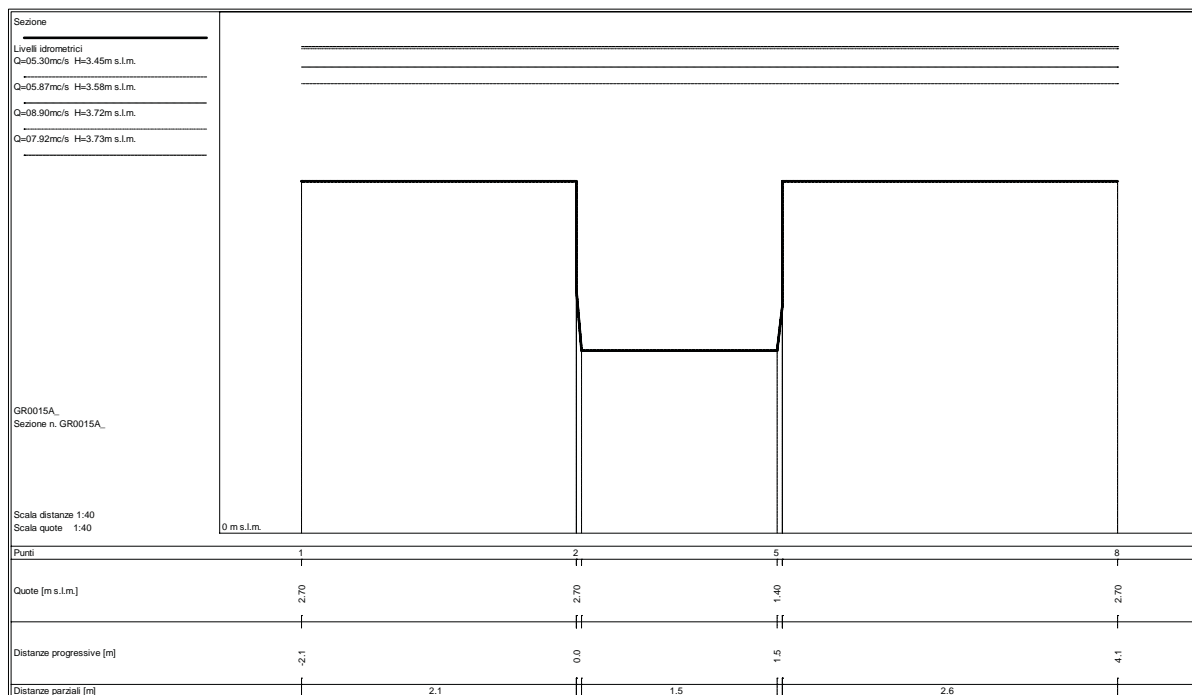
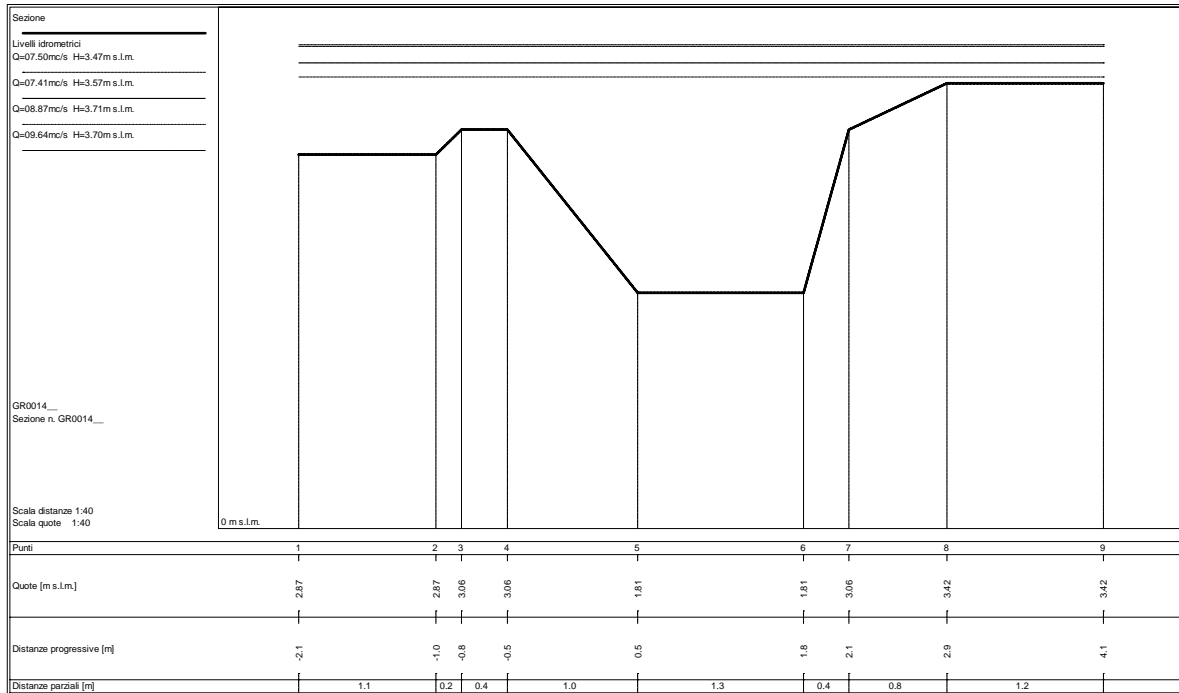

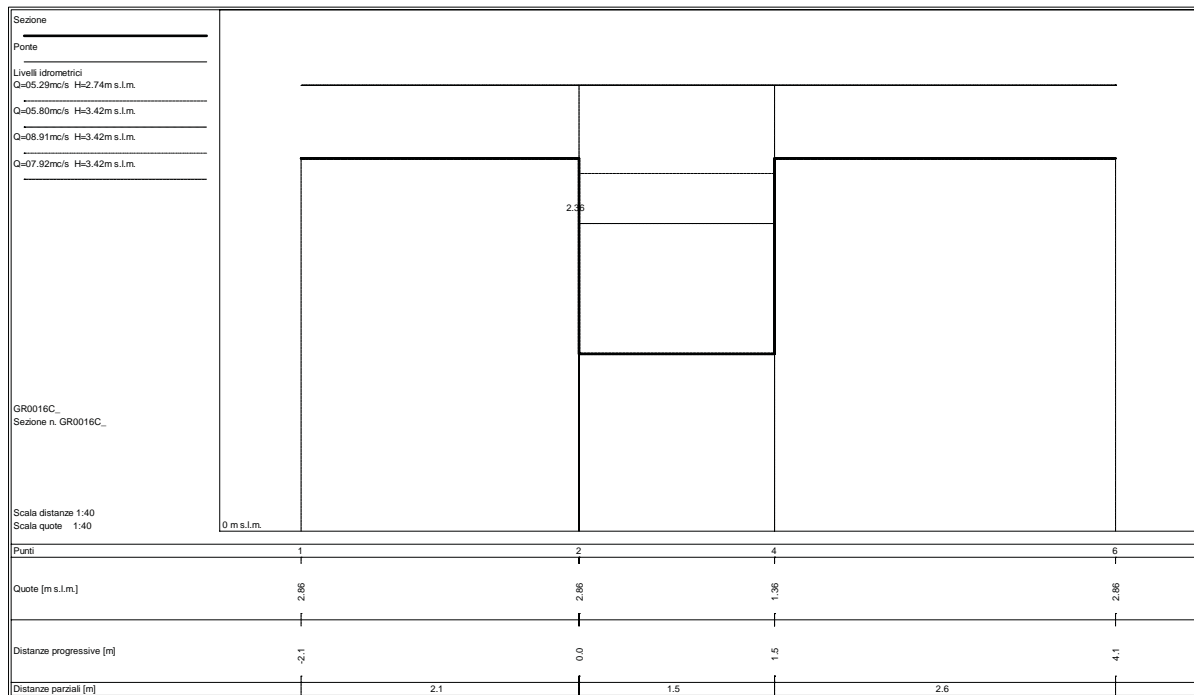
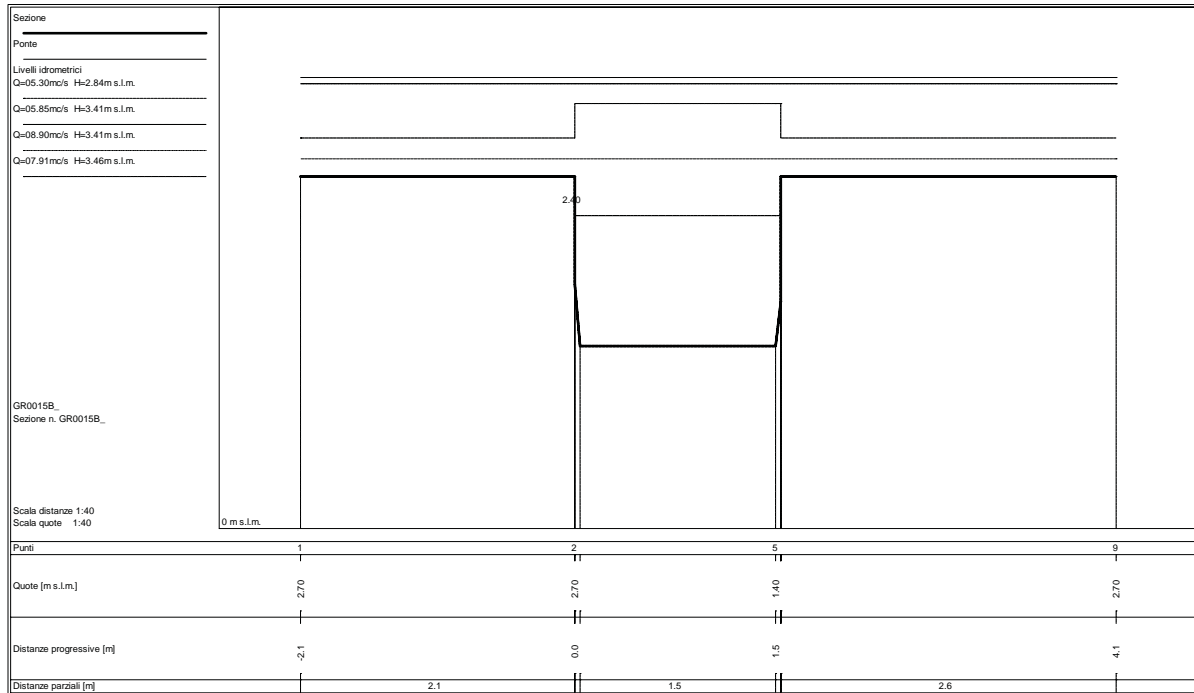

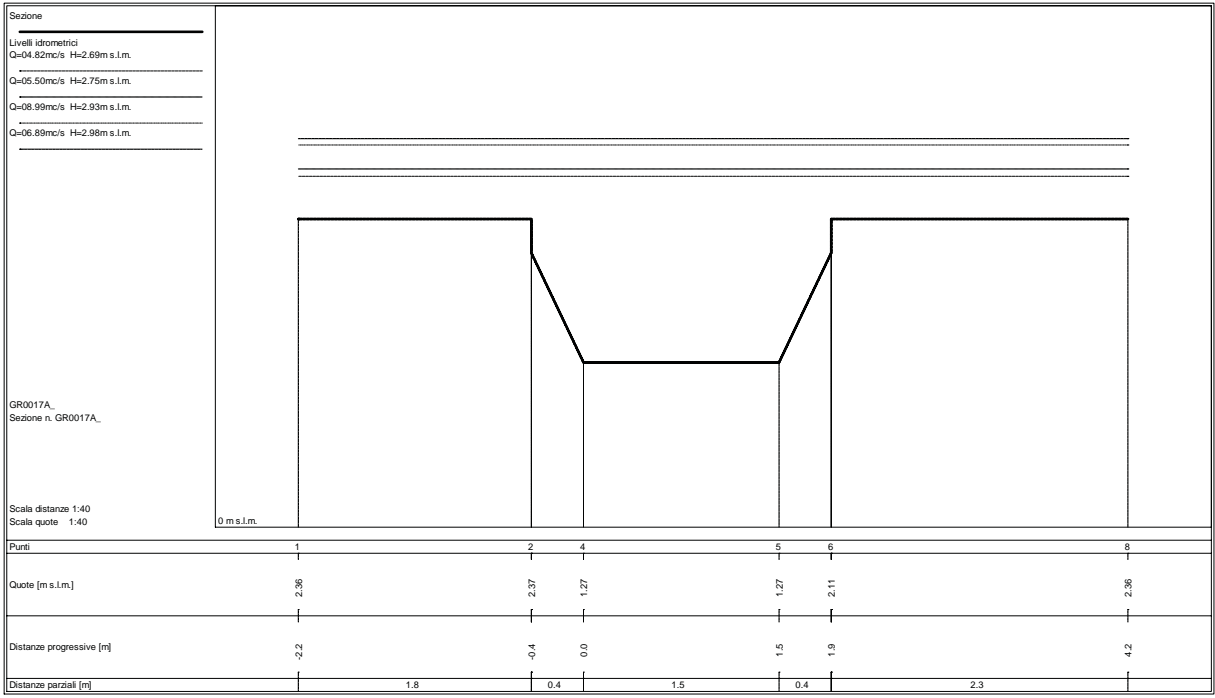
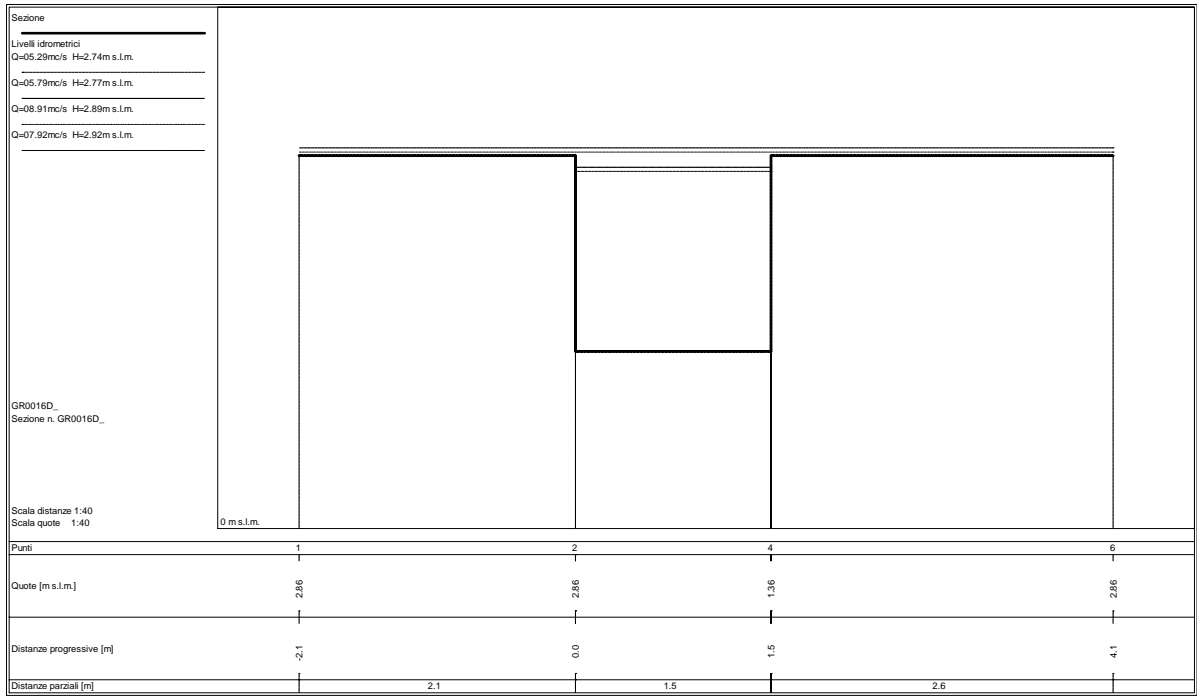

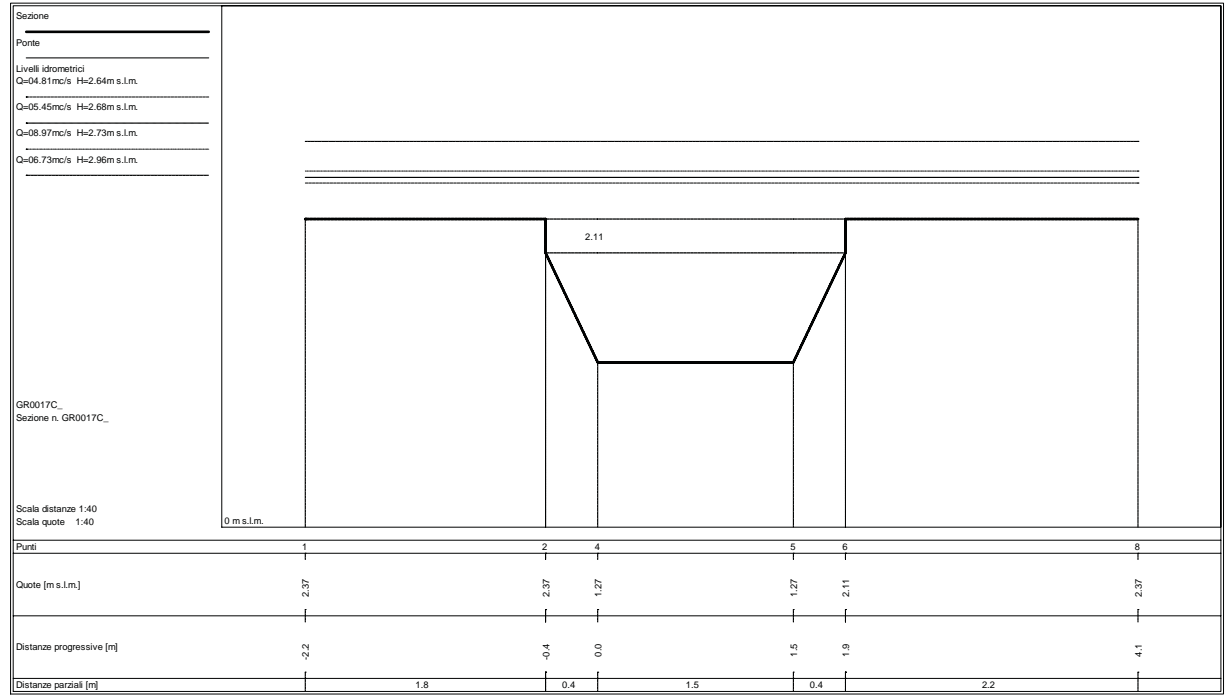
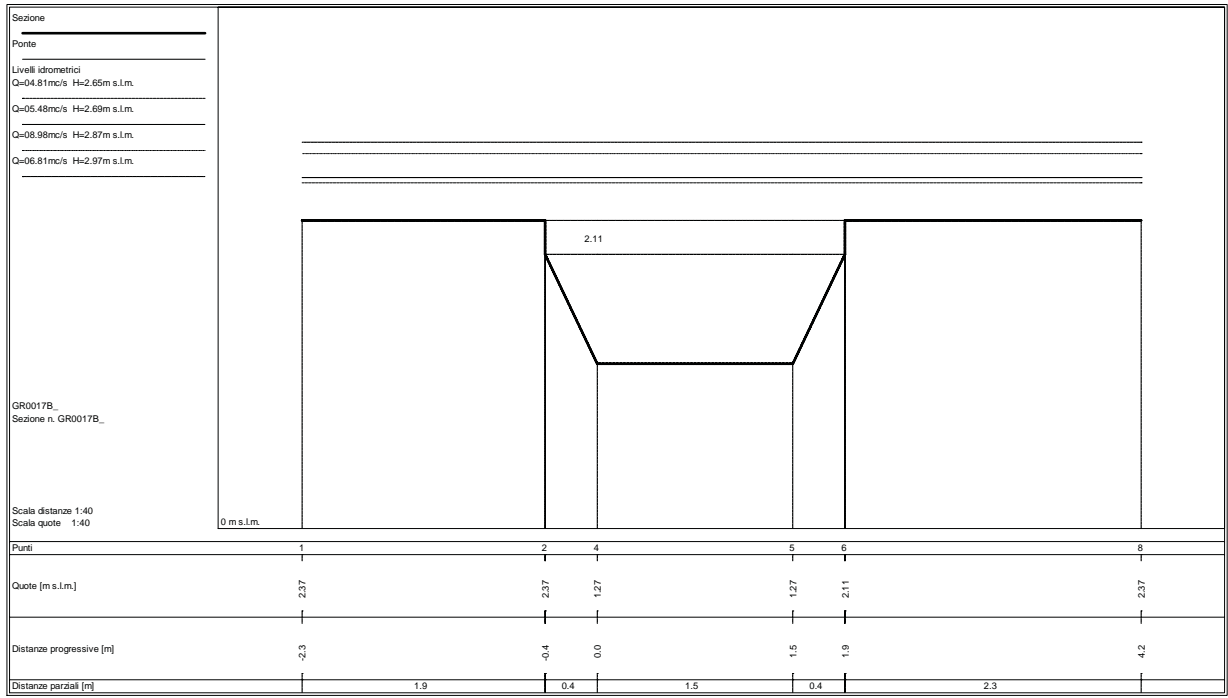

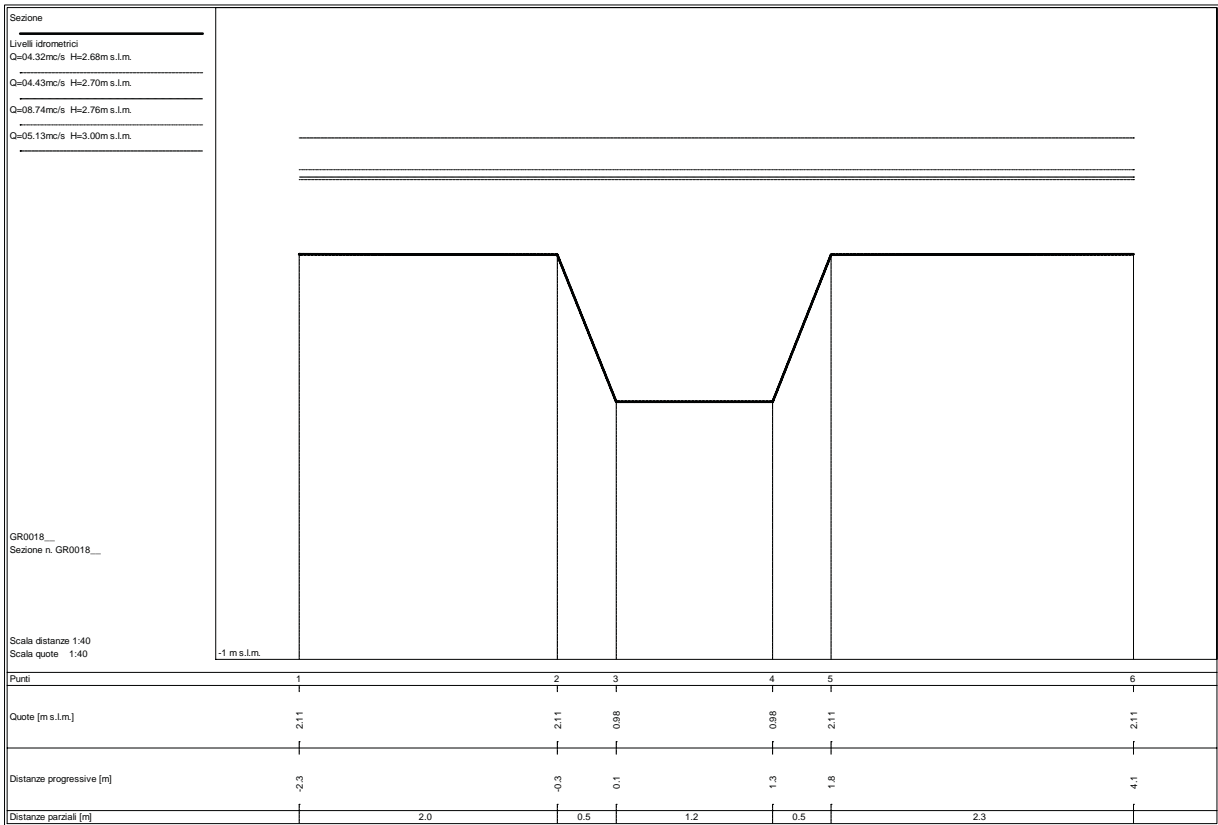
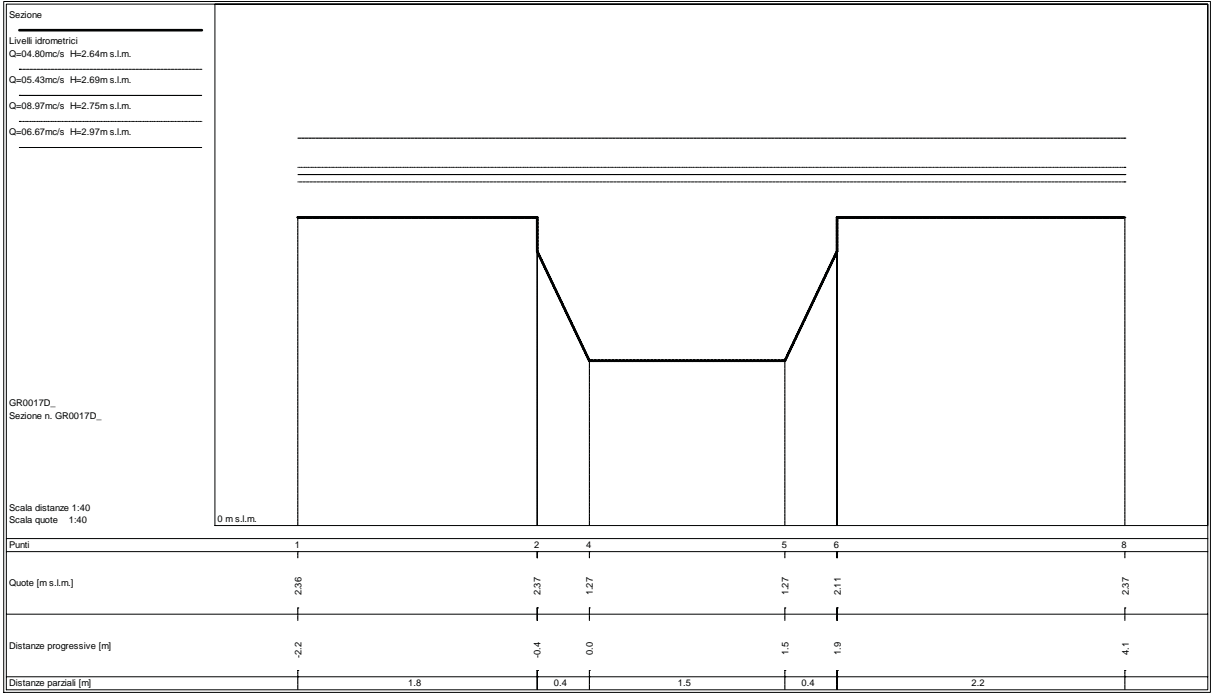

Sezione

 Livelli idrometrici
 Q=04.32mc/s H=2.69m s.l.m.

 Q=04.43mc/s H=2.71m s.l.m.

 Q=08.74mc/s H=2.80m s.l.m.

 Q=05.13mc/s H=3.00m s.l.m.



GR0019A_
 Sezione n. GR0019A_

Scale distanze 1:40
 Scale quote 1:40

Punti	1	2	4	5	6	8	10	12
Quote [m s.l.m.]	2.28	2.28	0.98	1.11	1.11	2.28	1.11	2.28
Distanze progressive [m]	-2.3	-0.9	0.4	0.8	1.6	1.8	3.0	4.1
Distanze parziali [m]		1.4	1.3	0.4	0.8	0.2	1.2	1.1

STATO ATTUALE
Sezioni fluviali fosso Colletto

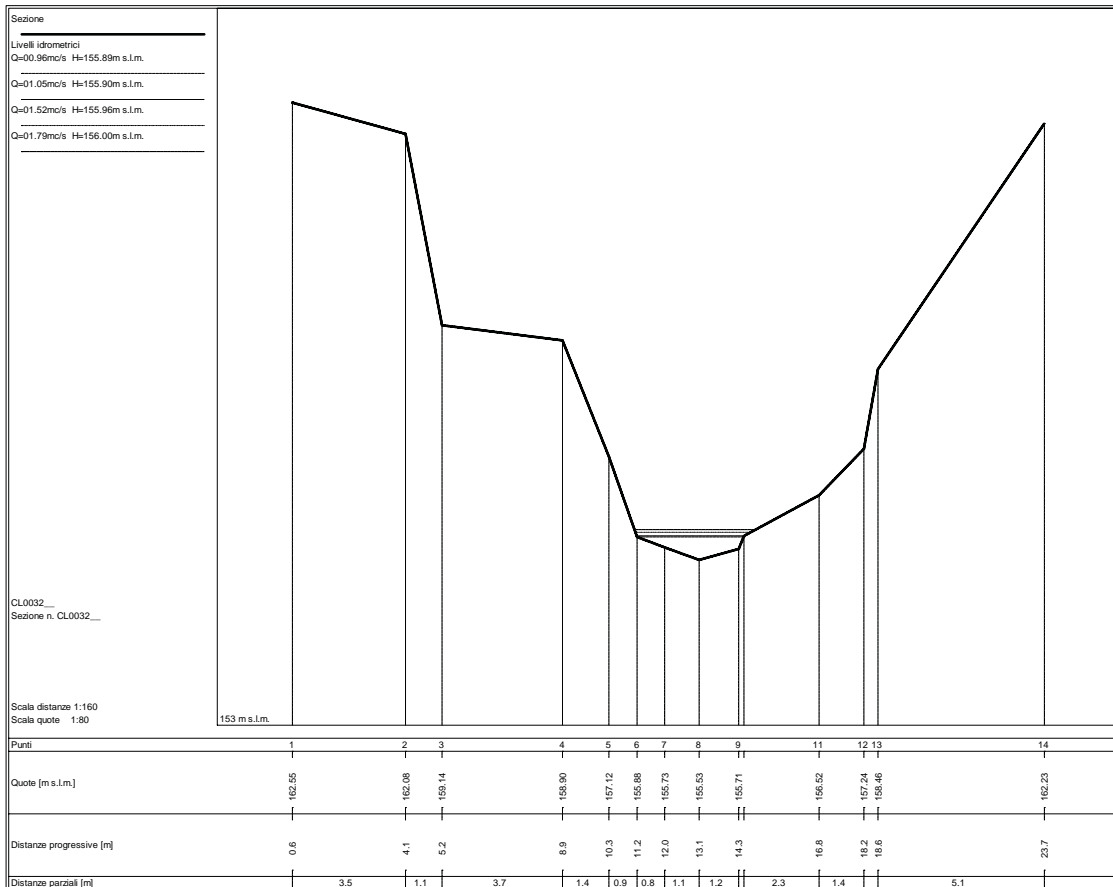
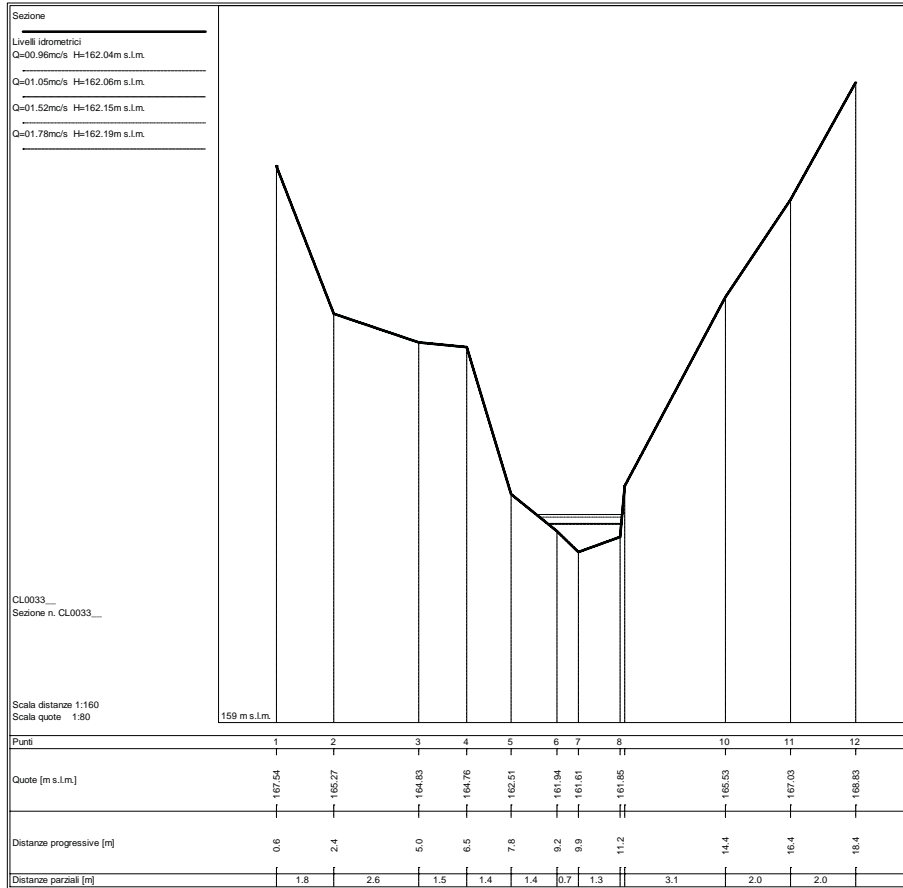

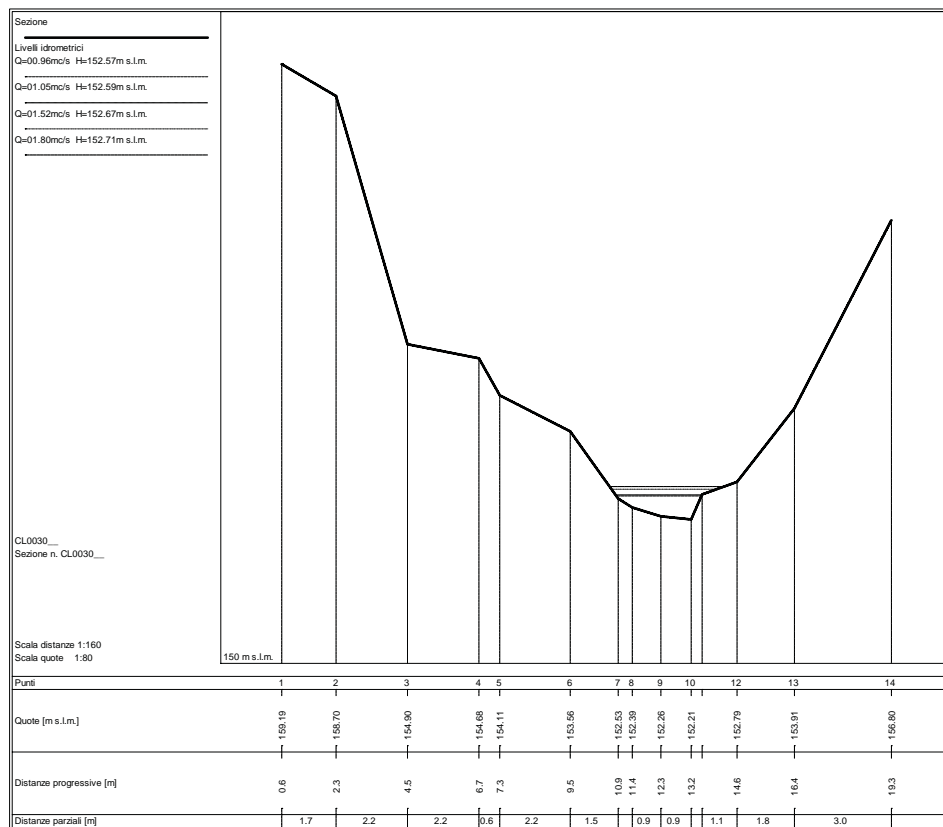
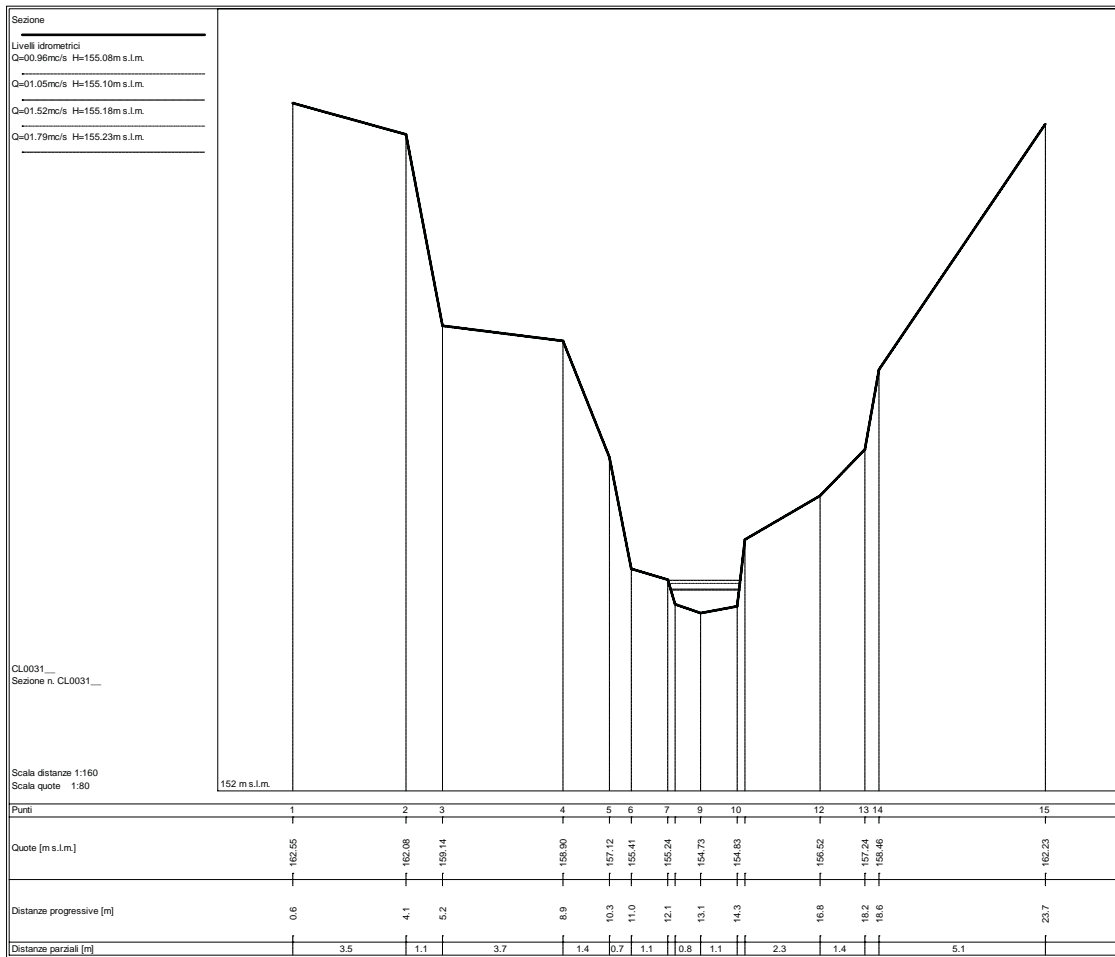

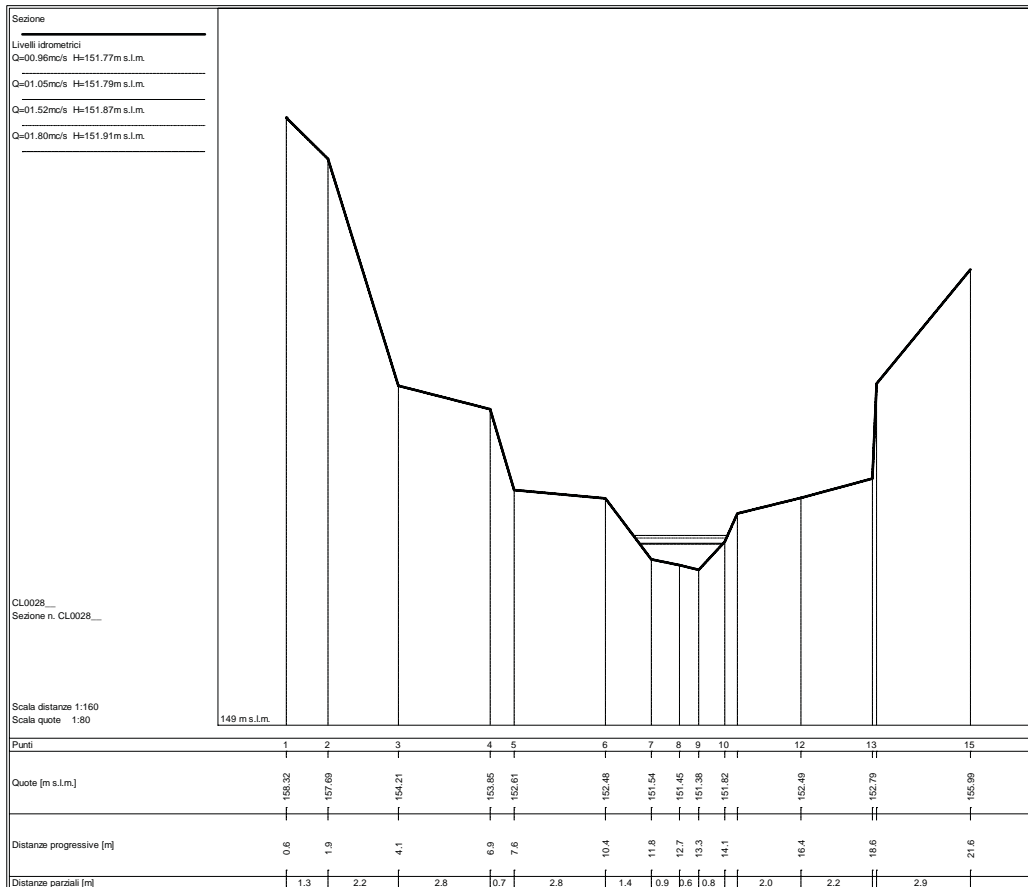
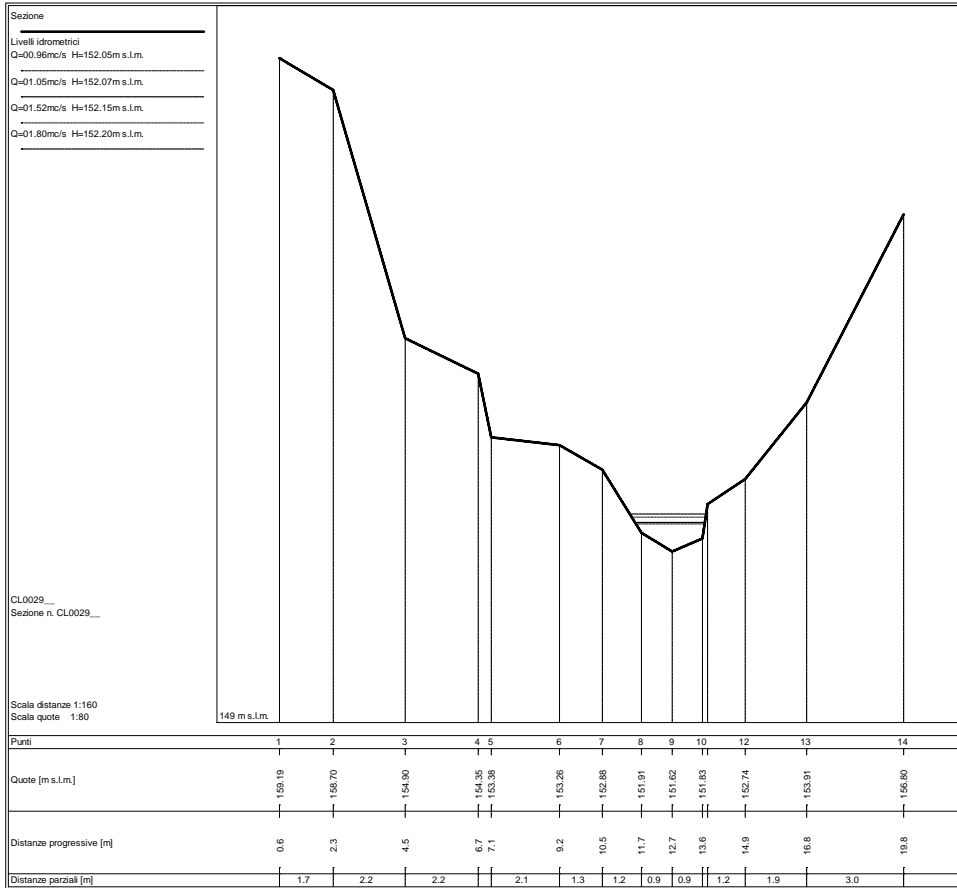

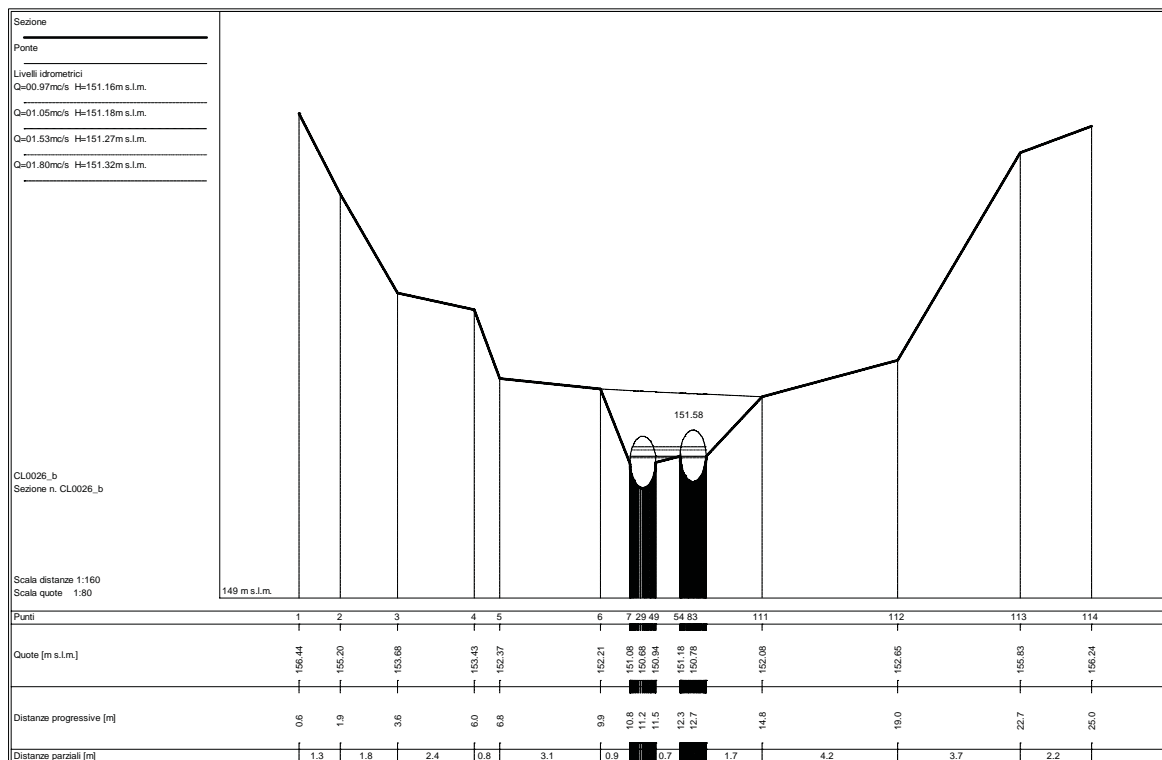
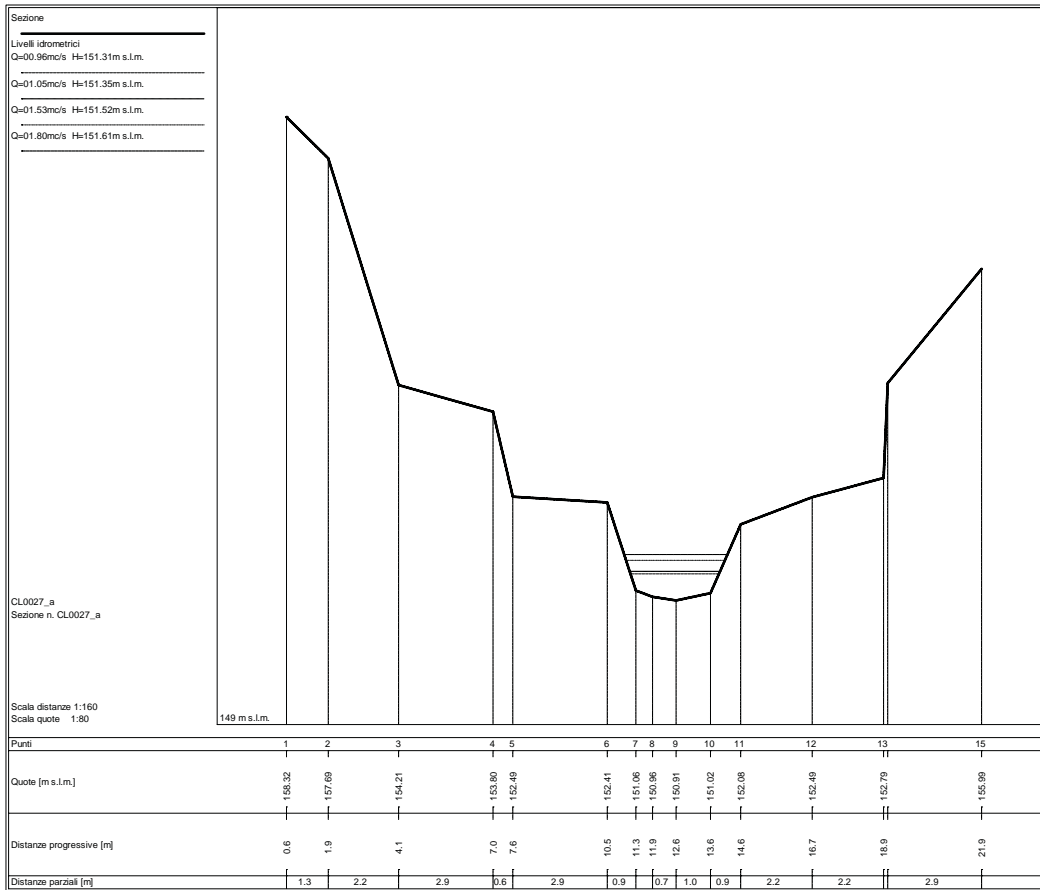

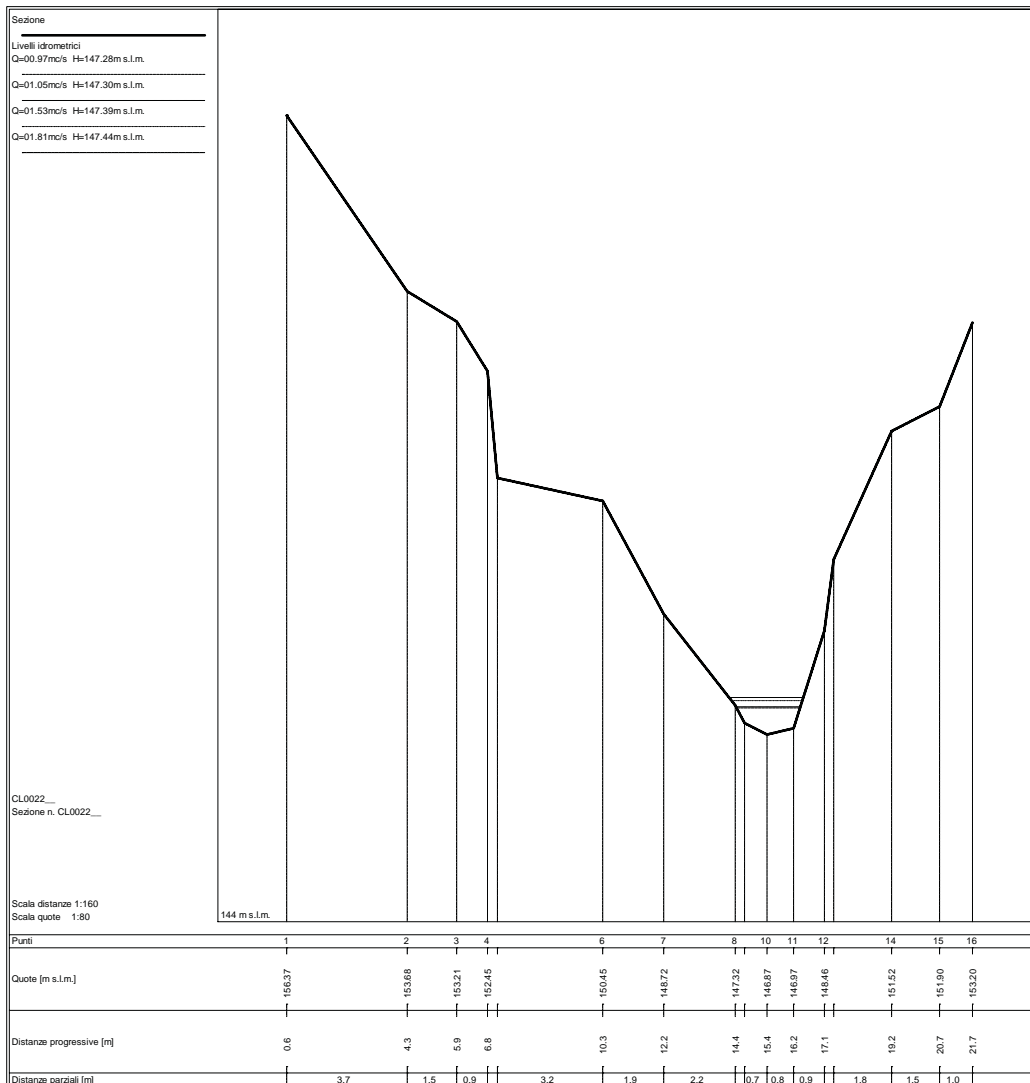
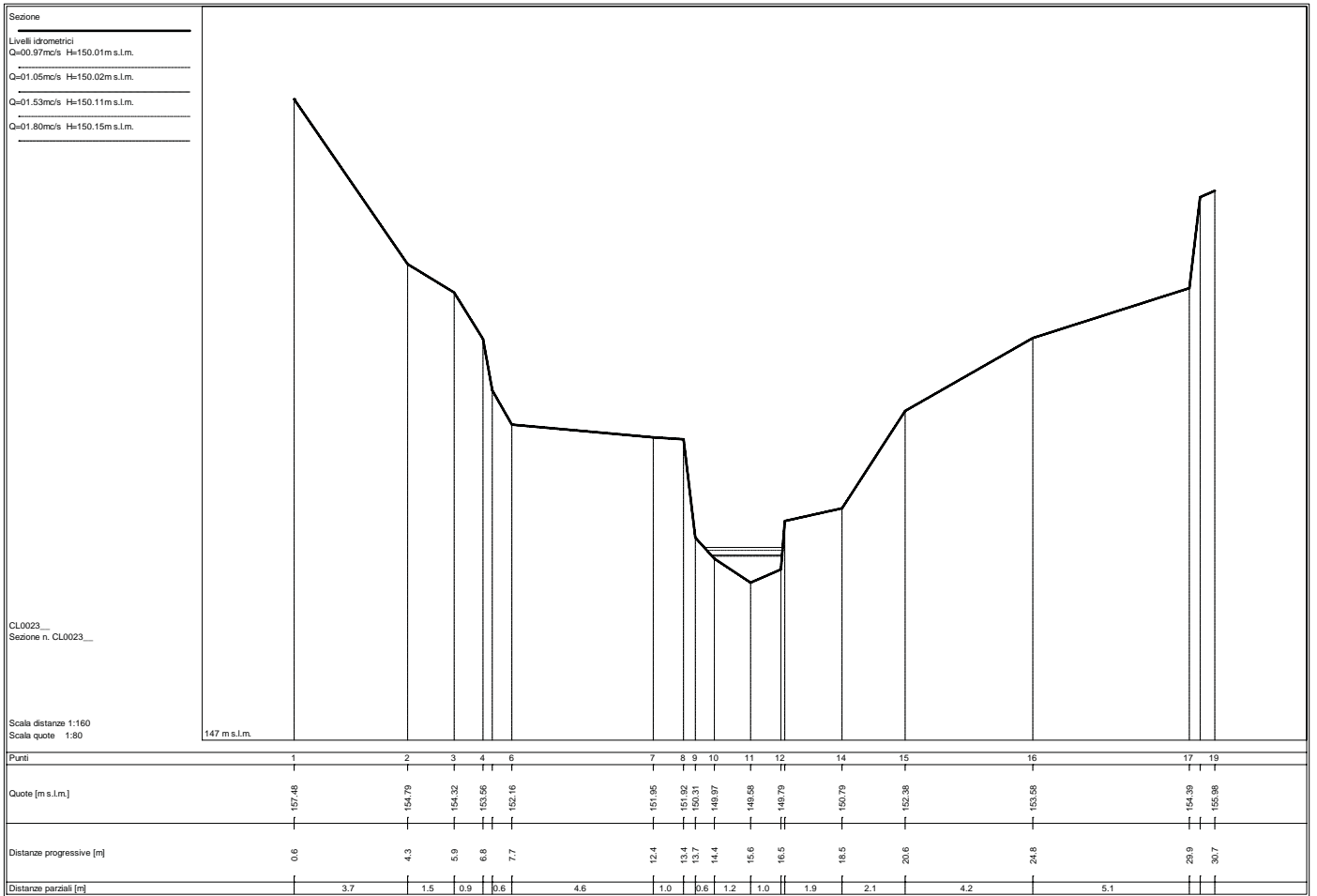

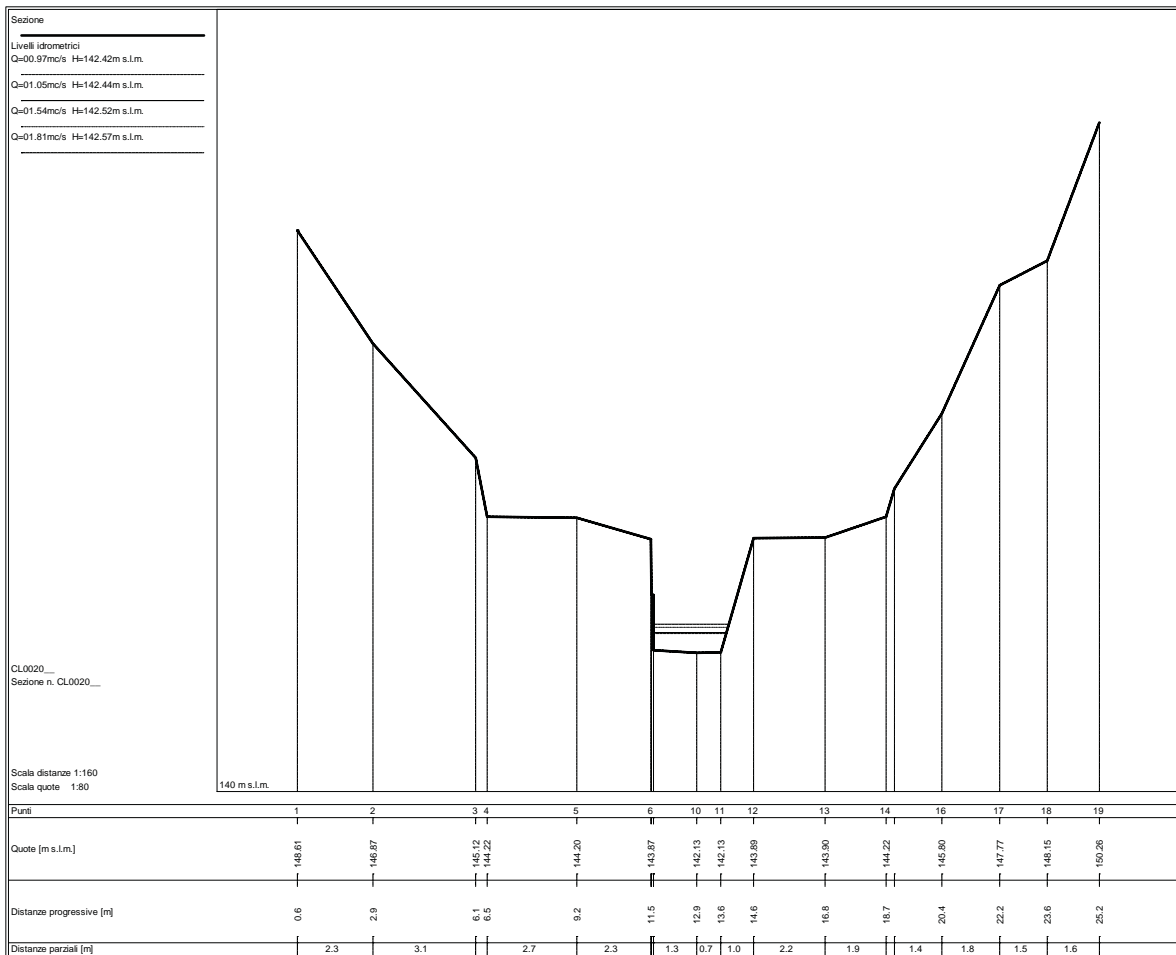
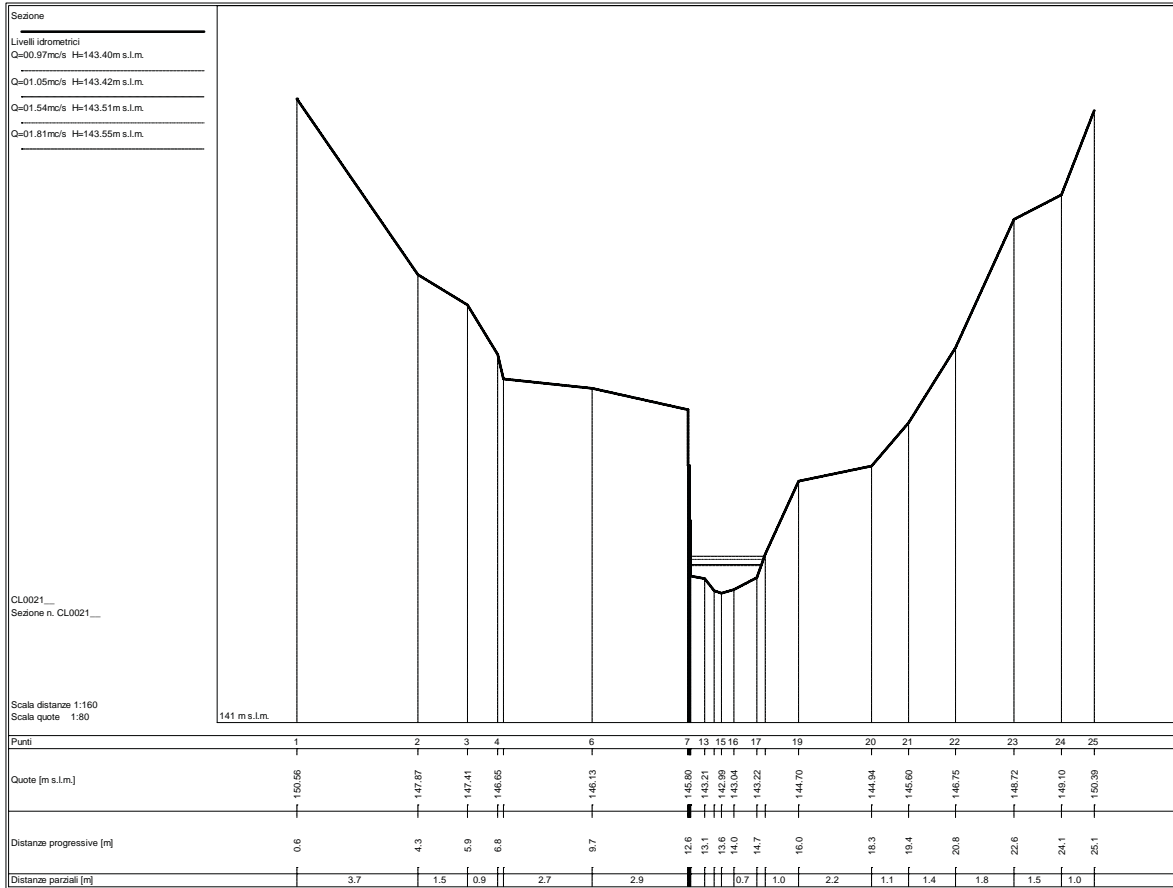

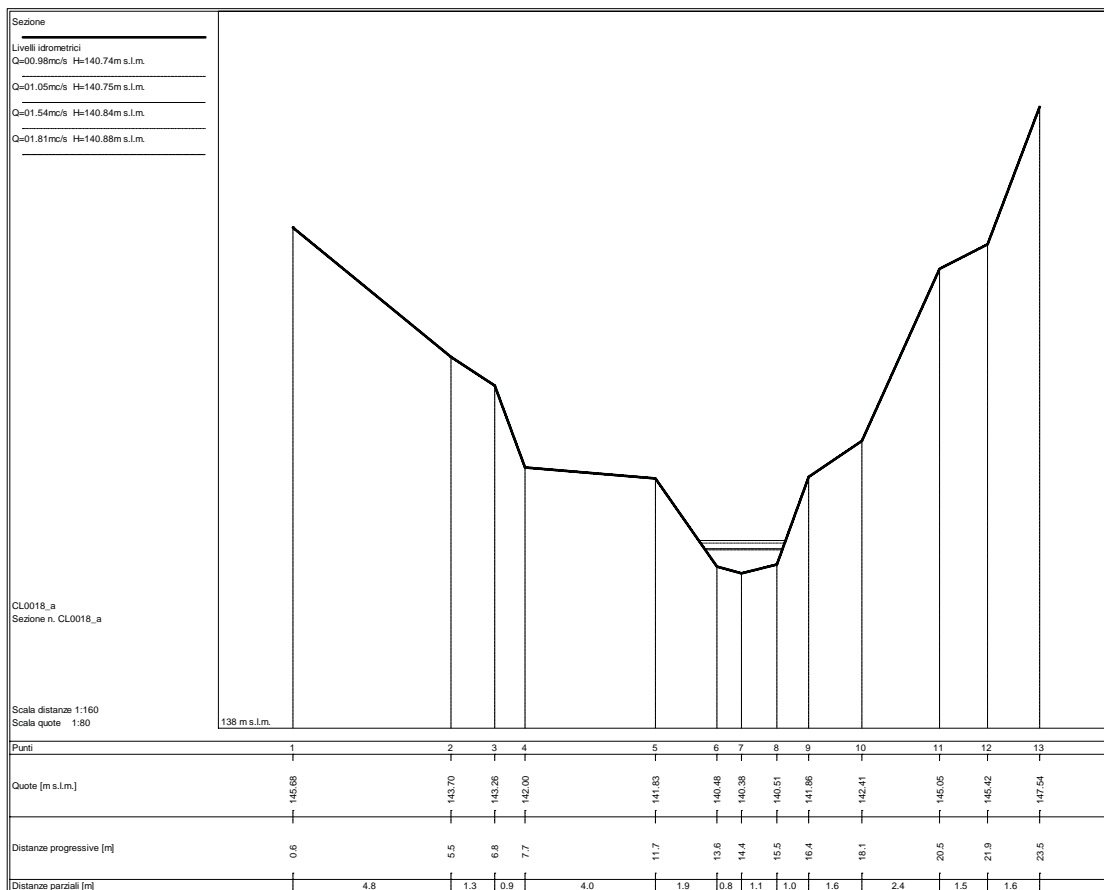
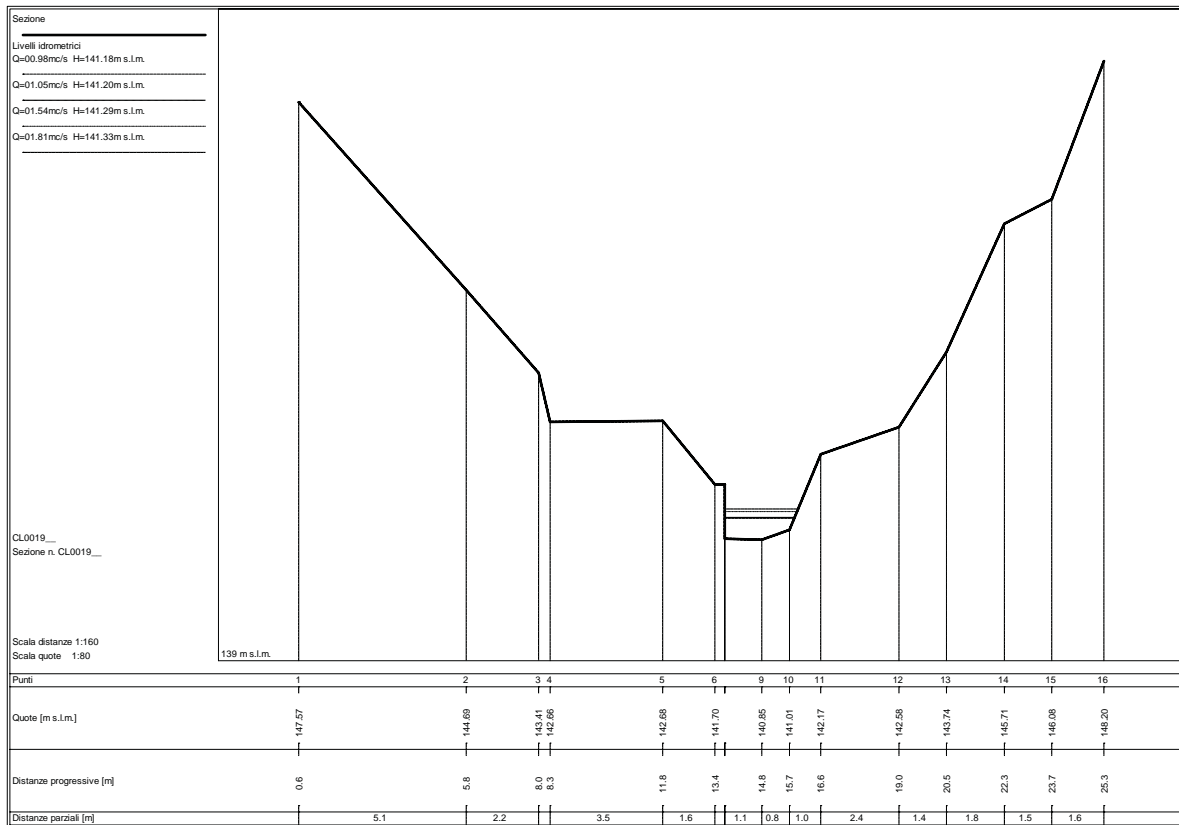

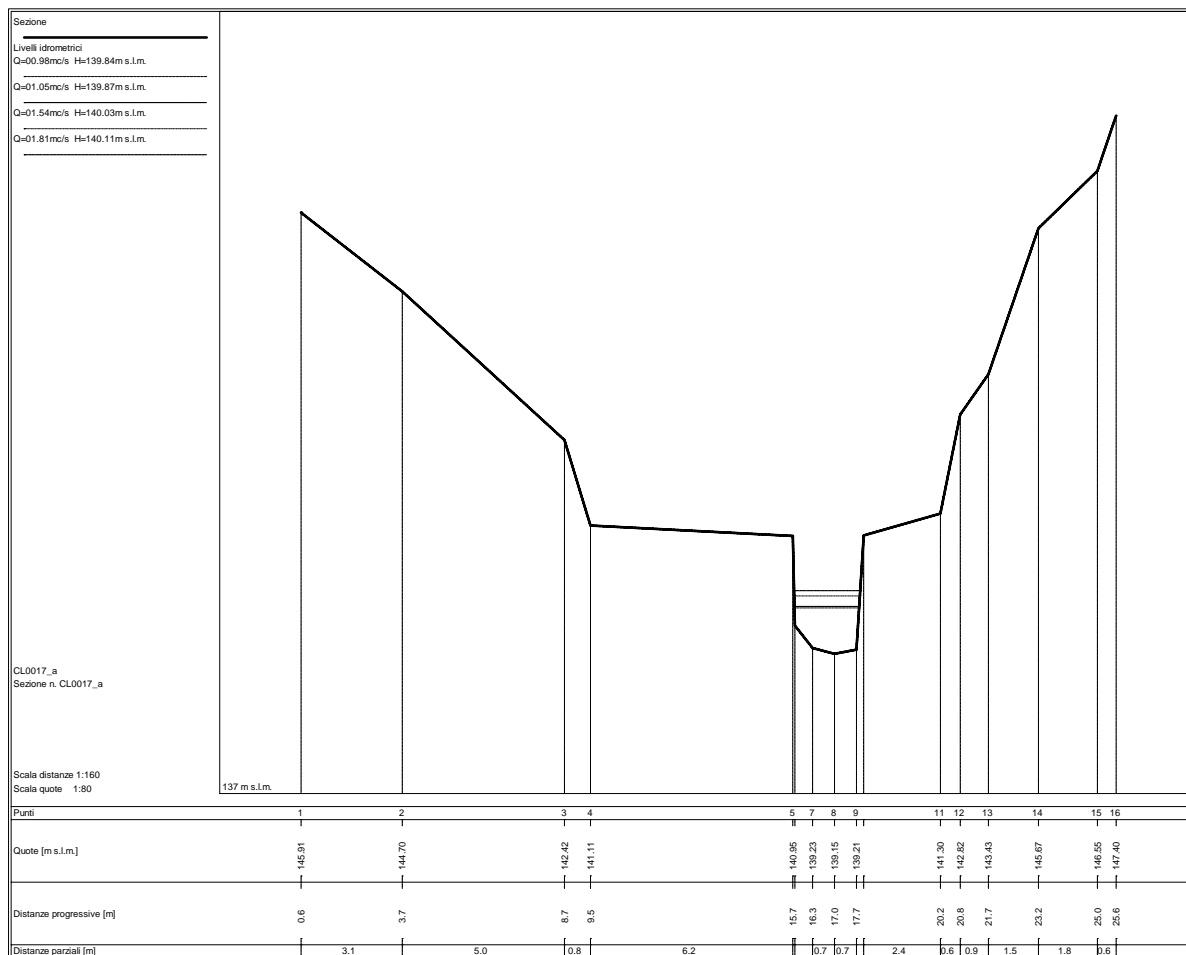
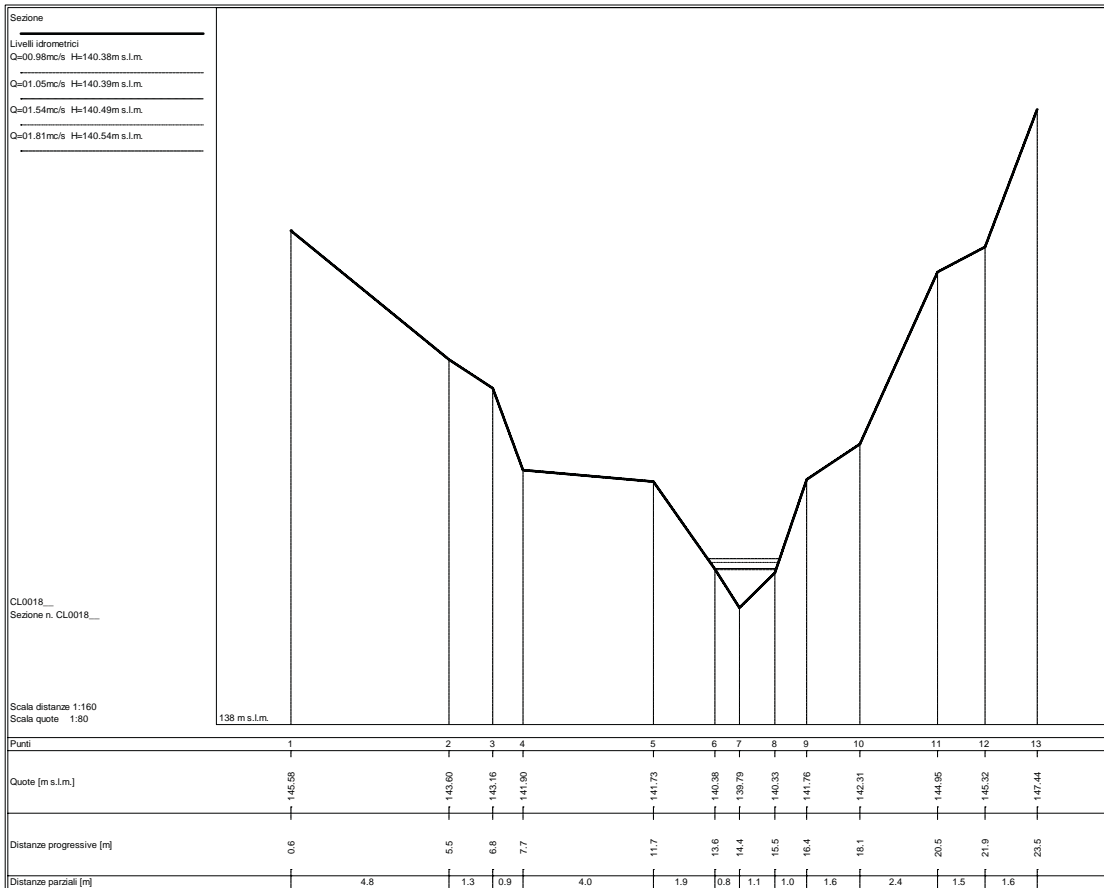

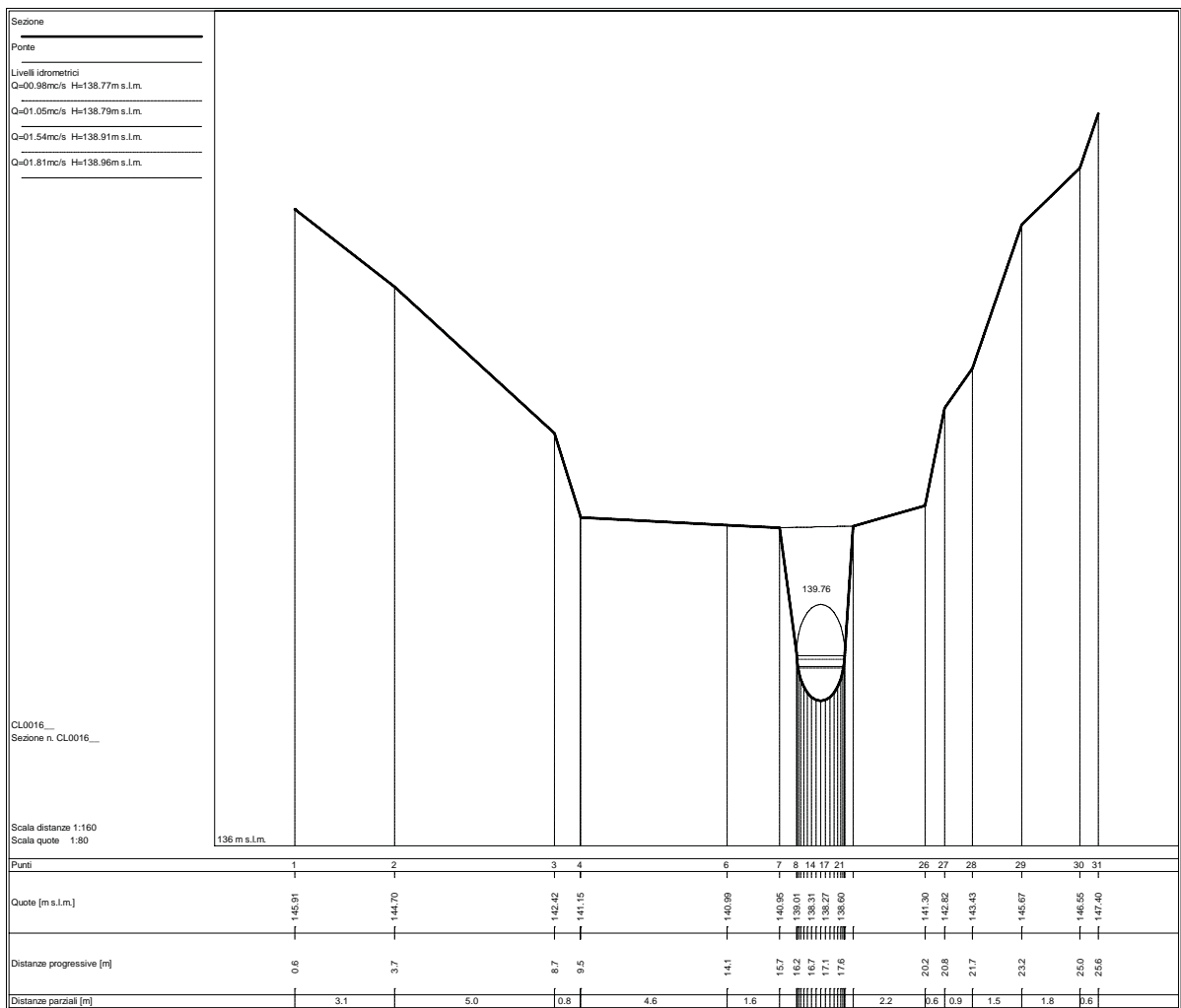
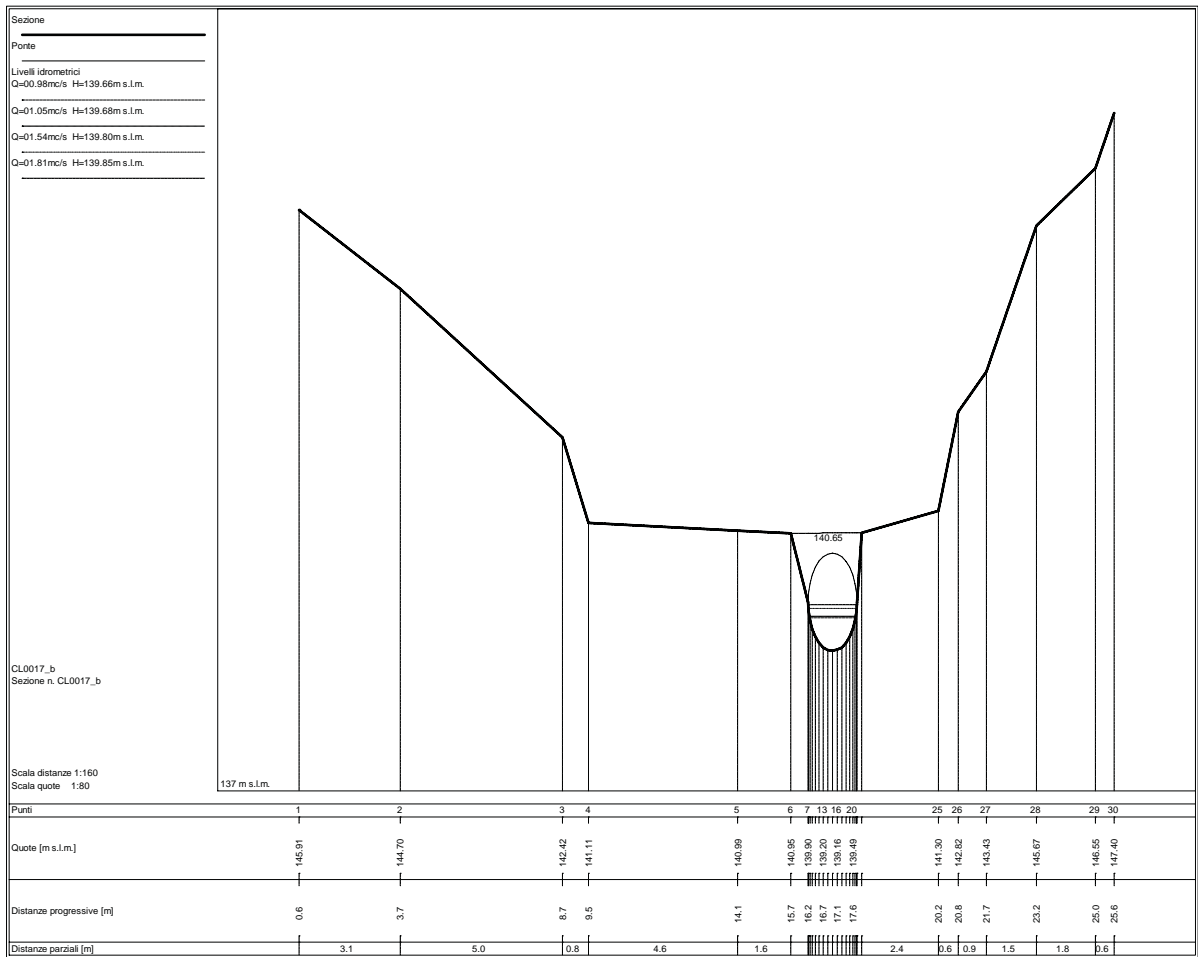

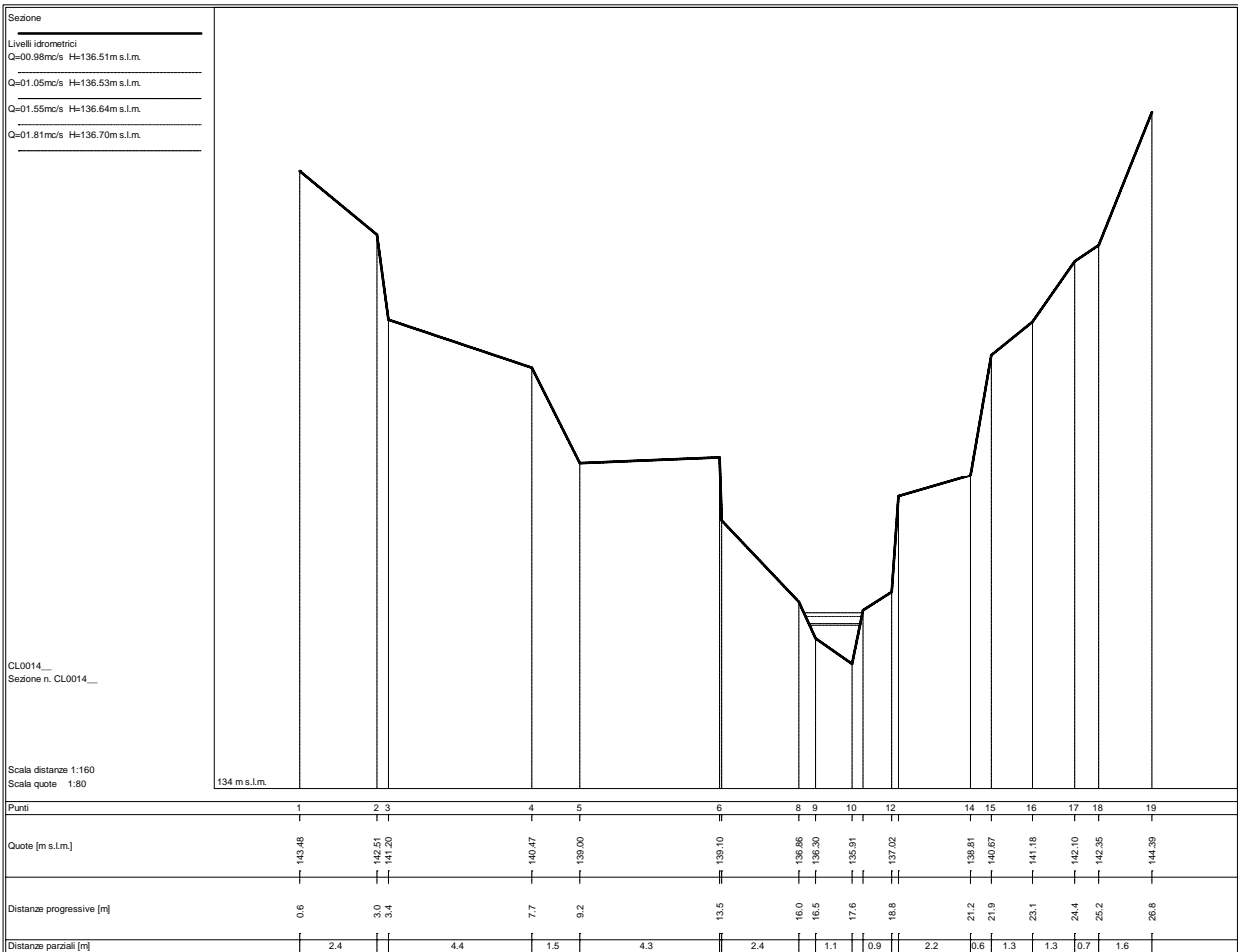
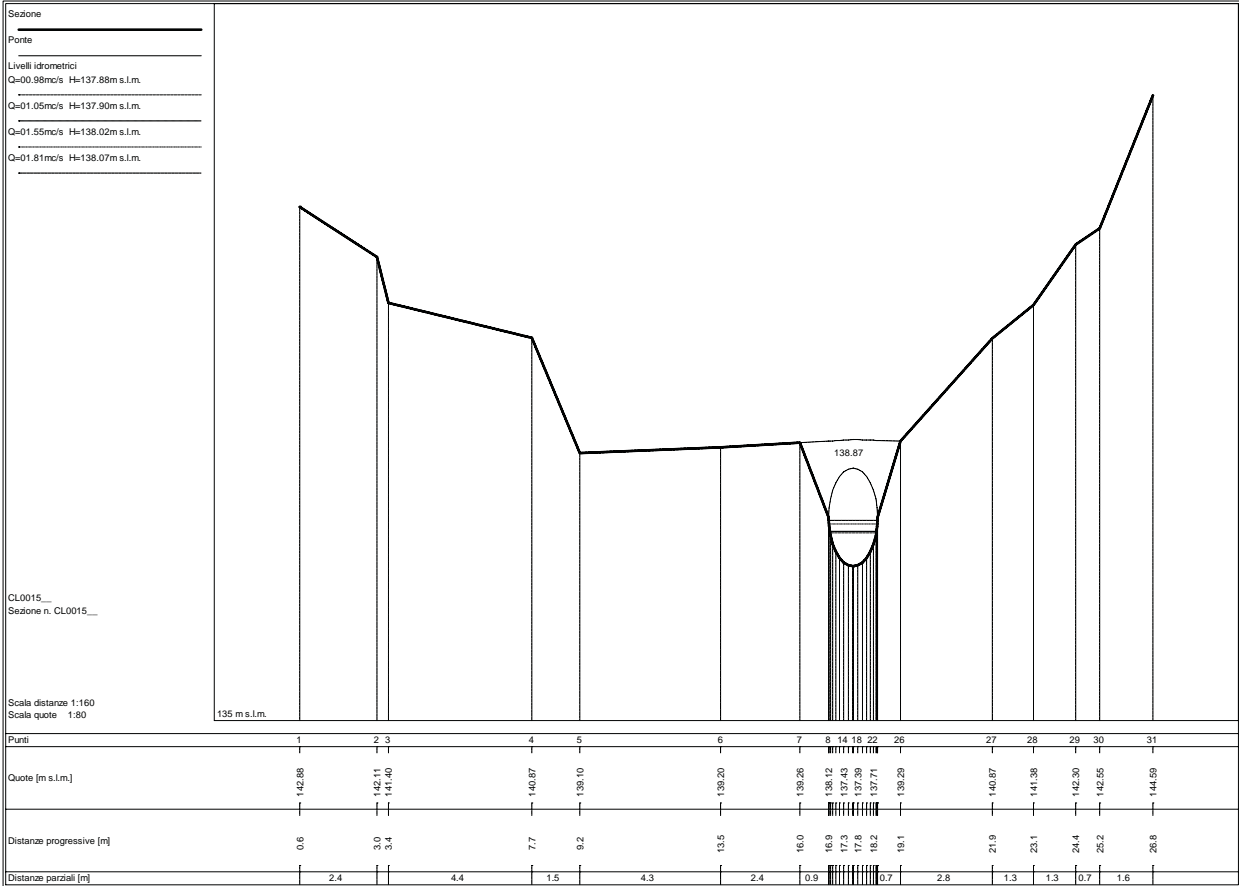

Sezione
 Livelli idrometrici
 Q=00.98mc/s H=134.88m s.l.m.
 Q=01.06mc/s H=134.90m s.l.m.
 Q=01.55mc/s H=134.97m s.l.m.
 Q=01.81mc/s H=135.01m s.l.m.

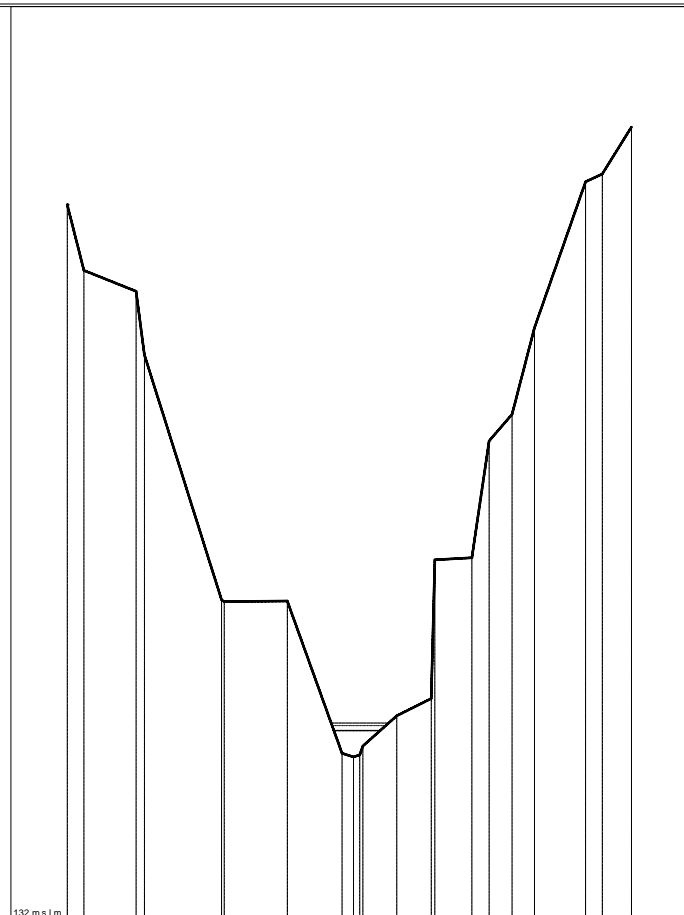

CL0013_
 Sezione n. CL0013_

Scala distanze 1:320
 Scala quote 1:80

Punti	1	2	3	5	7	8	9	12	13	15	16	17	18	19	20	21	
Quote [m s.l.m.]		142.96	141.95	141.63	138.90	138.88	134.54	134.48	135.12	135.38	137.54	139.34	139.75	141.07	143.32	143.43	144.15
Distanze progressive [m]		0.6	1.7	4.8	10.1	14.1	17.5	18.2	20.8	23.0	25.4	26.5	27.9	28.3	32.4	33.4	35.2
Distanze parziali [m]			3.2		4.7		3.9	3.3		2.1	2.1	2.3	1.4	1.4	3.1	1.8	

Sezione
 Livelli idrometrici
 Q=00.98mc/s H=133.22m s.l.m.
 Q=01.06mc/s H=133.23m s.l.m.
 Q=01.55mc/s H=133.30m s.l.m.
 Q=01.81mc/s H=133.33m s.l.m.

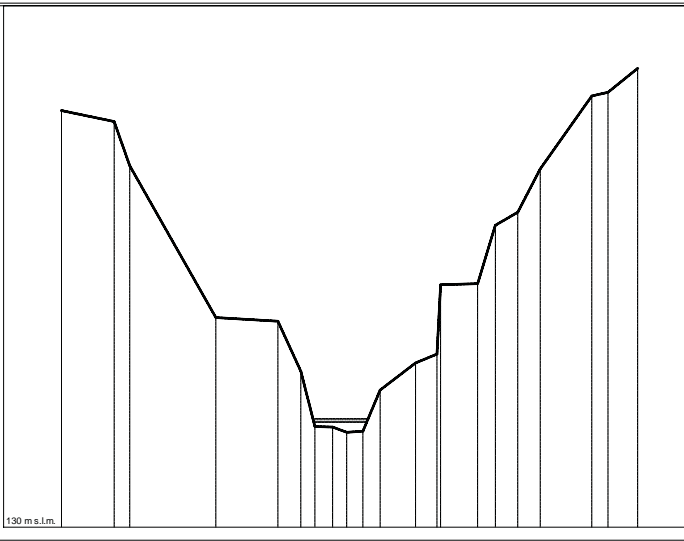

CL0012_
 Sezione n. CL0012_

Scala distanze 1:320
 Scala quote 1:160

Punti	1	2	3	4	5	6	7	8	9	10	11	12	13	14	15	16	17	18	19	20	21
Quote [m s.l.m.]		142.79	142.45	141.08	138.44	136.32	134.78	133.09	133.08	132.90	132.95	134.22	135.03	136.31	137.47	139.26	139.67	141.00	143.24	143.35	144.07
Distanze progressive [m]		0.6	3.9	4.8	10.1	13.9	15.3	16.2	17.3	18.1	19.2	20.2	22.4	23.7	26.2	27.3	28.7	30.0	33.2	34.2	35.0
Distanze parziali [m]			3.3		5.3		3.8	1.4		1.4		2.2	1.3	2.3	2.3	1.4	1.4	3.1	1.8		

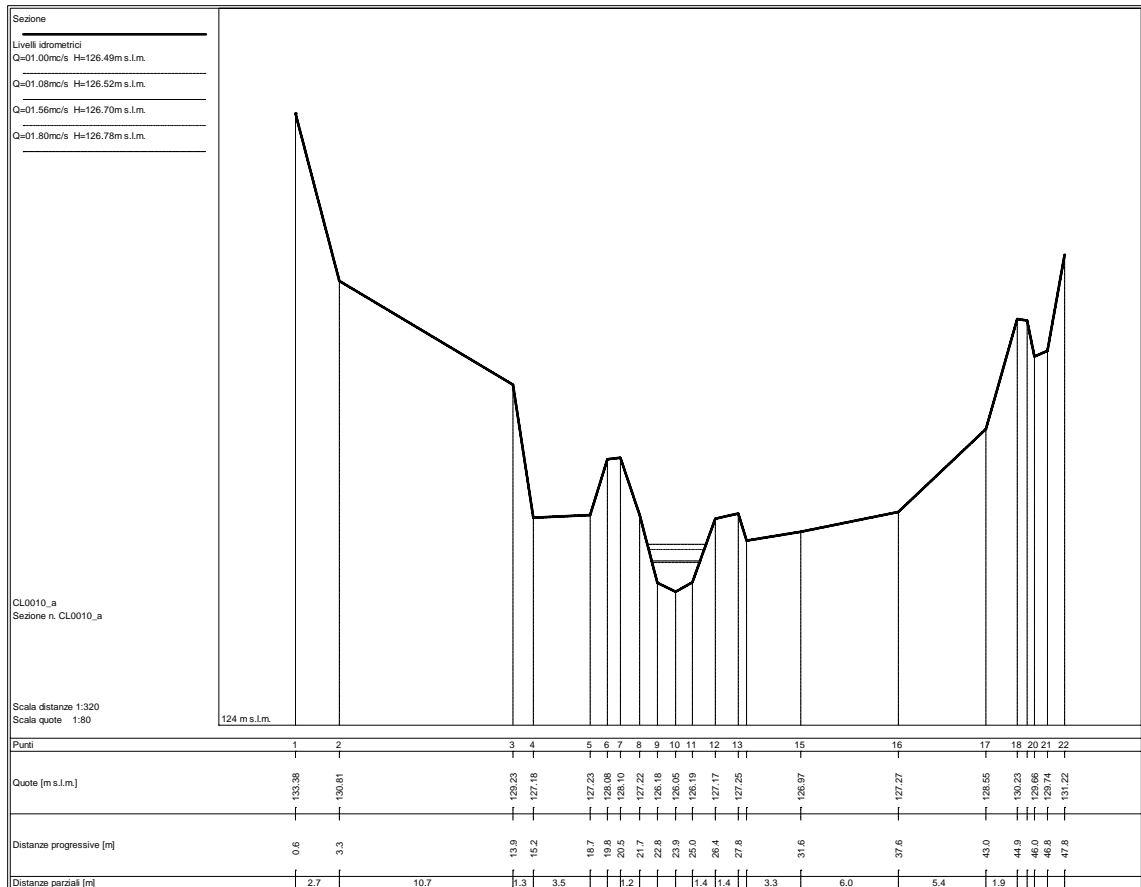
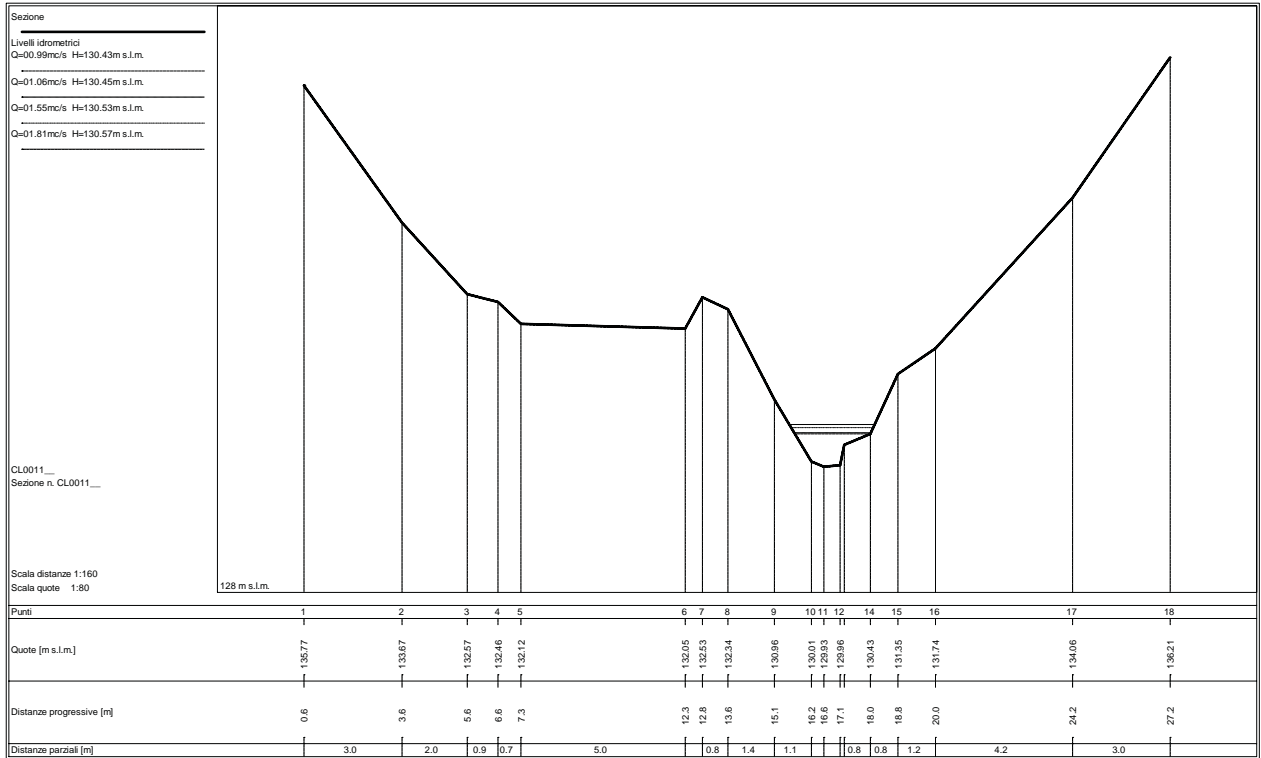

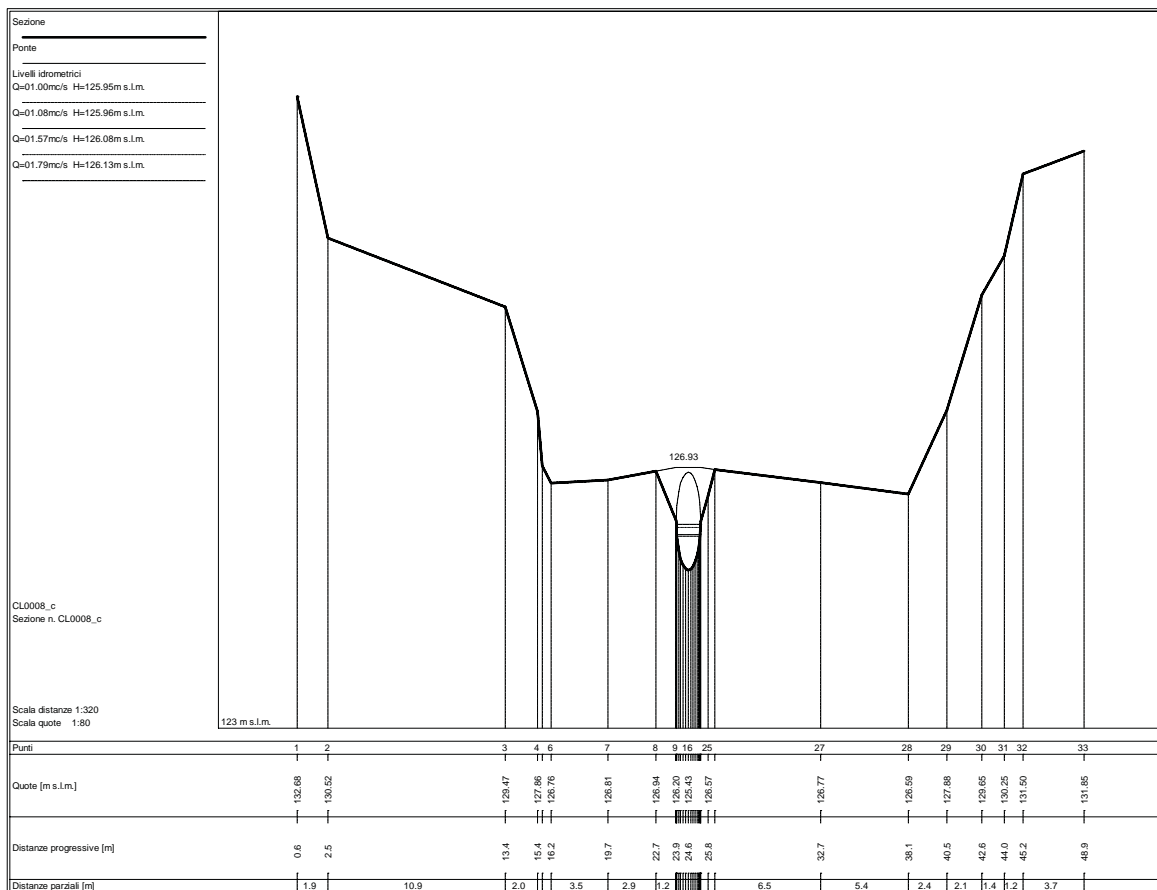
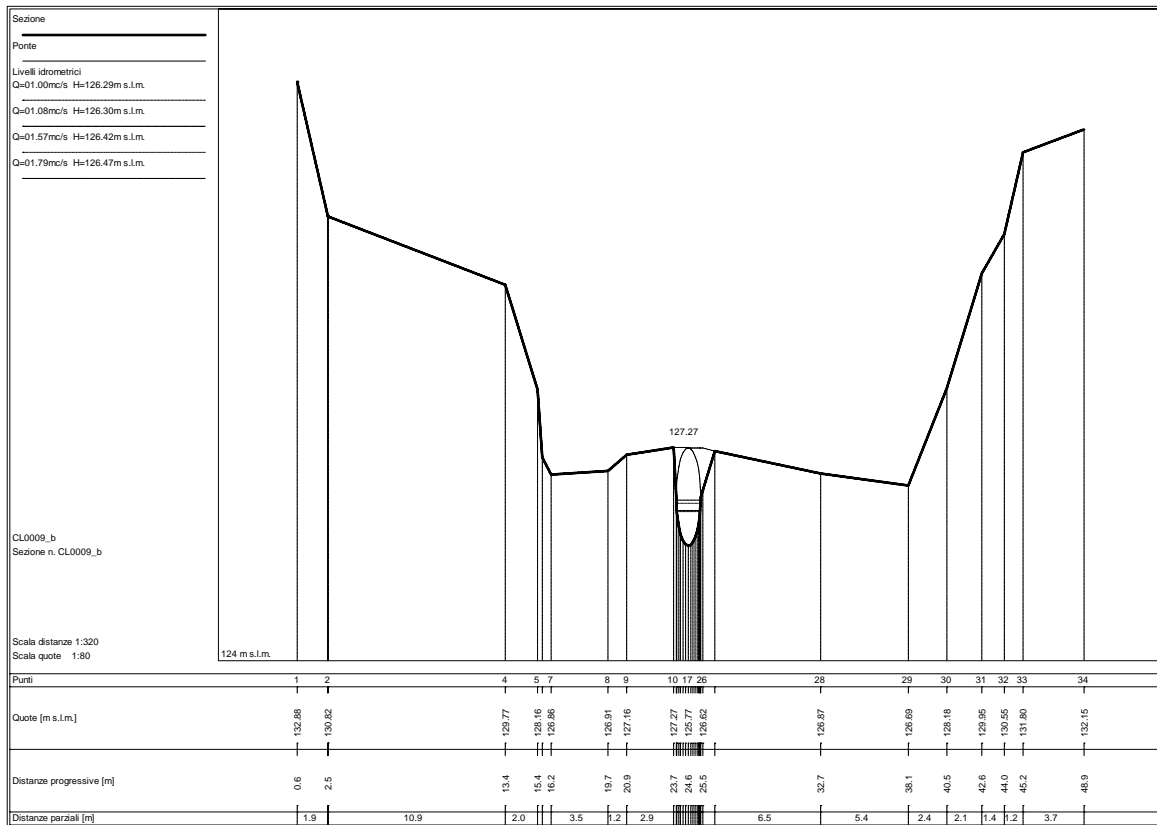

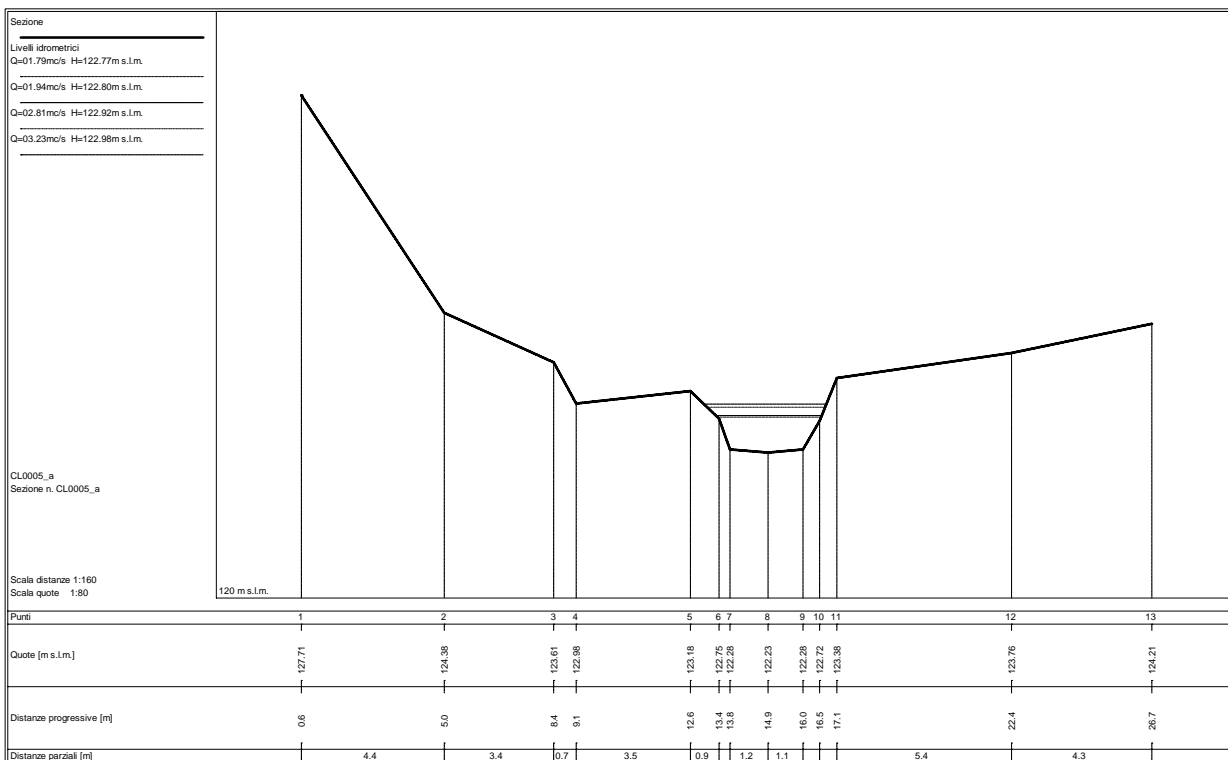
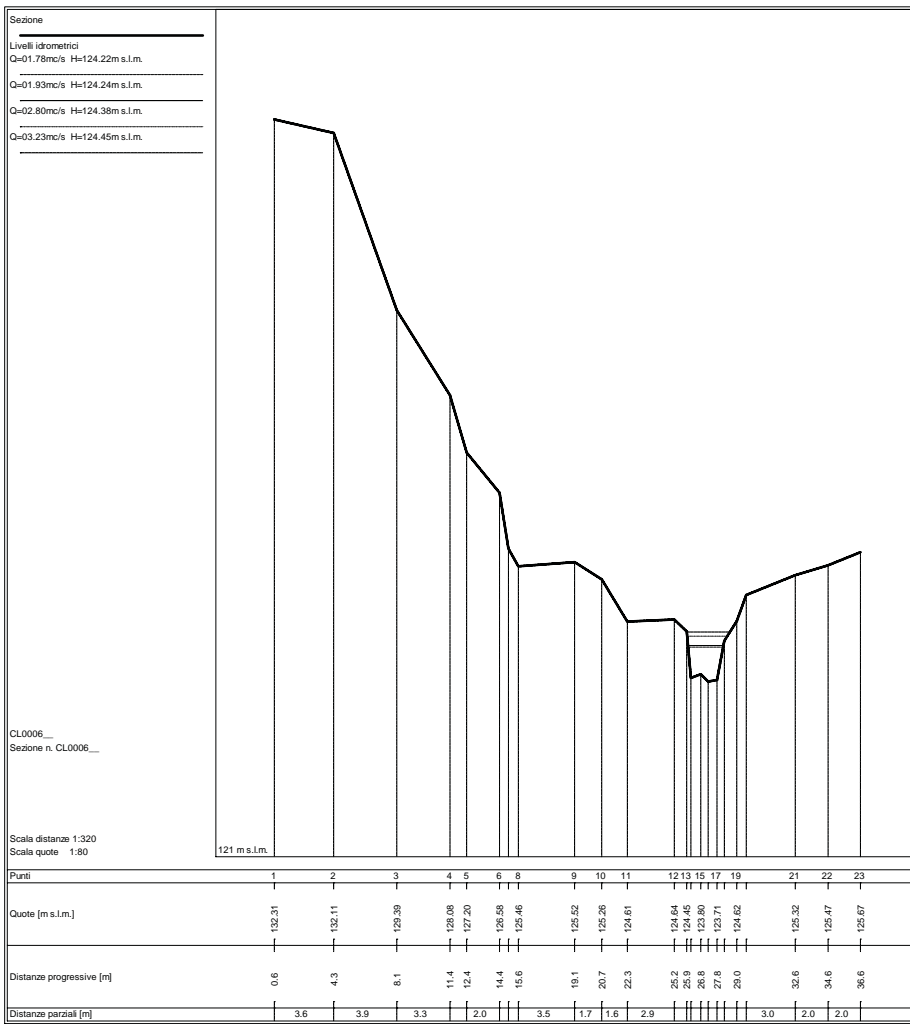

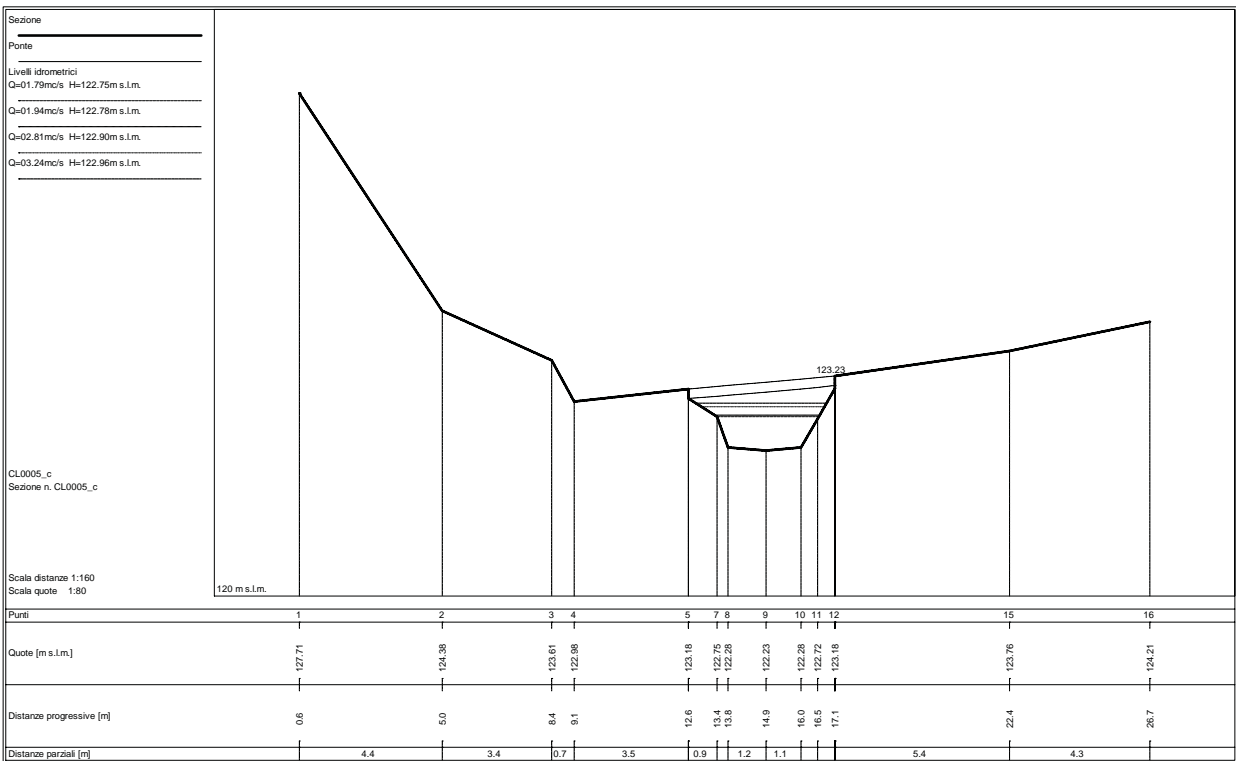
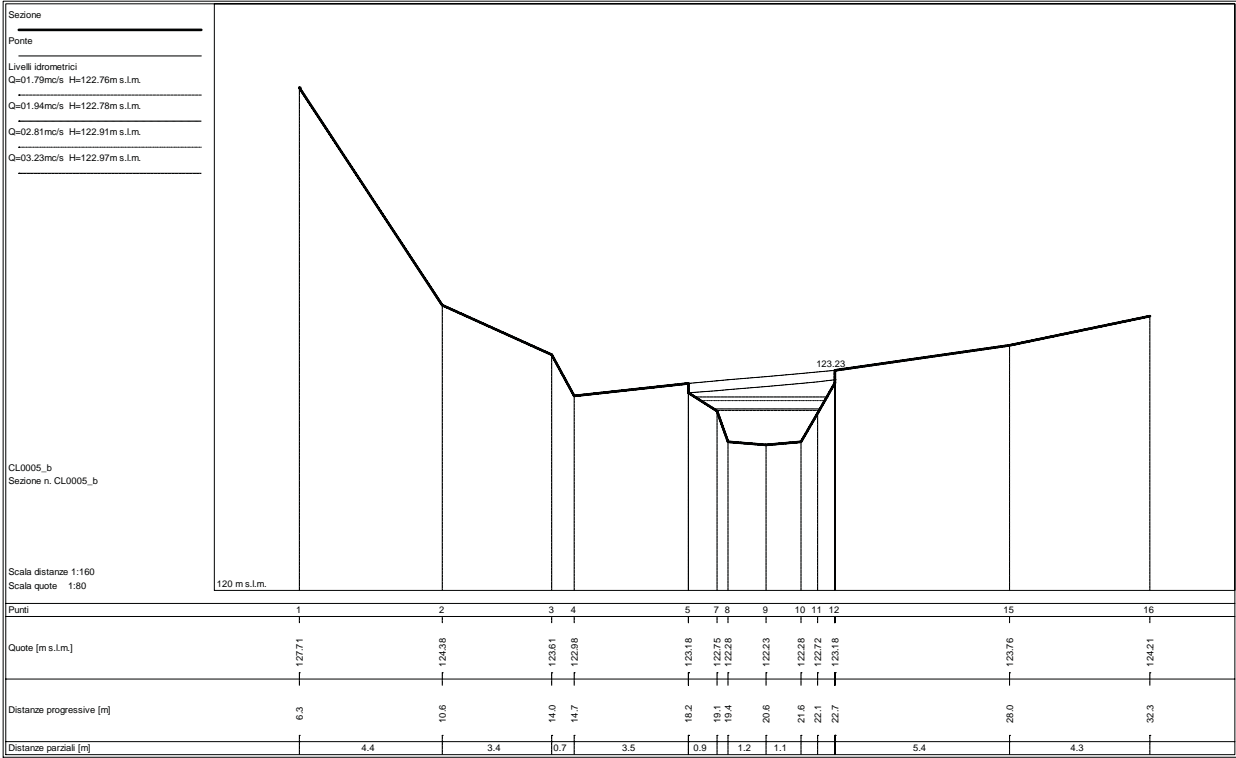

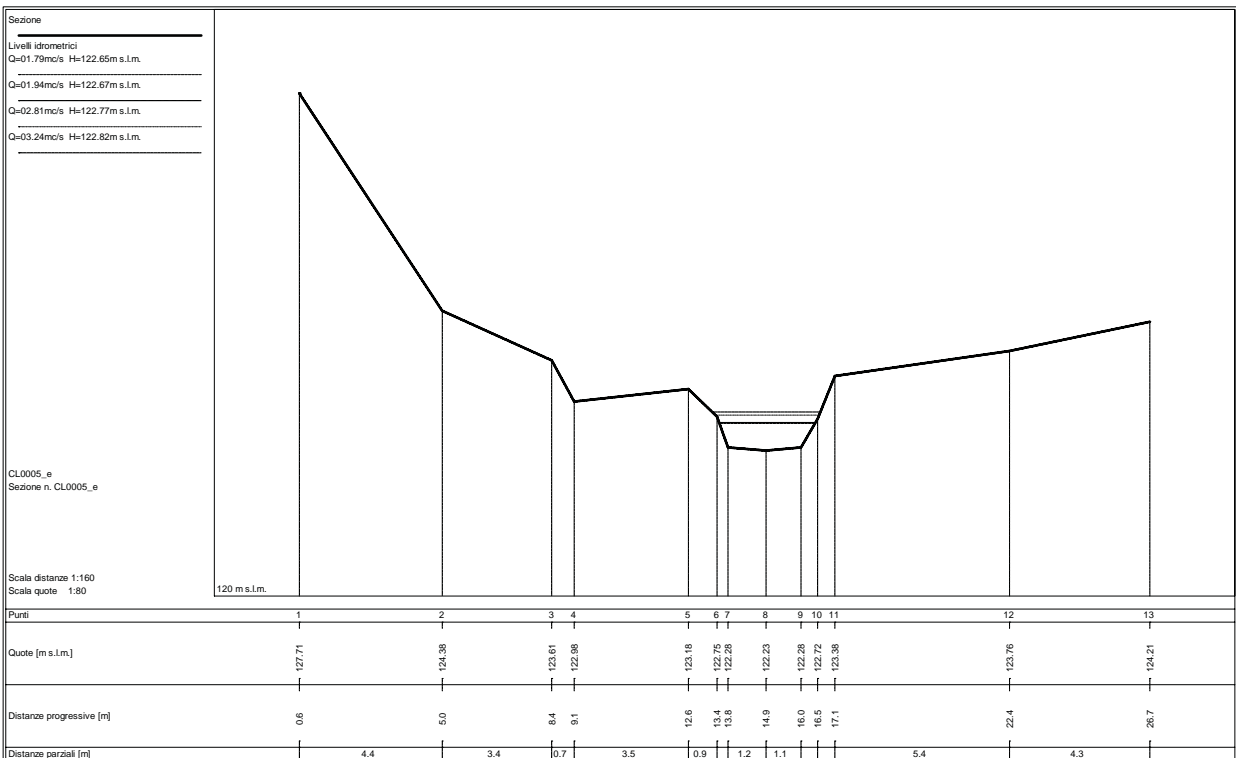
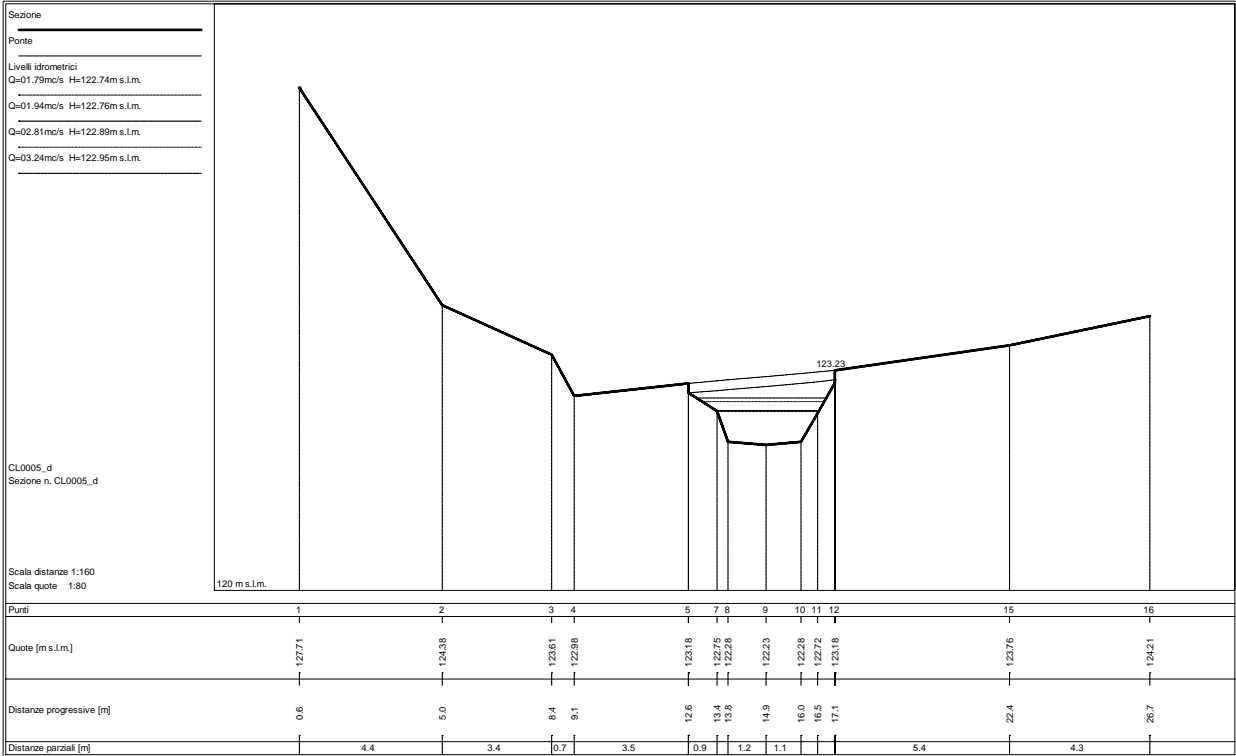

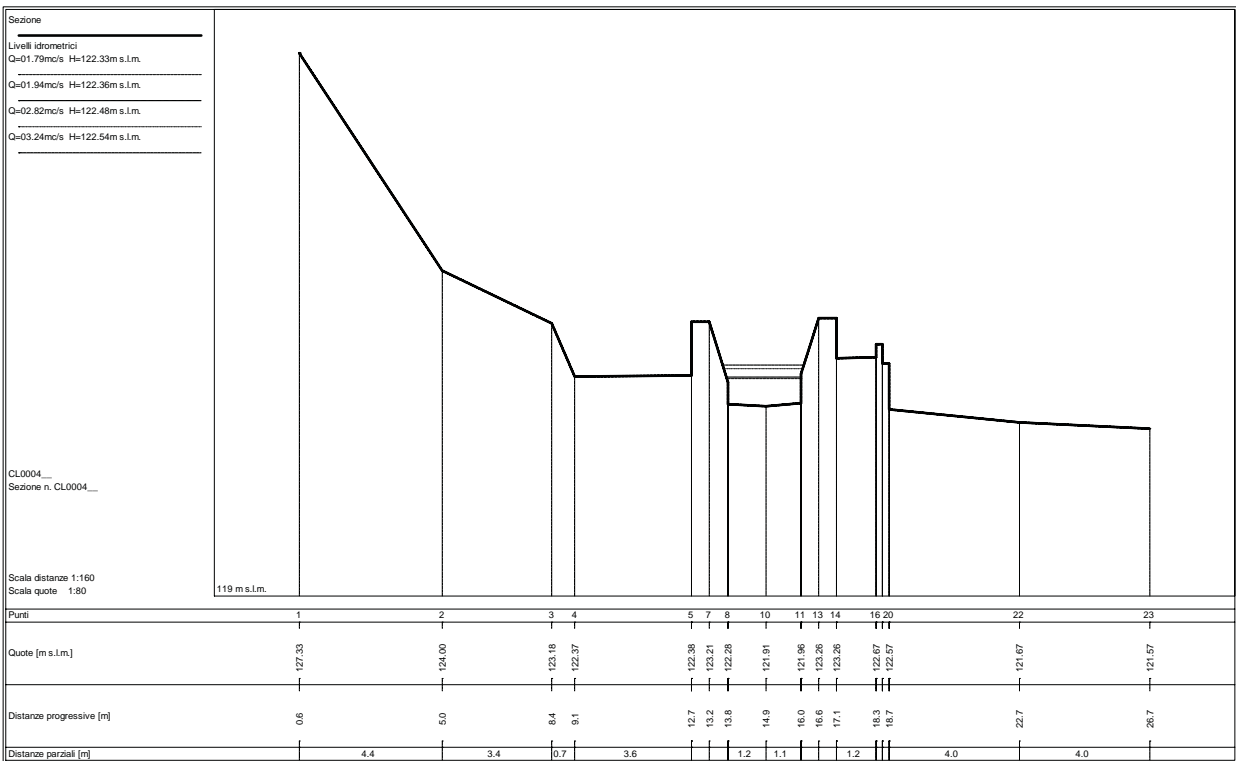
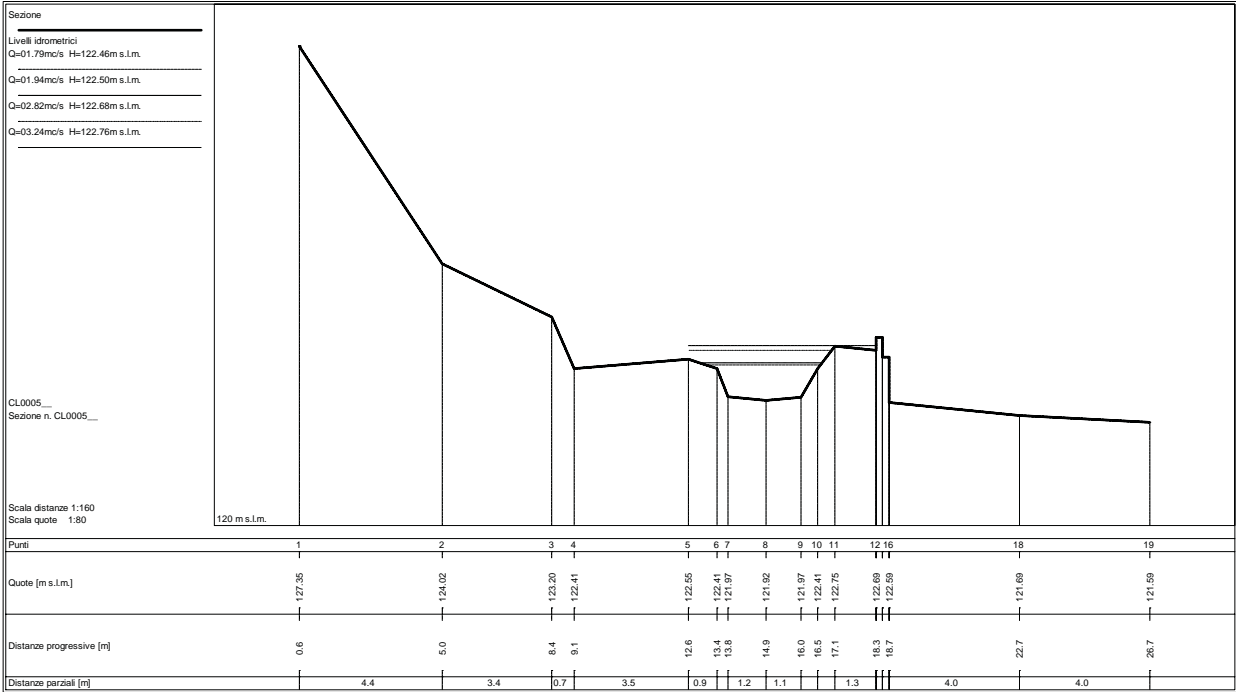

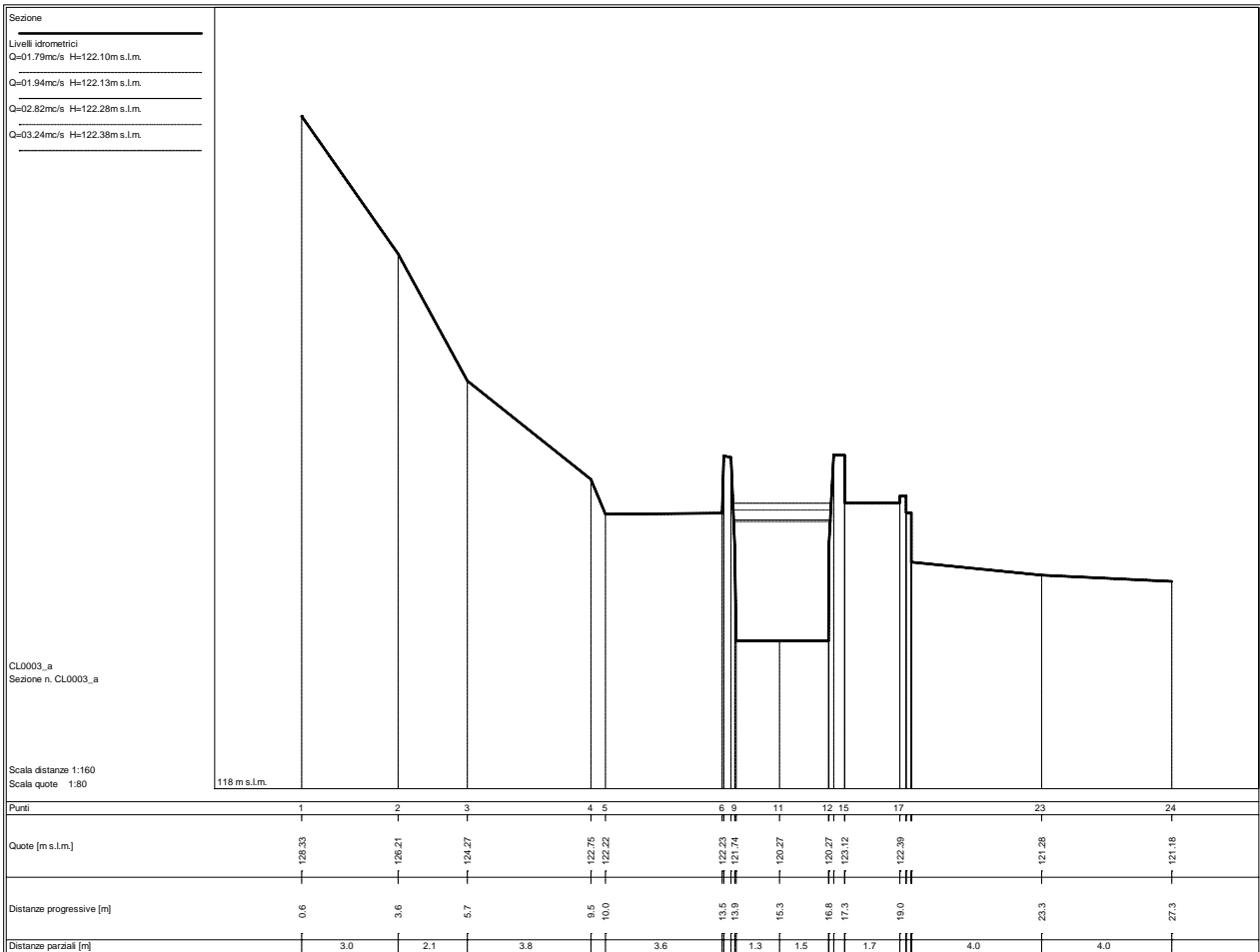
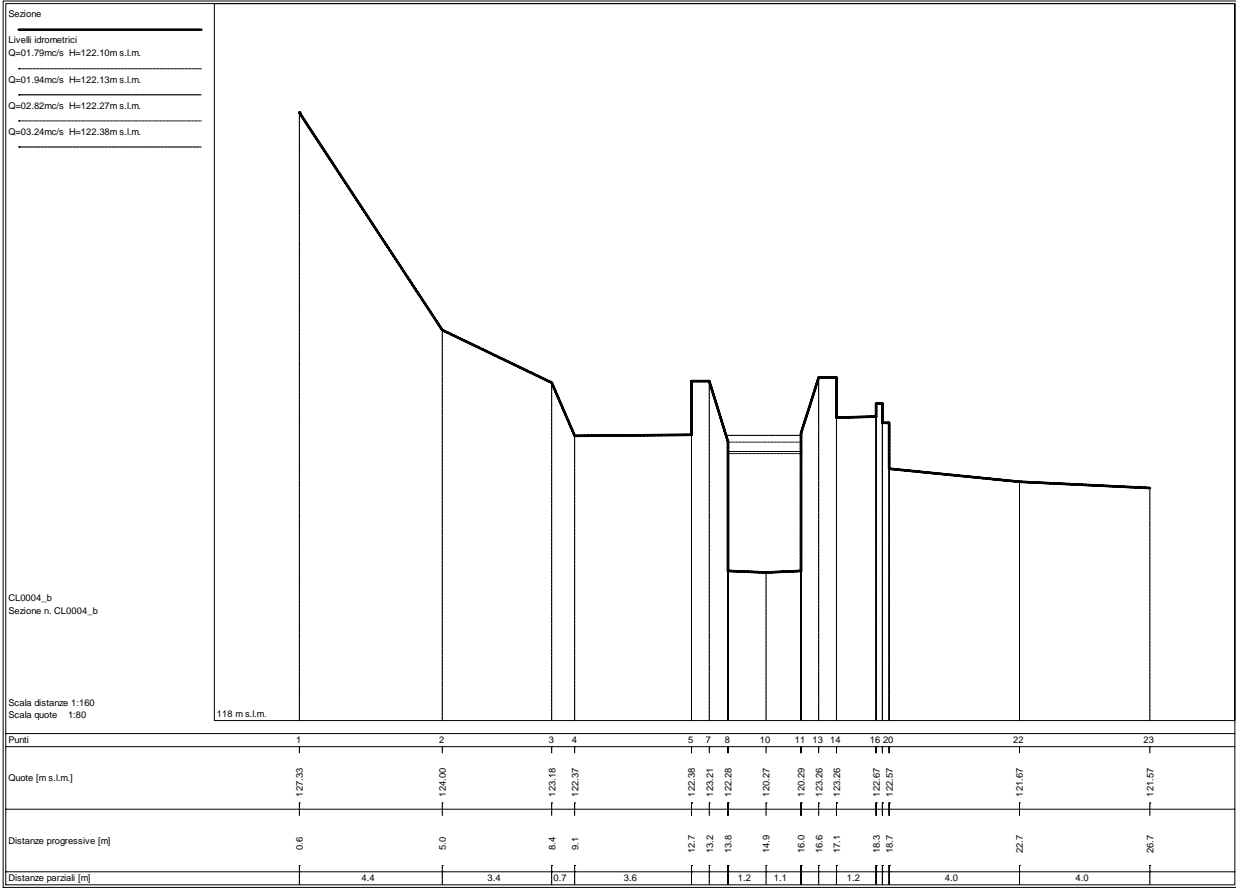

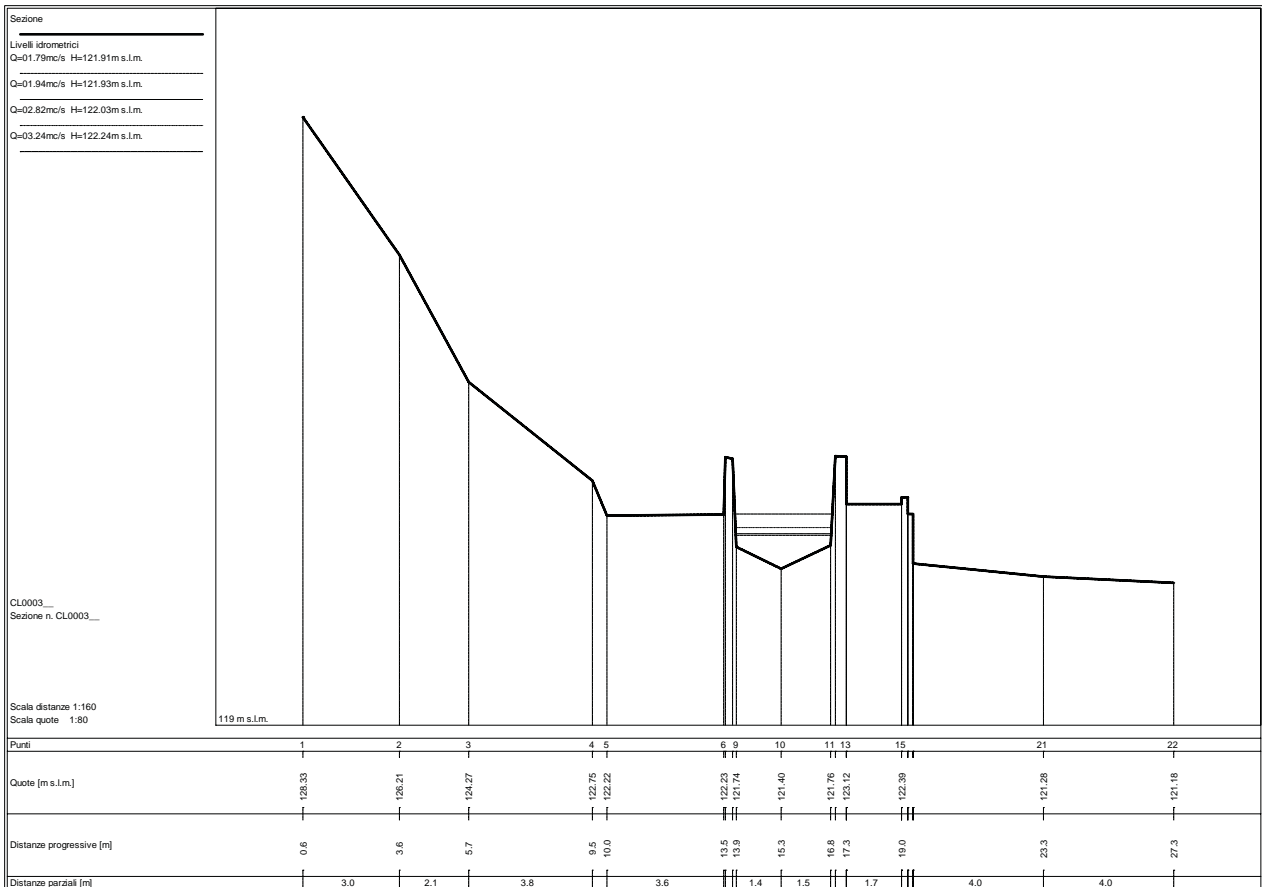
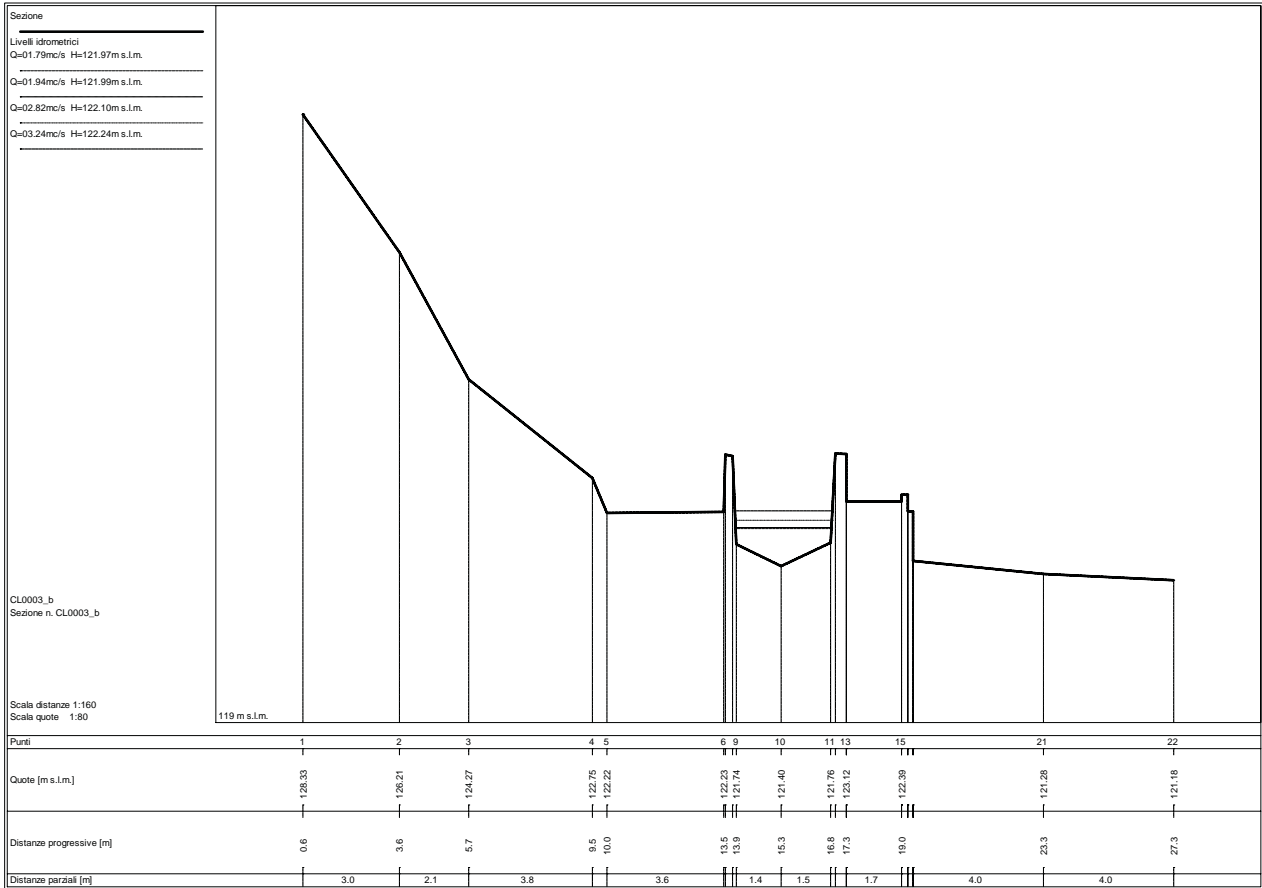

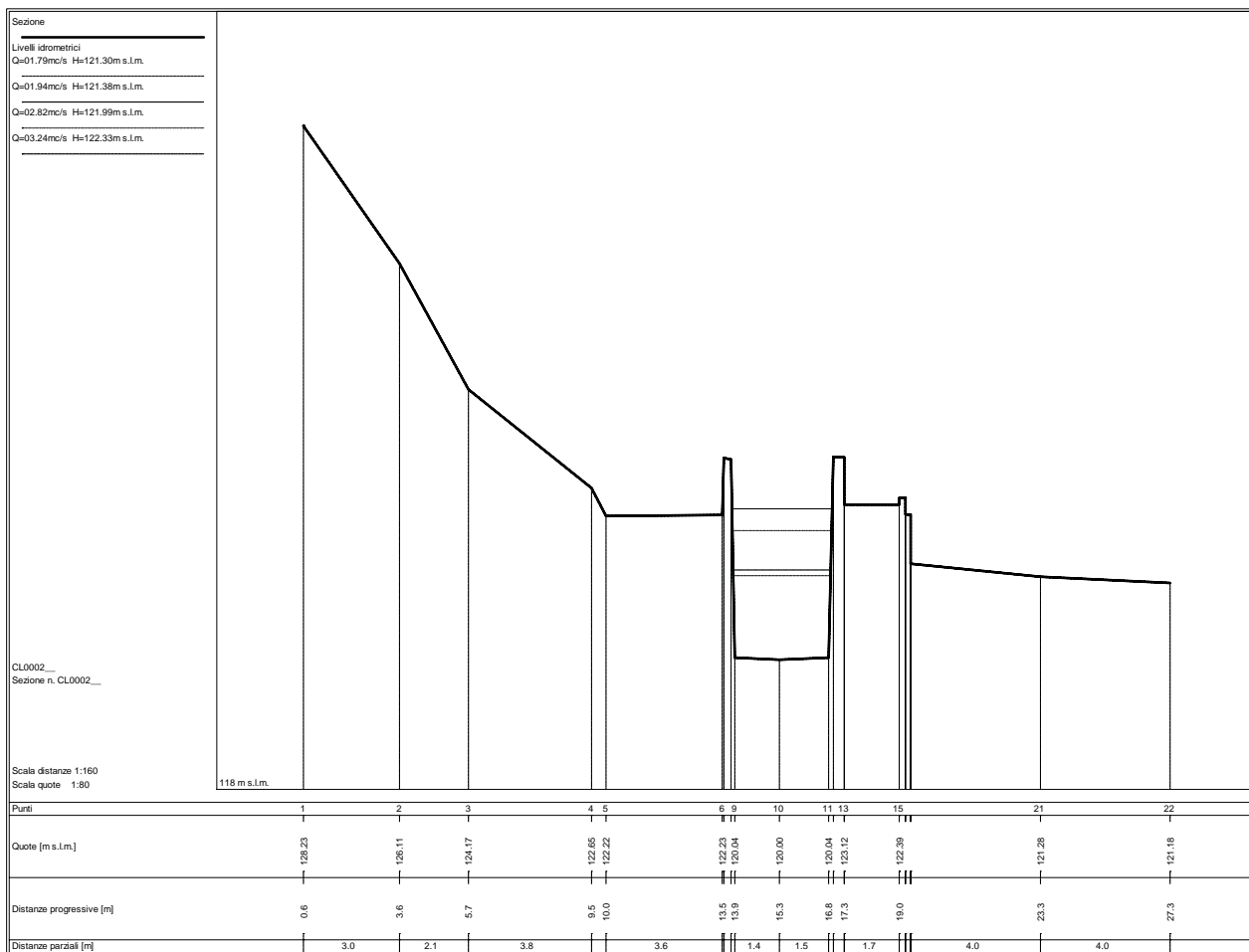
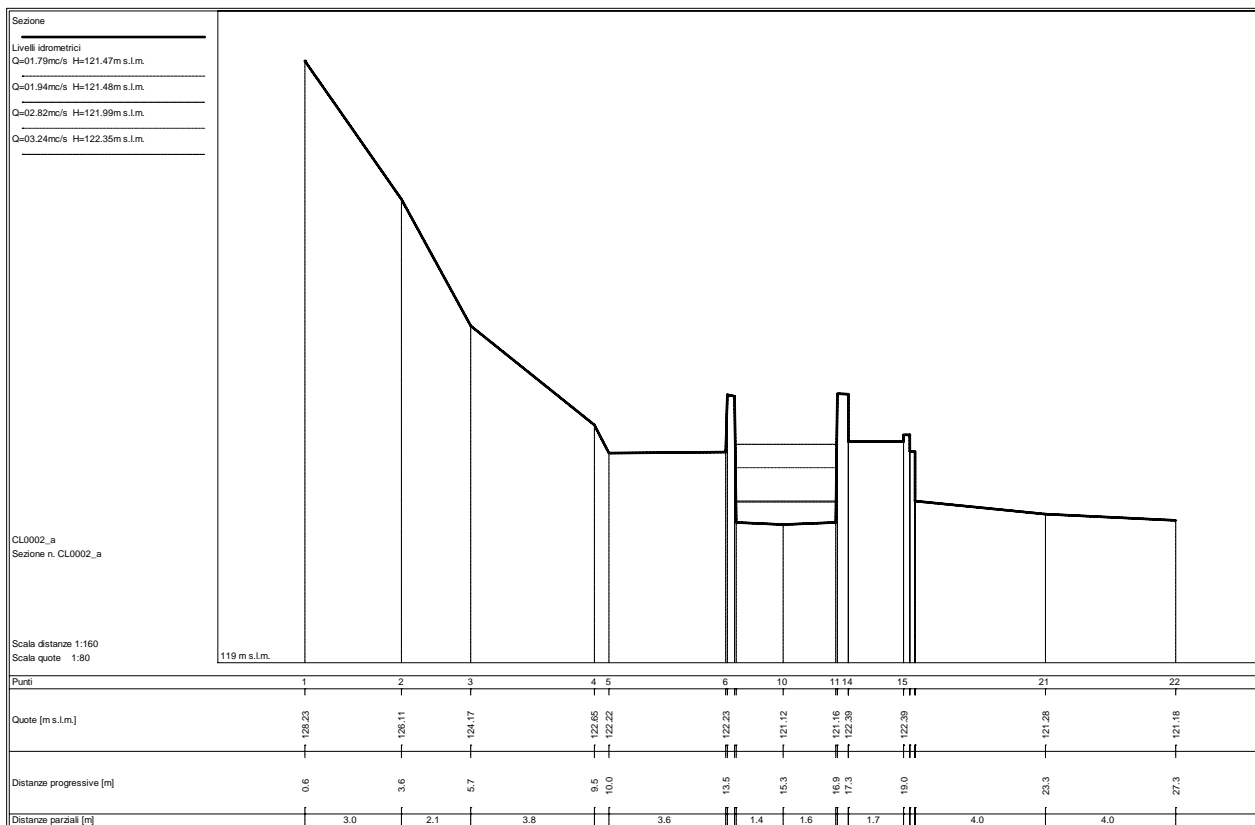

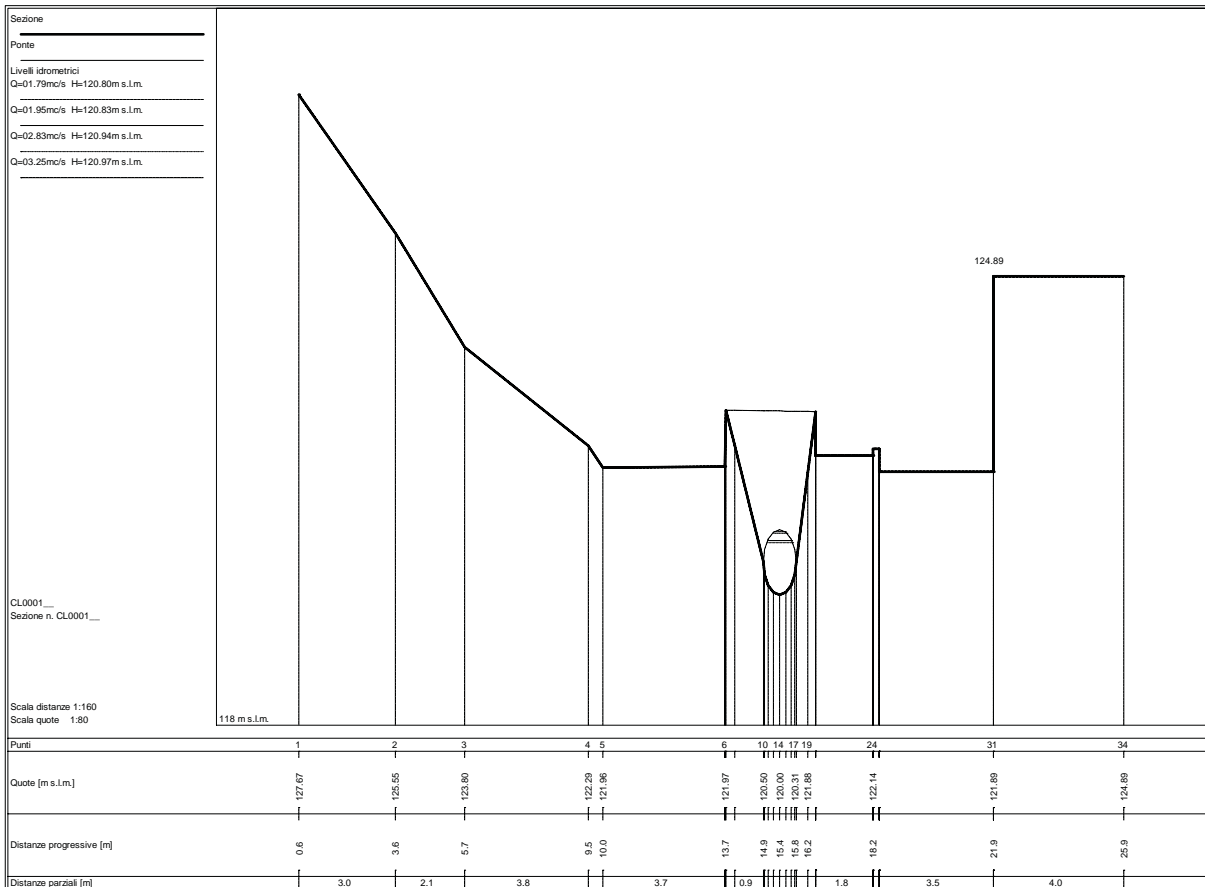
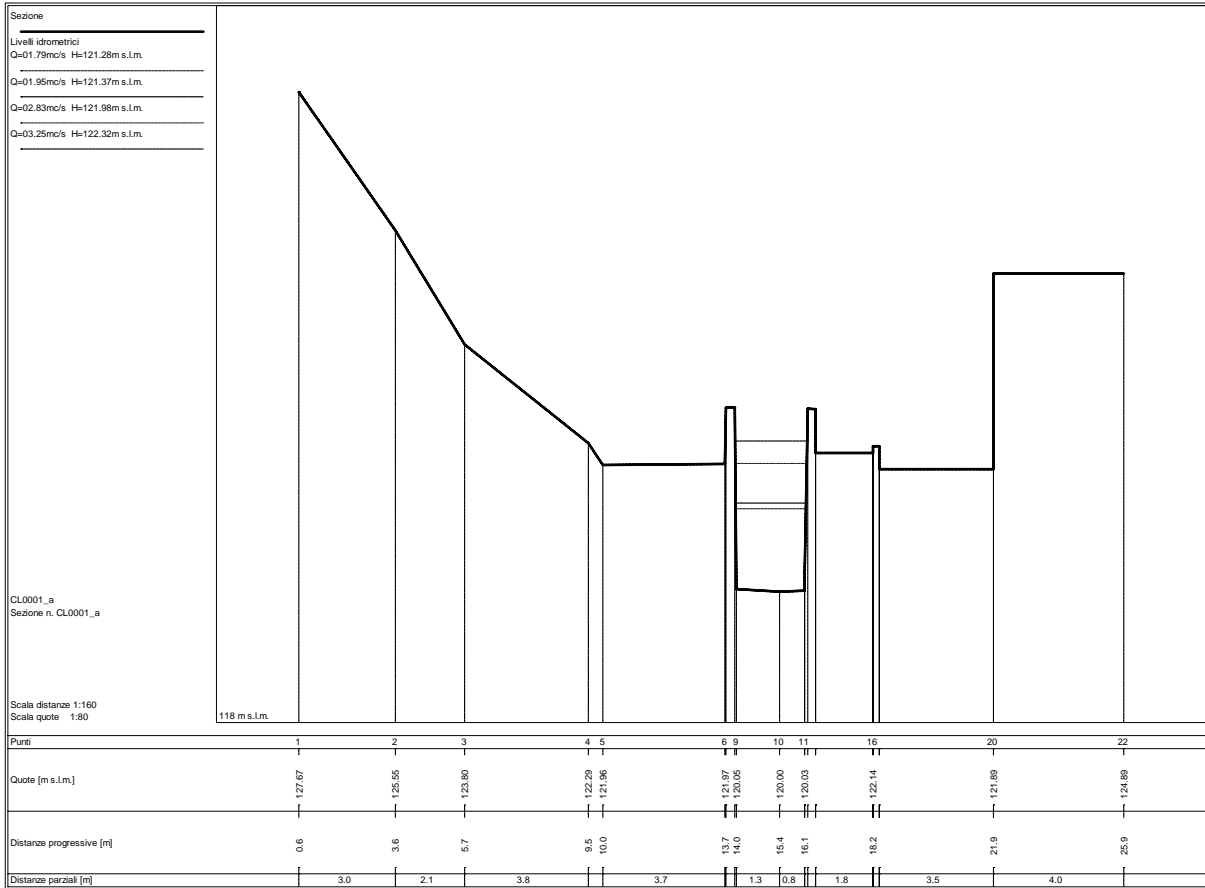

Sezione
 Ponte
 Livelli idrometrici
 Q=01.80mc/s H=119.86m s.Lm.
 Q=01.95mc/s H=119.89m s.Lm.
 Q=02.83mc/s H=120.00m s.Lm.
 Q=03.25mc/s H=120.02m s.Lm.

CL0001_b
 Sezione n. CL0001_b

Scala distanze 1:10
 Scala quote 1:40

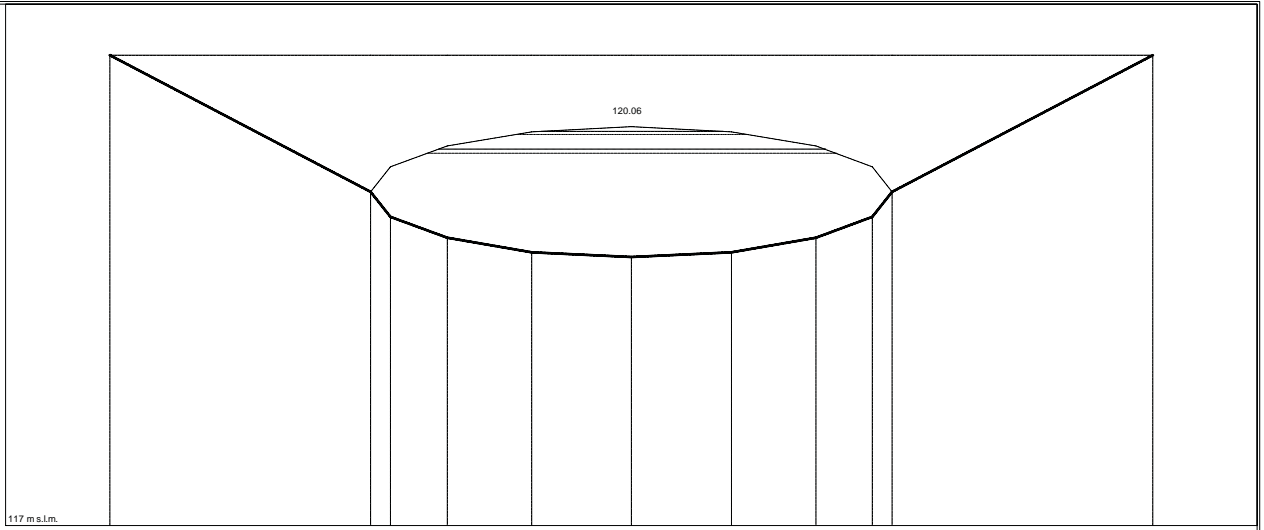

Punti	1	2	3	4	5	6	7	8	9	10	11
Quote [m s.l.m.]	120.61	118.56	118.37	118.21	118.10	118.06	118.10	118.21	118.37	118.56	120.61
Distanze progressive [m]	0.4	0.9	0.9	1.0	1.2	1.4	1.6	1.7	1.9	1.9	2.4
Distanze parziali [m]		0.5	0.0	0.1	0.2	0.2	0.2	0.2	0.1	0.0	0.5

Sezione
 Ponte
 Livelli idrometrici
 Q=01.80mc/s H=118.45m s.Lm.
 Q=01.95mc/s H=118.48m s.Lm.
 Q=02.83mc/s H=118.59m s.Lm.
 Q=03.25mc/s H=118.61m s.Lm.

CL0001ba
 Sezione n. CL0001ba

Scala distanze 1:10
 Scala quote 1:40

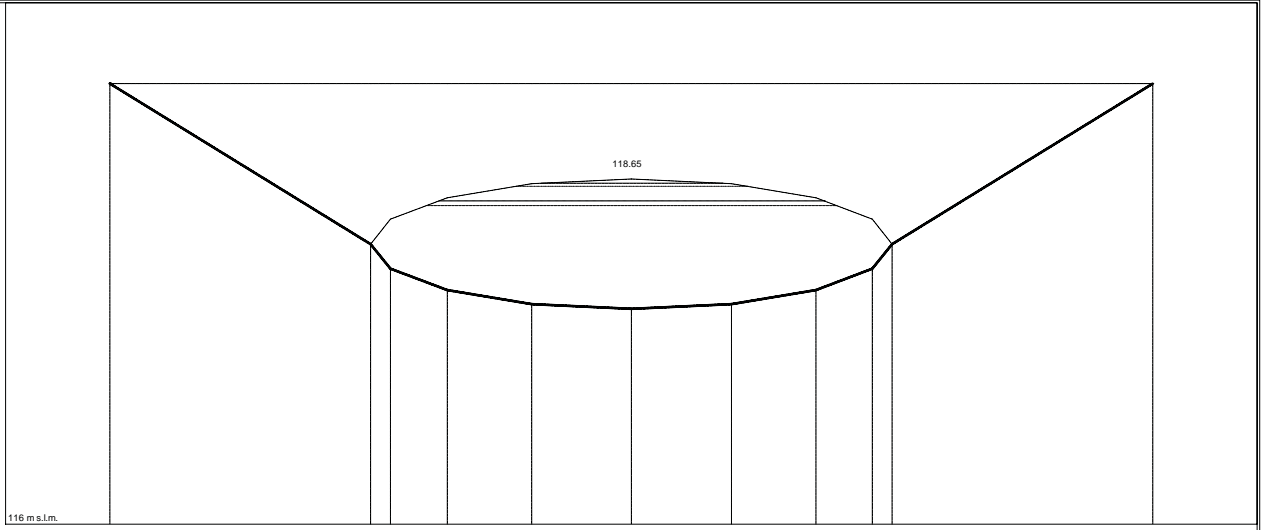

Punti	1	2	3	4	5	6	7	8	9	10	11
Quote [m s.l.m.]	118.38	118.15	117.96	117.80	117.69	117.65	117.69	117.80	117.96	118.15	118.38
Distanze progressive [m]	0.4	0.9	0.9	1.0	1.2	1.4	1.6	1.7	1.9	1.9	2.4
Distanze parziali [m]		0.5	0.0	0.1	0.2	0.2	0.2	0.2	0.1	0.0	0.5

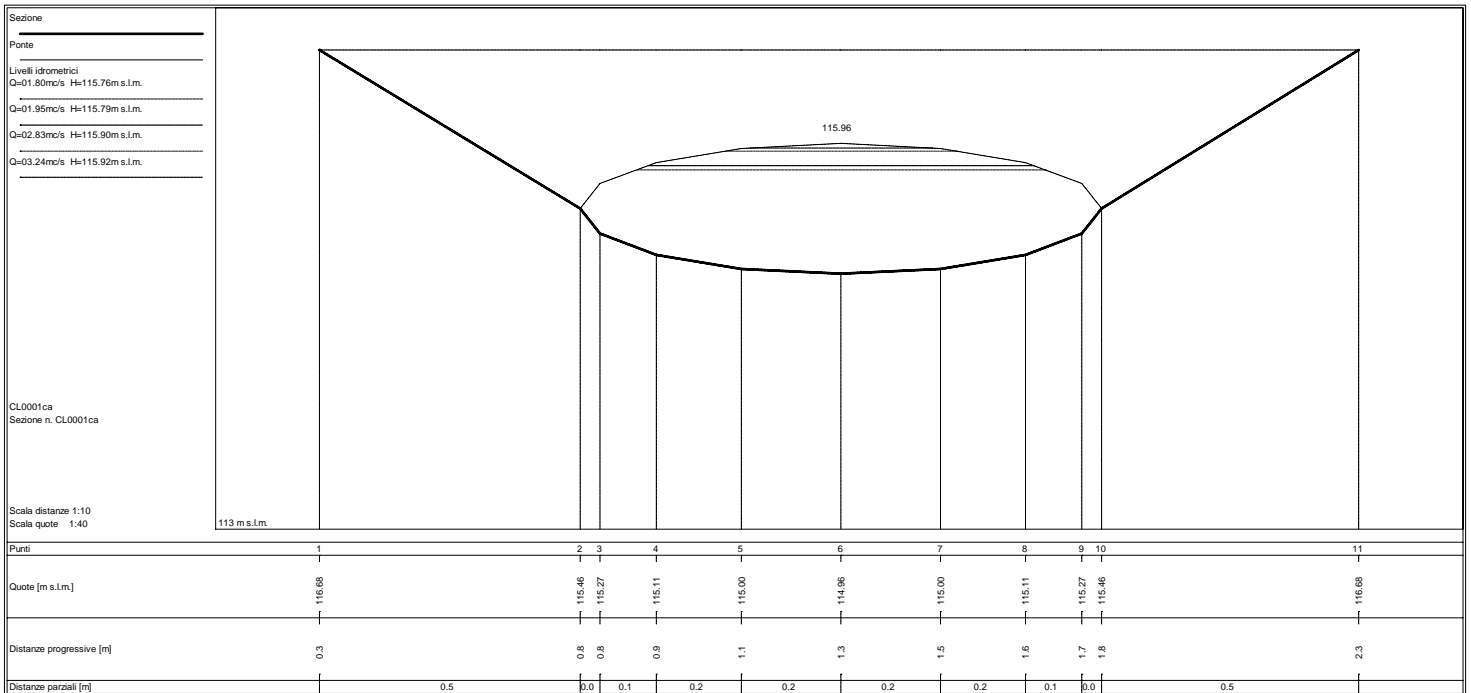
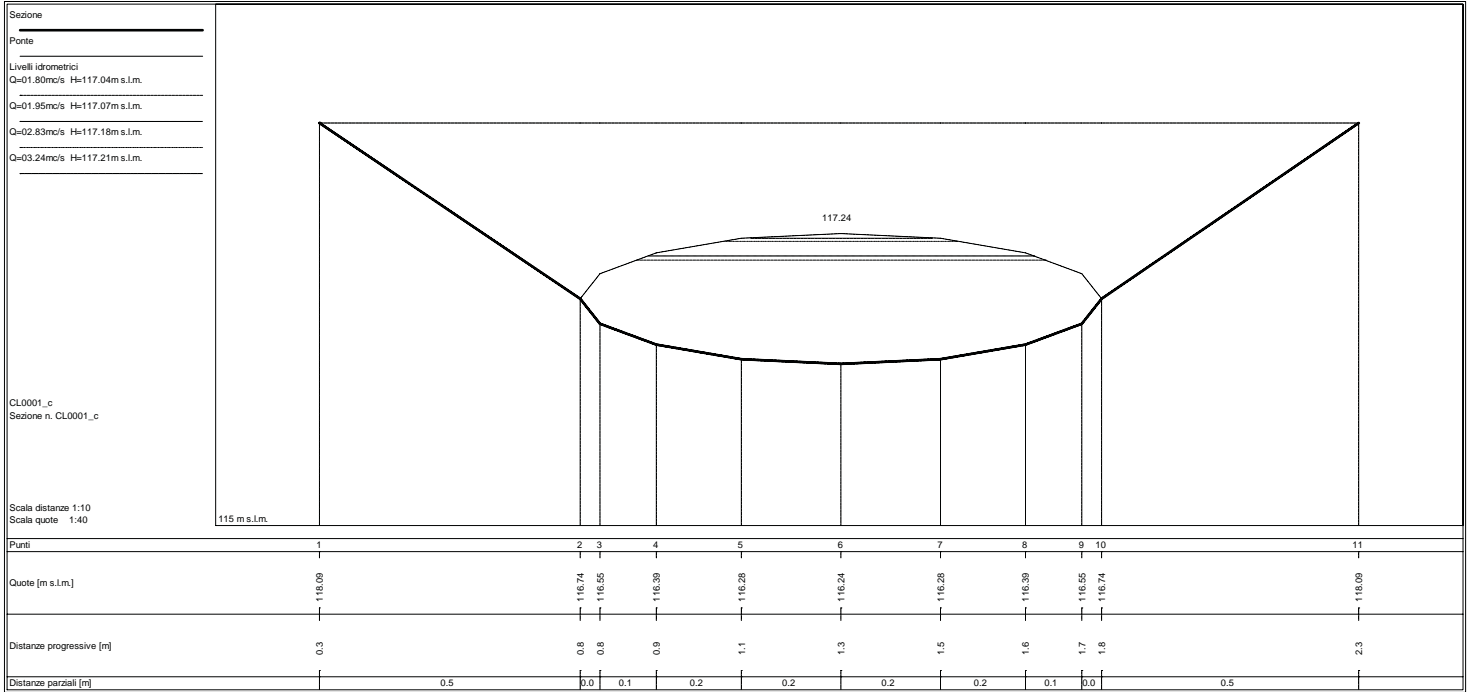

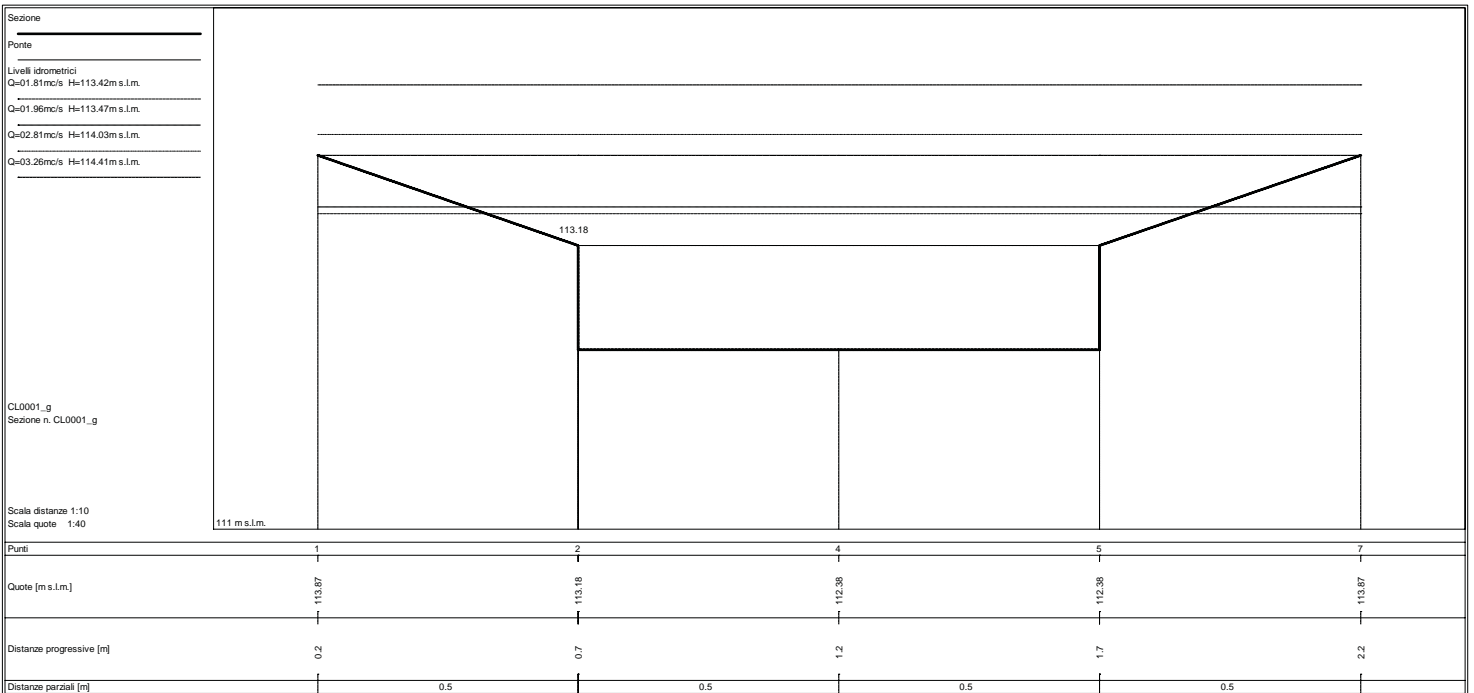
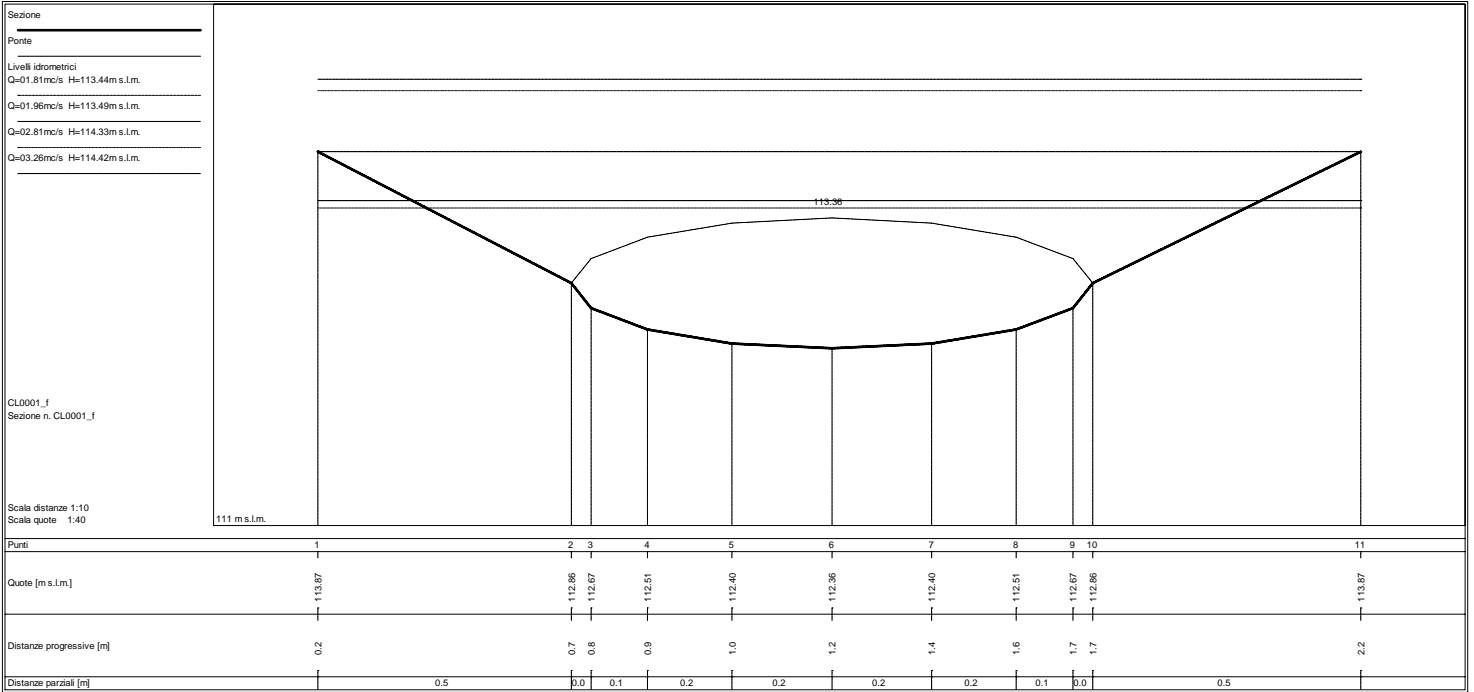

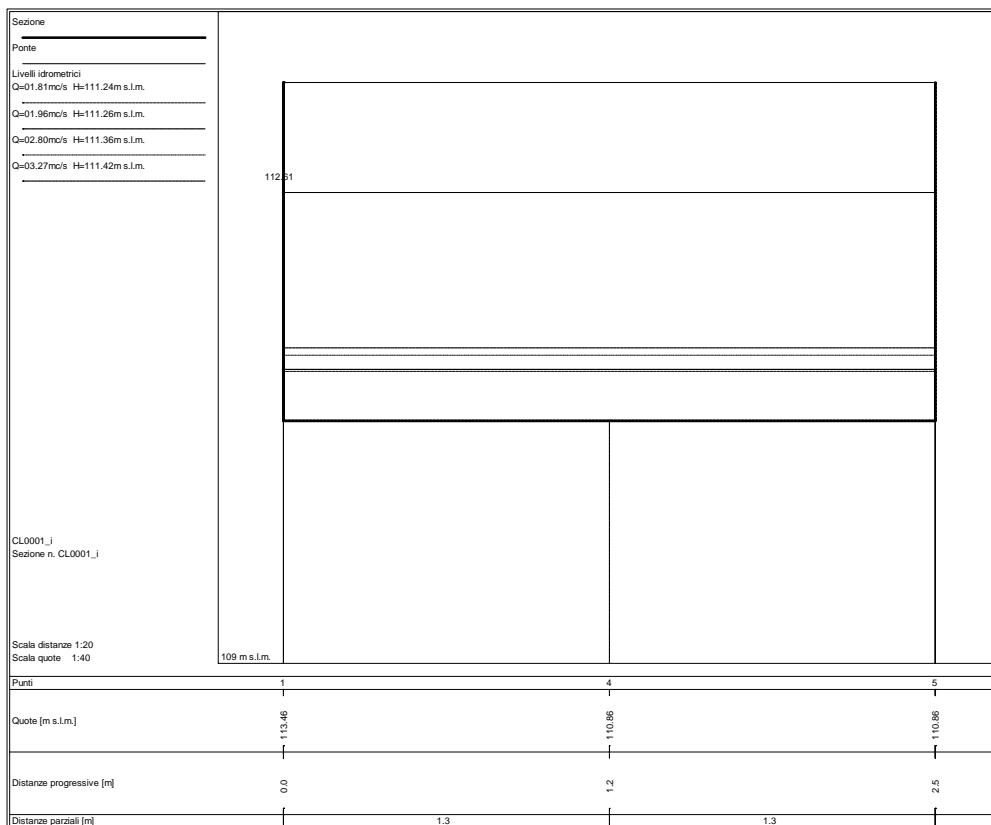
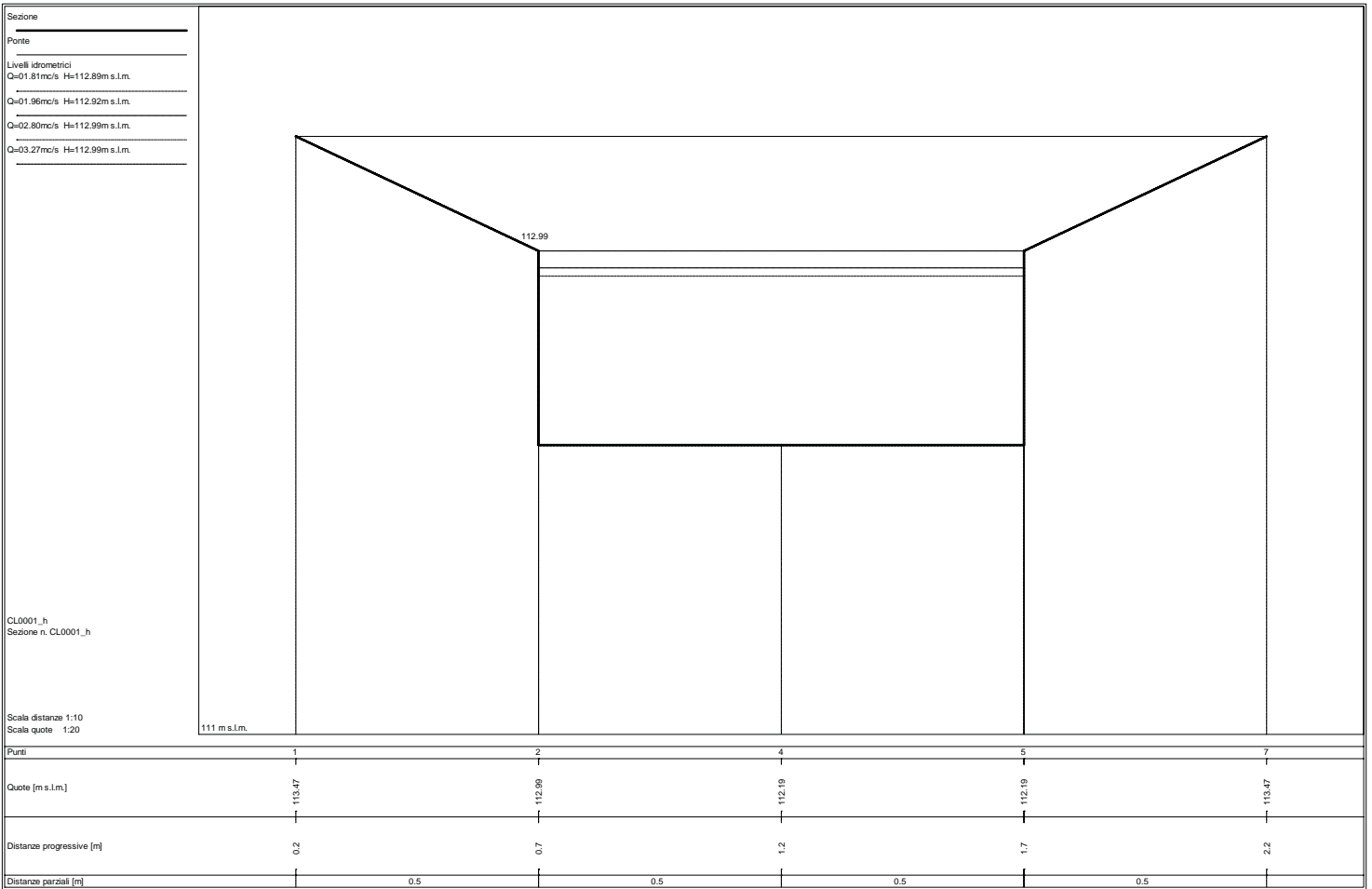

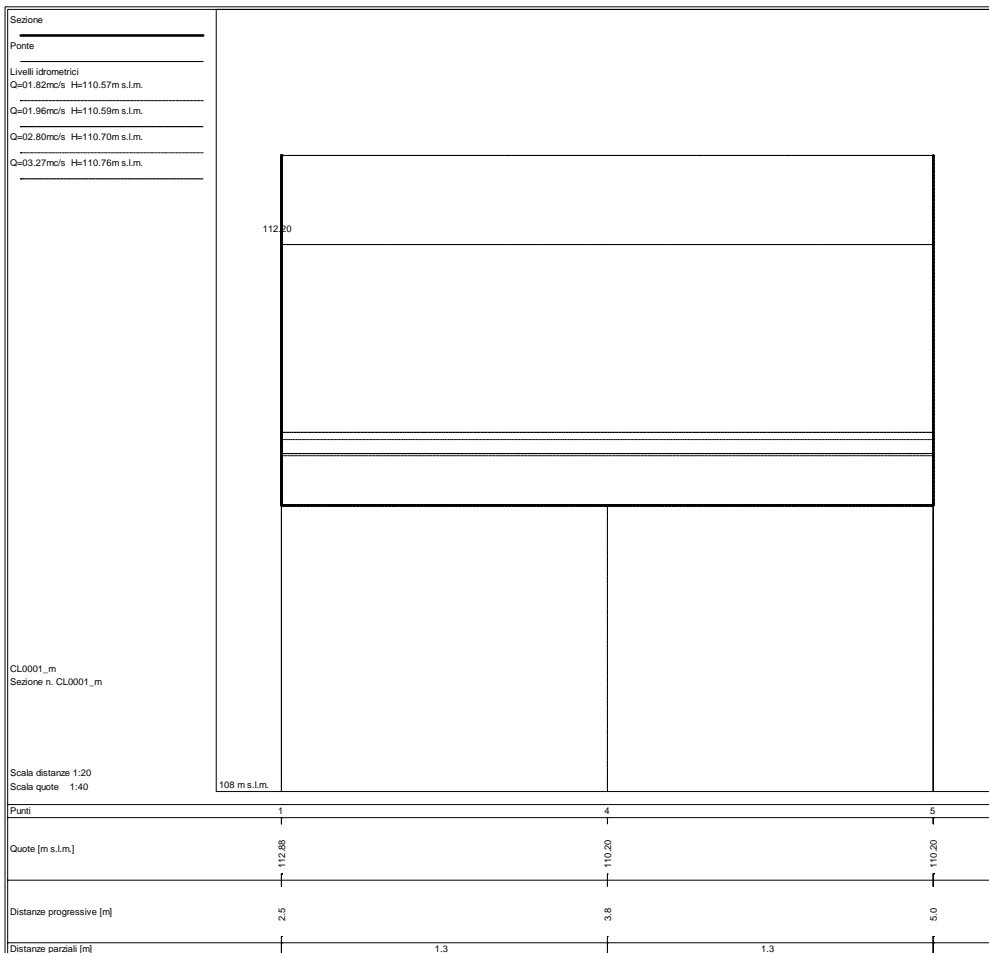
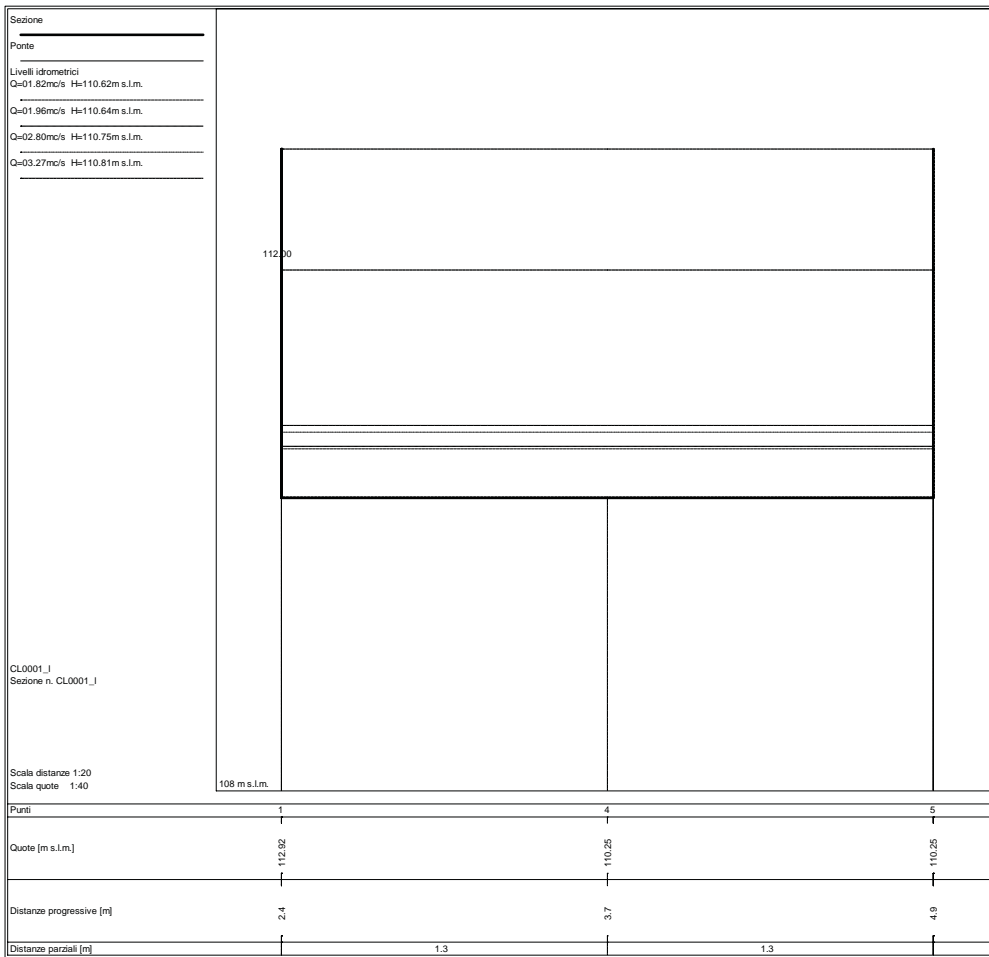

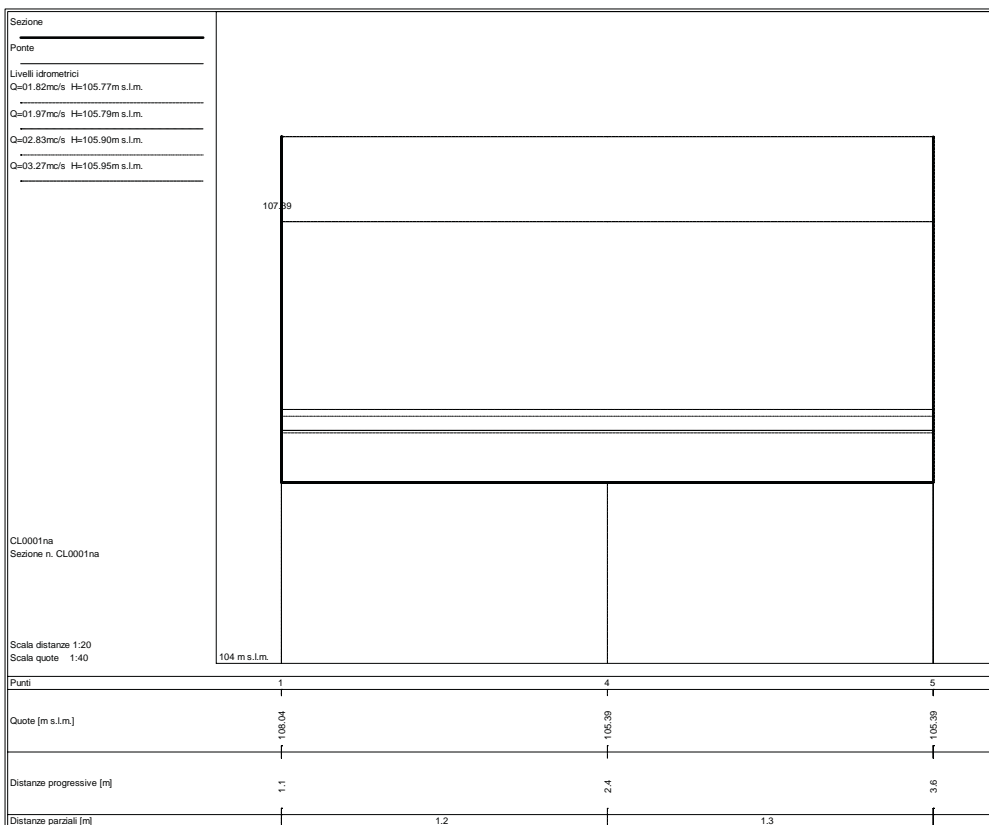
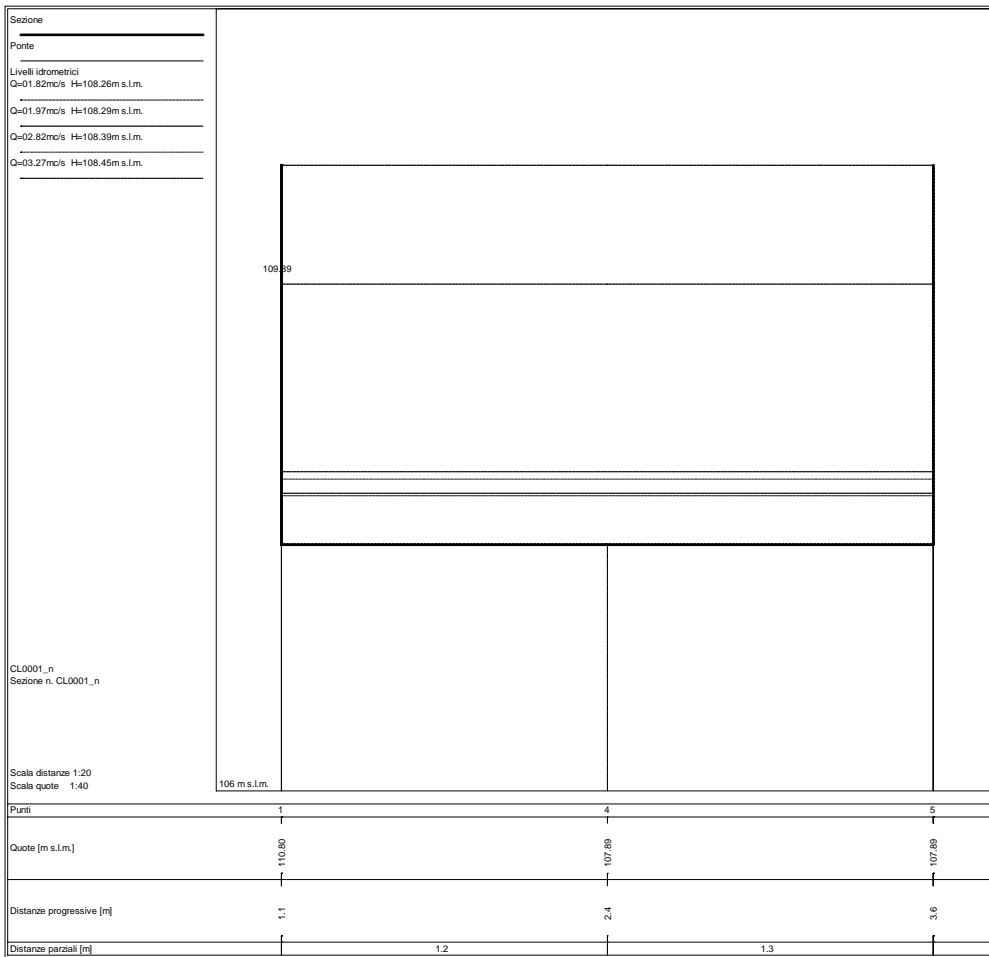

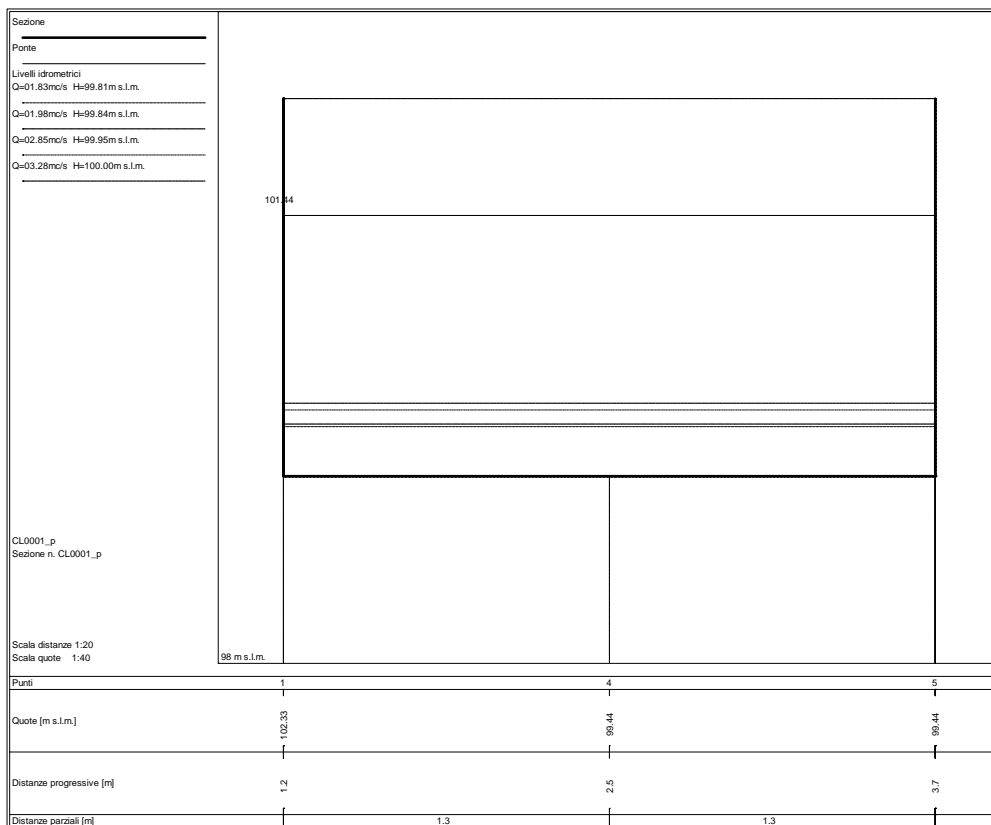
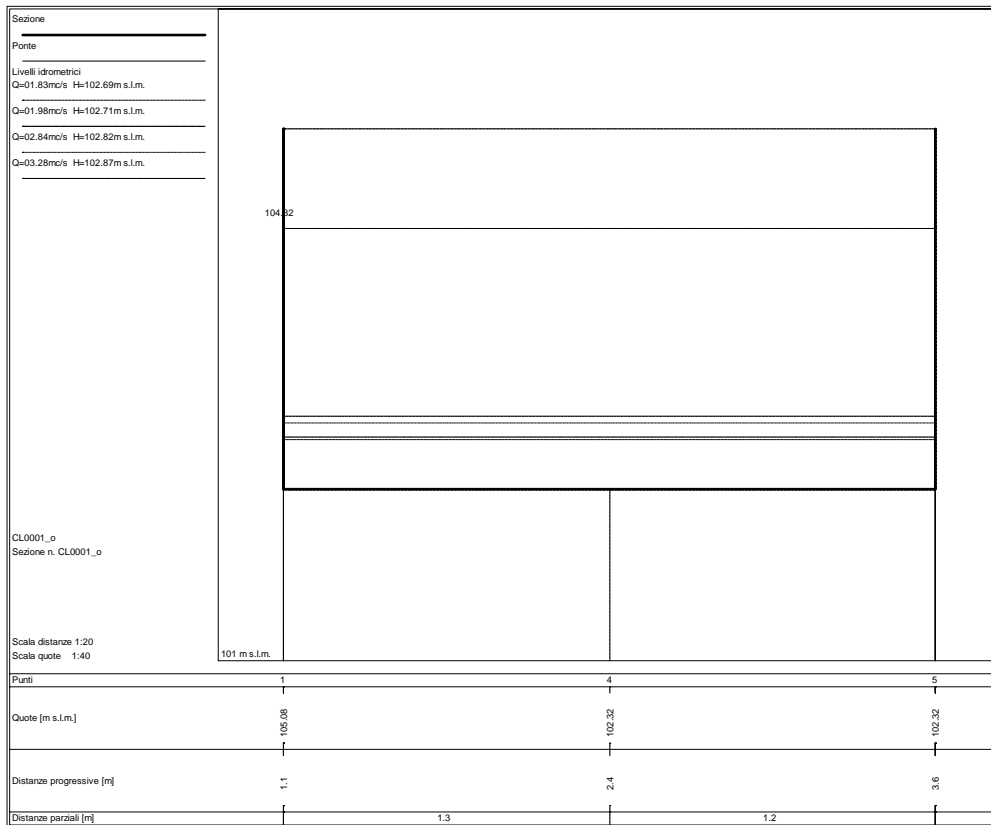

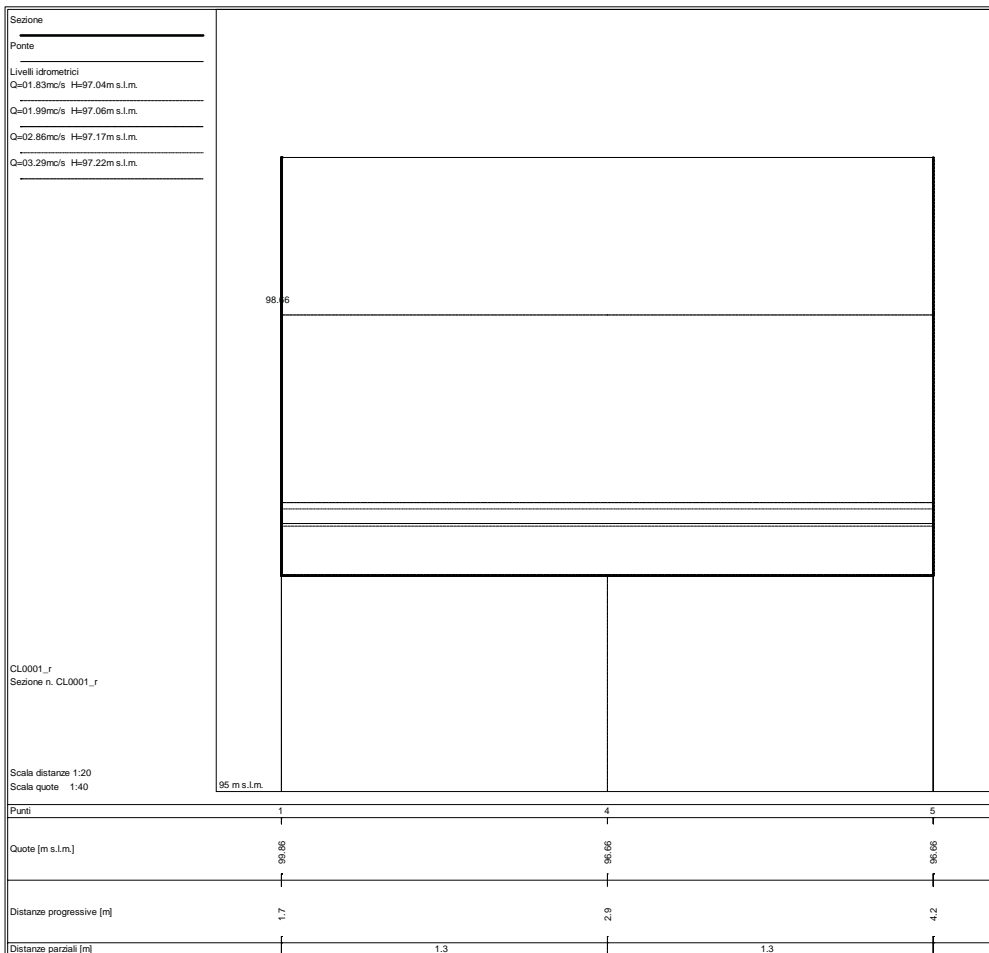
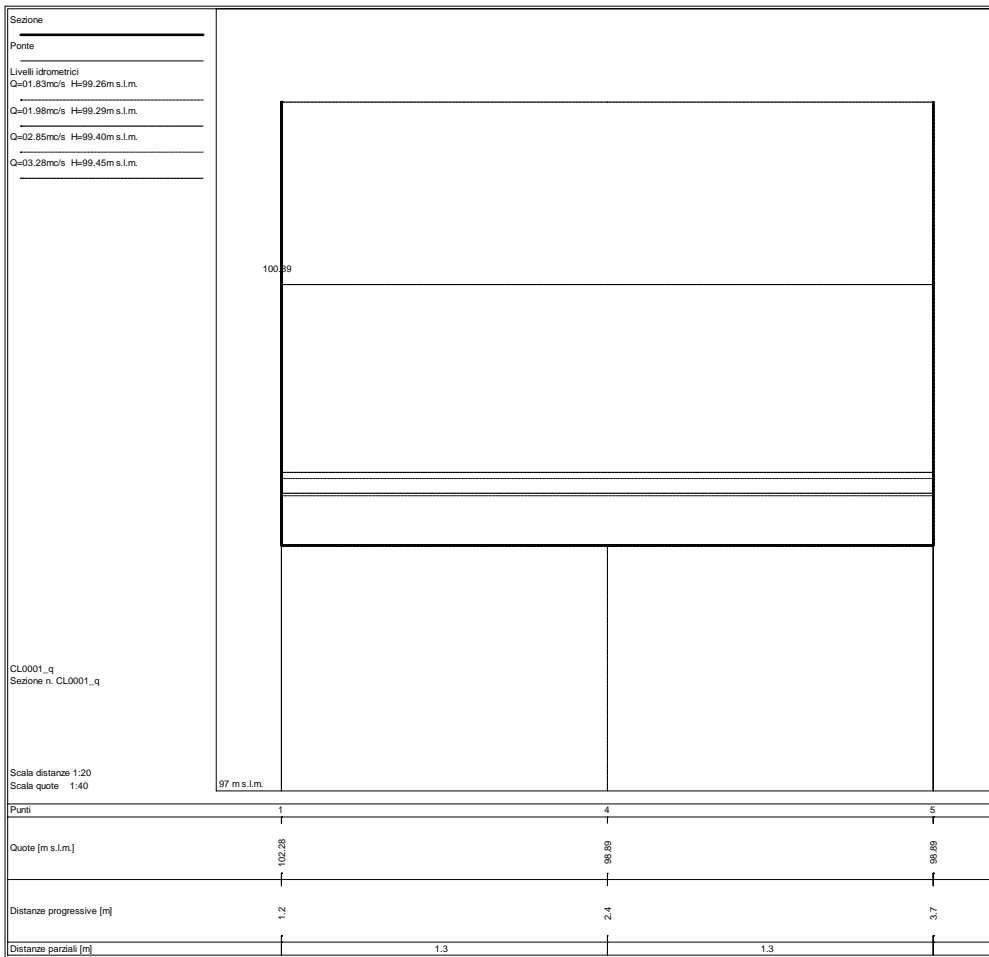

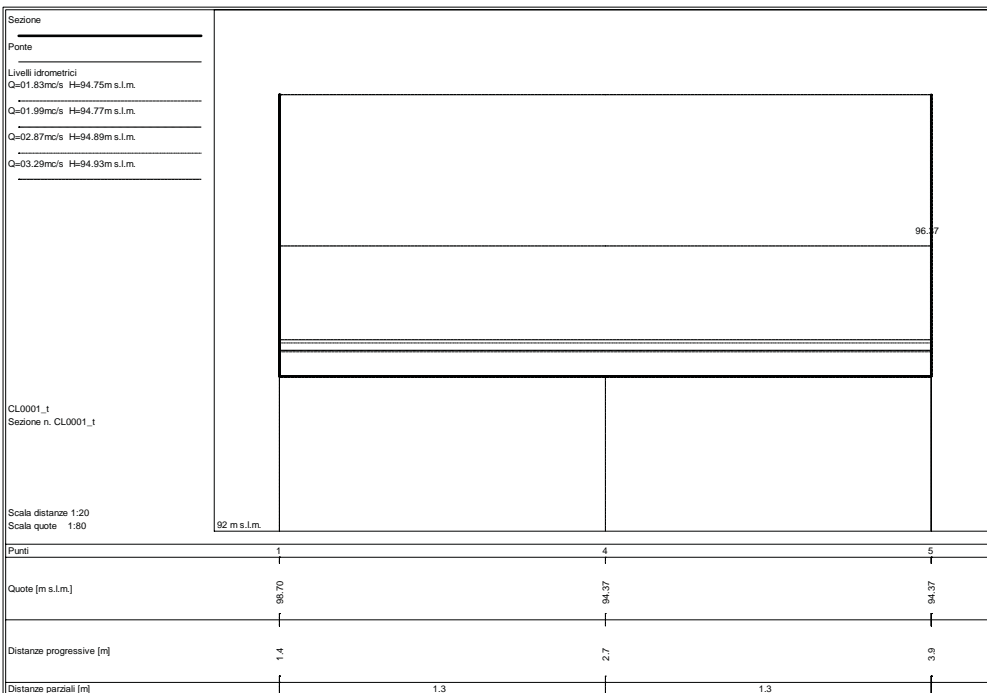
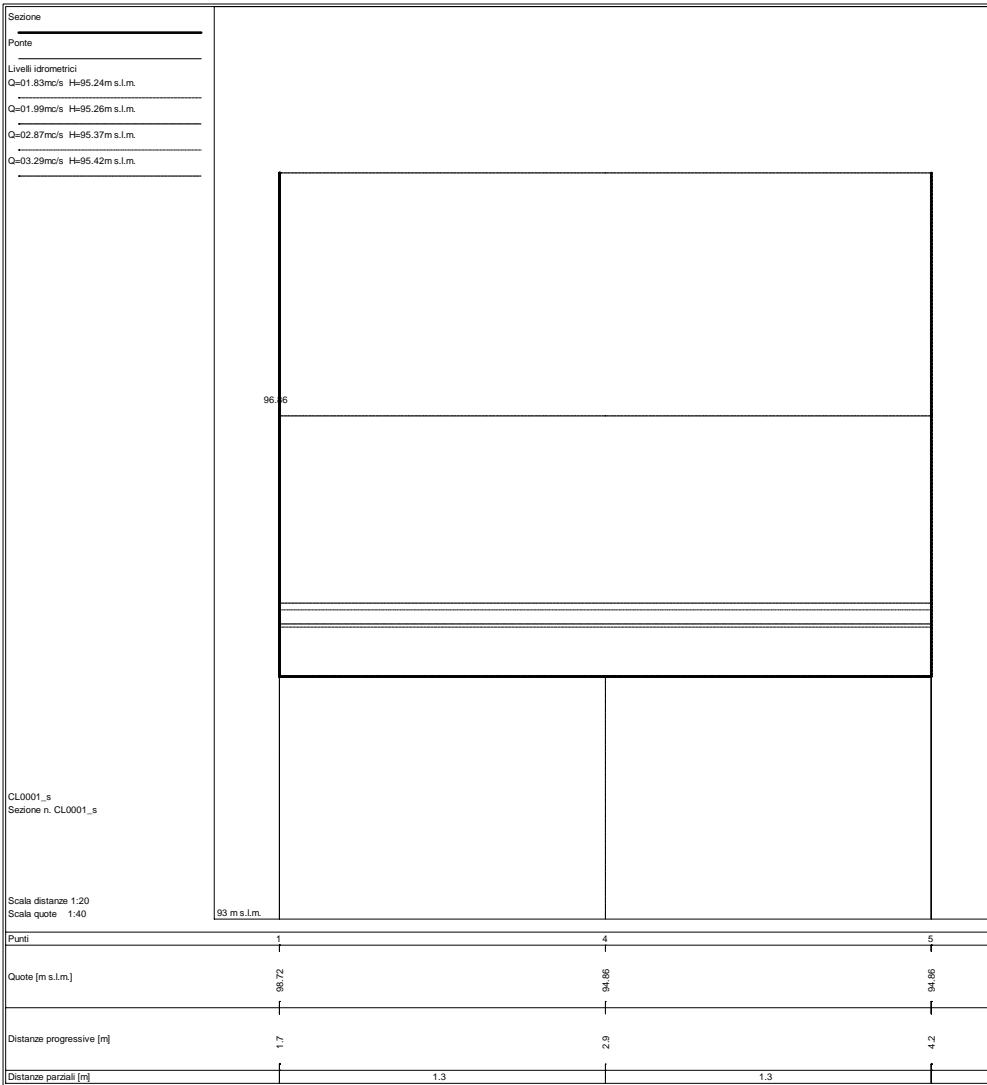

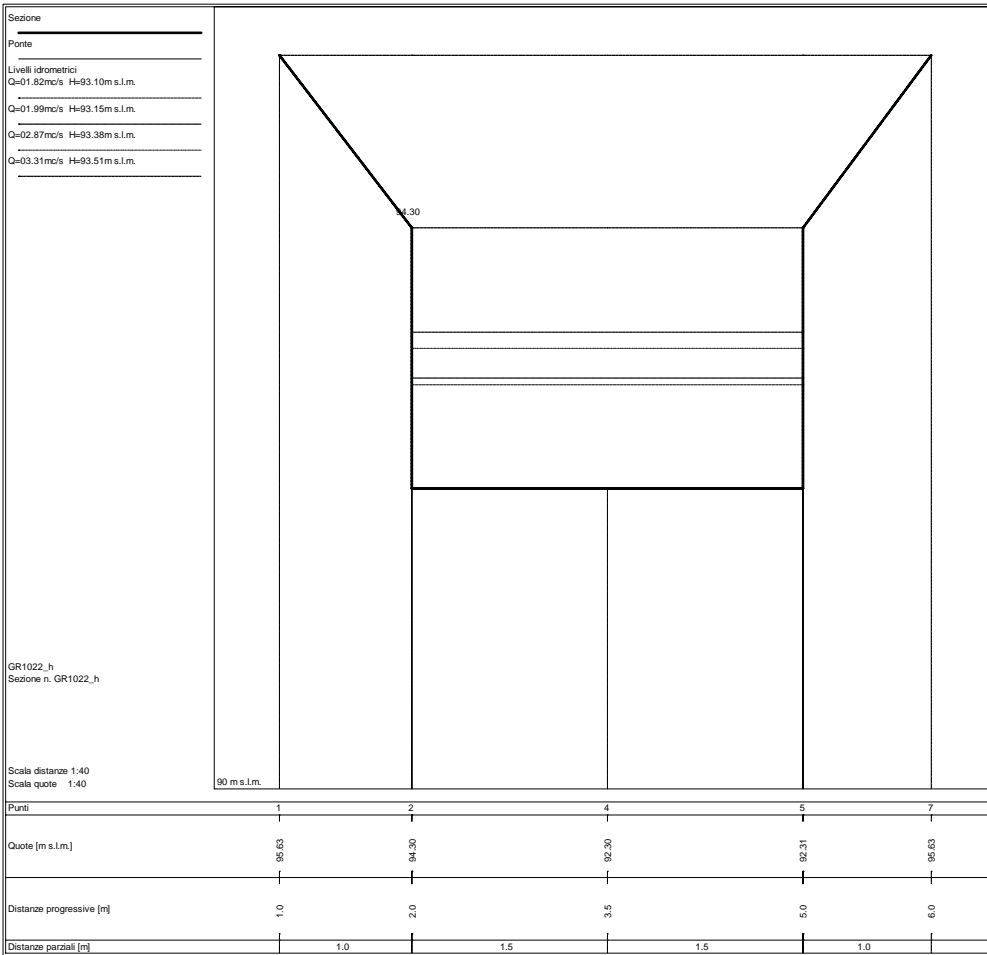

STATO ATTUALE
Sezioni fluviali fosso Ronco

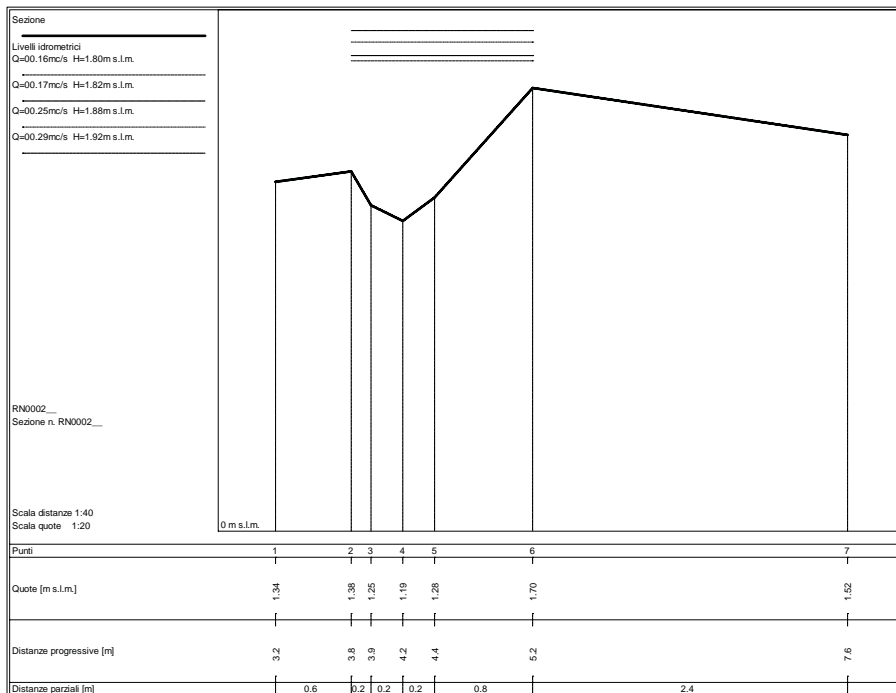
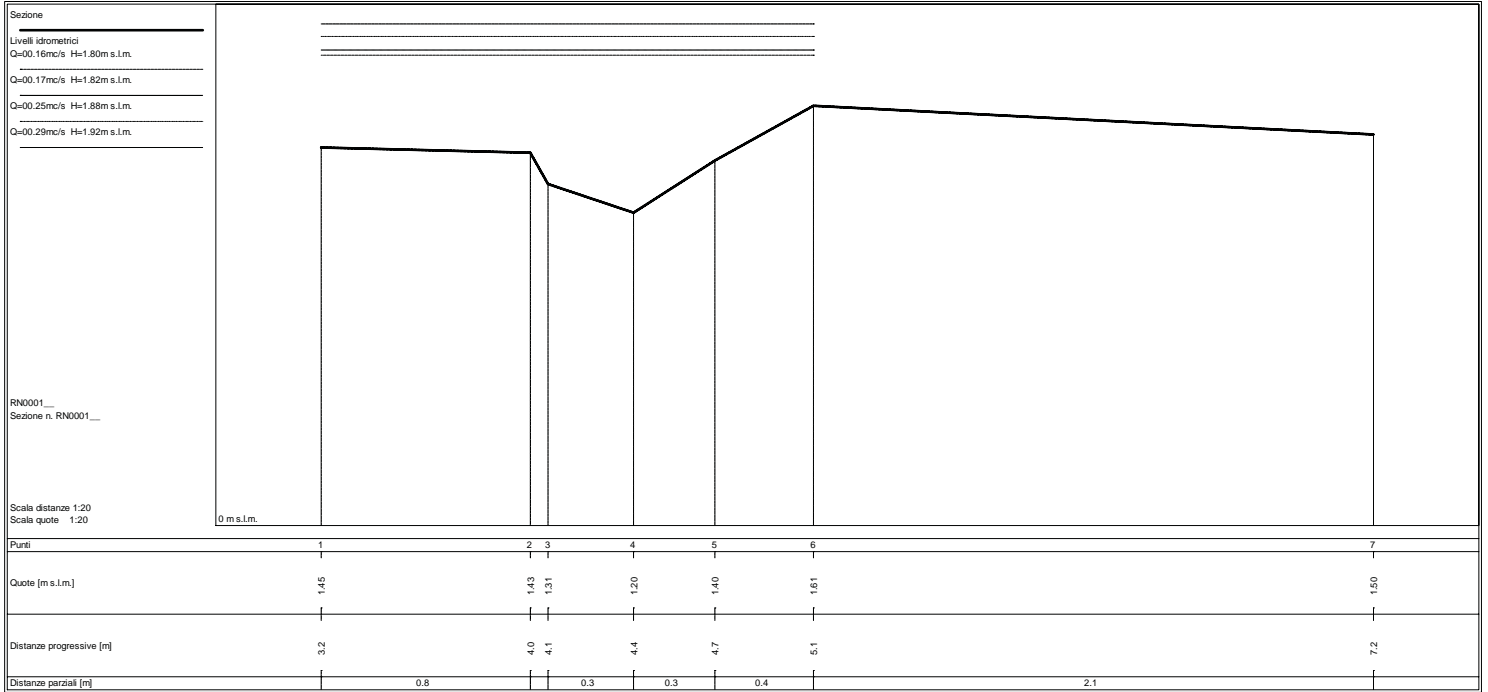

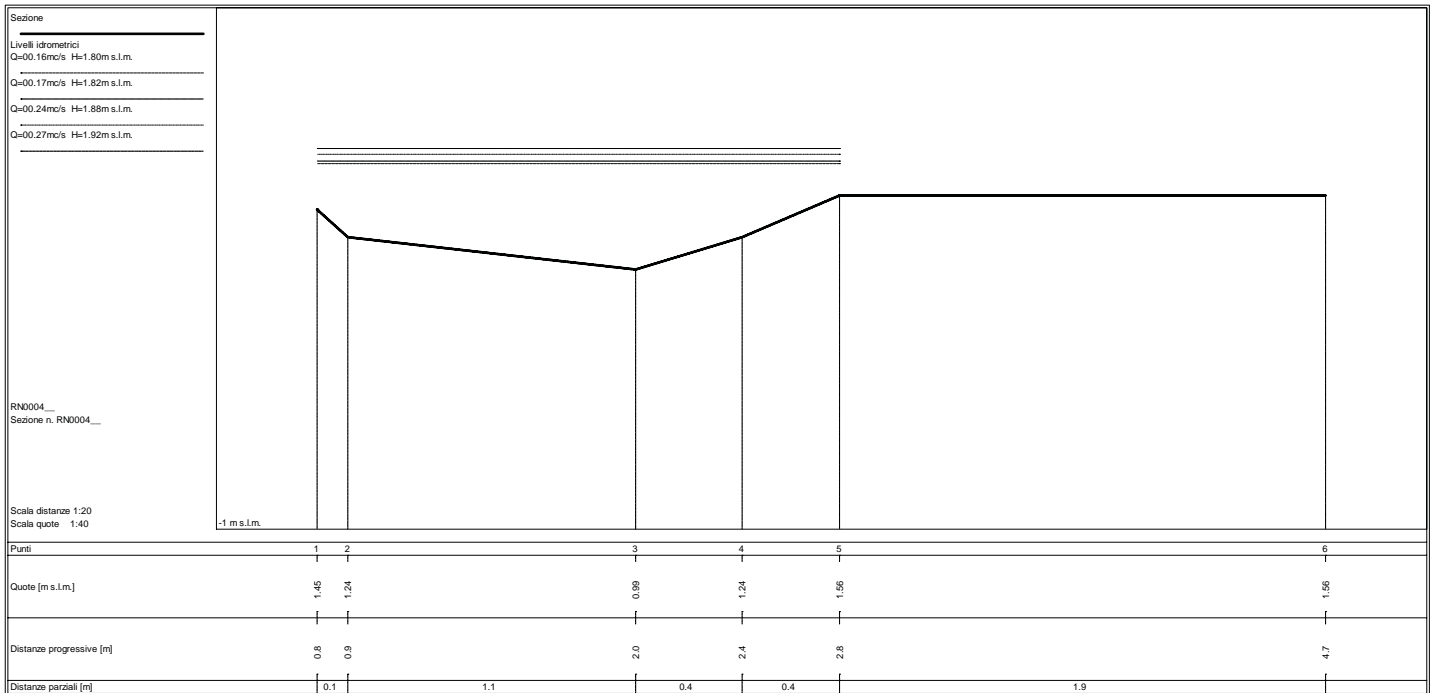
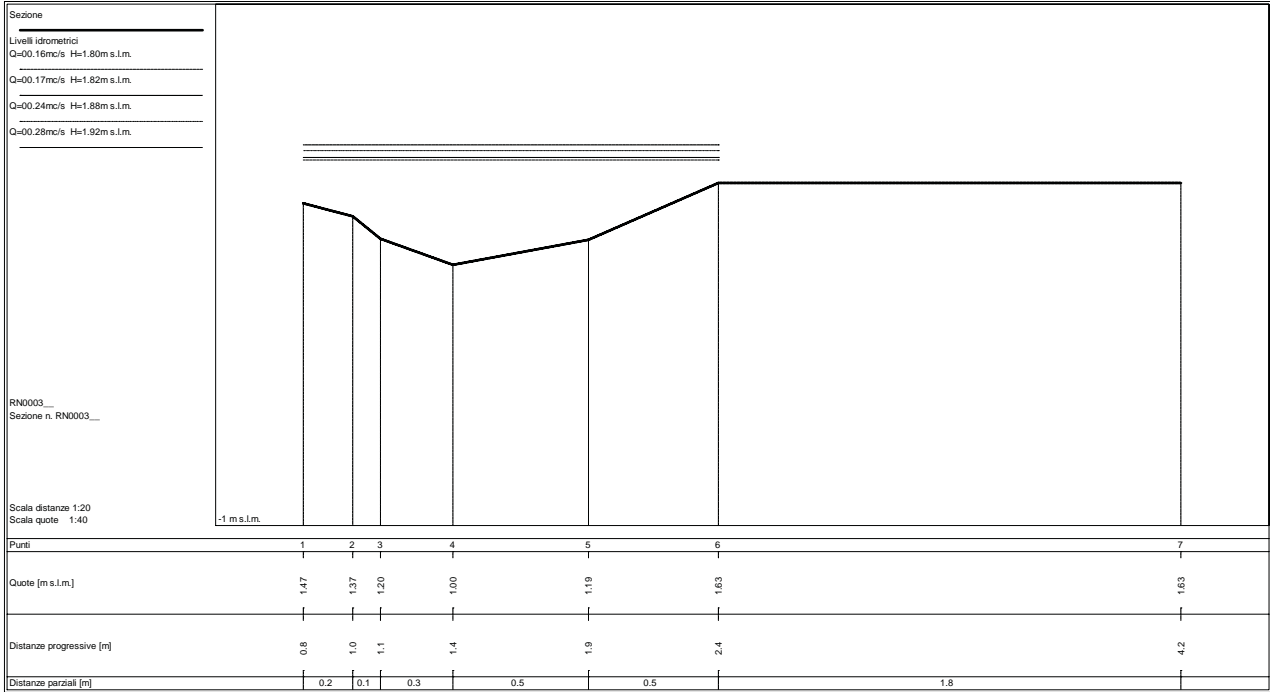

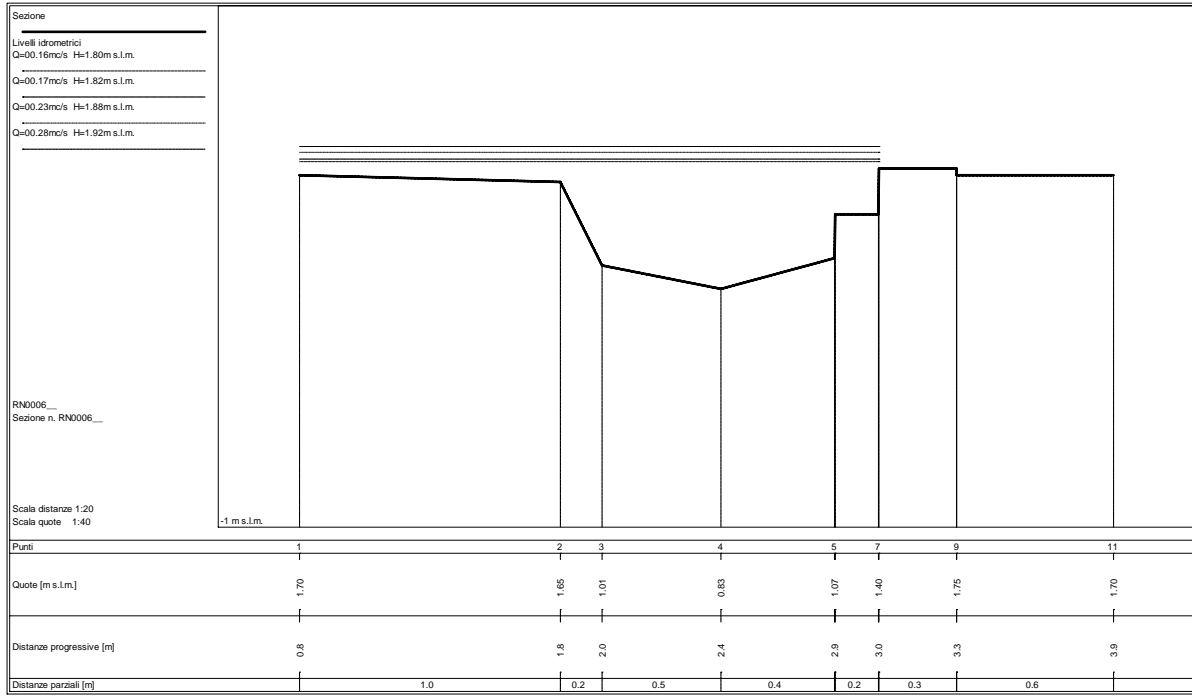
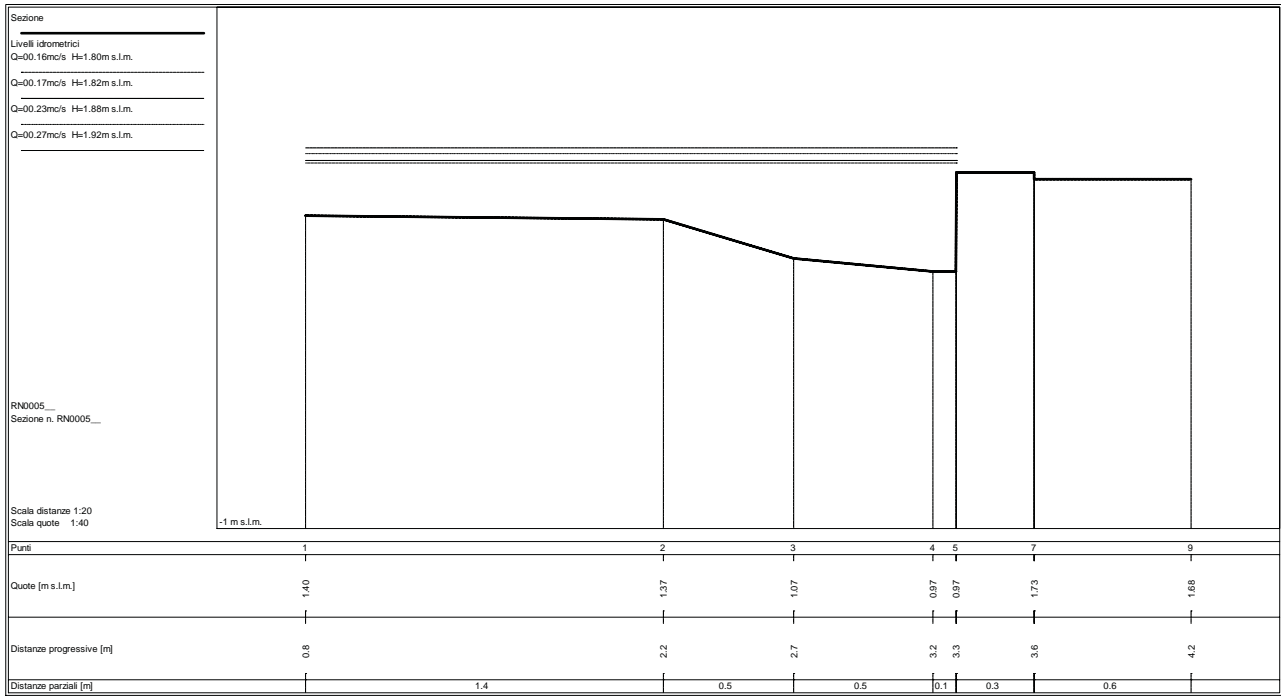

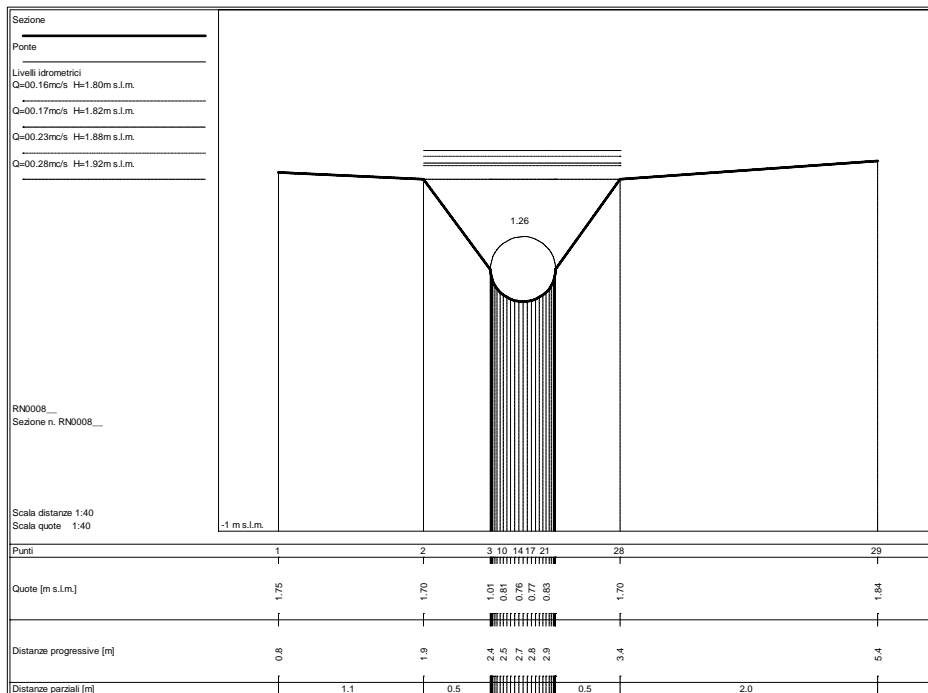
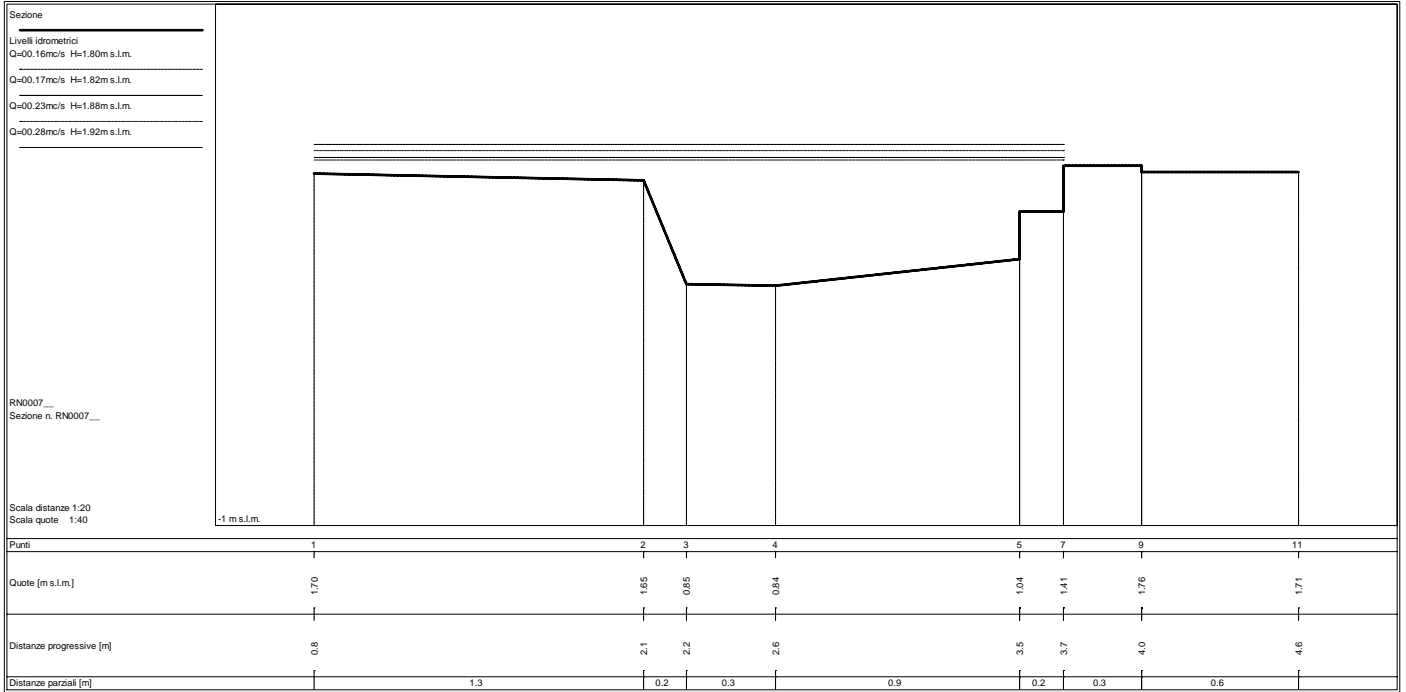

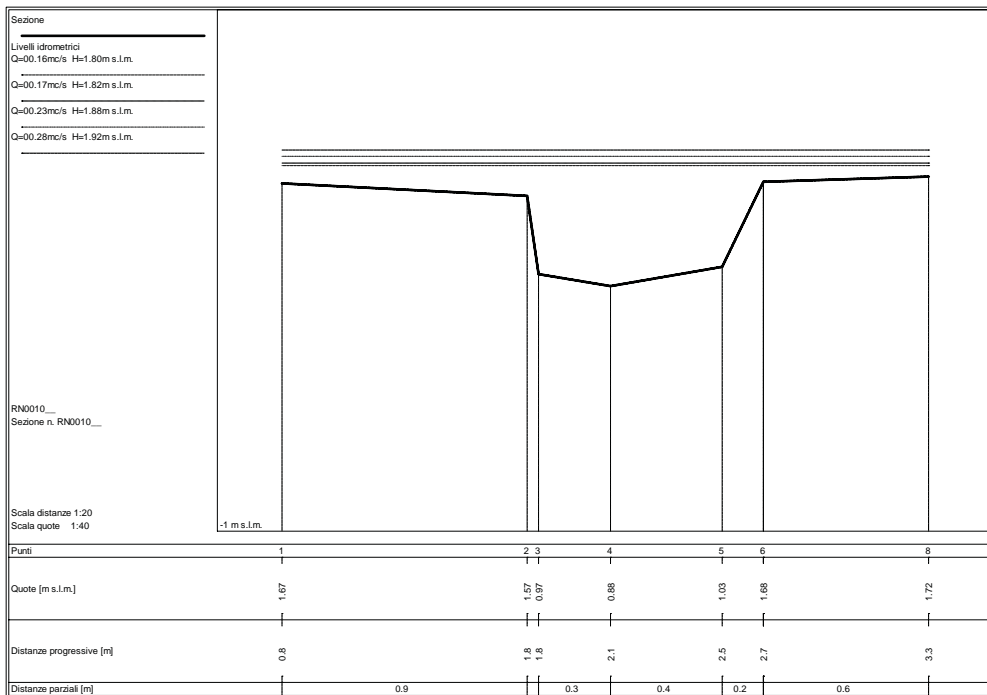
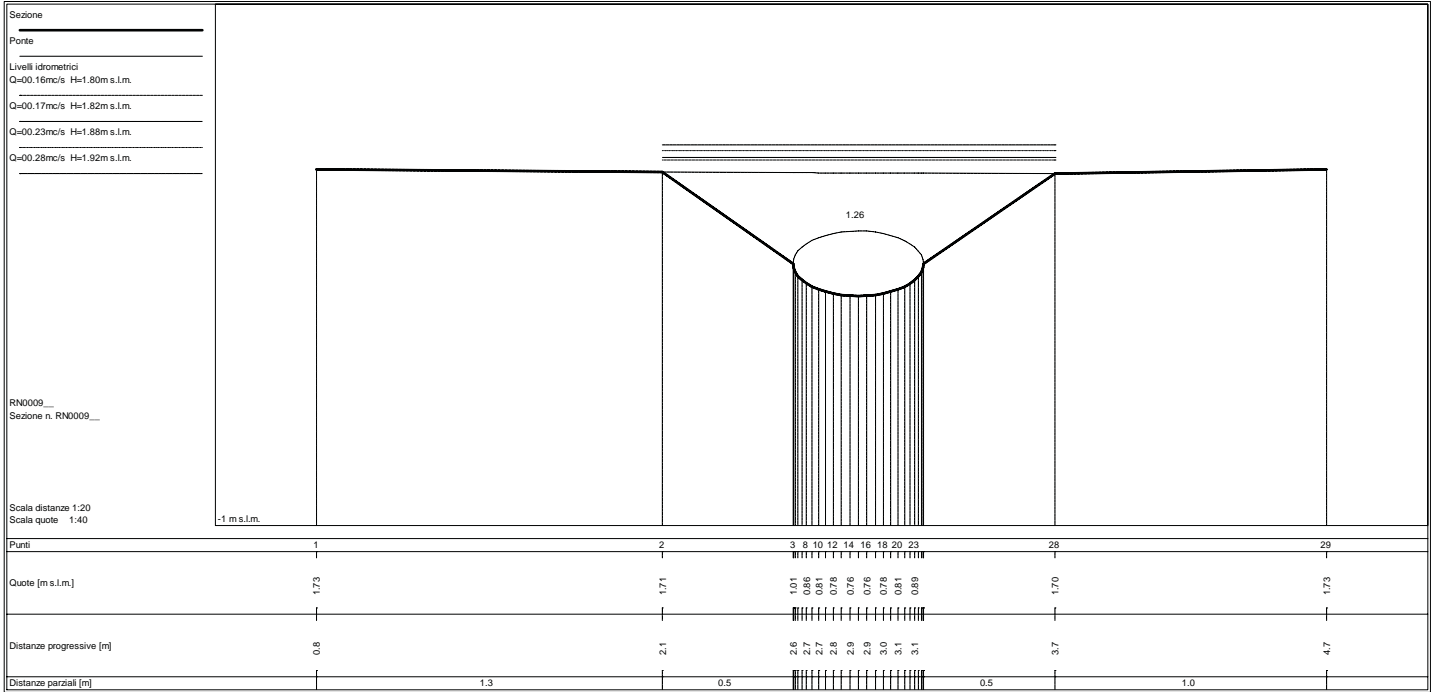

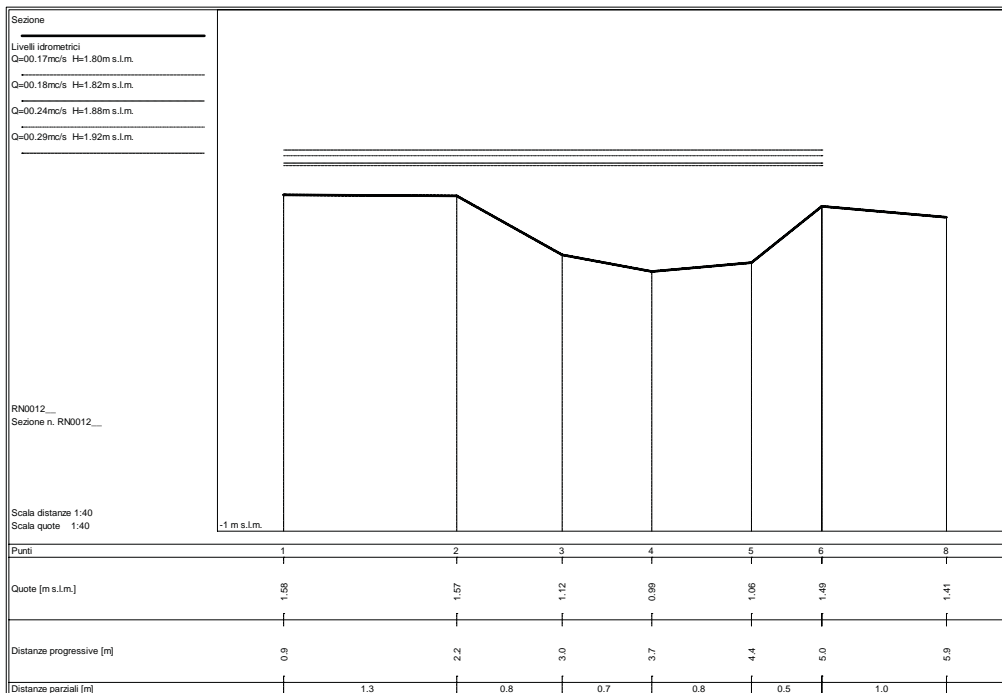
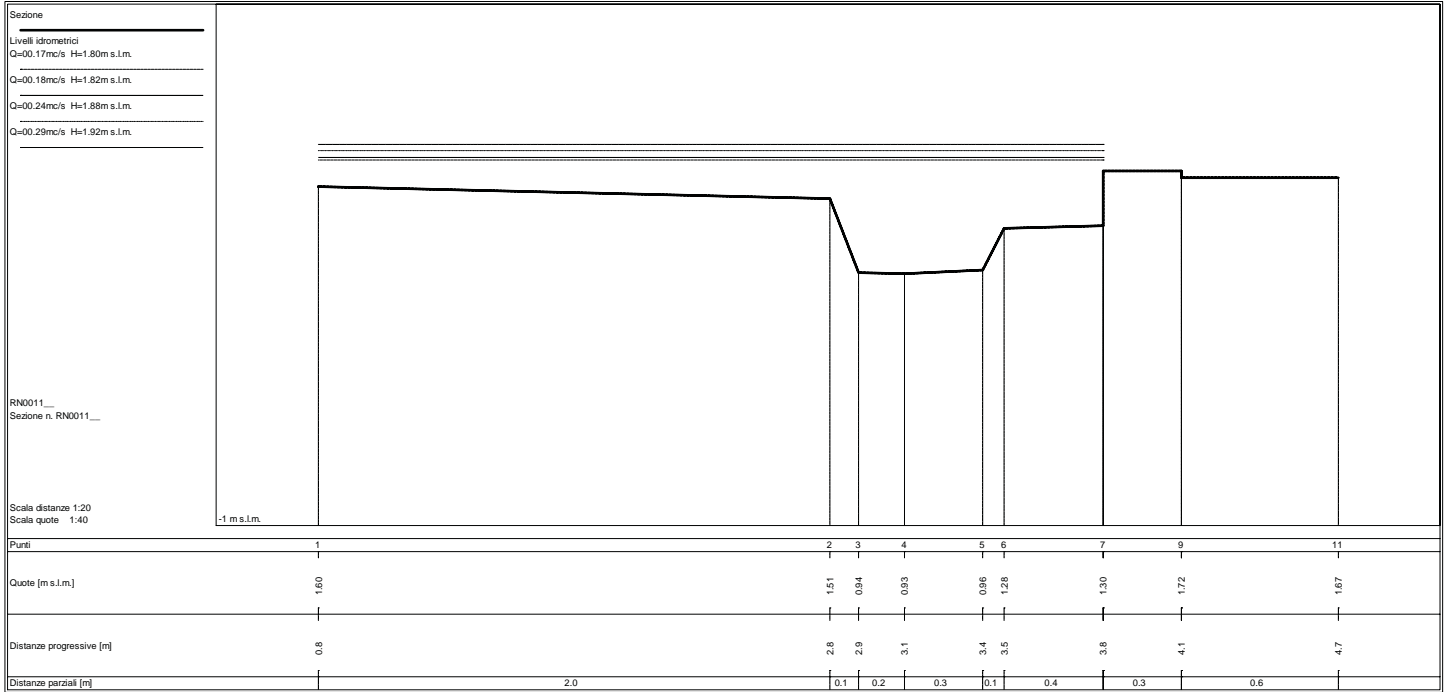

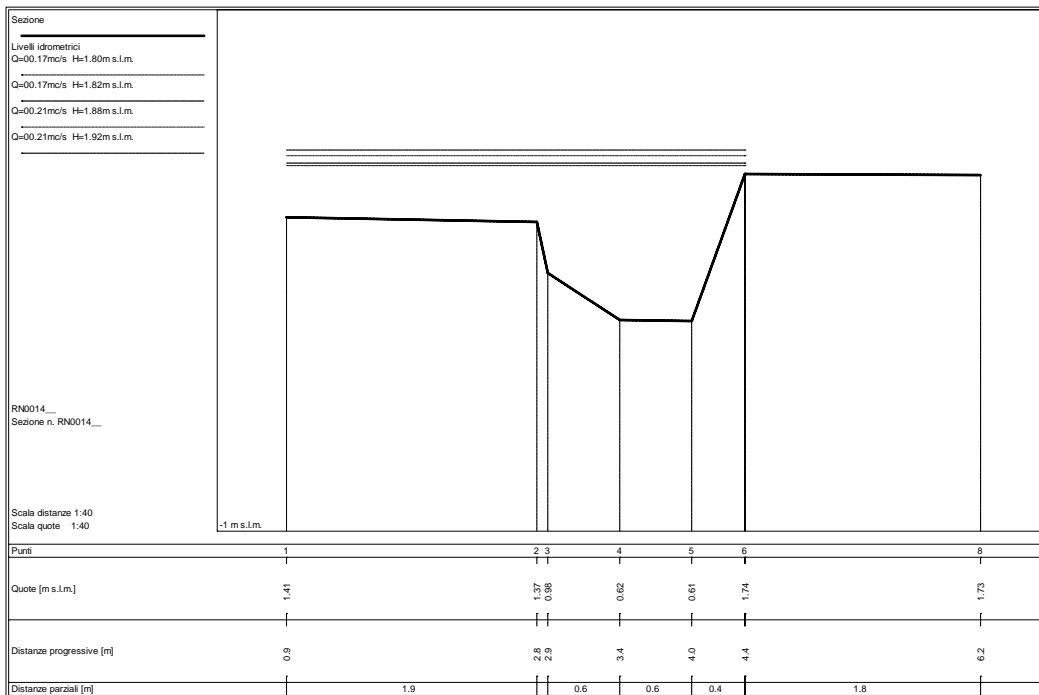
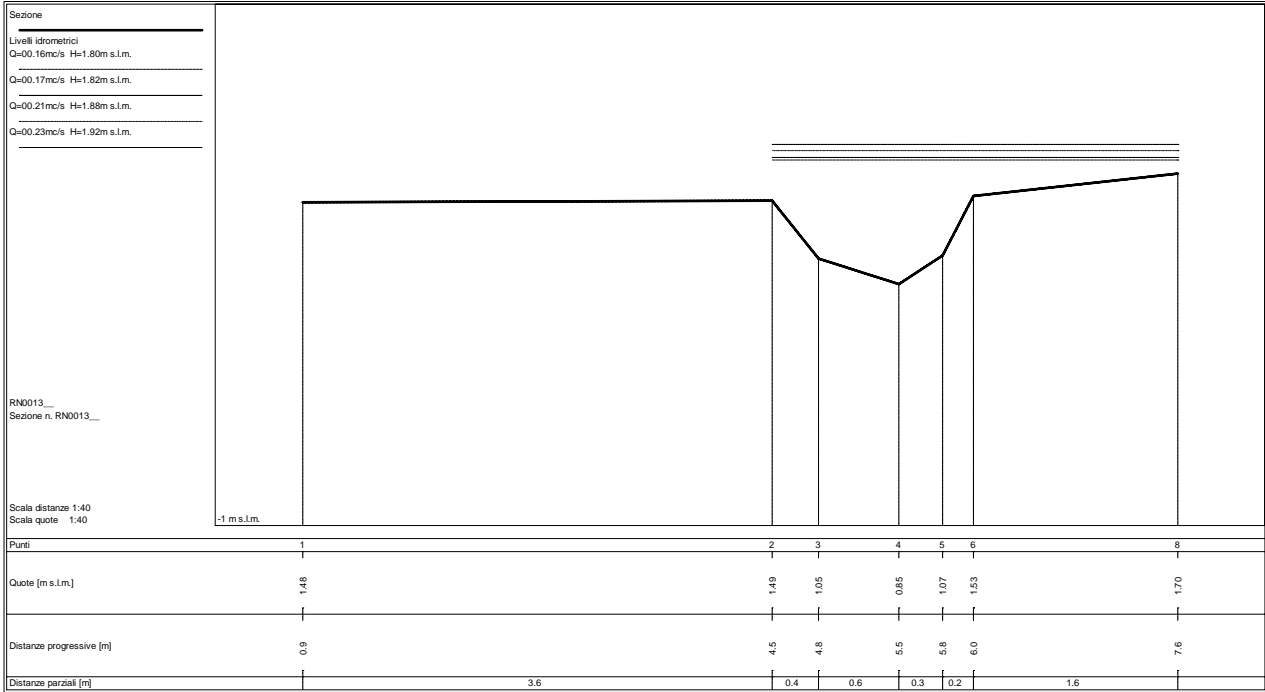

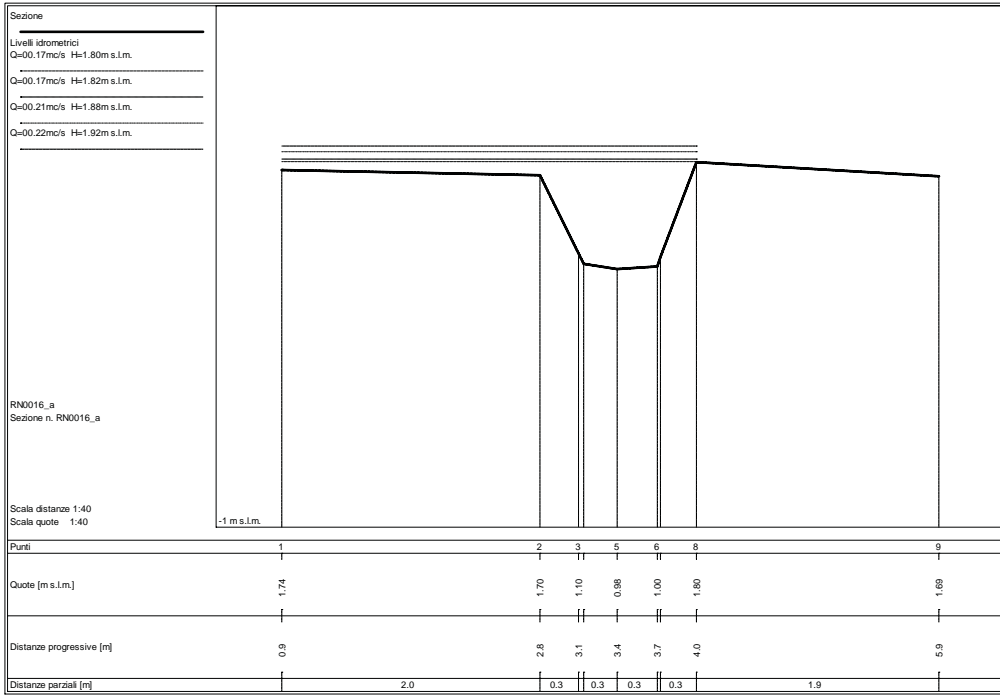
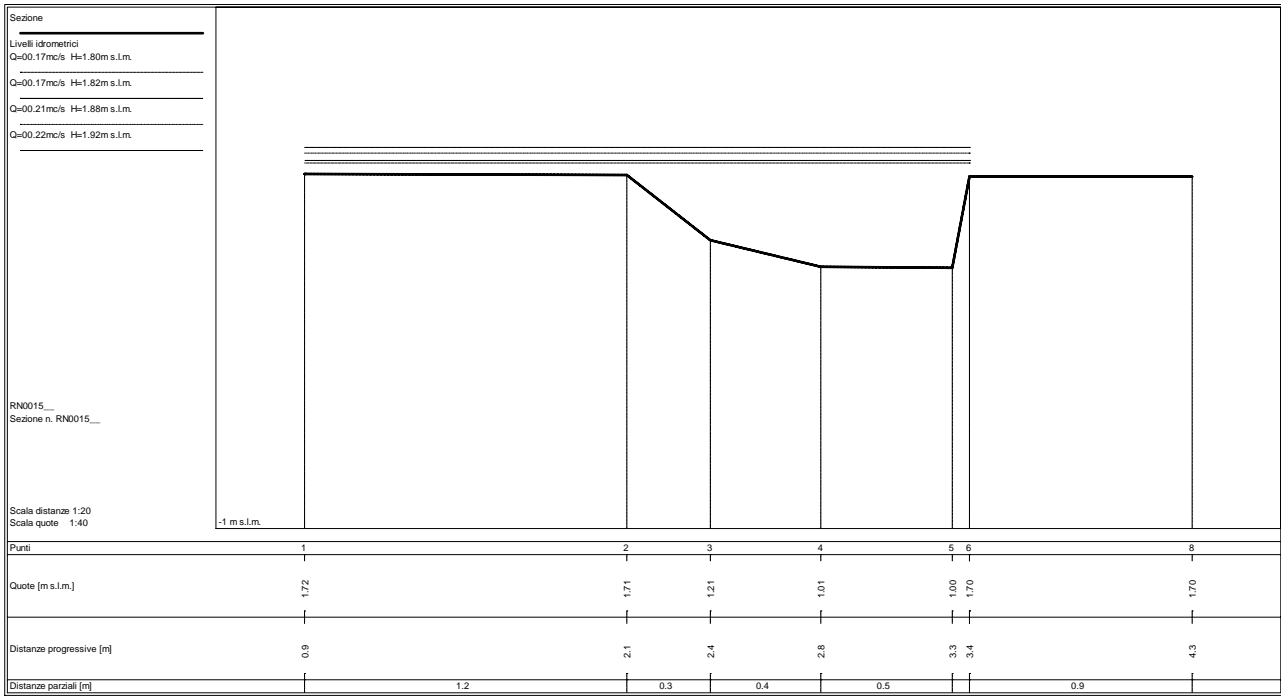

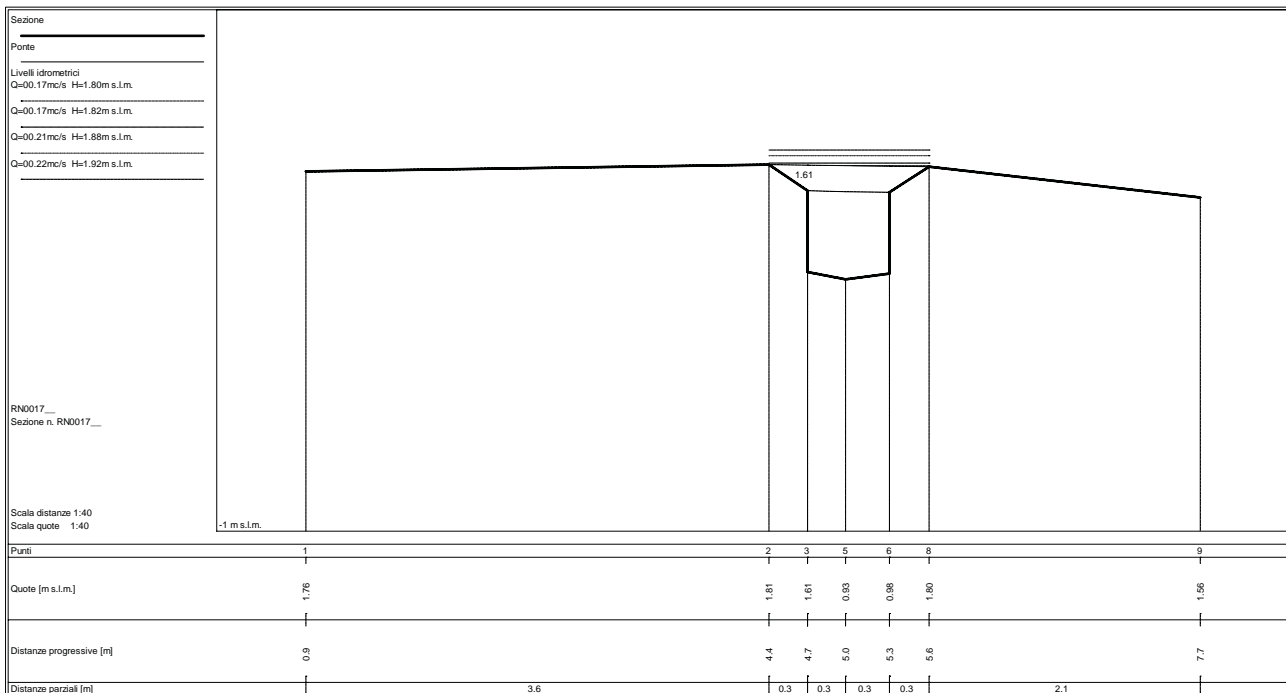
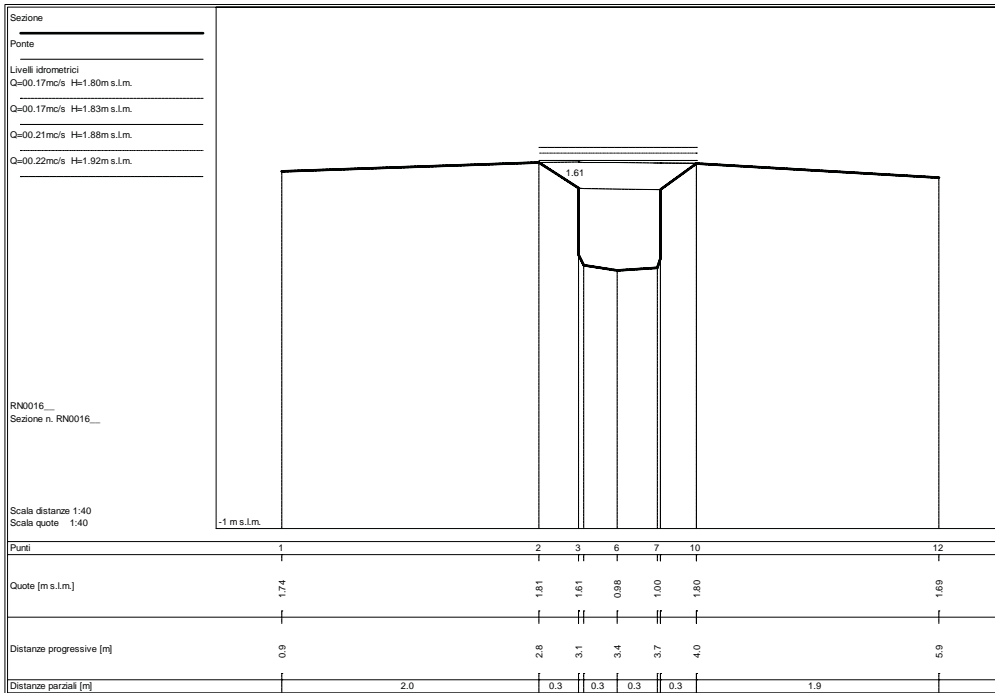

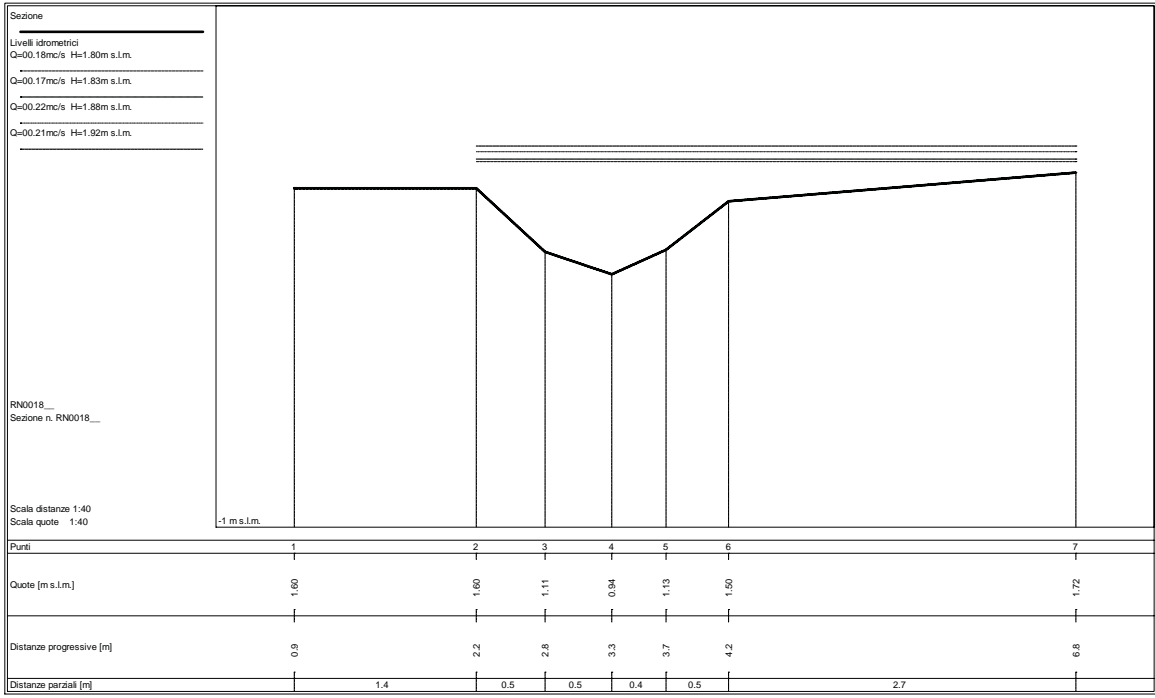
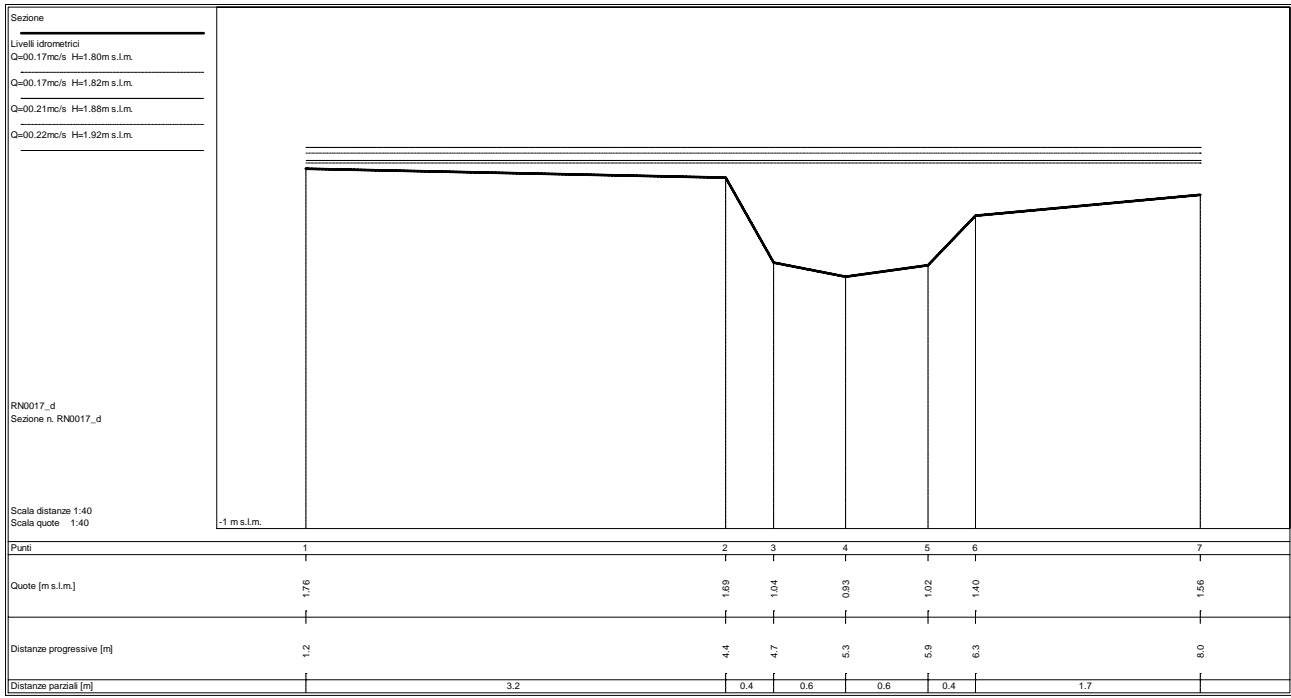

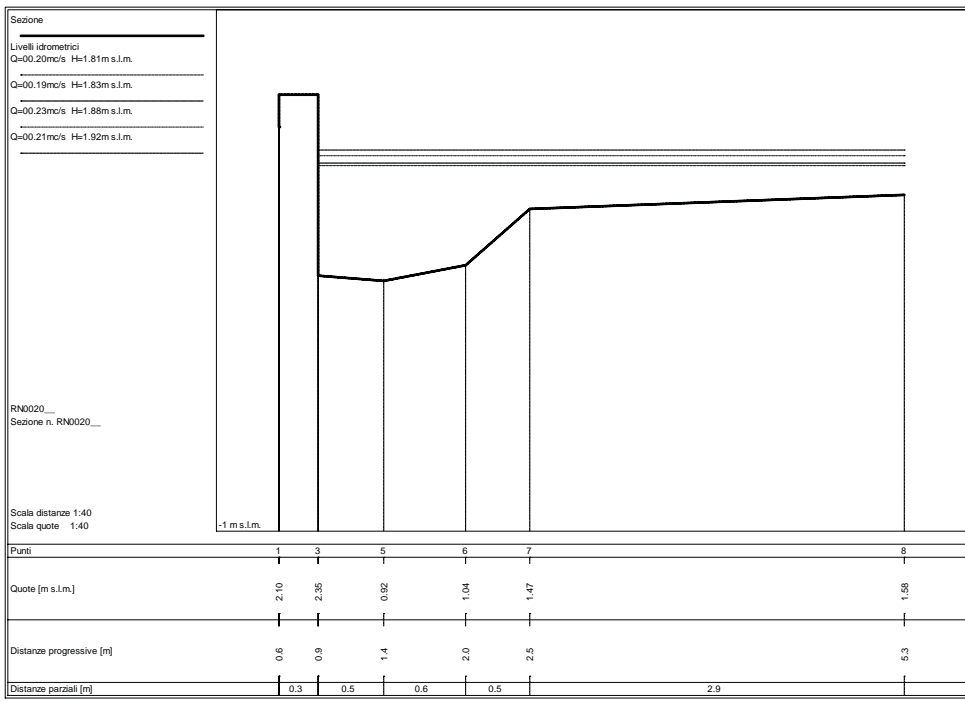
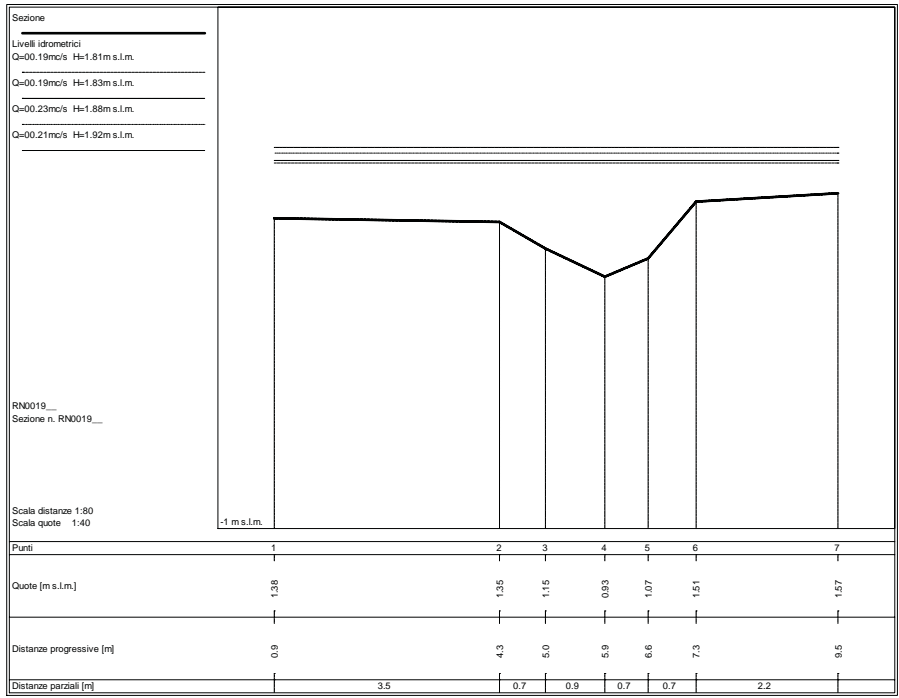

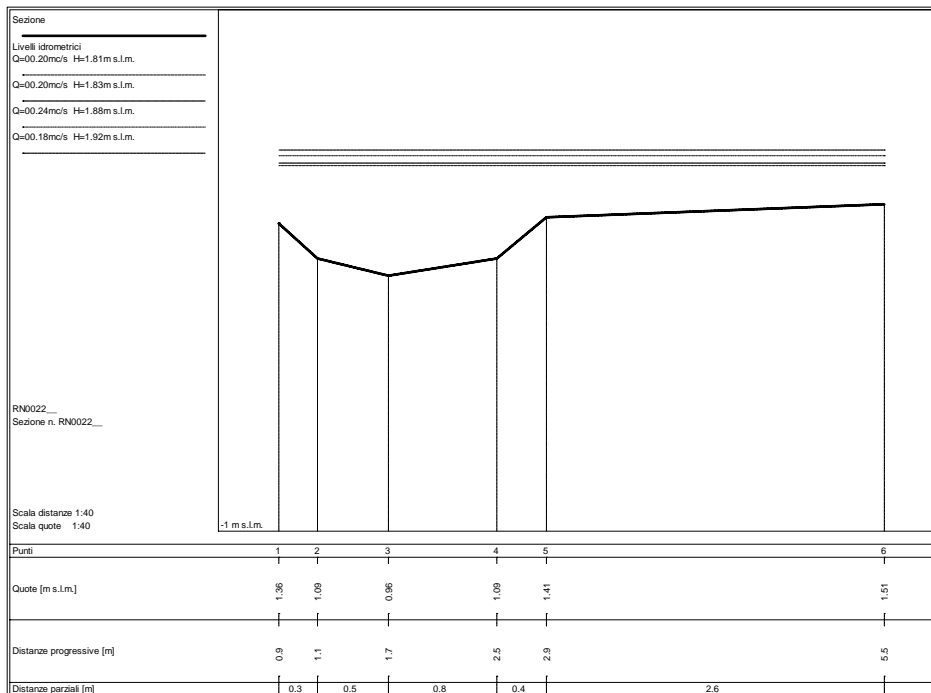
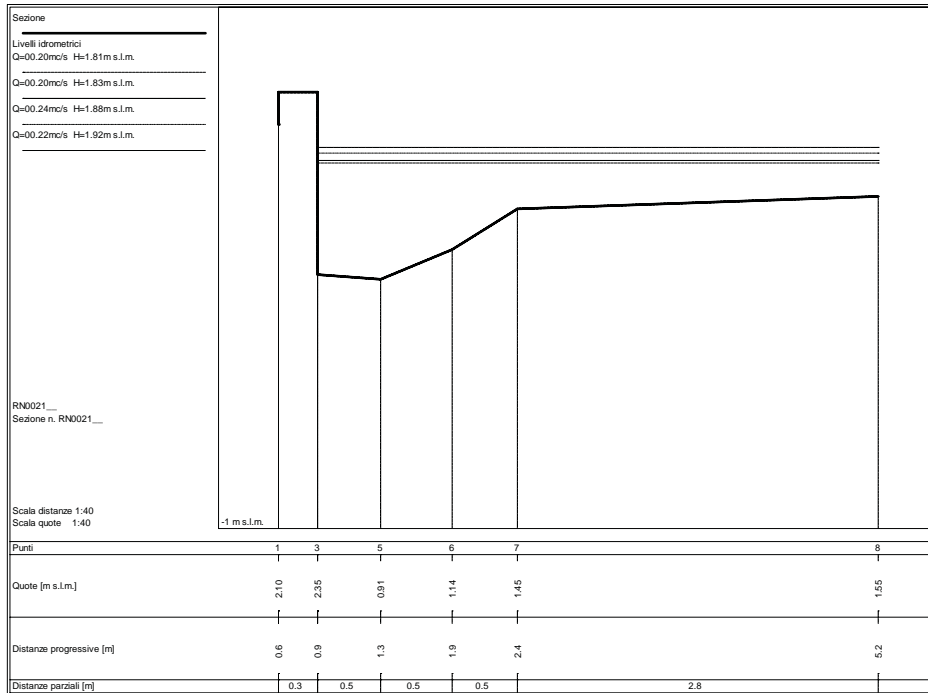

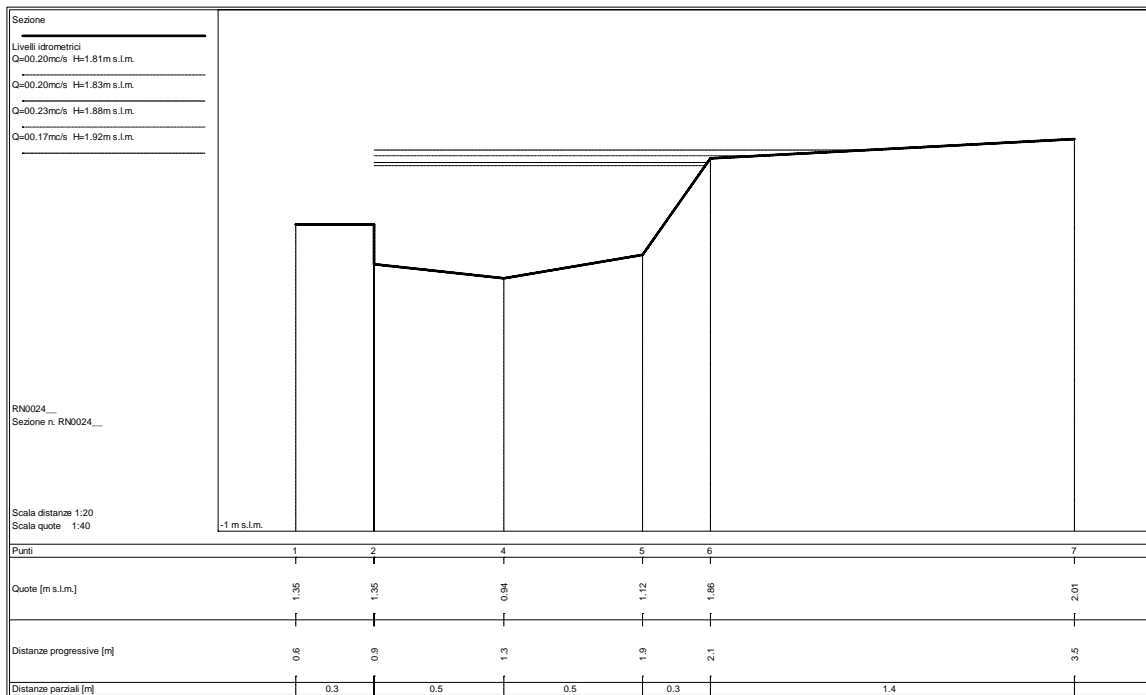
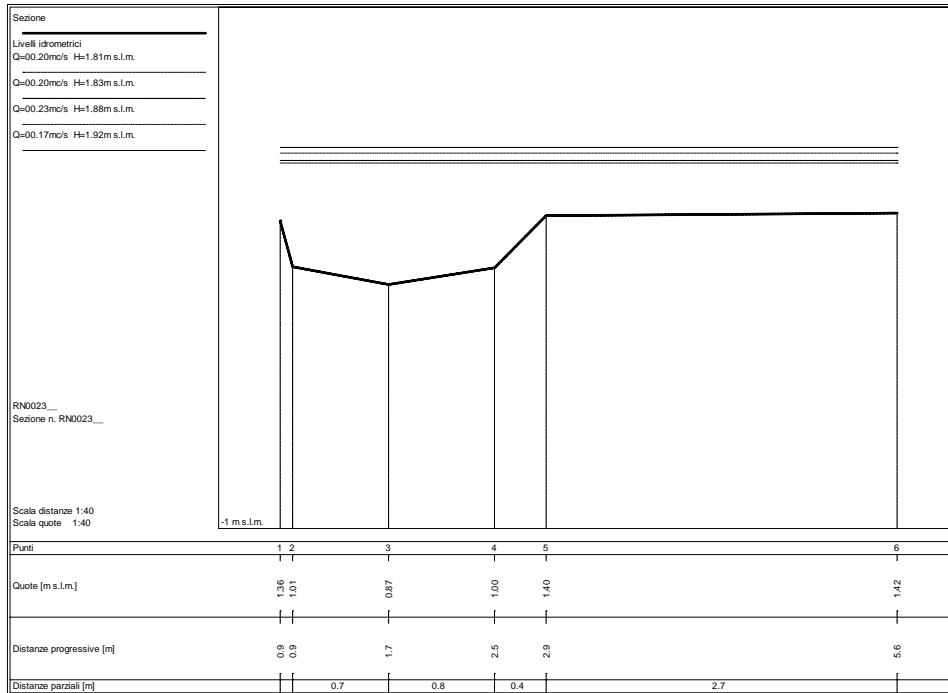

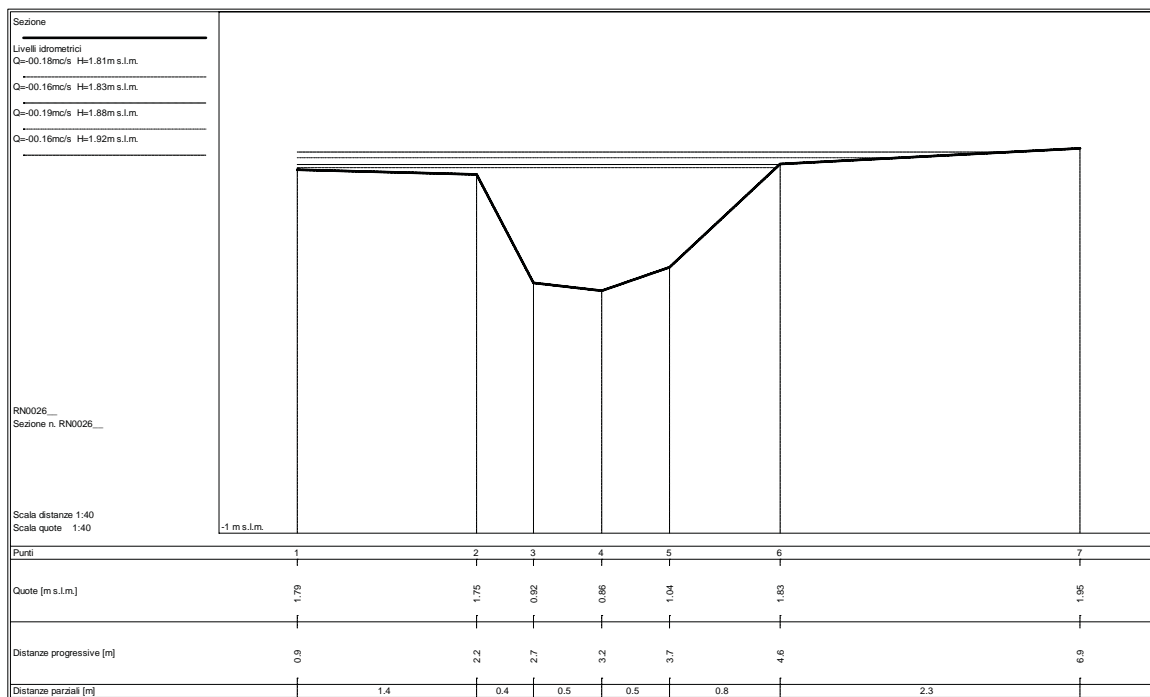
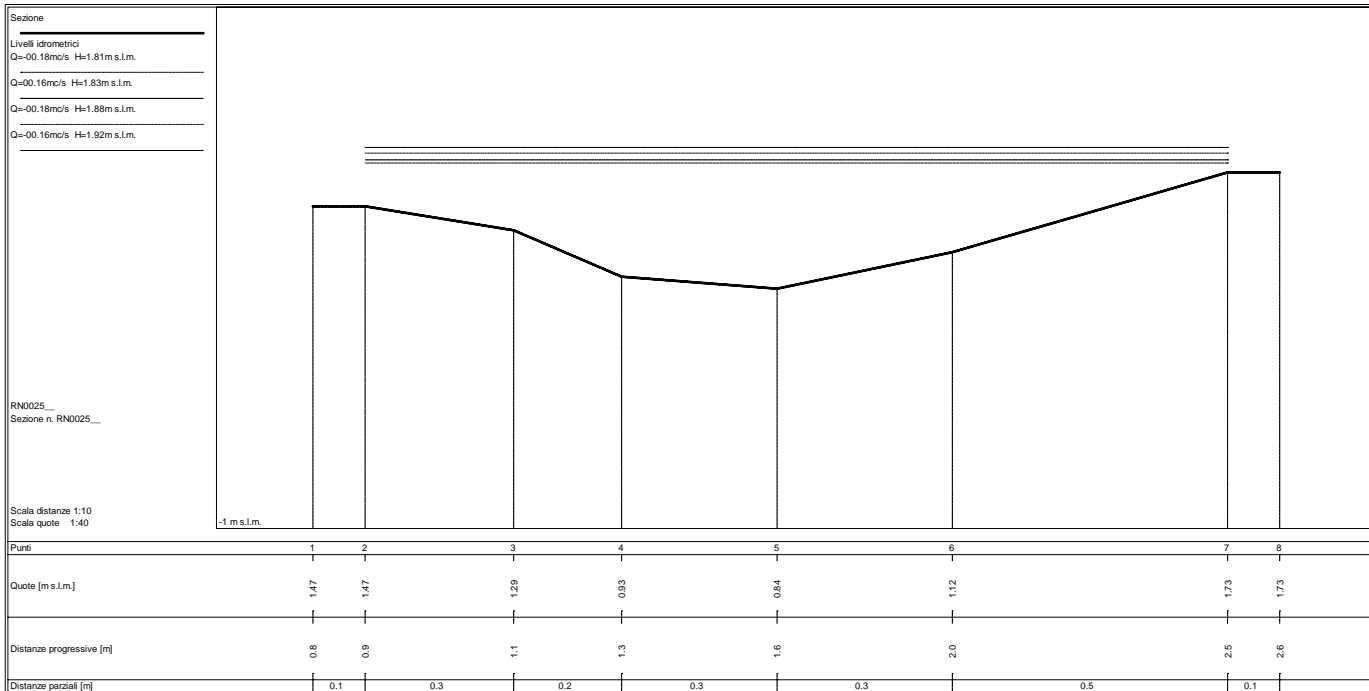

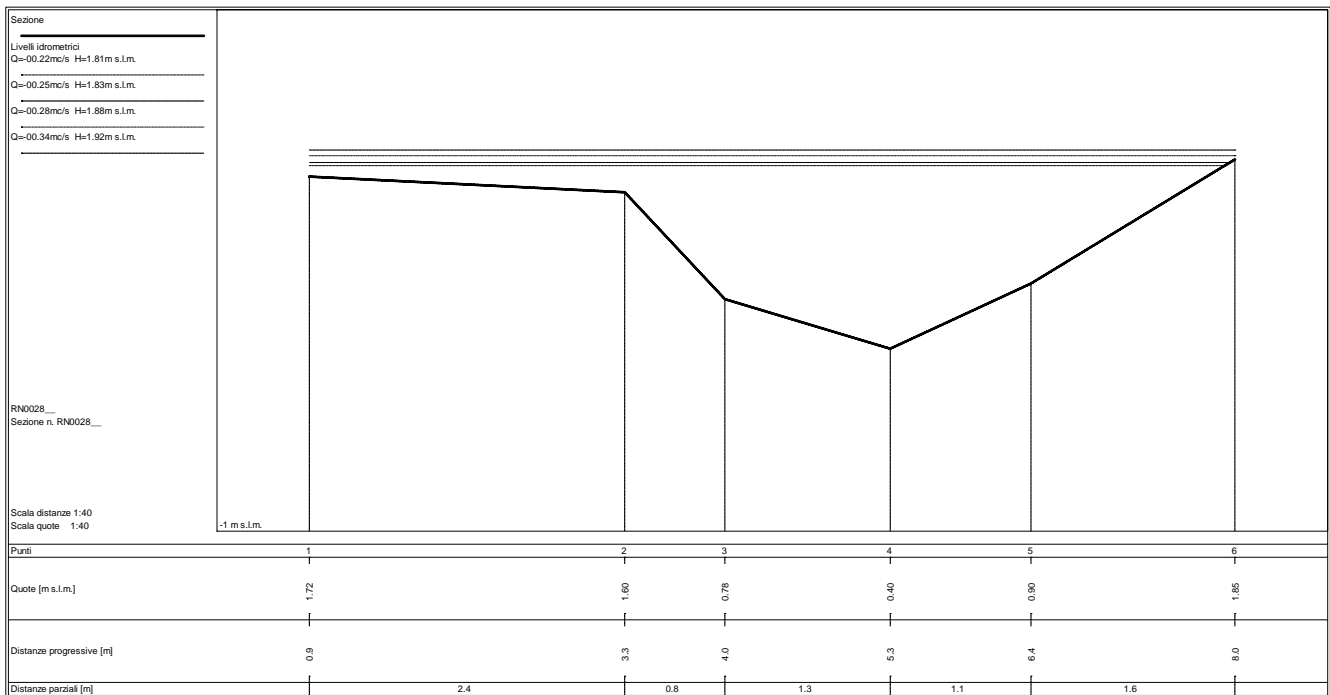
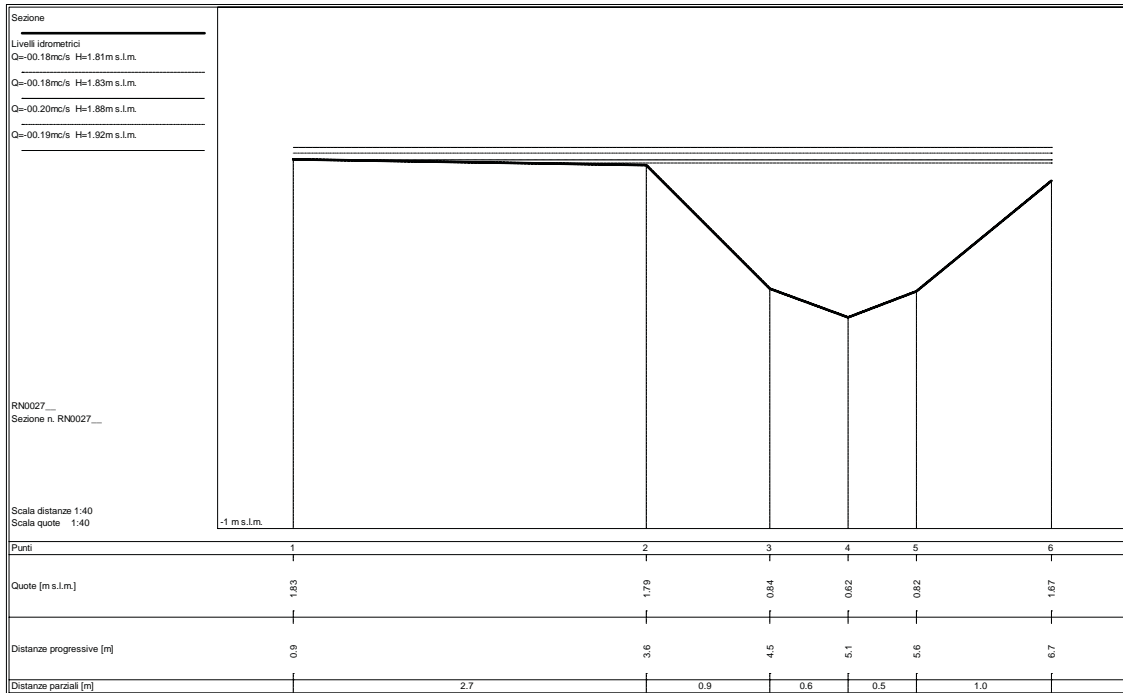

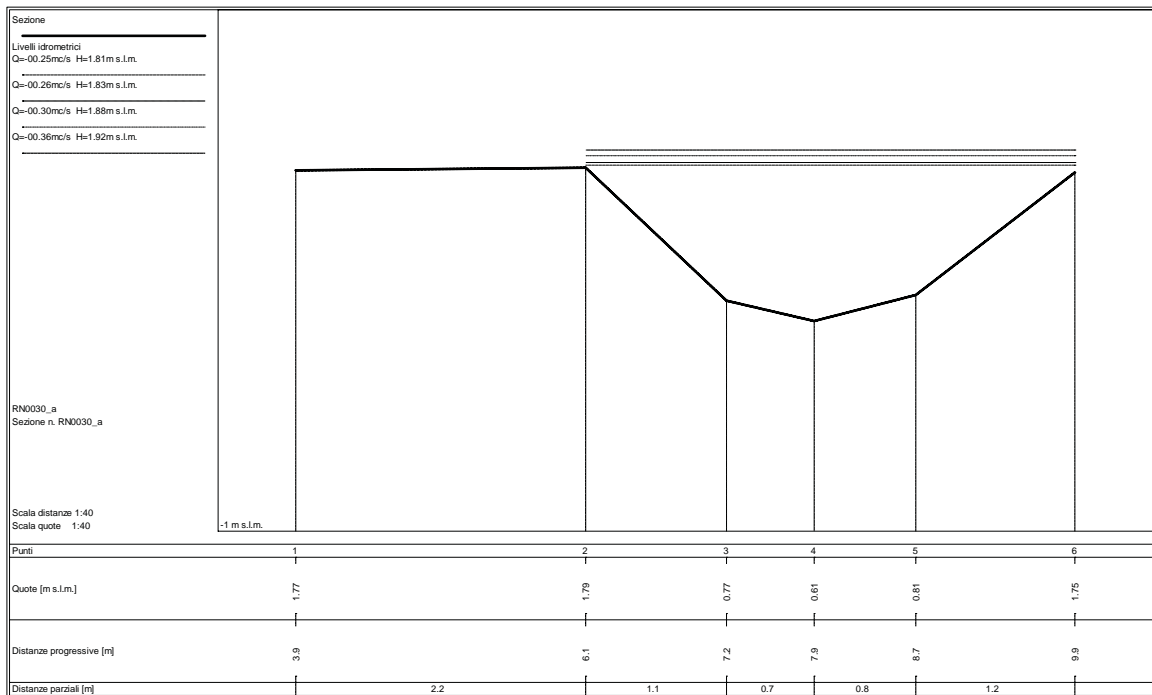
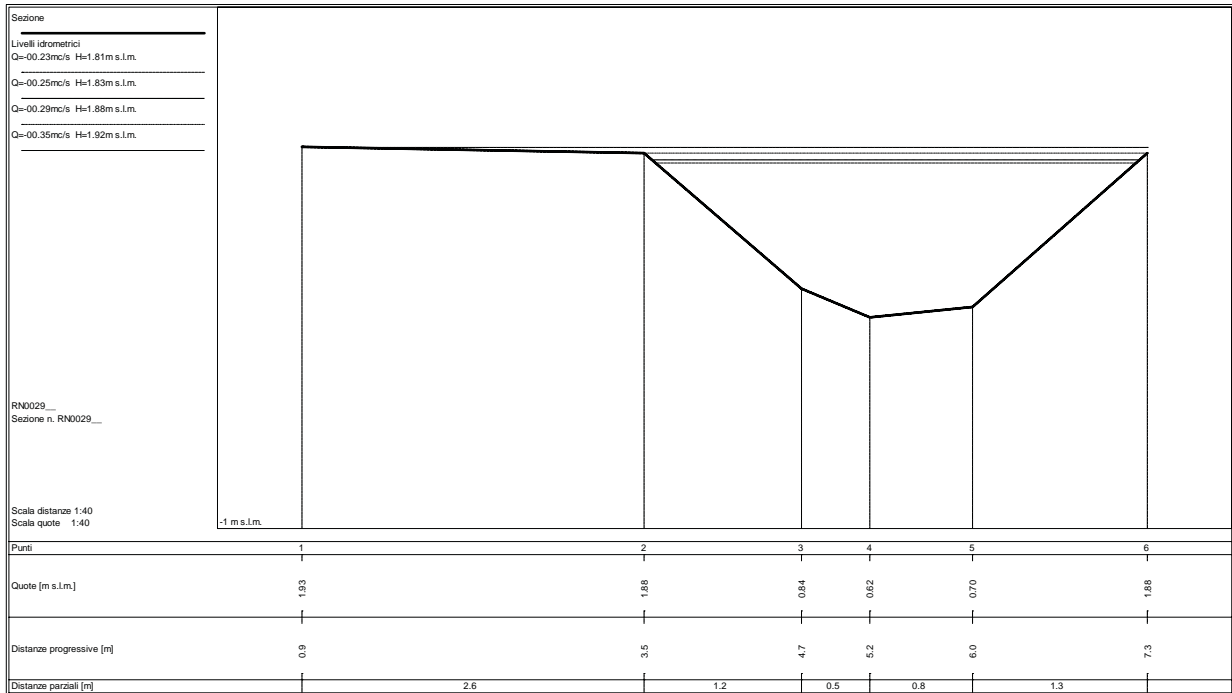

Sezione
 Ponte
 Livelli idrometrici
 Q=00.25mc/s H=1.81m s.l.m.
 Q=00.26mc/s H=1.83m s.l.m.
 Q=00.30mc/s H=1.88m s.l.m.
 Q=00.36mc/s H=1.93m s.l.m.

RN0030
 Sezione n. RN0030

Scala distanze 1:10
 Scala quote 1:40

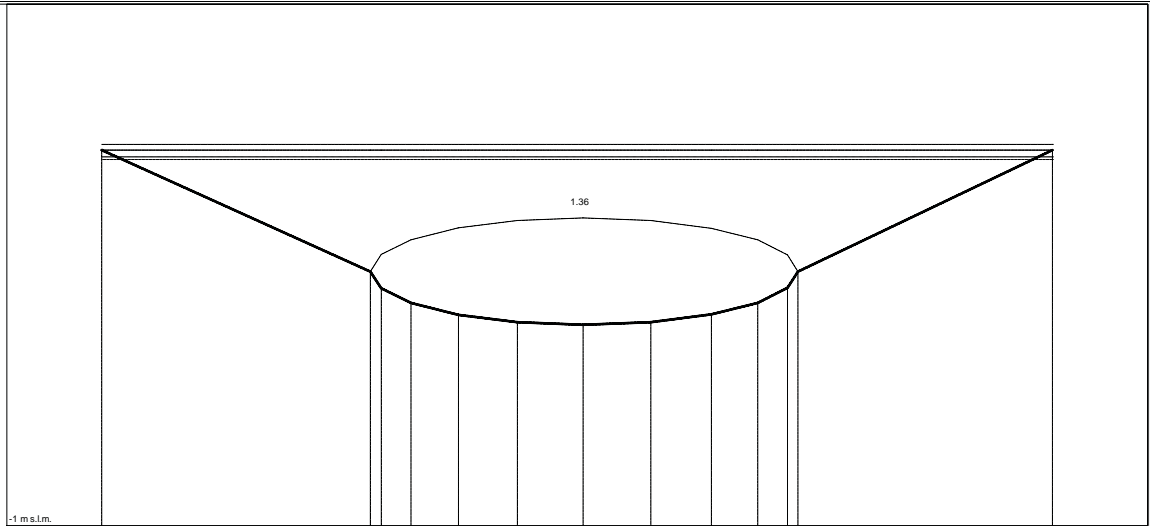

Punti	1	2	3	4	5	6	7	8	9	10	11	13
Quote [m s.l.m.]	1.88	0.85	0.82	0.71	0.62	0.56	0.54	0.56	0.62	0.71	0.83	1.88
Distanze progressive [m]	3.9	4.4	4.4	4.5	4.6	4.7	4.8	5.0	5.1	5.2	5.2	5.7
Distanze parziali [m]		0.5	0.1	0.1	0.1	0.1	0.1	0.1	0.1	0.1	0.1	0.5

Sezione
 Ponte
 Livelli idrometrici
 Q=00.28mc/s H=1.81m s.l.m.
 Q=00.28mc/s H=1.83m s.l.m.
 Q=00.33mc/s H=1.88m s.l.m.
 Q=00.37mc/s H=1.93m s.l.m.

RN0031
 Sezione n. RN0031

Scala distanze 1:20
 Scala quote 1:40

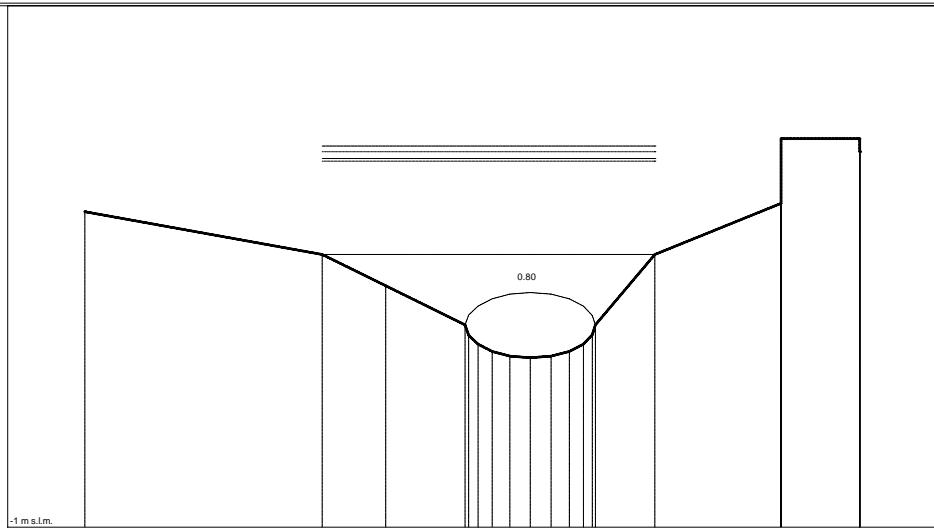

Punti	1	2	3	4	5	6	7	8	9	10	11	12	15	16	18
Quote [m s.l.m.]	1.42	1.09	0.85	0.55	0.40	0.40	0.35	0.31	0.30	0.31	0.35	0.40	1.09	1.49	1.98
Distanze progressive [m]	0.9	1.8	2.0	2.3	2.4	2.4	2.5	2.6	2.6	2.7	2.7	2.8	3.0	3.5	3.8
Distanze parziali [m]		0.9	0.2	0.3	0.1	0.1	0.1	0.1	0.1	0.1	0.1	0.1	0.2	0.5	0.3

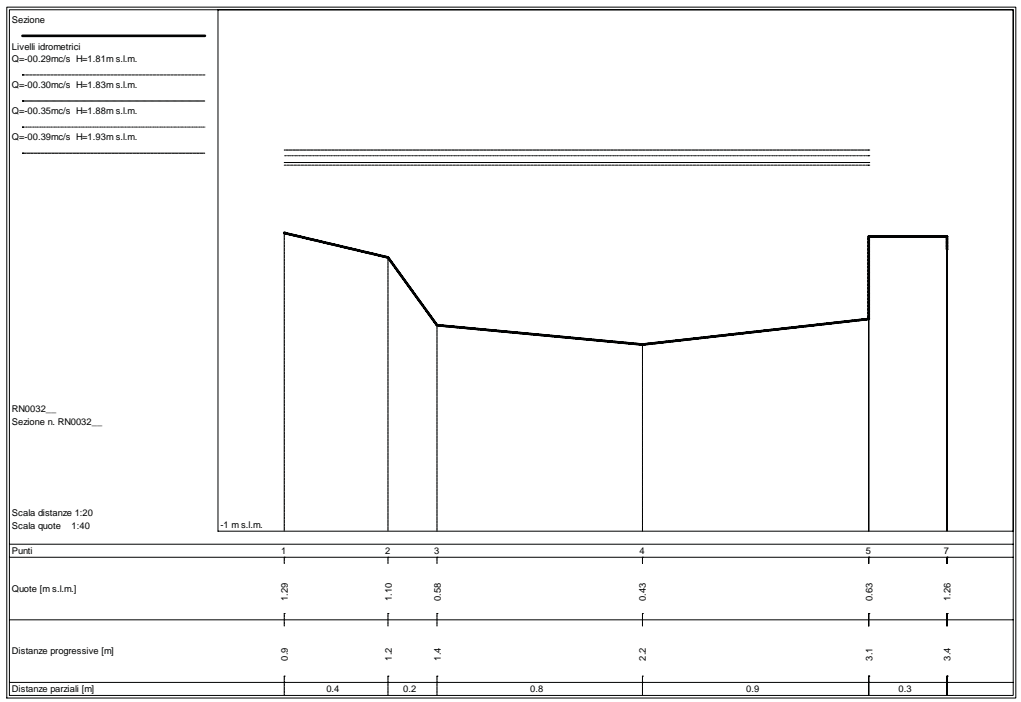
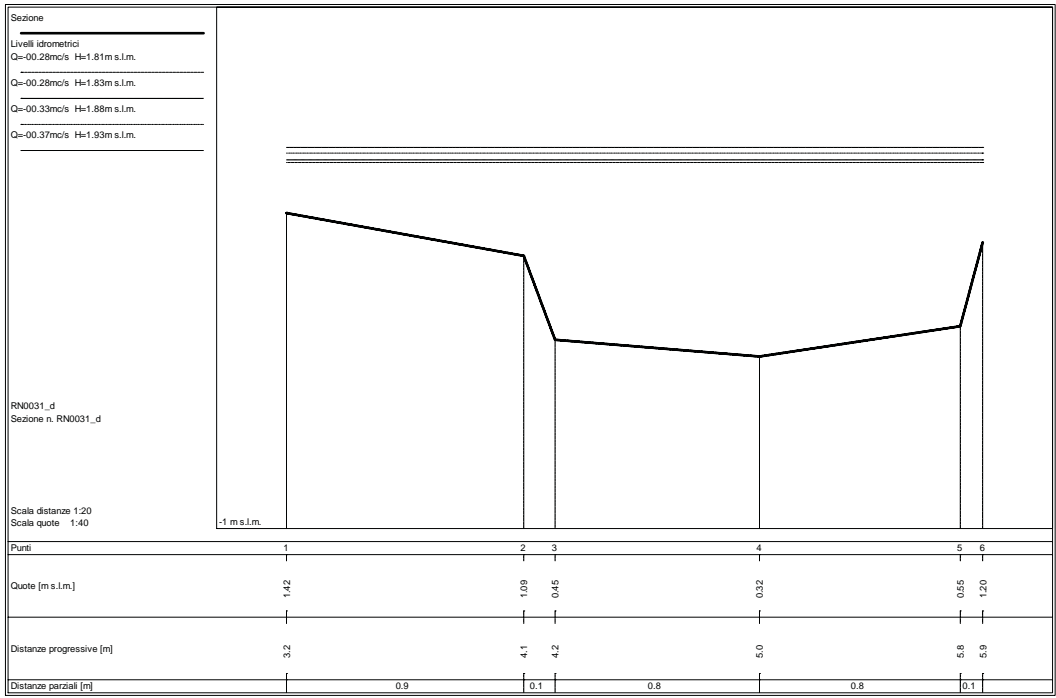

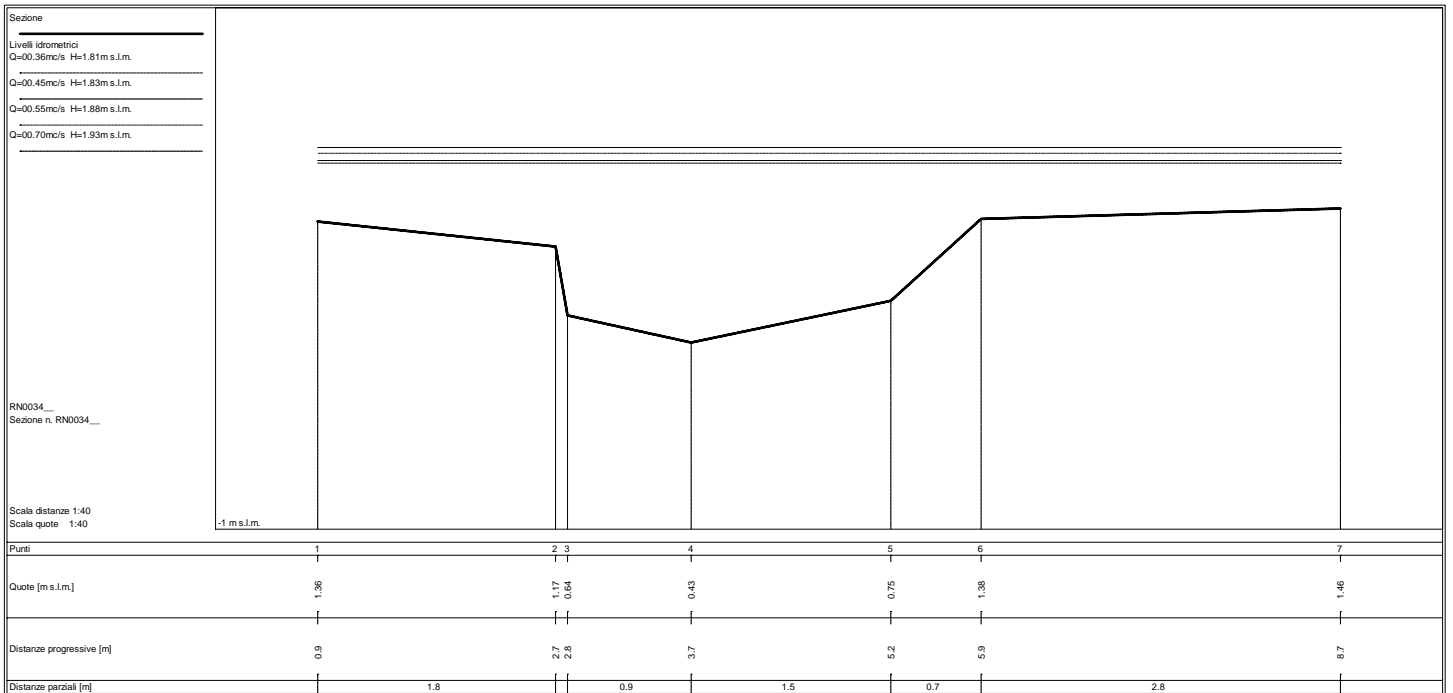
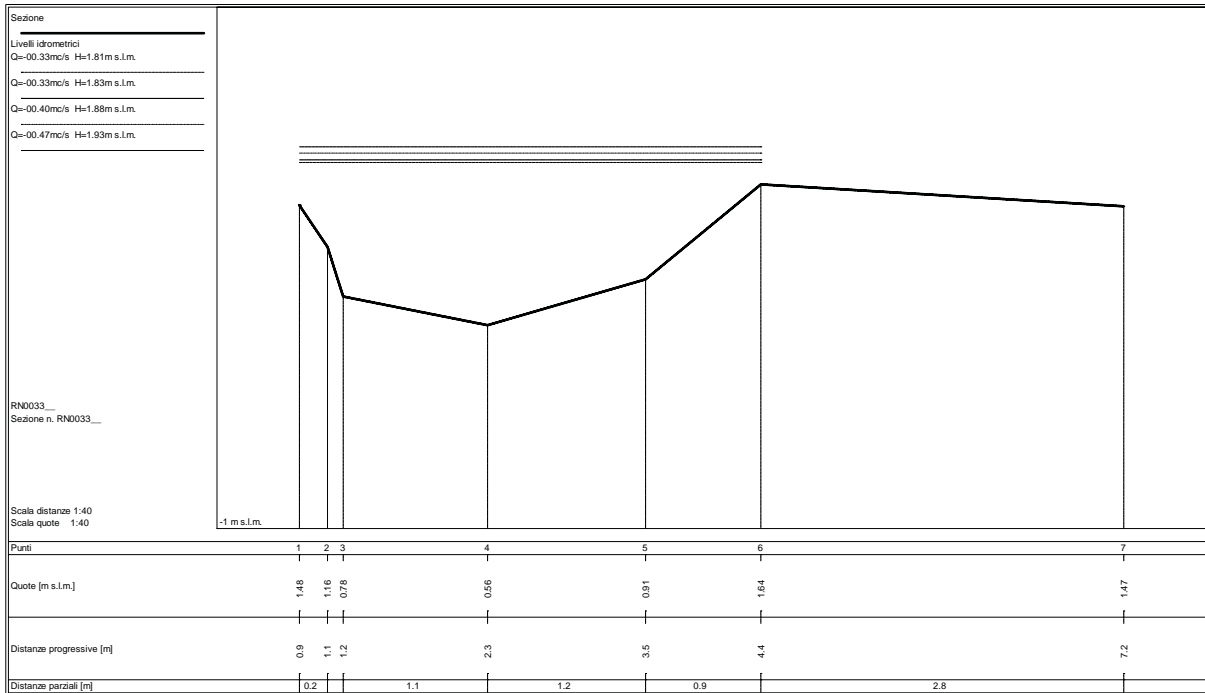

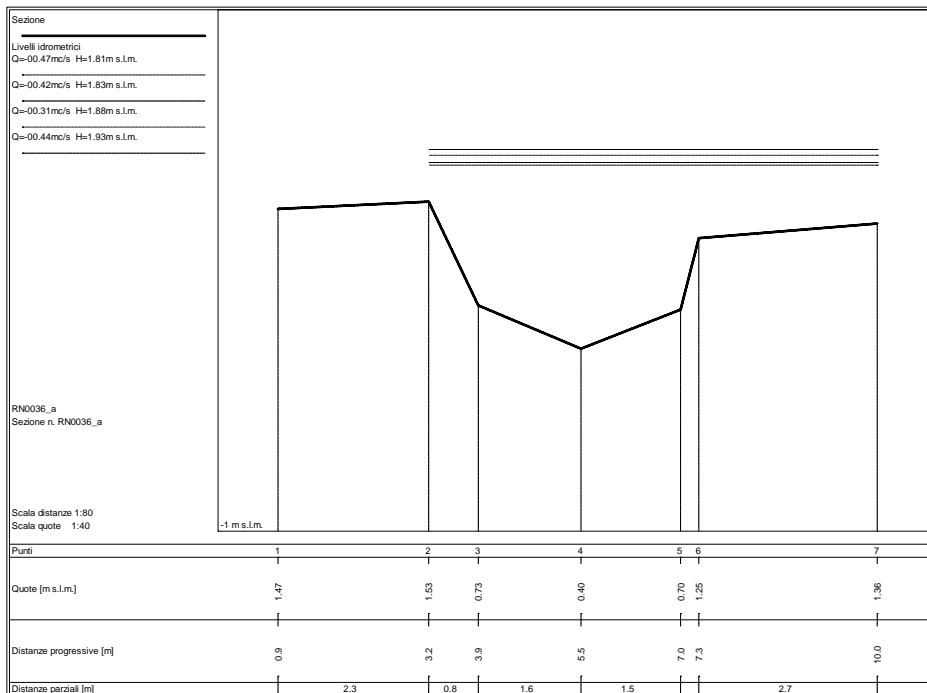
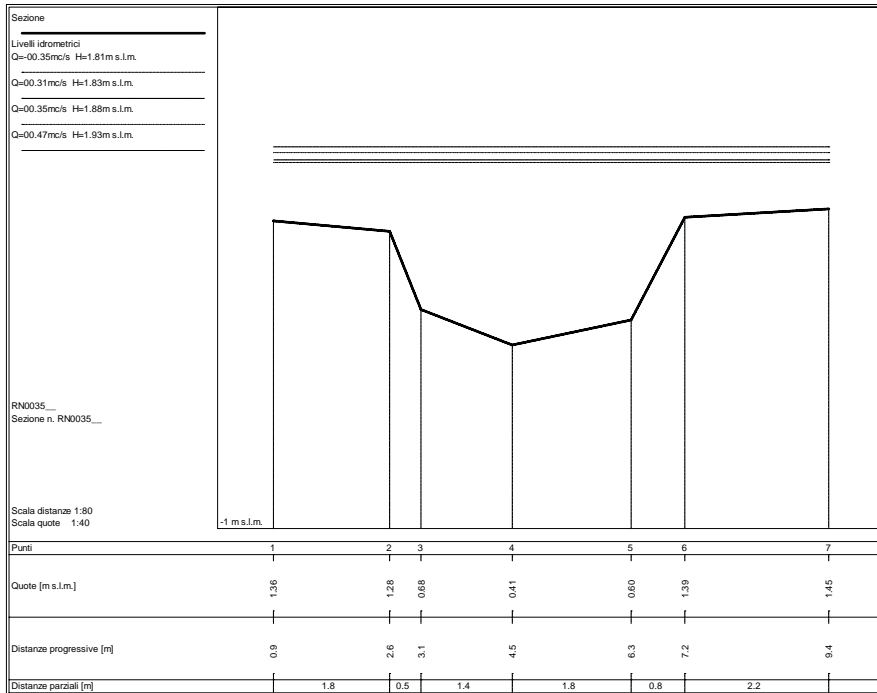

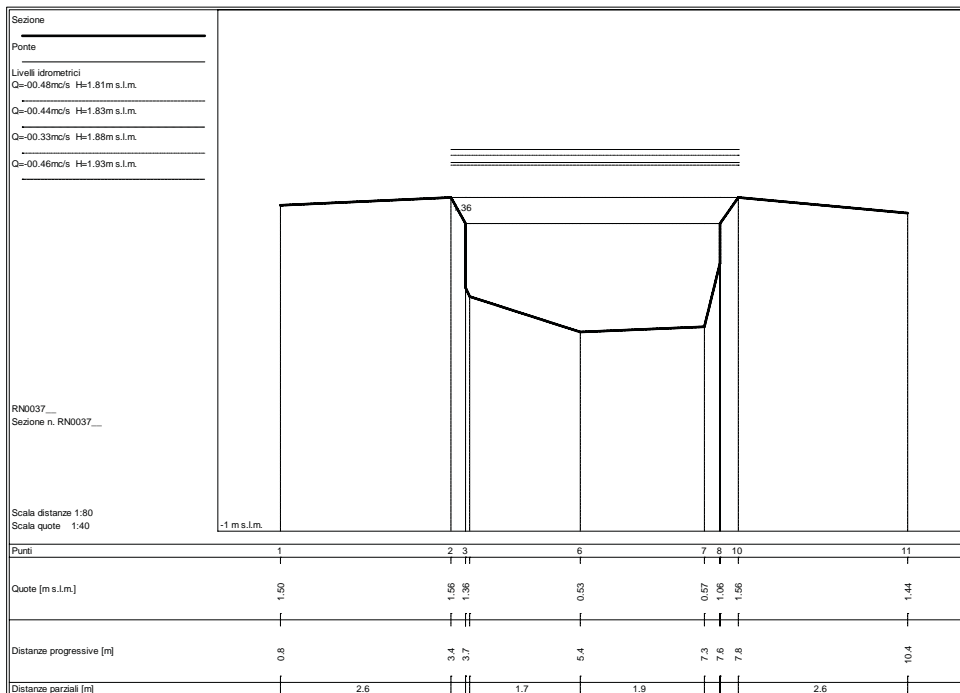
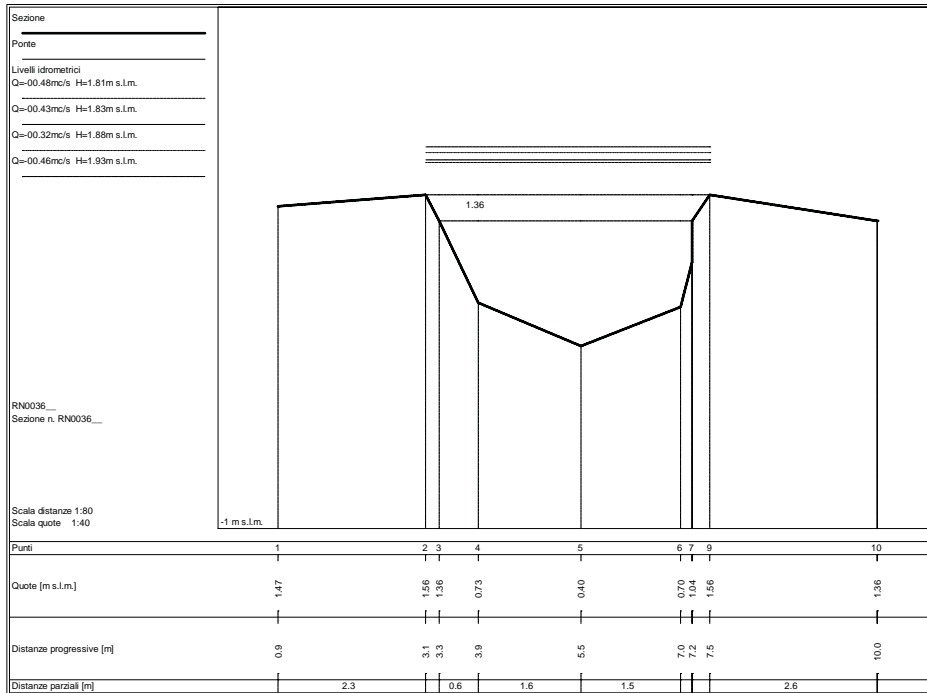

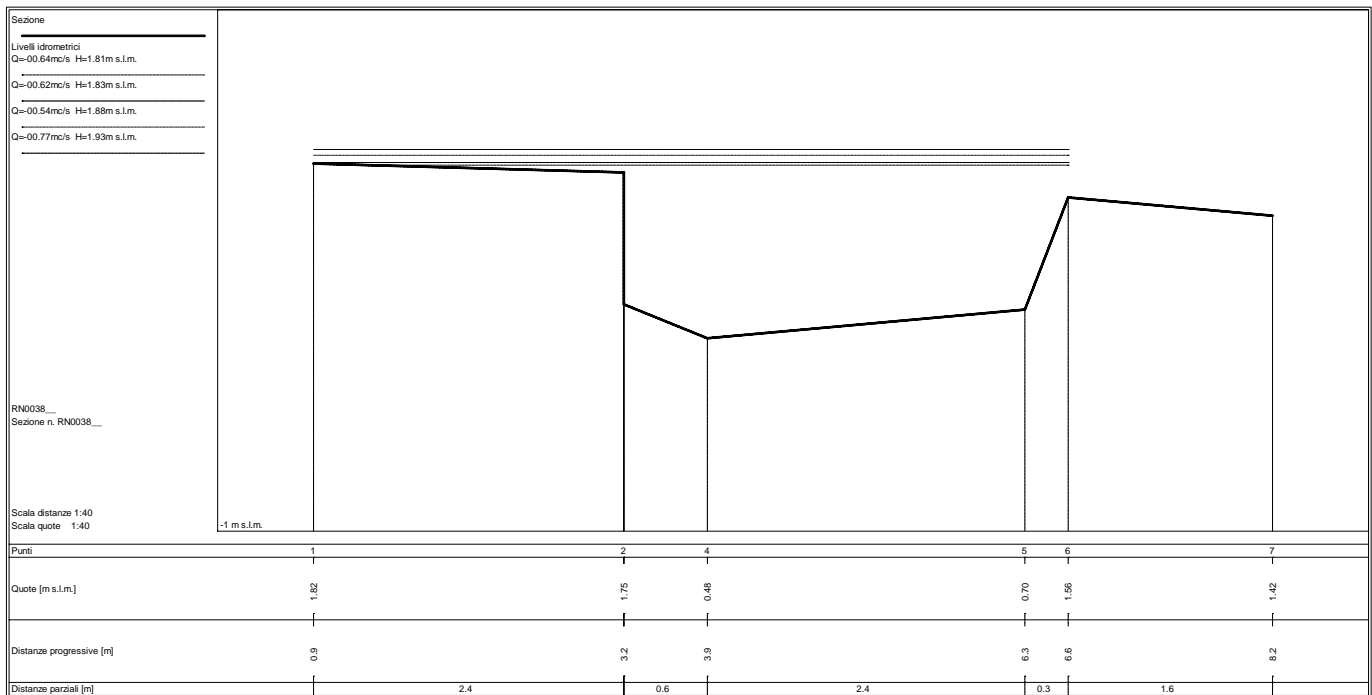
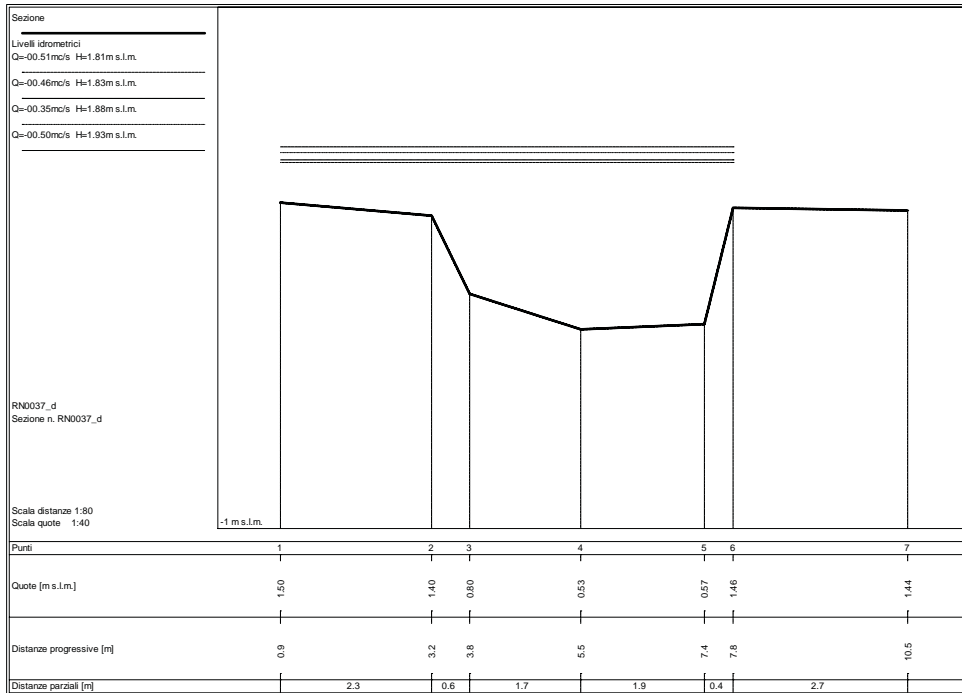

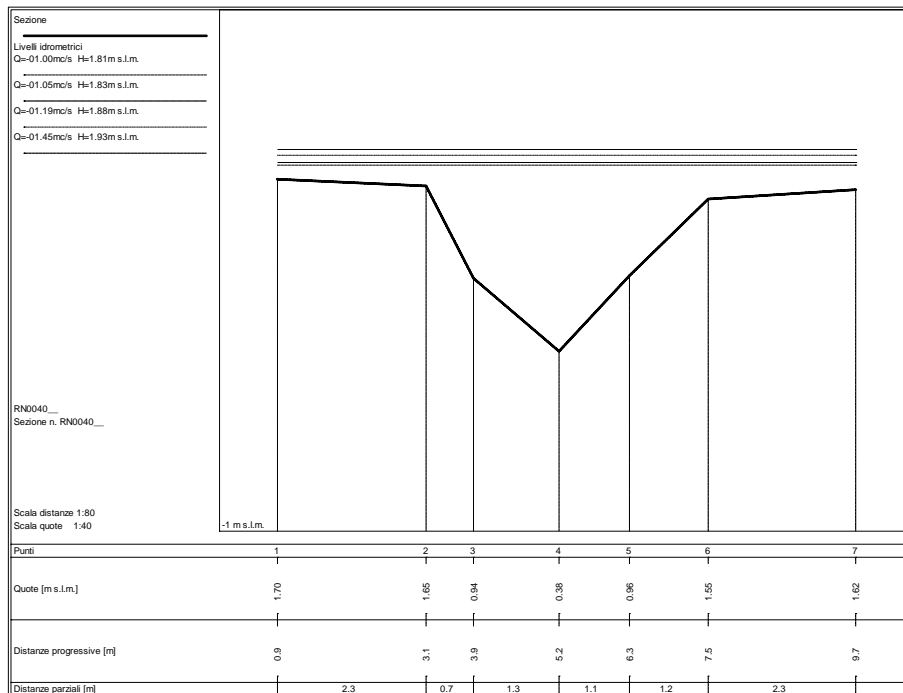
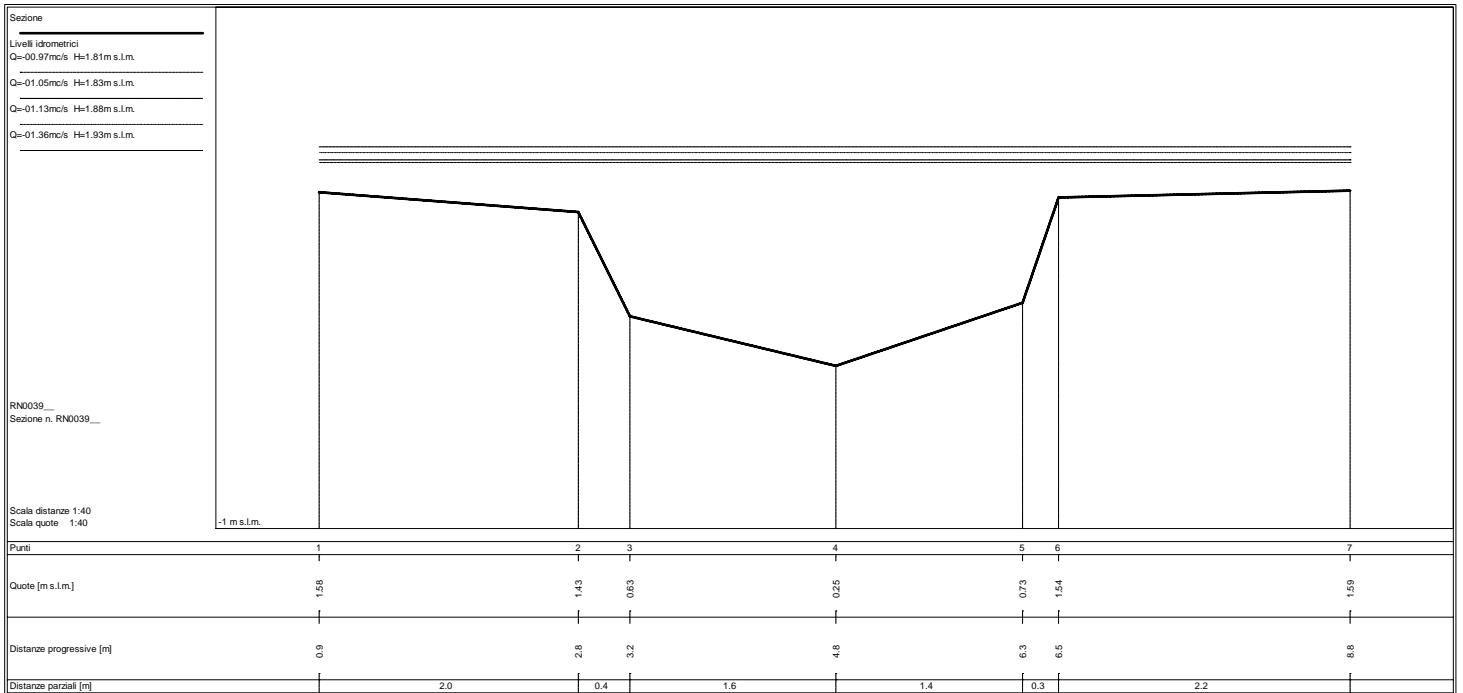

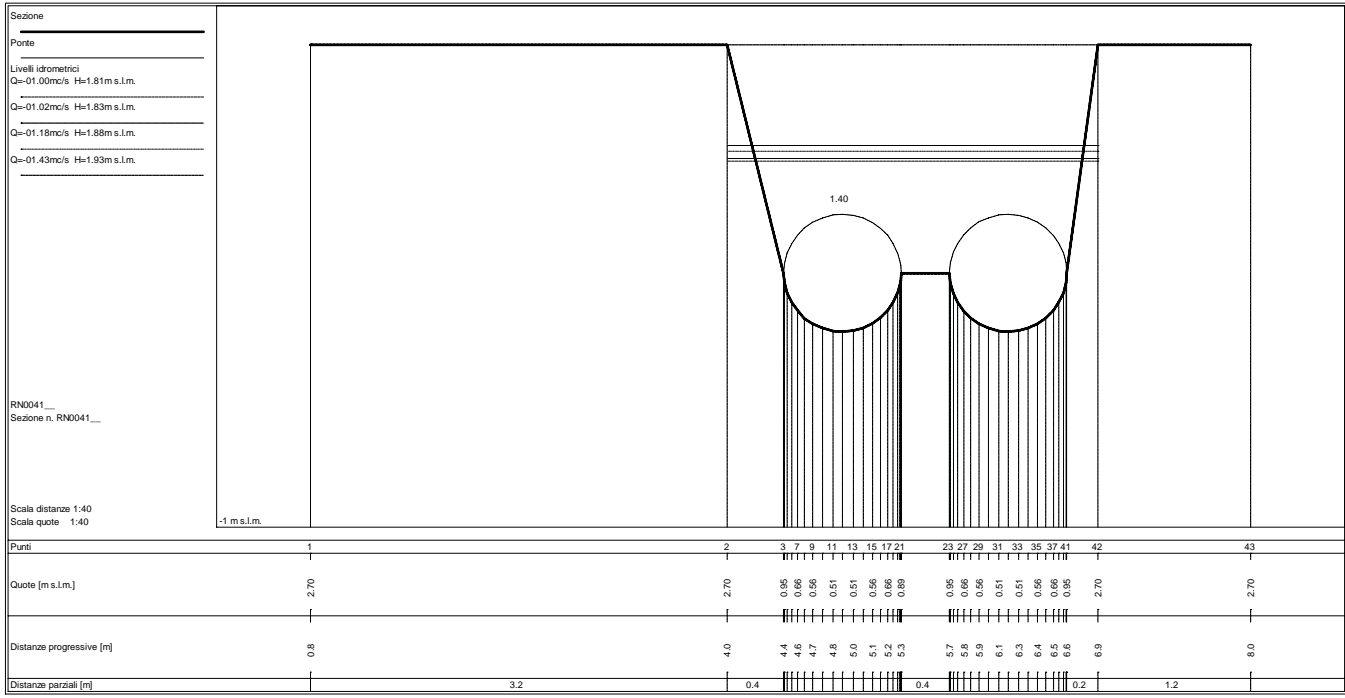
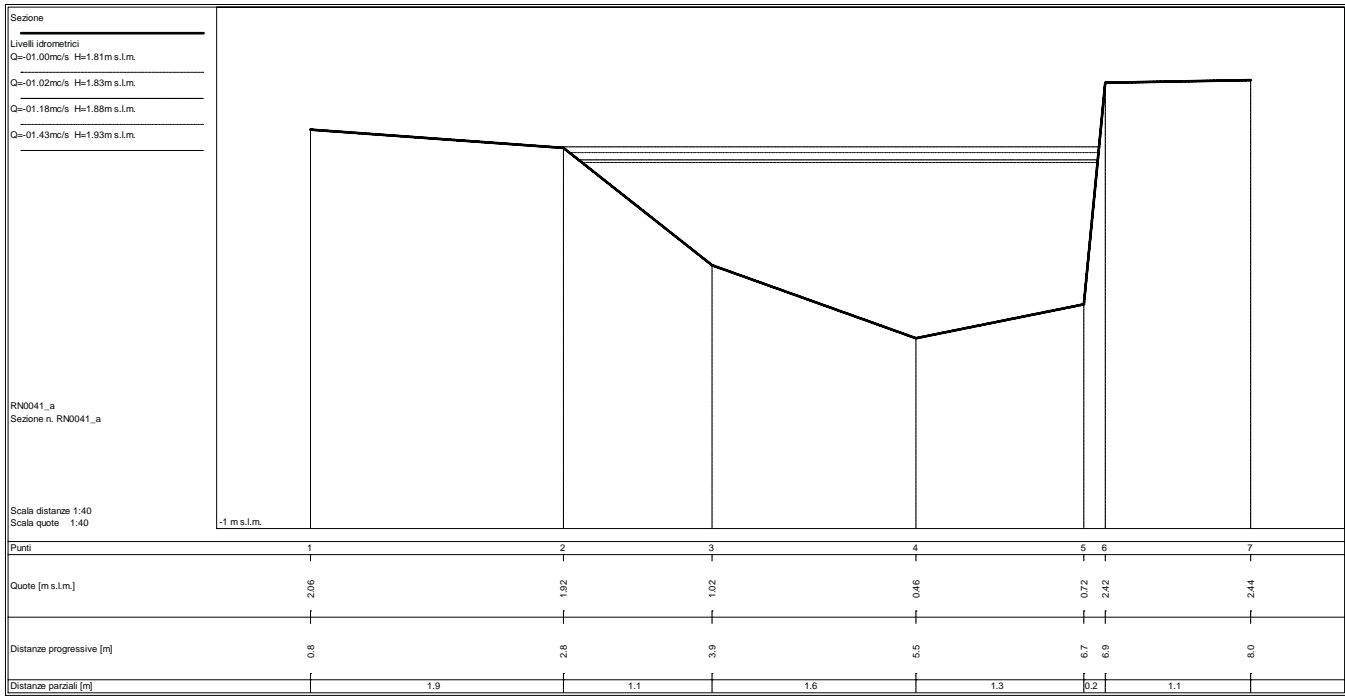

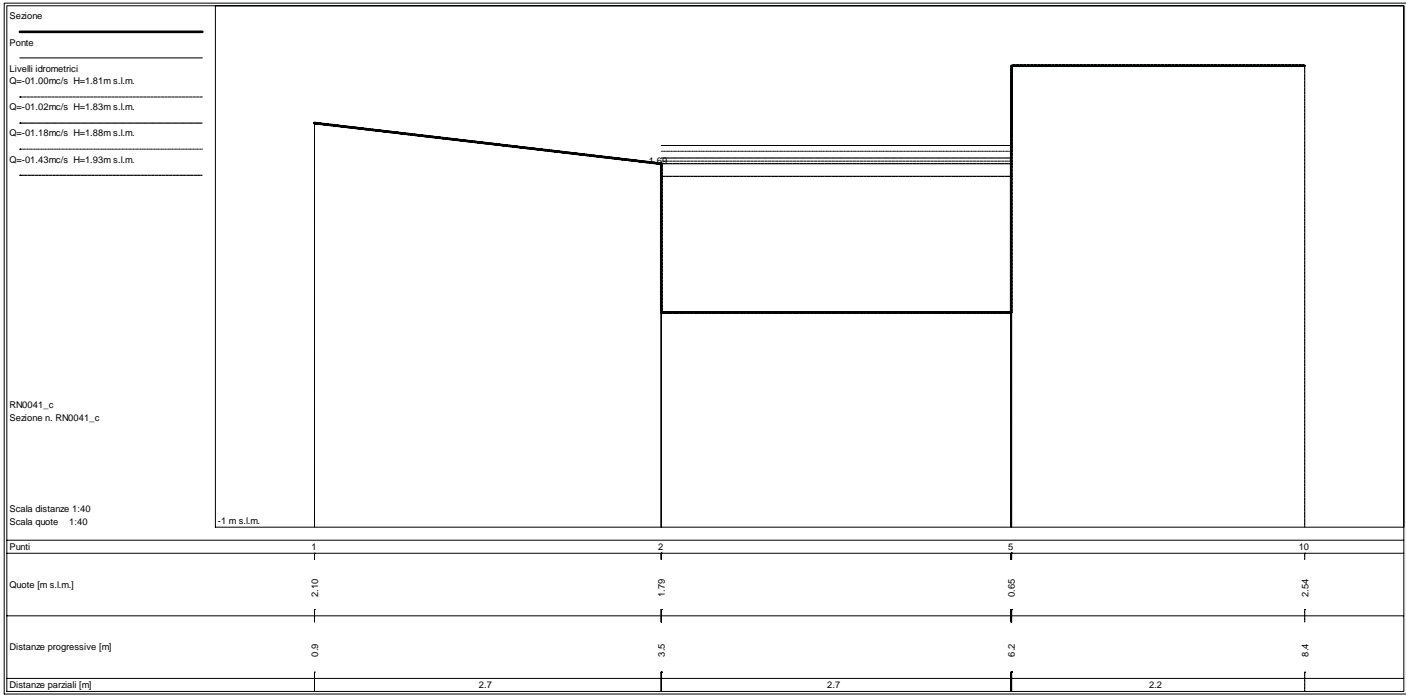
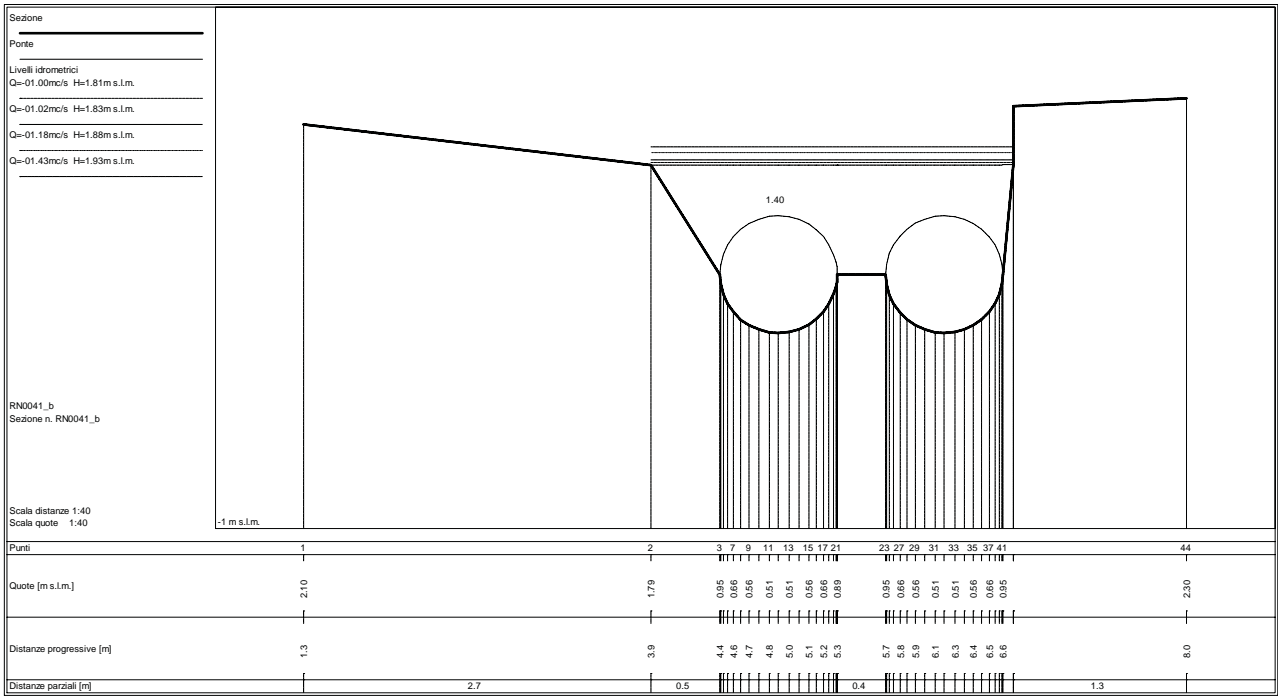

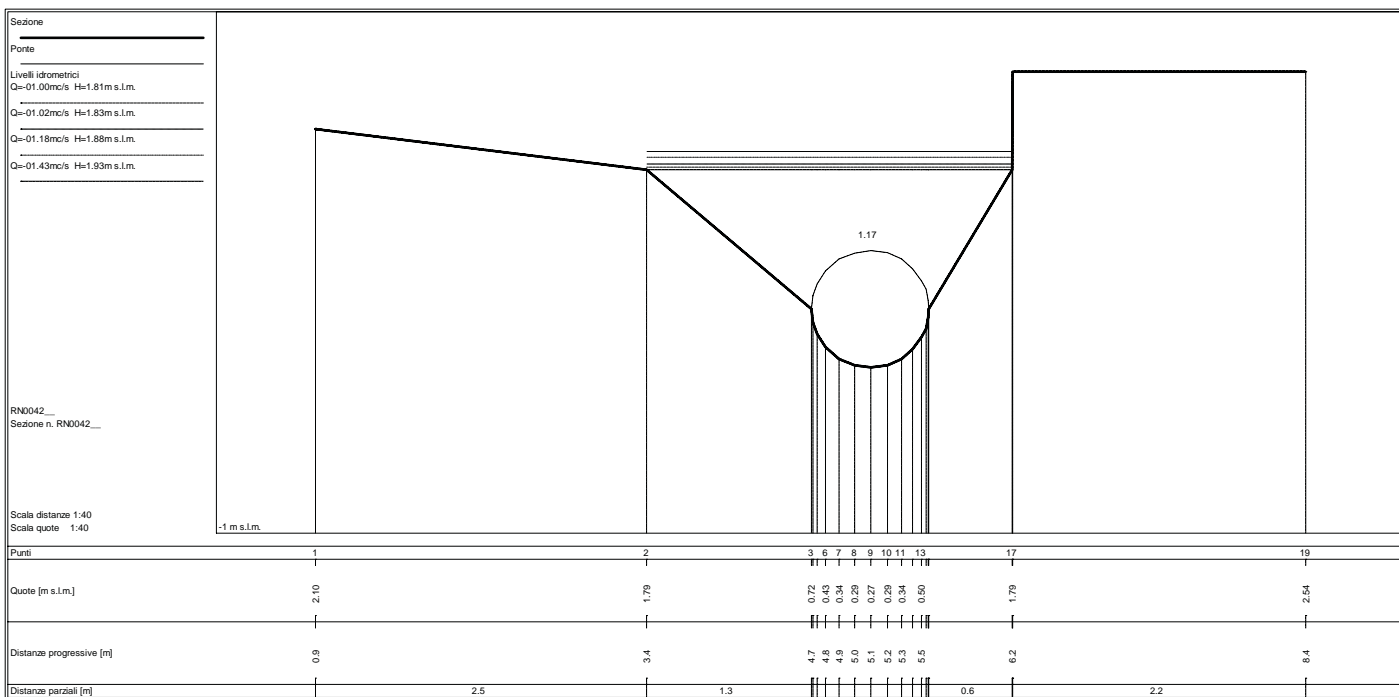
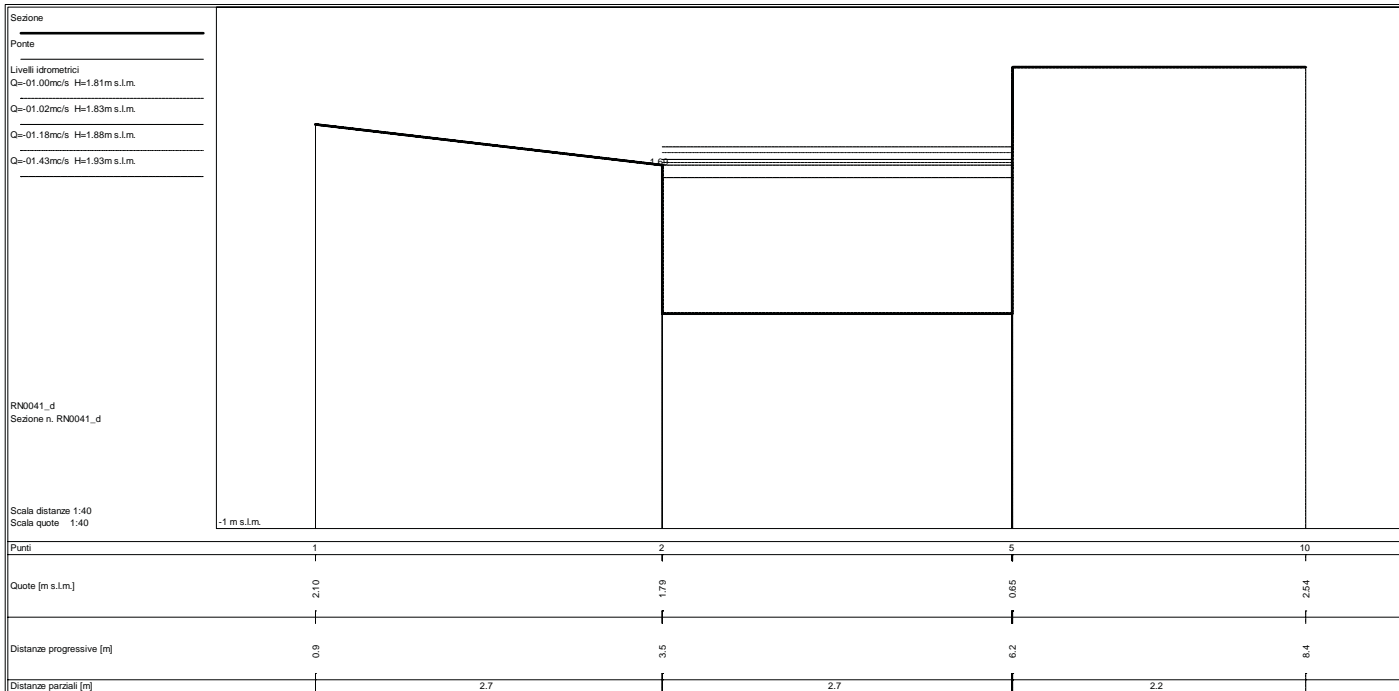

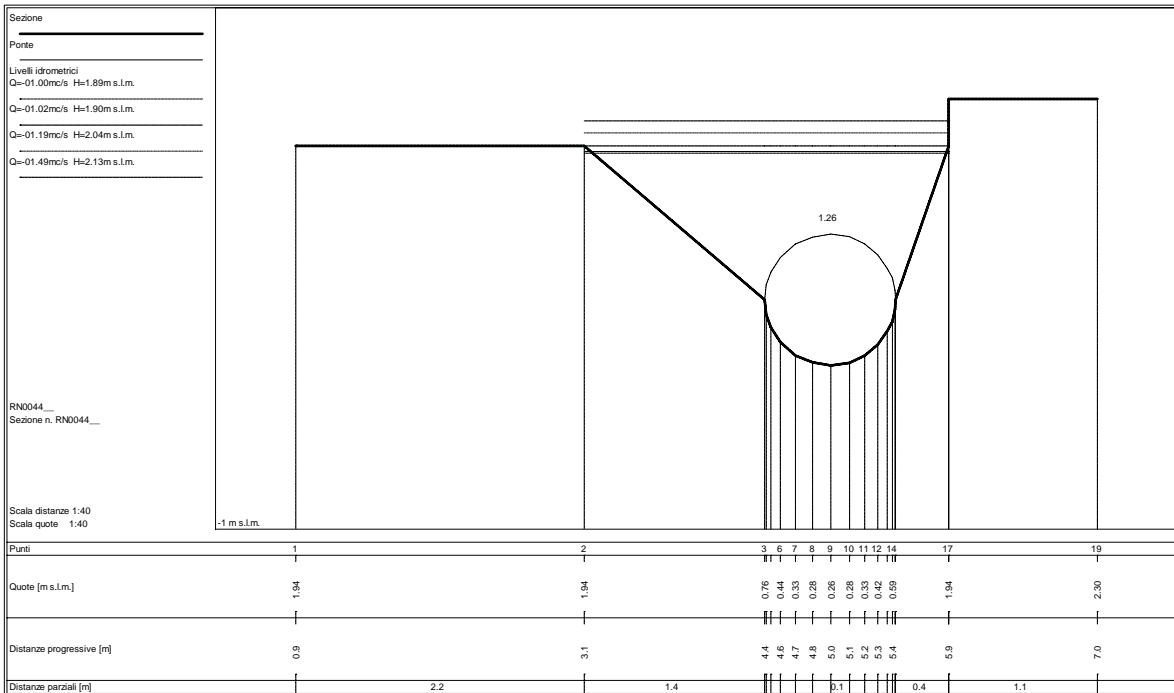
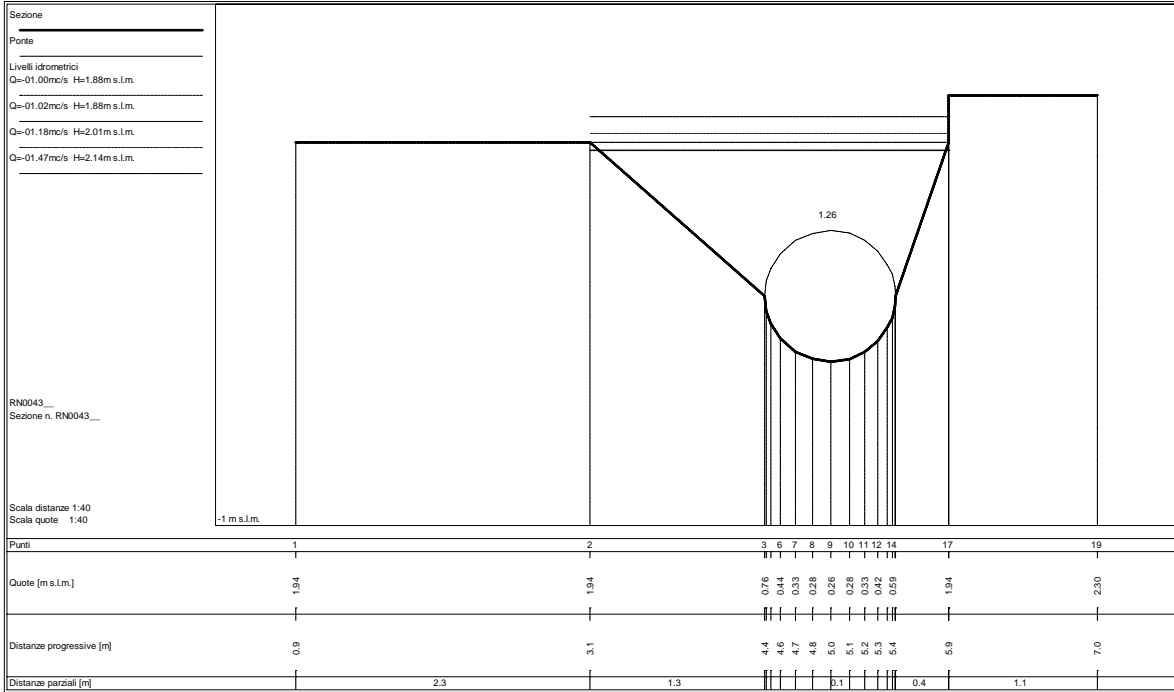

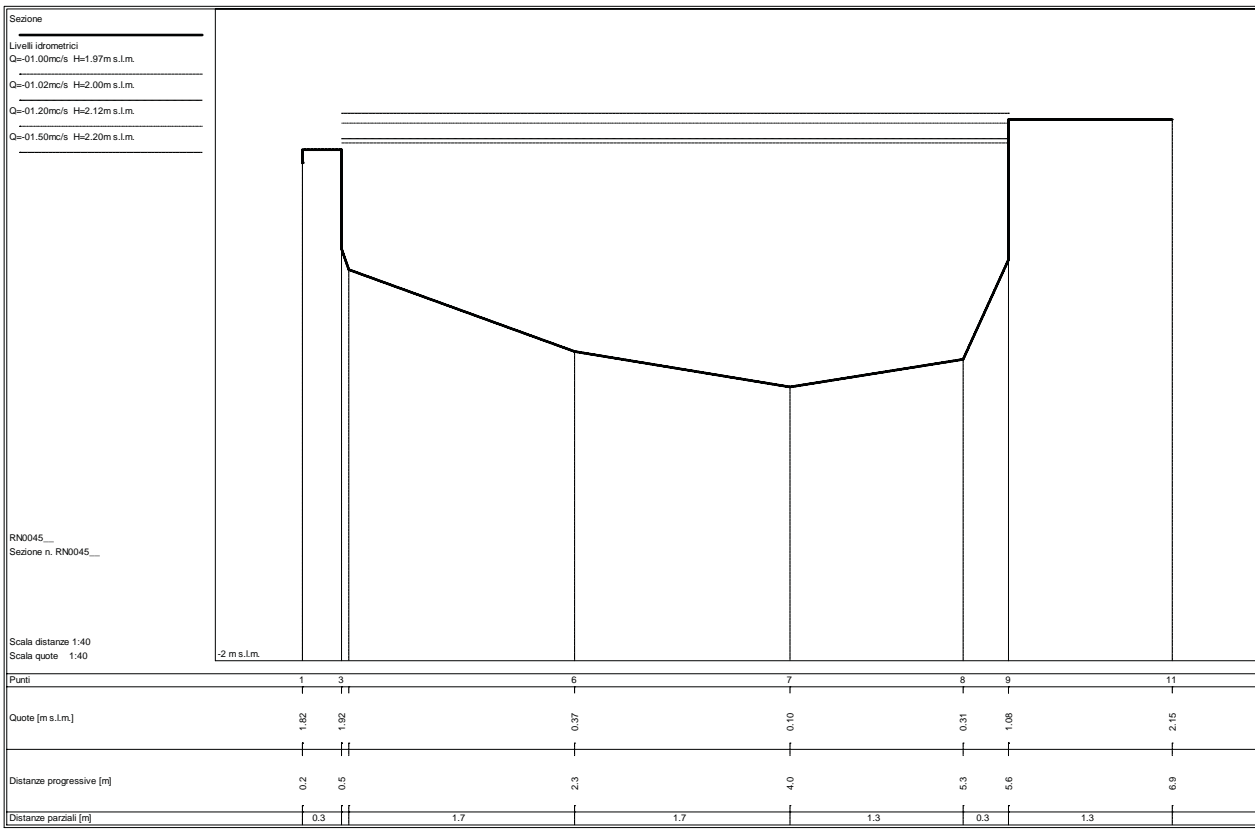

STATO ATTUALE
Sezioni fluviali fosso Loghi

Sezione

 Livelli idrometrici
 Q=04.32mc/s H=2.69m s.l.m.

 Q=04.43mc/s H=2.71m s.l.m.

 Q=08.74mc/s H=2.80m s.l.m.

 Q=05.13mc/s H=3.00m s.l.m.

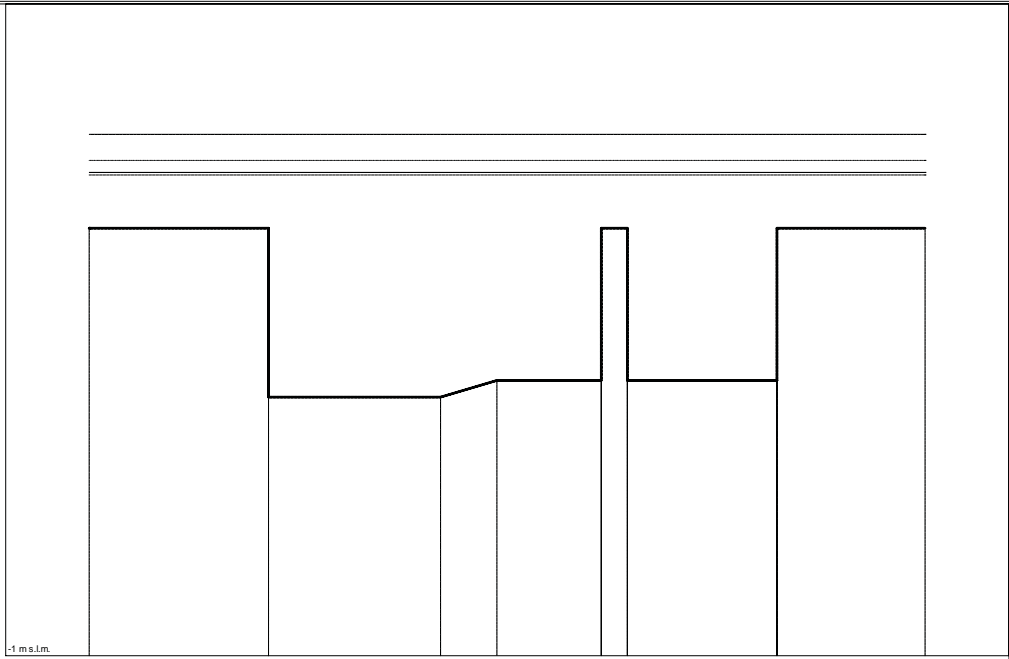

GR0019A_
 Sezione n. GR0019A_

Scala distanze 1:40
 Scala quote 1:40

Punti	1	2	4	5	6	8	10	12
Quote [m s.l.m.]	2.28	2.28	0.98	1.11	1.11	2.28	1.11	2.28
Distanze progressive [m]	-2.3	-0.9	0.4	0.8	1.6	1.8	3.0	4.1
Distanze parziali [m]		1.4	1.3	0.4	0.8	0.2	1.2	1.1

Sezione

 Livelli idrometrici
 Q=04.32mc/s H=2.69m s.l.m.

 Q=04.43mc/s H=2.71m s.l.m.

 Q=08.74mc/s H=2.80m s.l.m.

 Q=05.12mc/s H=3.00m s.l.m.

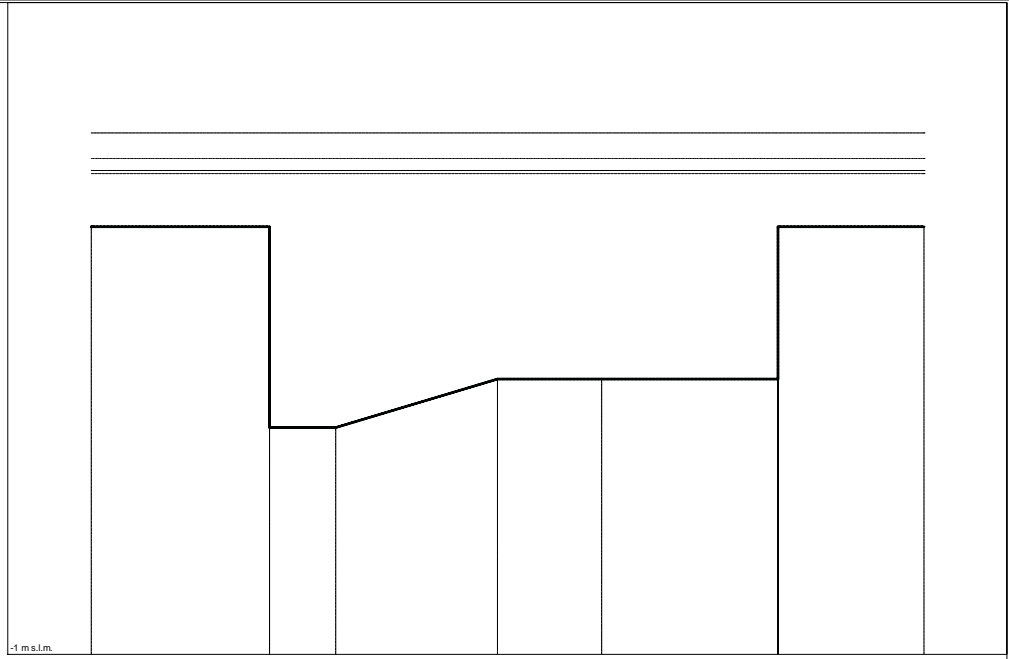

GR0019B_
 Sezione n. GR0019B_

Scala distanze 1:40
 Scala quote 1:40

Punti	1	2	4	5	6	7	9
Quote [m s.l.m.]	2.28	2.28	0.74	1.11	1.11	1.11	2.28
Distanze progressive [m]	-2.3	-0.9	-0.4	0.8	1.6	3.0	4.1
Distanze parziali [m]		1.4	0.5	1.2	0.8	1.4	1.1

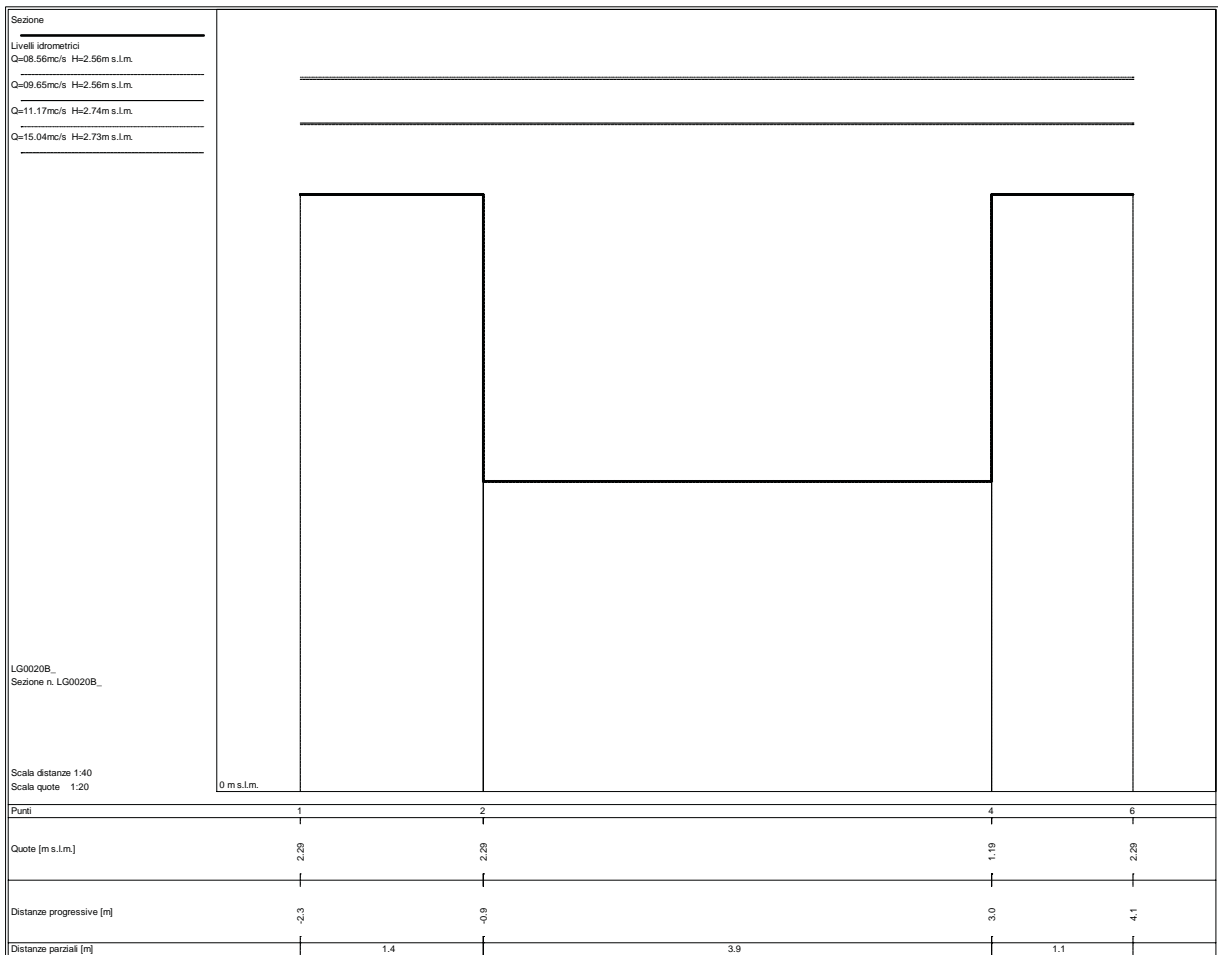
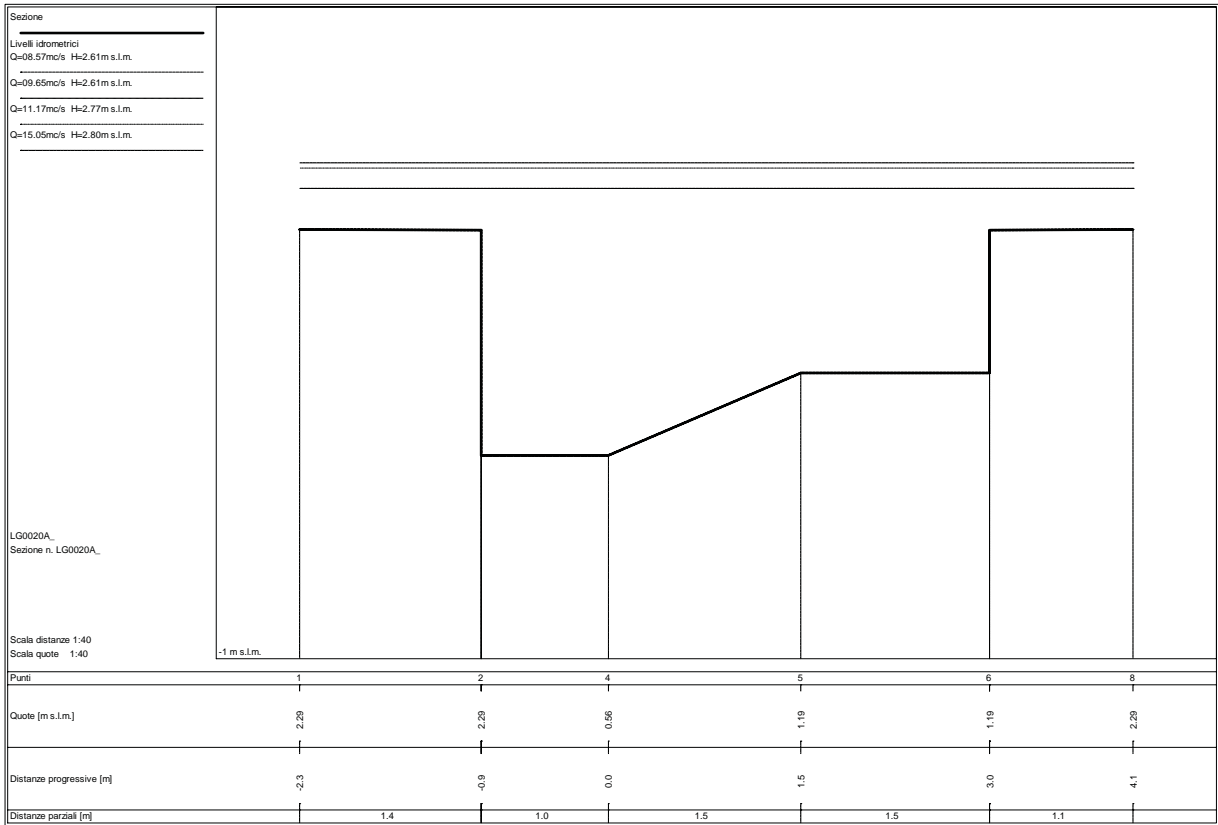

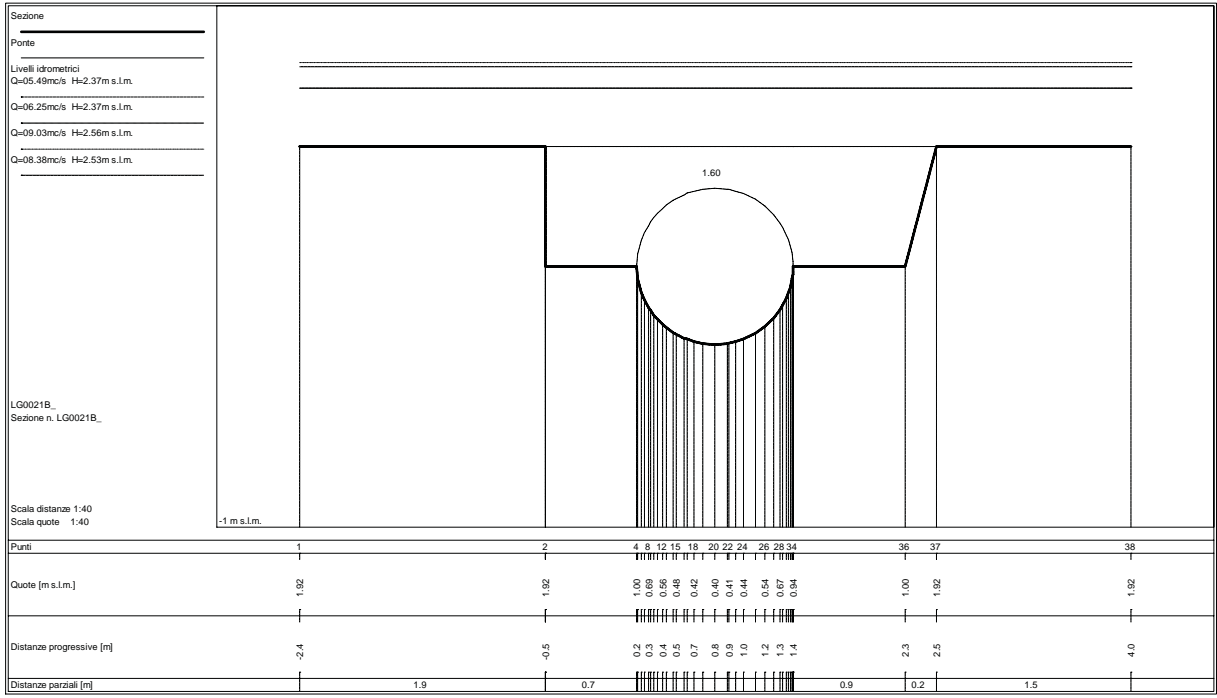
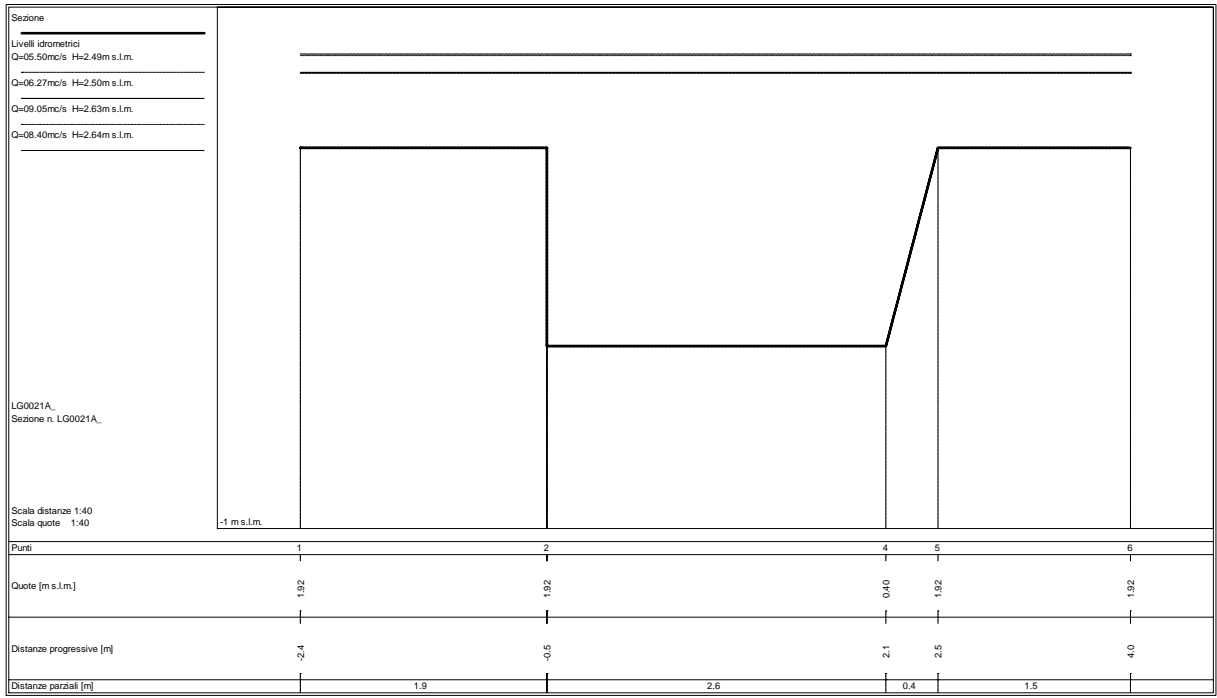

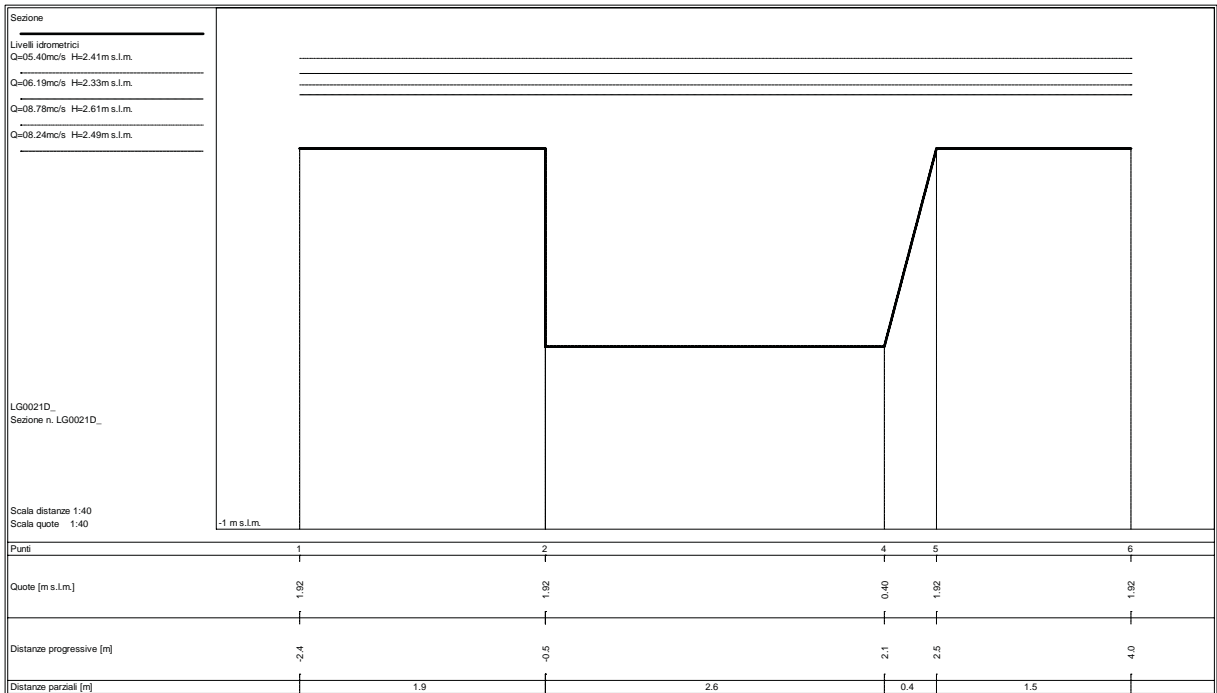
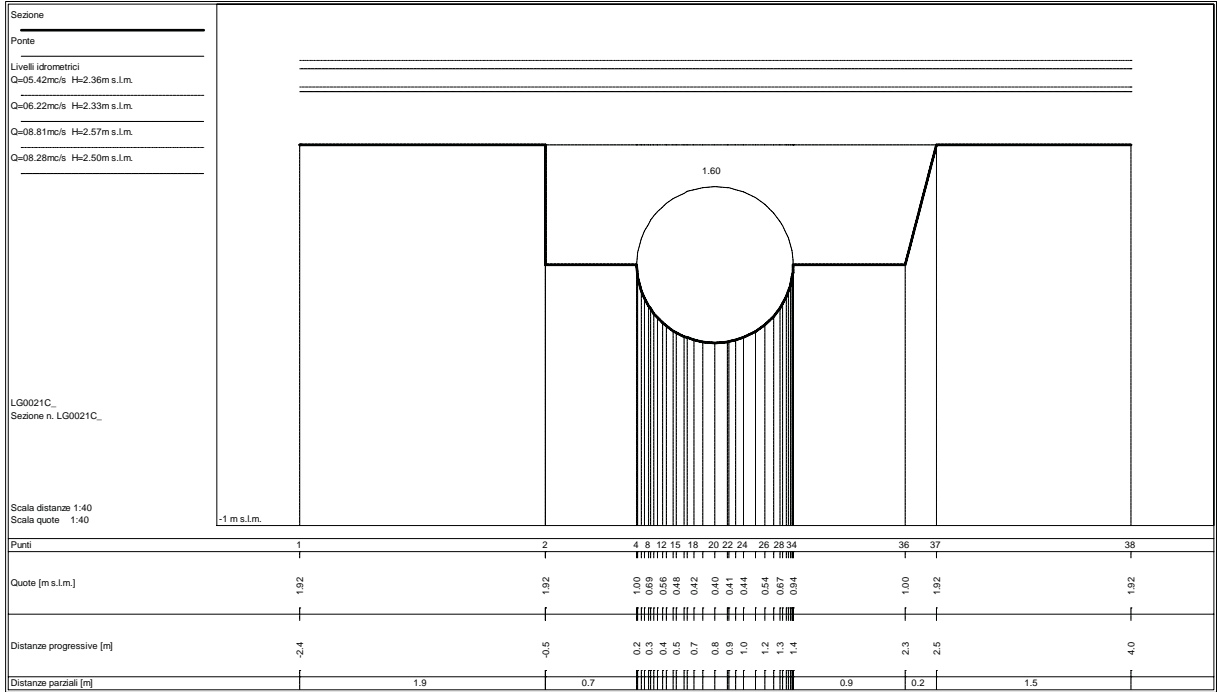

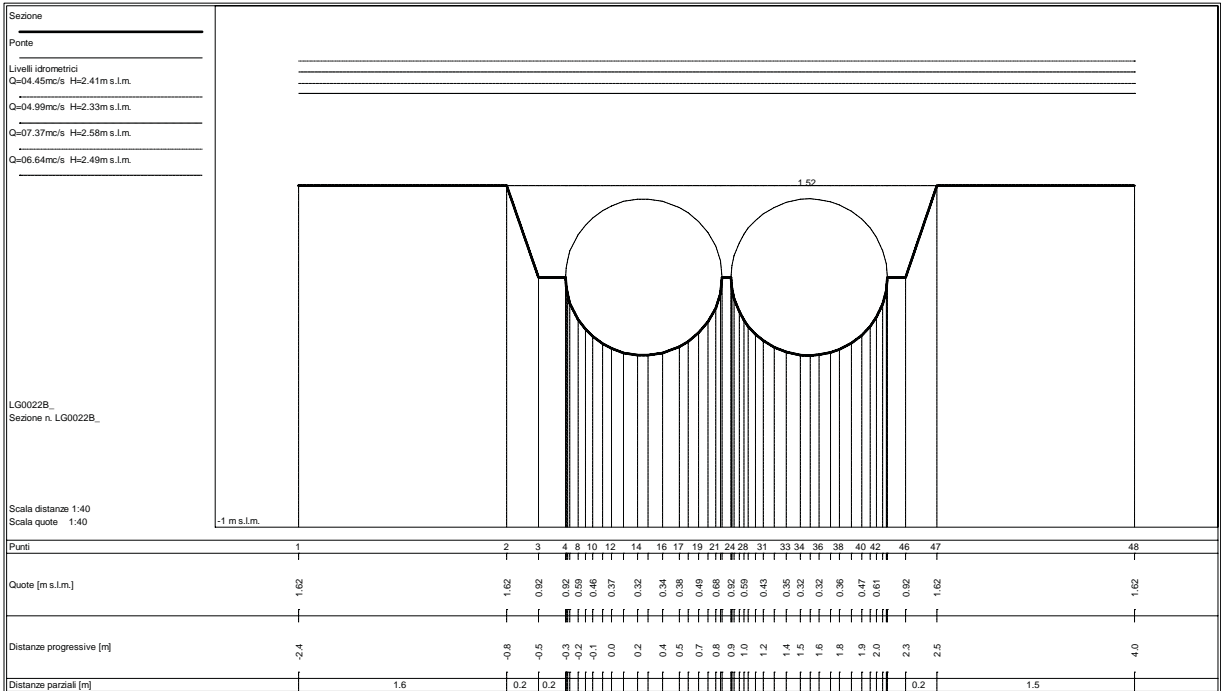
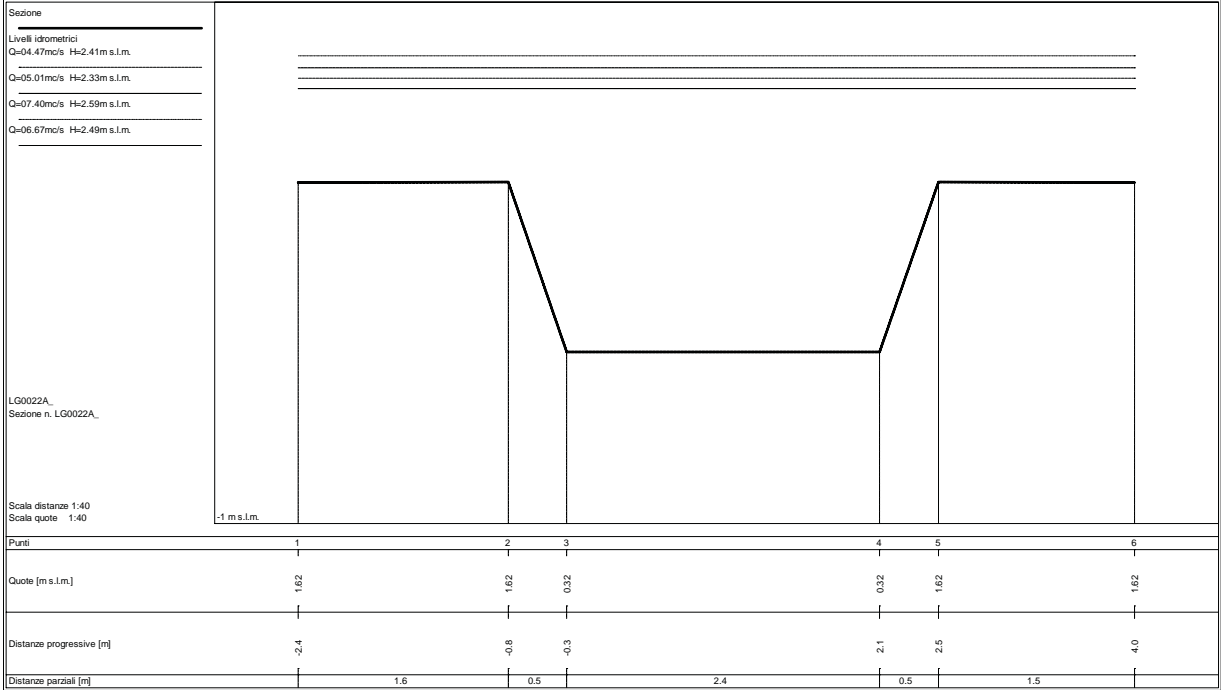

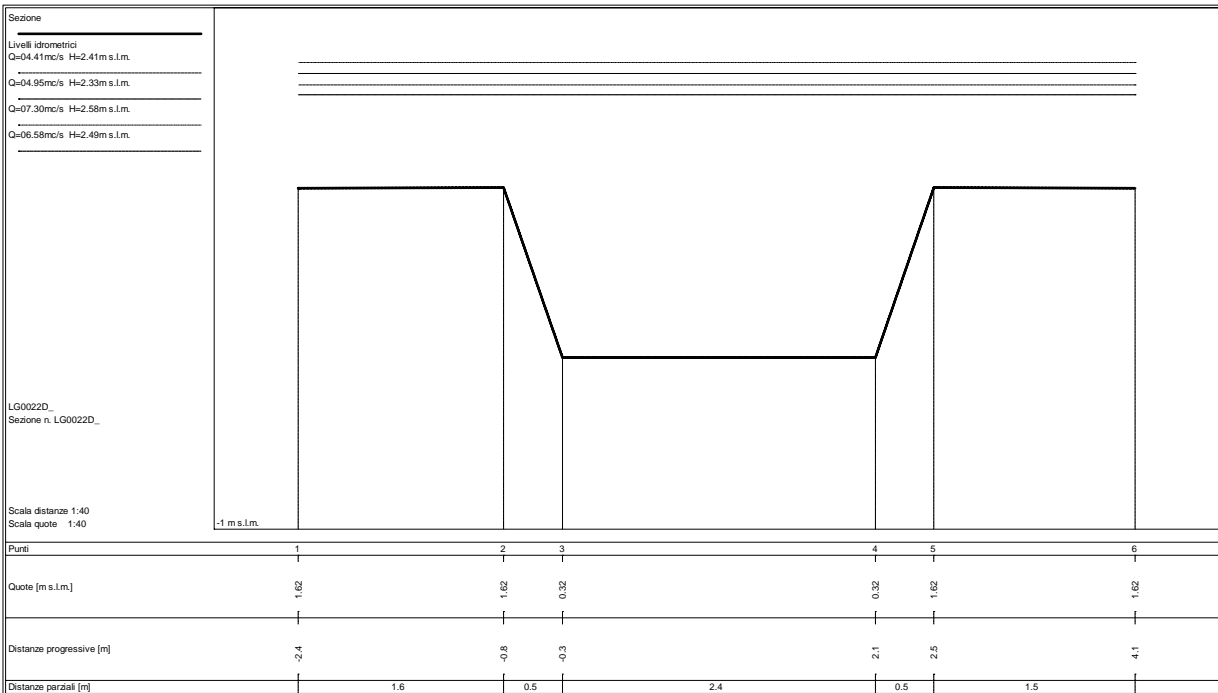
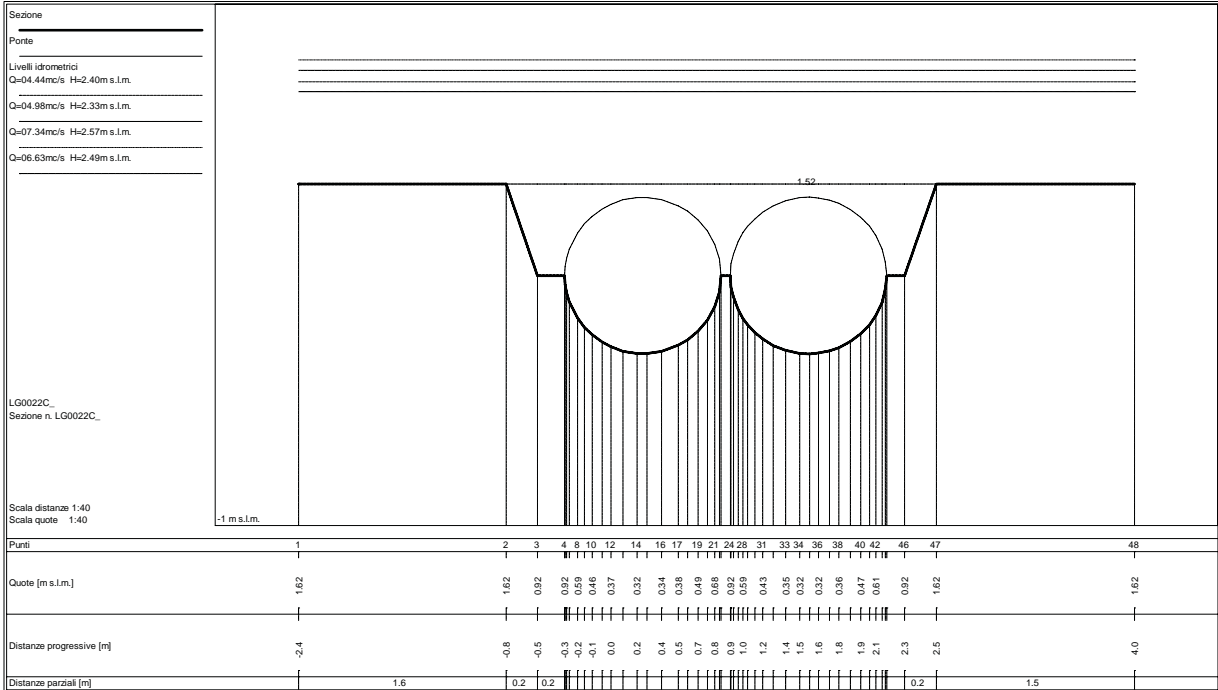

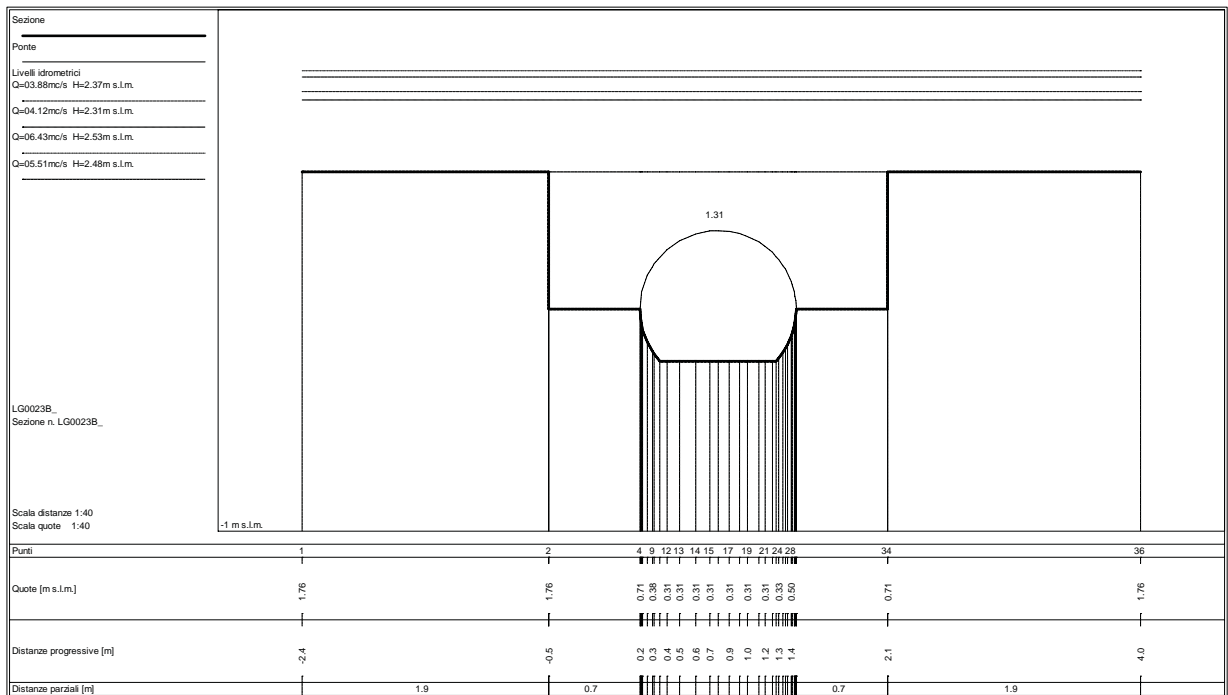
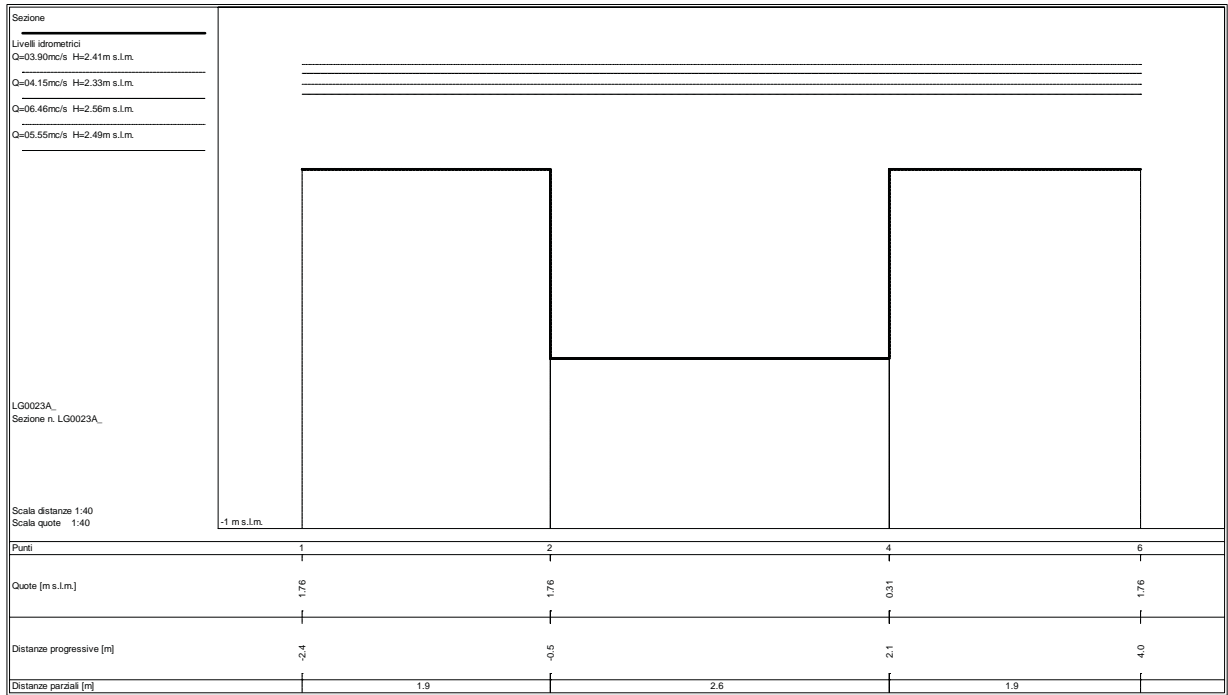

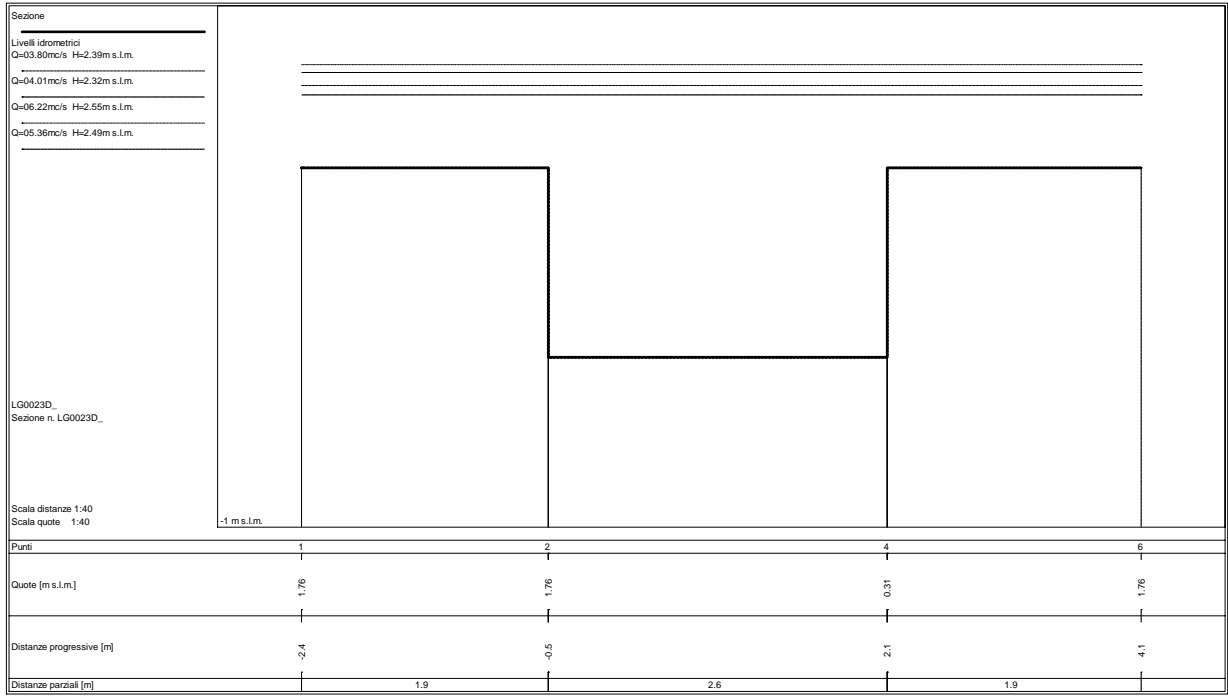
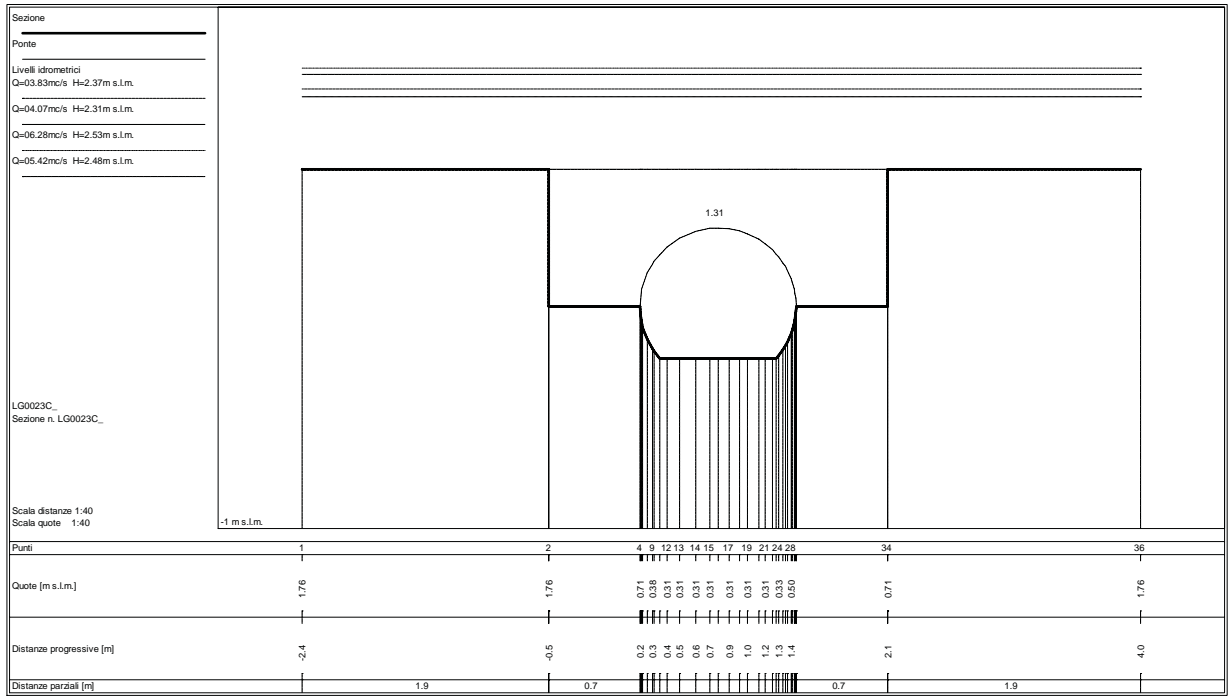

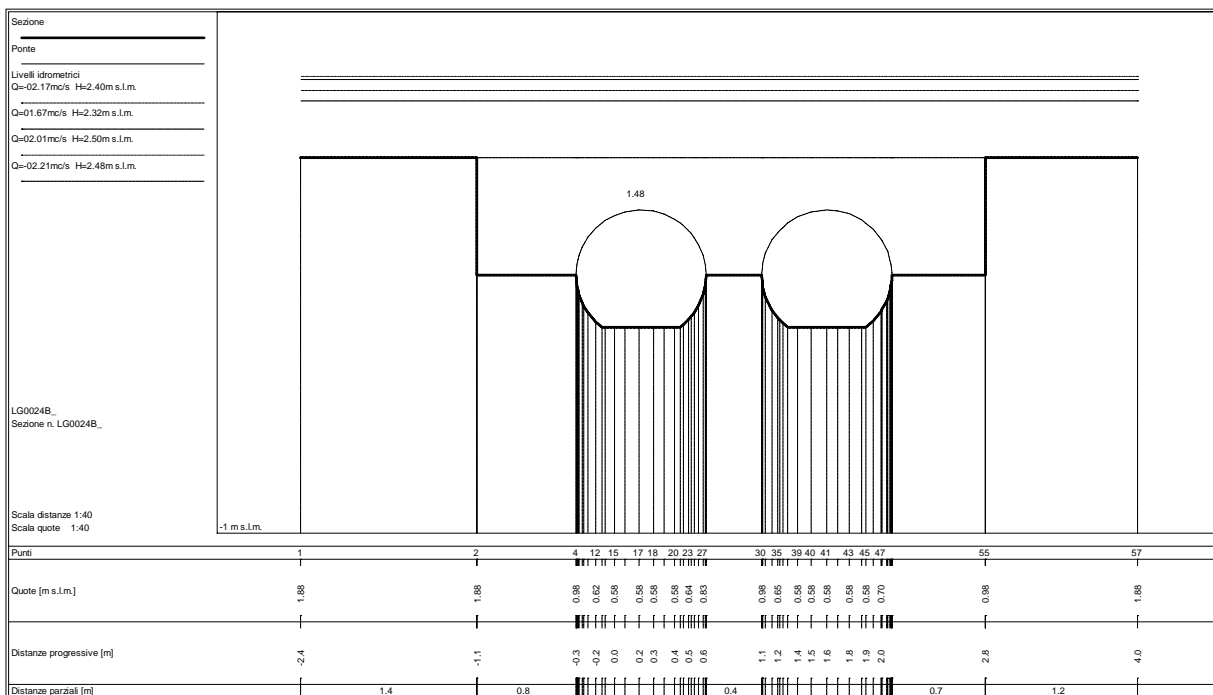
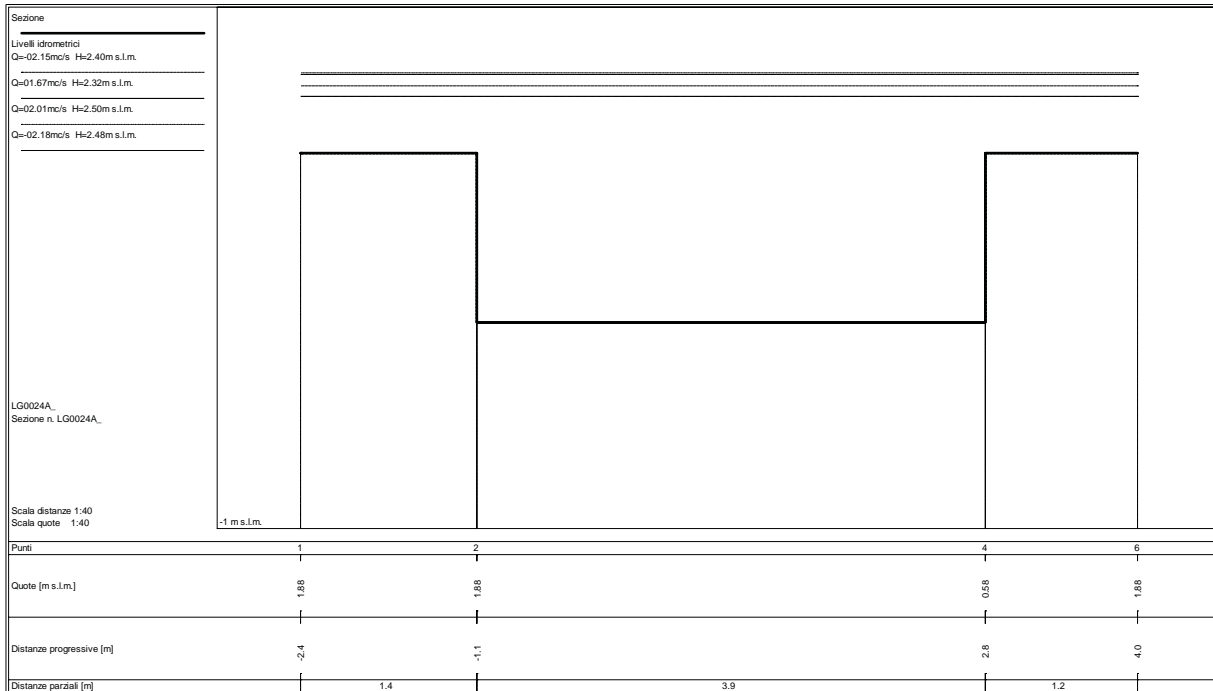

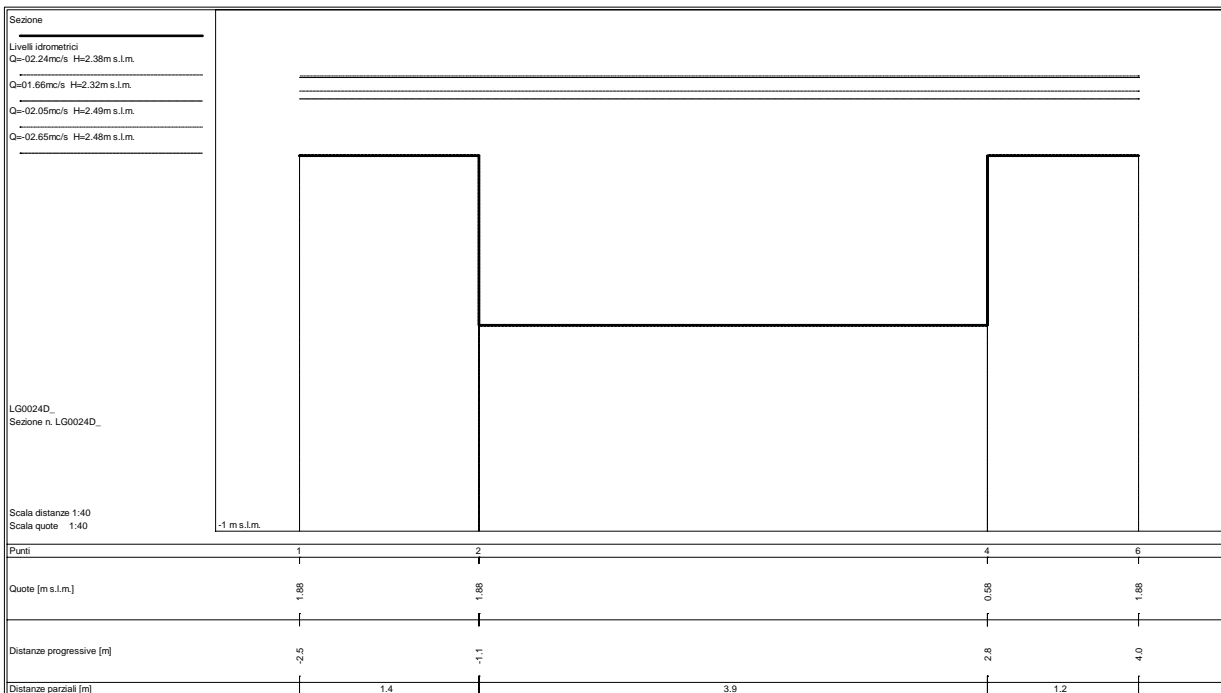
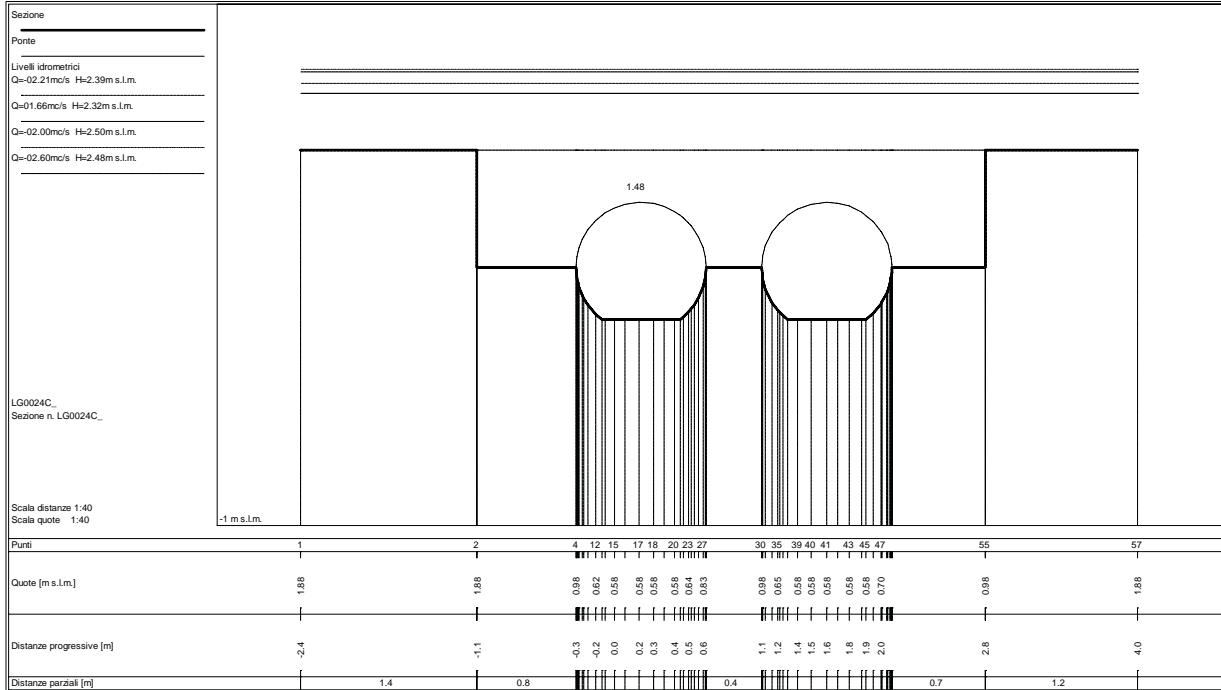

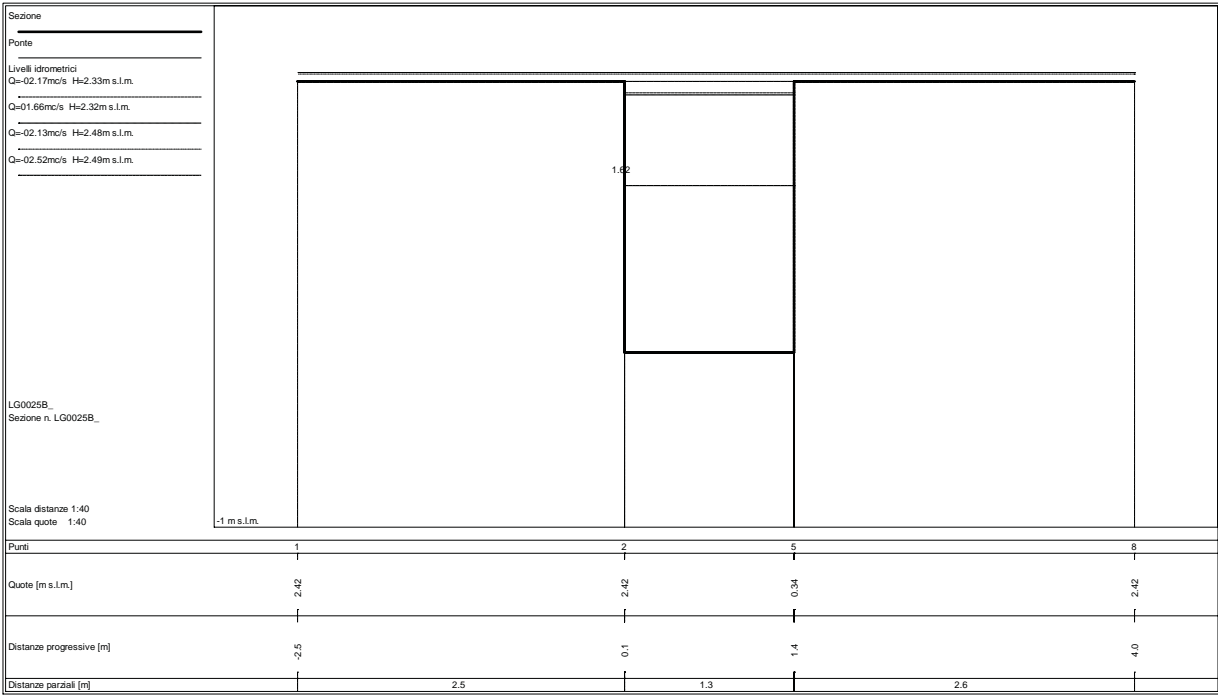
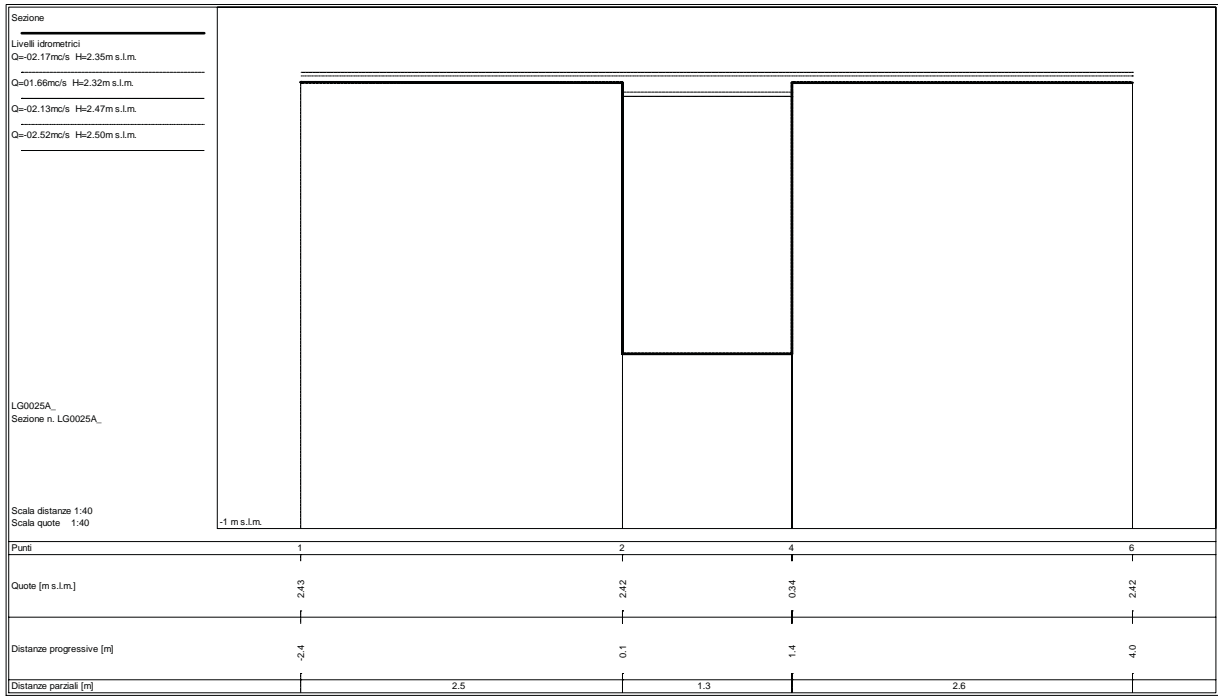

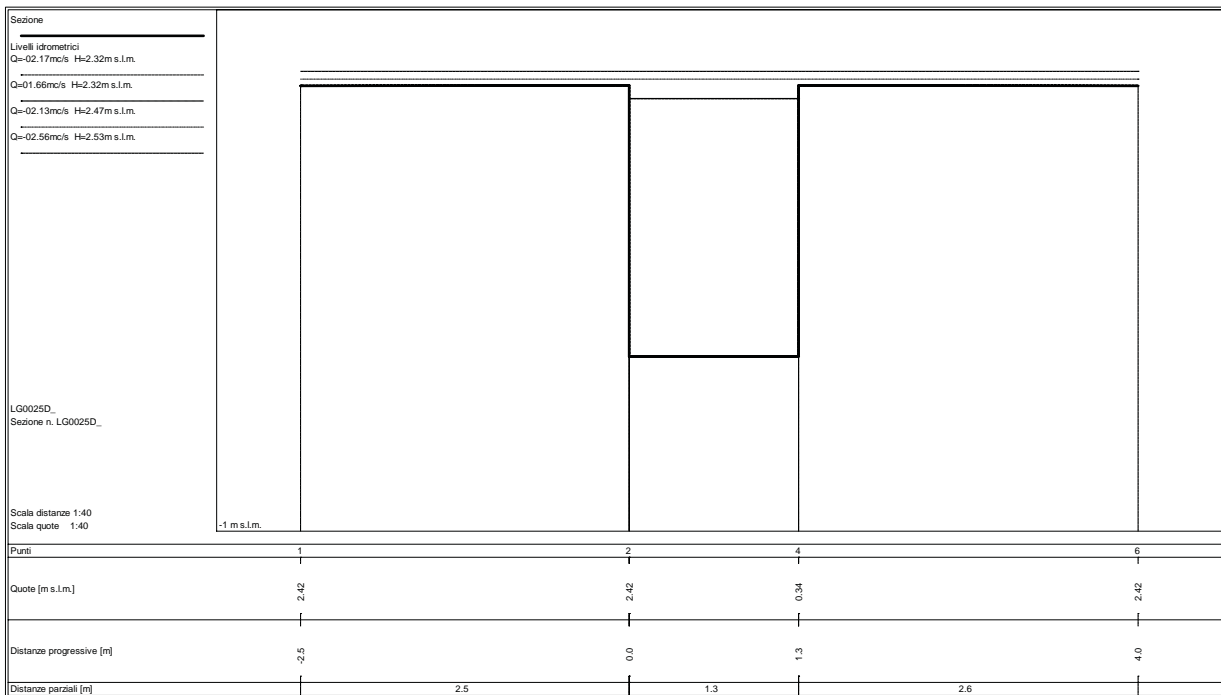
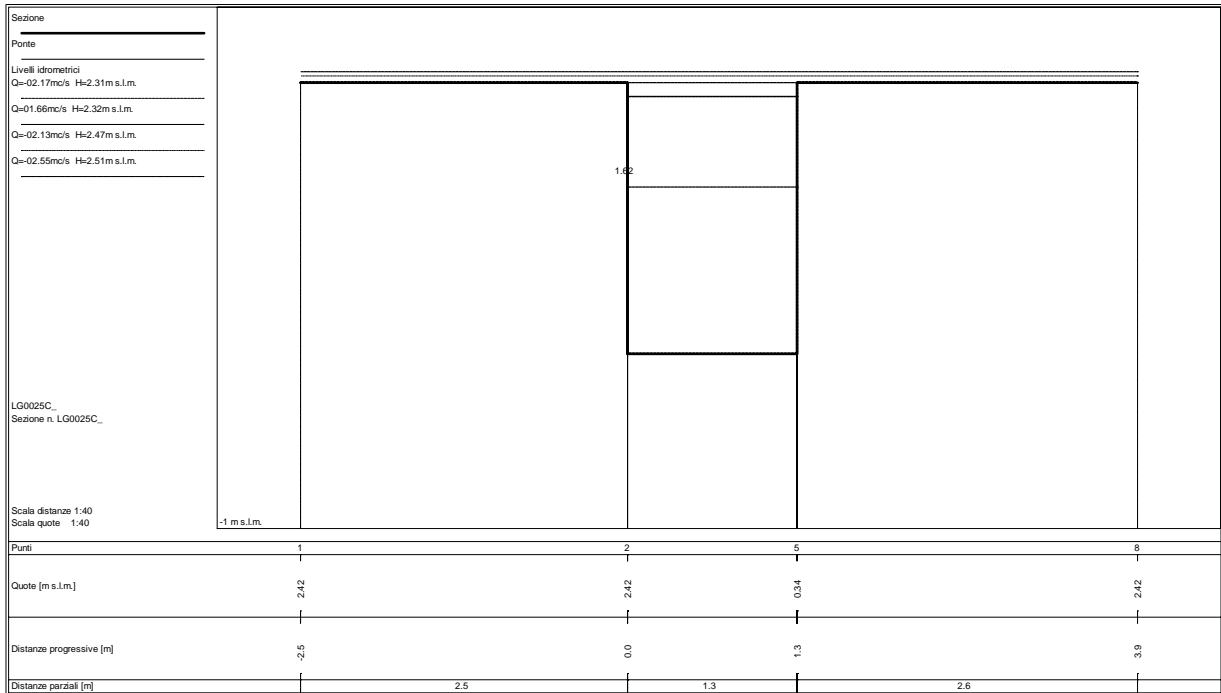

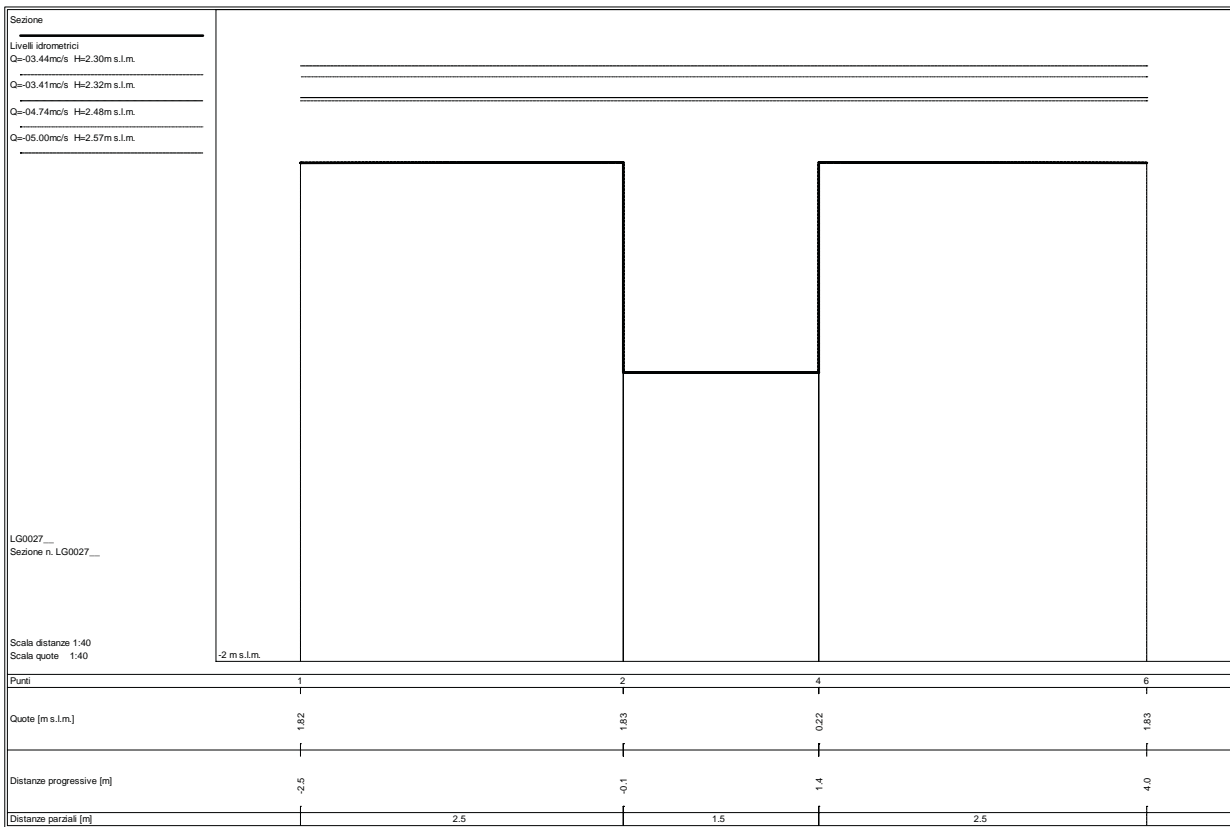
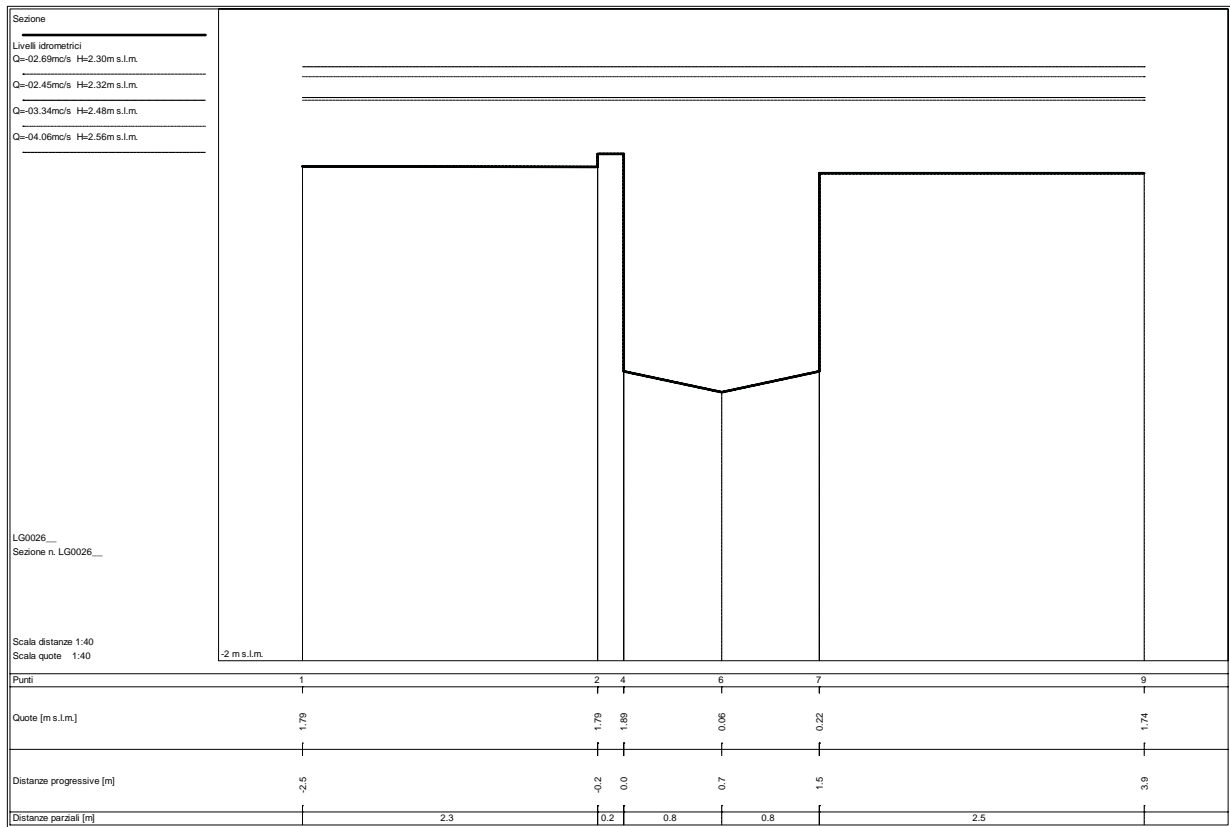

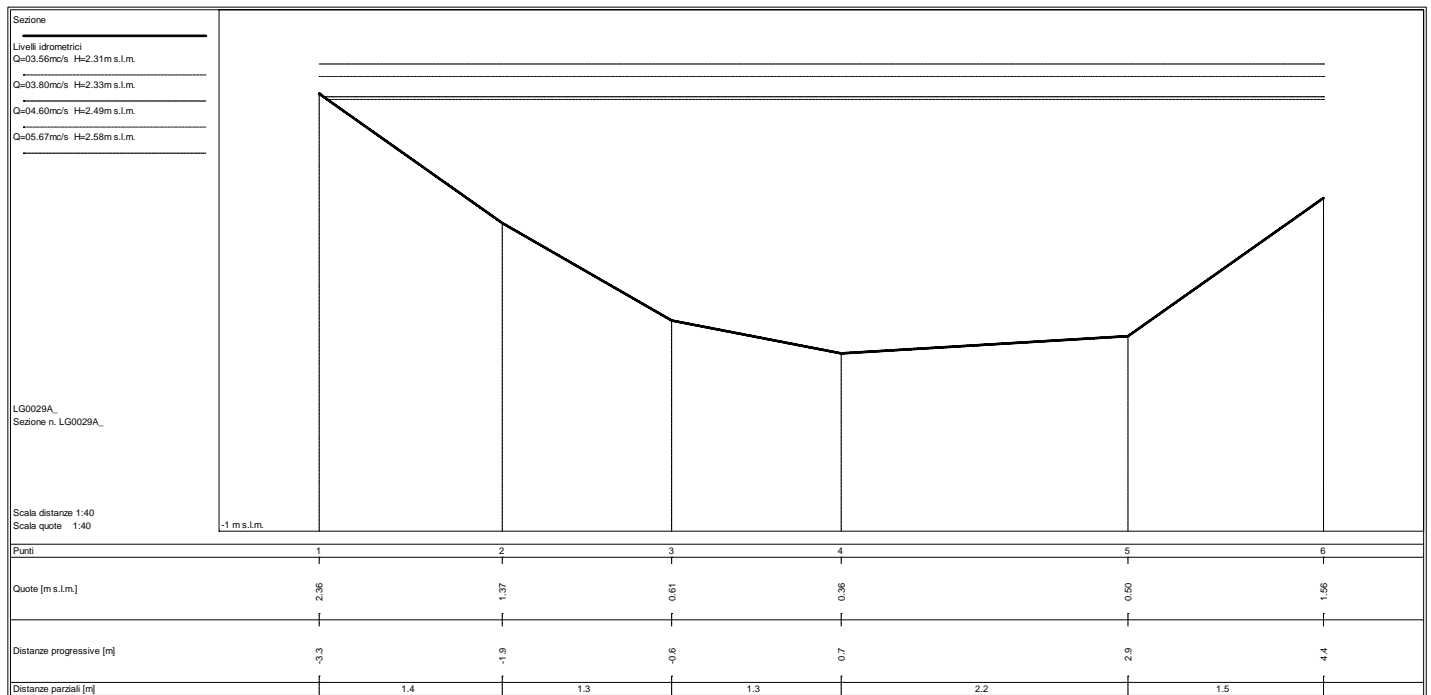
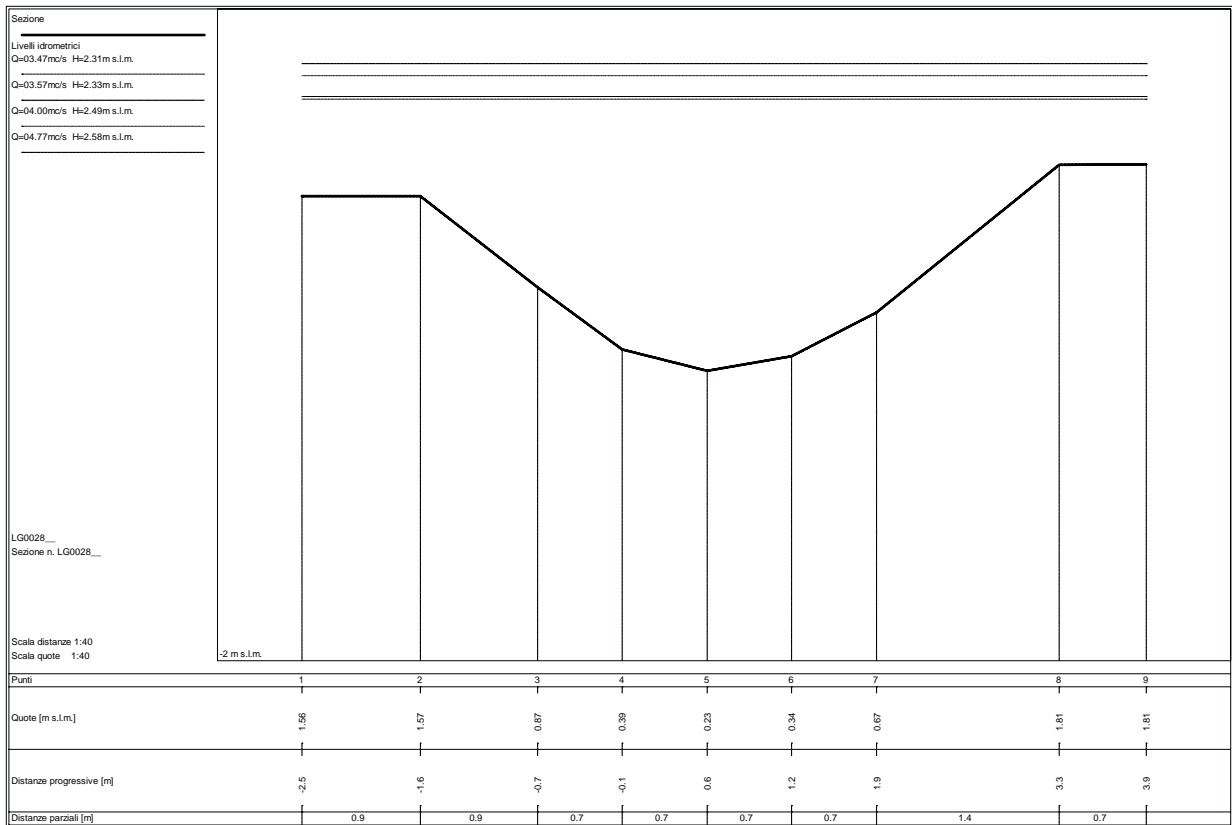

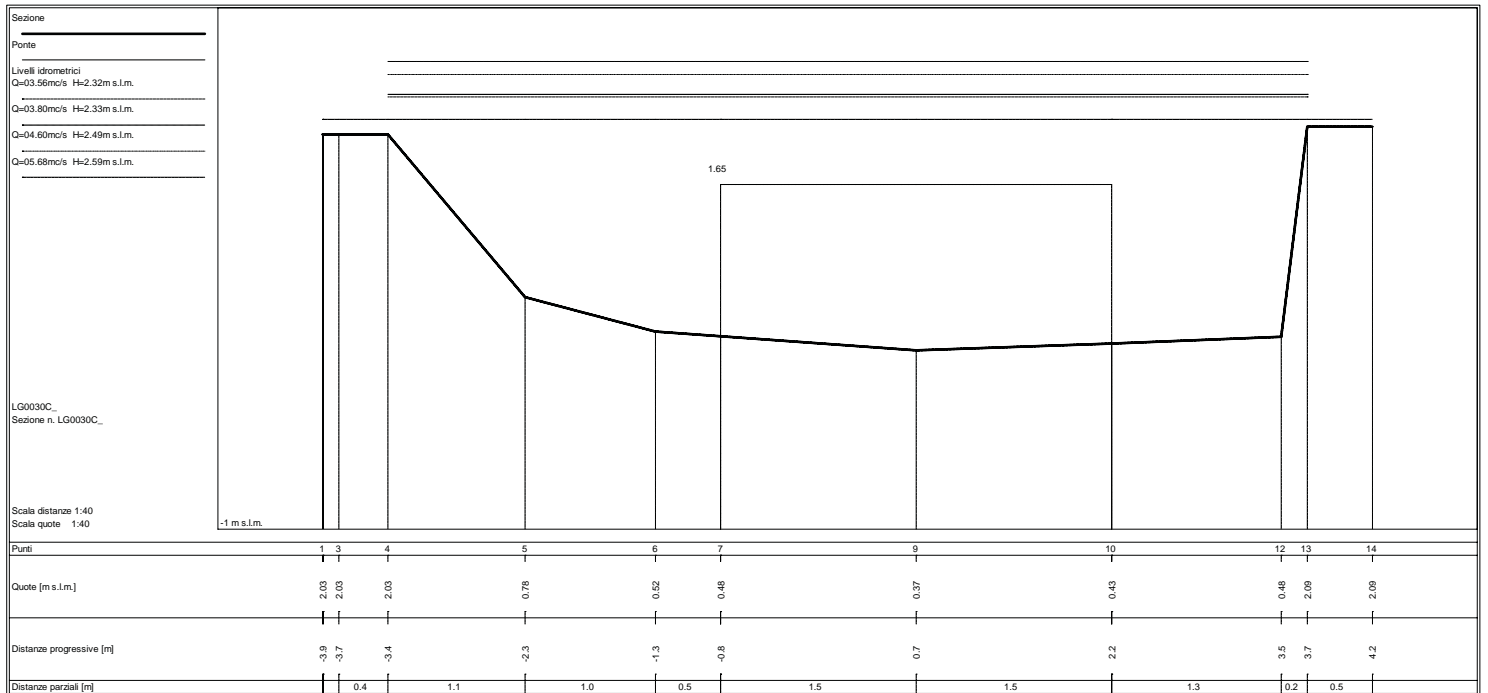
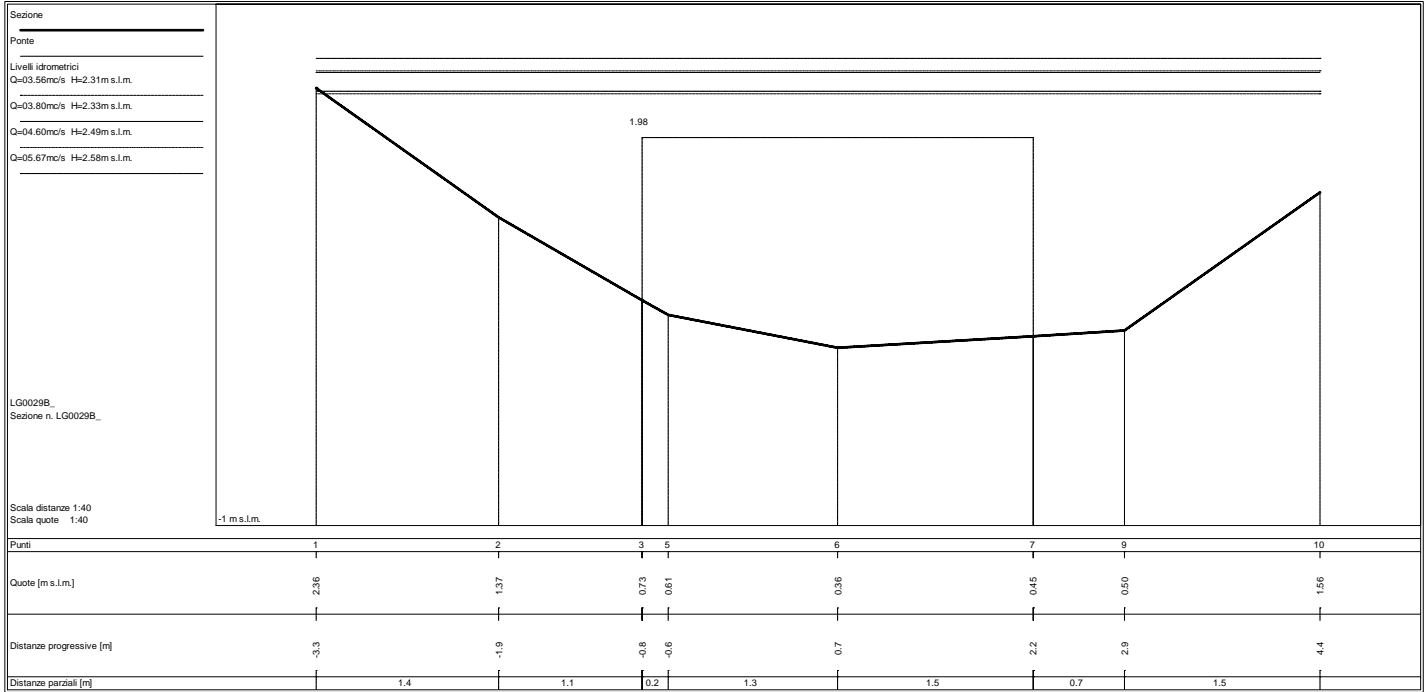

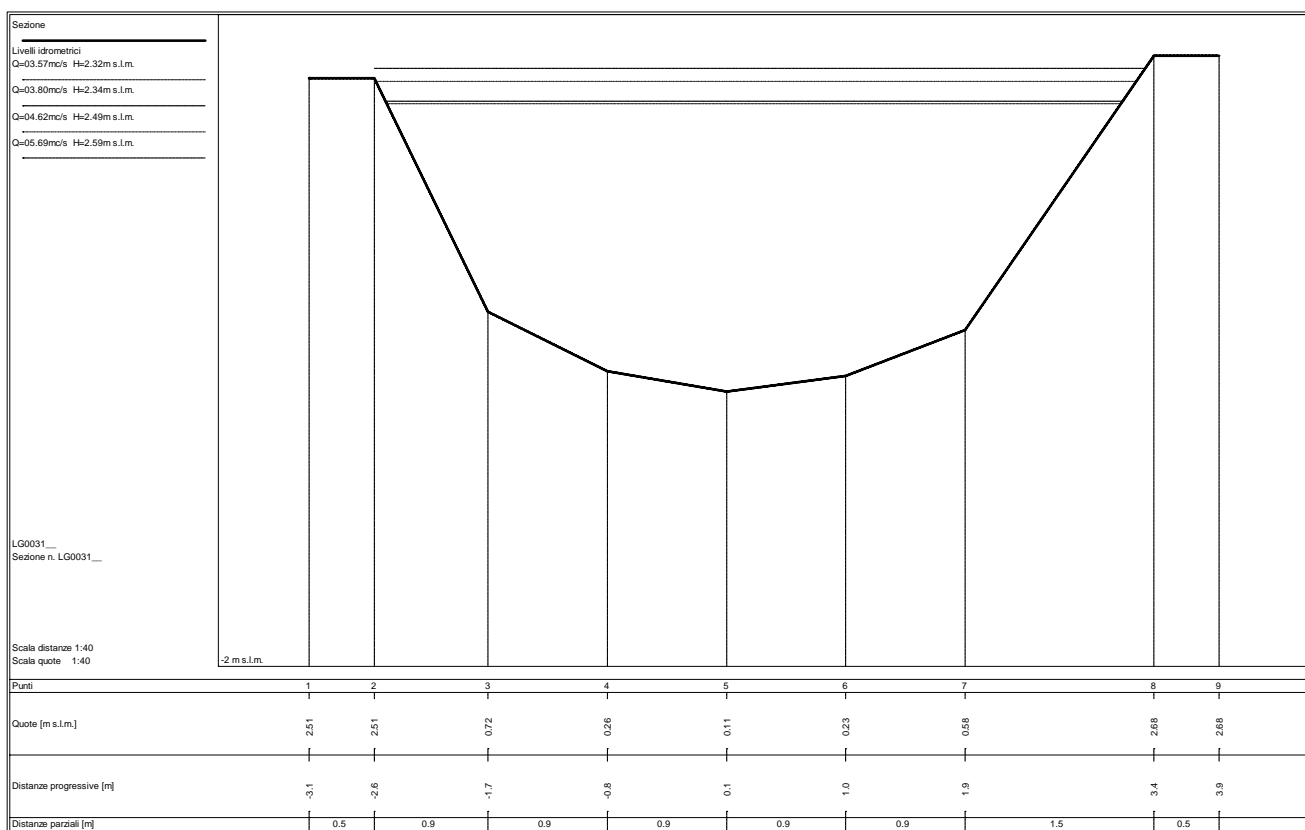
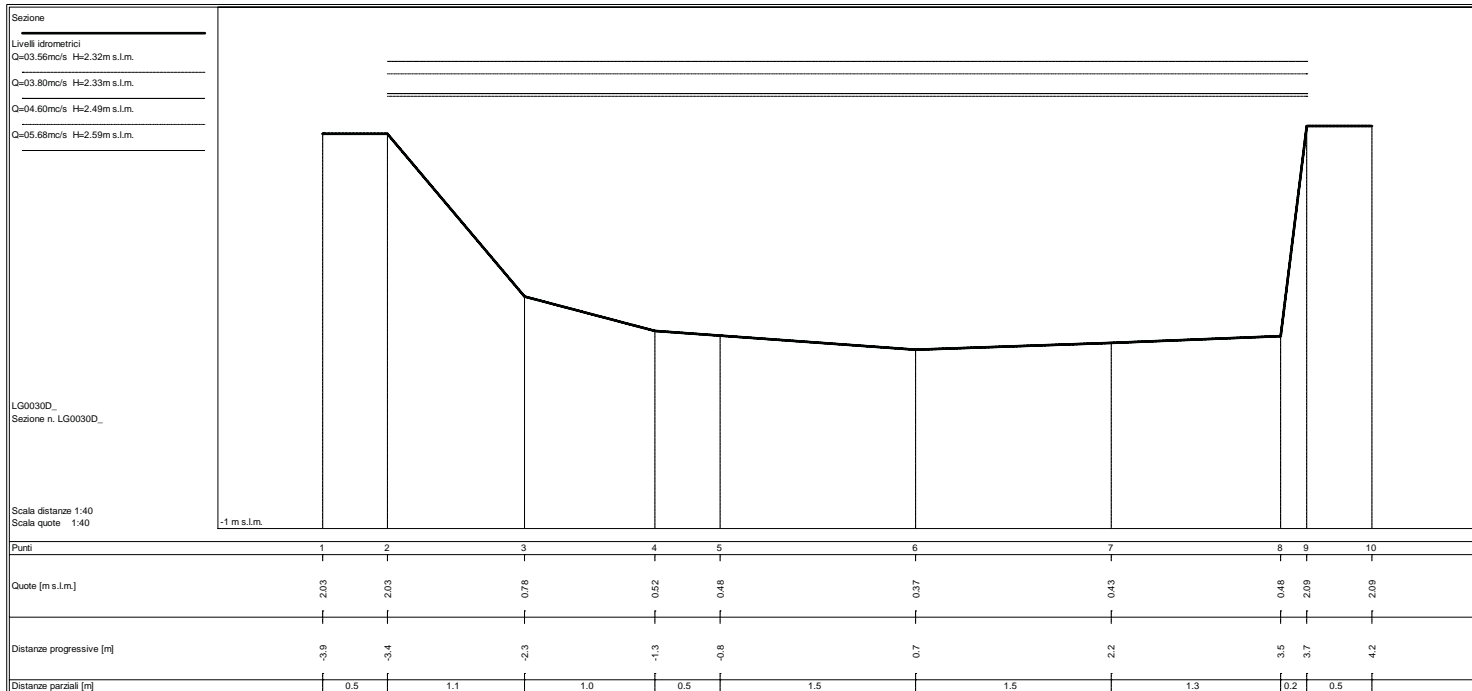

STATO ATTUALE

Sezioni fluviali fosso Riva dei Ronchi

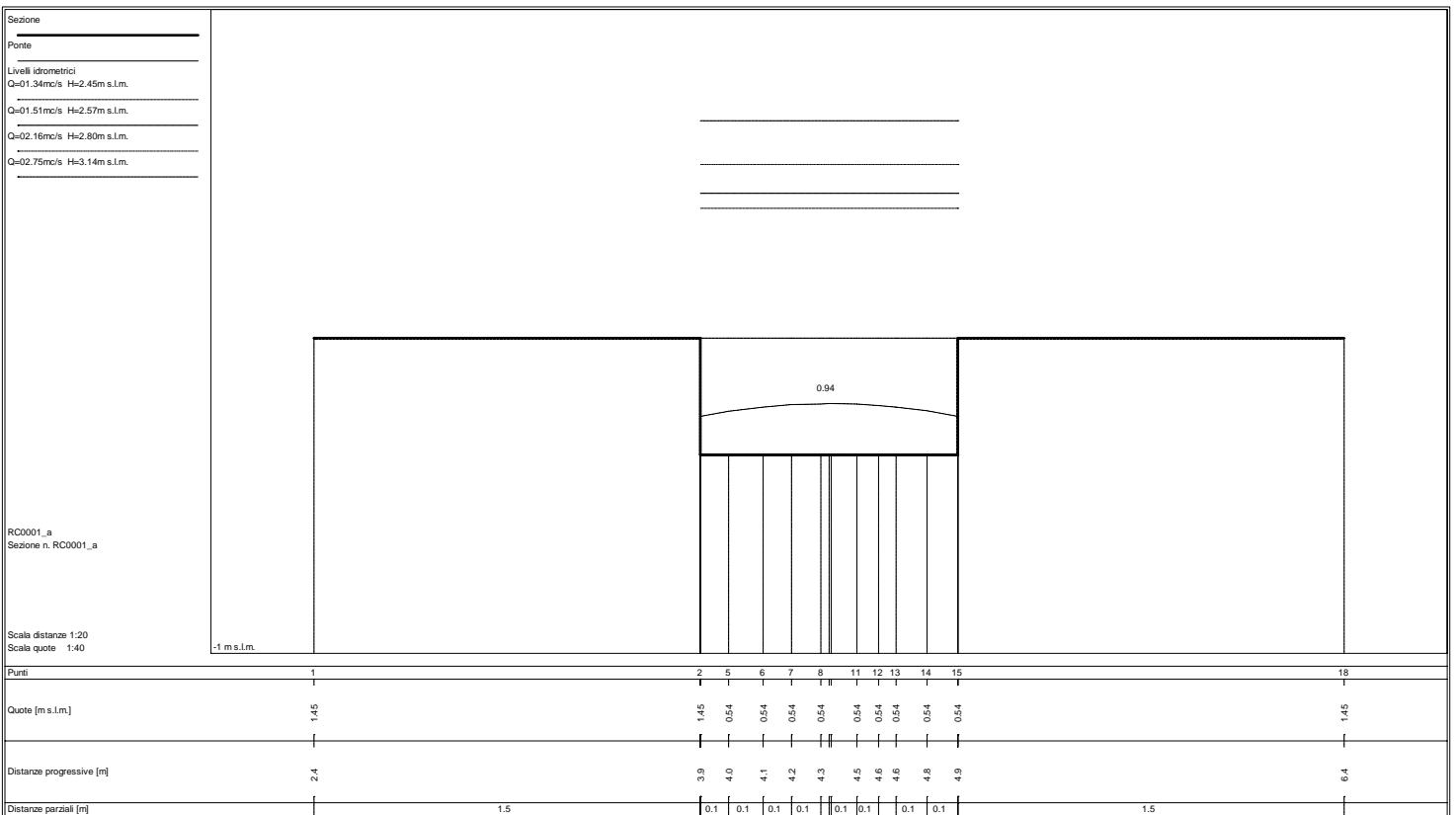
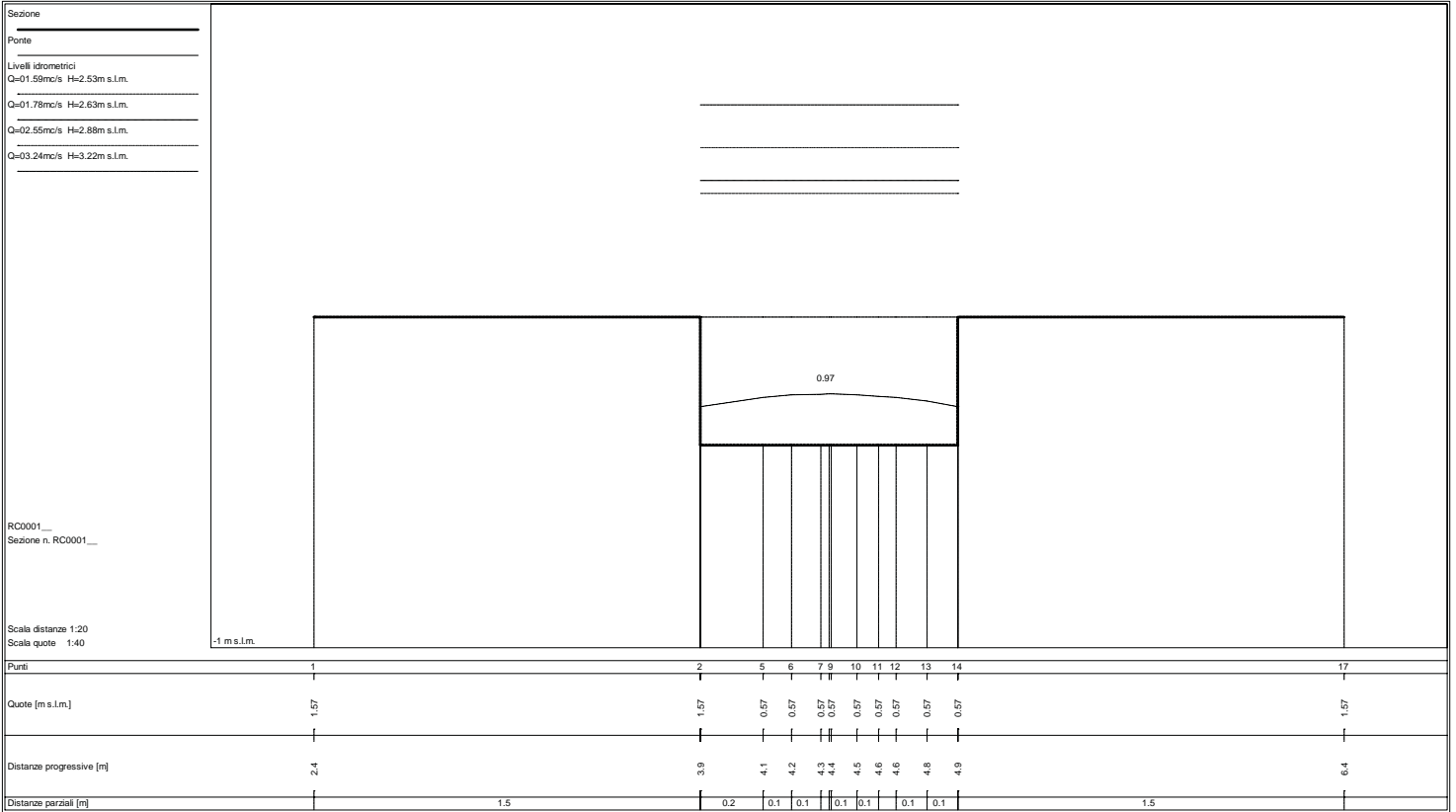

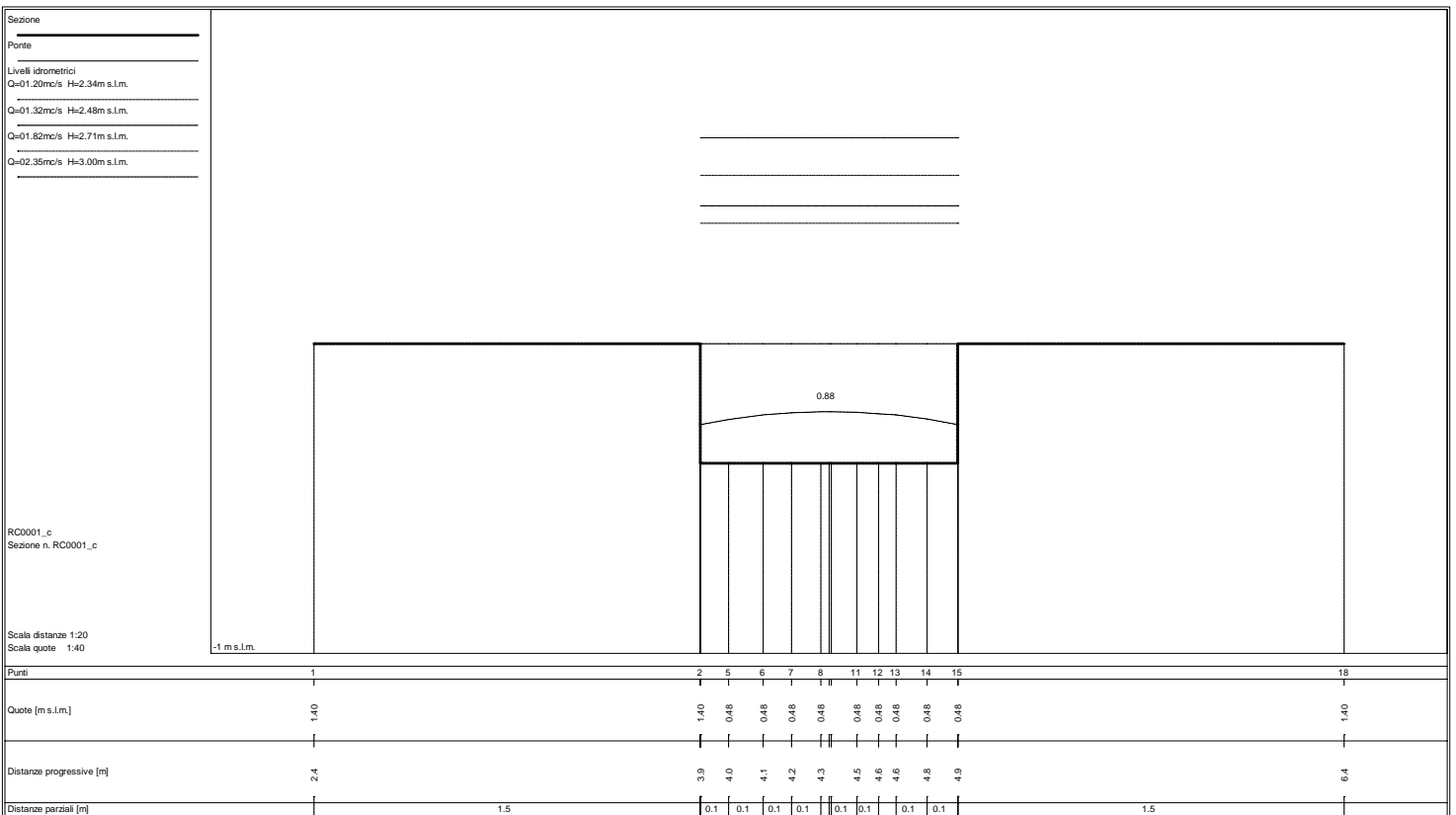
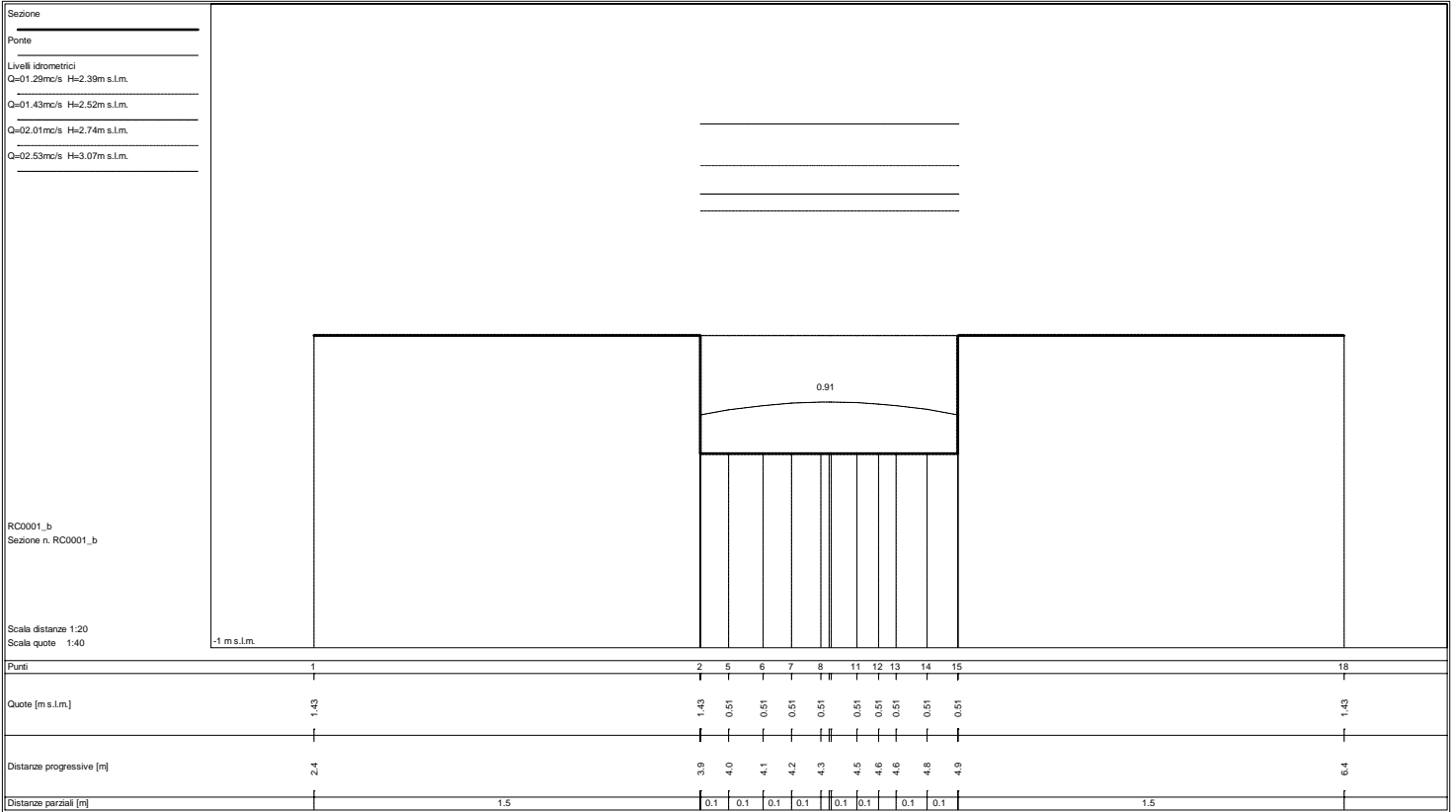

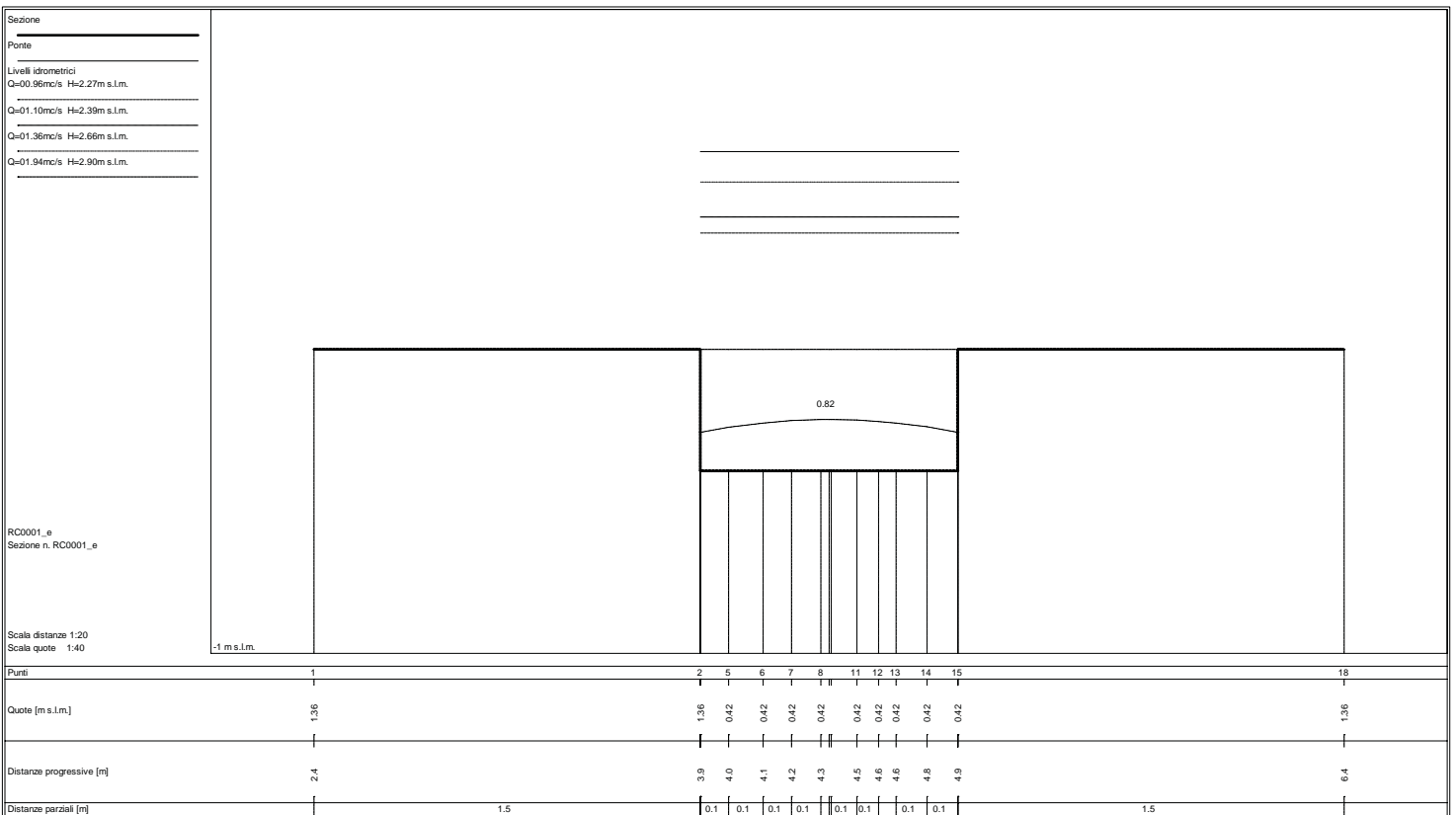
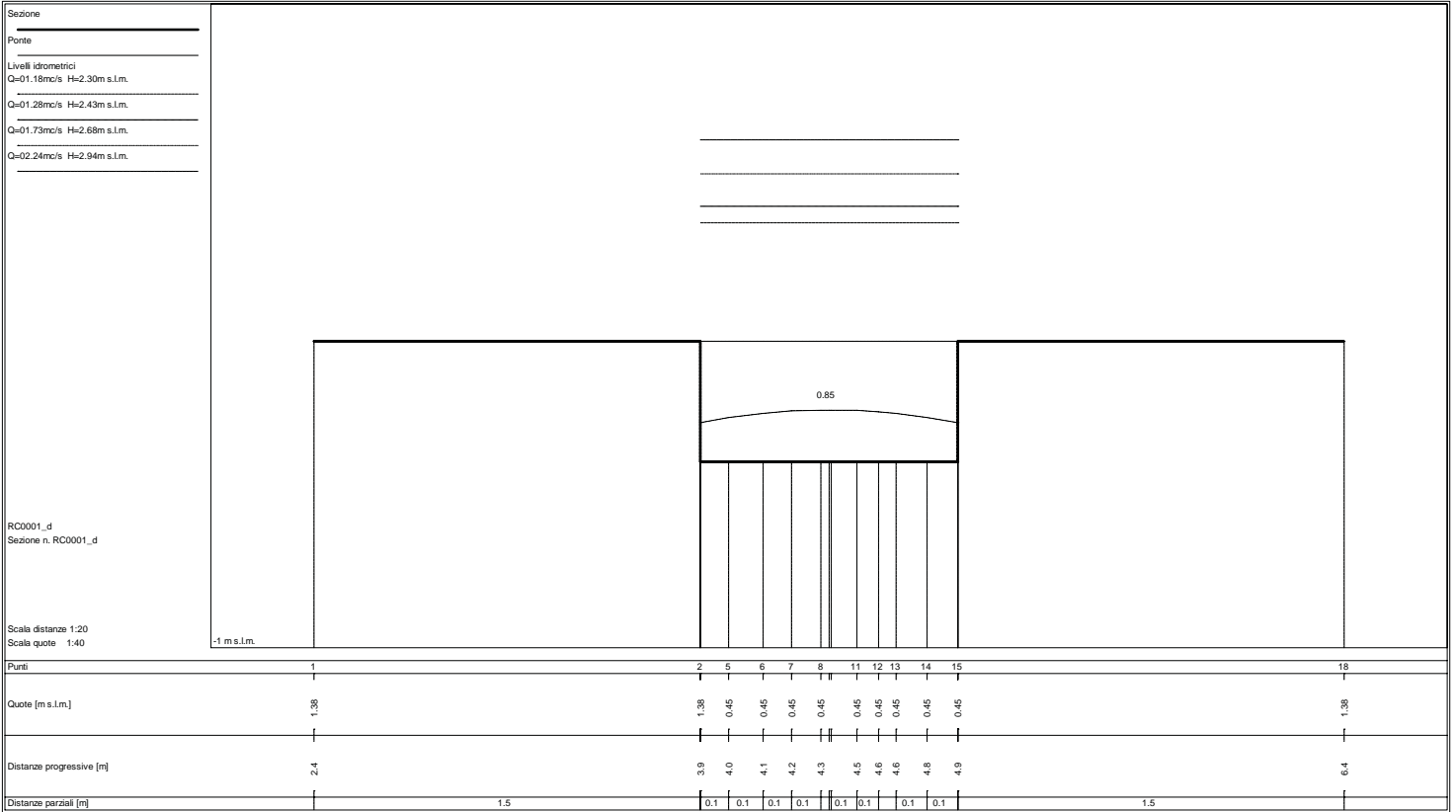

Sezione
 Ponte
 Livelli idrometrici
 Q=0.70mc/s H=2.24m s.l.m.
 Q=0.91mc/s H=2.36m s.l.m.
 Q=0.90mc/s H=2.64m s.l.m.
 Q=0.58mc/s H=2.88m s.l.m.

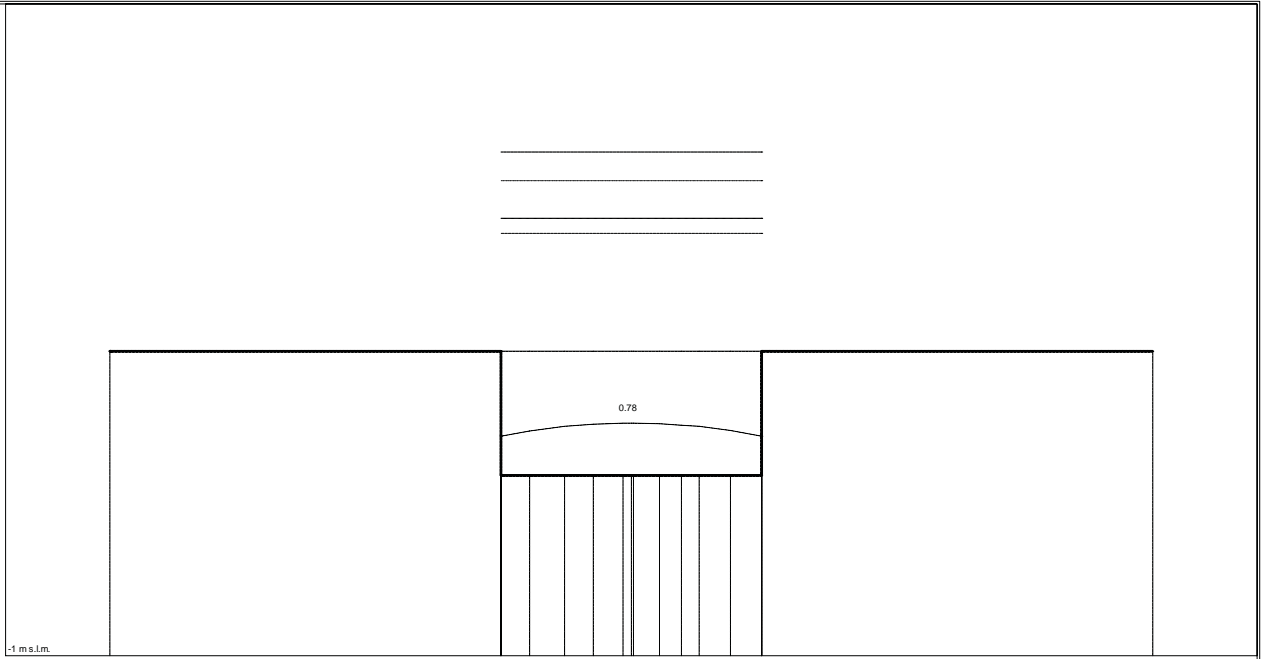

RC0001_f
 Sezione n. RC0001_f

Scala distanze 1:20
 Scala quote 1:40

Punti	1	2	5	6	7	8	11	12	13	14	15	18
Quote [m s.l.m.]	1.34	1.34	0.38	0.38	0.38	0.38	0.38	0.38	0.38	0.38	0.38	1.34
Distanze progressive [m]	2.4	3.9	4.0	4.1	4.2	4.3	4.5	4.6	4.6	4.8	4.9	6.4
Distanze parziali [m]		1.5	0.1	0.1	0.1	0.1	0.1	0.1	0.1	0.1	0.1	1.5

Sezione
 Ponte
 Livelli idrometrici
 Q=0.53mc/s H=2.23m s.l.m.
 Q=0.71mc/s H=2.33m s.l.m.
 Q=0.64mc/s H=2.64m s.l.m.
 Q=0.22mc/s H=2.84m s.l.m.

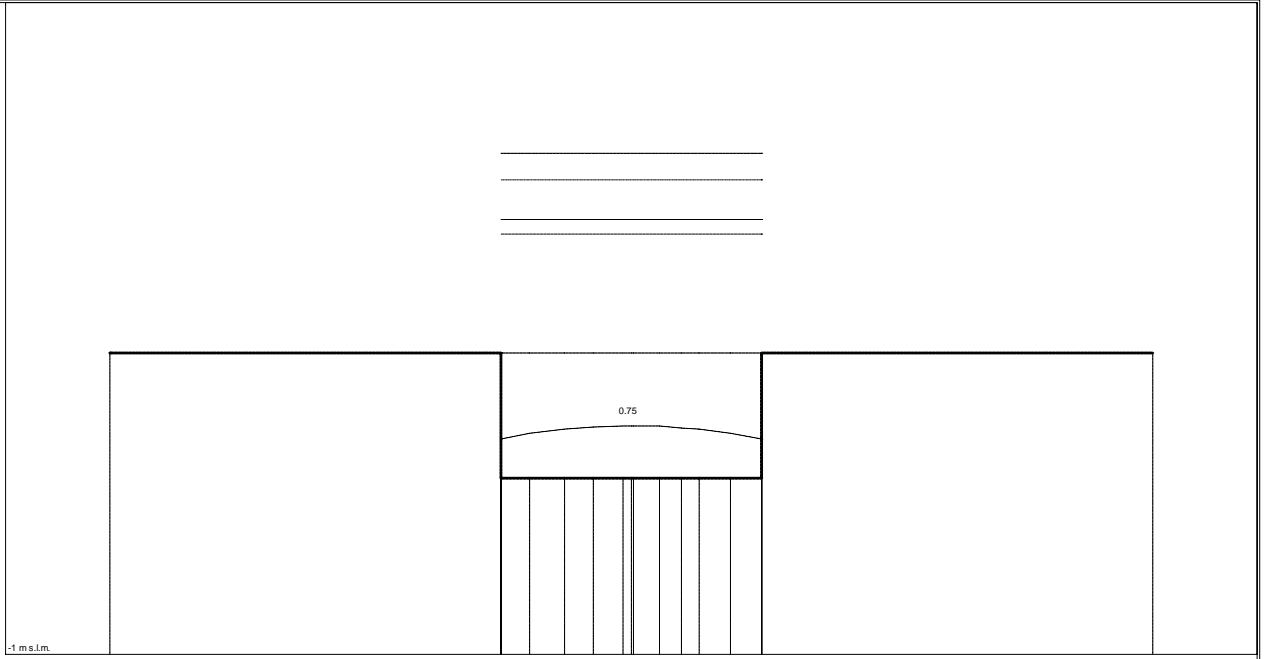

RC0001_g
 Sezione n. RC0001_g

Scala distanze 1:20
 Scala quote 1:40

Punti	1	2	5	6	7	8	11	12	13	14	15	18
Quote [m s.l.m.]	1.31	1.31	0.35	0.35	0.35	0.35	0.35	0.35	0.35	0.35	0.35	1.31
Distanze progressive [m]	2.4	3.9	4.0	4.1	4.2	4.3	4.5	4.6	4.6	4.8	4.9	6.4
Distanze parziali [m]		1.5	0.1	0.1	0.1	0.1	0.1	0.1	0.1	0.1	0.1	1.5

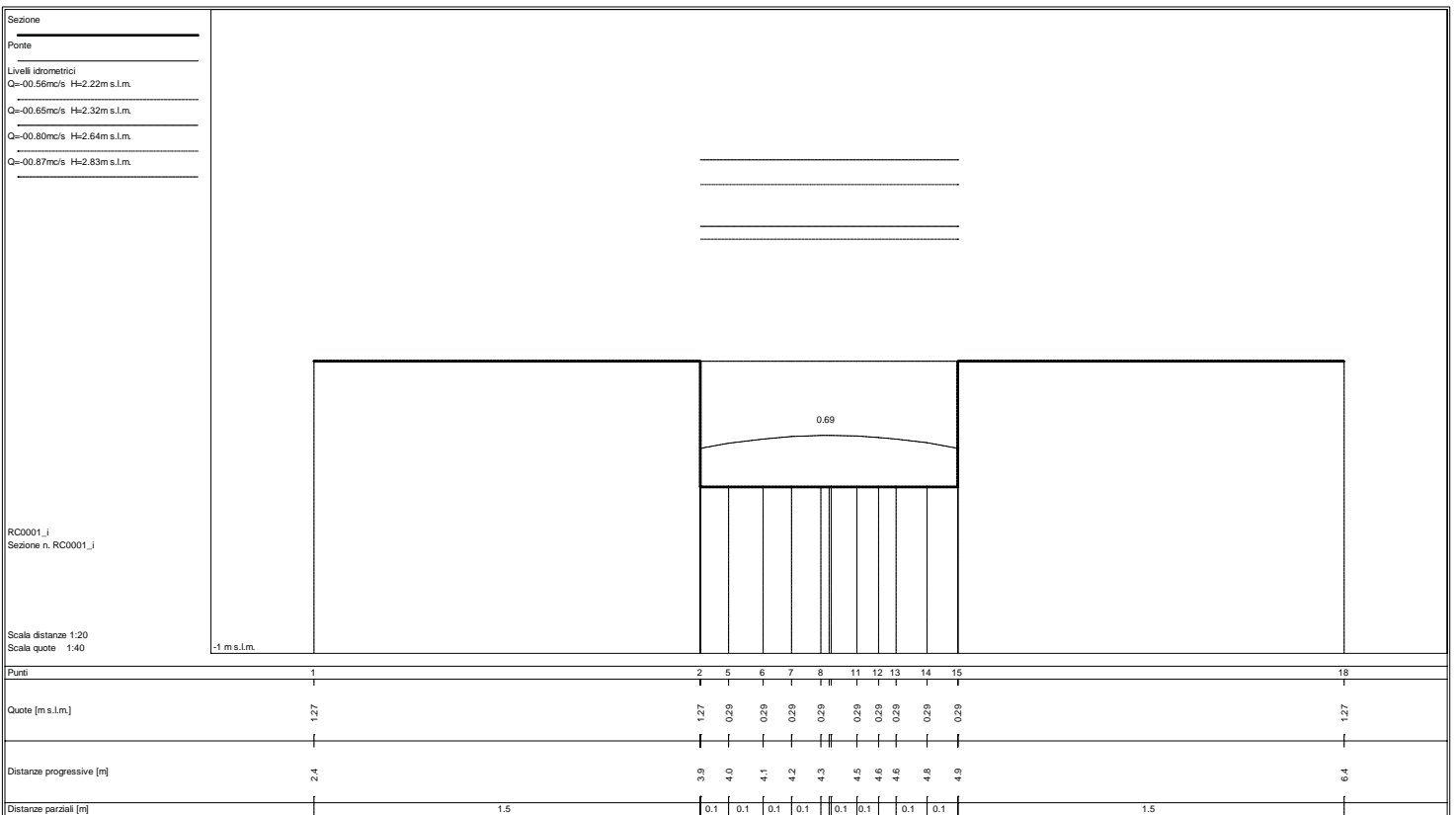
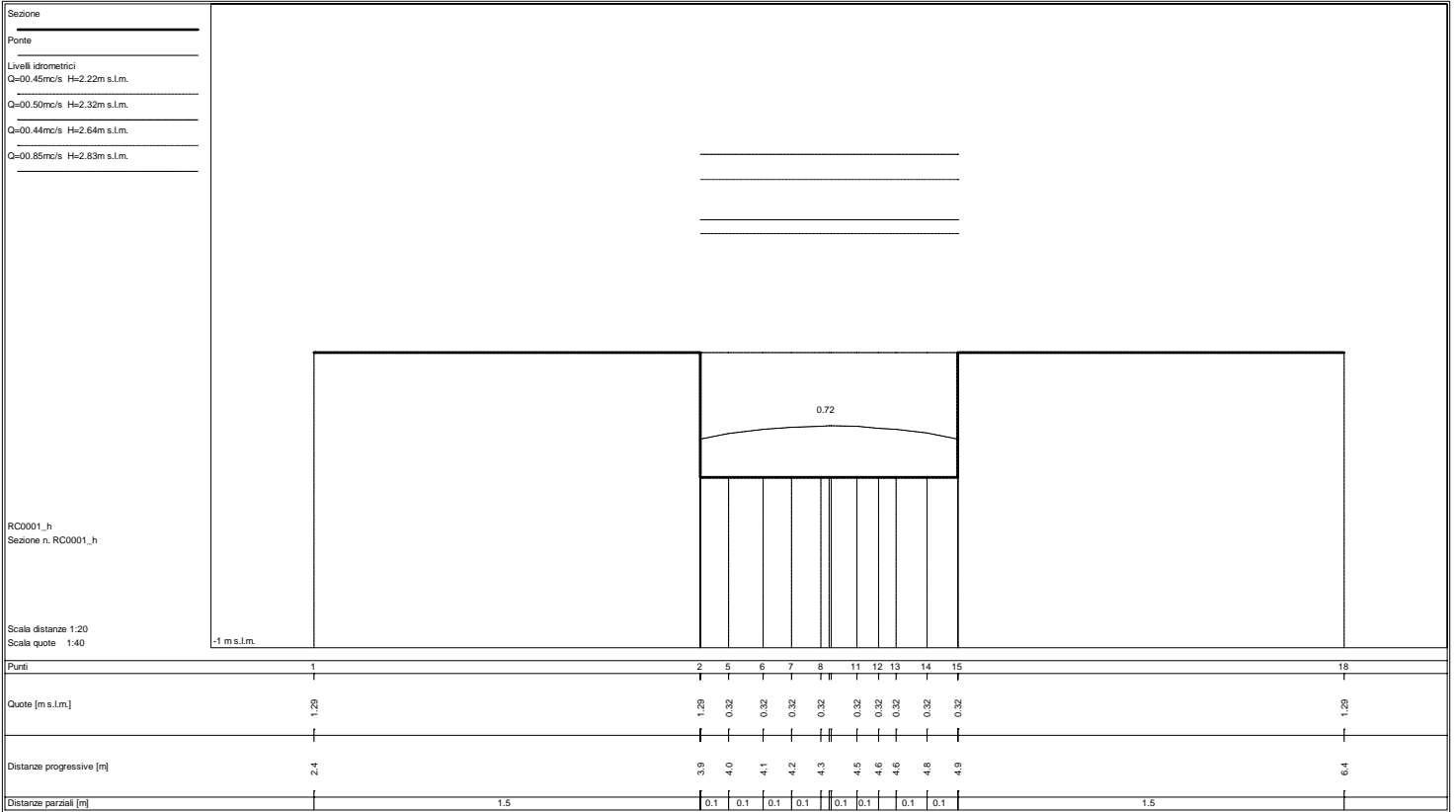

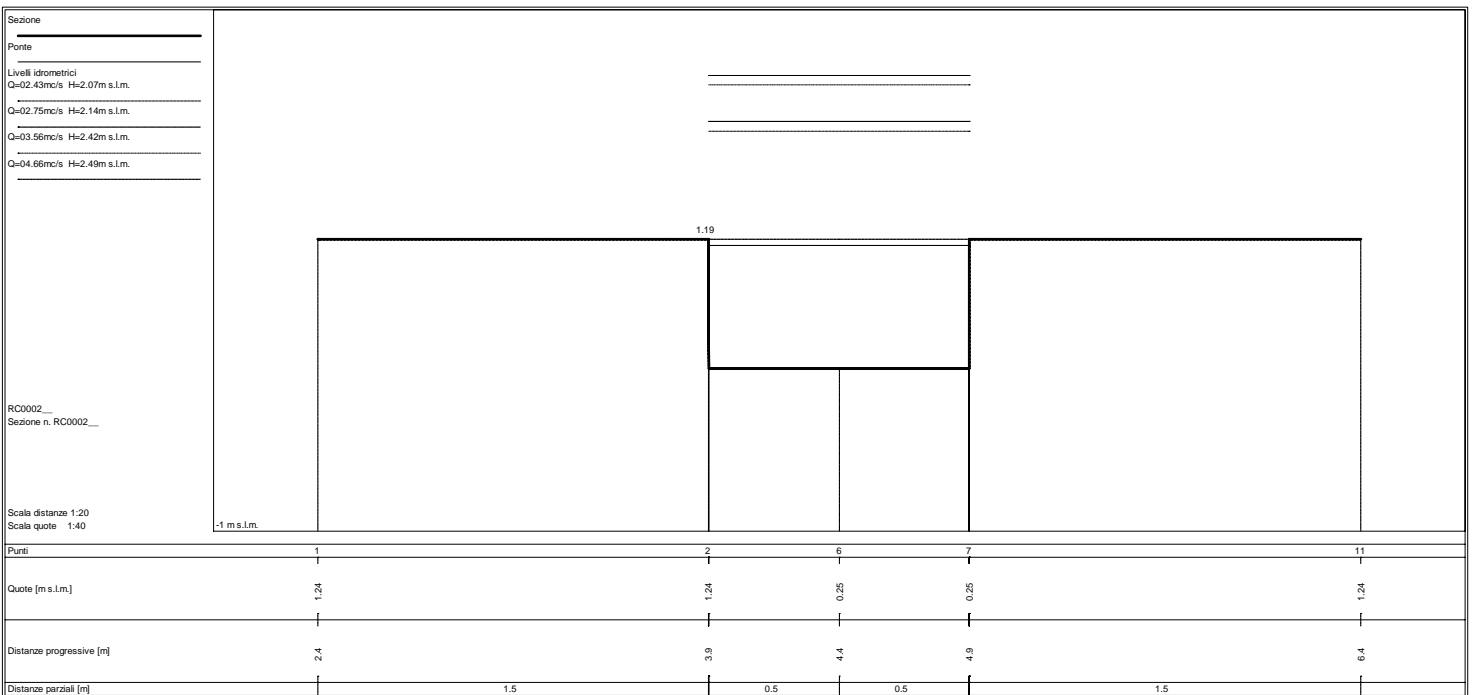
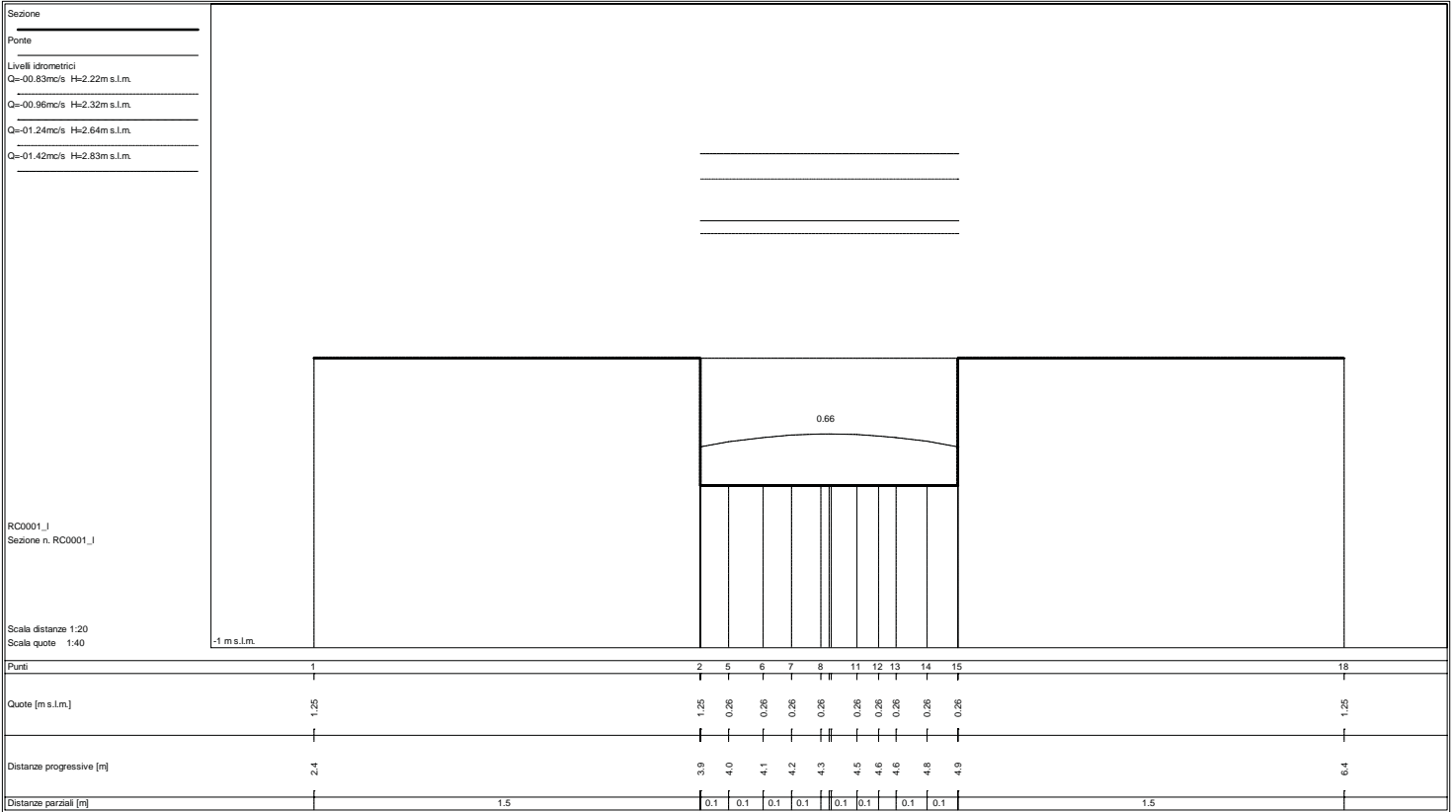

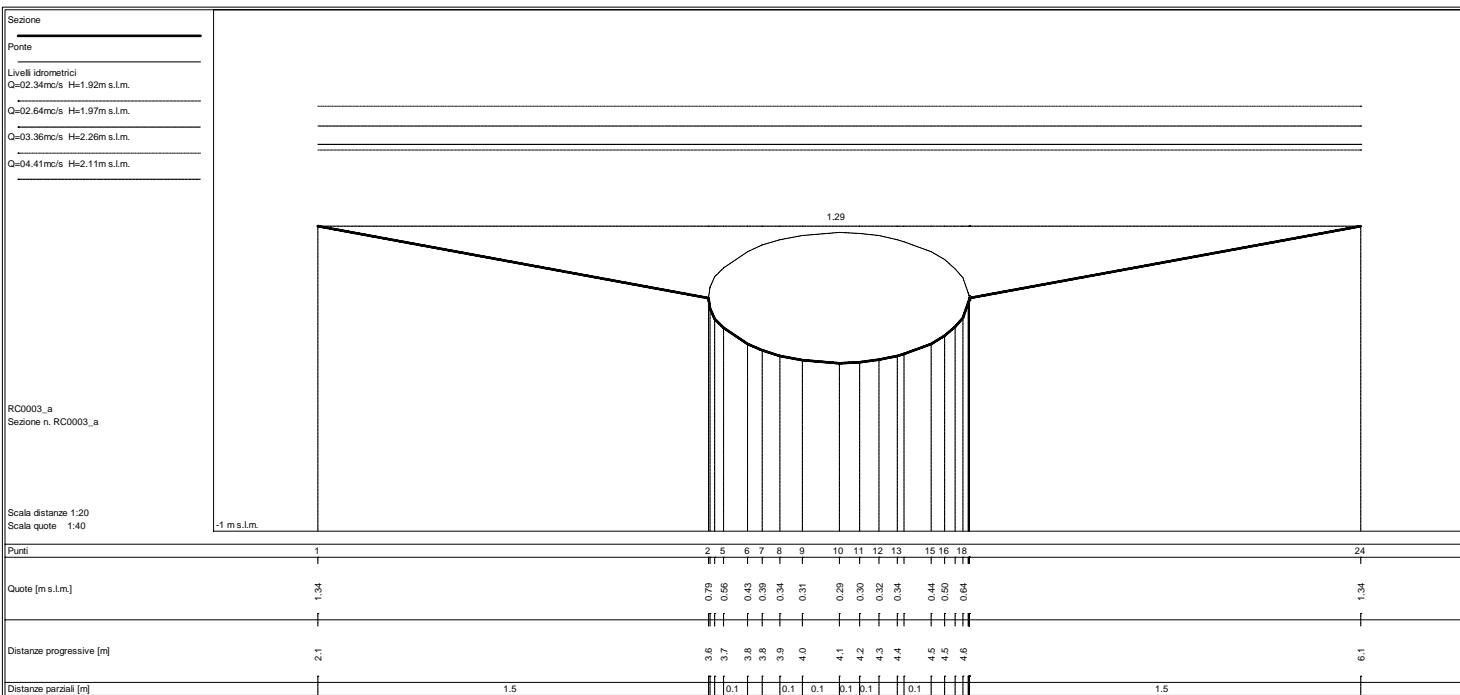
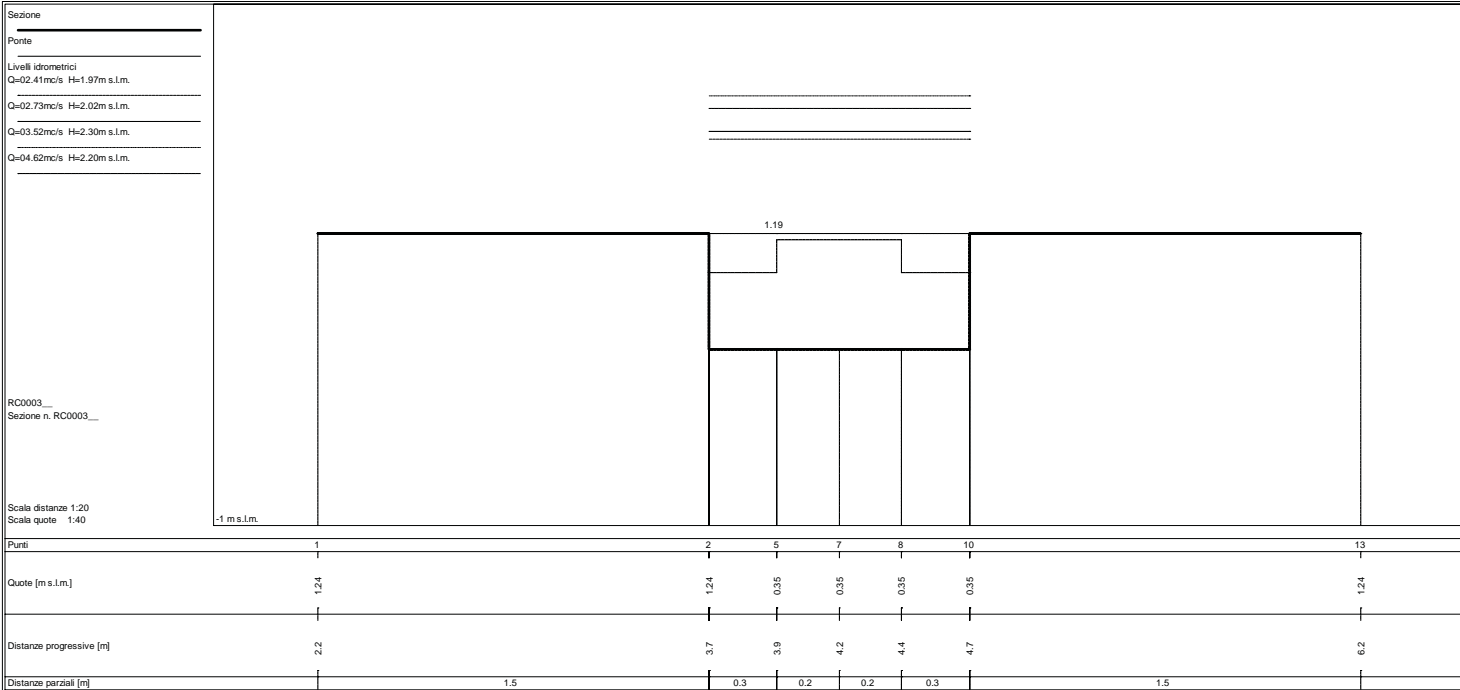

Sezione
 Ponte
 Livelli idrometrici
 Q=02.20mc/s H=1.92m s.l.m.
 Q=02.47mc/s H=1.95m s.l.m.
 Q=03.26mc/s H=2.26m s.l.m.
 Q=04.11mc/s H=2.09m s.l.m.

RC0003_b
 Sezione n. RC0003_b

Scala distanze 1:20
 Scala quote 1:40

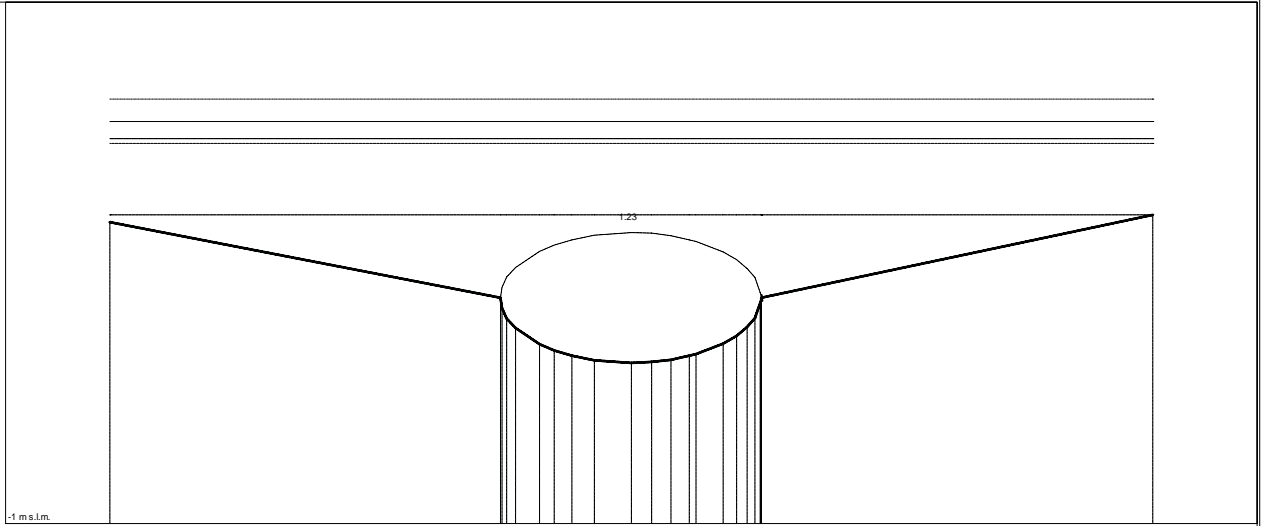

Punti	1	2	5	6	7	8	9	10	11	12	13	15	16	18	24
Quote [m s.l.m.]	1.31	0.73	0.50	0.38	0.33	0.29	0.25	0.23	0.24	0.26	0.29	0.38	0.44	0.58	1.37
Distanze progressive [m]	2.1	3.6	3.7	3.8	3.8	3.9	4.0	4.1	4.2	4.3	4.4	4.5	4.5	4.6	6.1
Distanze parziali [m]		1.5	0.1	0.1	0.1	0.1	0.1	0.1	0.1	0.1	0.1	0.1	0.1	0.1	1.5

Sezione
 Ponte
 Livelli idrometrici
 Q=02.17mc/s H=1.91m s.l.m.
 Q=02.44mc/s H=1.93m s.l.m.
 Q=03.37mc/s H=2.24m s.l.m.
 Q=03.92mc/s H=2.04m s.l.m.

RC0003_c
 Sezione n. RC0003_c

Scala distanze 1:20
 Scala quote 1:40

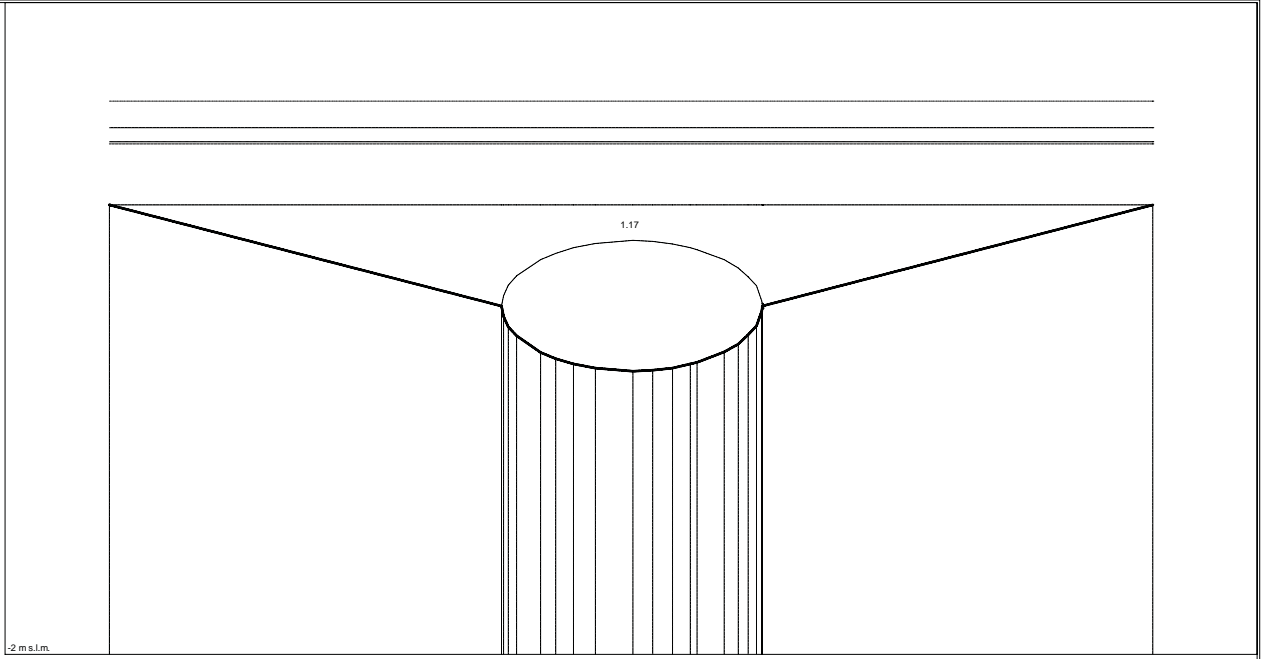

Punti	1	2	5	6	7	8	9	10	11	12	13	15	16	18	24
Quote [m s.l.m.]	1.45	0.67	0.44	0.32	0.27	0.23	0.19	0.17	0.18	0.20	0.23	0.32	0.38	0.52	1.45
Distanze progressive [m]	2.1	3.6	3.7	3.8	3.8	3.9	4.0	4.1	4.2	4.3	4.4	4.5	4.5	4.6	6.1
Distanze parziali [m]		1.5	0.1	0.1	0.1	0.1	0.1	0.1	0.1	0.1	0.1	0.1	0.1	0.1	1.5

Sezione

Ponte

Livelli idrometrici

Q=01.98mc/s H=1.92m s.l.m.

Q=02.17mc/s H=1.98m s.l.m.

Q=03.22mc/s H=2.17m s.l.m.

Q=03.75mc/s H=1.97m s.l.m.

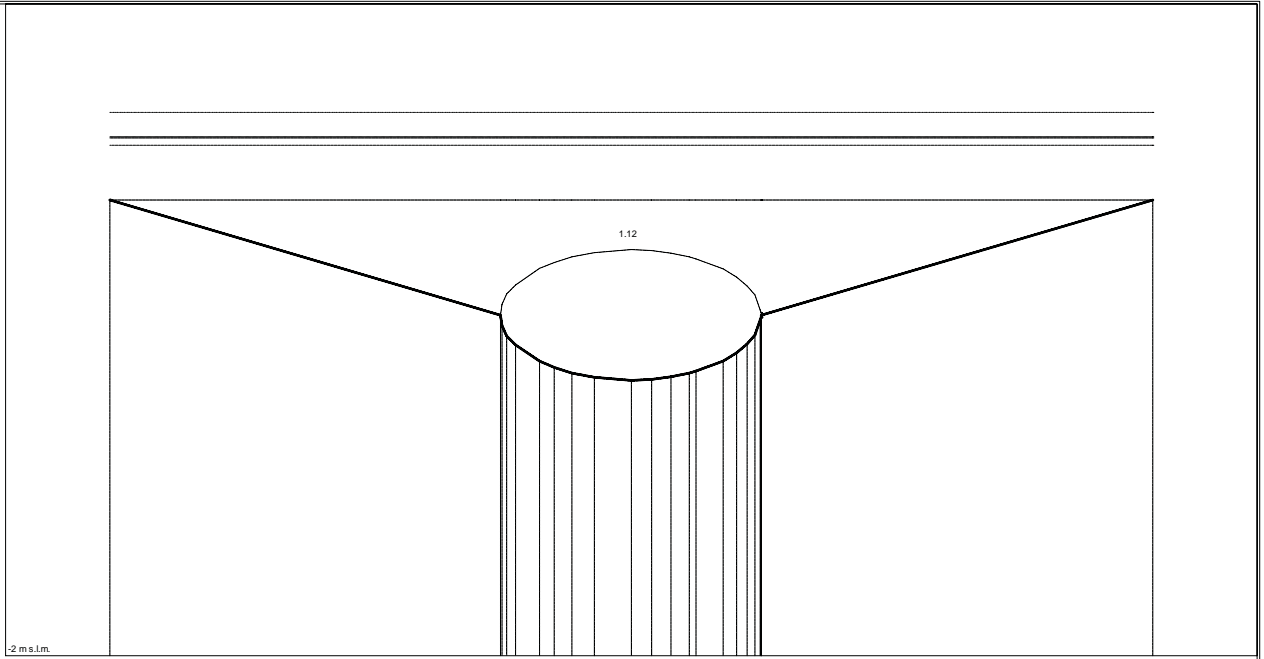

RC0003_d
Sezione n. RC0003_d

Scala distanze 1:20
Scala quote 1:40

Punti	1	2	5	6	7	8	9	10	11	12	13	15	16	18	24
Quote [m s.l.m.]	1.50	0.61	0.38	0.26	0.21	0.17	0.14	0.11	0.12	0.14	0.17	0.26	0.32	0.46	1.50
Distanze progressive [m]	2.1	3.6	3.7	3.8	3.8	3.9	4.0	4.1	4.2	4.3	4.4	4.5	4.5	4.6	6.1
Distanze parziali [m]		1.5	0.1	0.1	0.1	0.1	0.1	0.1	0.1	0.1	0.1	0.1	0.1	0.1	1.5

Sezione

Ponte

Livelli idrometrici

Q=01.95mc/s H=1.78m s.l.m.

Q=02.13mc/s H=1.81m s.l.m.

Q=03.21mc/s H=1.89m s.l.m.

Q=03.78mc/s H=1.97m s.l.m.

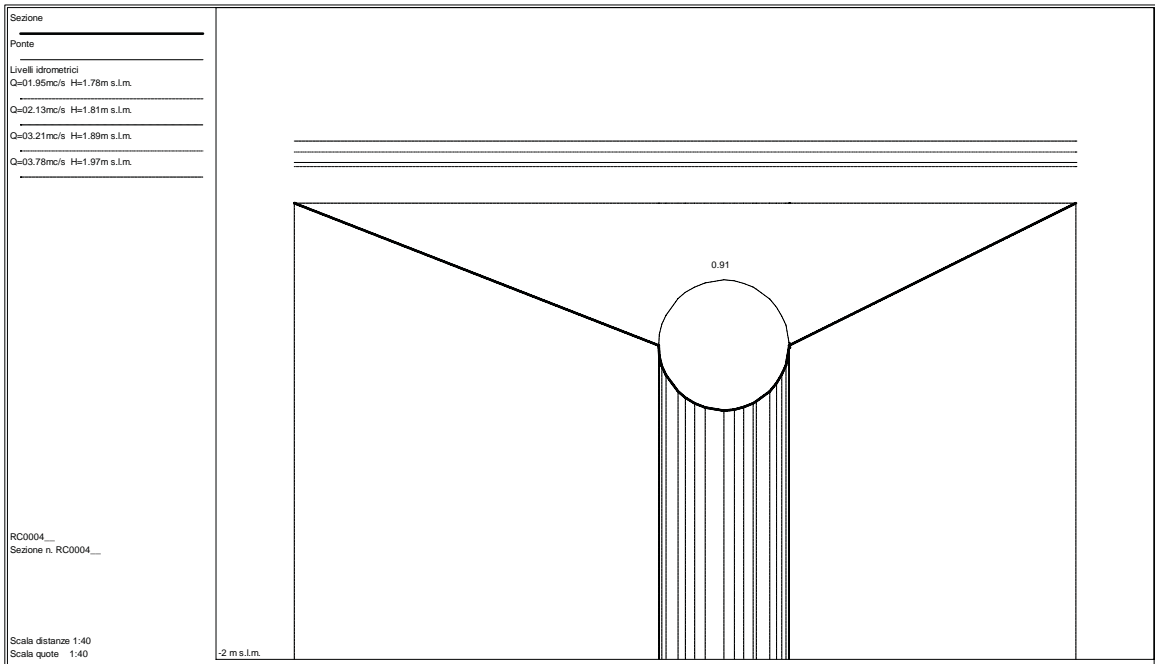

RC0004_
Sezione n. RC0004_

Scala distanze 1:40
Scala quote 1:40

Punti	1	2	6	8	9	10	12	15	18	24
Quote [m s.l.m.]	1.50	0.41	0.05	-0.04	-0.07	-0.09	-0.07	0.06	0.26	1.50
Distanze progressive [m]	7.1	9.9	10.0	10.1	10.2	10.4	10.5	10.7	10.9	13.1
Distanze parziali [m]		2.8	0.1	0.1	0.1	0.1	0.1	0.1	0.1	2.2

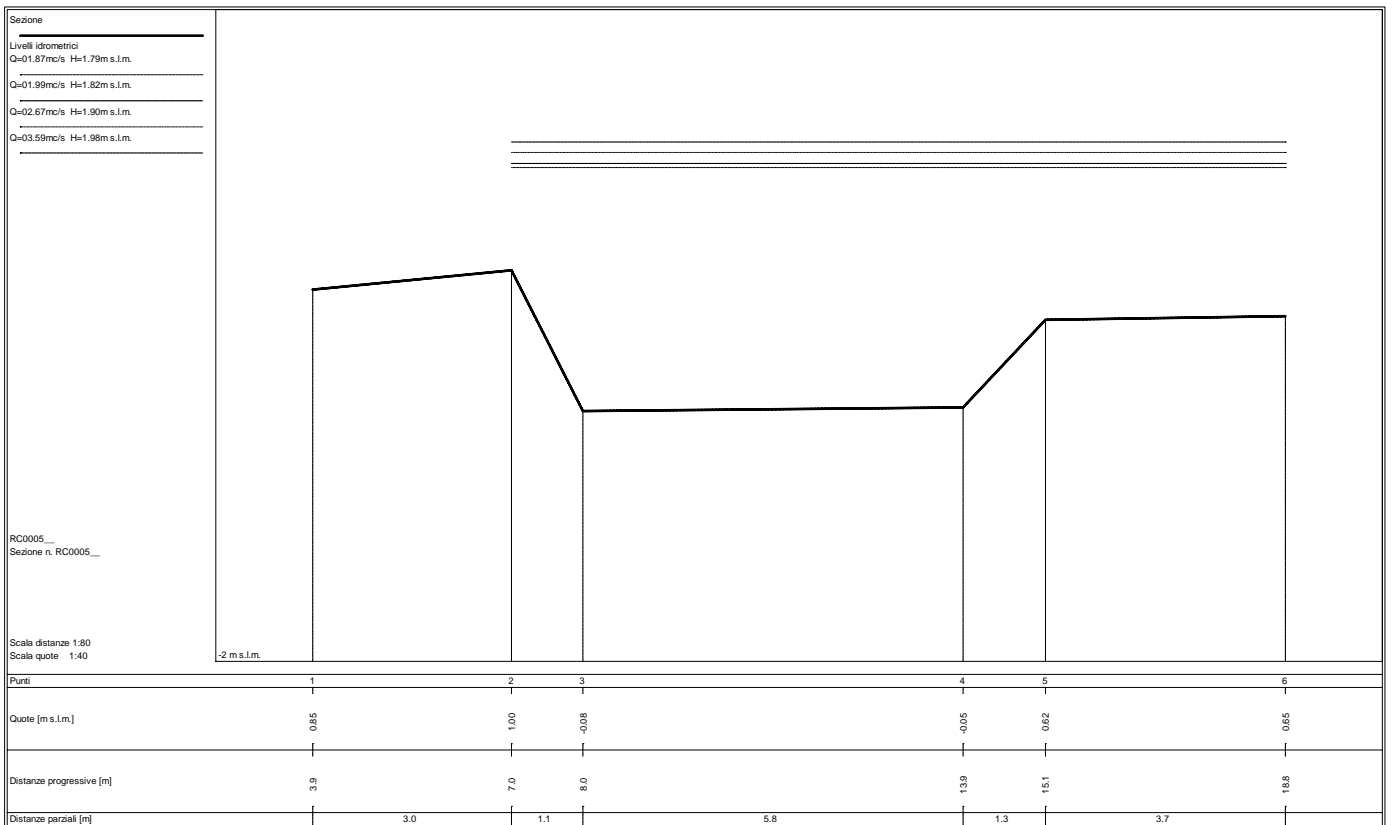
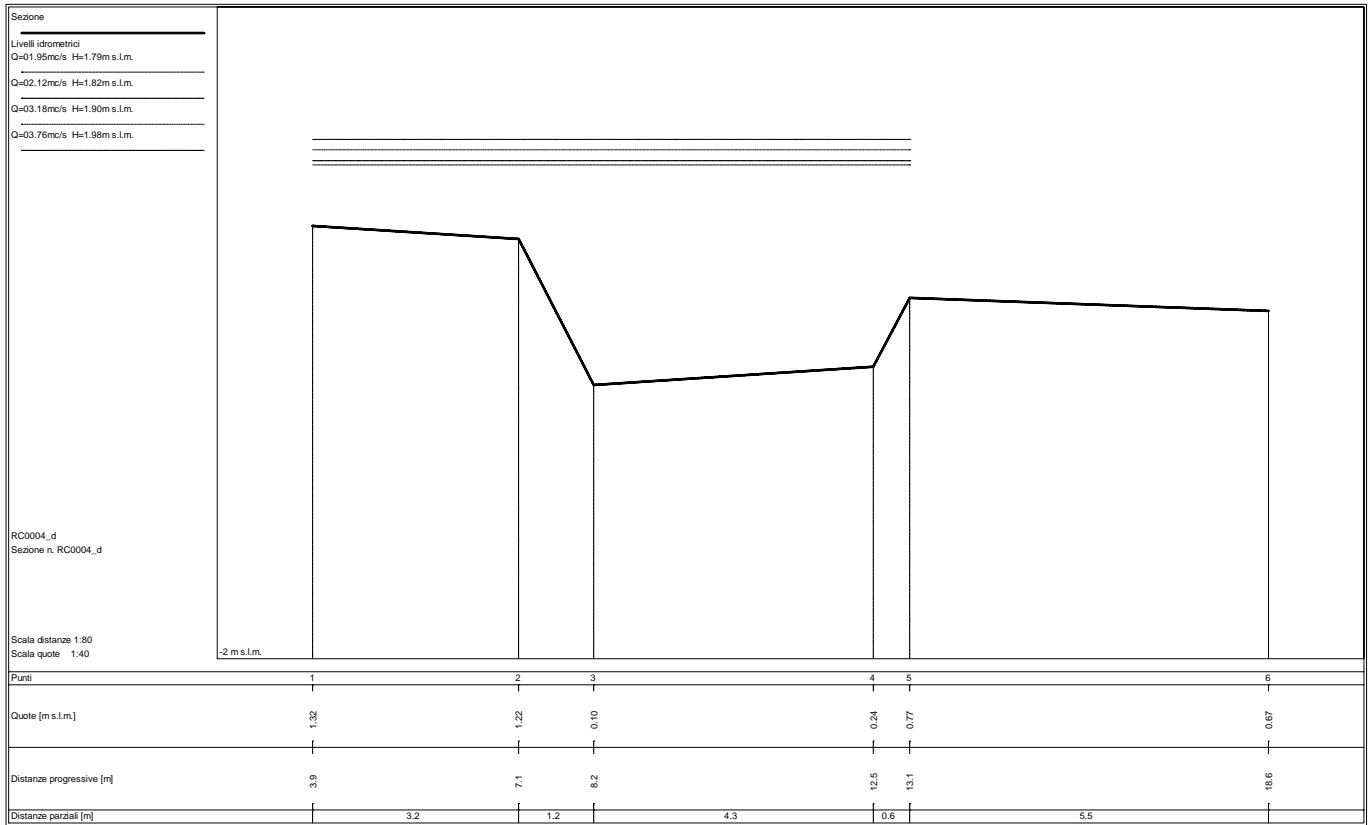

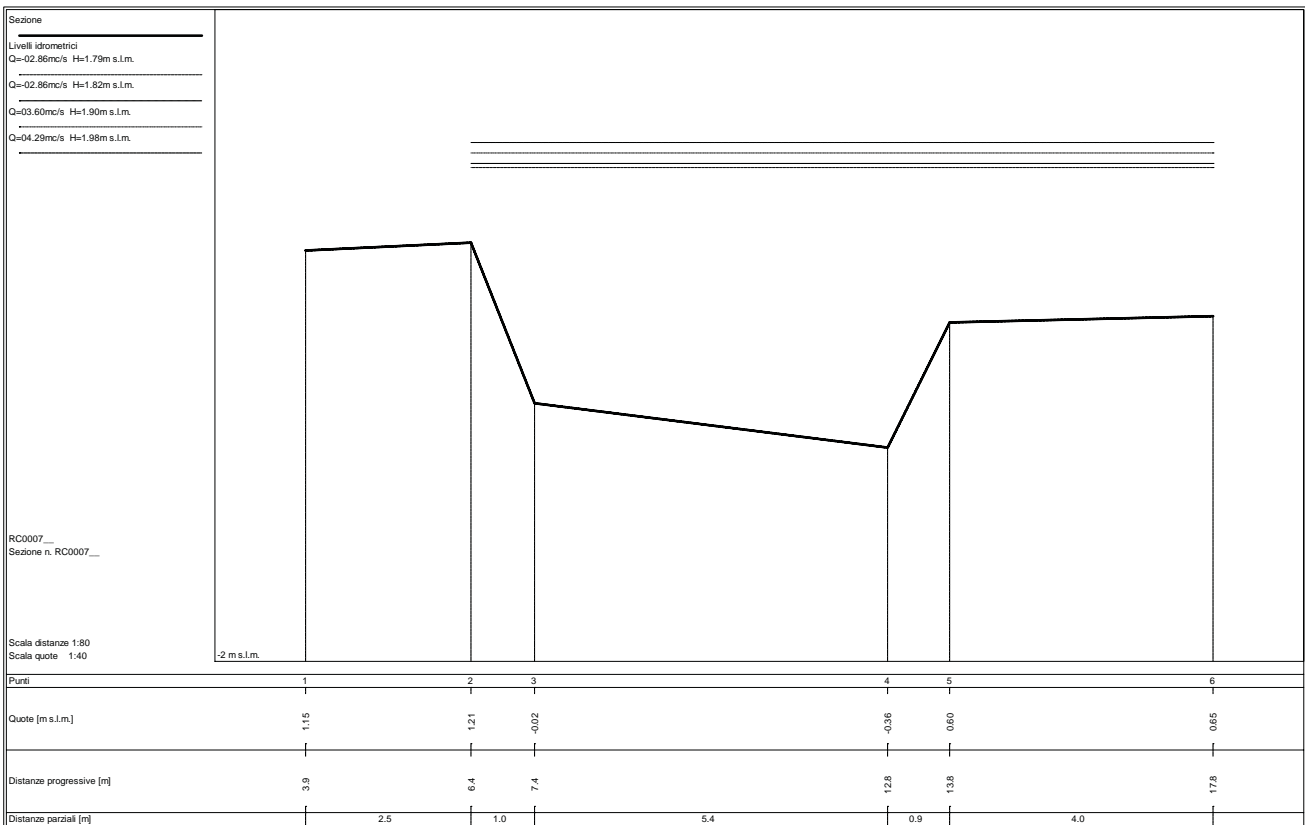
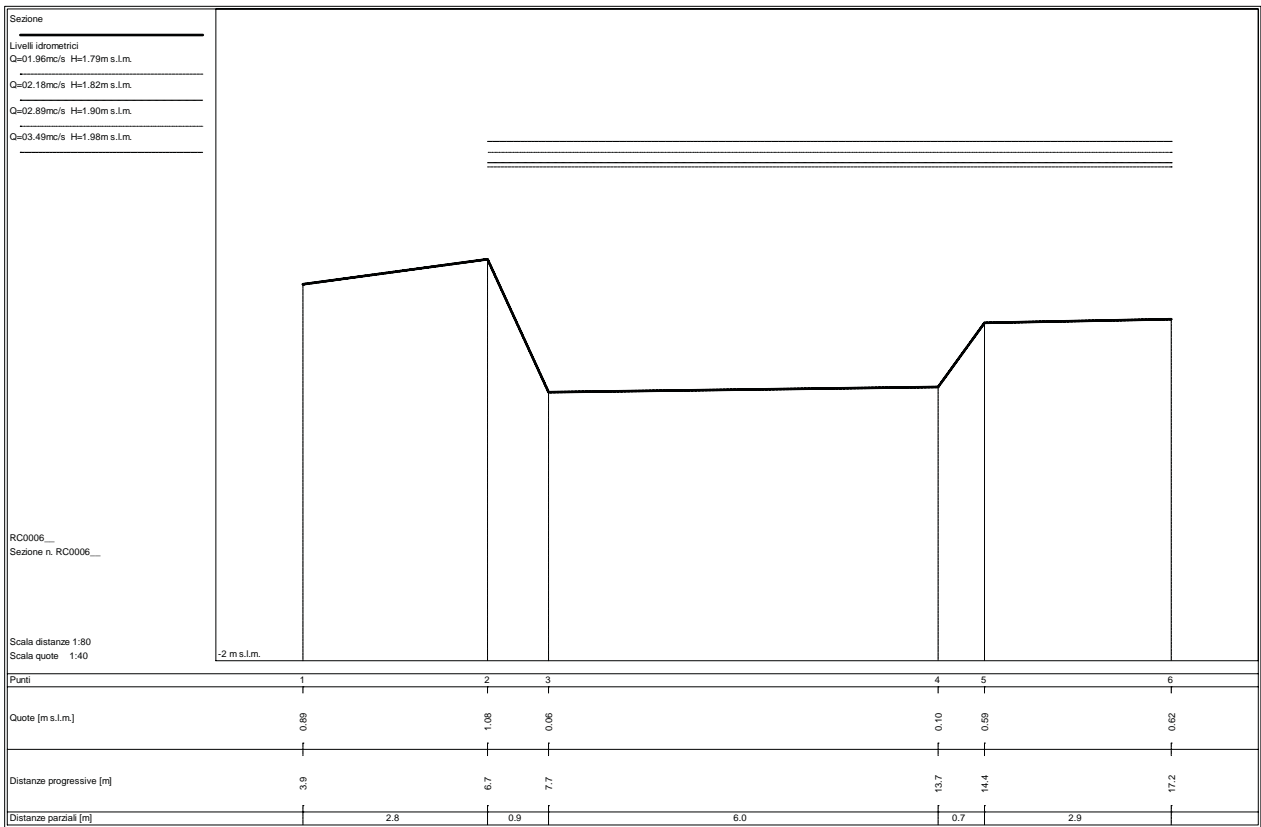

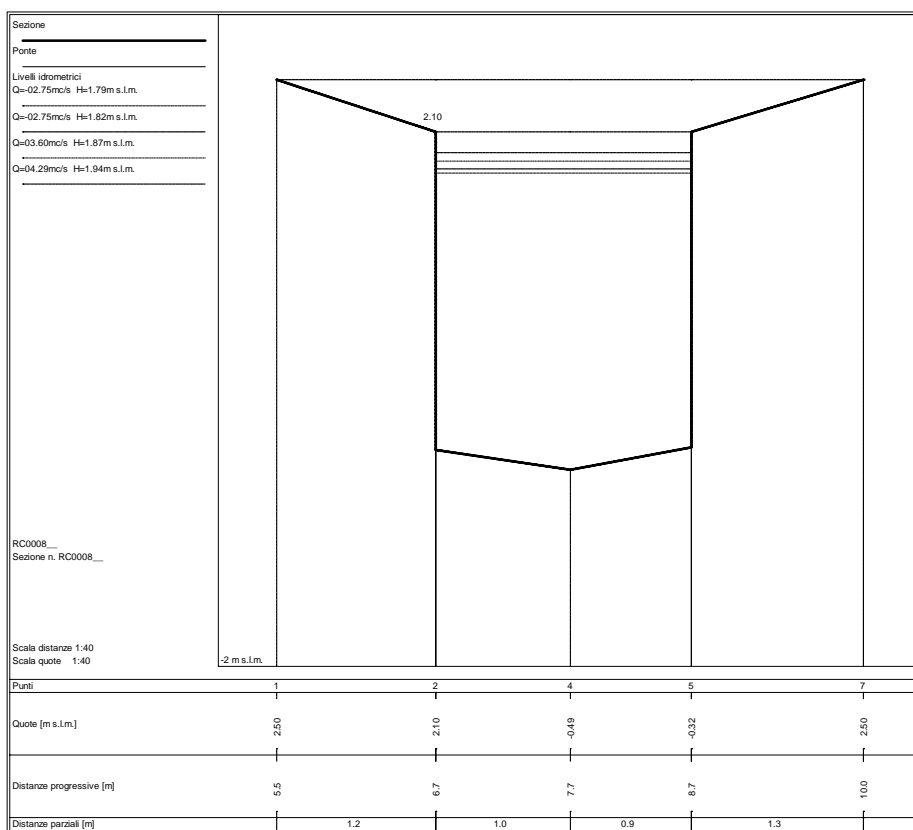
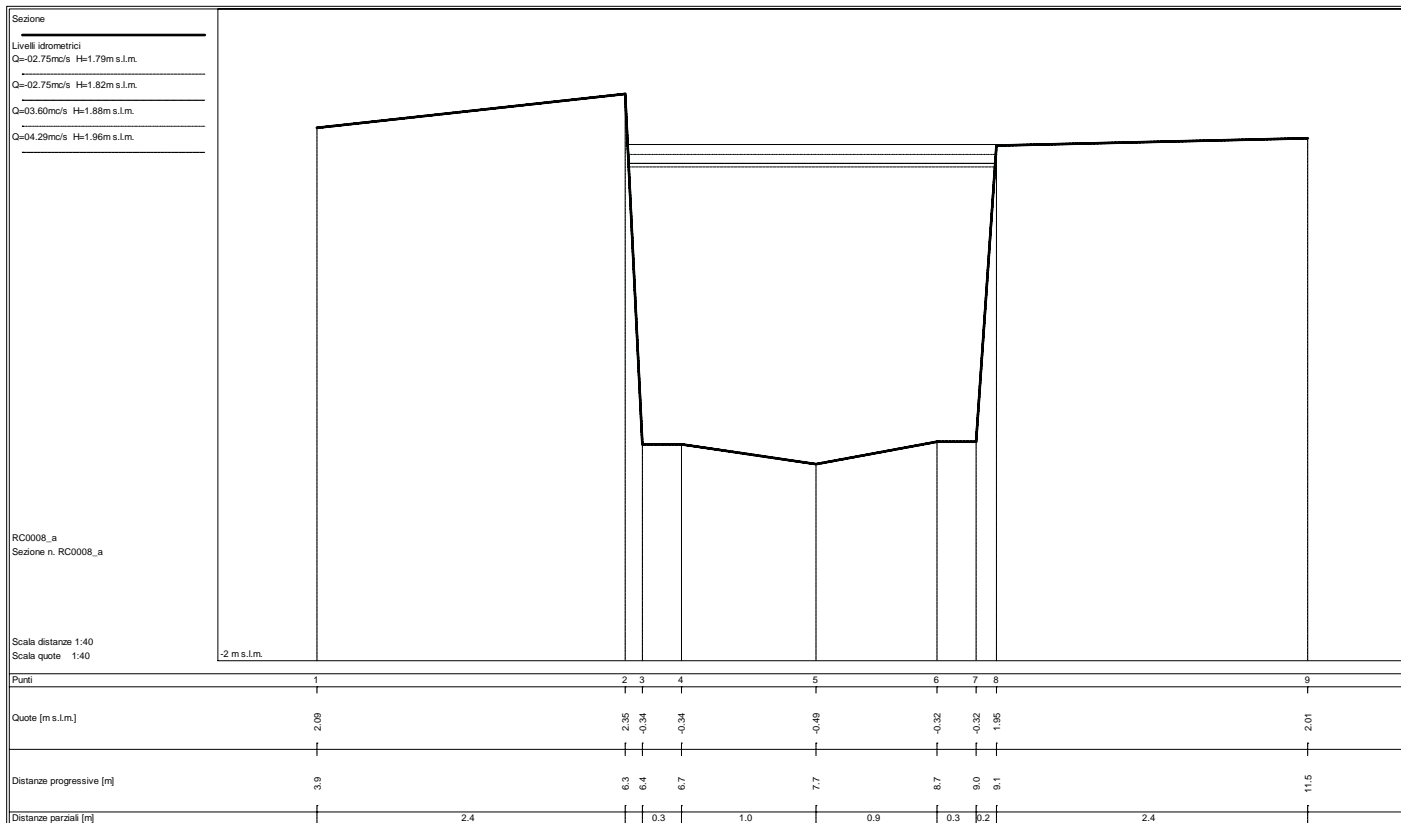

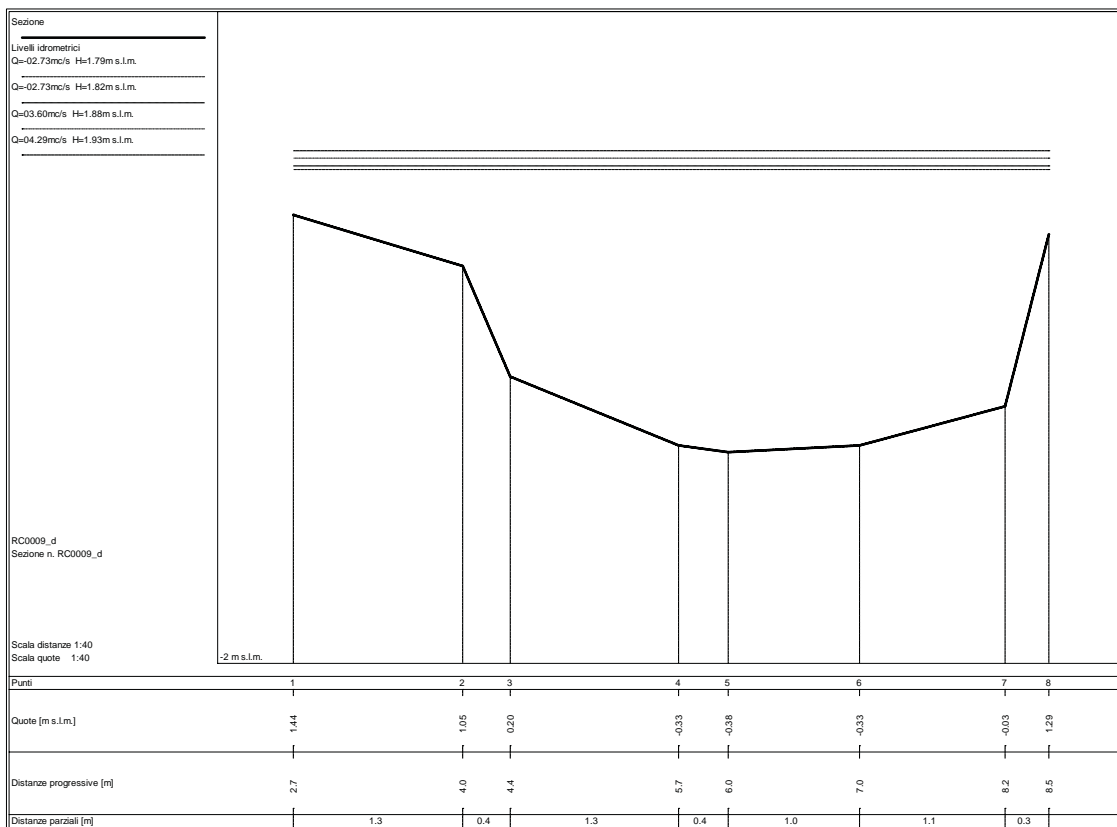
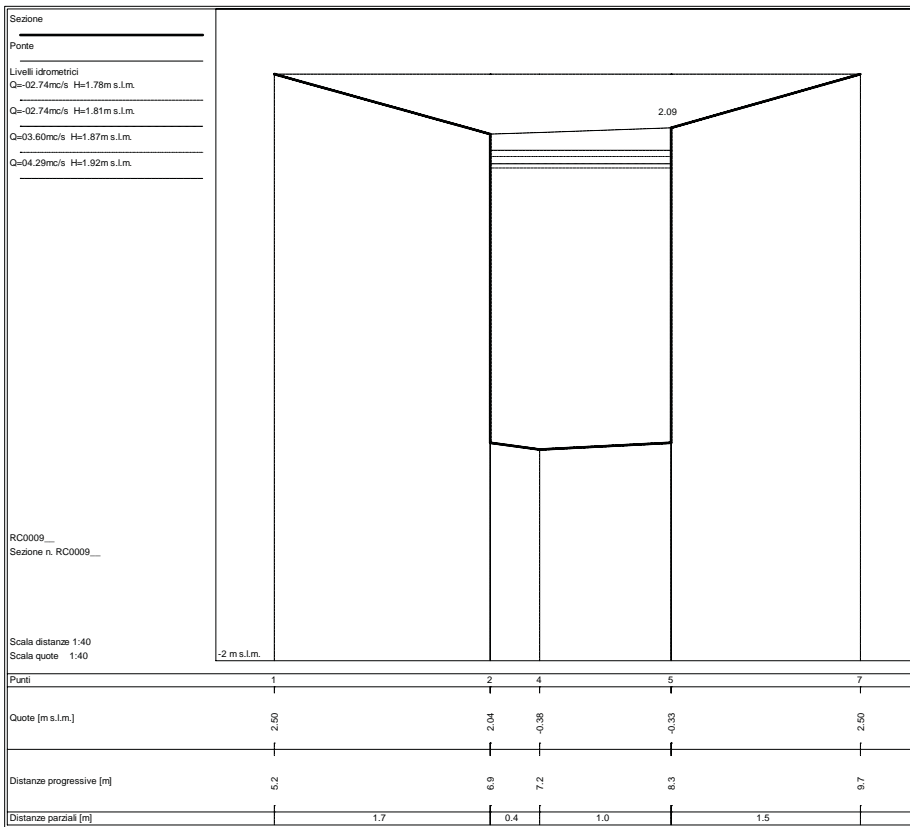

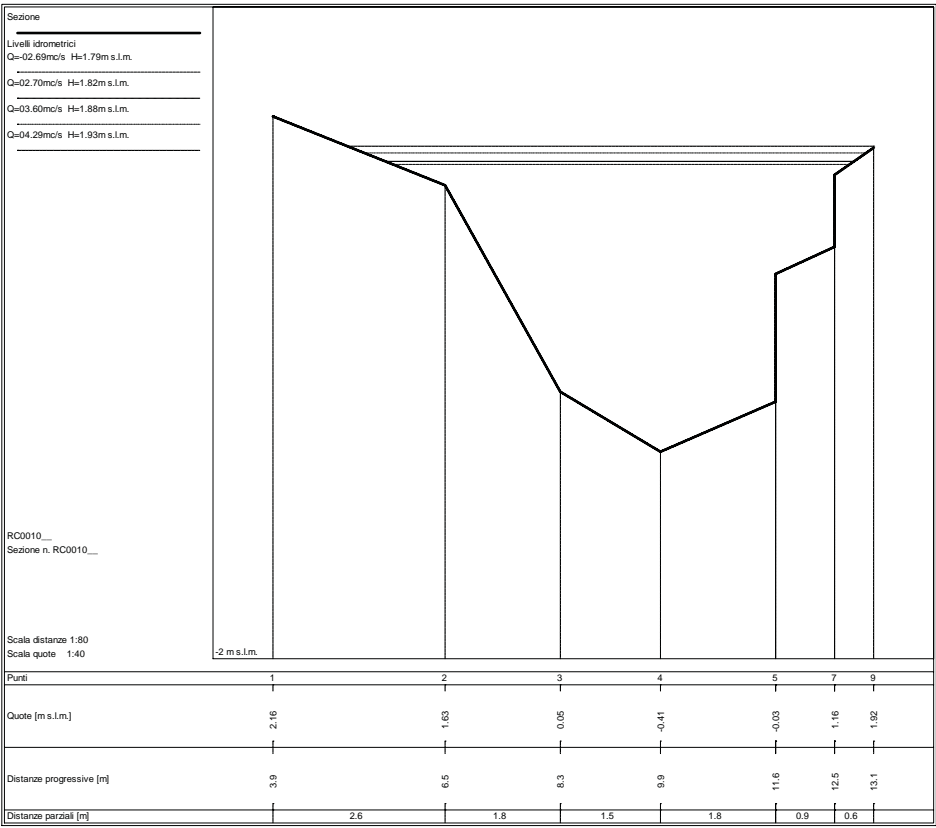

STATO ATTUALE
Sezioni fluviali fosso San Remigio

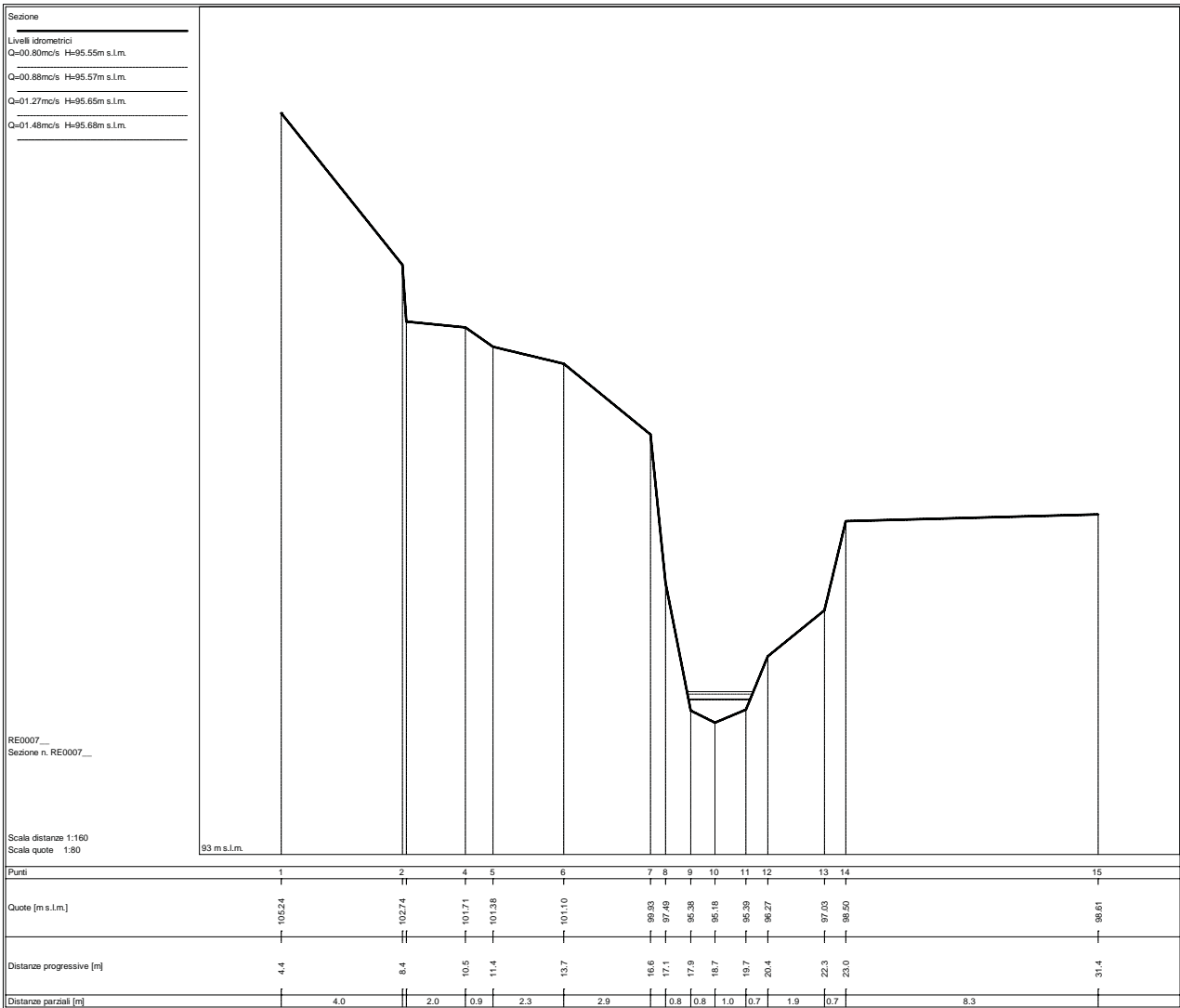
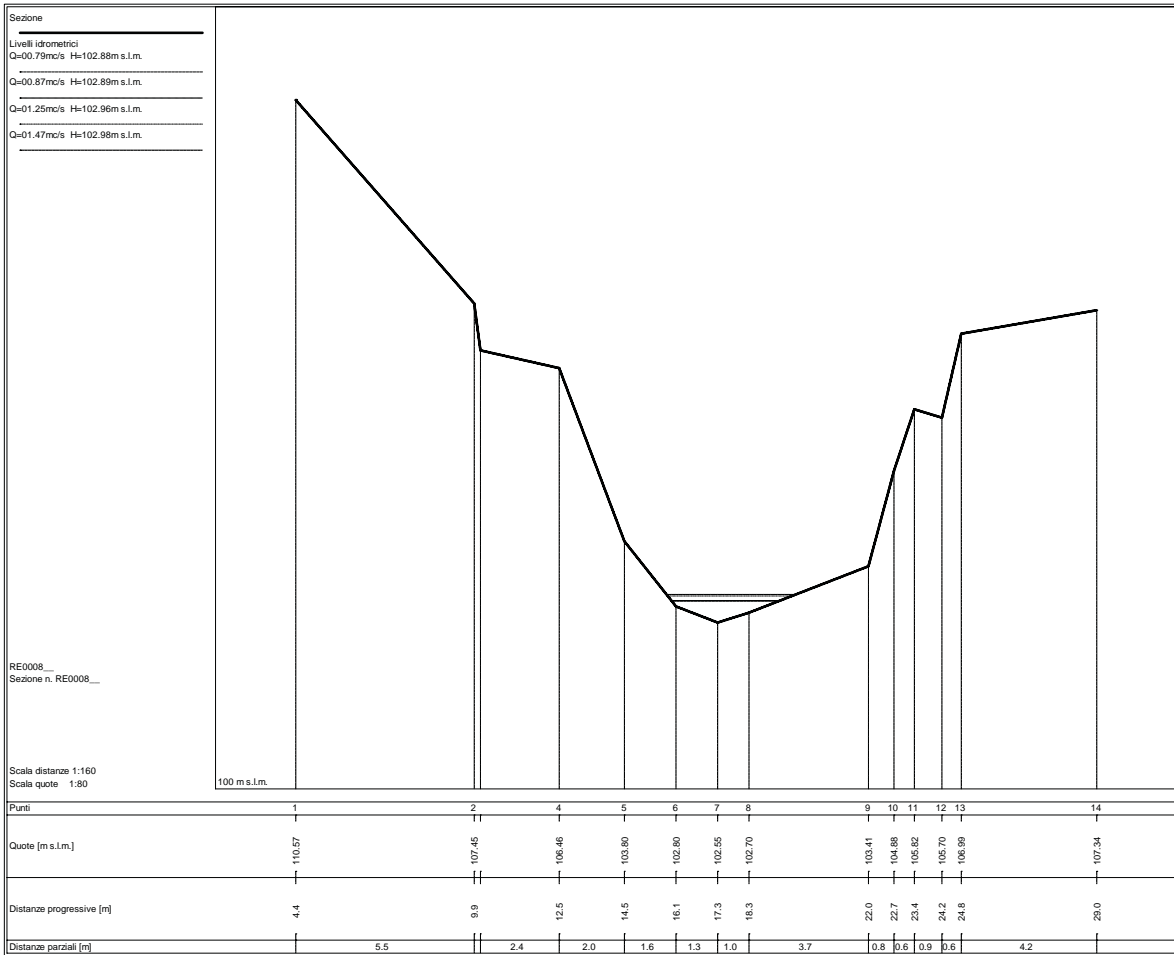

Sezione
 Livelli idrometrici
 Q=0.81mc/s H=89.83m s.l.m.
 Q=0.88mc/s H=89.84m s.l.m.
 Q=1.28mc/s H=89.92m s.l.m.
 Q=1.48mc/s H=89.96m s.l.m.

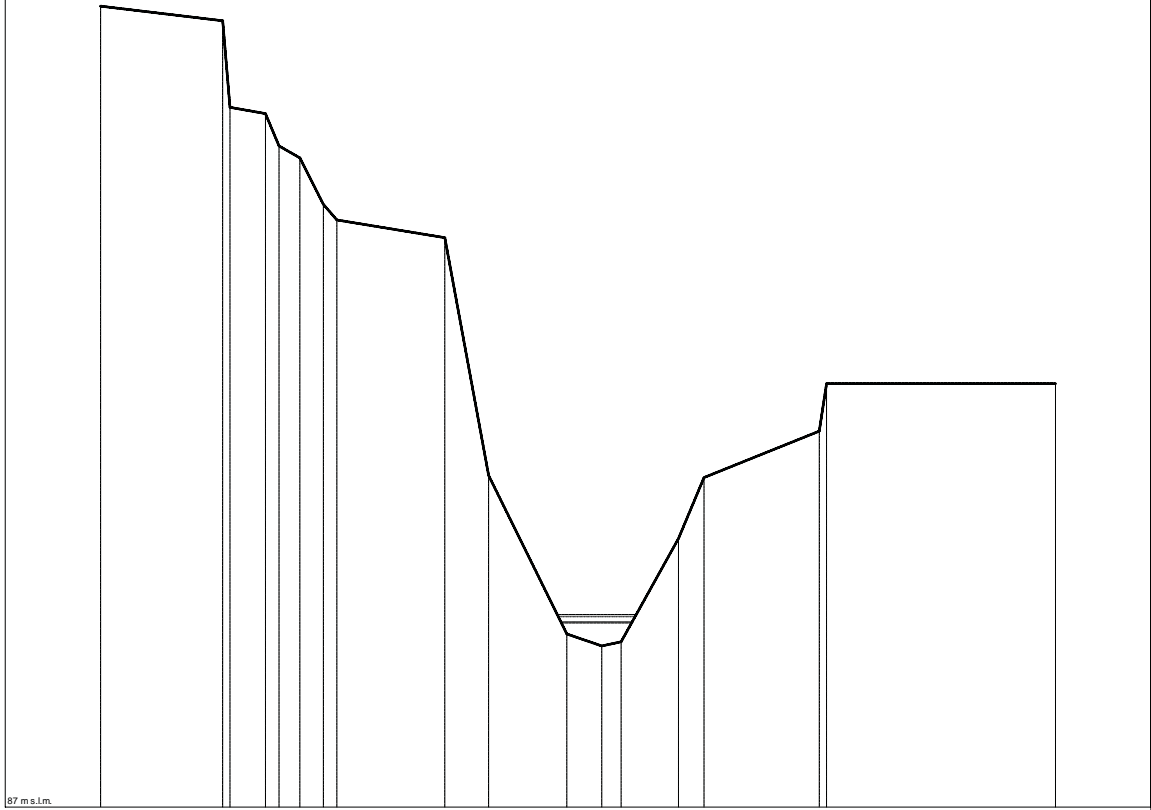

RE0006_
 Sezione n. RE0006_

Scala distanze 1:160
 Scala quote 1:80

87 m s.l.m.

Punti	1	2	4	5	6	7	8	9	10	11	12	13	14	15	16	18
Quote [m s.l.m.]	99.29	99.07	97.64	97.14	96.96	96.24	96.01	95.73	92.09	89.66	89.47	89.54	91.12	92.05	92.77	93.50
Distanze progressive [m]	4.4	8.1	9.4	9.9	10.5	11.2	11.6	14.9	16.3	18.7	19.8	20.3	22.1	22.9	26.4	33.7
Distanze parziali [m]		3.7	1.1	0.6	0.7		3.3	1.3	2.4	1.1	0.6	1.8	0.8	3.5		7.0

Sezione
 Livelli idrometrici
 Q=0.82mc/s H=88.27m s.l.m.
 Q=0.89mc/s H=88.29m s.l.m.
 Q=1.29mc/s H=88.38m s.l.m.
 Q=1.49mc/s H=88.42m s.l.m.

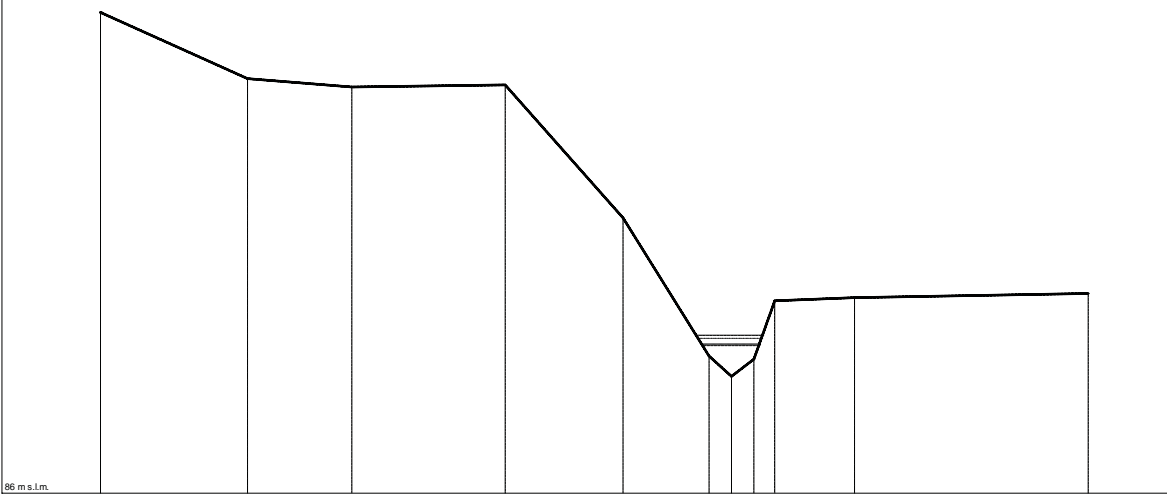

RE0005_
 Sezione n. RE0005_

Scala distanze 1:160
 Scala quote 1:80

86 m s.l.m.

Punti	1	2	3	4	5	6	7	8	9	10	11
Quote [m s.l.m.]	93.38	92.36	92.23	92.26	90.23	88.11	87.79	88.08	88.95	89.00	88.07
Distanze progressive [m]	4.4	6.9	12.1	16.8	20.4	25.0	23.7	24.4	25.1	27.5	34.7
Distanze parziali [m]		4.5	3.2	4.7	3.6	2.6	0.7	0.7	0.6	2.5	7.2

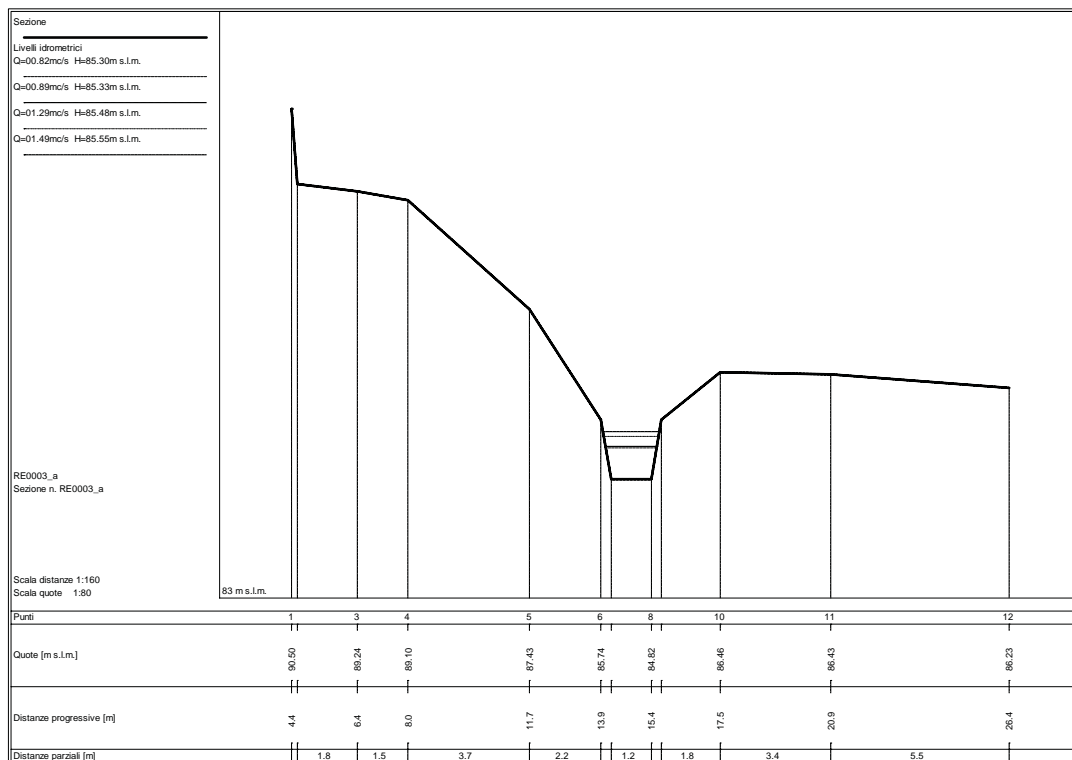
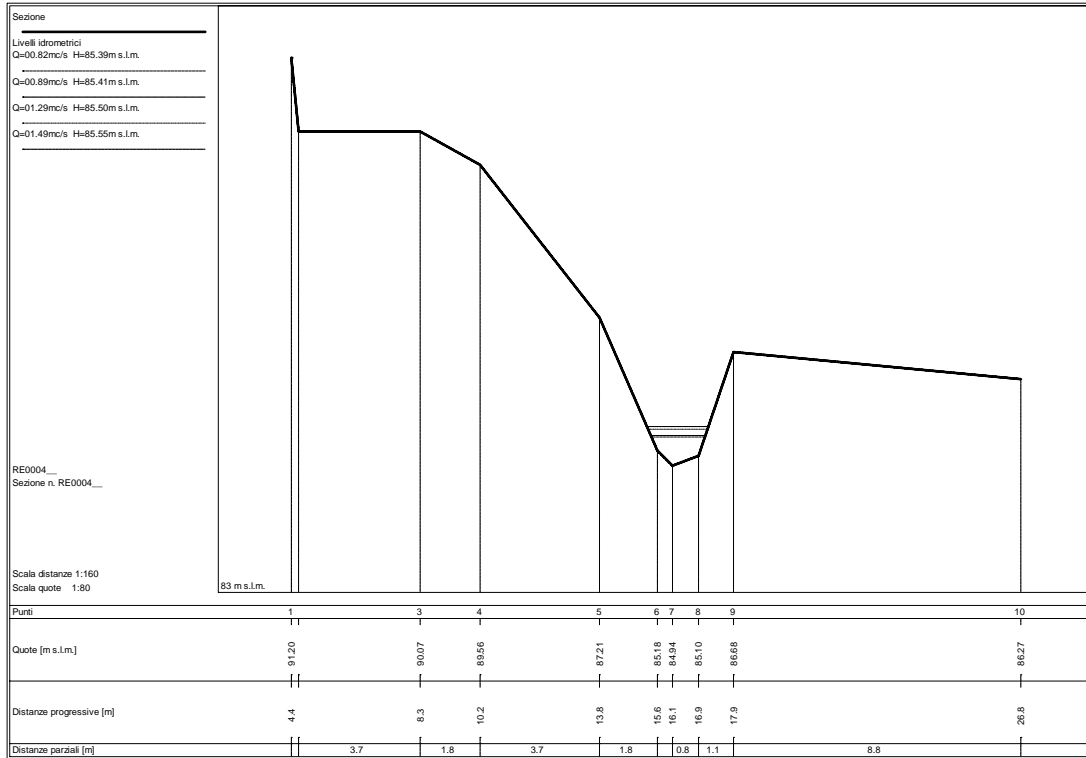

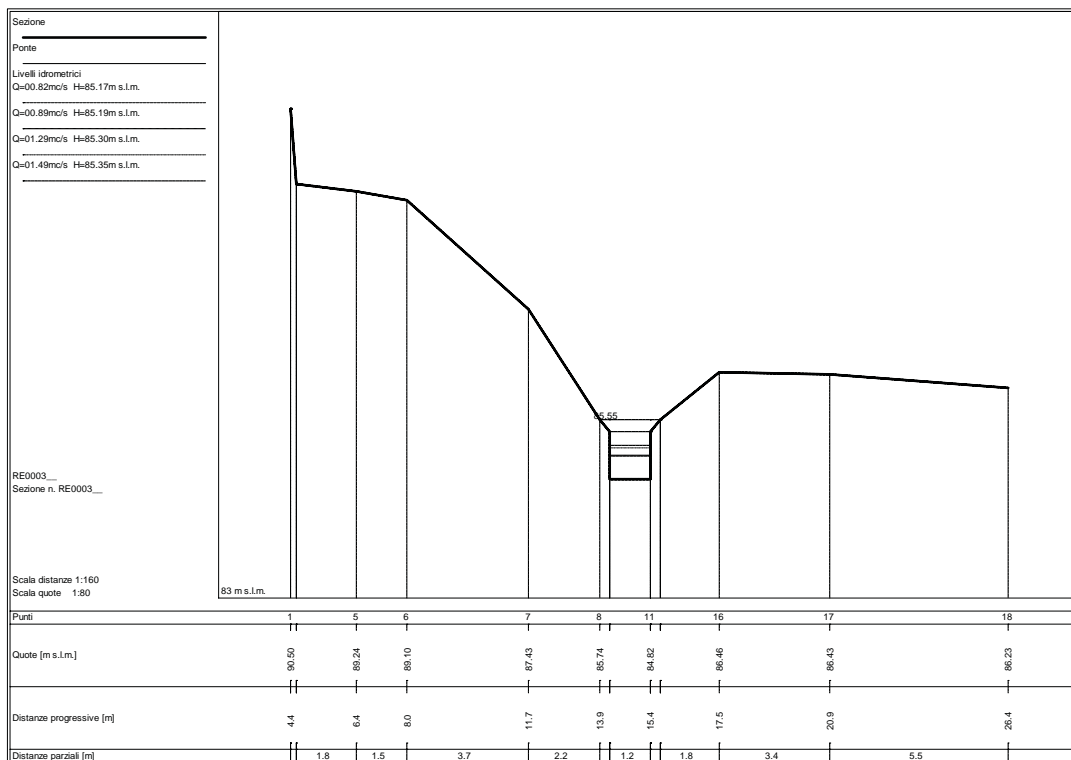
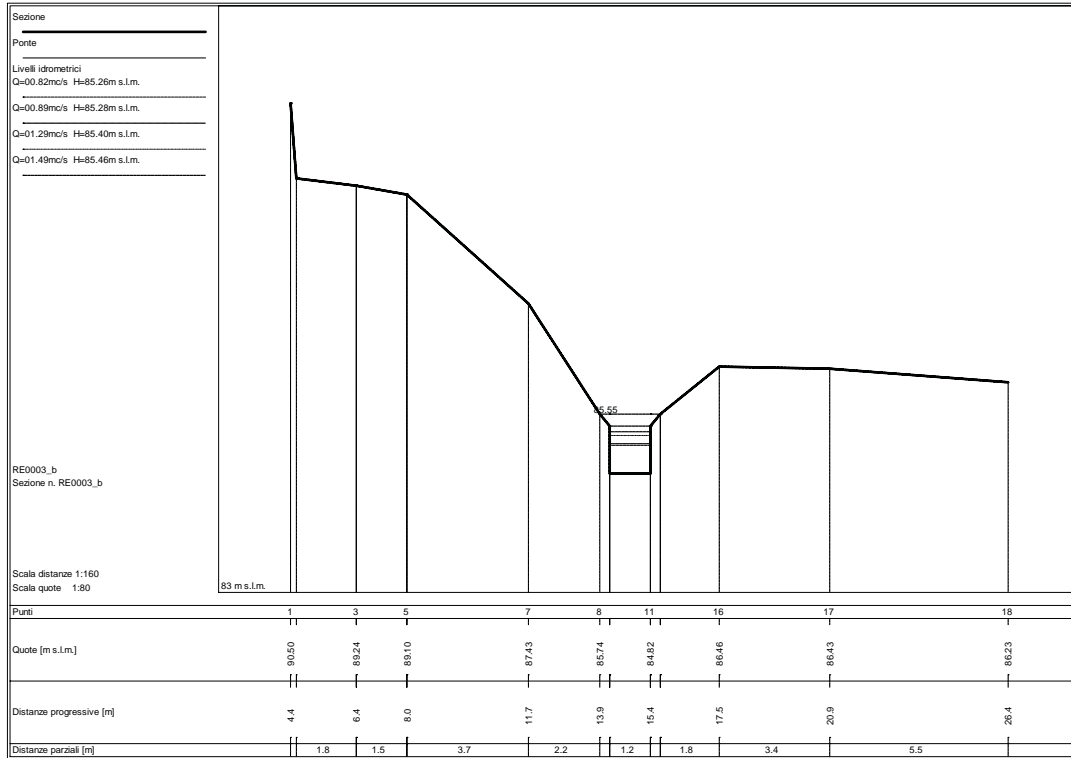

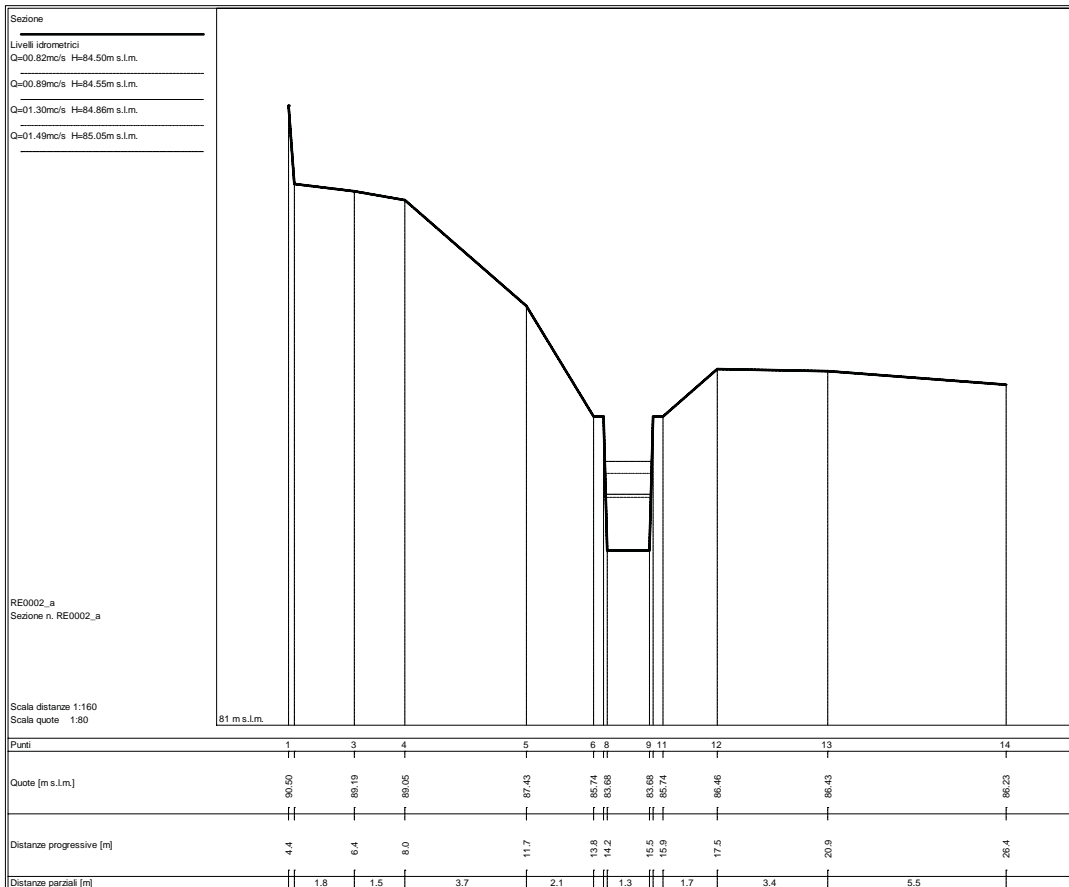
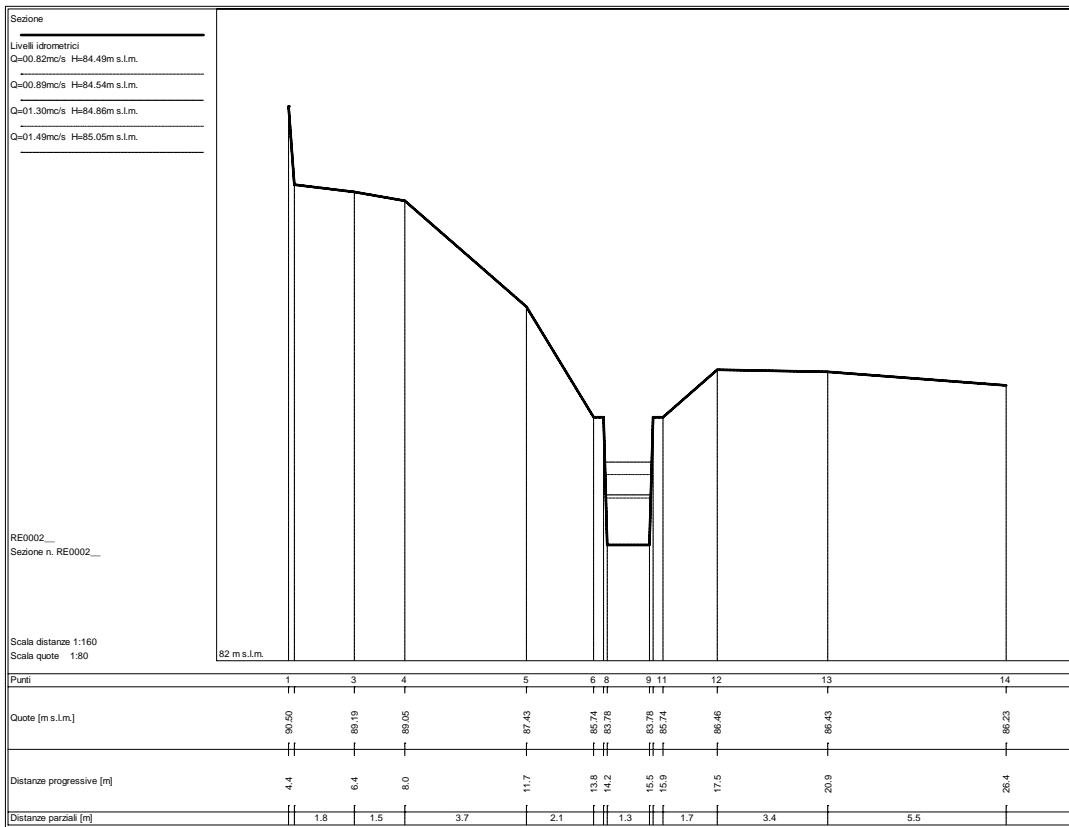

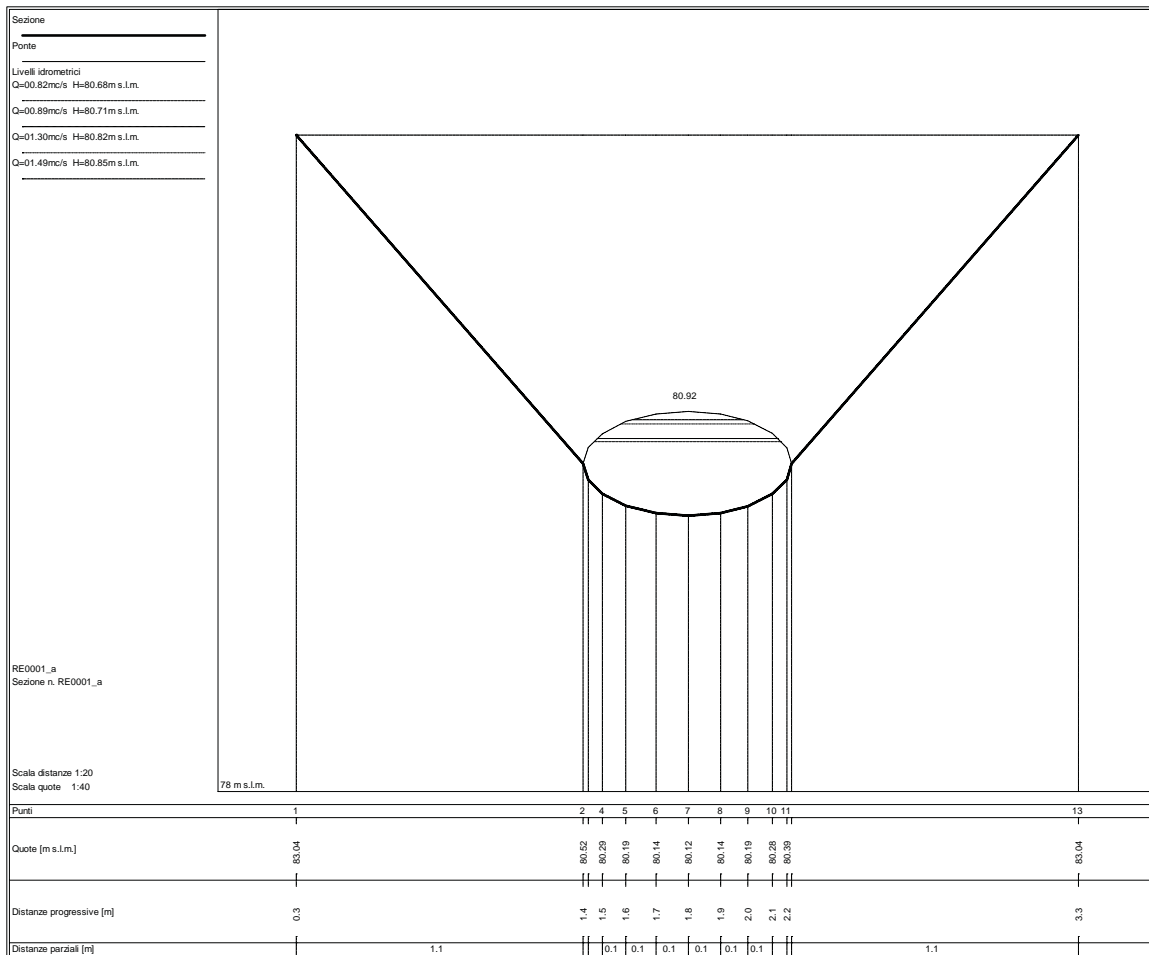
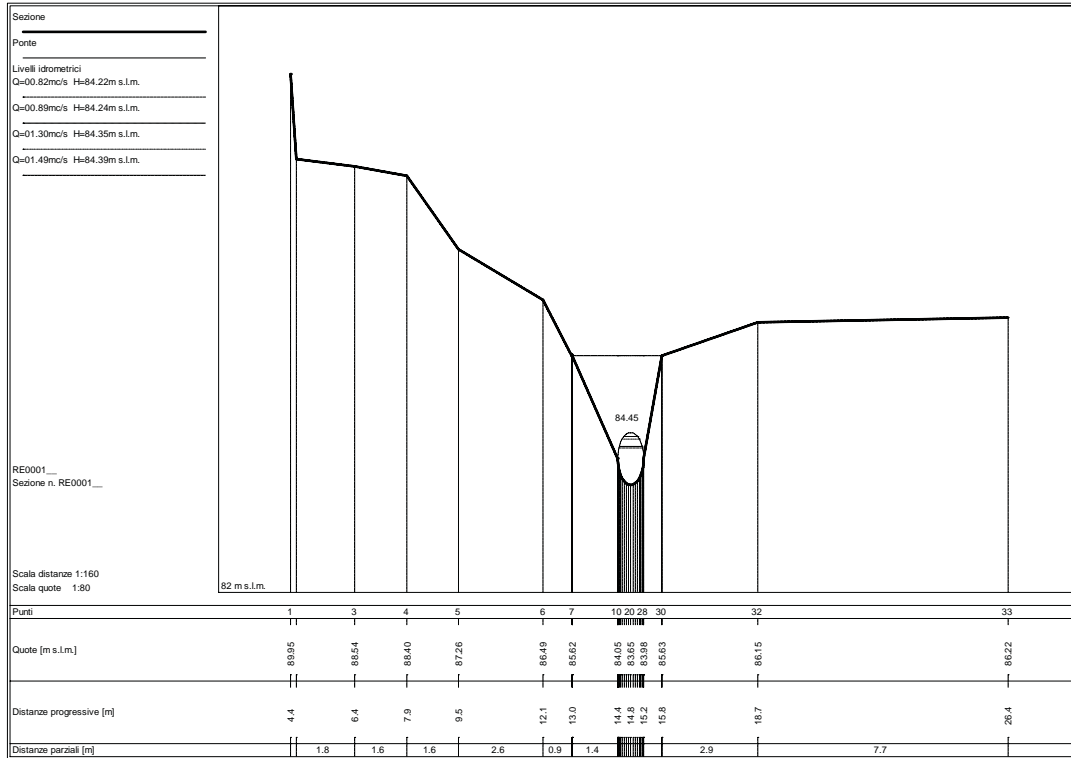

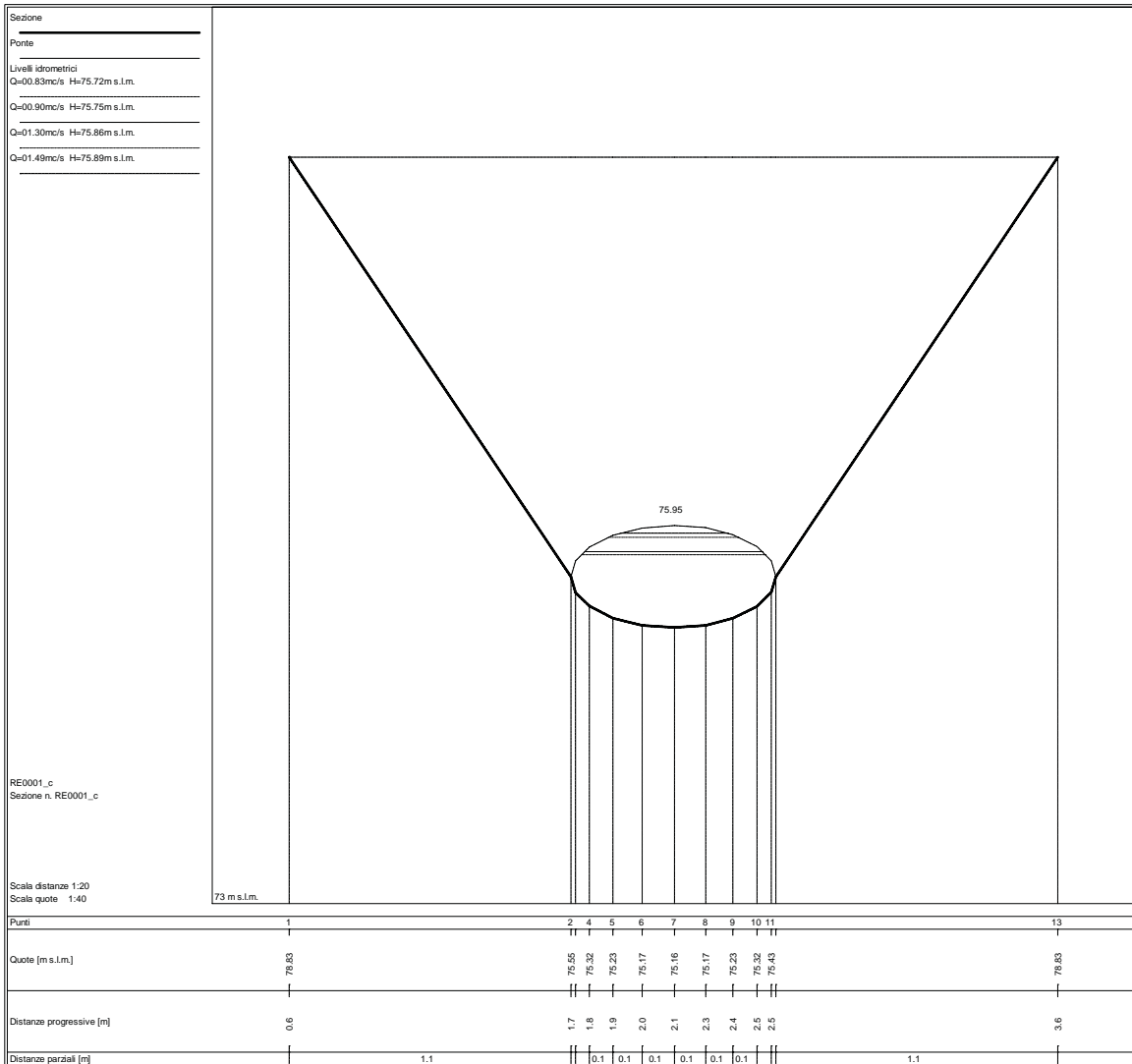
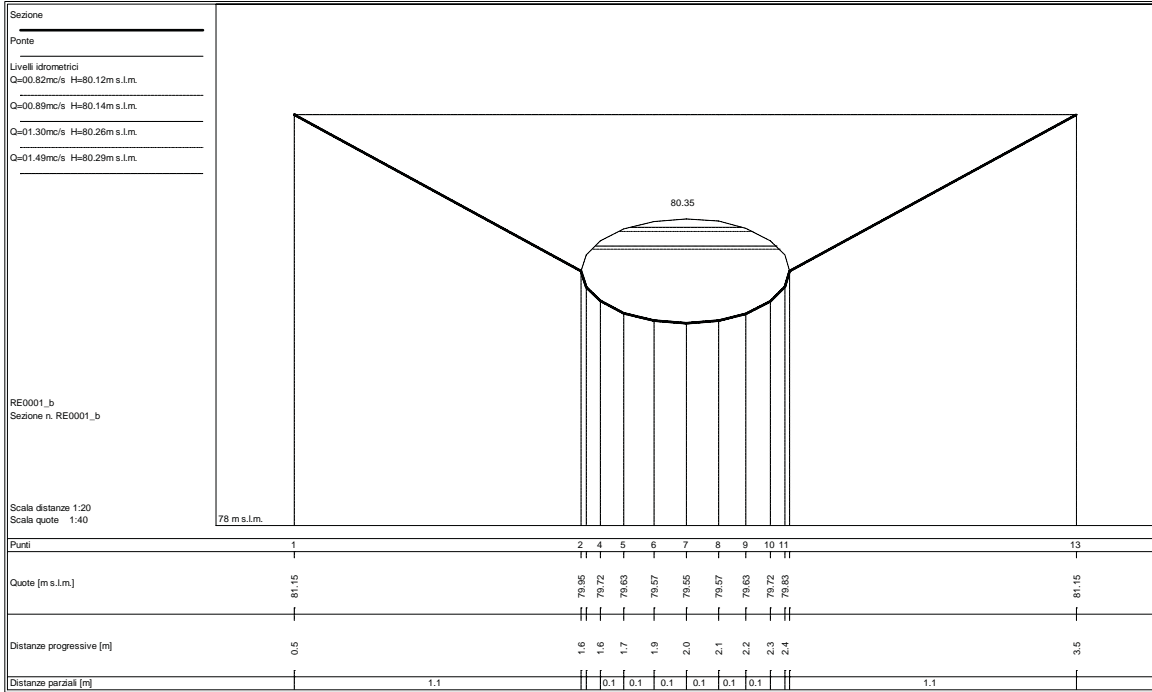

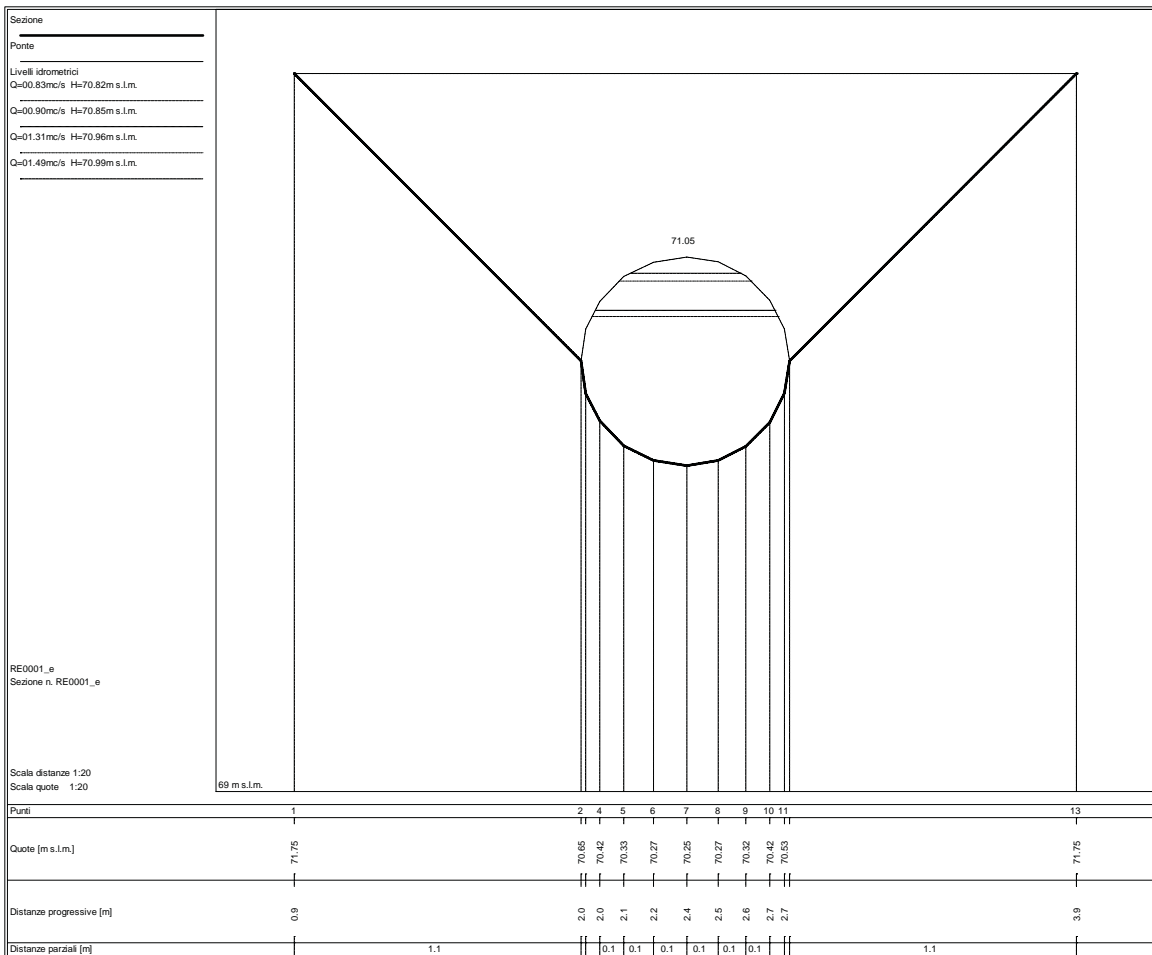
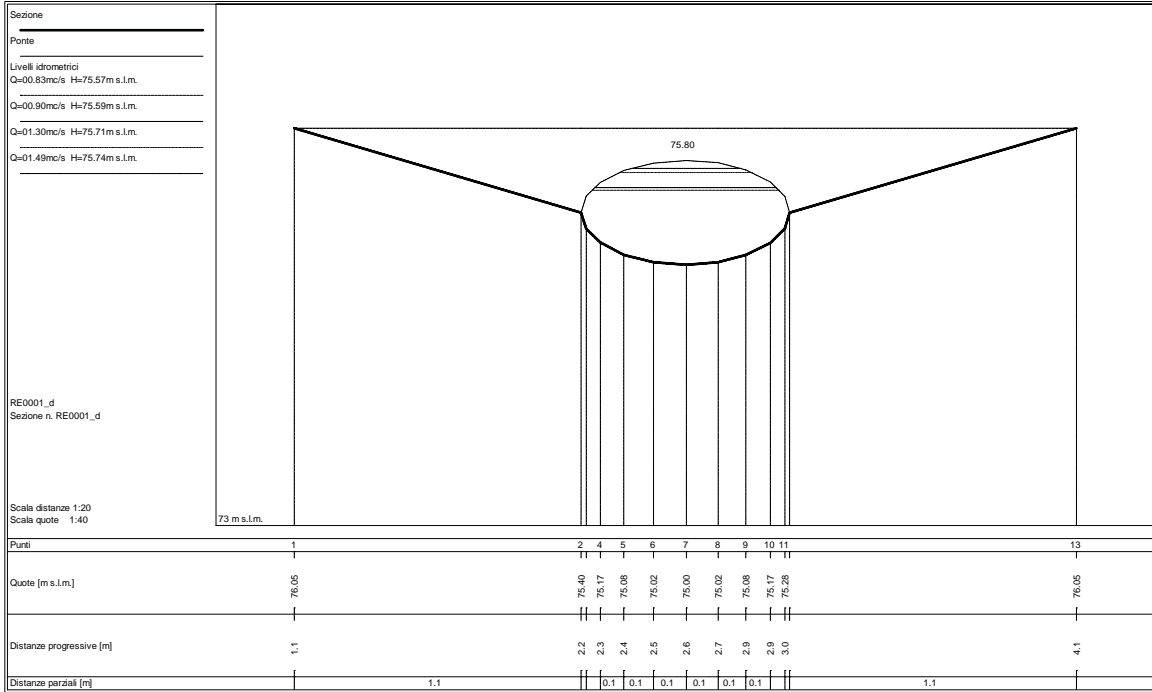

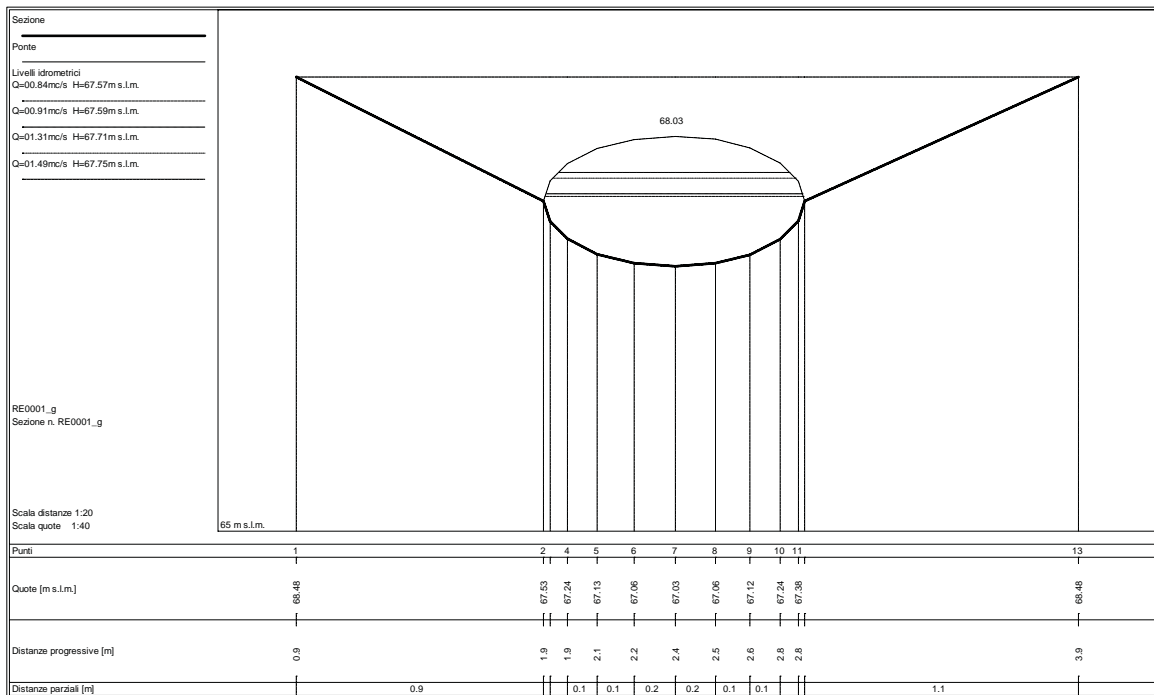
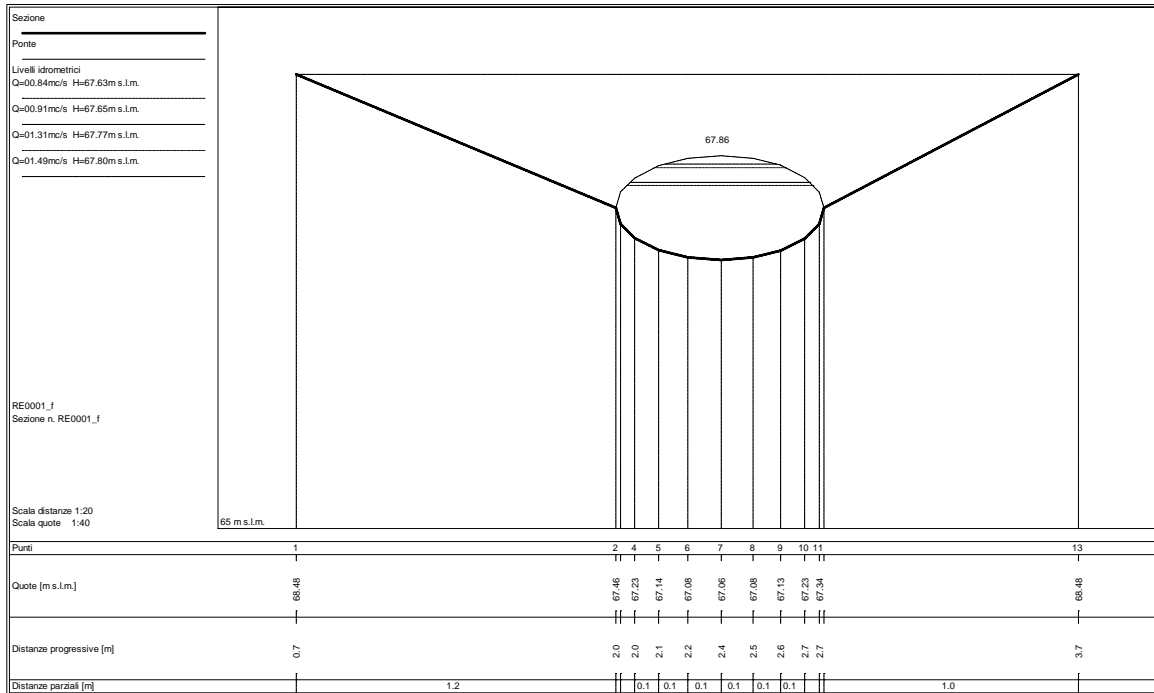

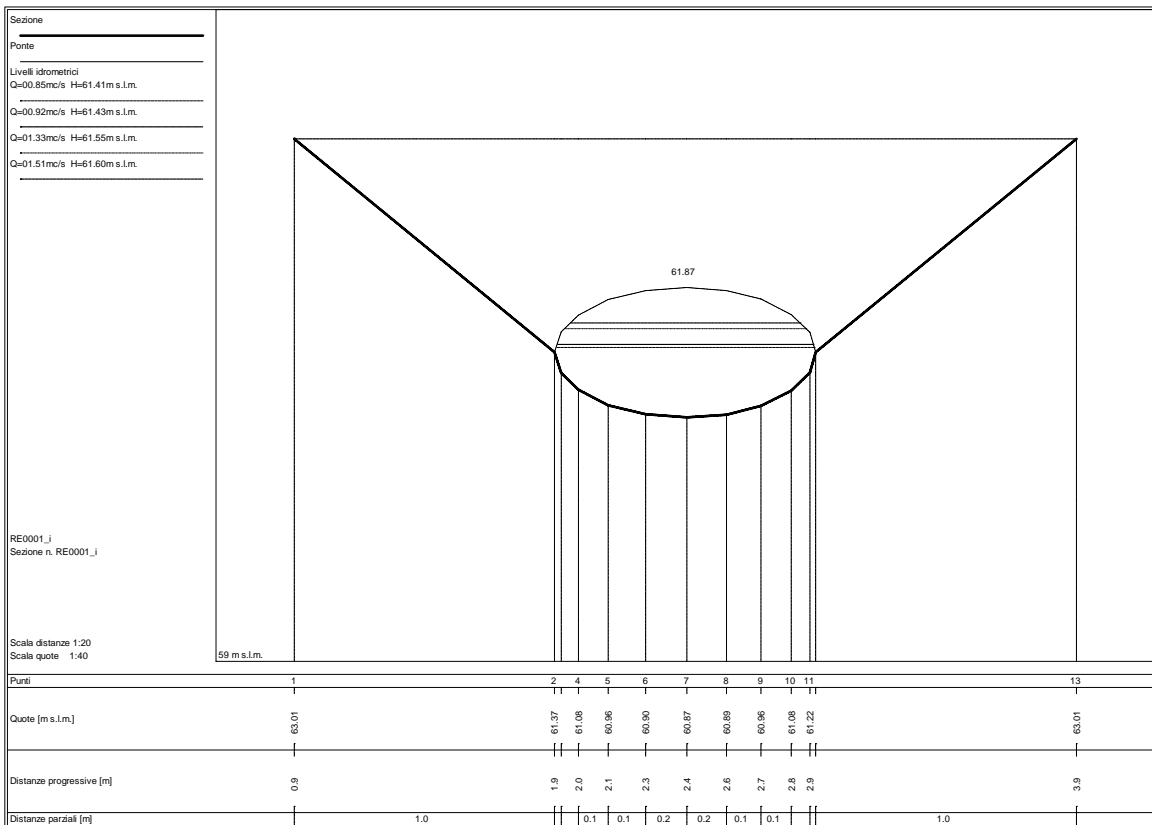
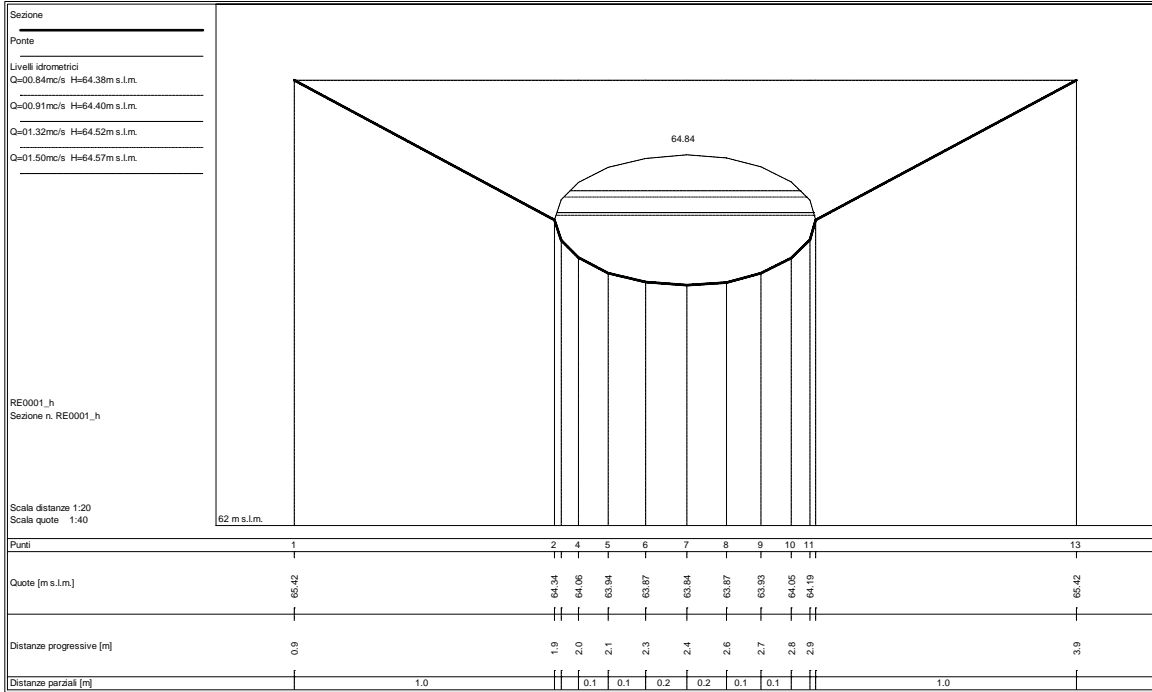

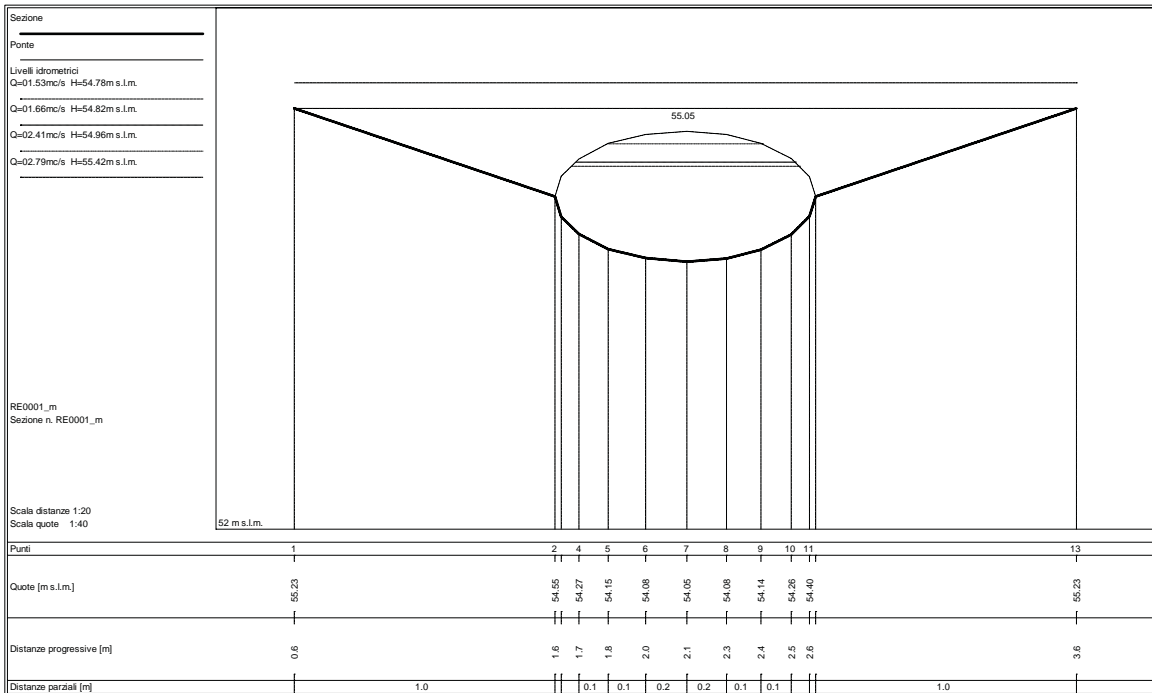
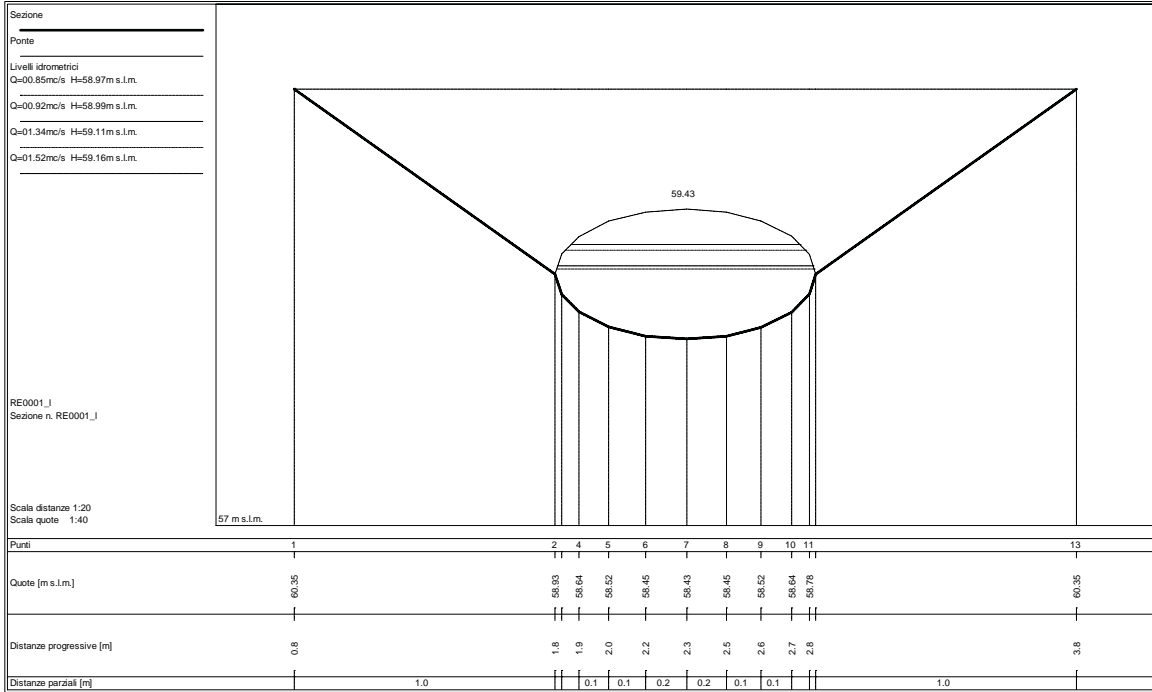

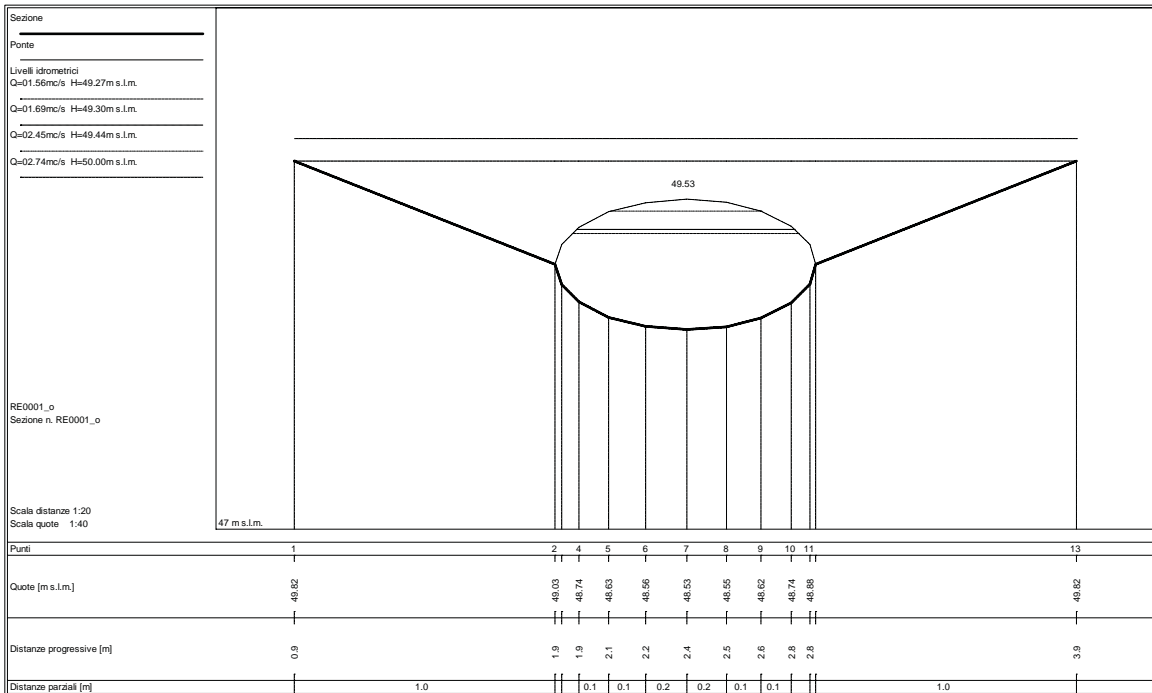
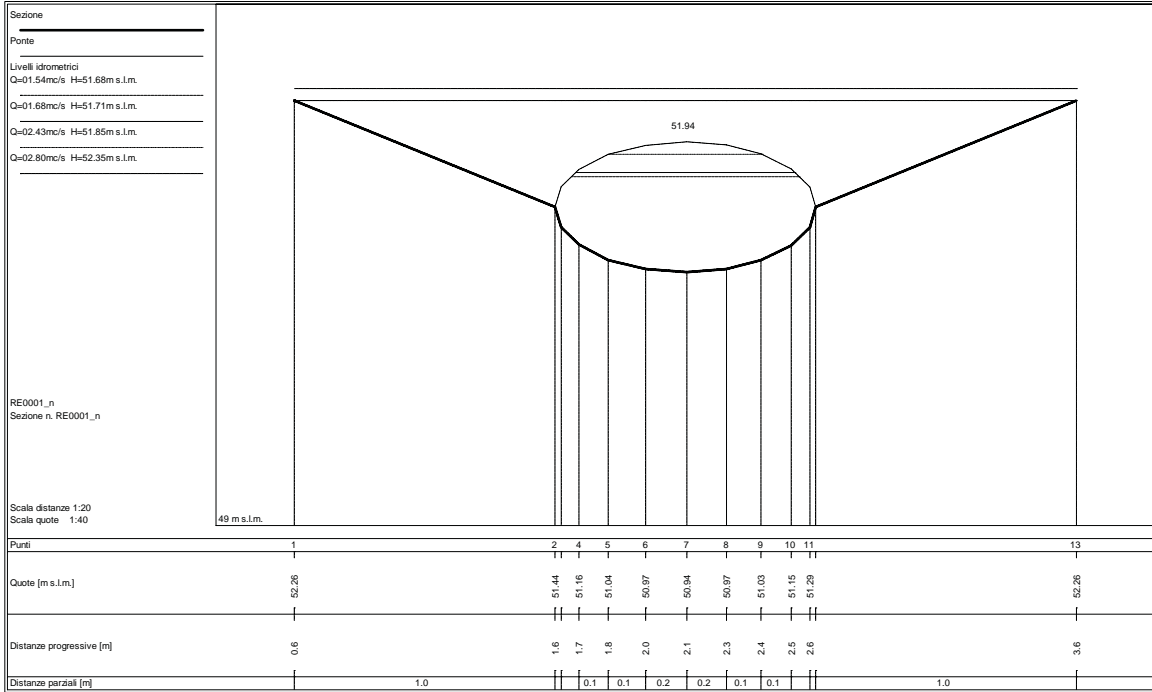

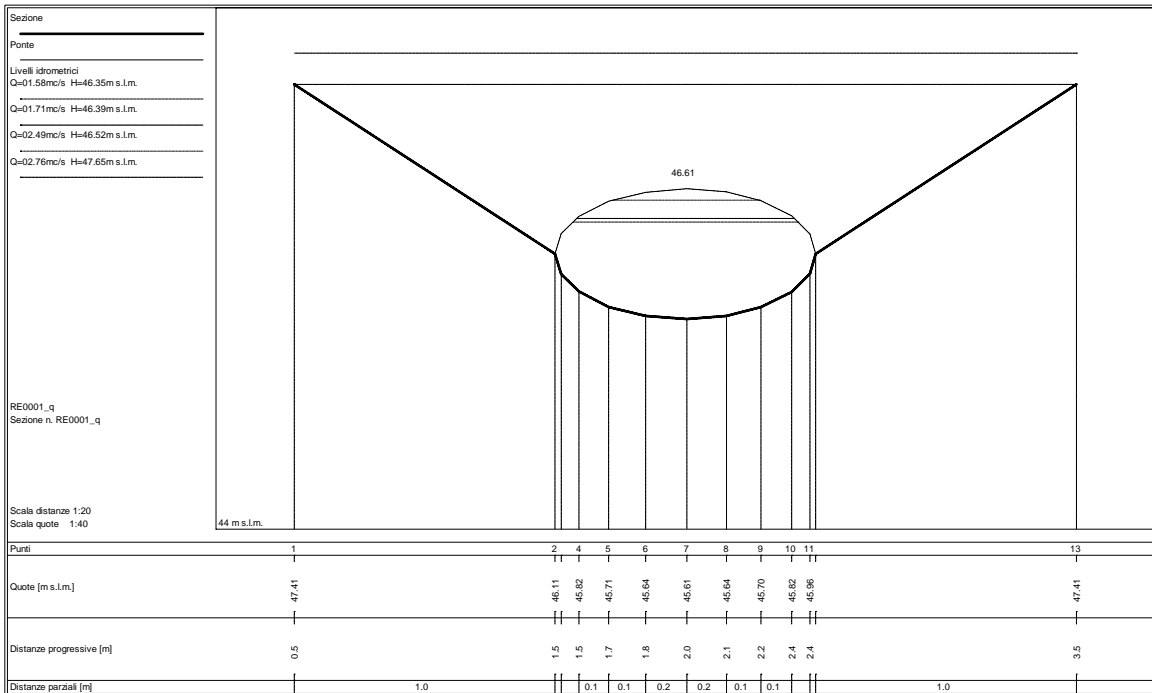
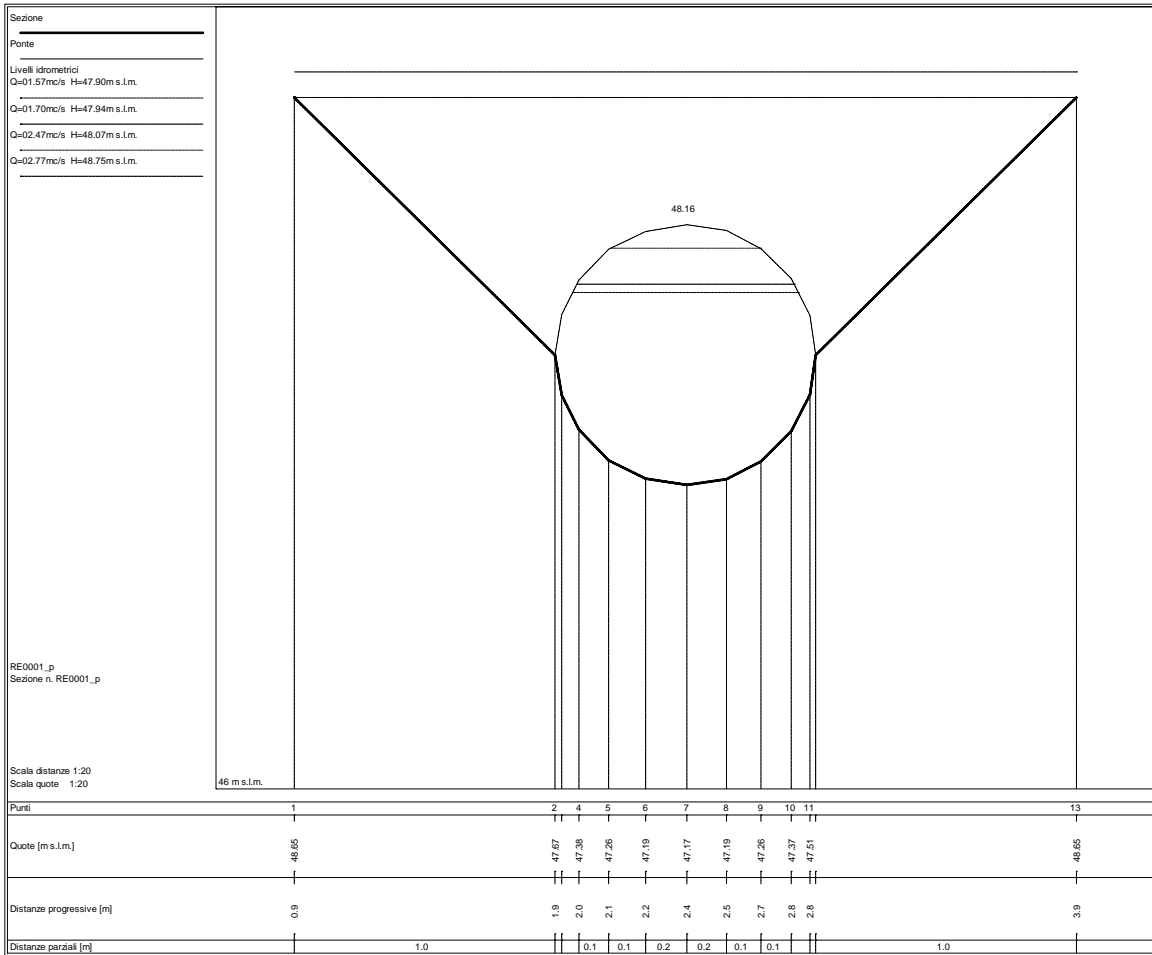

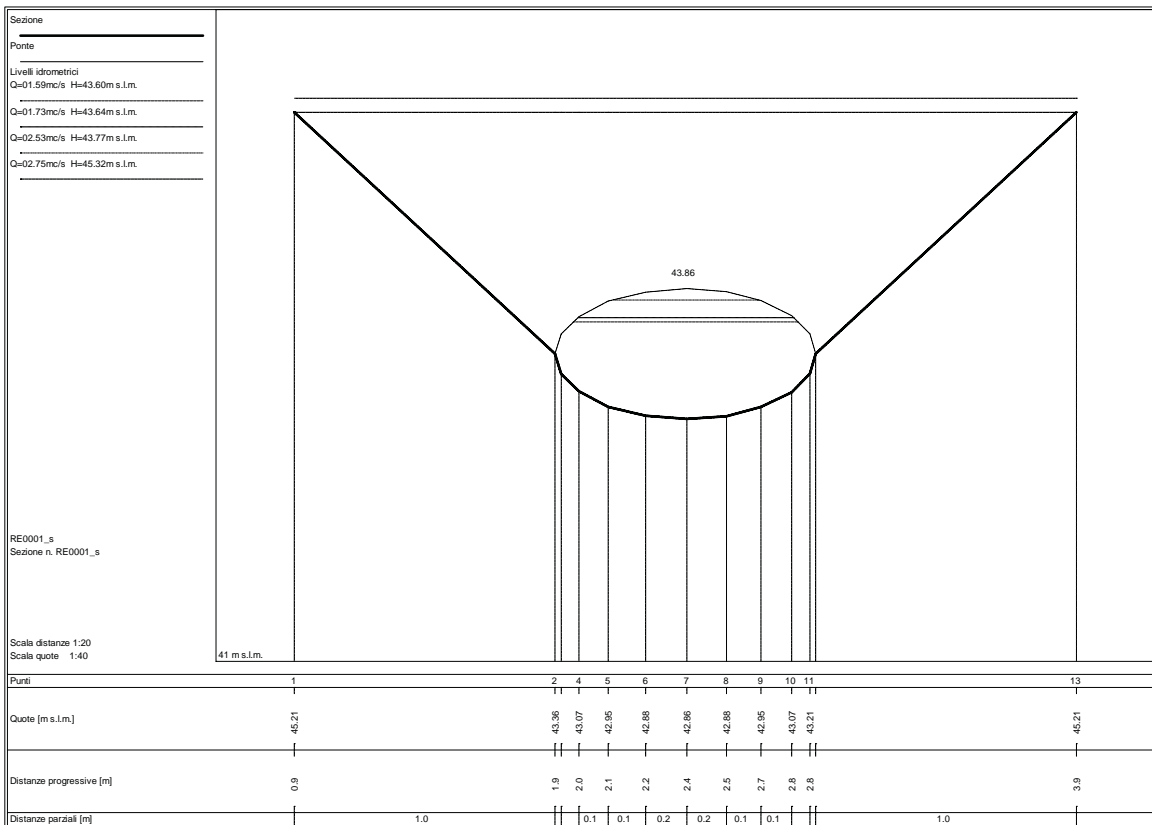
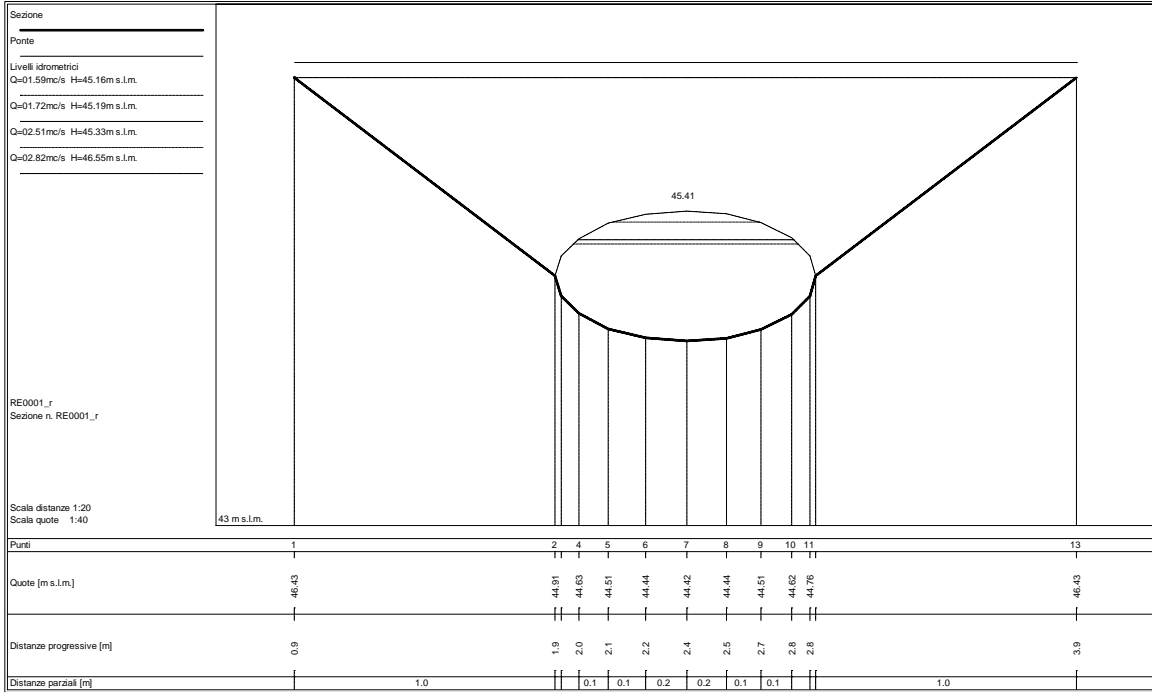

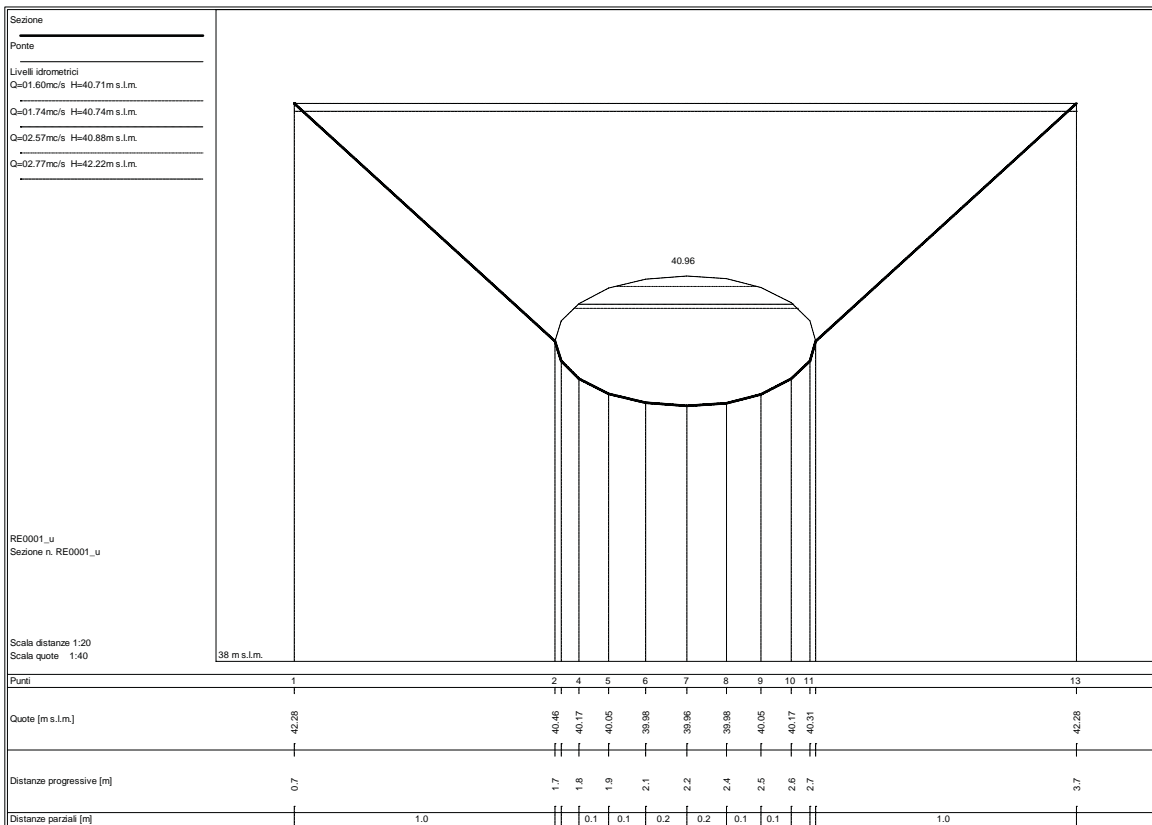
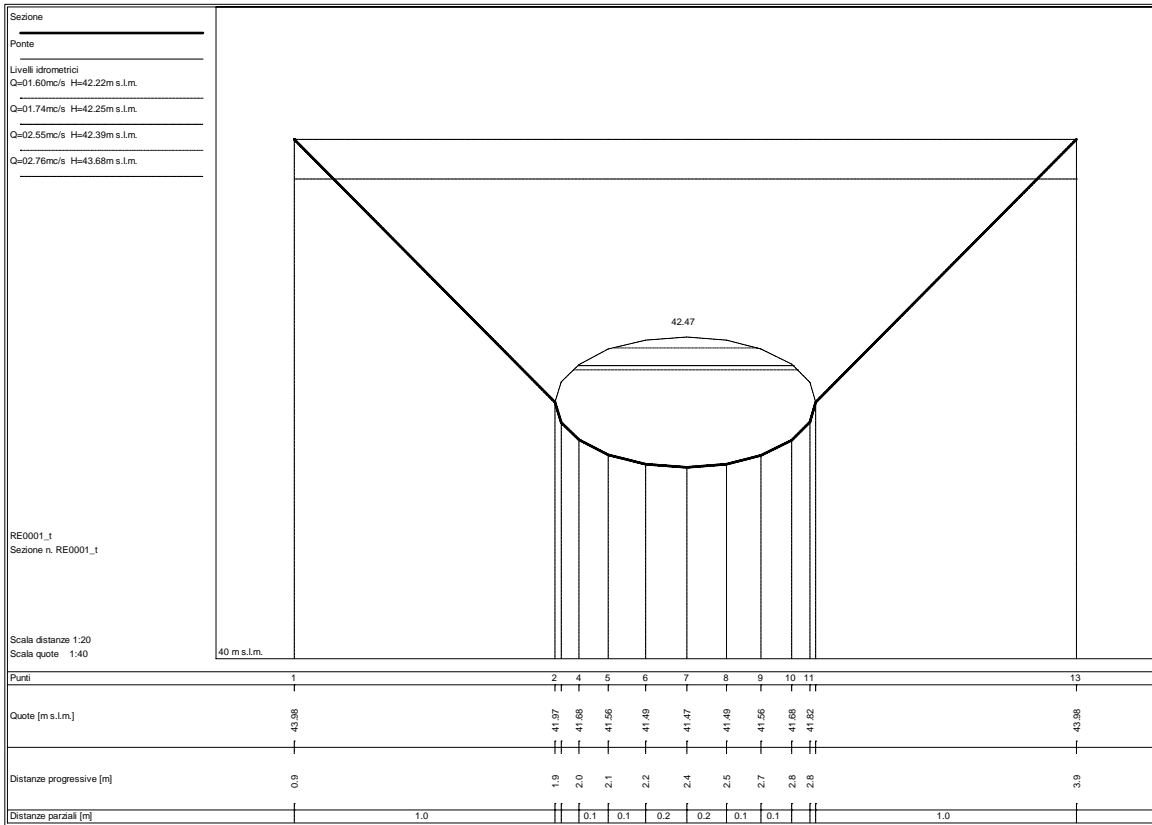

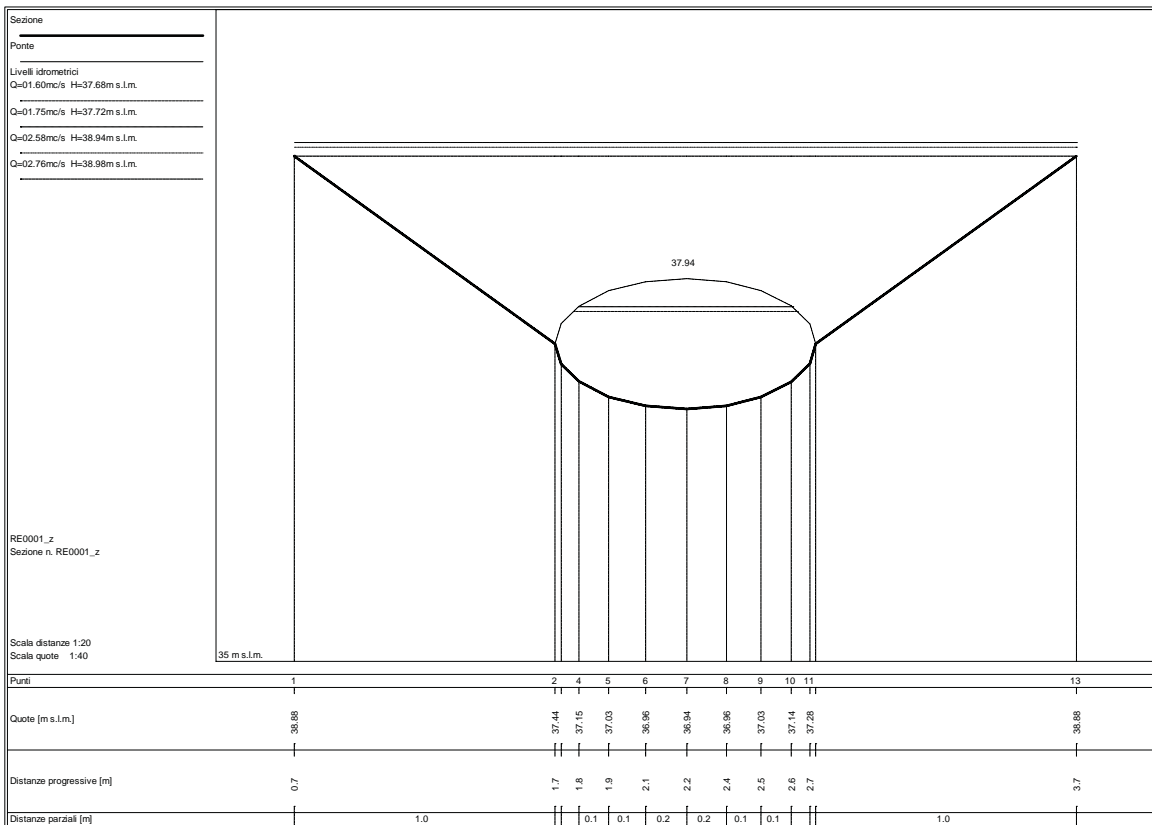
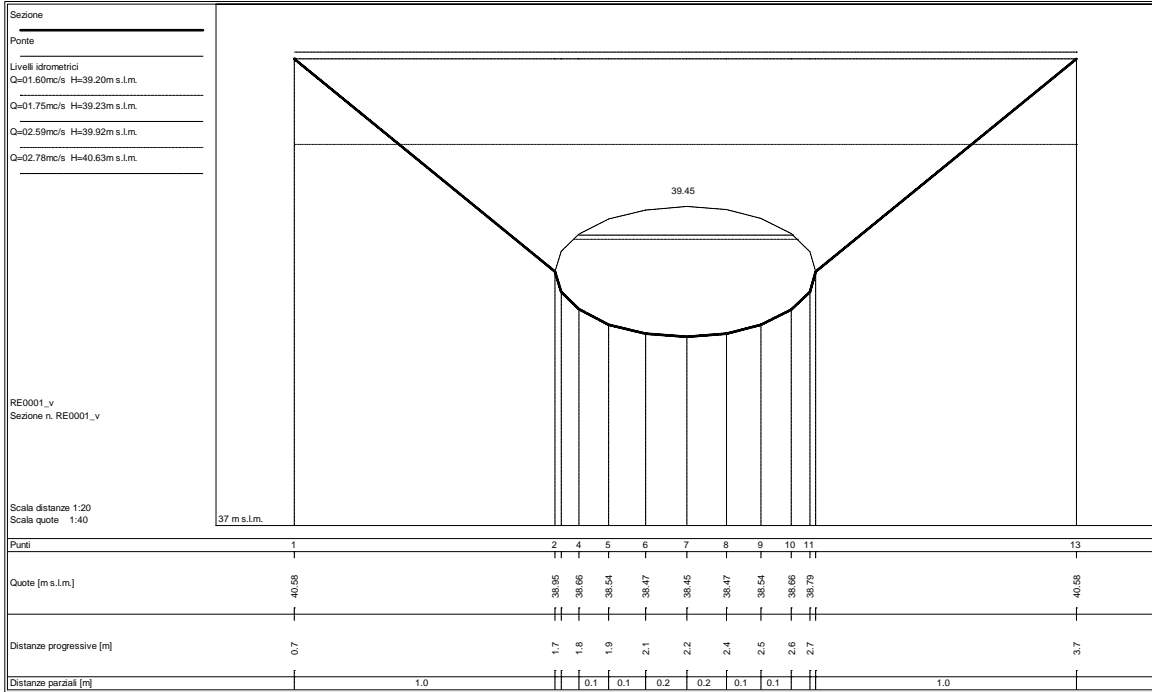

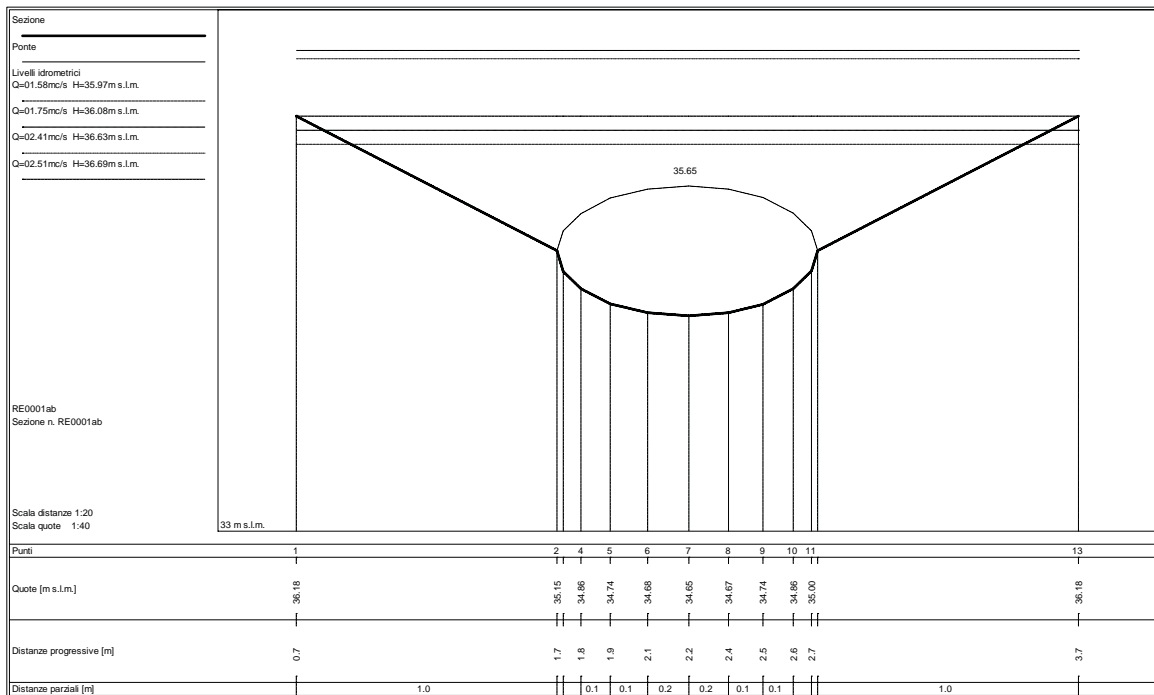
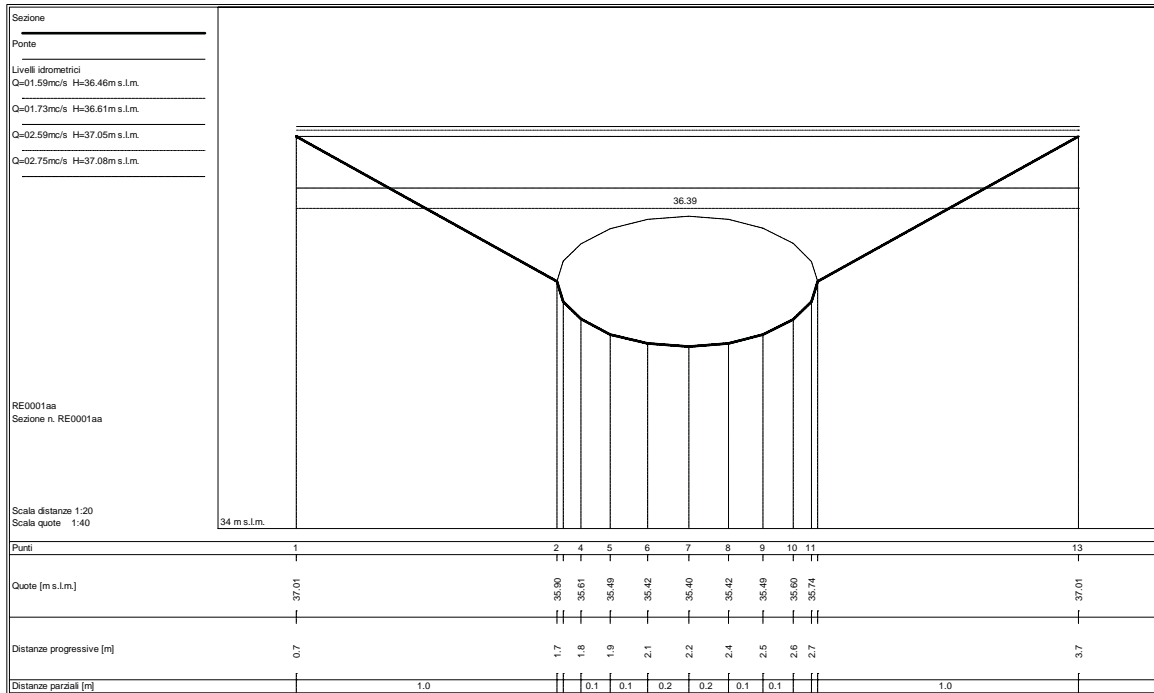

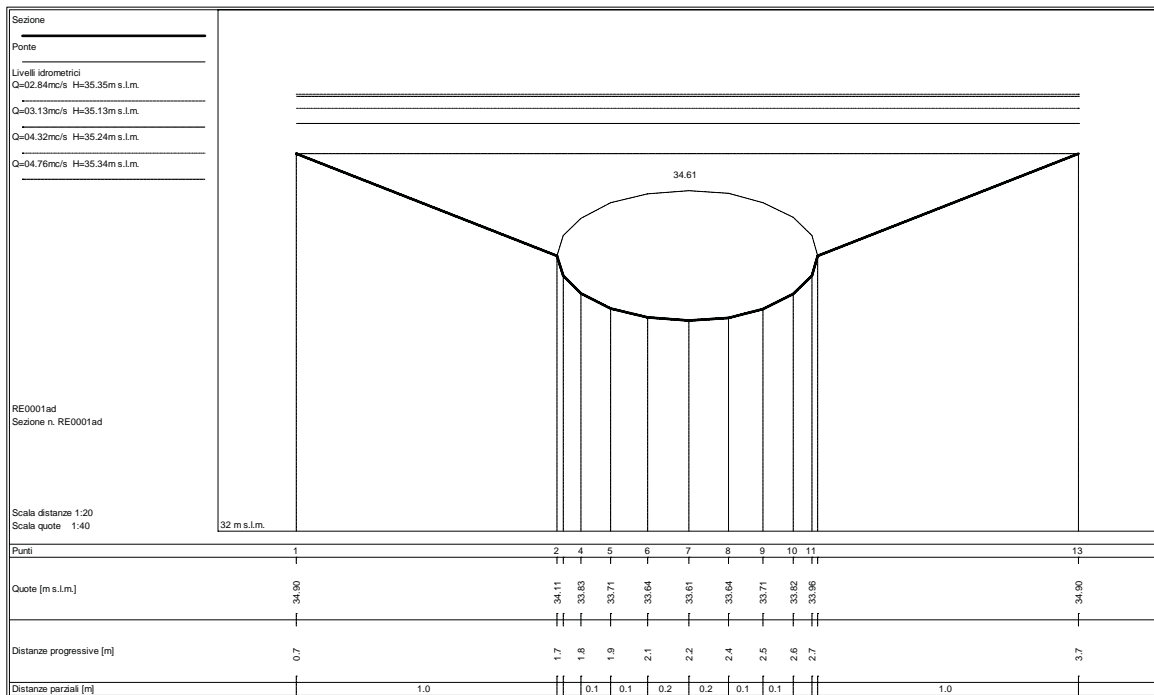
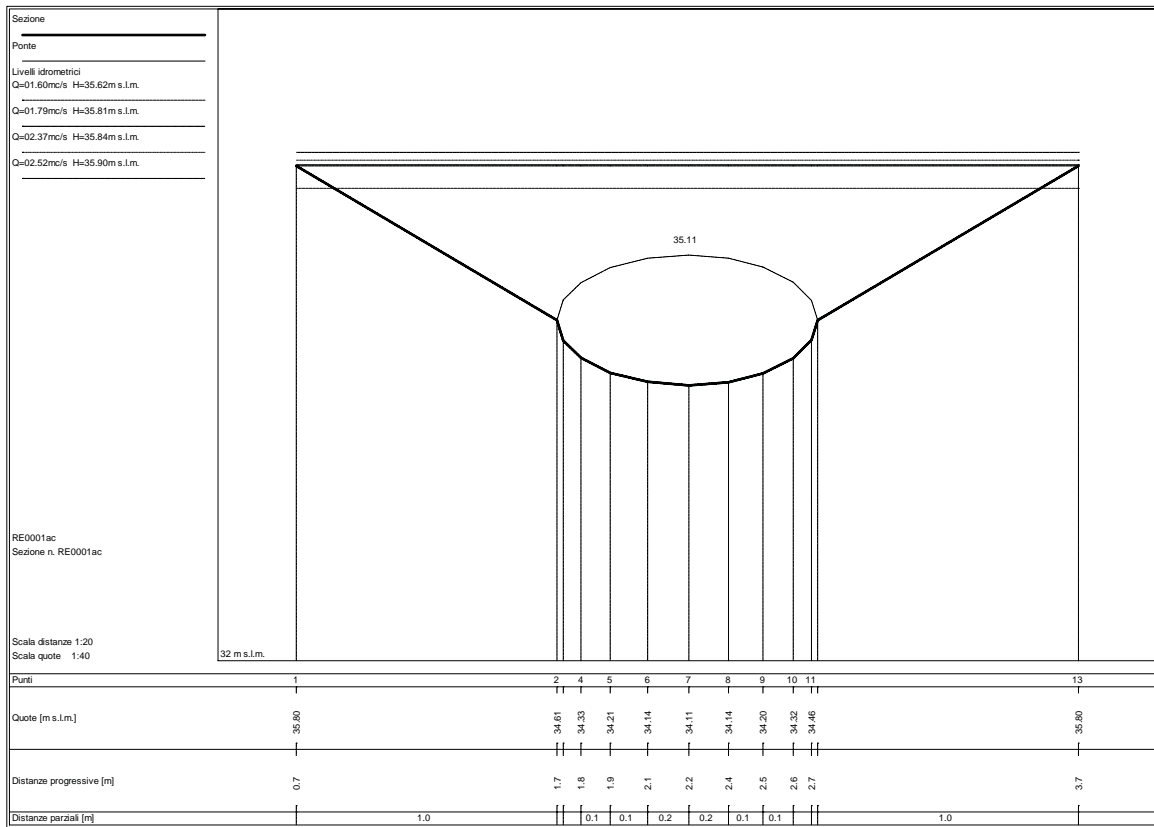

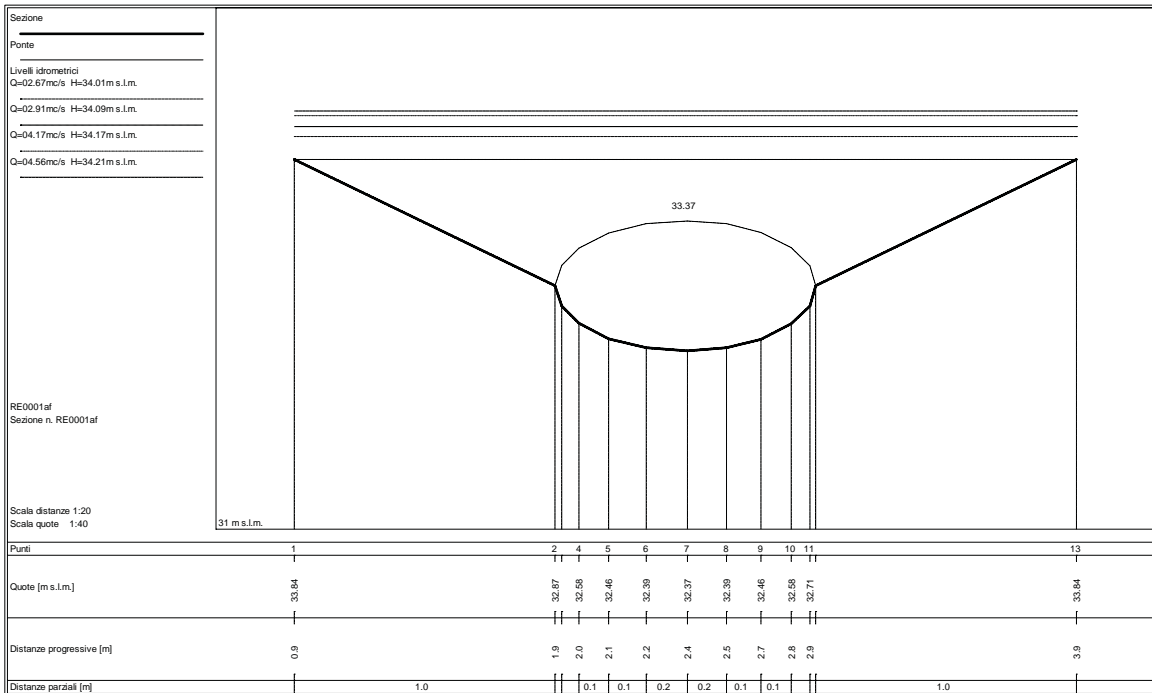
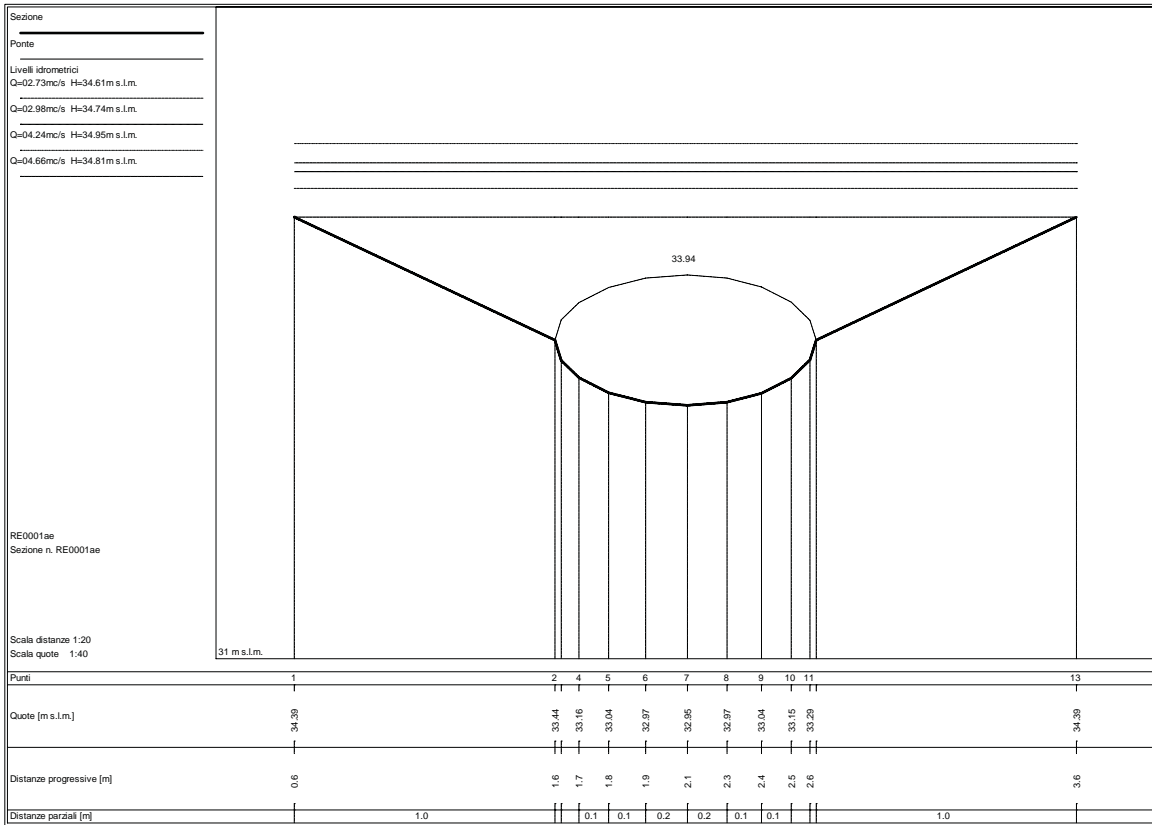

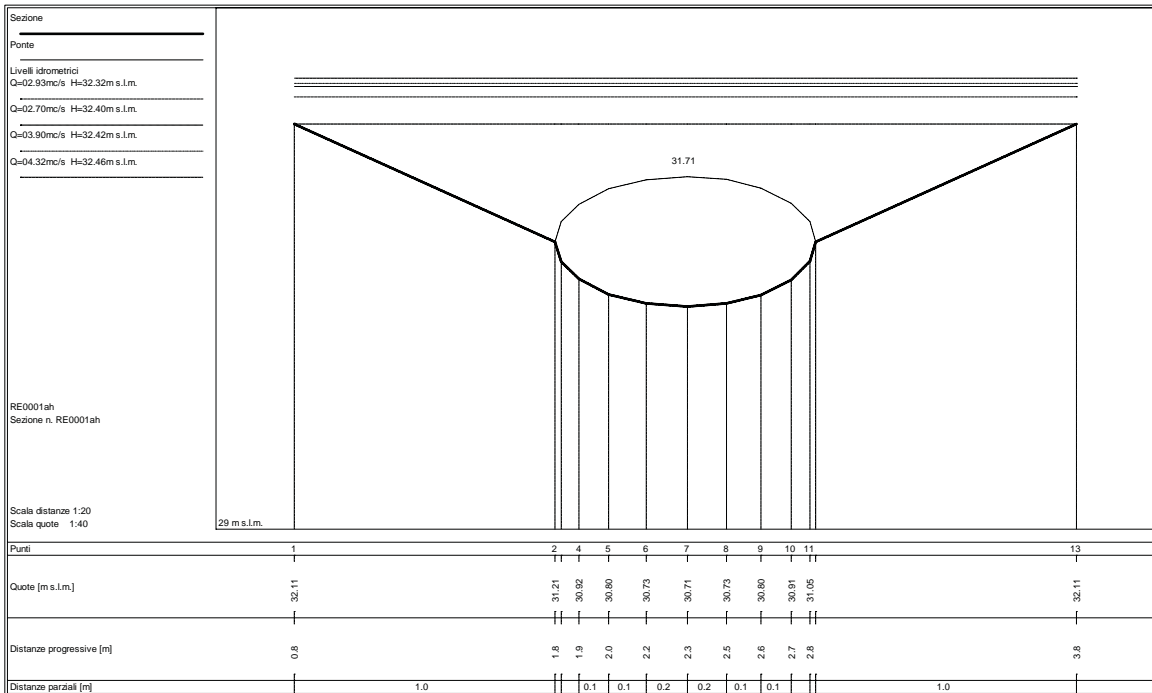
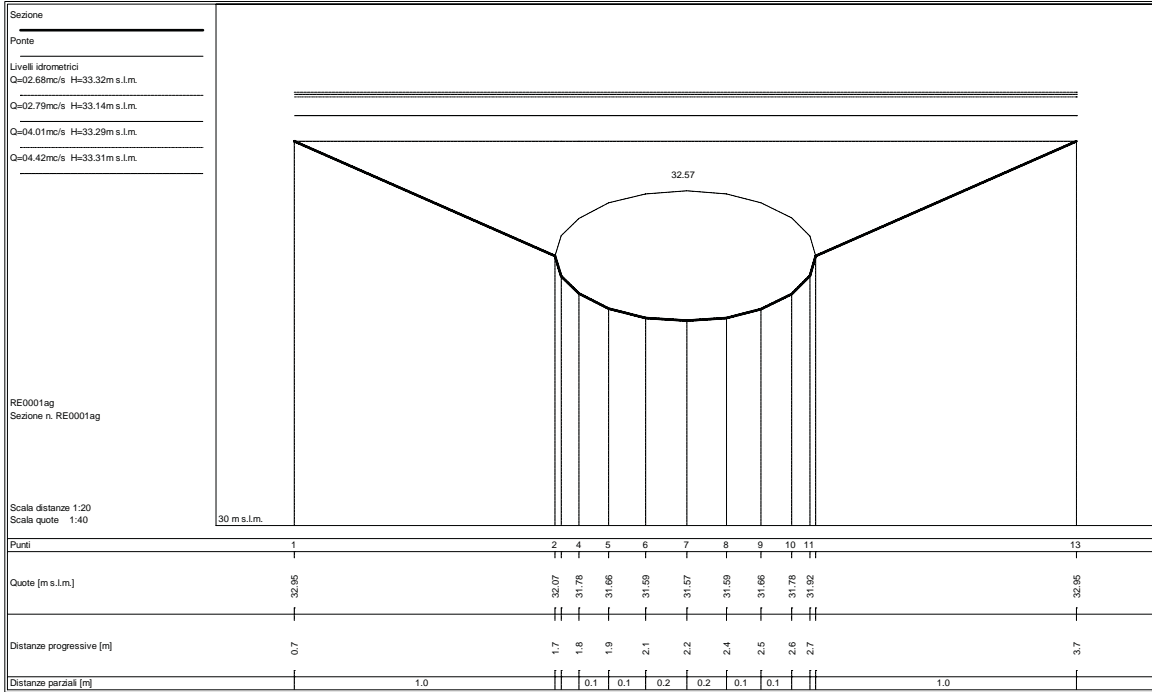

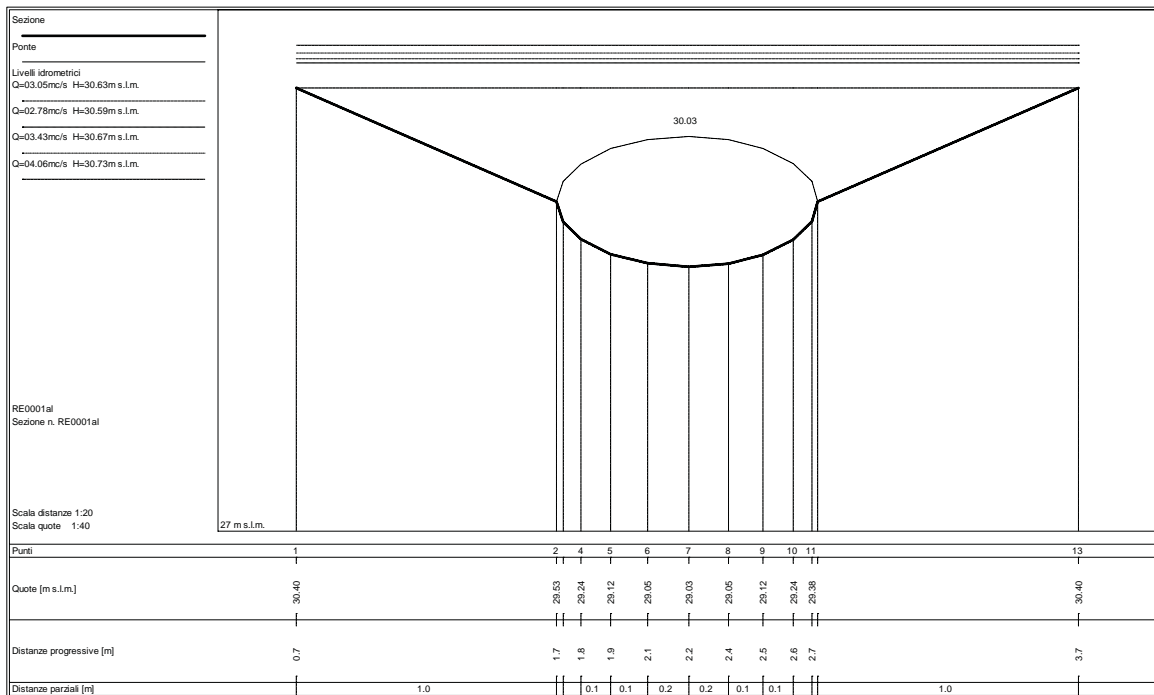
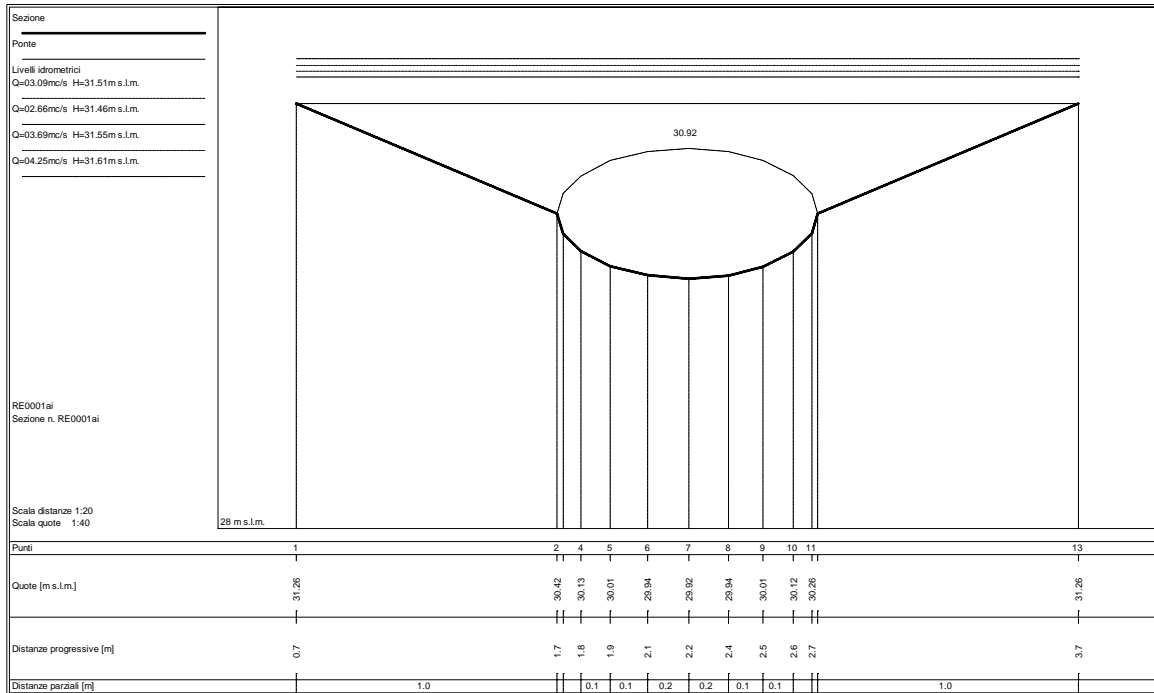

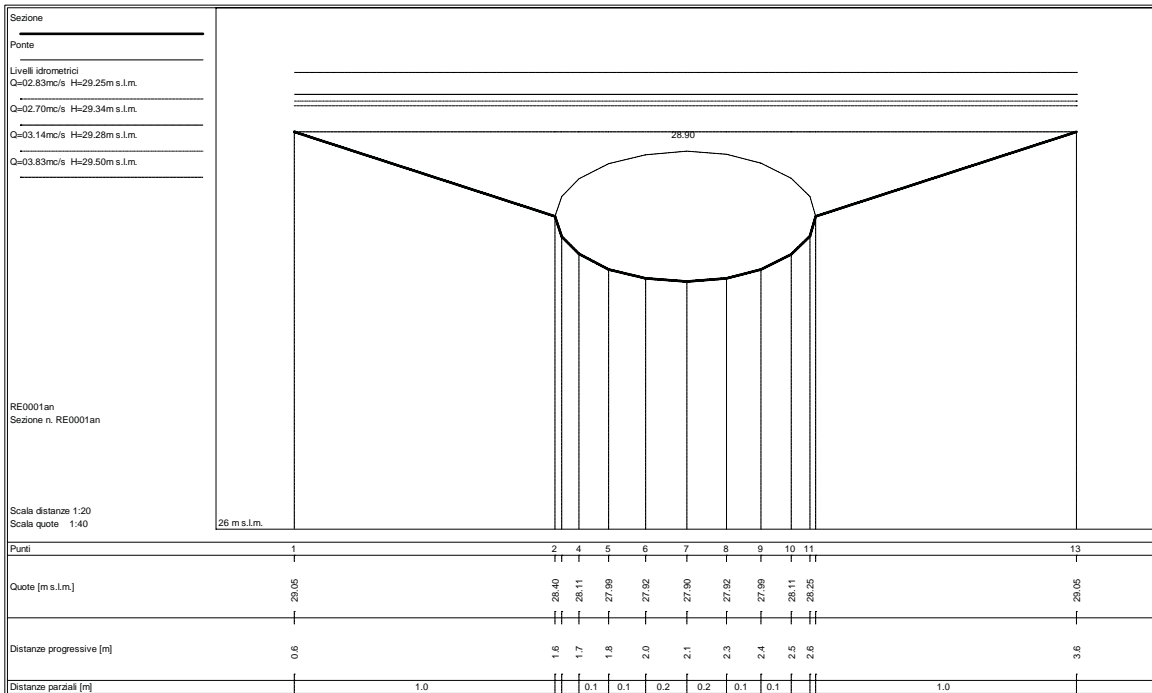
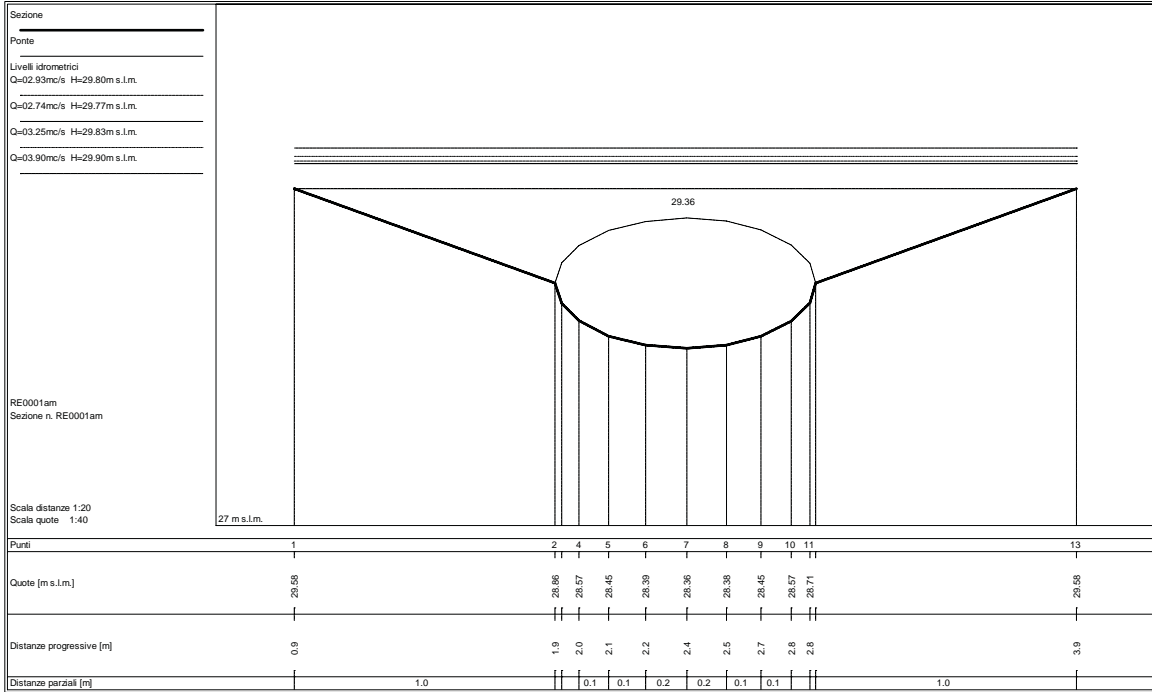

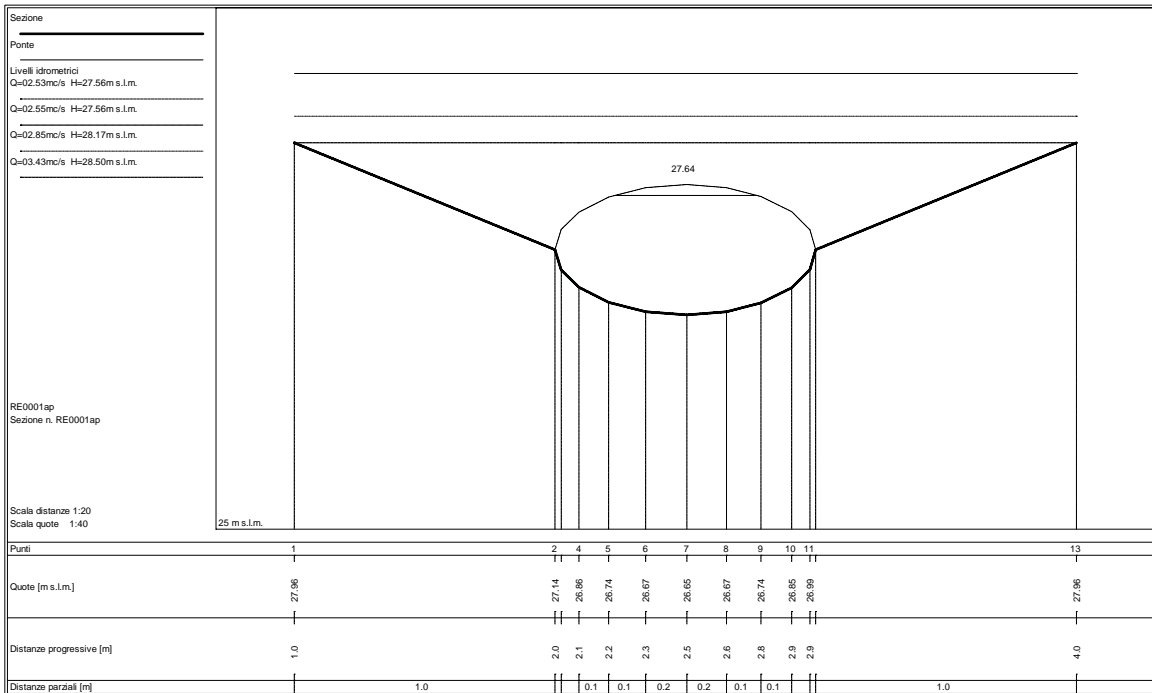
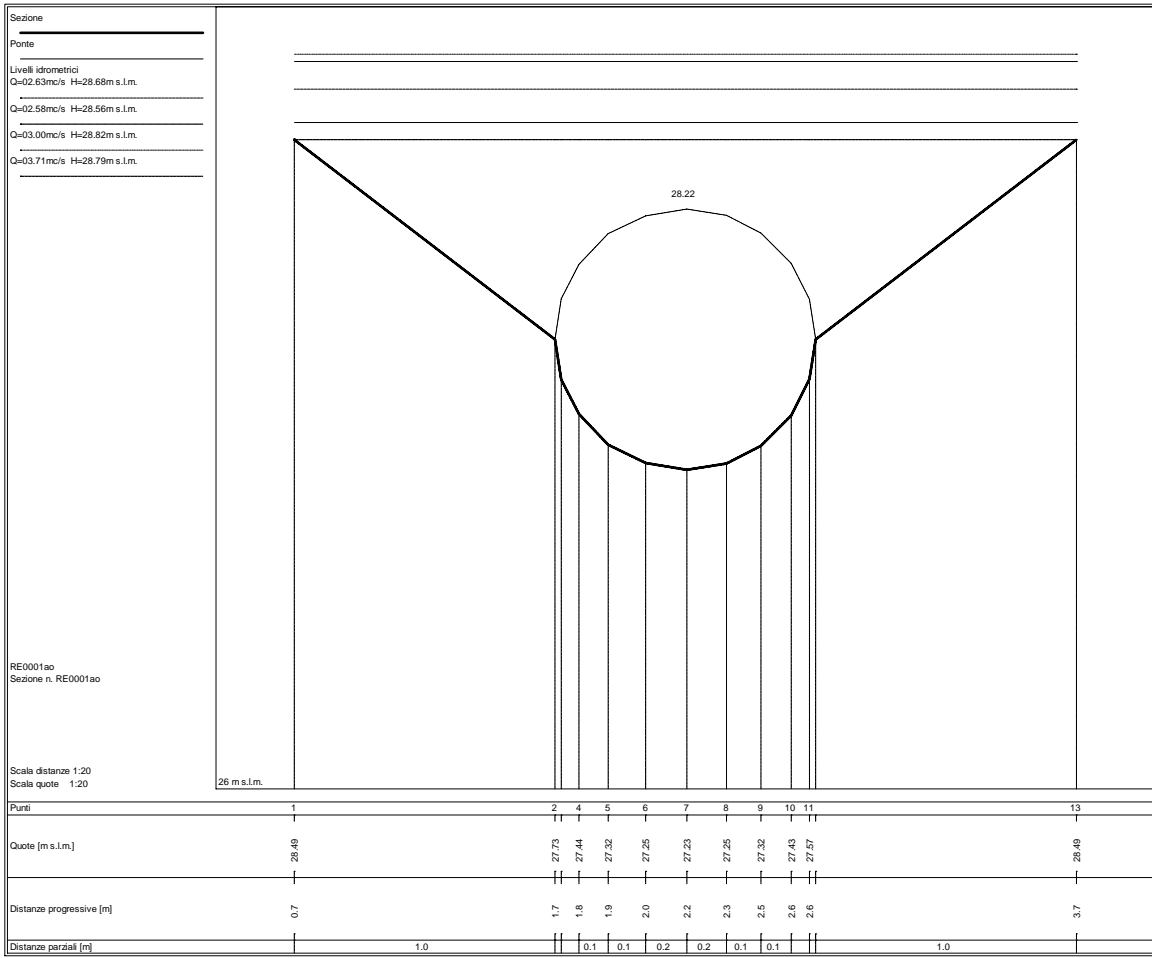

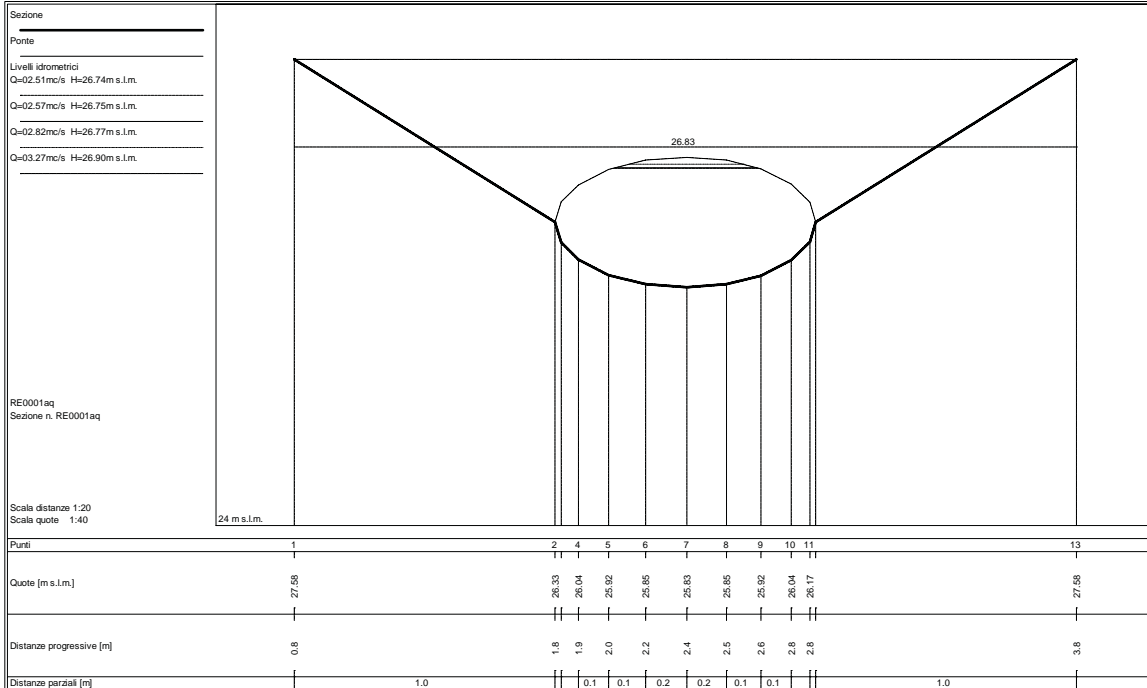

STATO ATTUALE

Sezioni fluviali fosso Poveromo

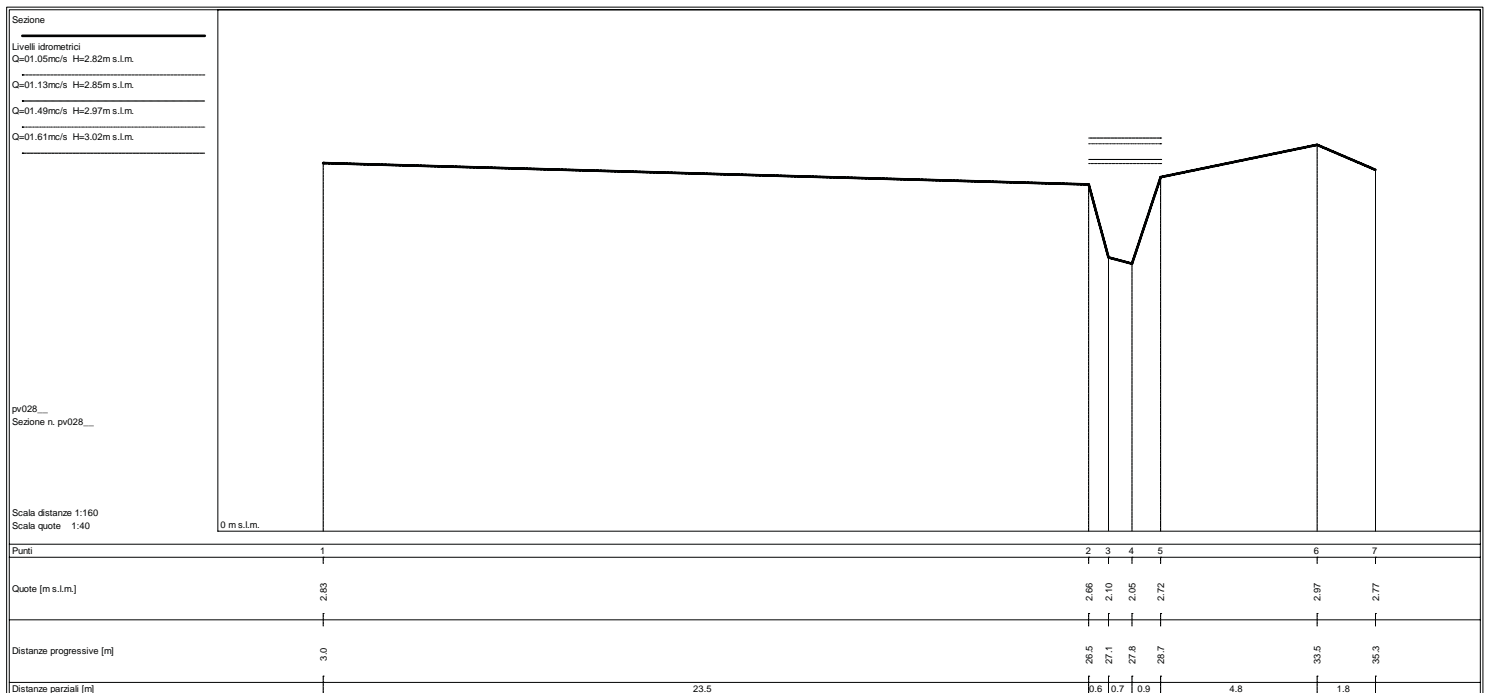
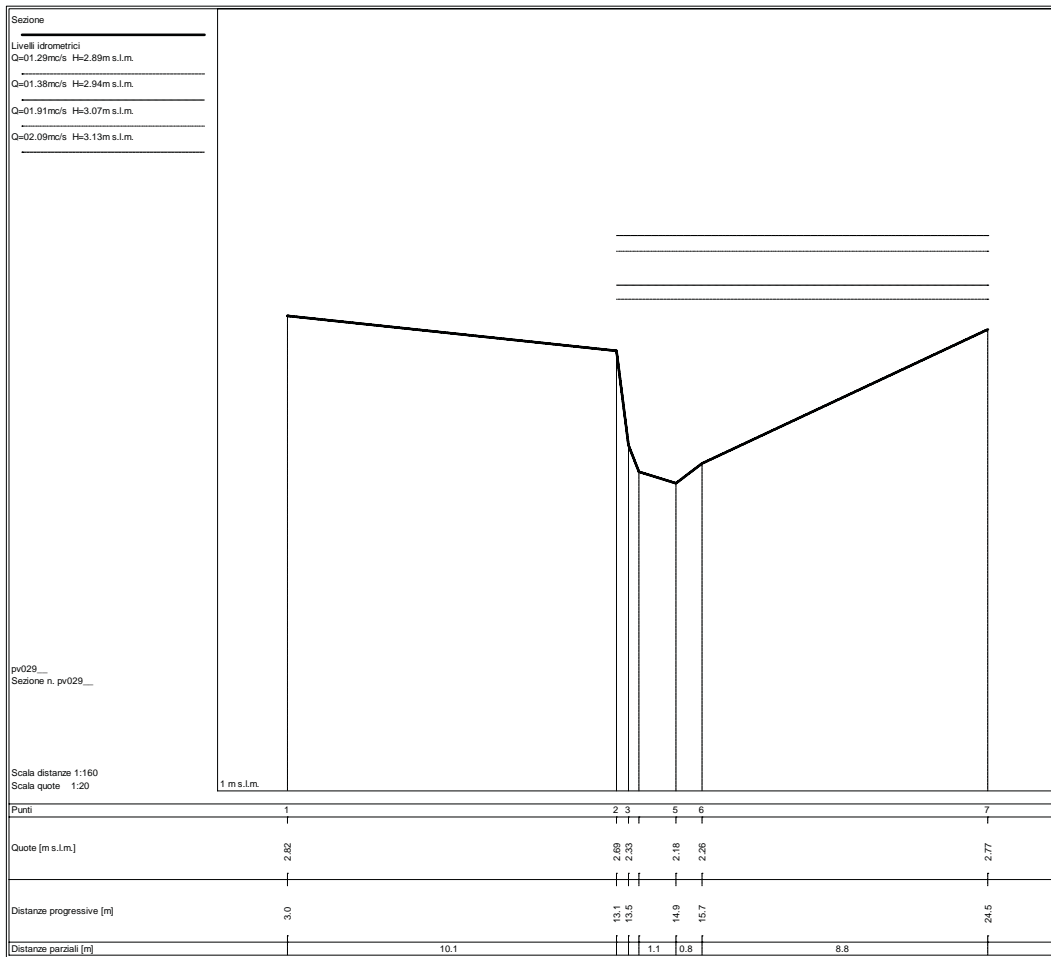

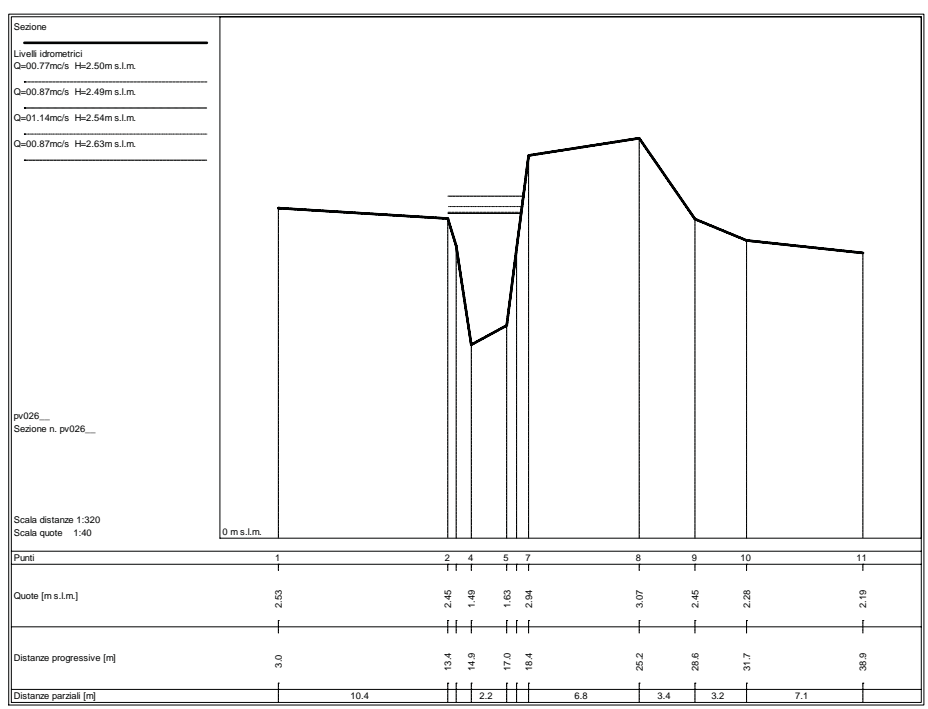
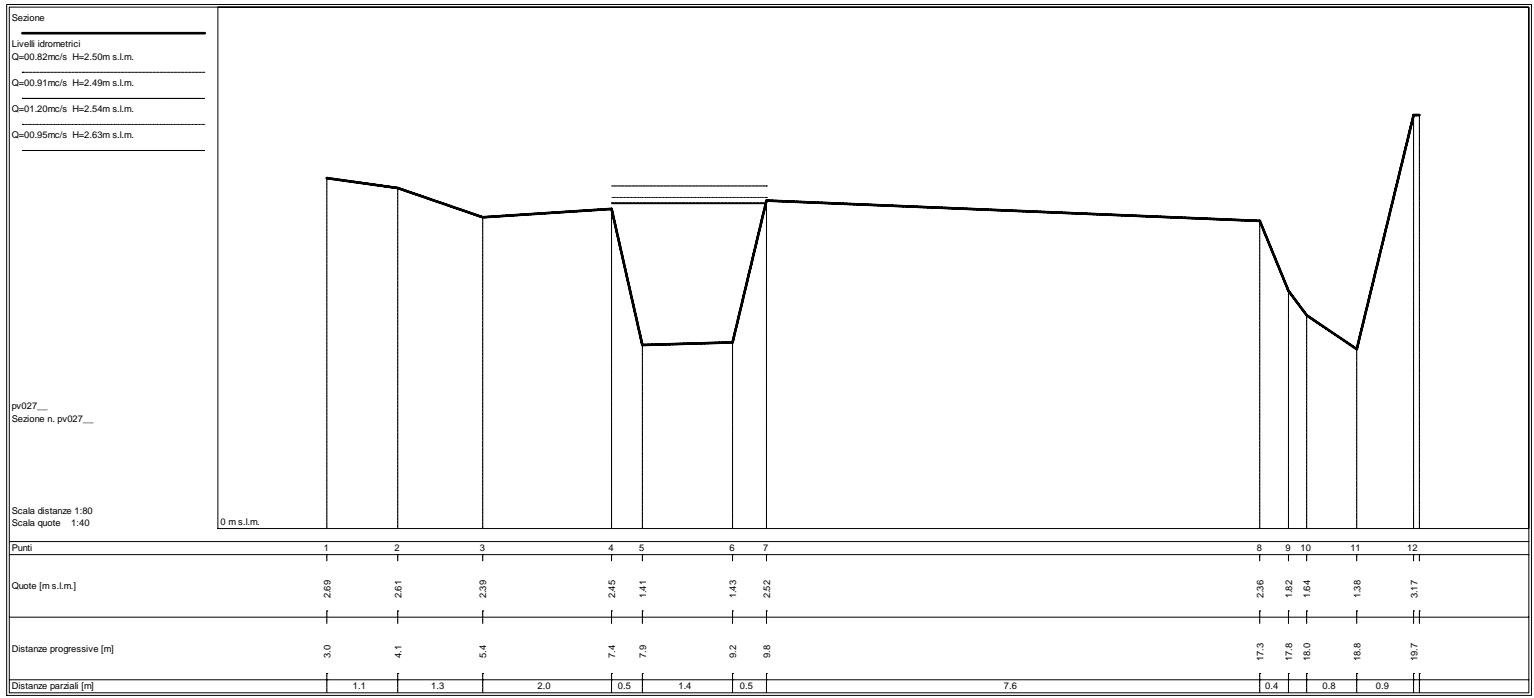

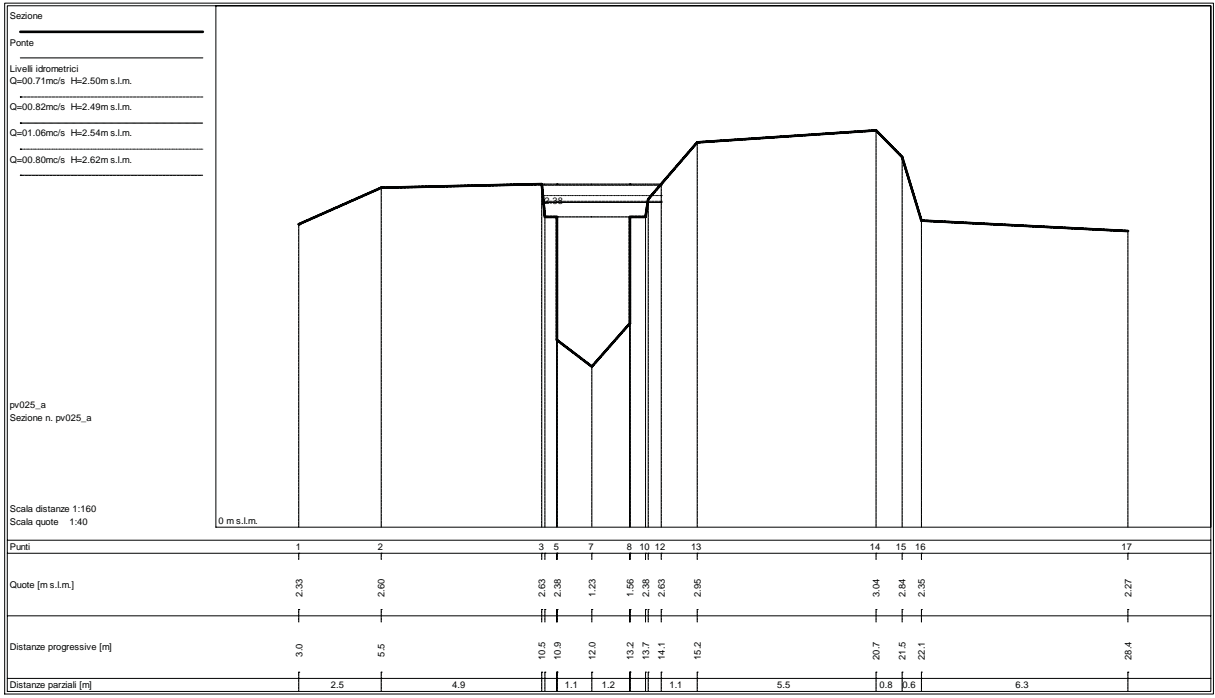
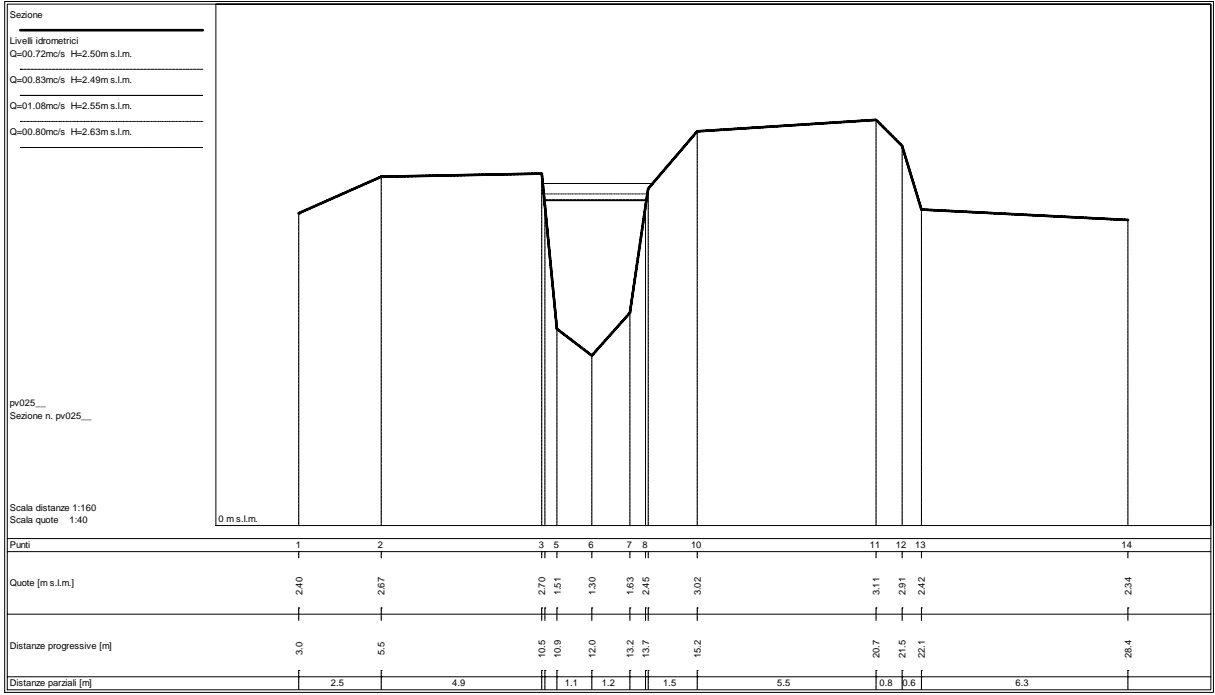

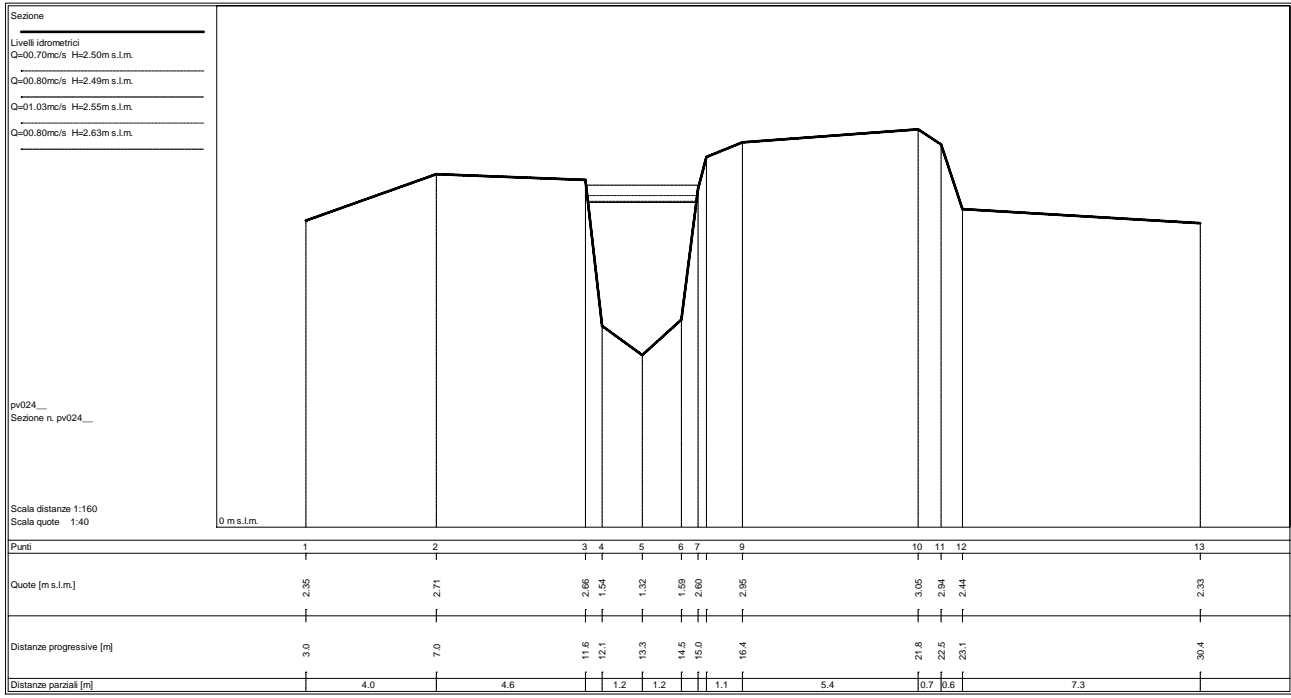
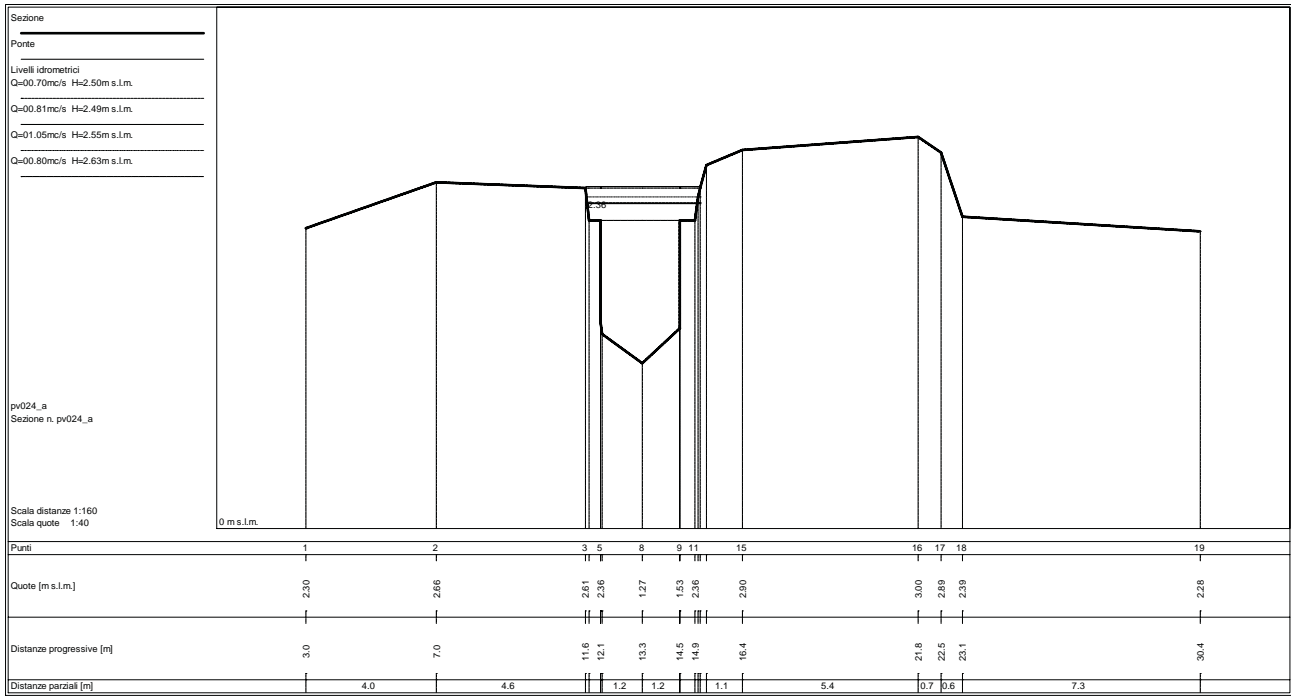

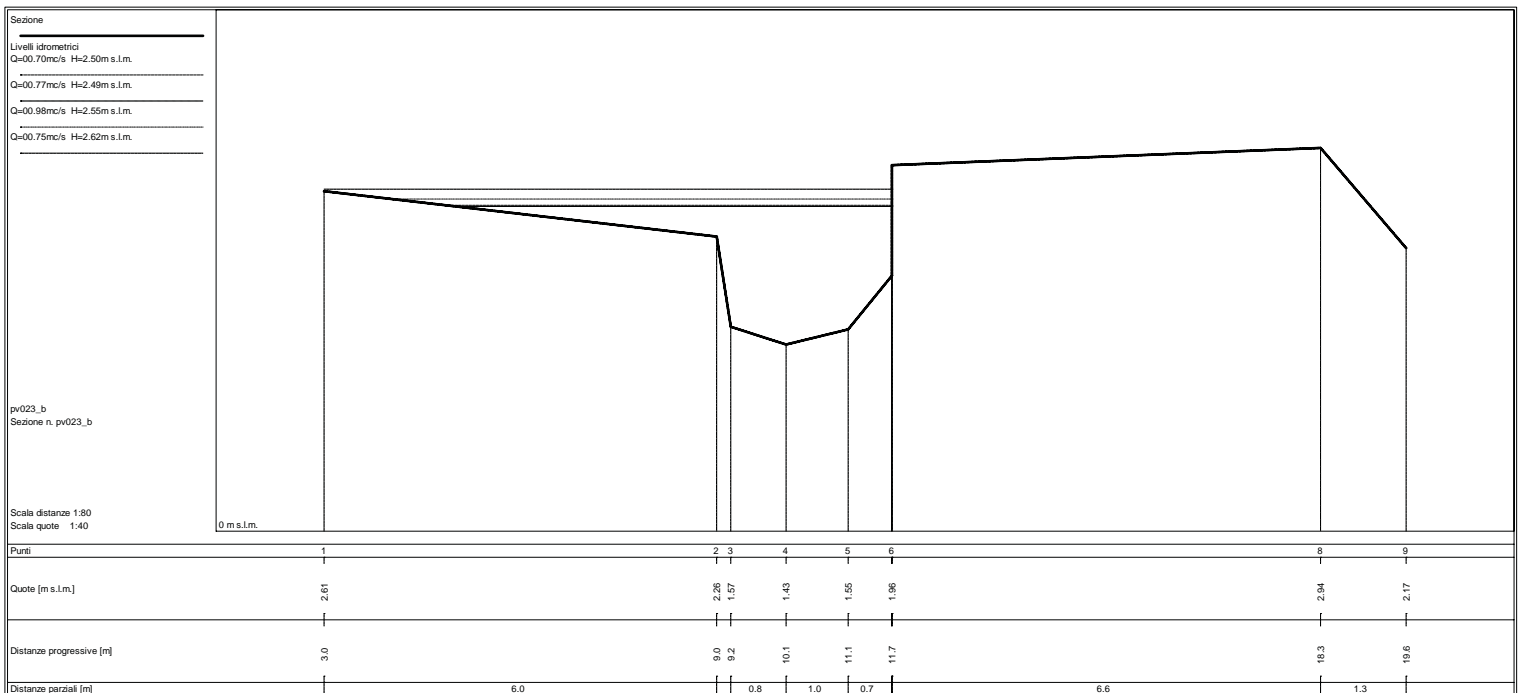
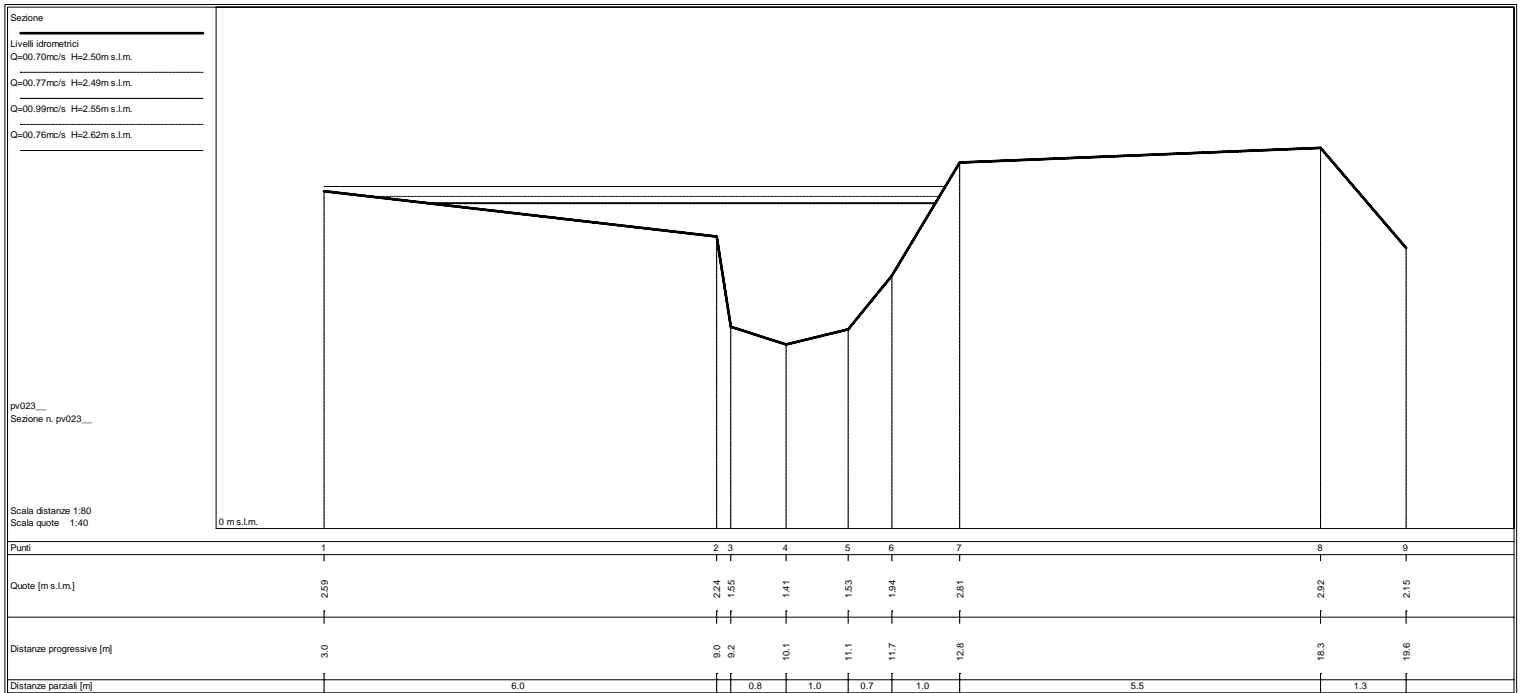

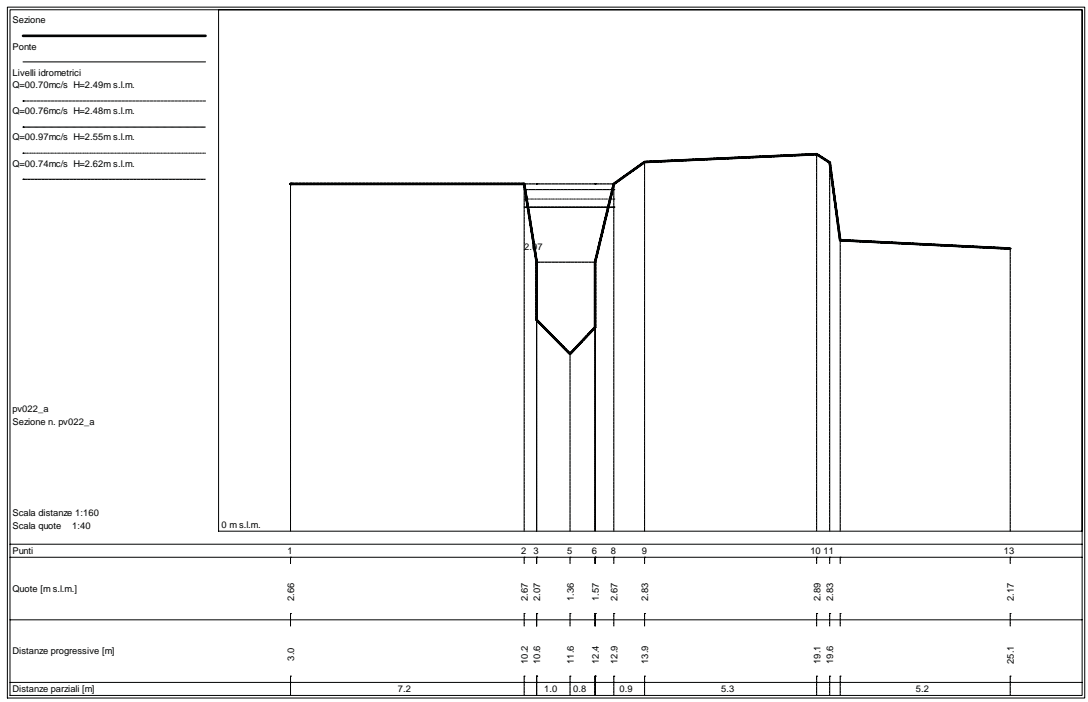
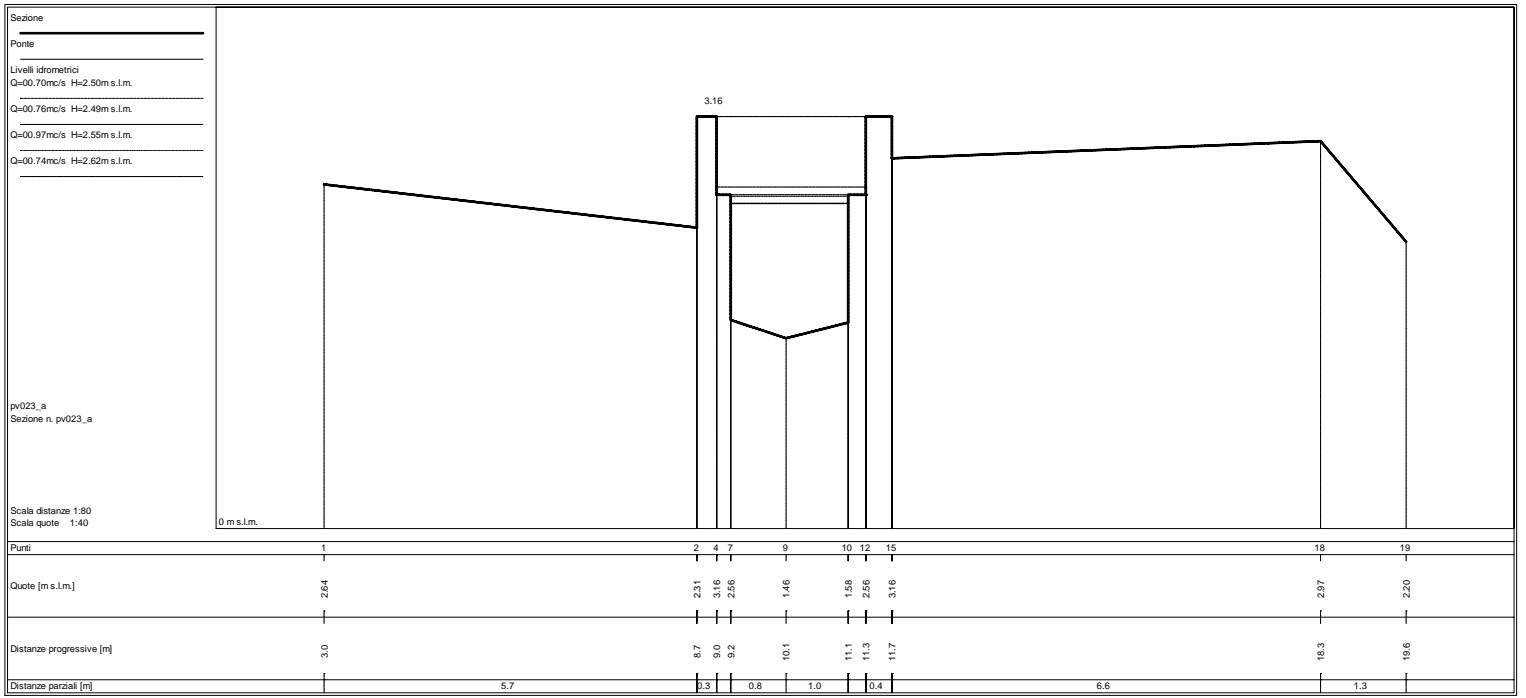

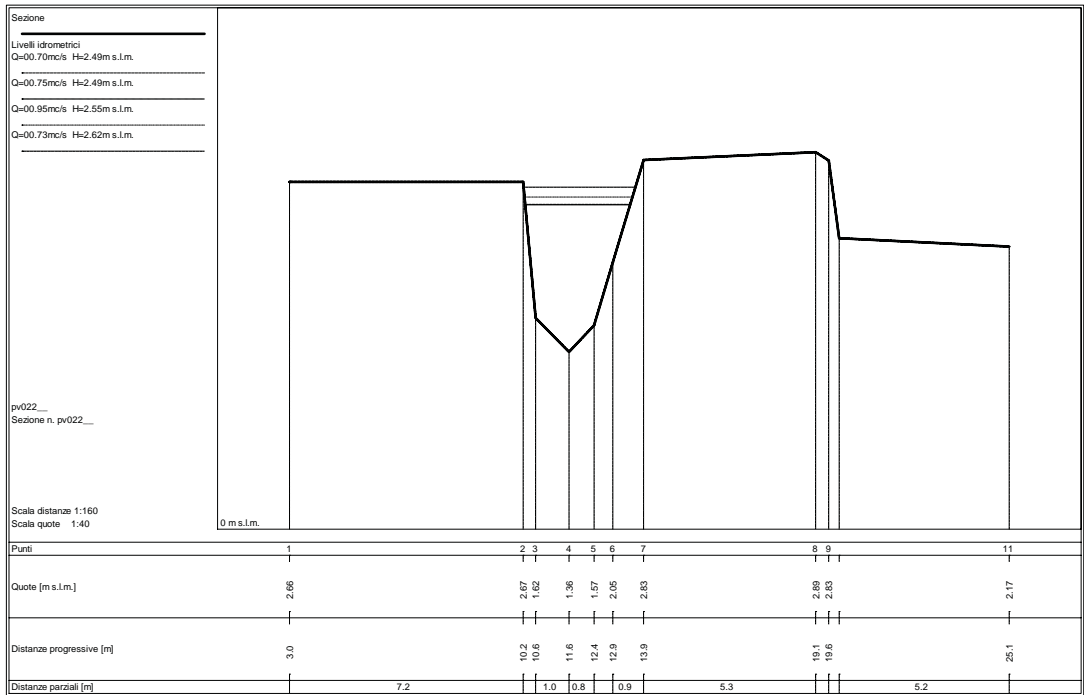
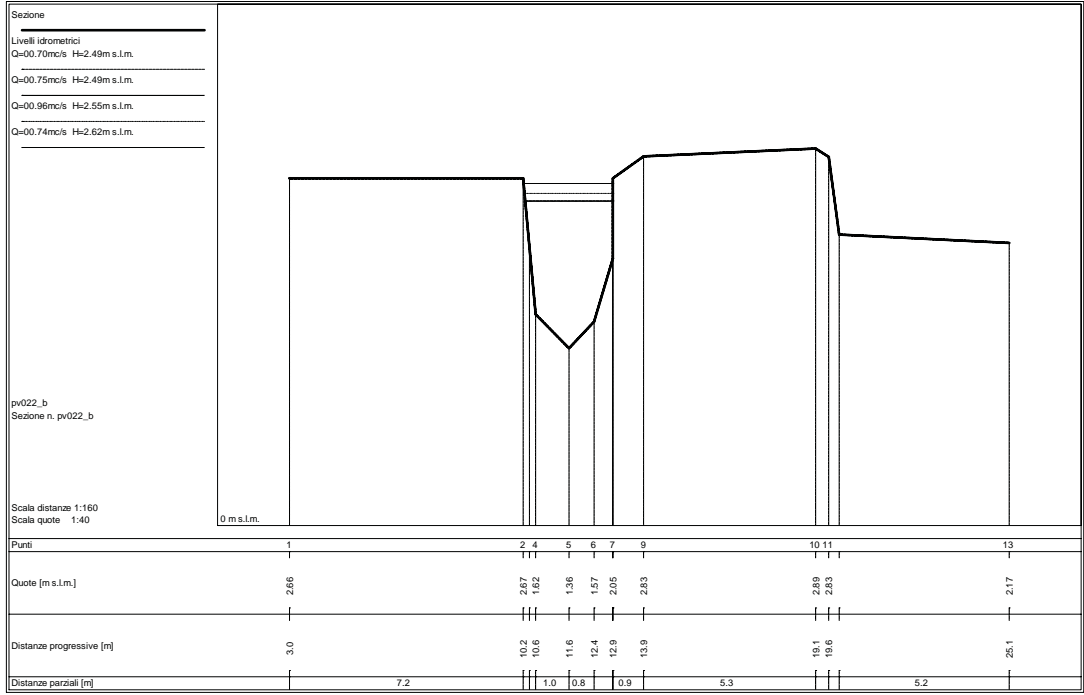

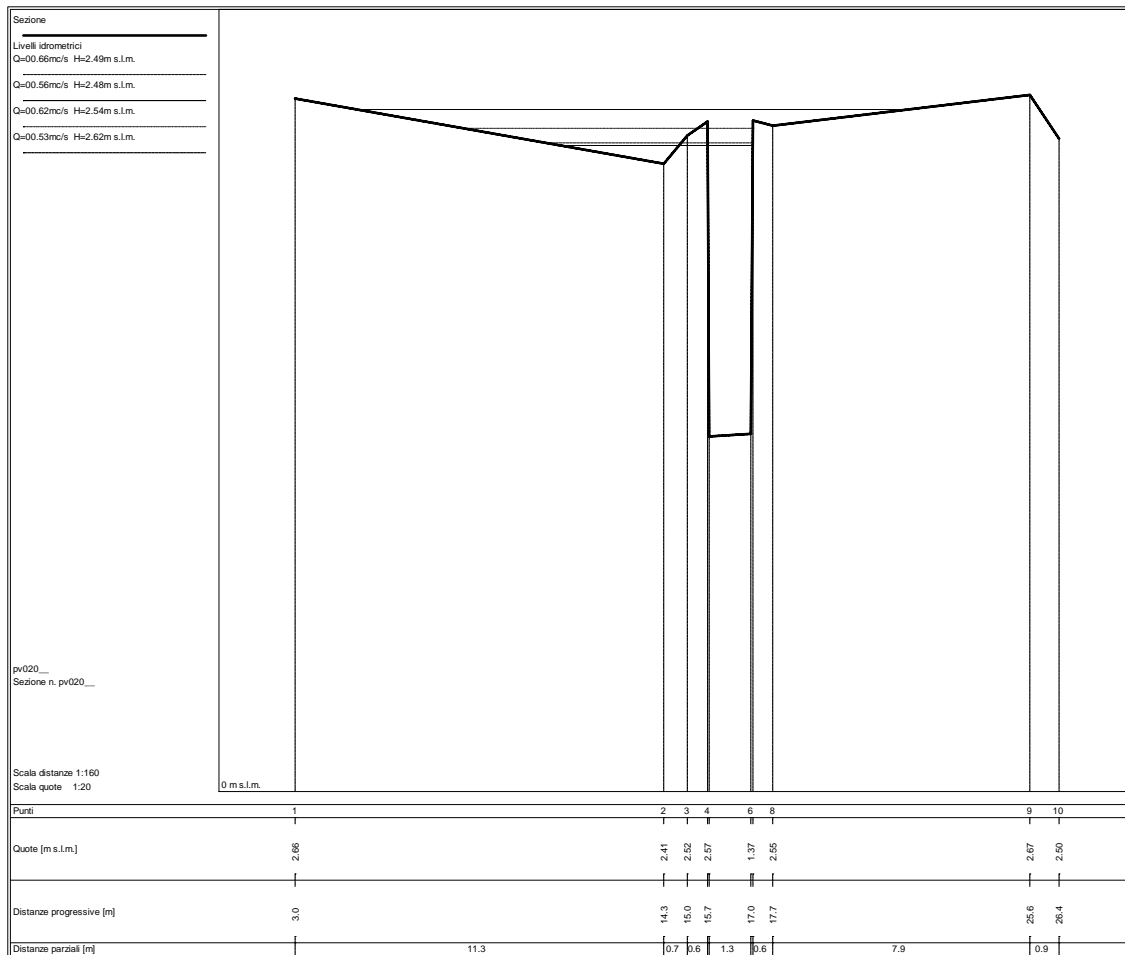
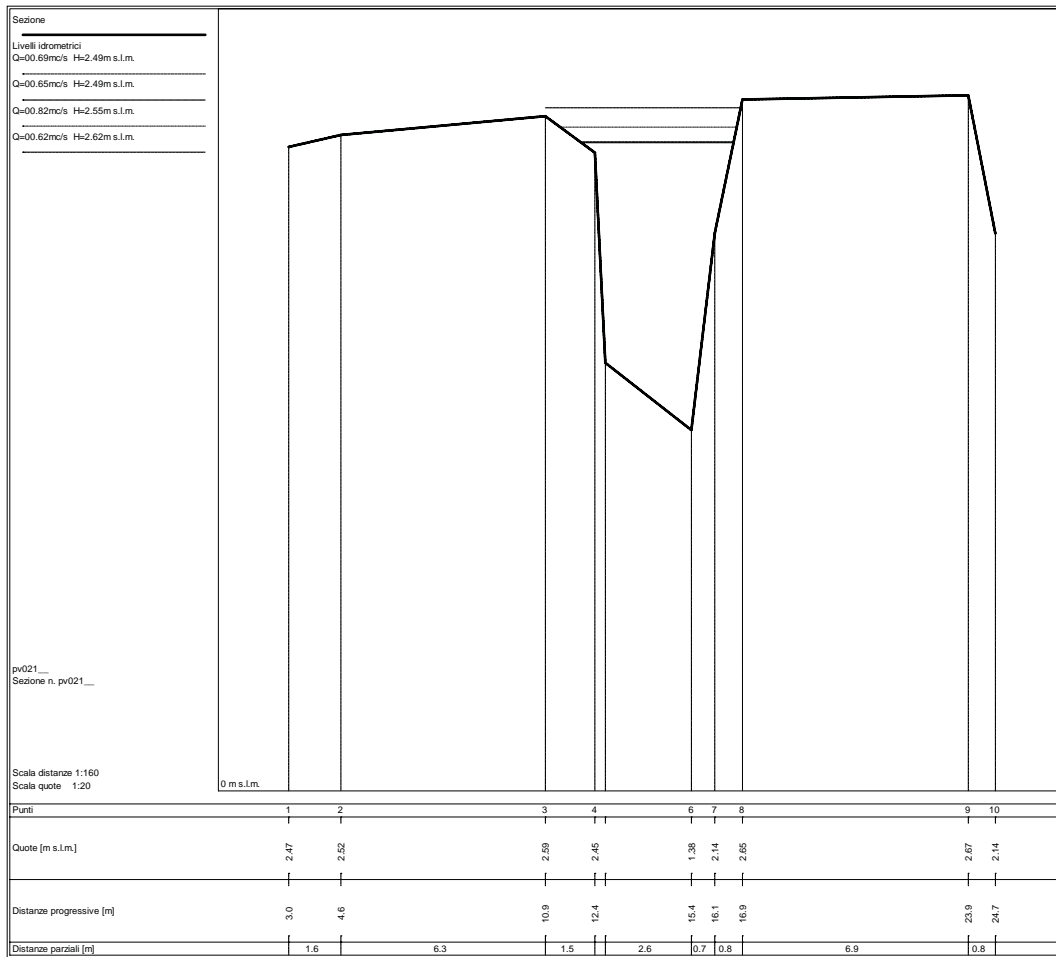

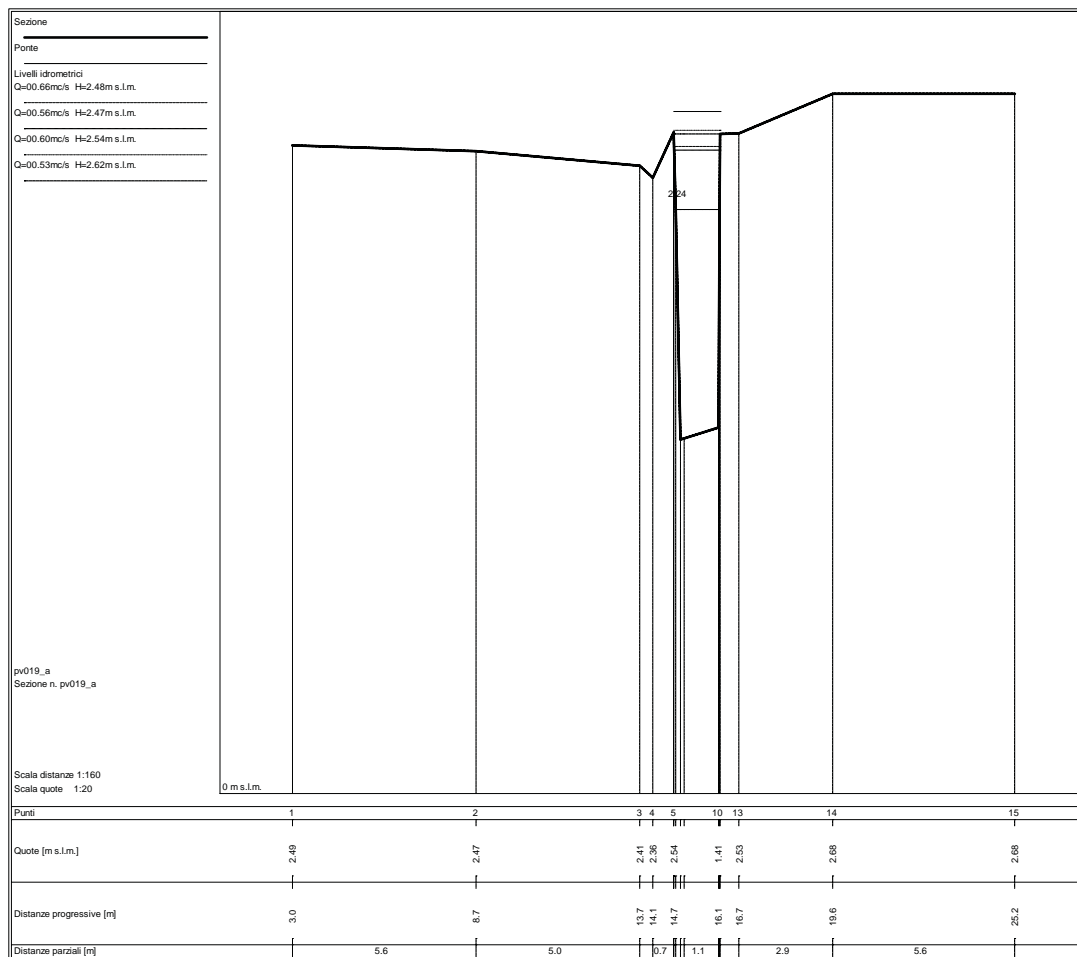
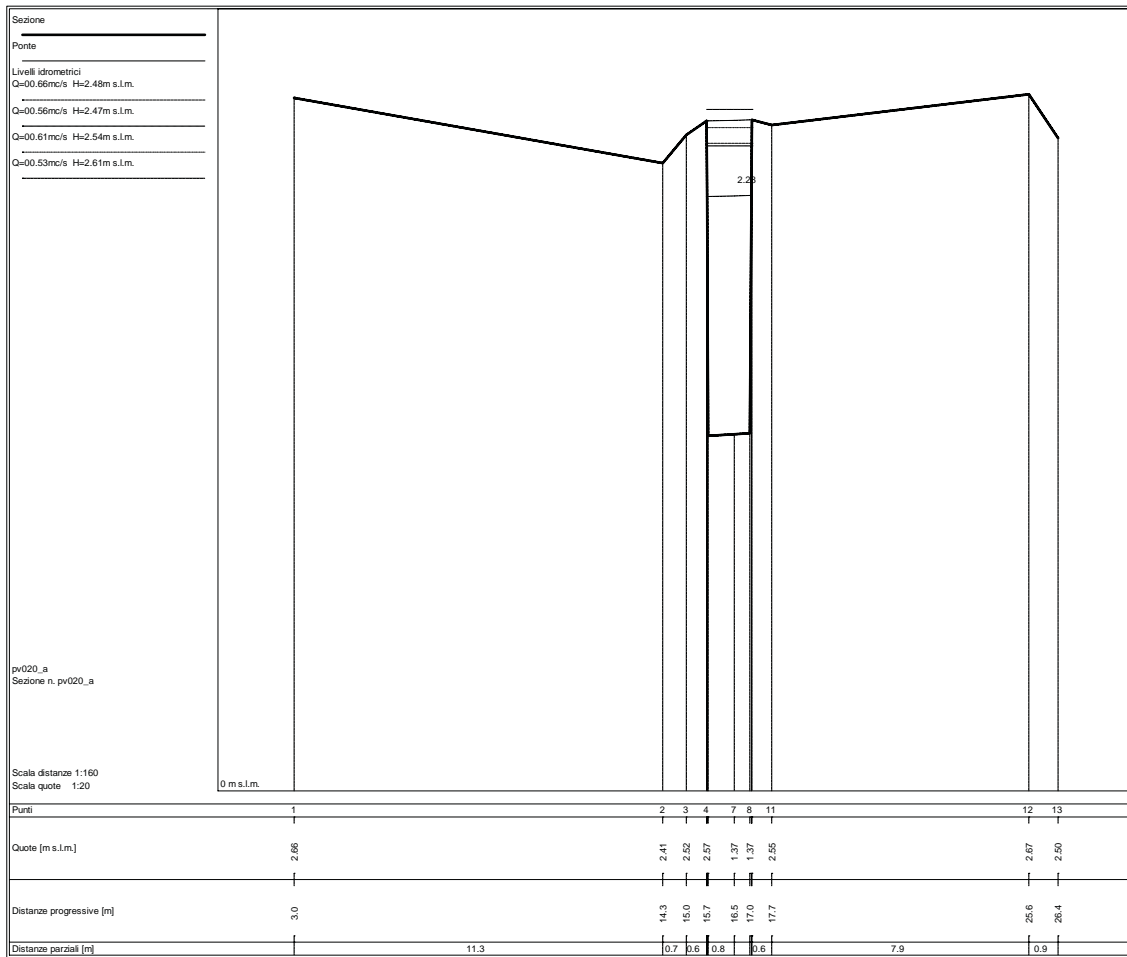

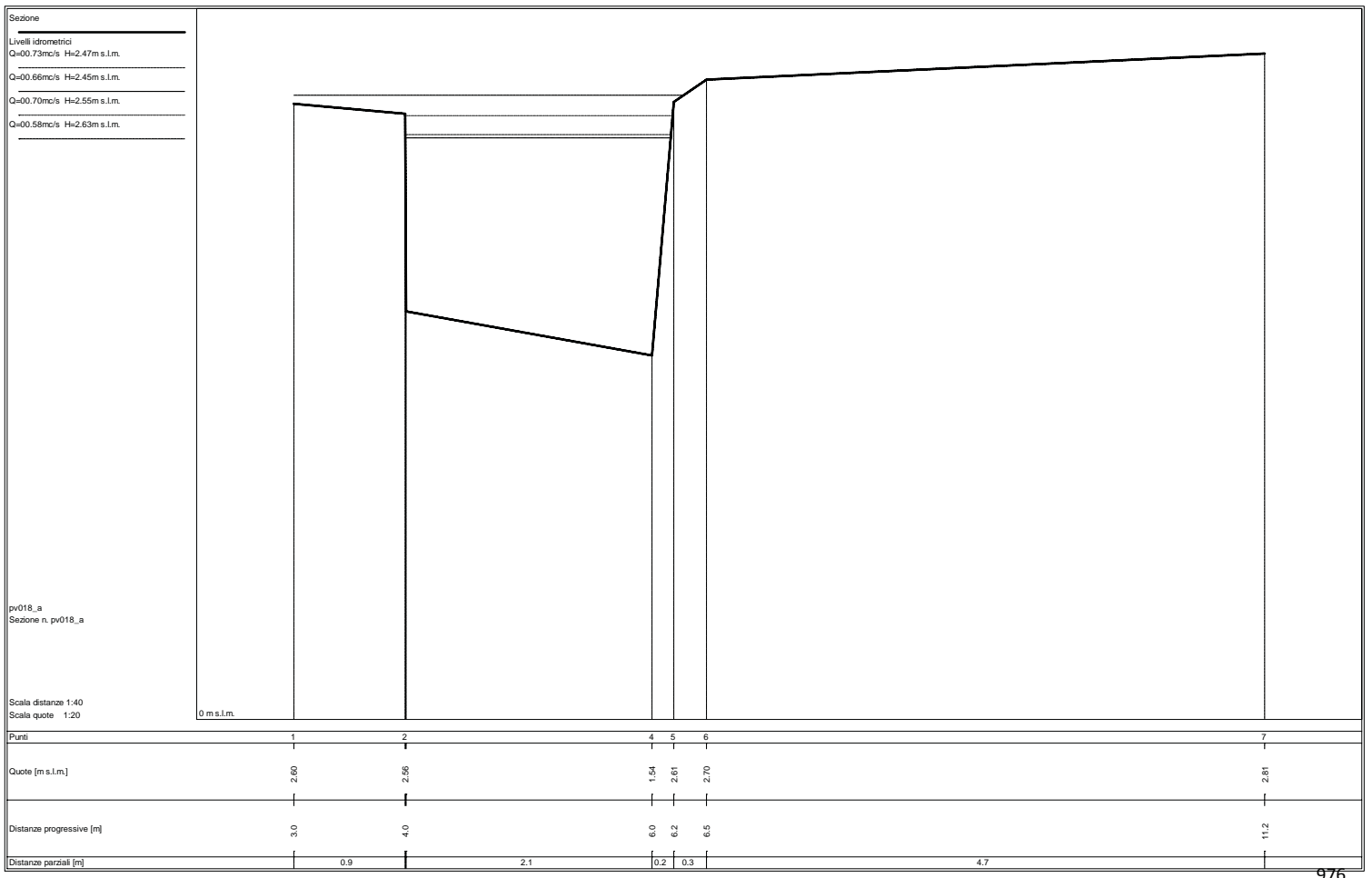
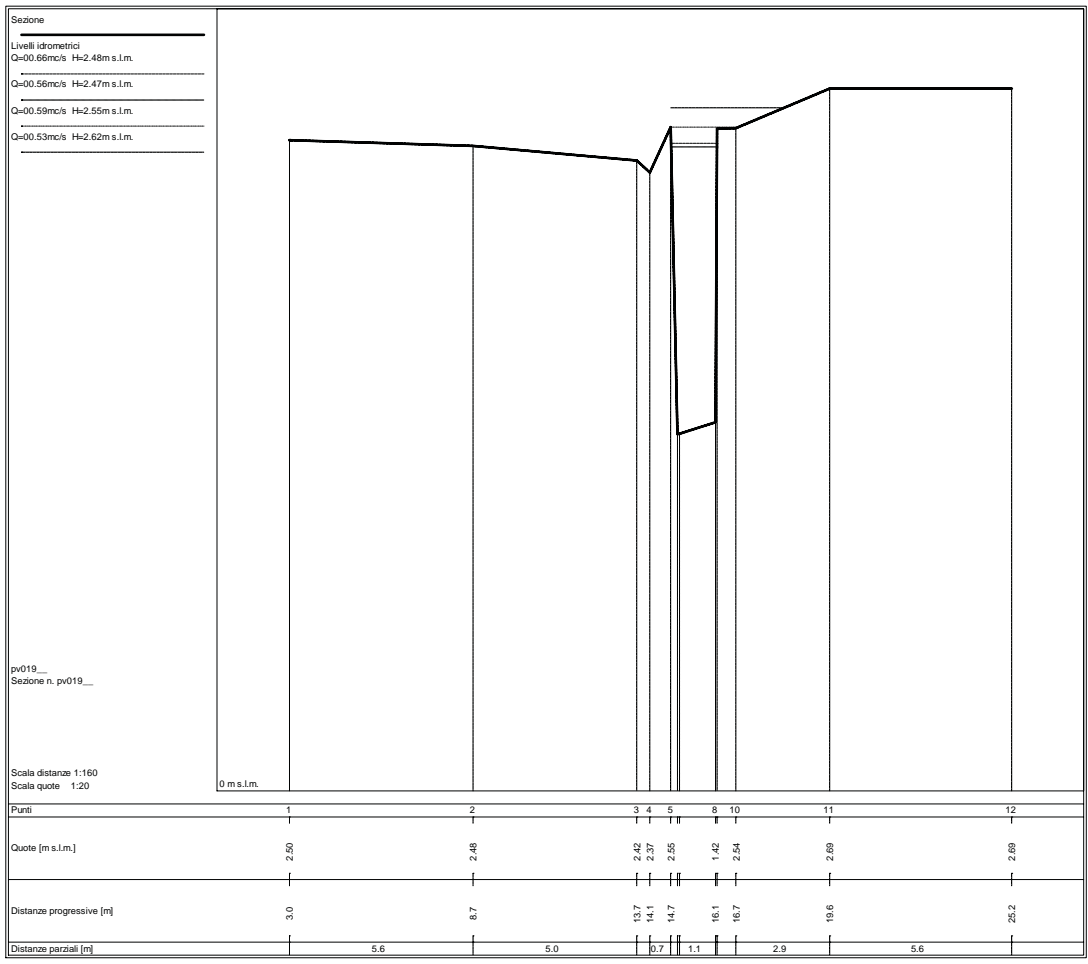

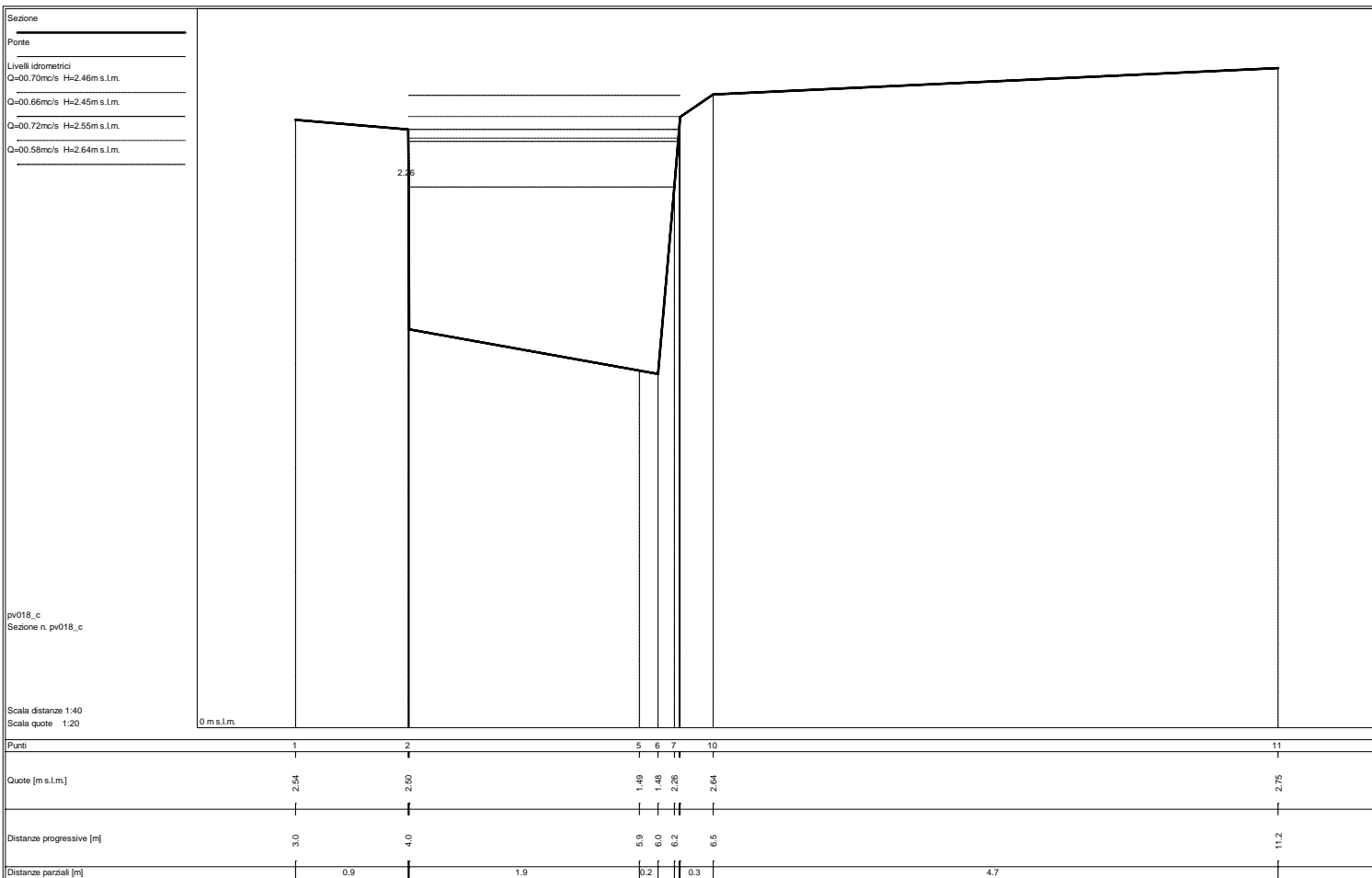
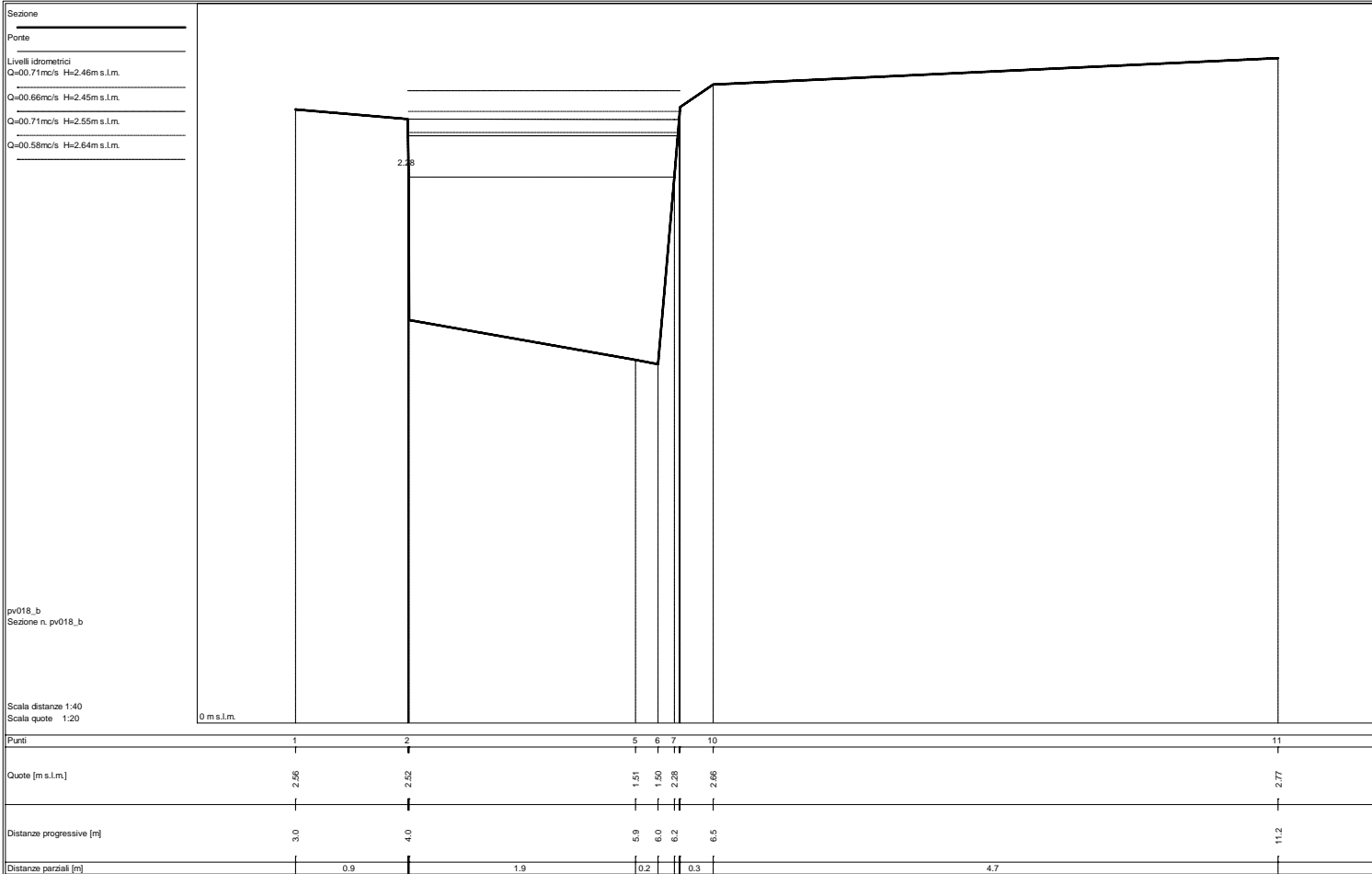

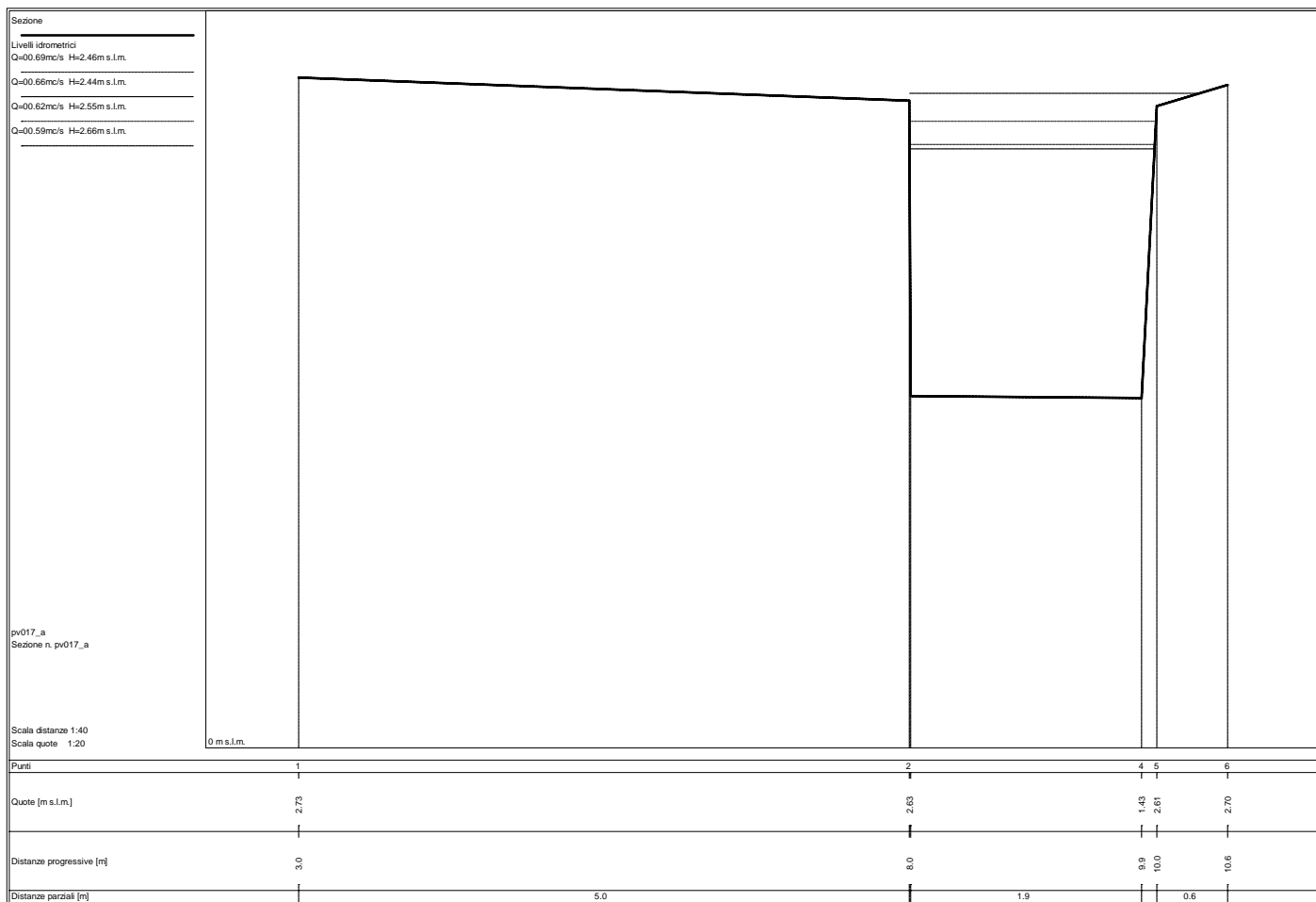
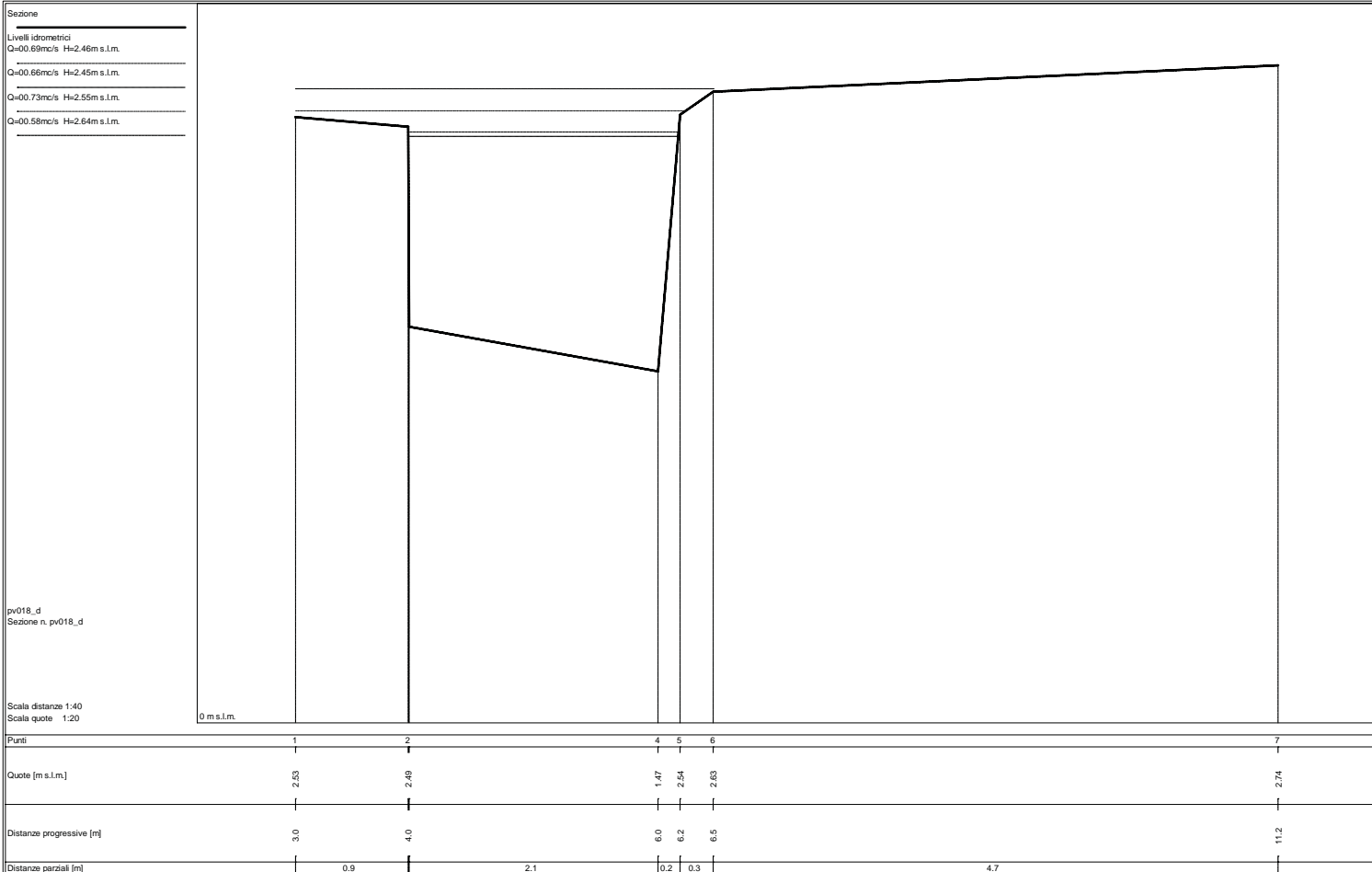

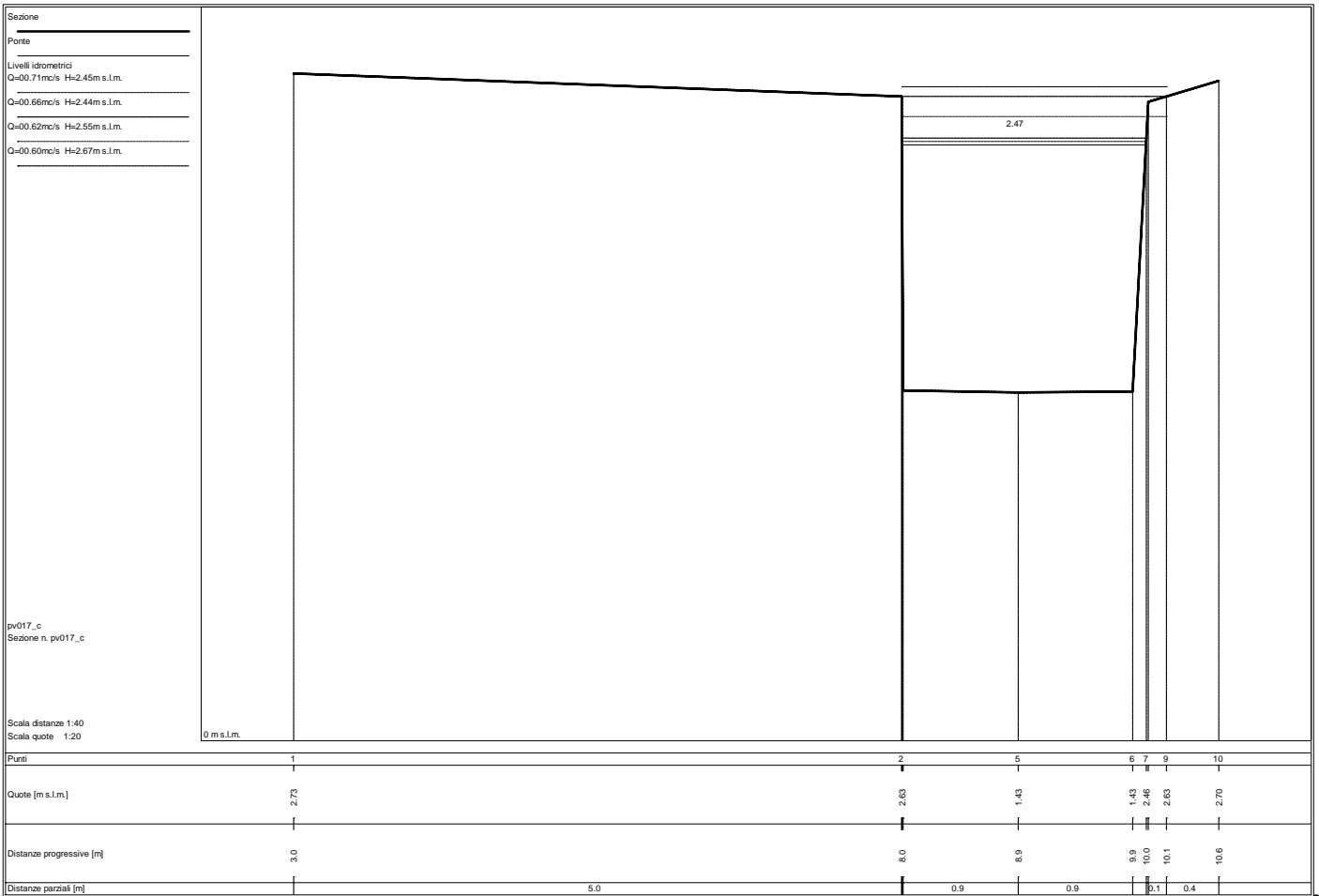
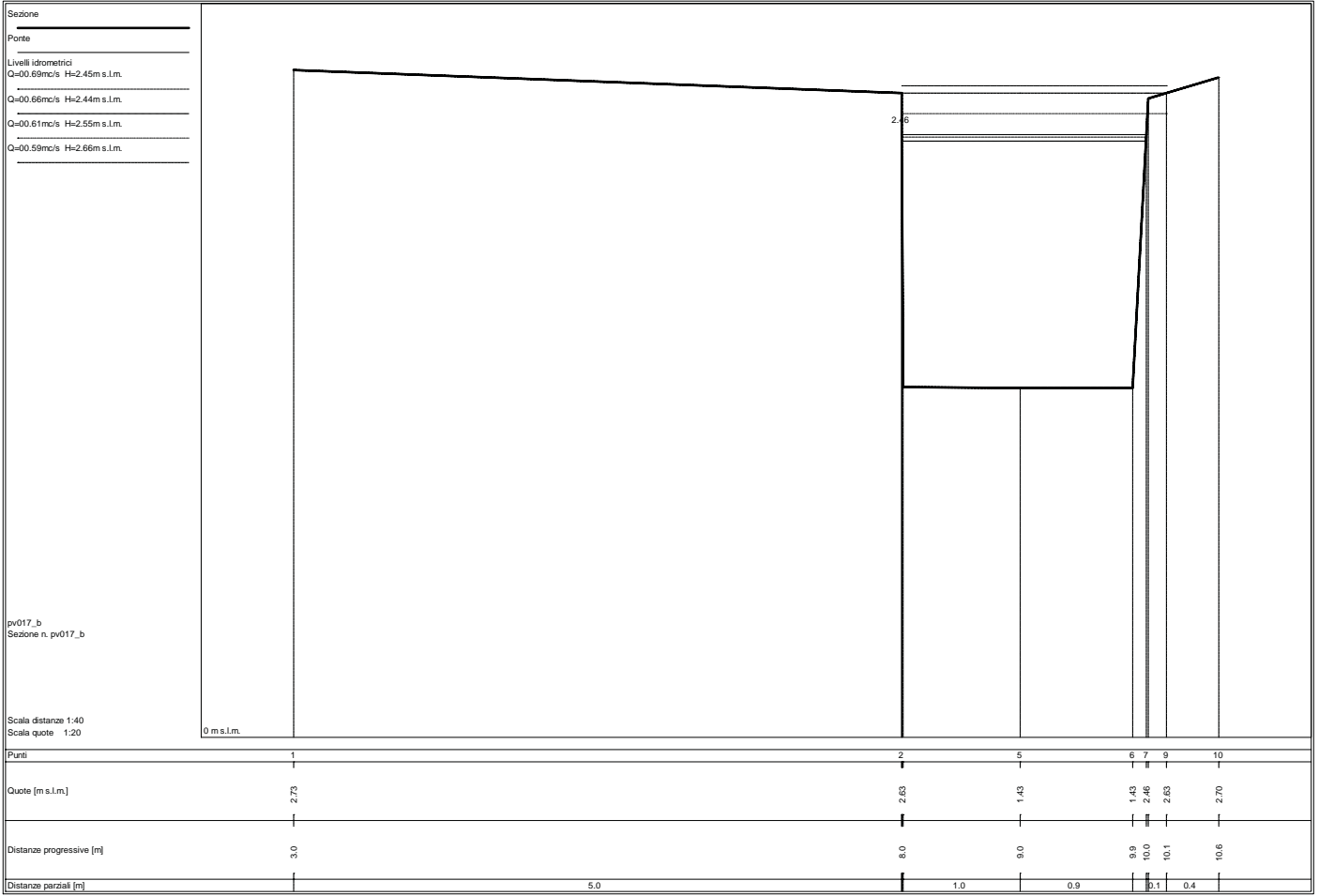

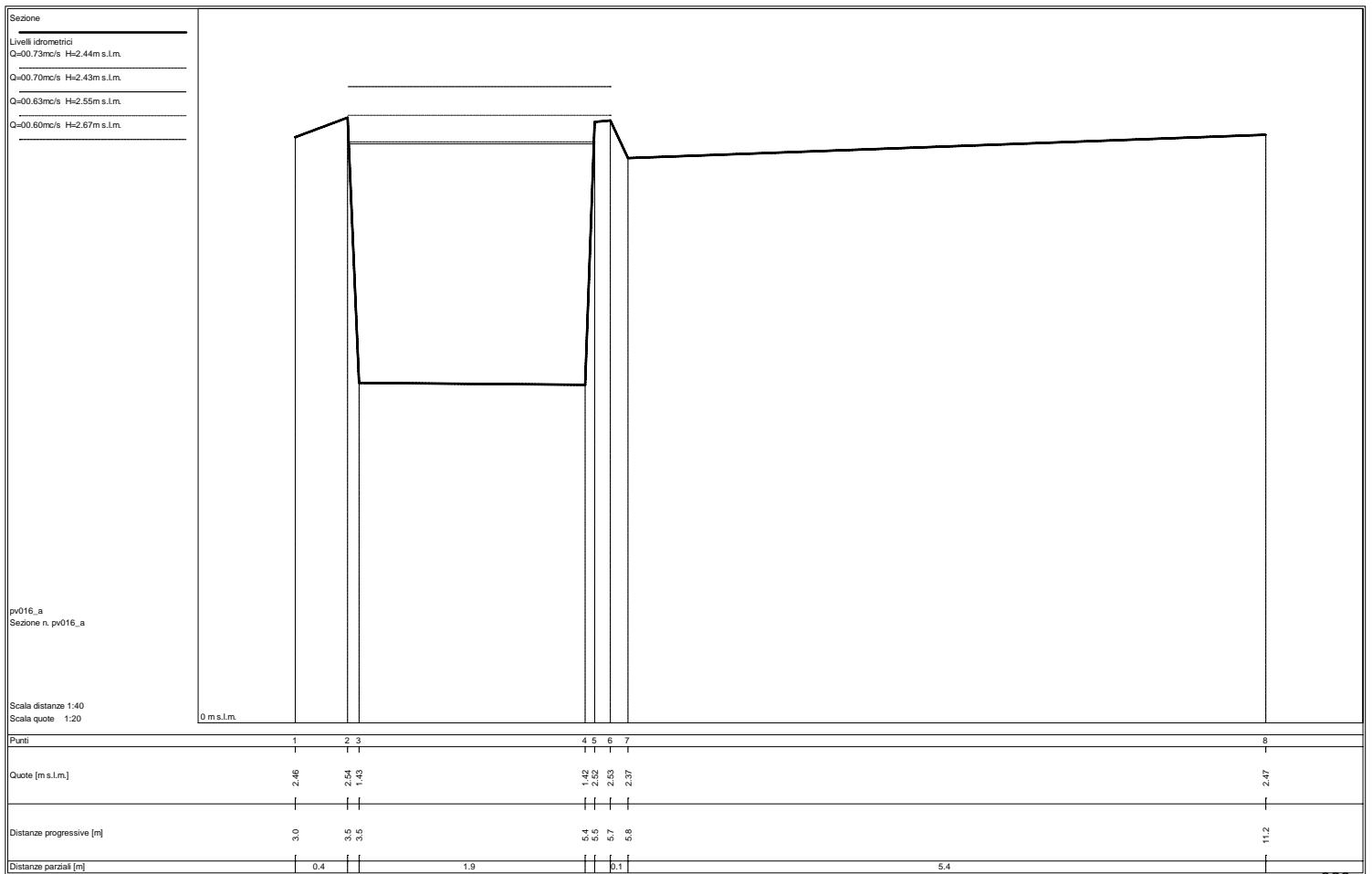
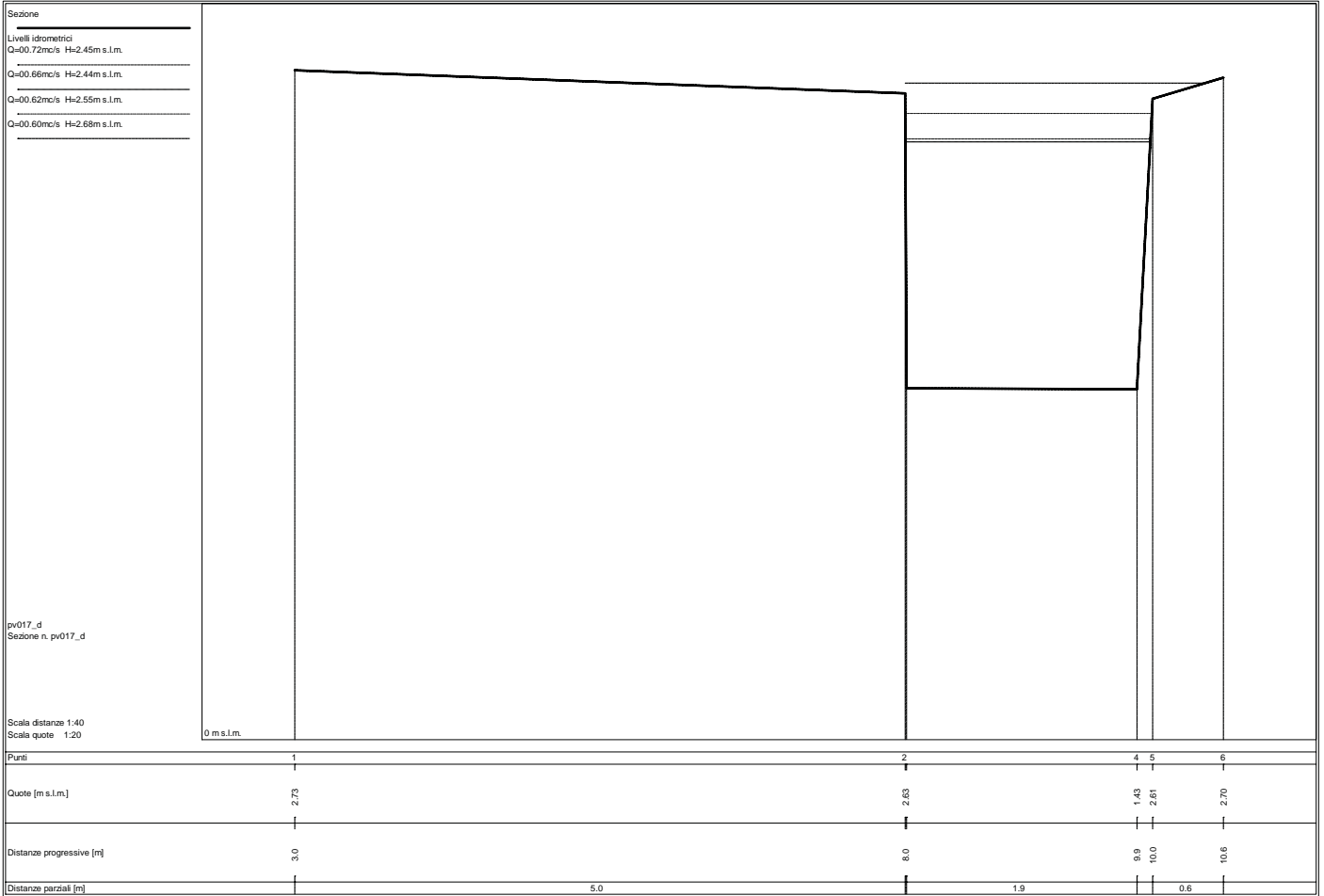

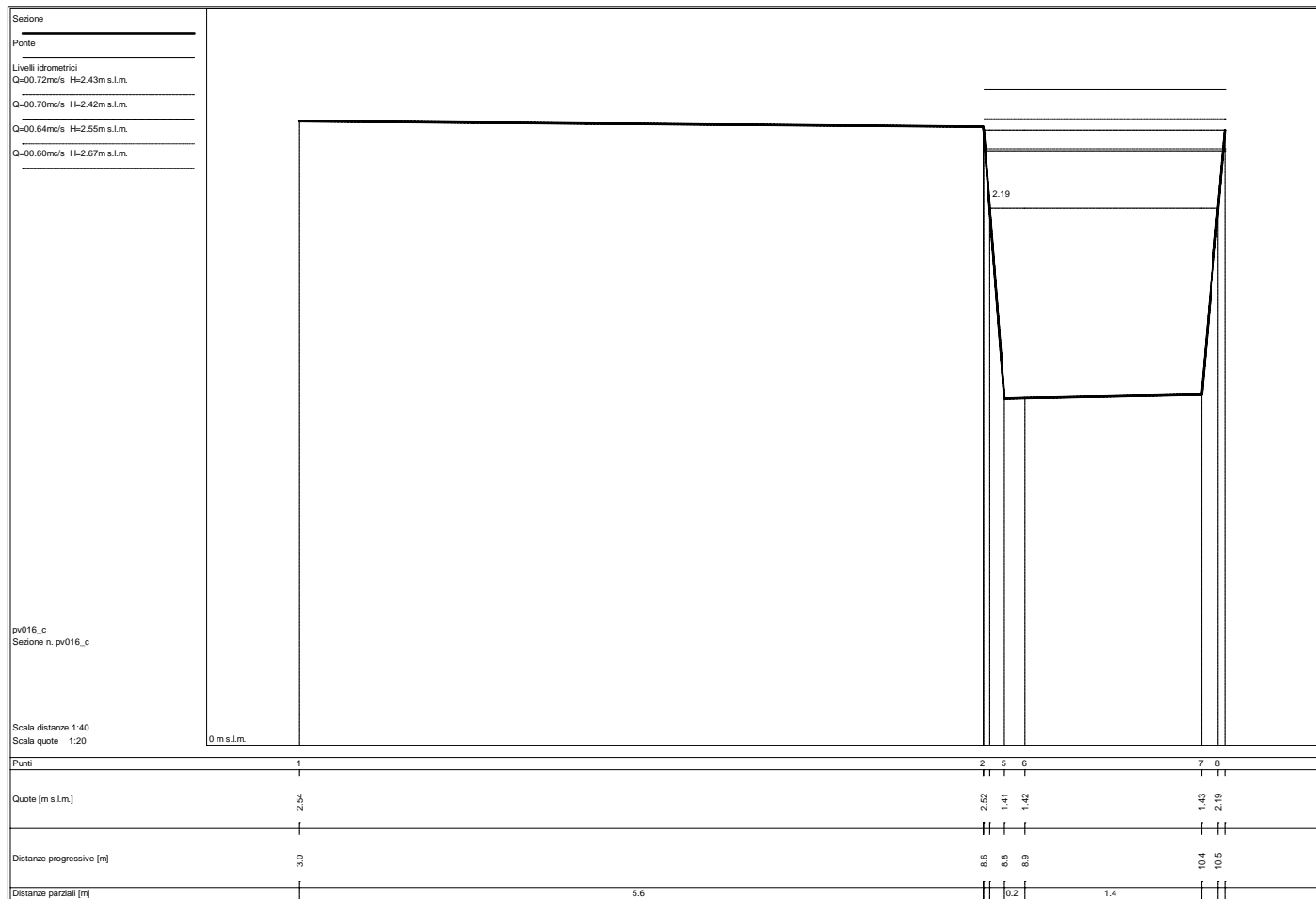
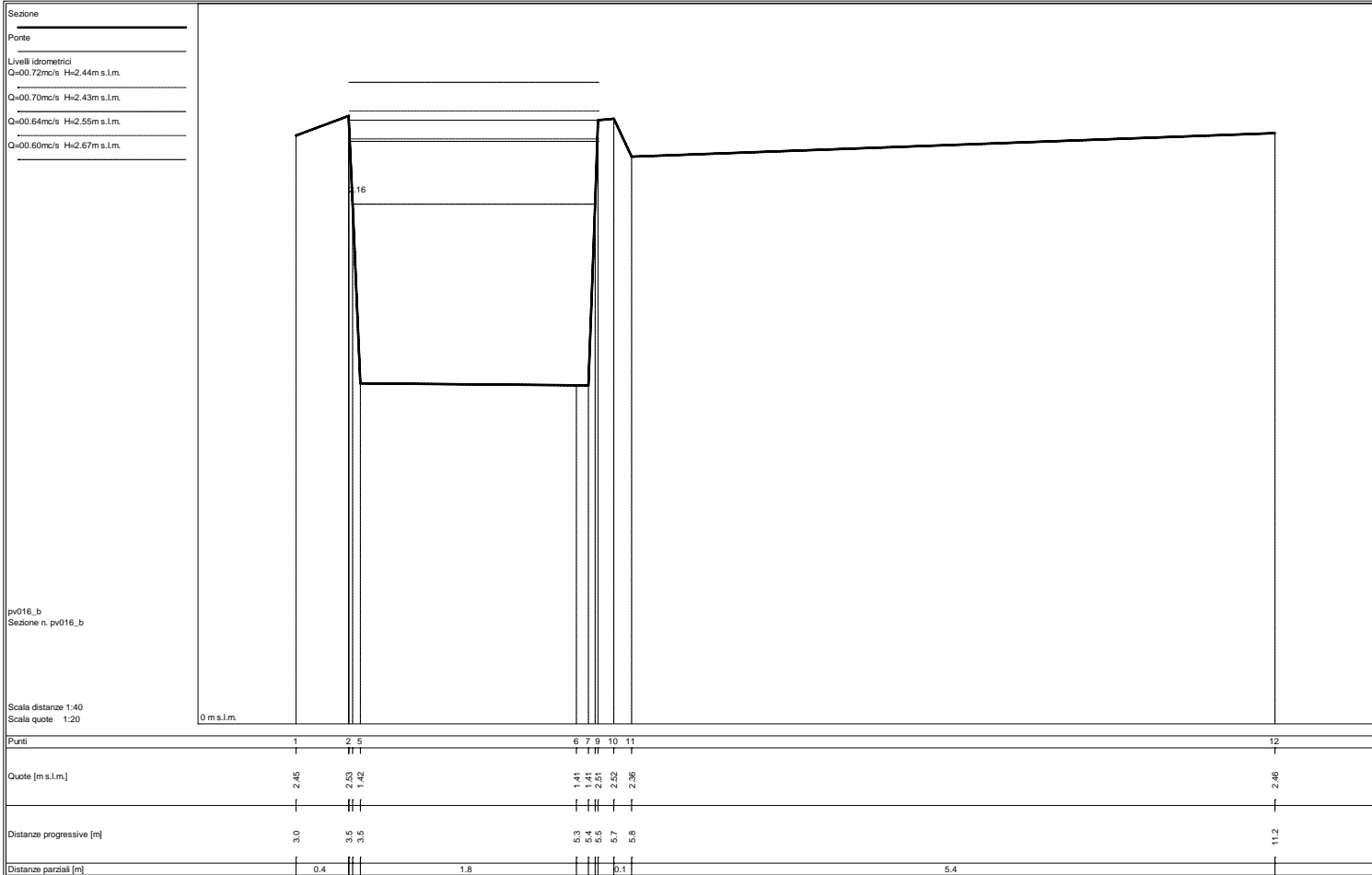

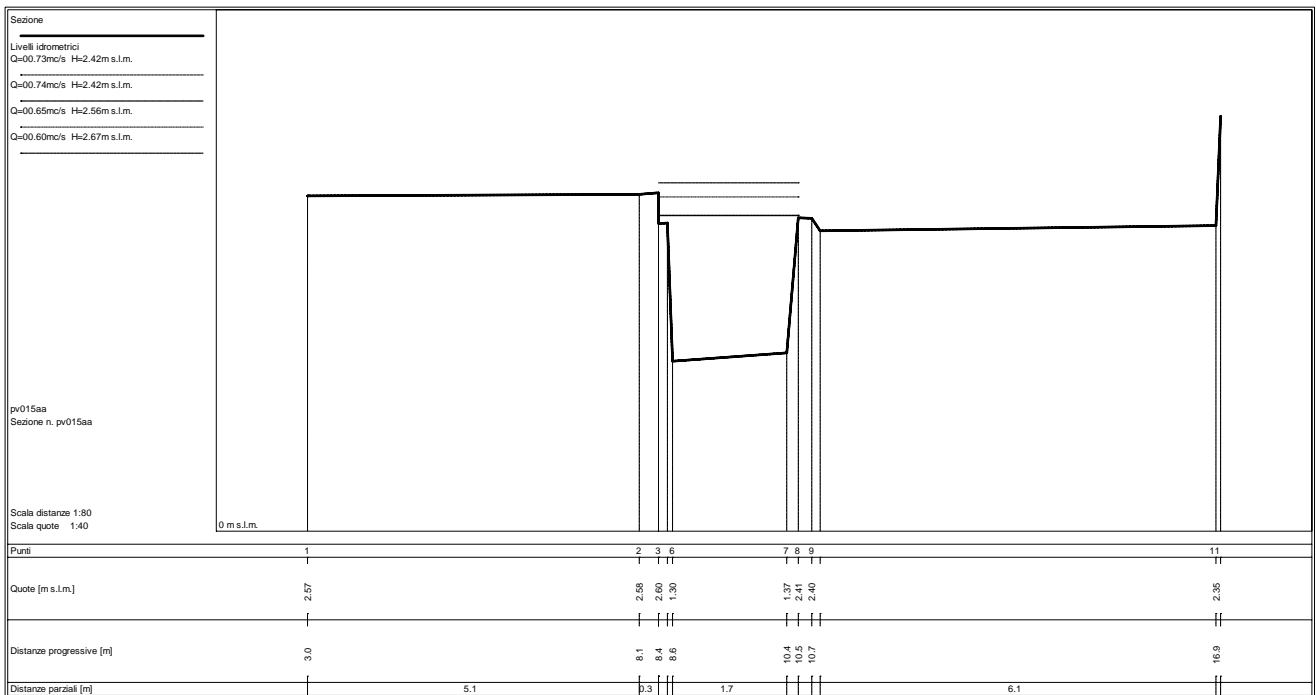
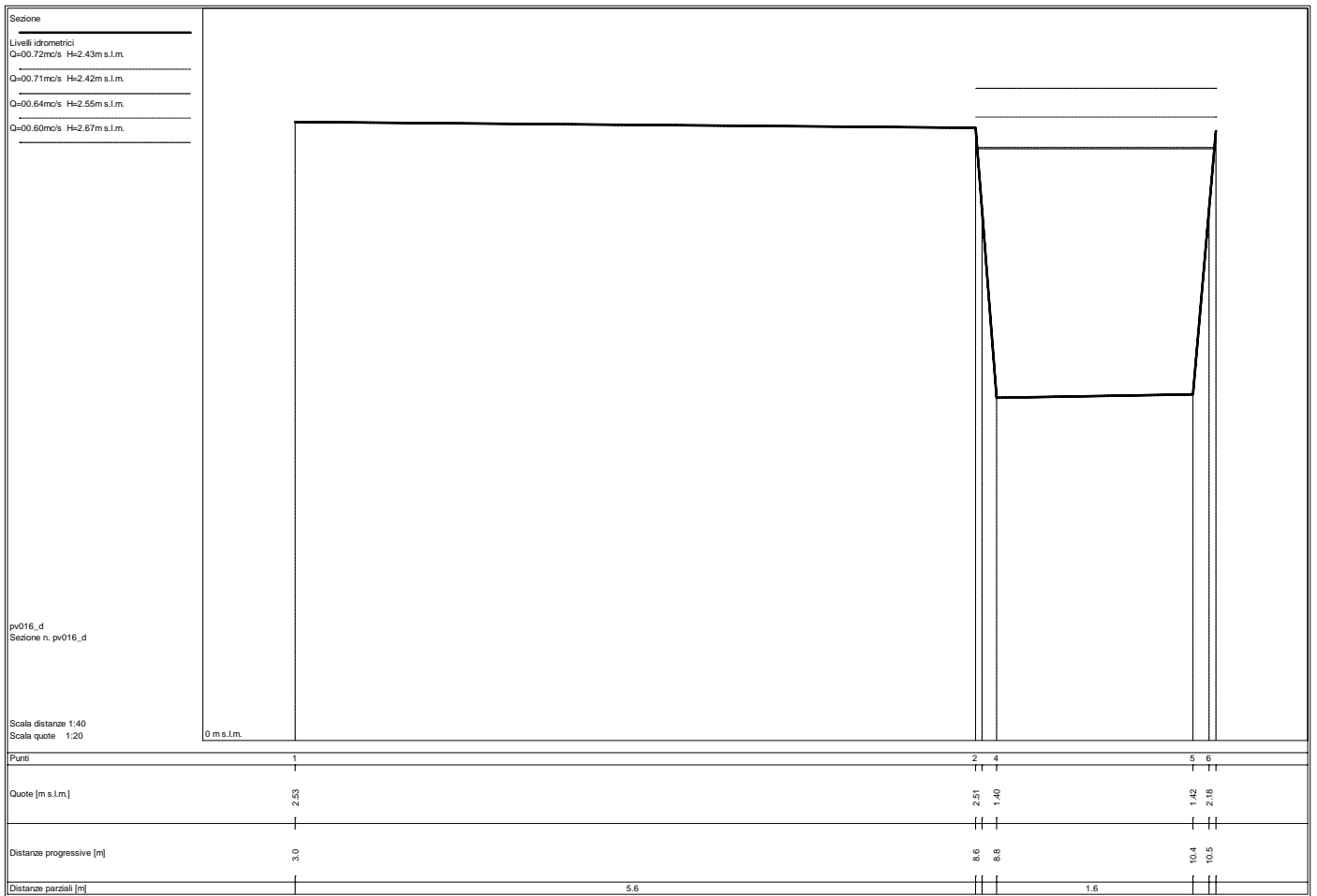

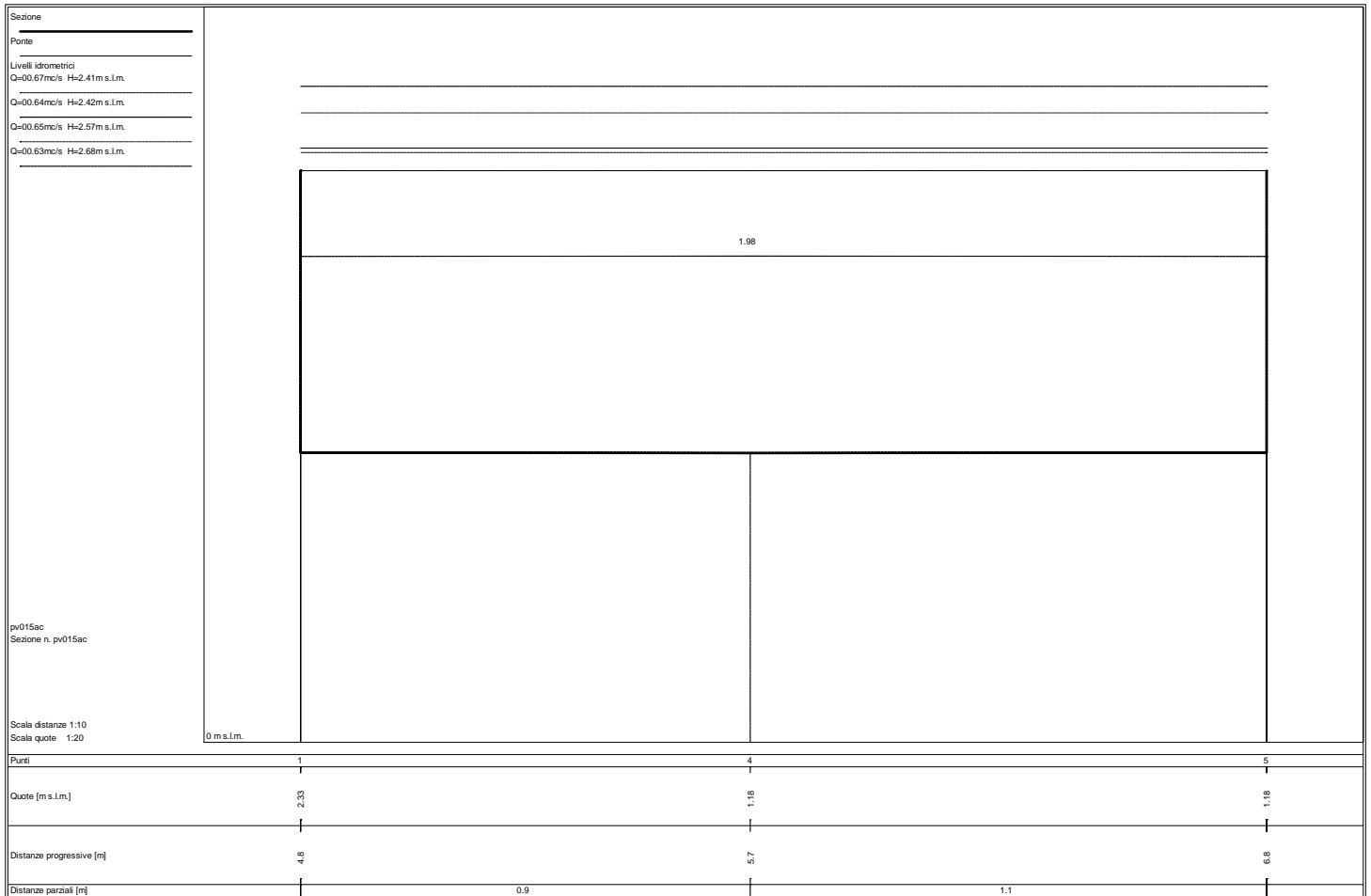
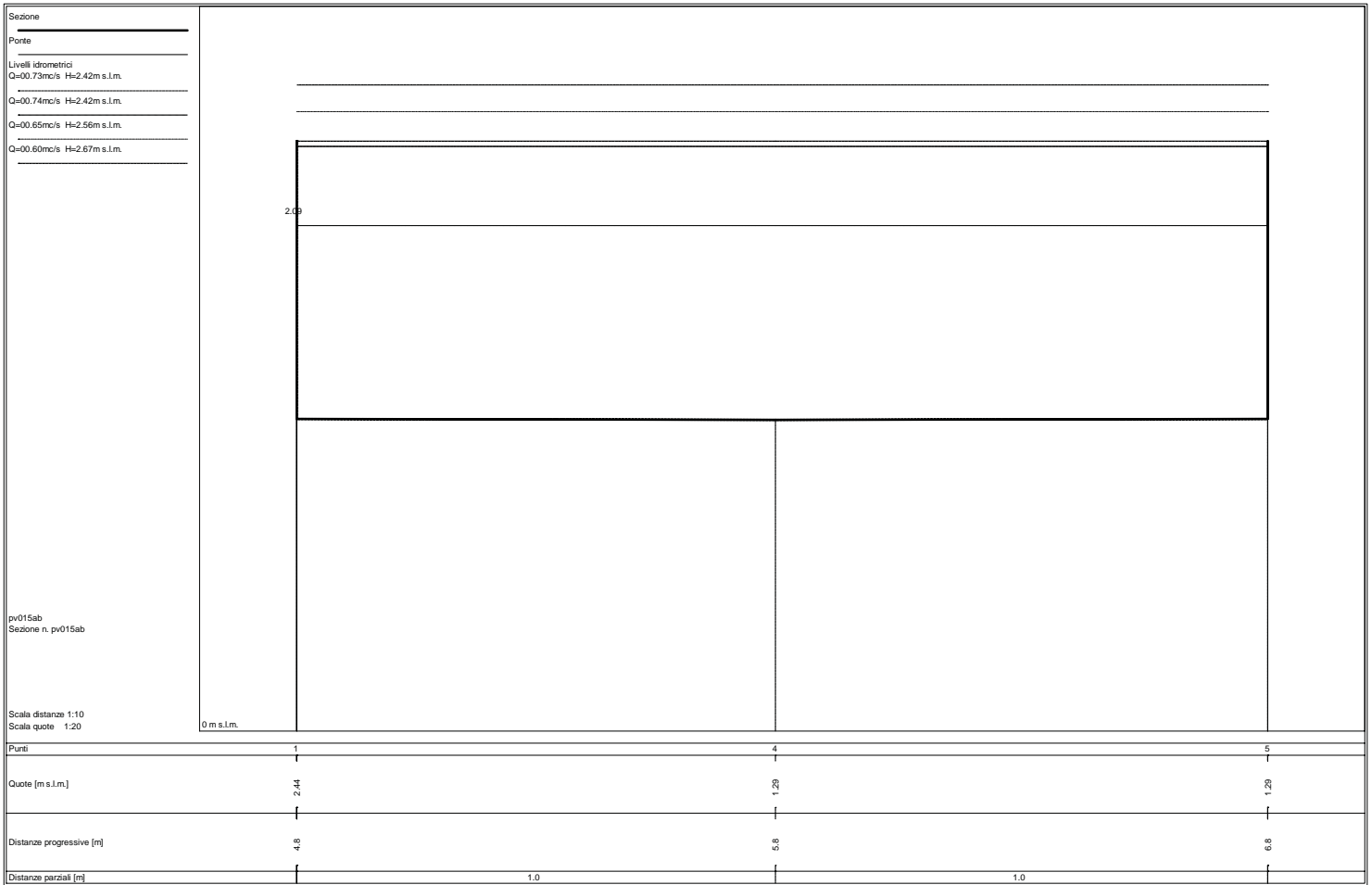

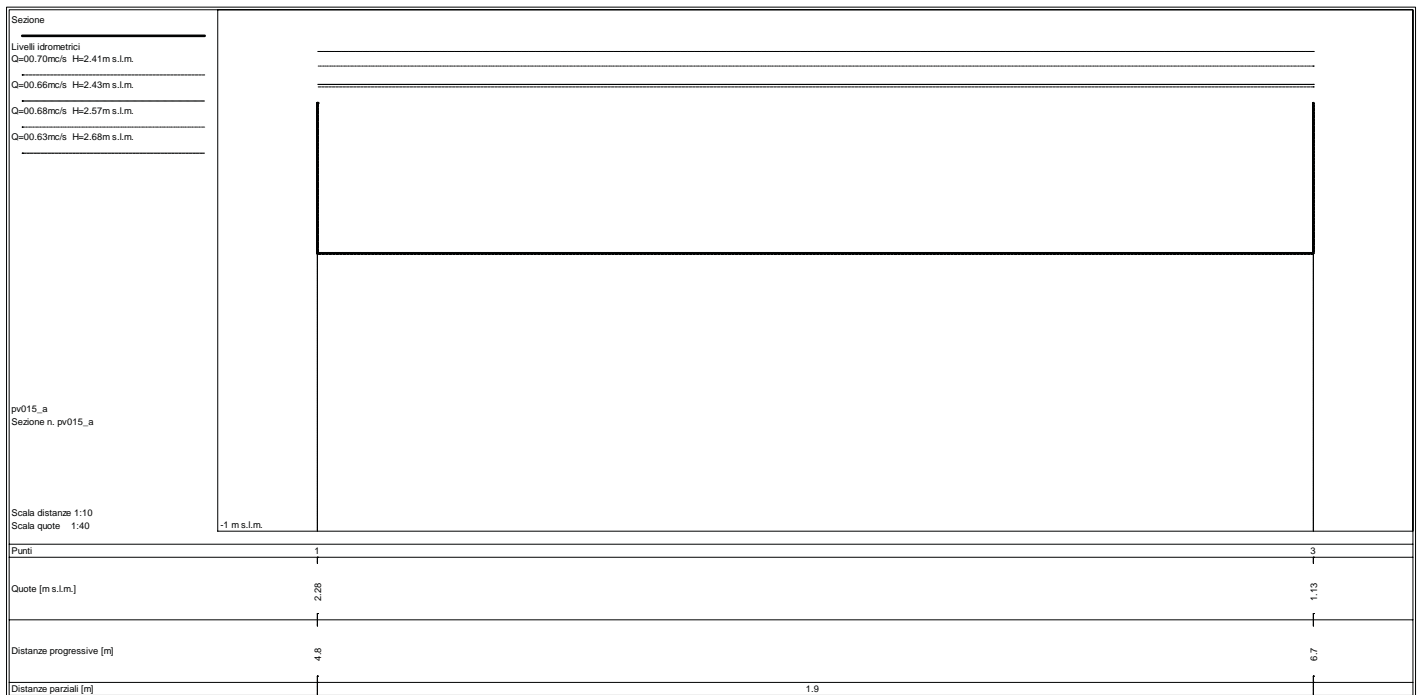
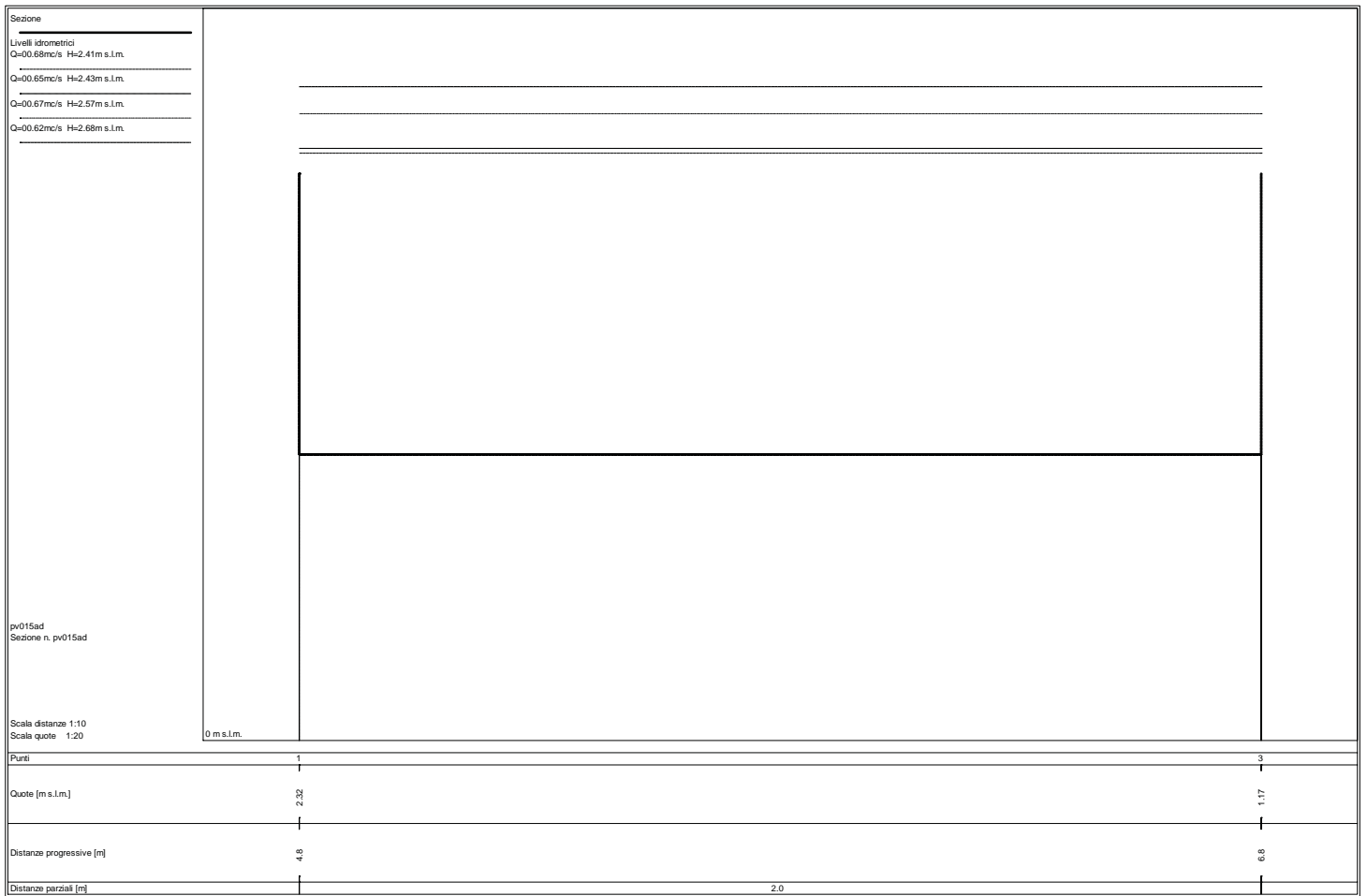

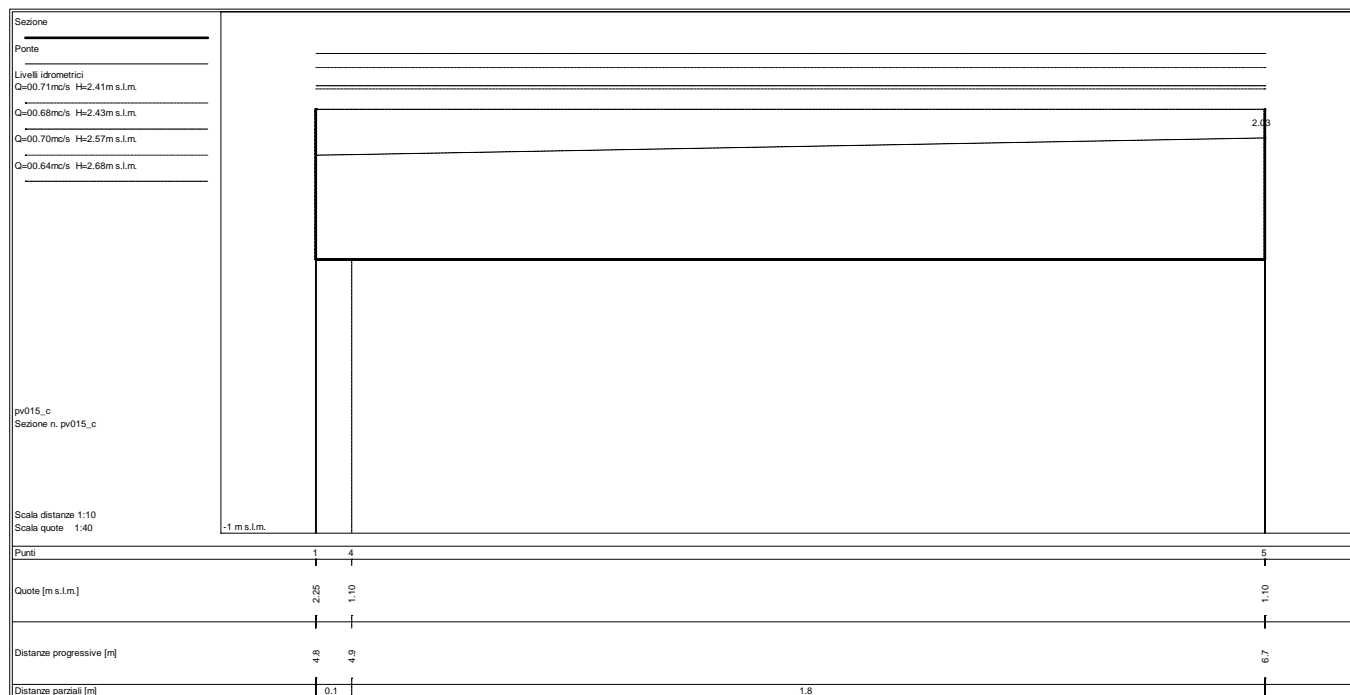
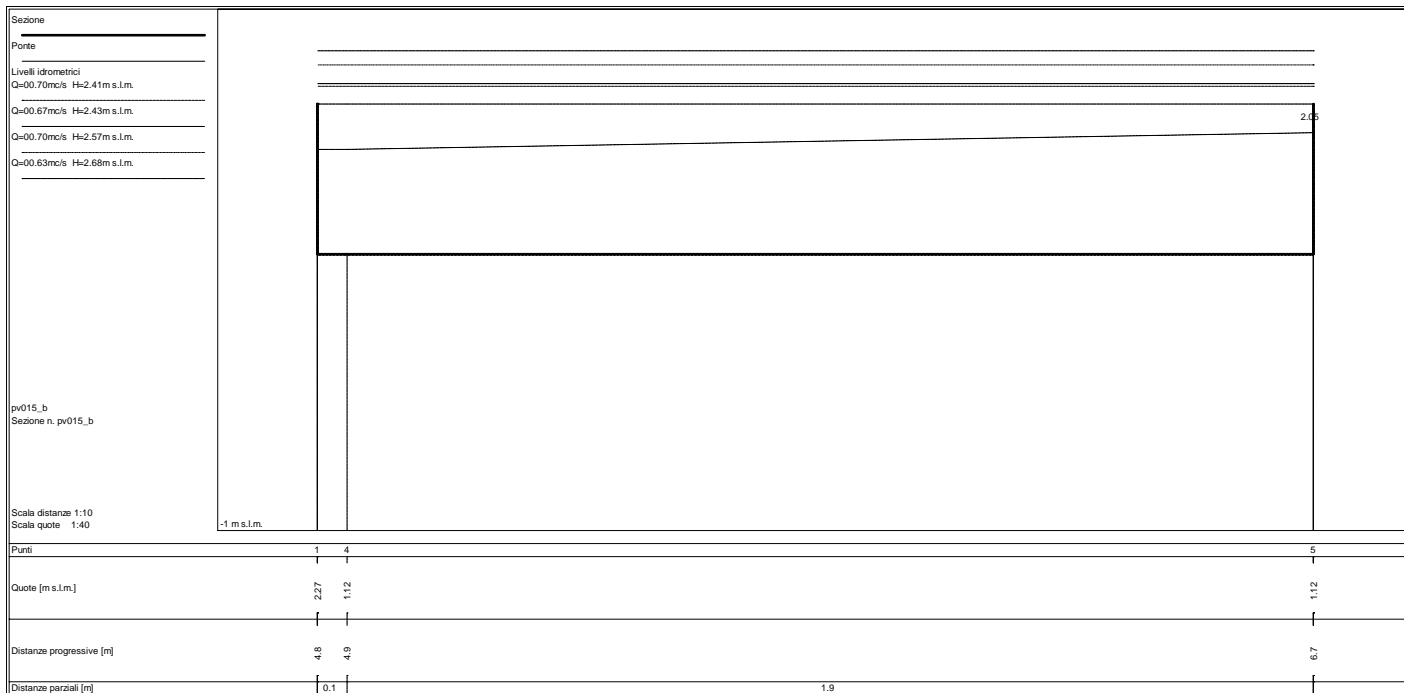

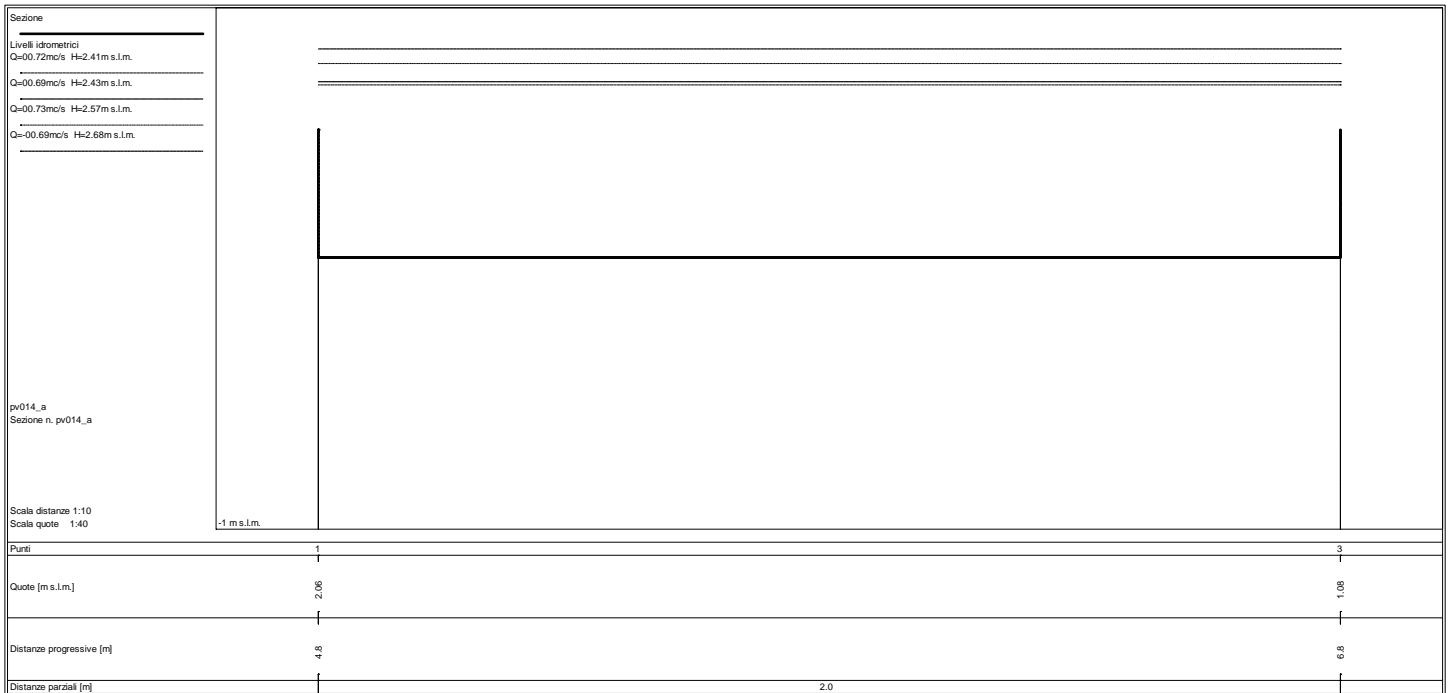
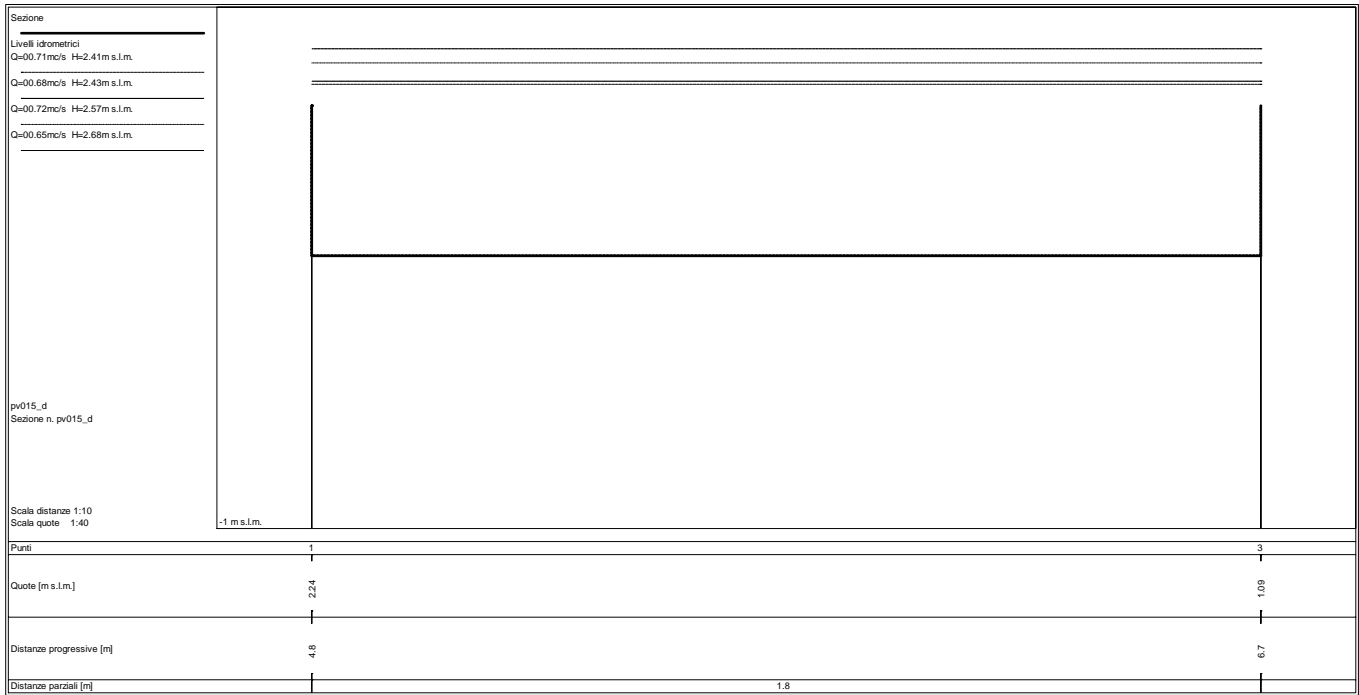

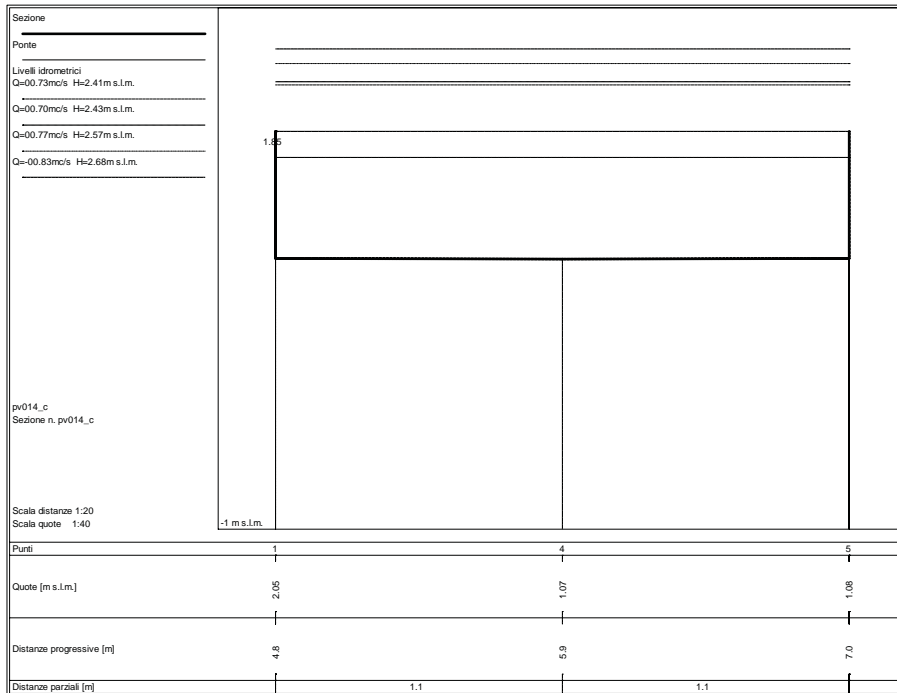
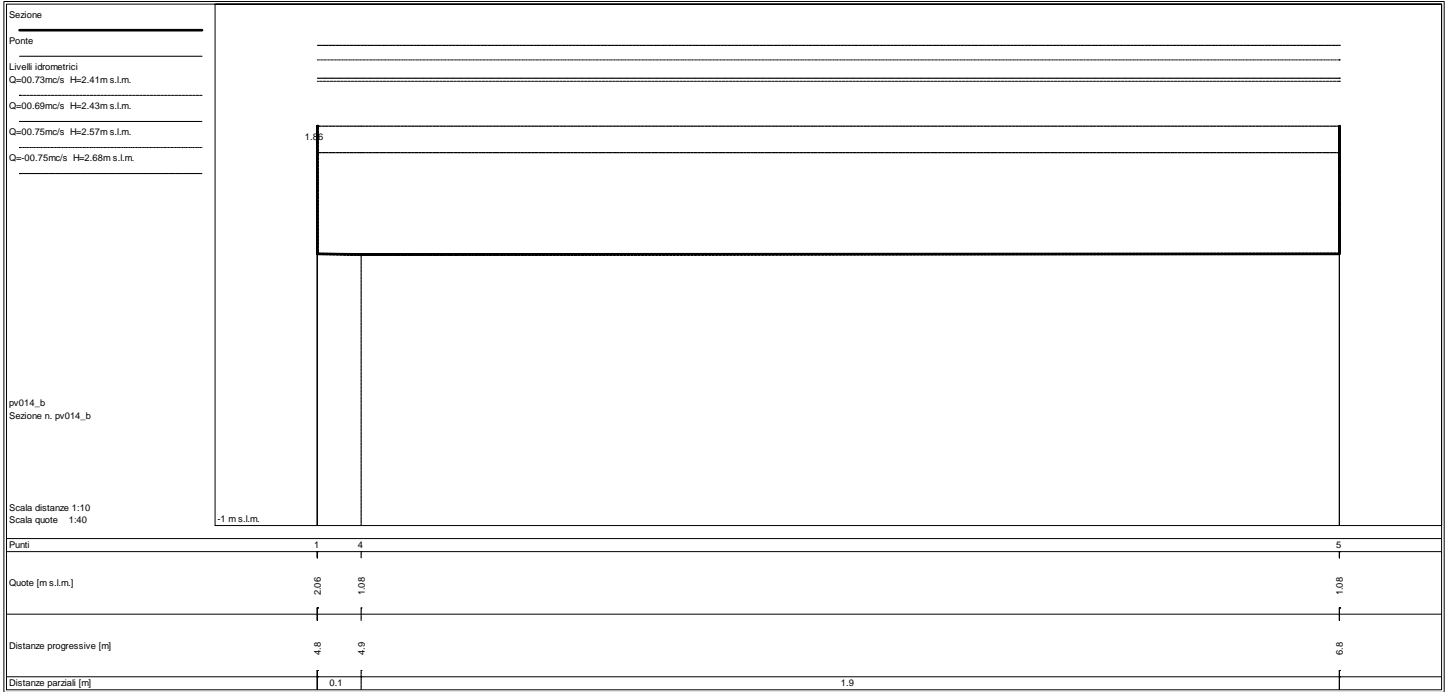

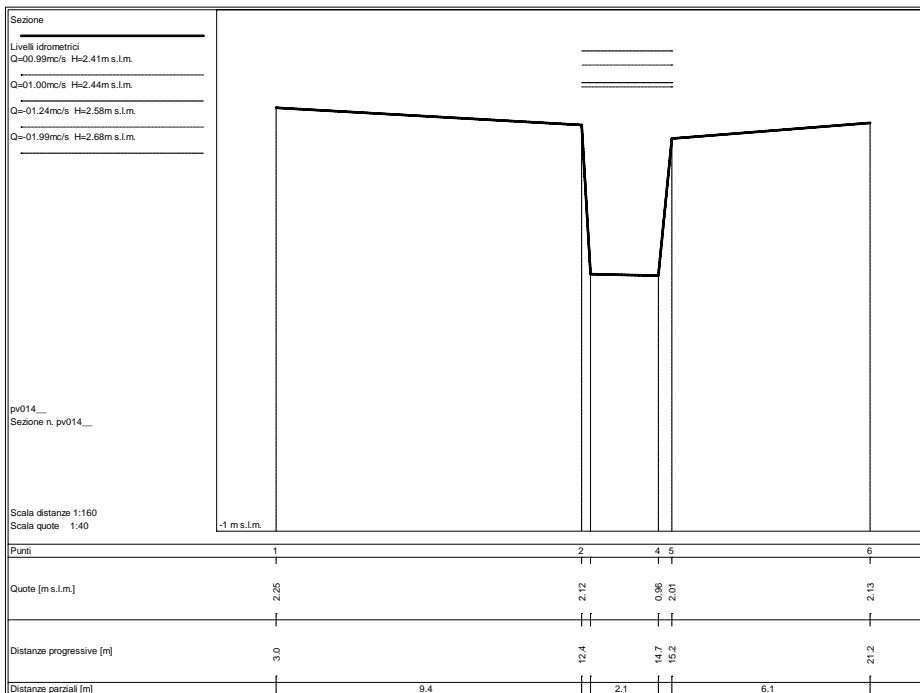
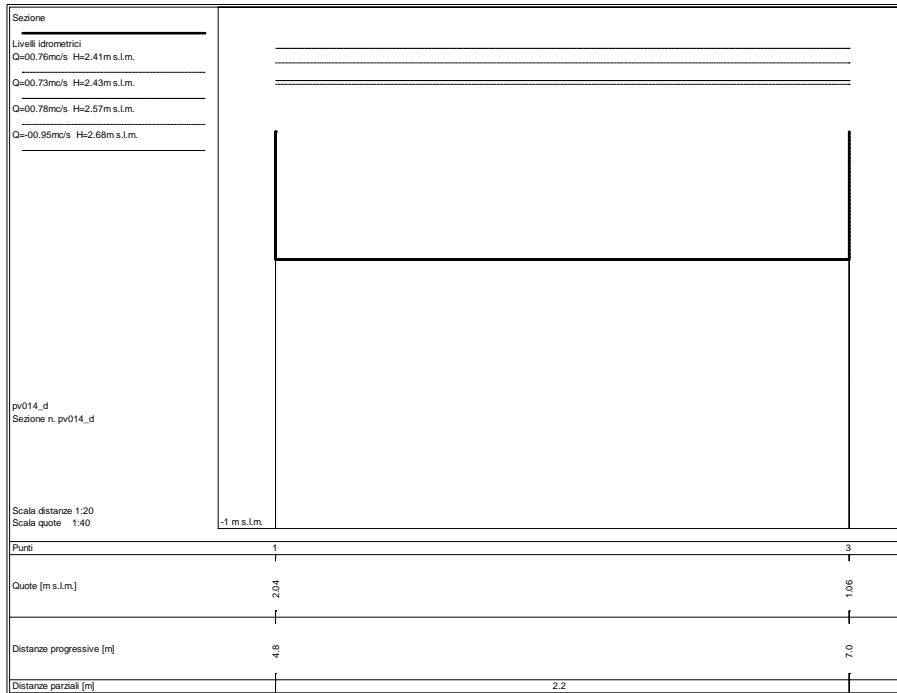

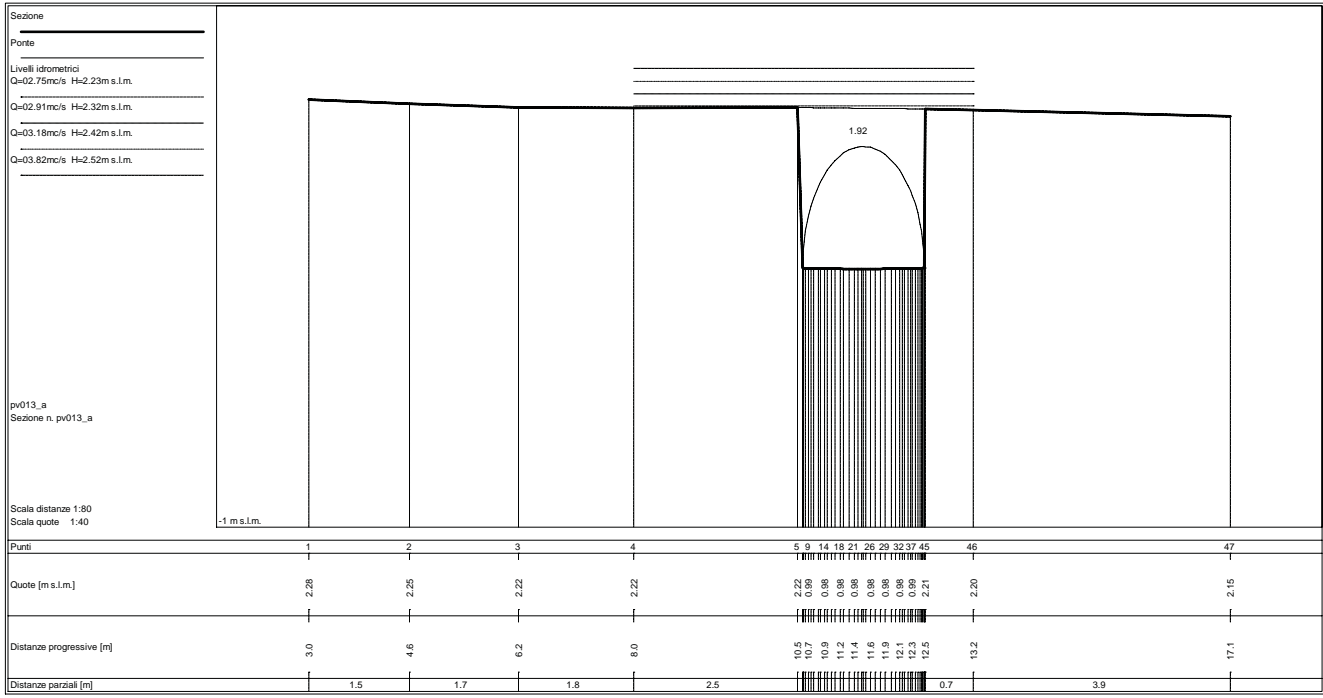
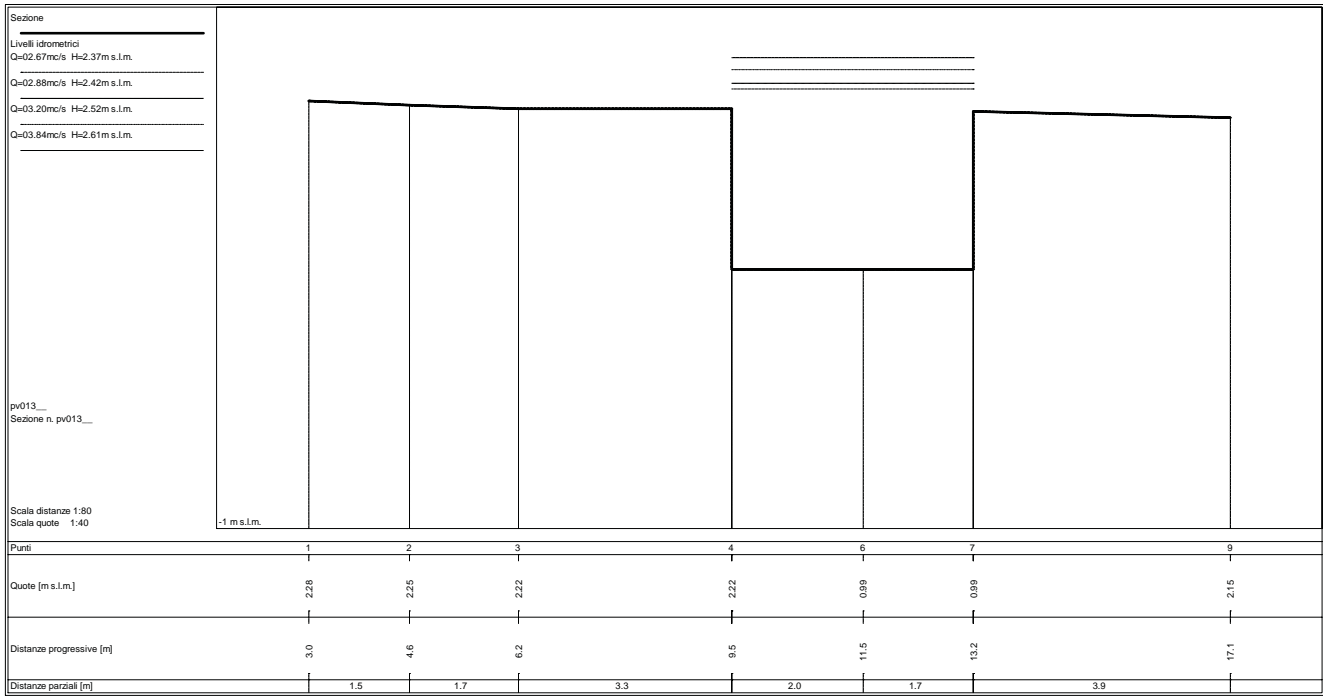

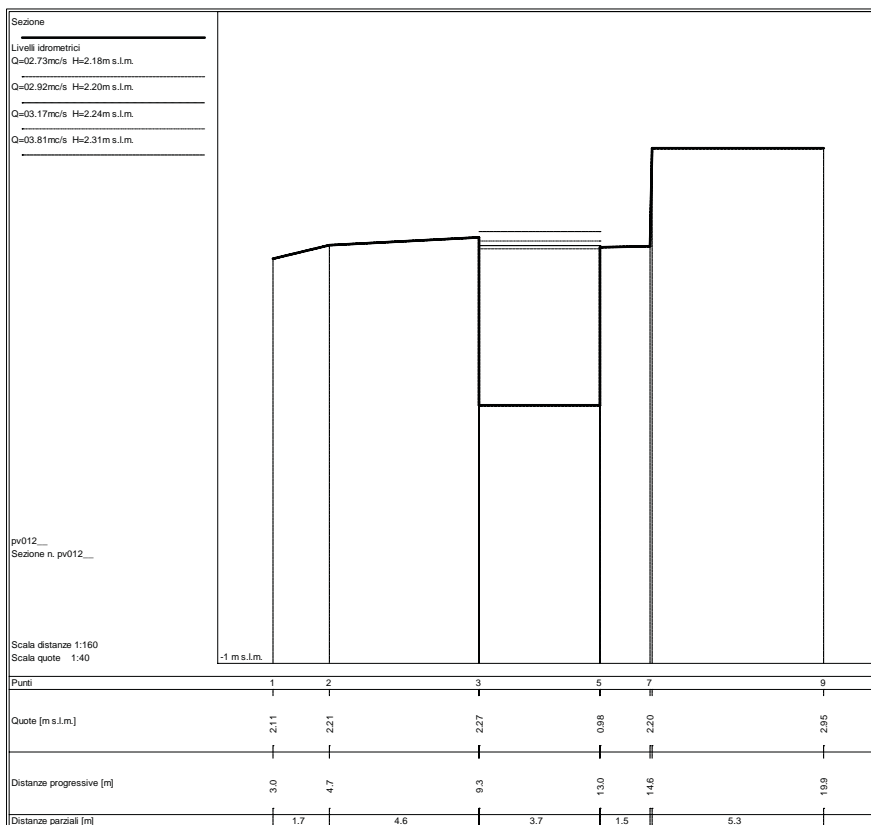
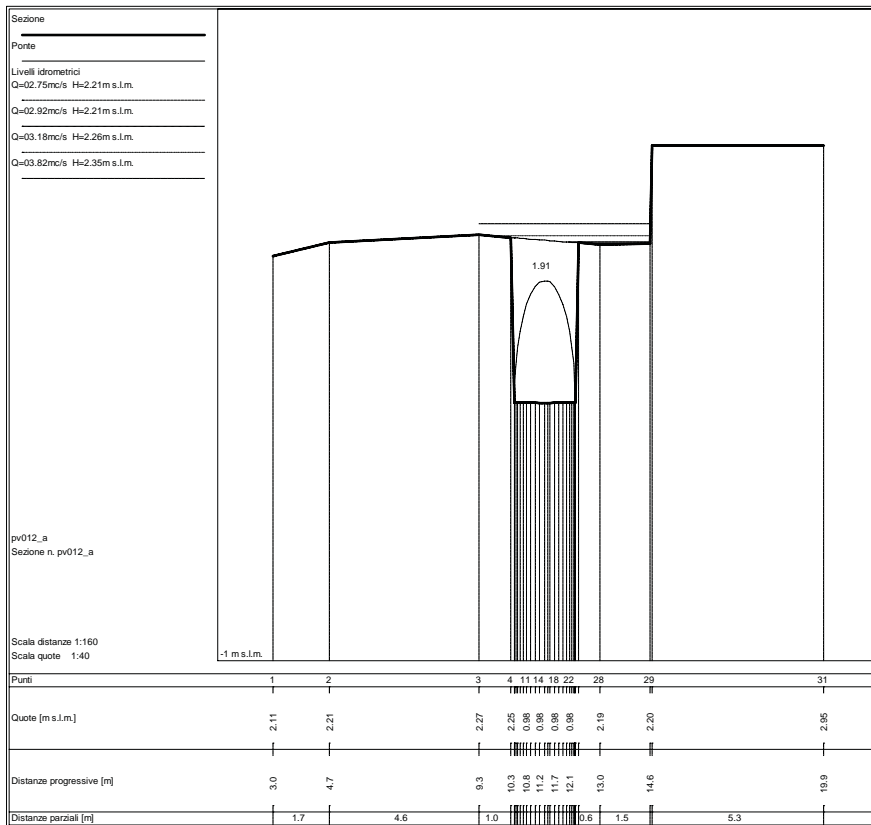

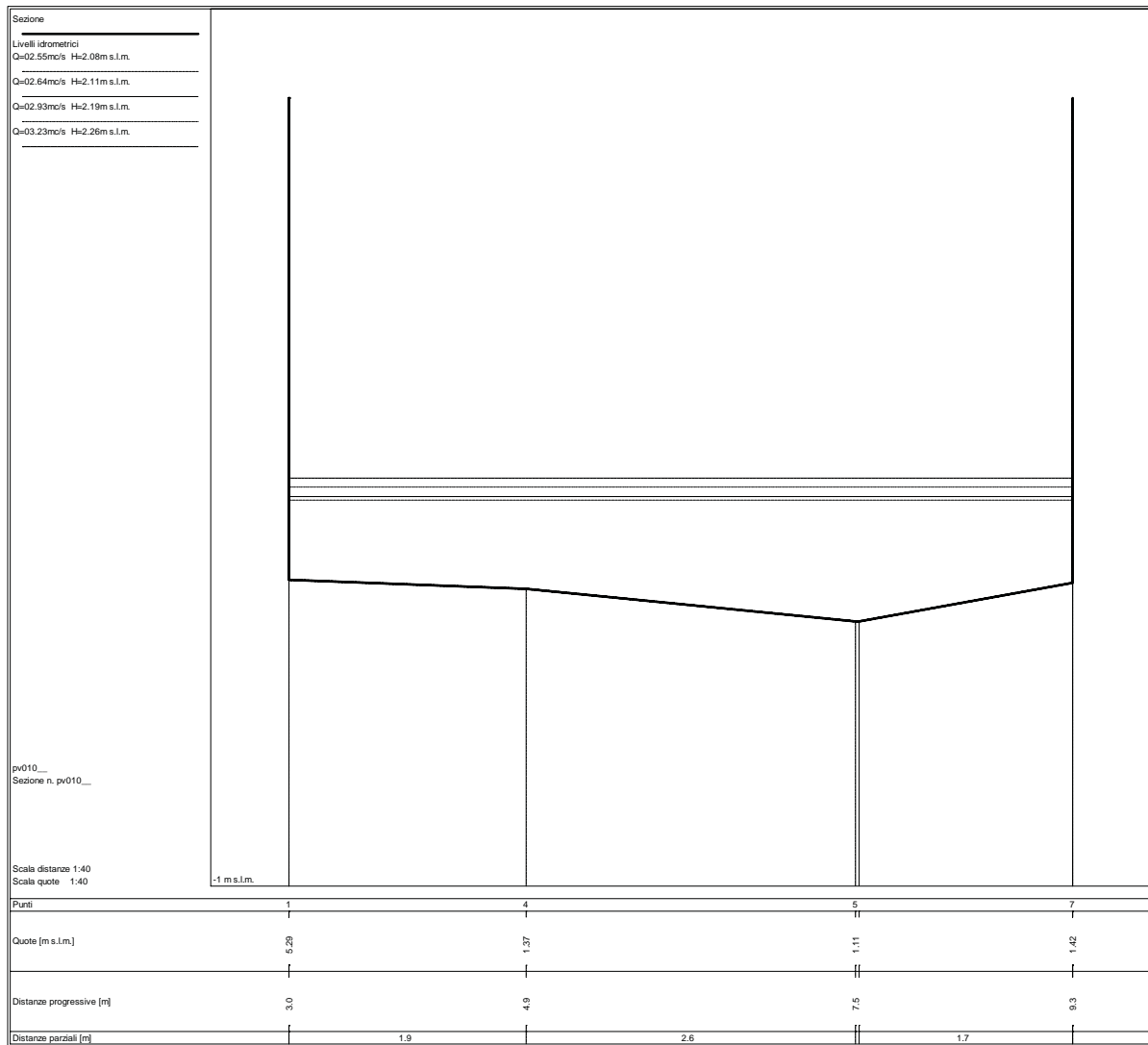
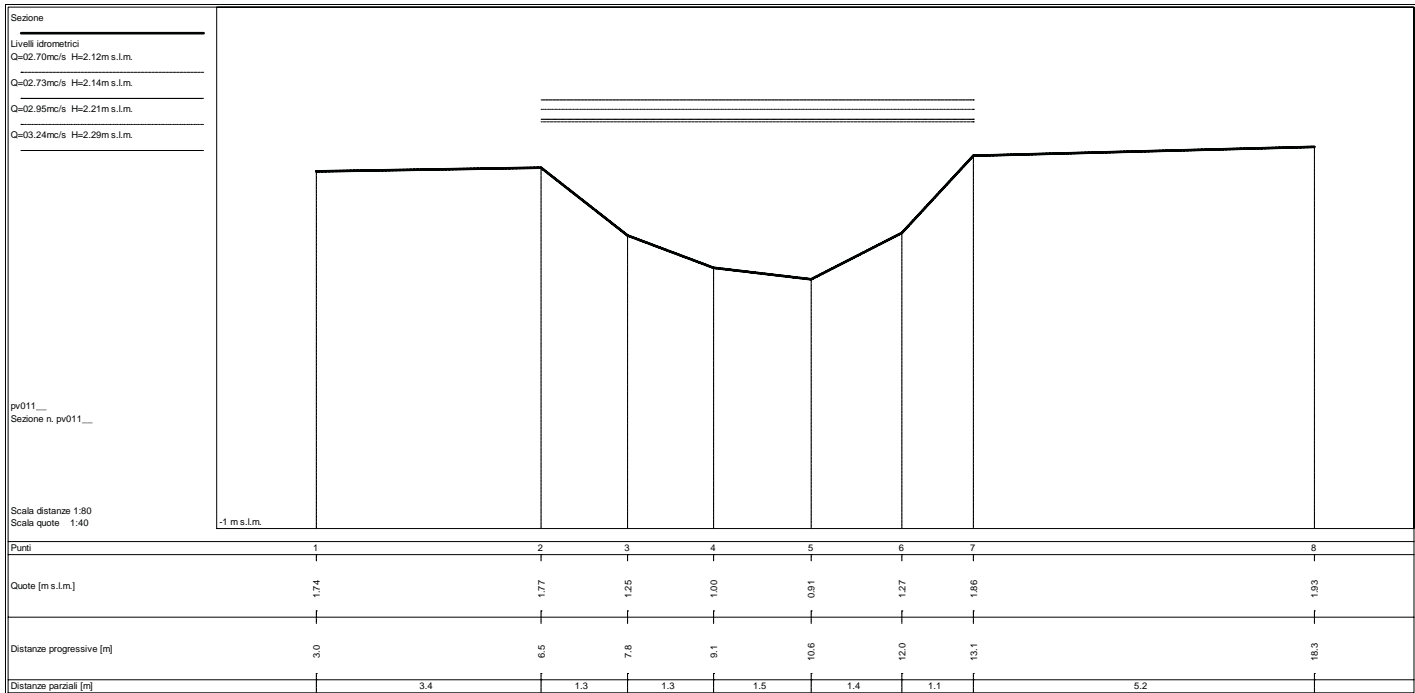

Sezione
 Ponte
 Livelli idrometrici
 Q=02.54mc/s H=1.99m s.l.m.
 Q=02.64mc/s H=2.02m s.l.m.
 Q=02.93mc/s H=2.09m s.l.m.
 Q=03.23mc/s H=2.16m s.l.m.

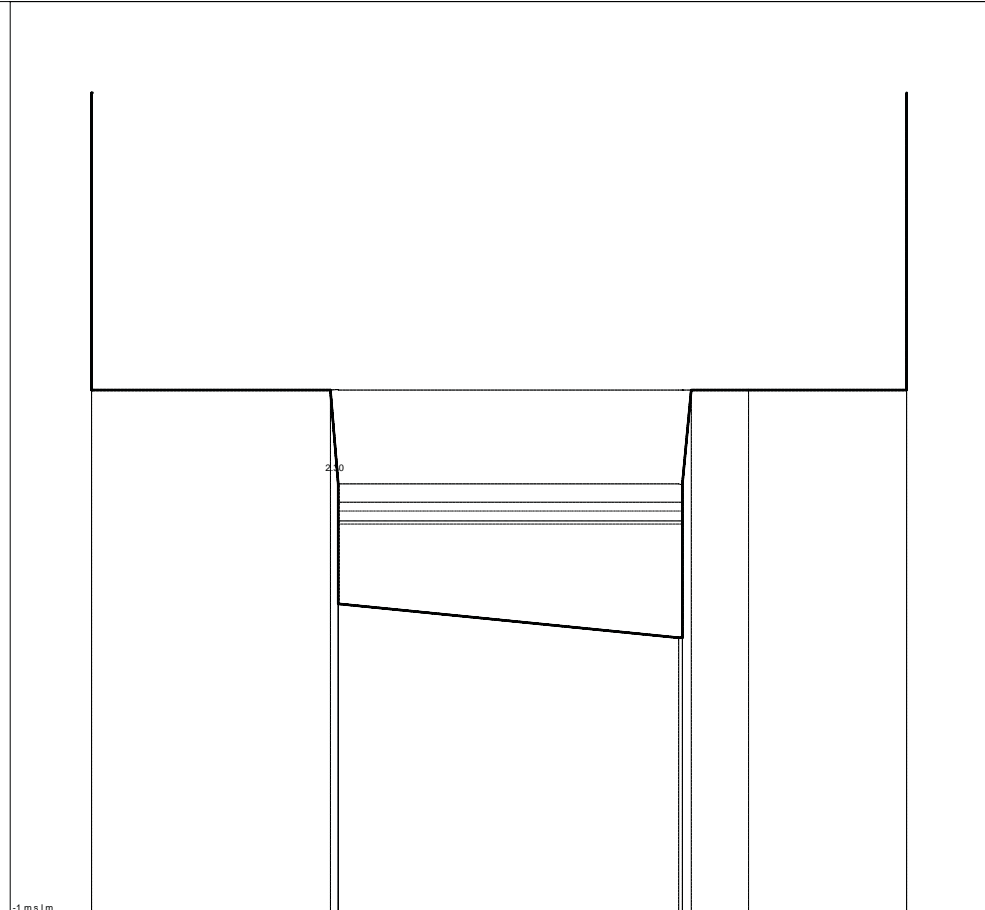

pv010_a
 Sezione n. pv010_a

Scala distanze 1:40
 Scala quote 1:40

Punti	1	4	7	11	12
Quote [m s.l.m.]	5.30	3.02	1.12	3.02	3.02
Distanze progressive [m]	3.0	4.8	7.5	8.1	9.3
Distanze parziali [m]		1.8	2.6	0.4	1.2

Sezione
 Ponte
 Livelli idrometrici
 Q=02.54mc/s H=1.99m s.l.m.
 Q=02.64mc/s H=2.01m s.l.m.
 Q=02.93mc/s H=2.09m s.l.m.
 Q=03.23mc/s H=2.16m s.l.m.

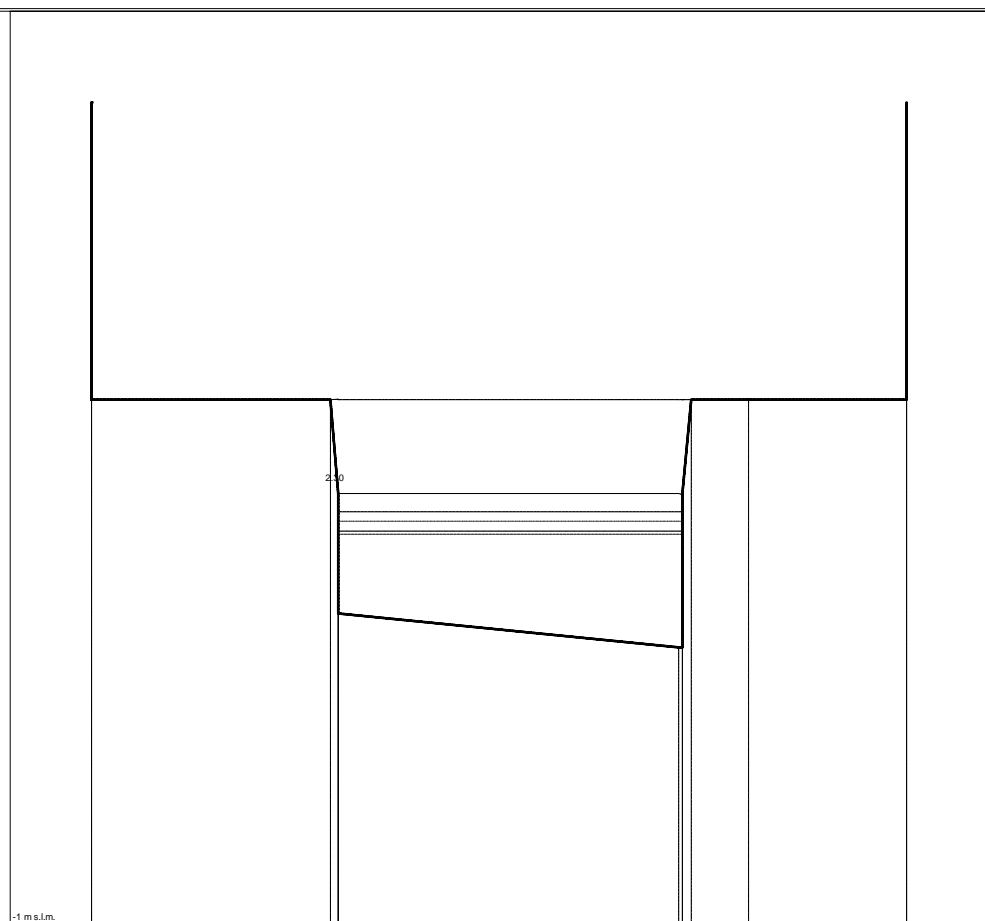

pv010_av
 Sezione n. pv010_av

Scala distanze 1:40
 Scala quote 1:40

Punti	1	4	7	11	12
Quote [m s.l.m.]	5.30	3.02	1.12	3.02	3.02
Distanze progressive [m]	3.0	4.8	7.5	8.1	9.3
Distanze parziali [m]		1.8	2.6	0.4	1.2

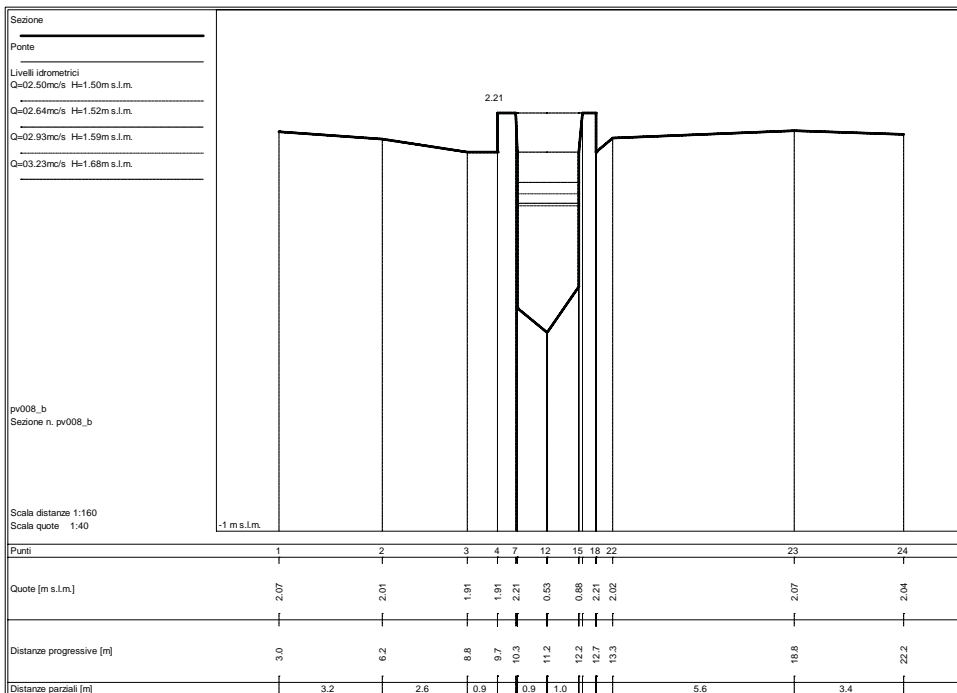
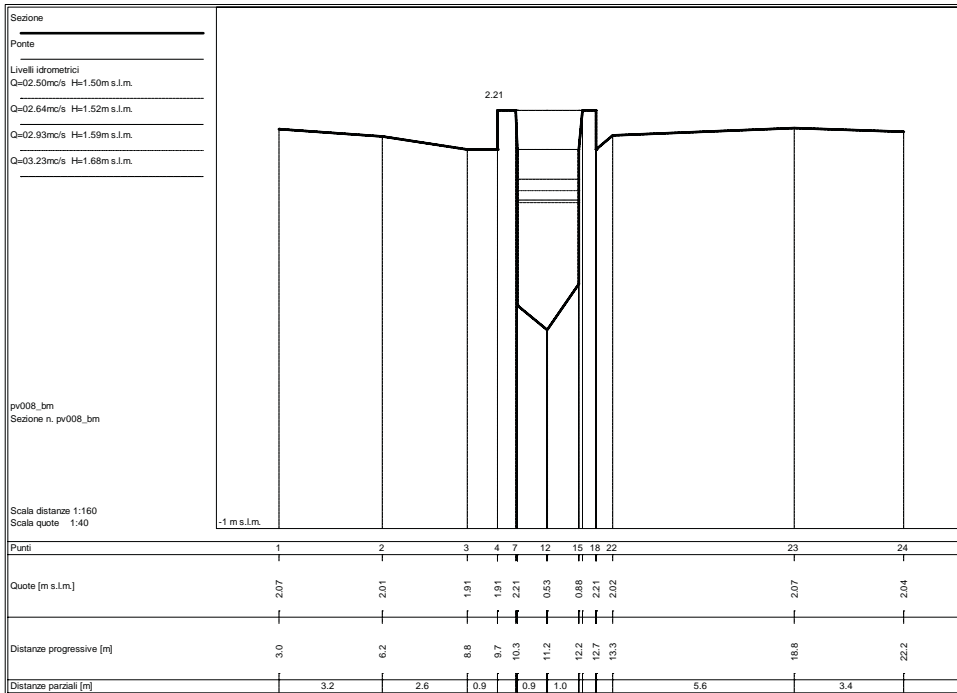

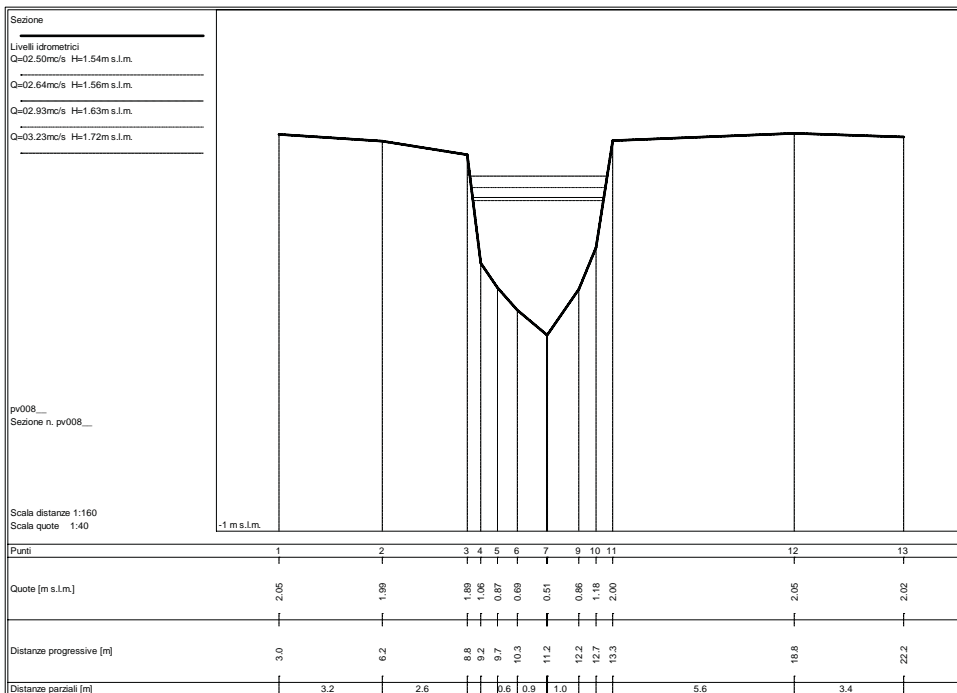
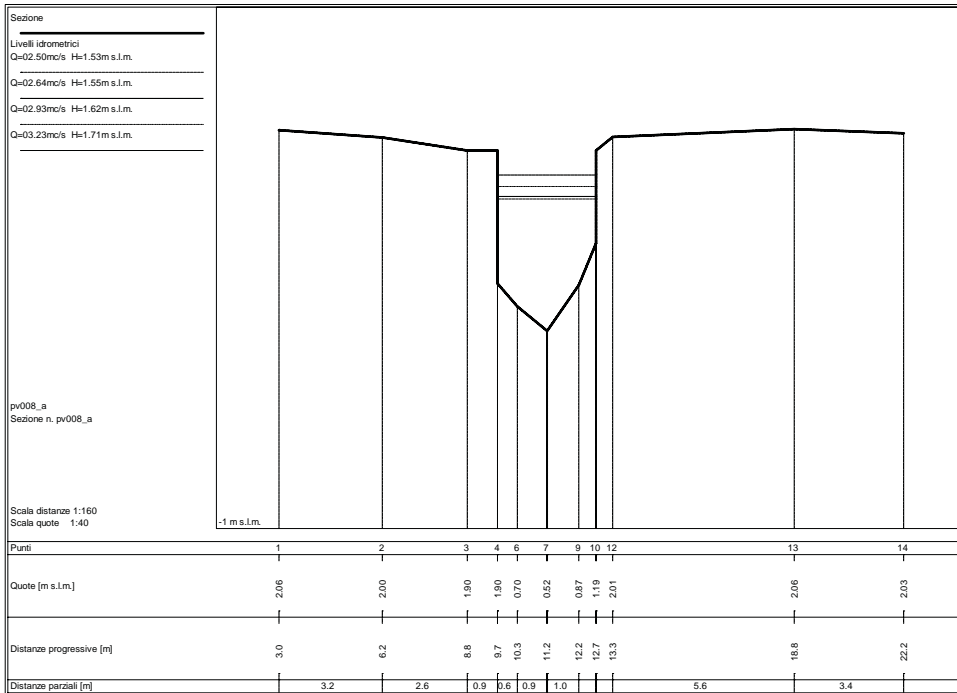

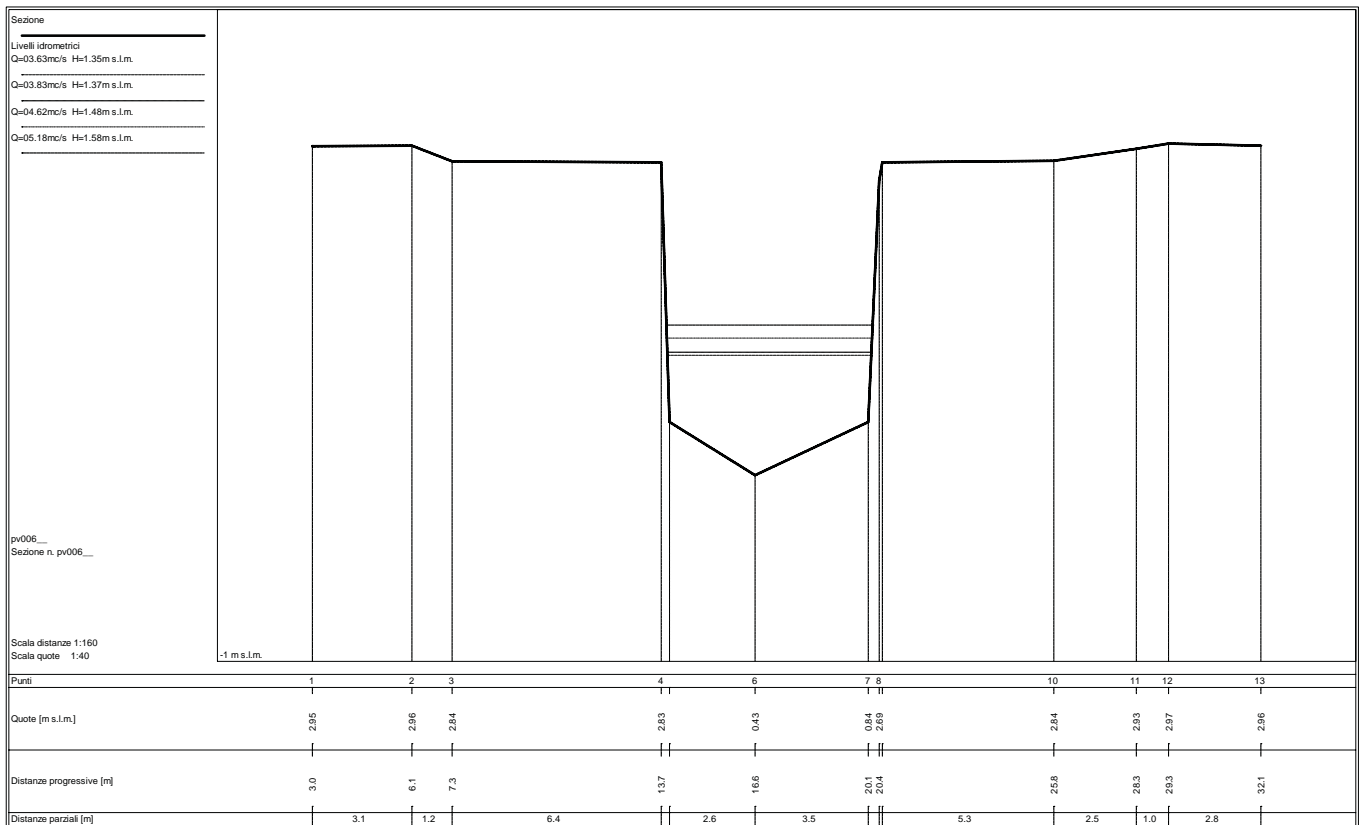
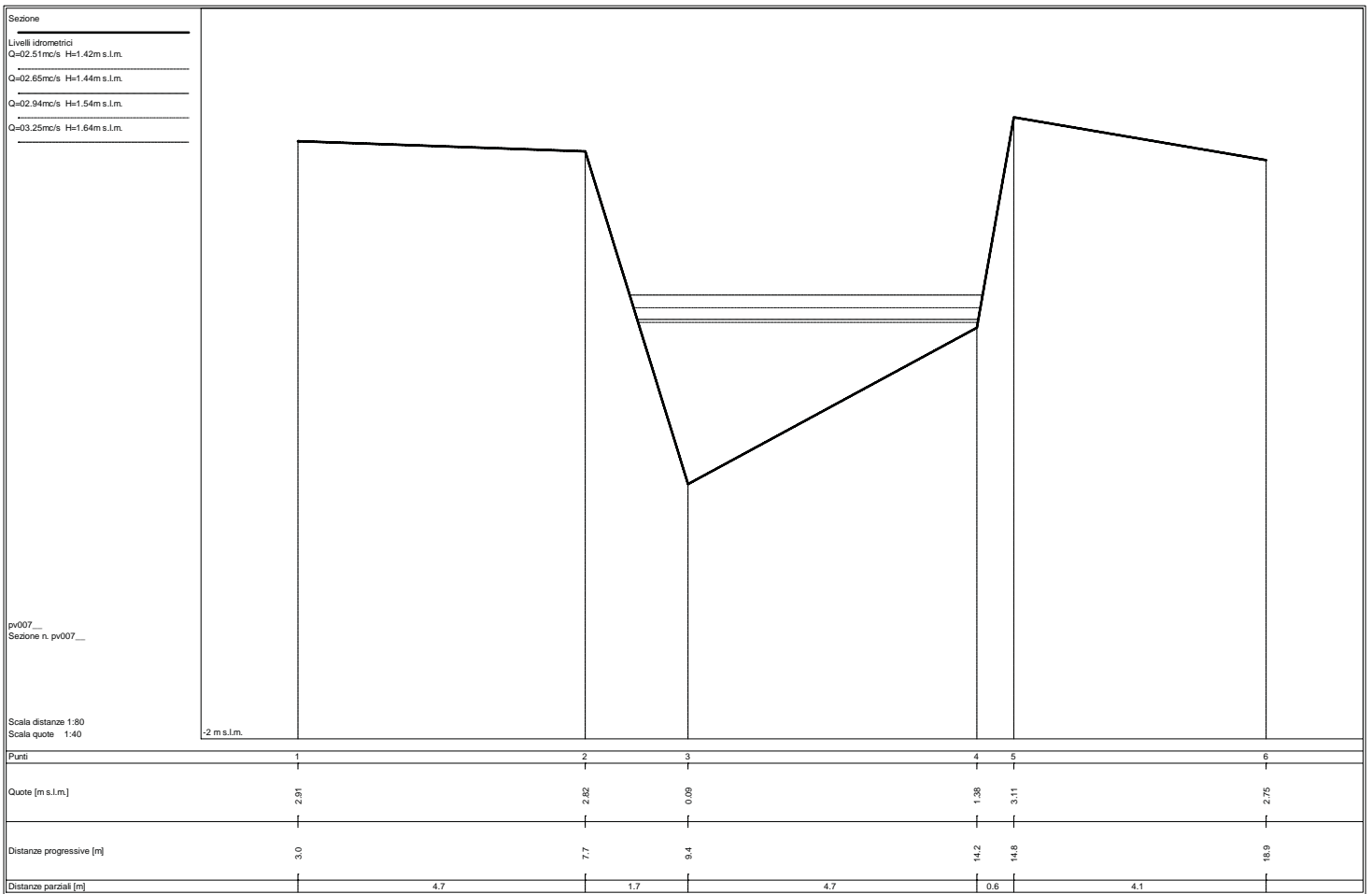

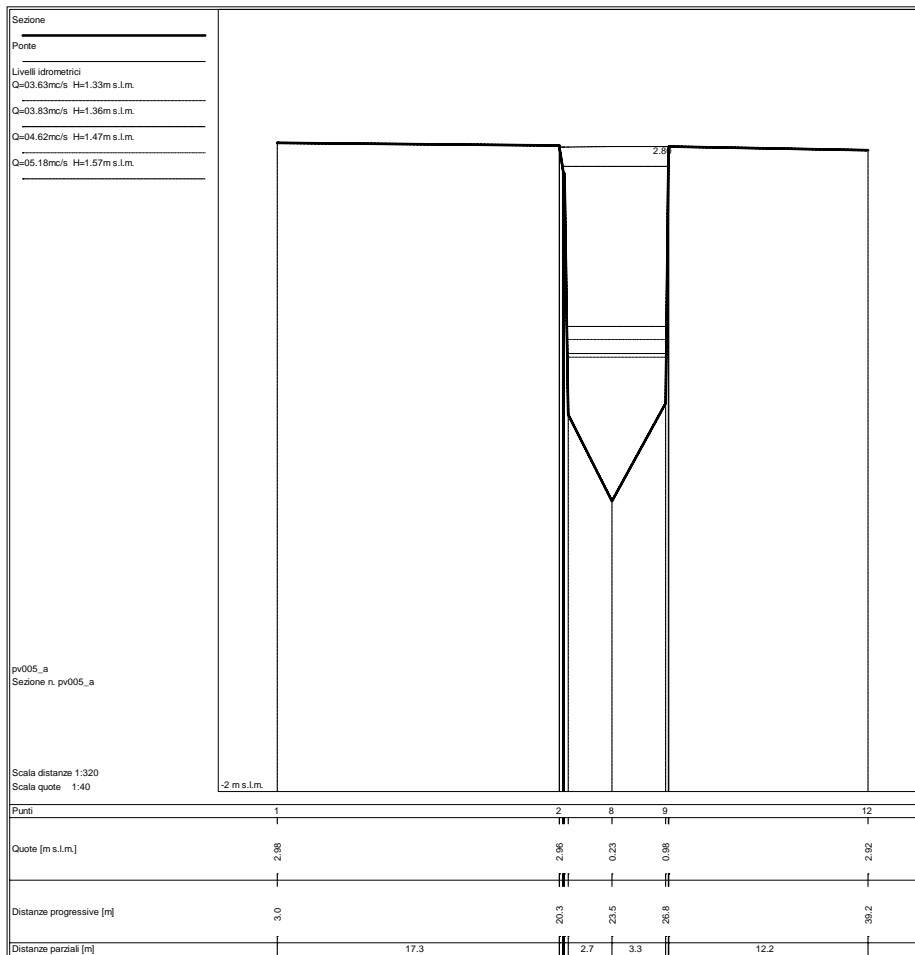
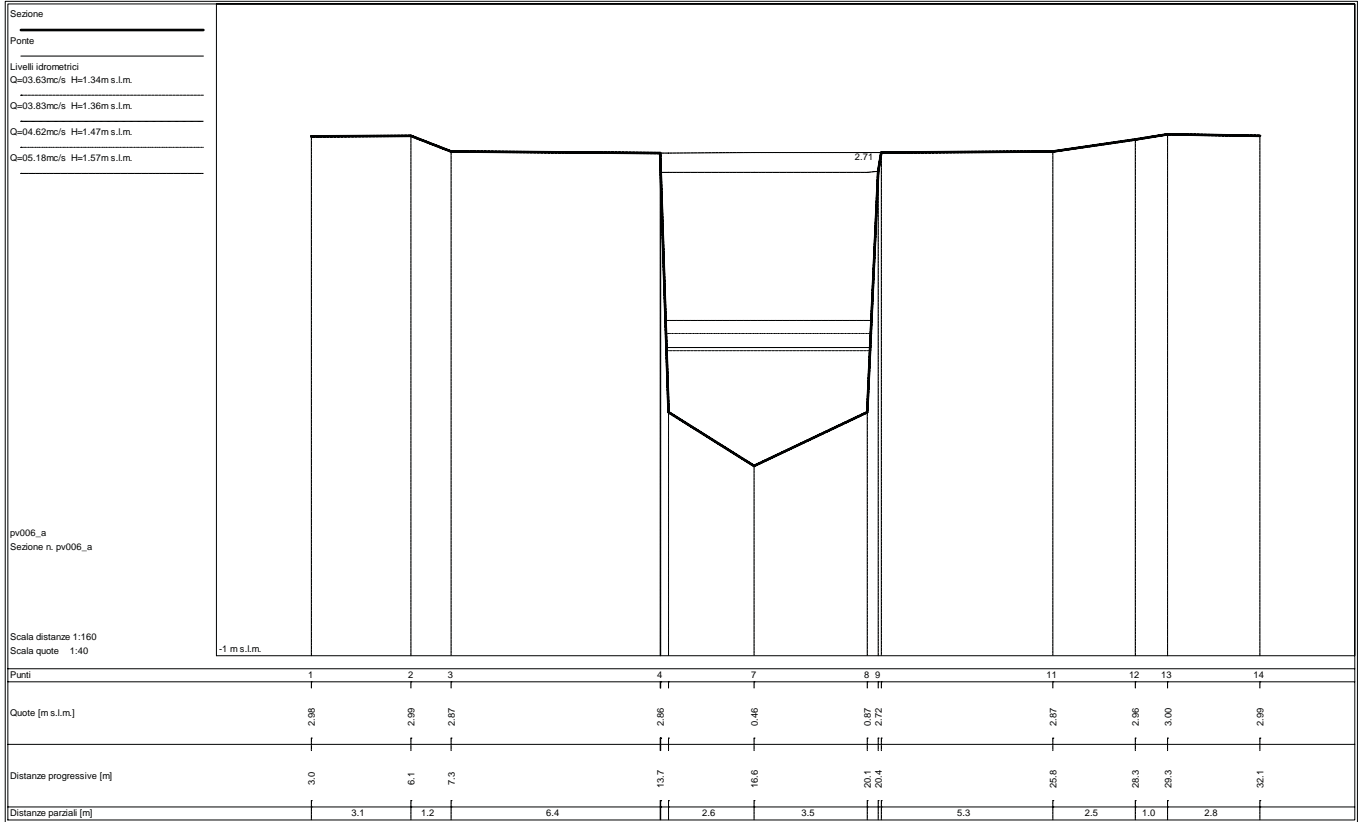

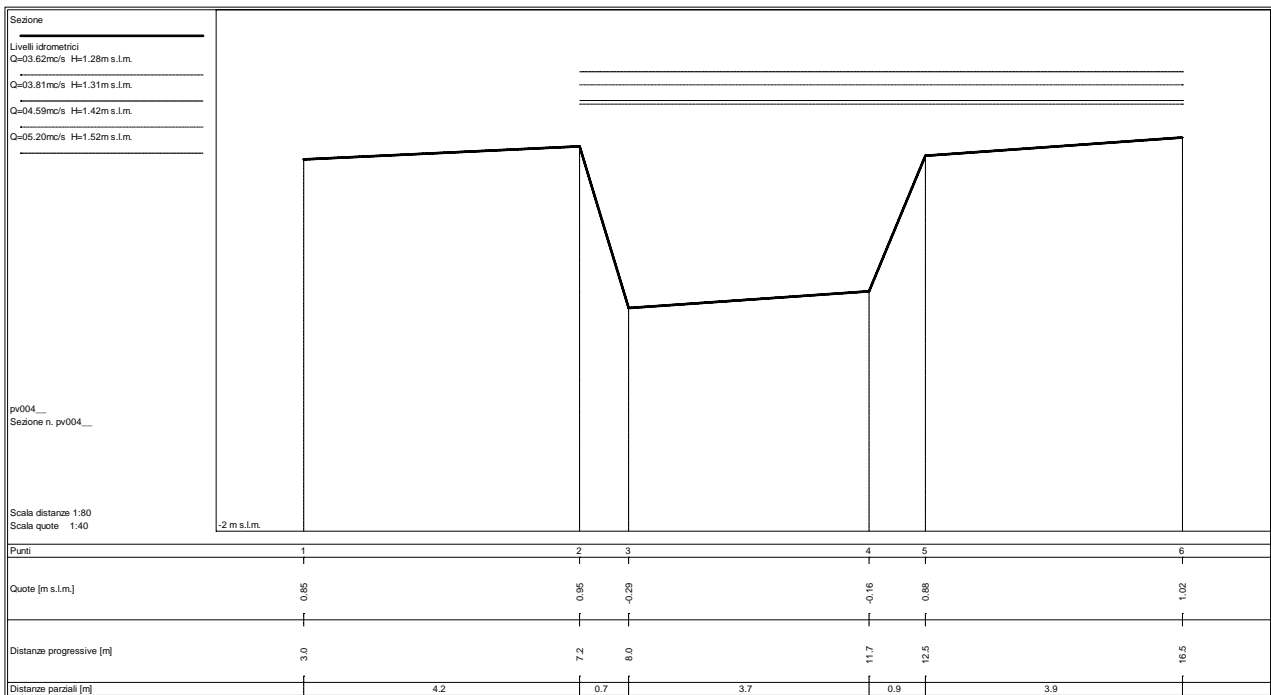
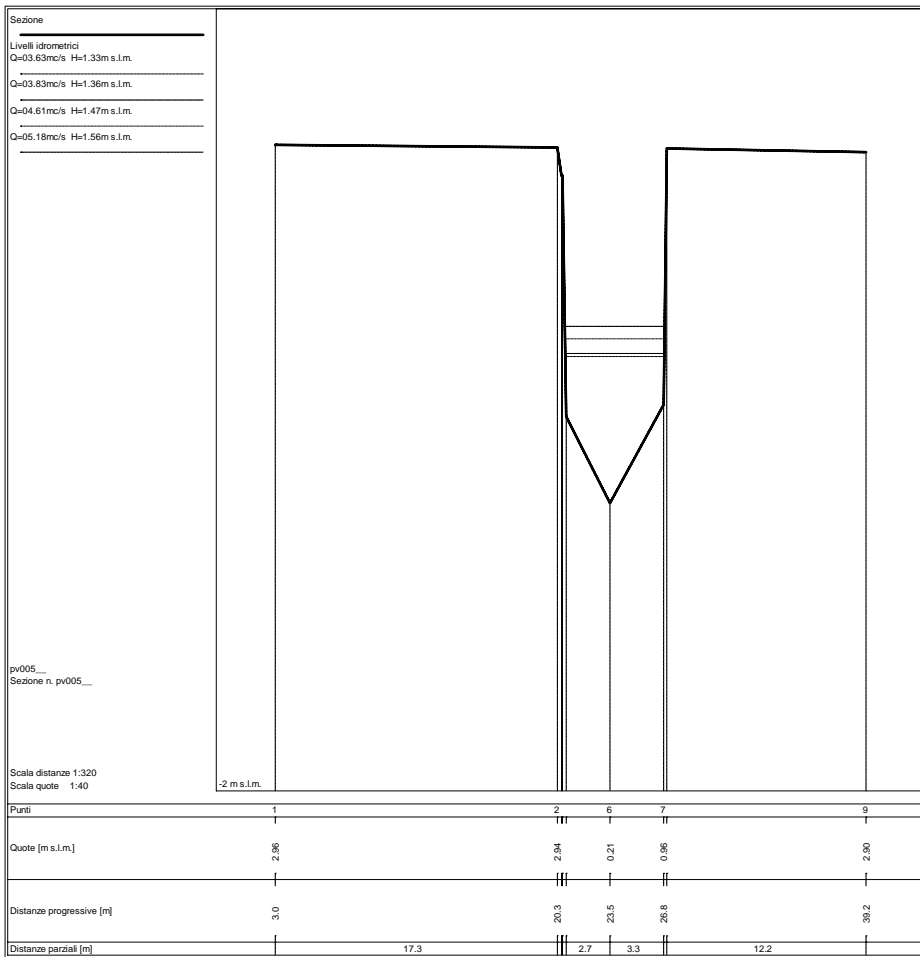

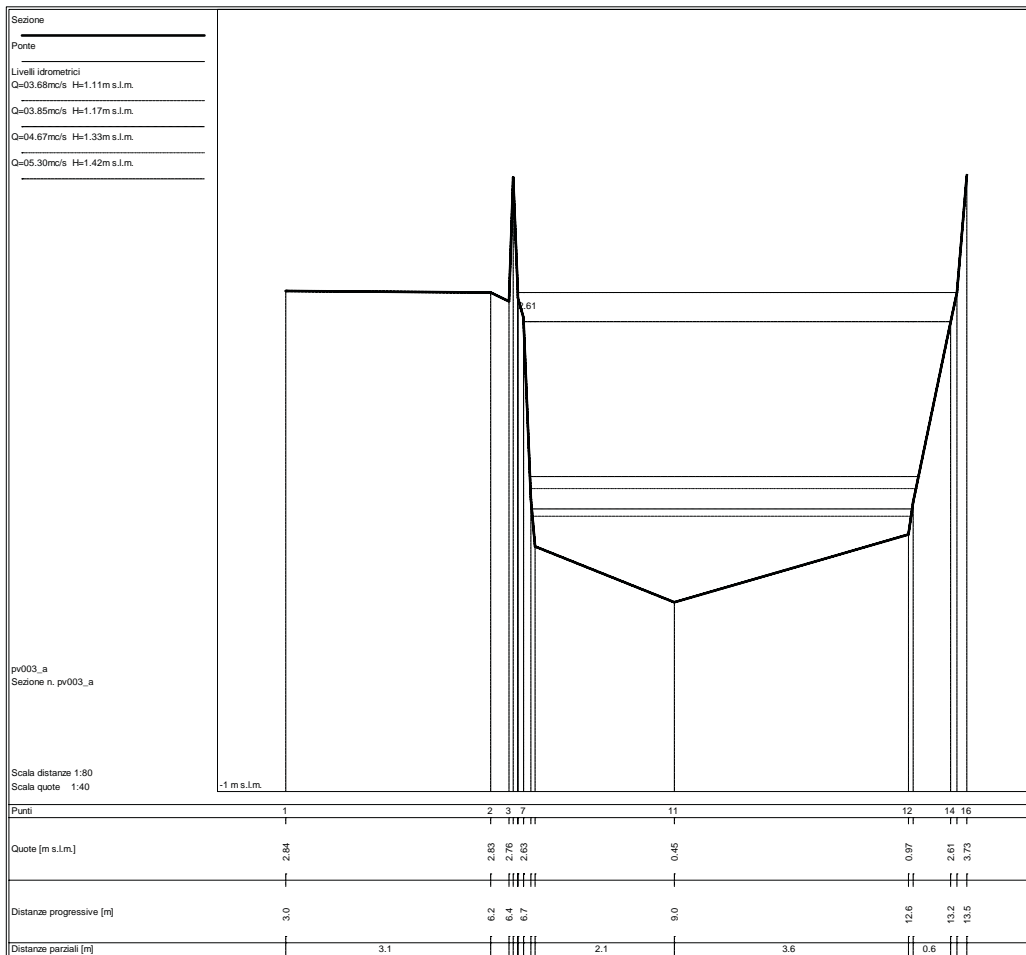
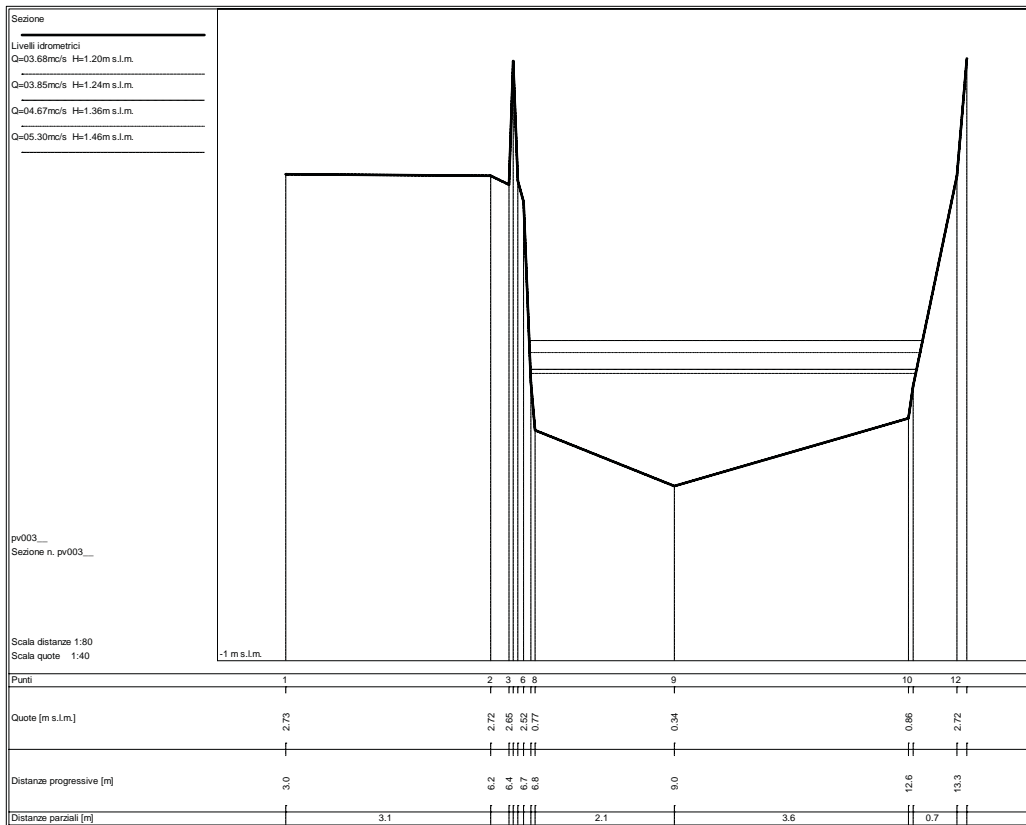

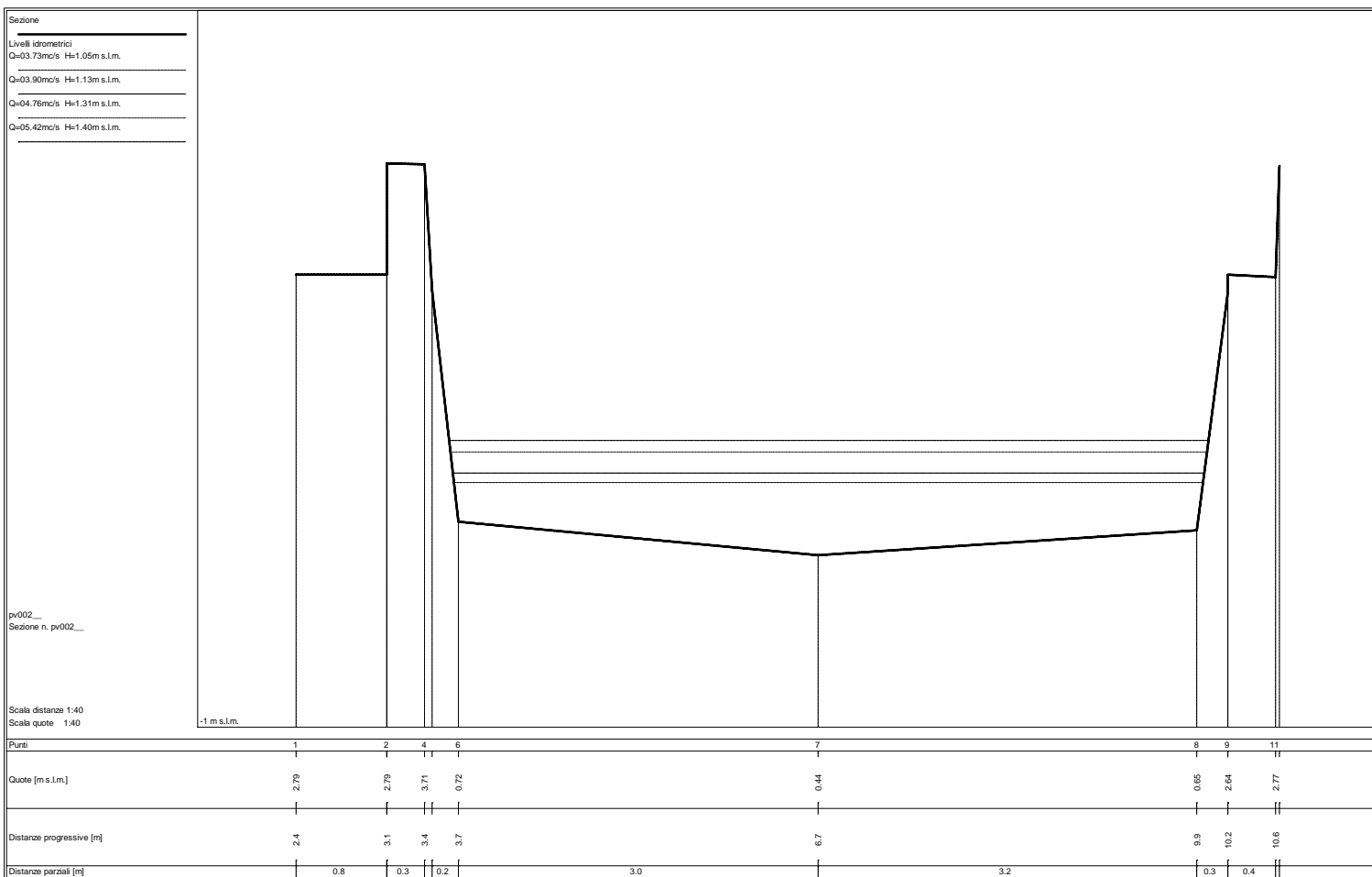
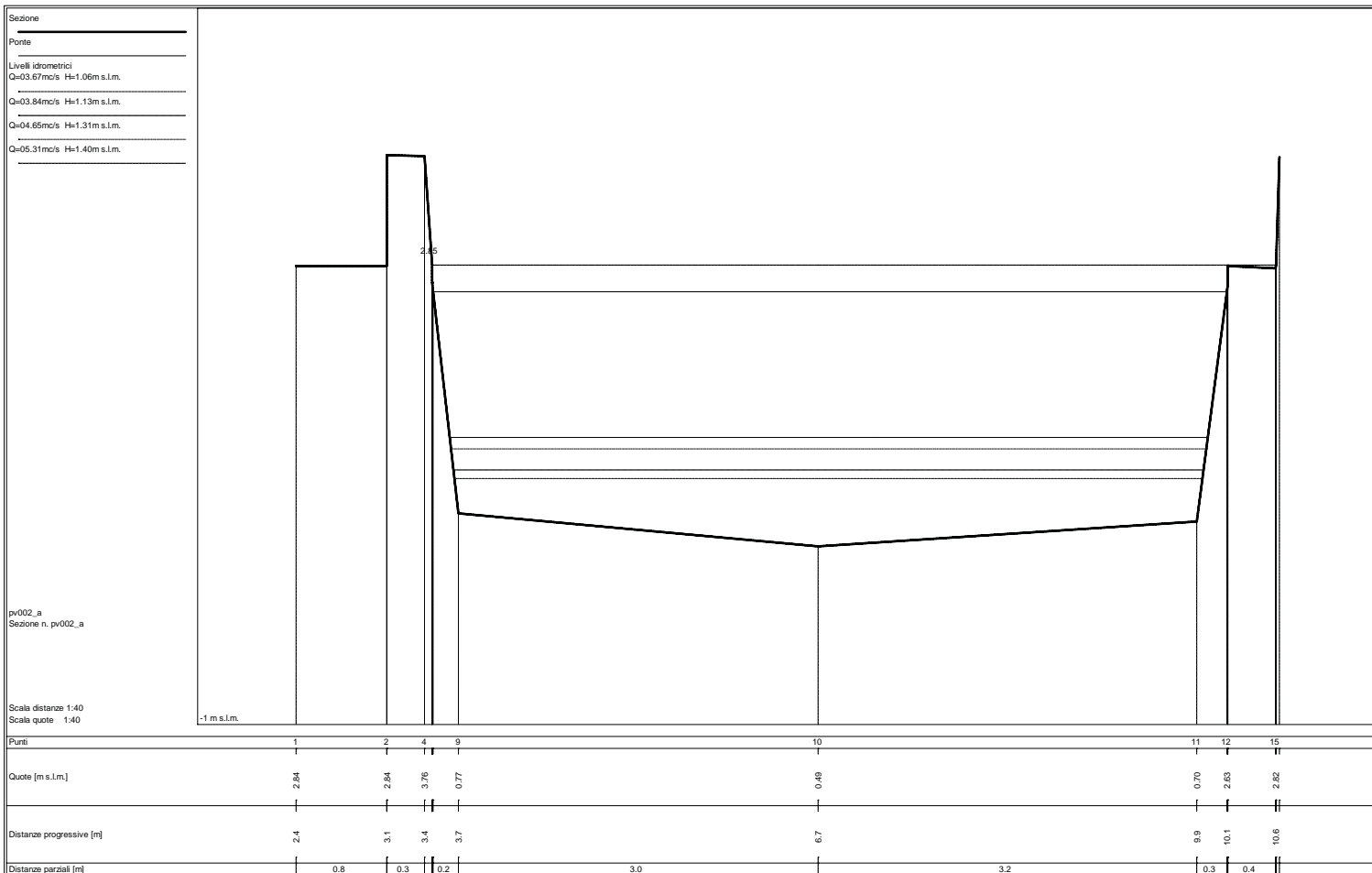

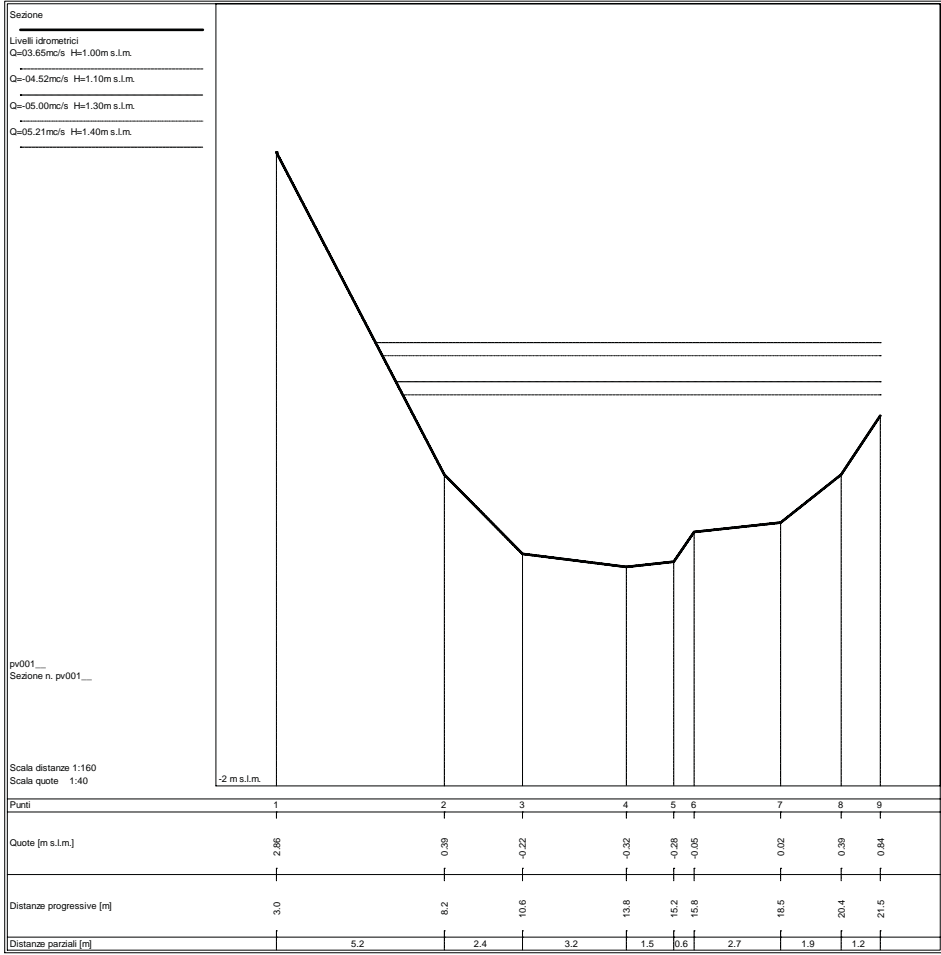

STATO ATTUALE

Sezioni fluviali torrente Canalmagro – Canalmagro_01

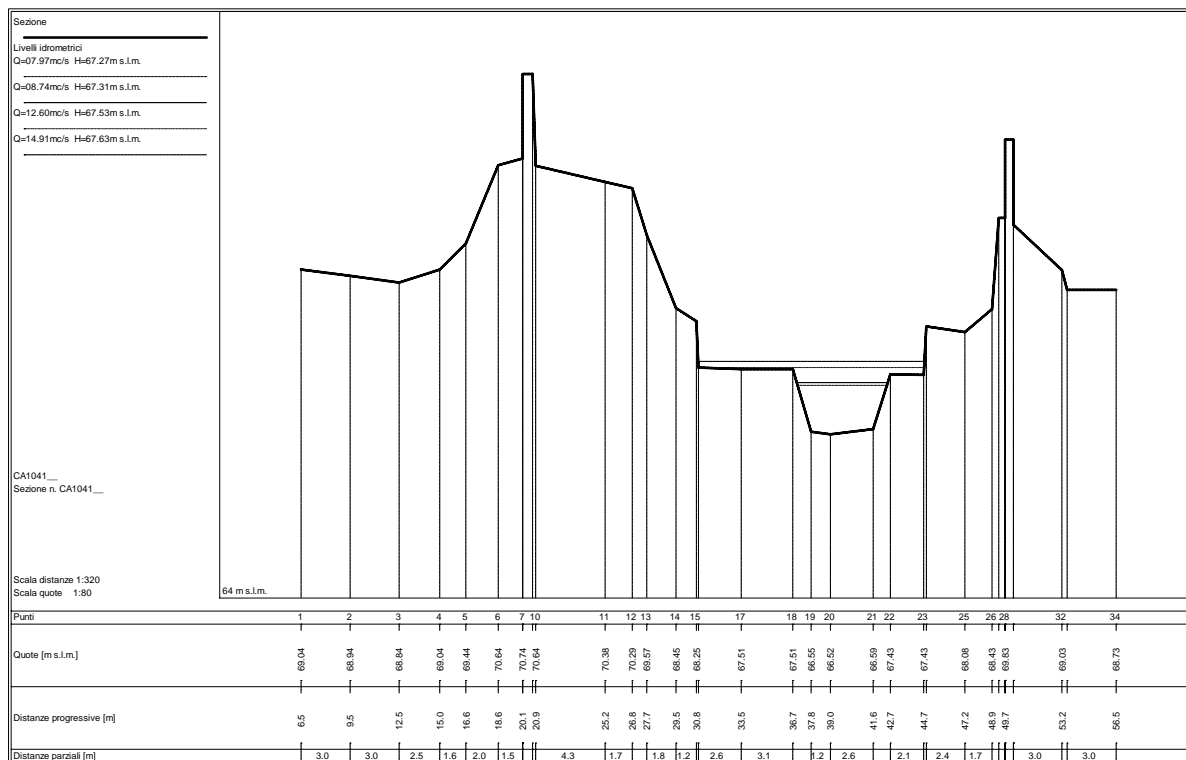
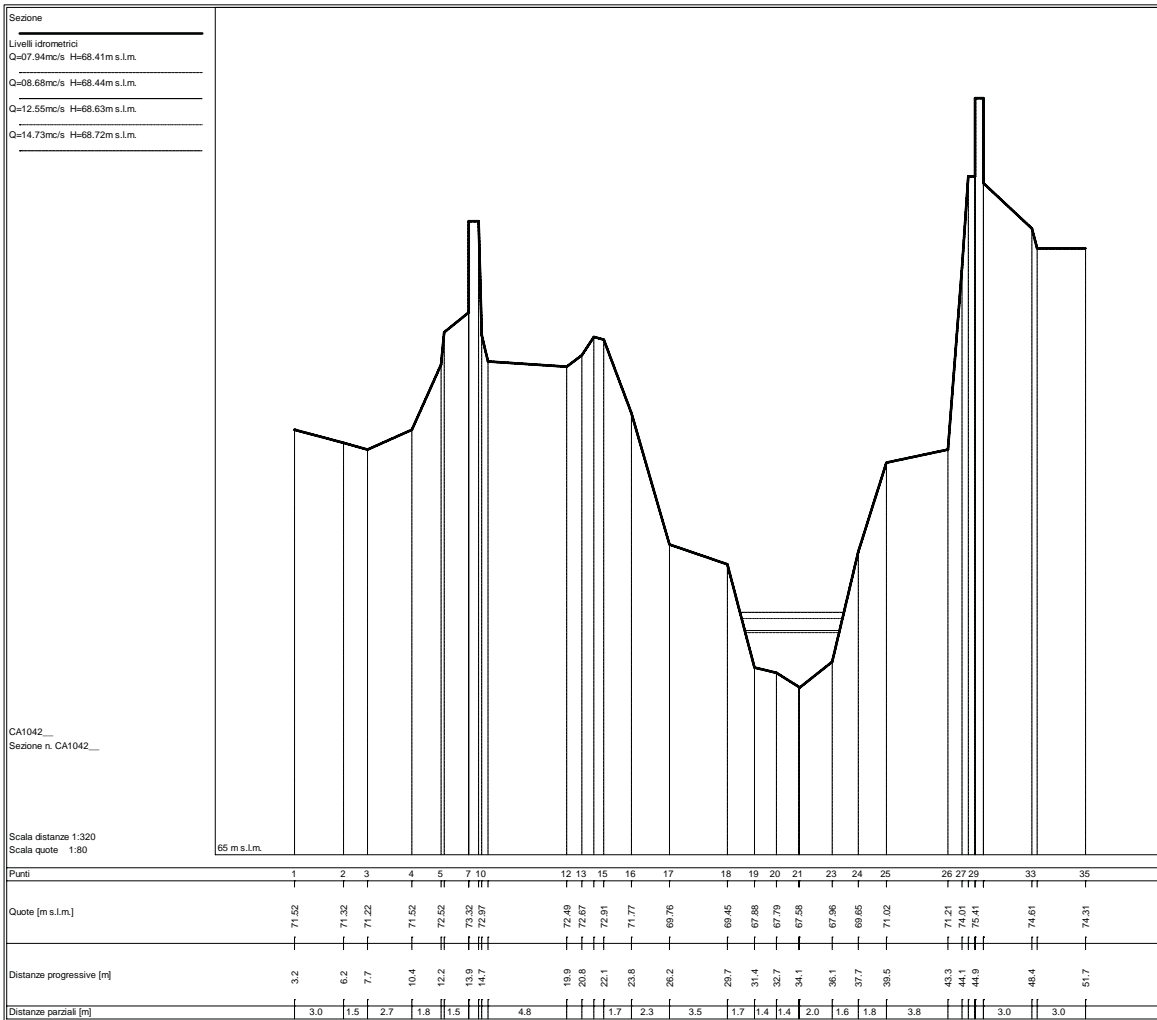

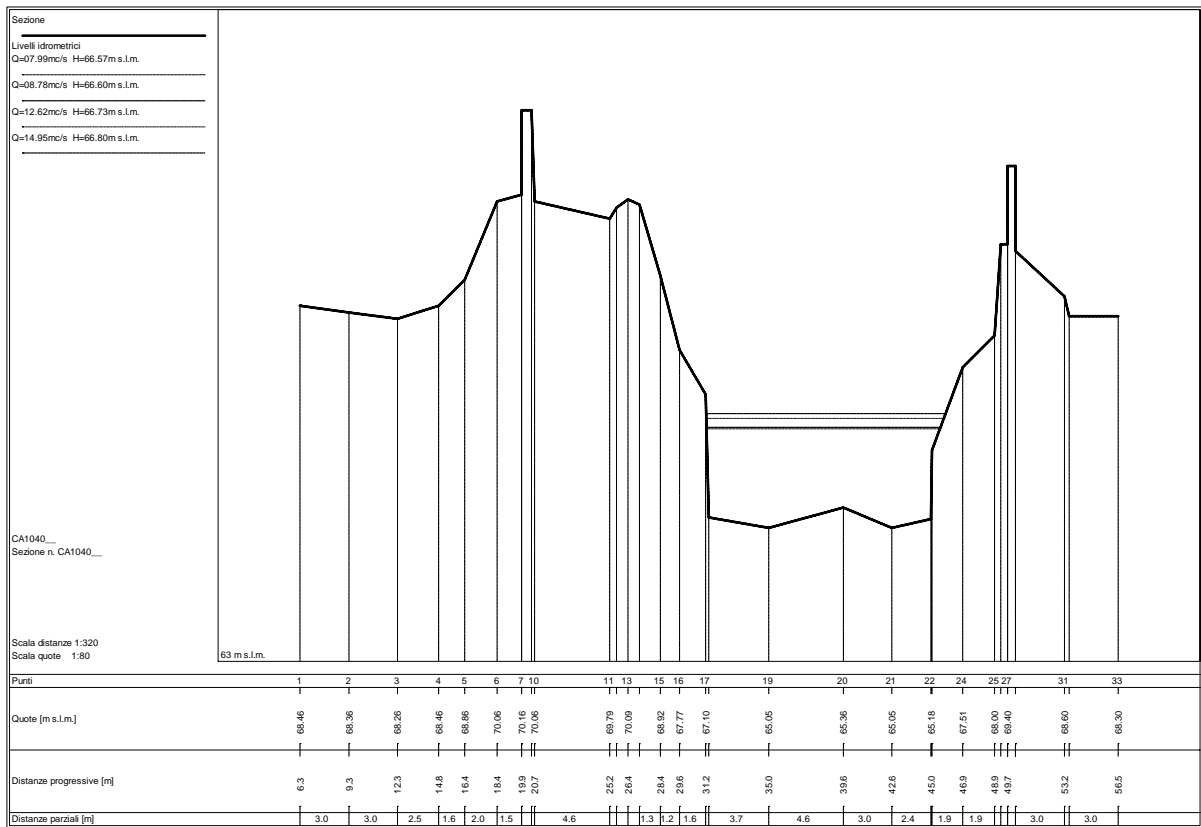
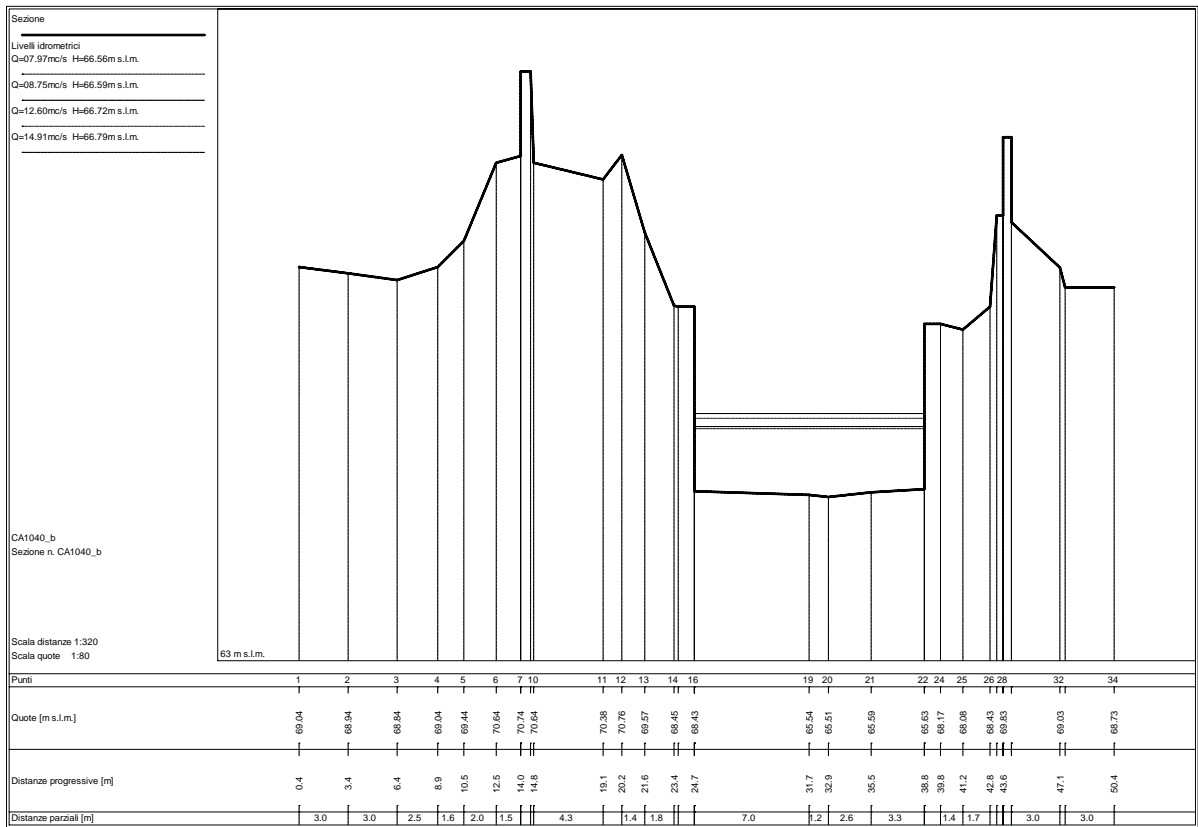

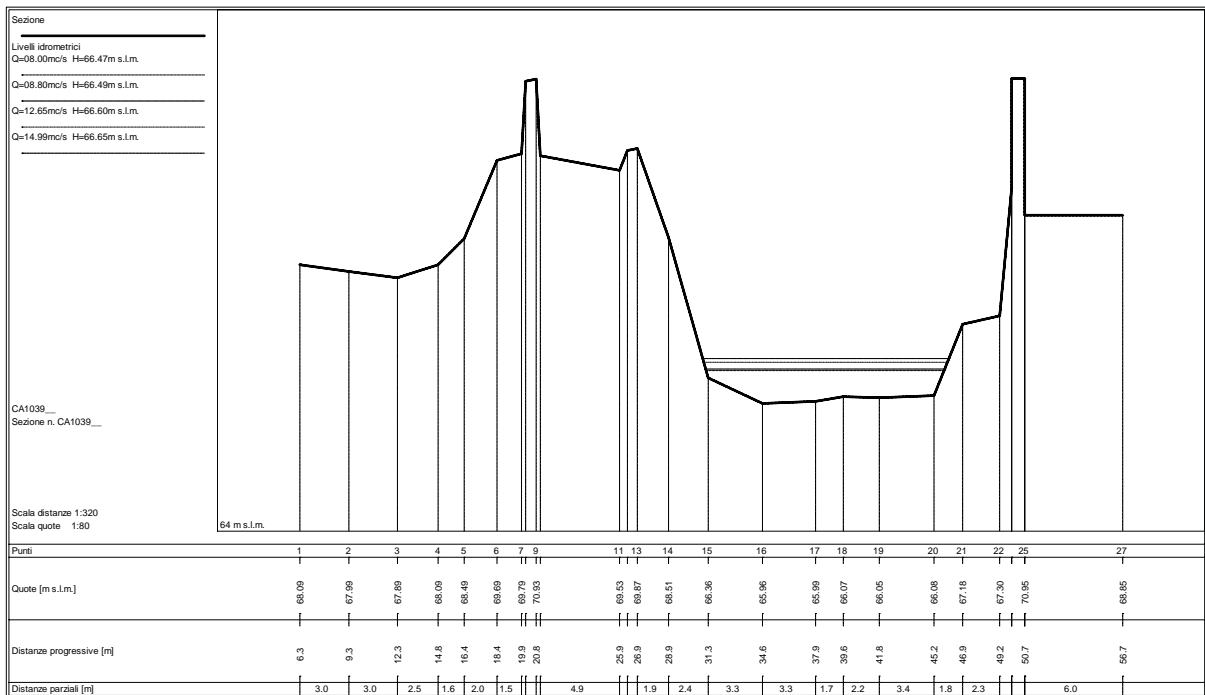
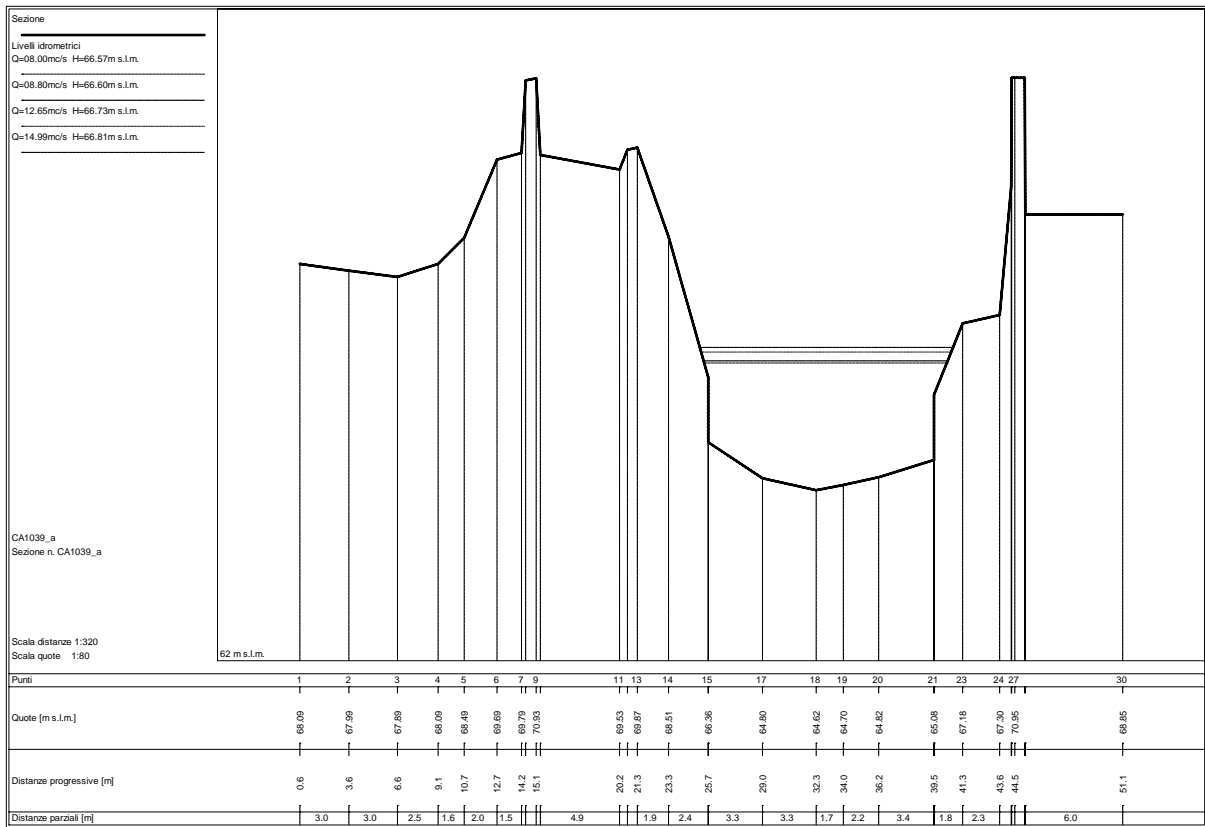

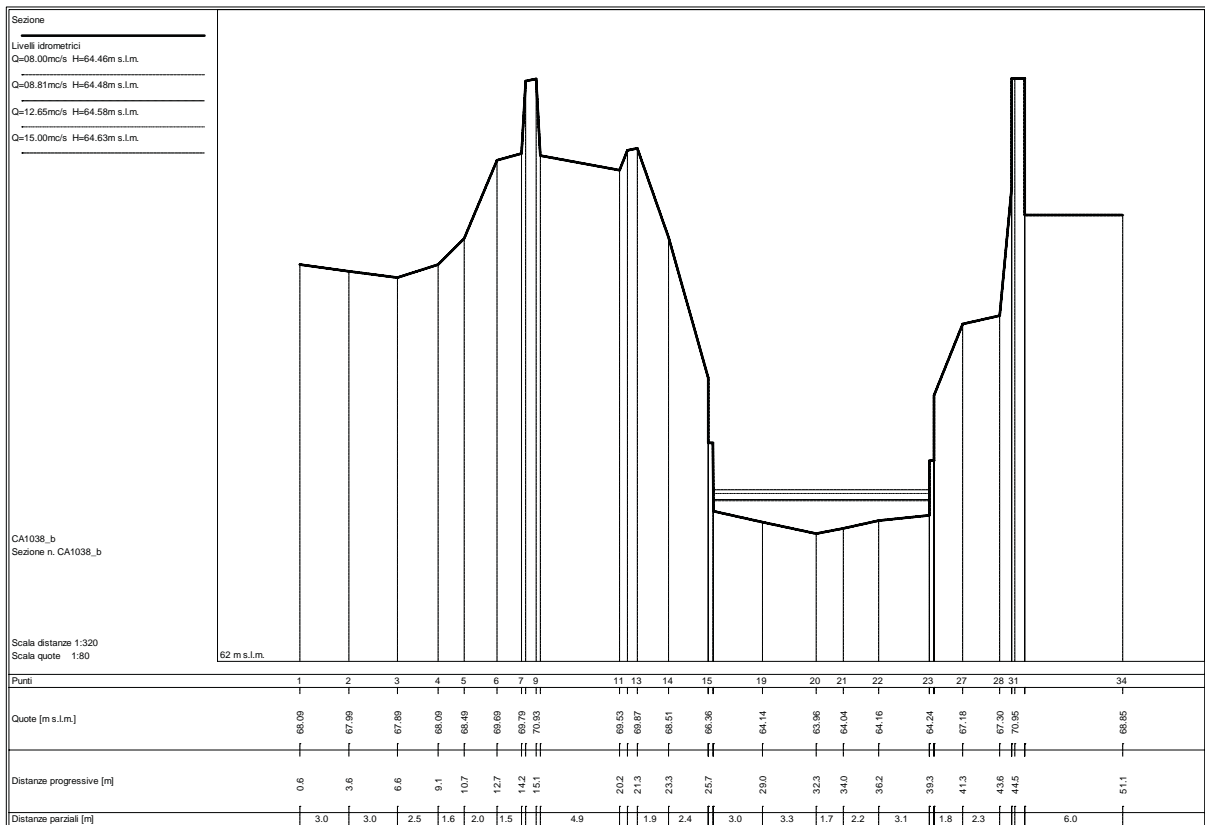
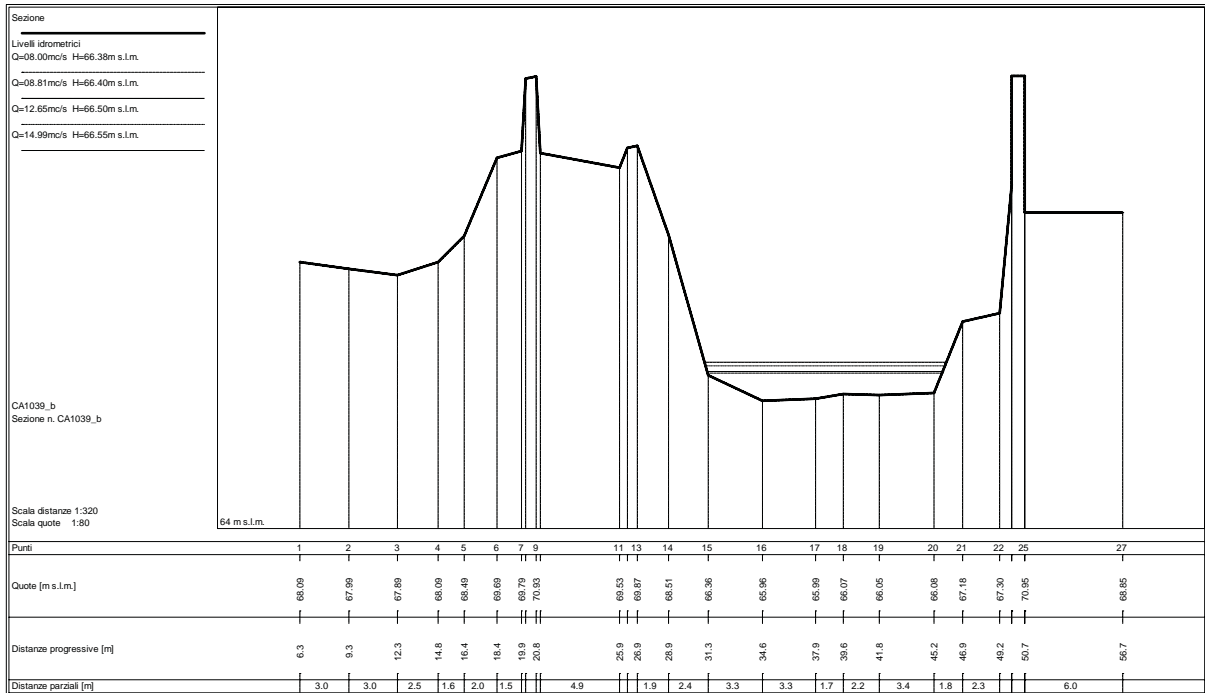

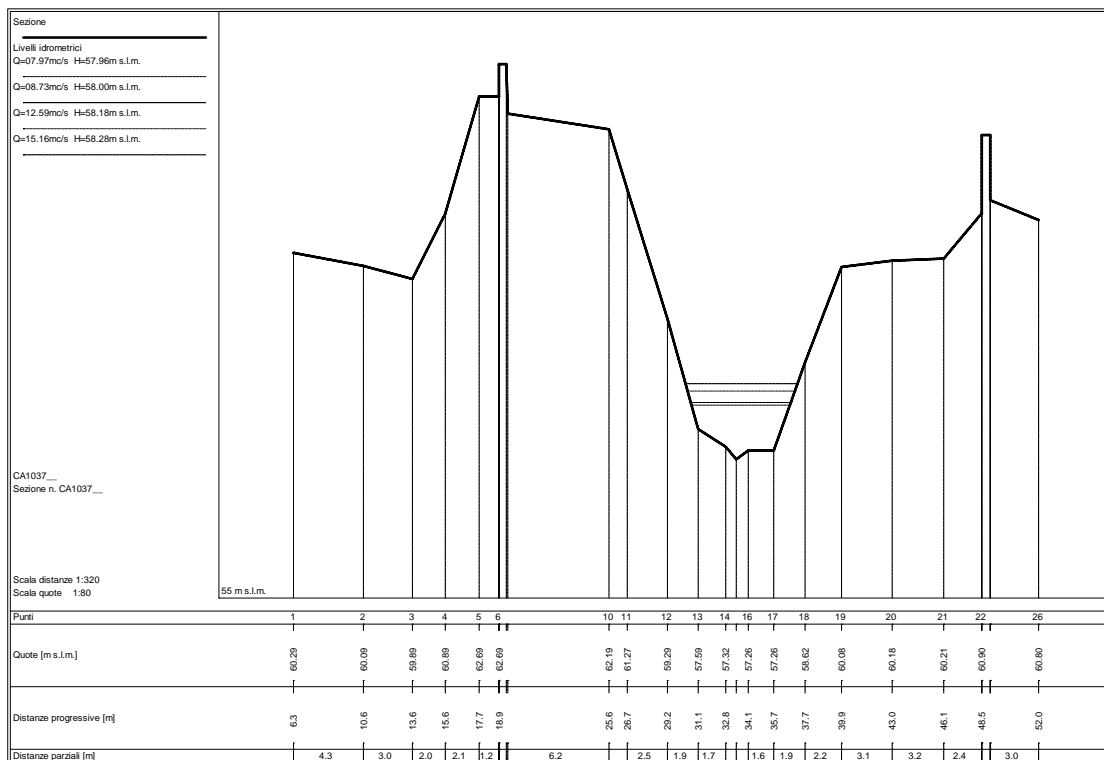
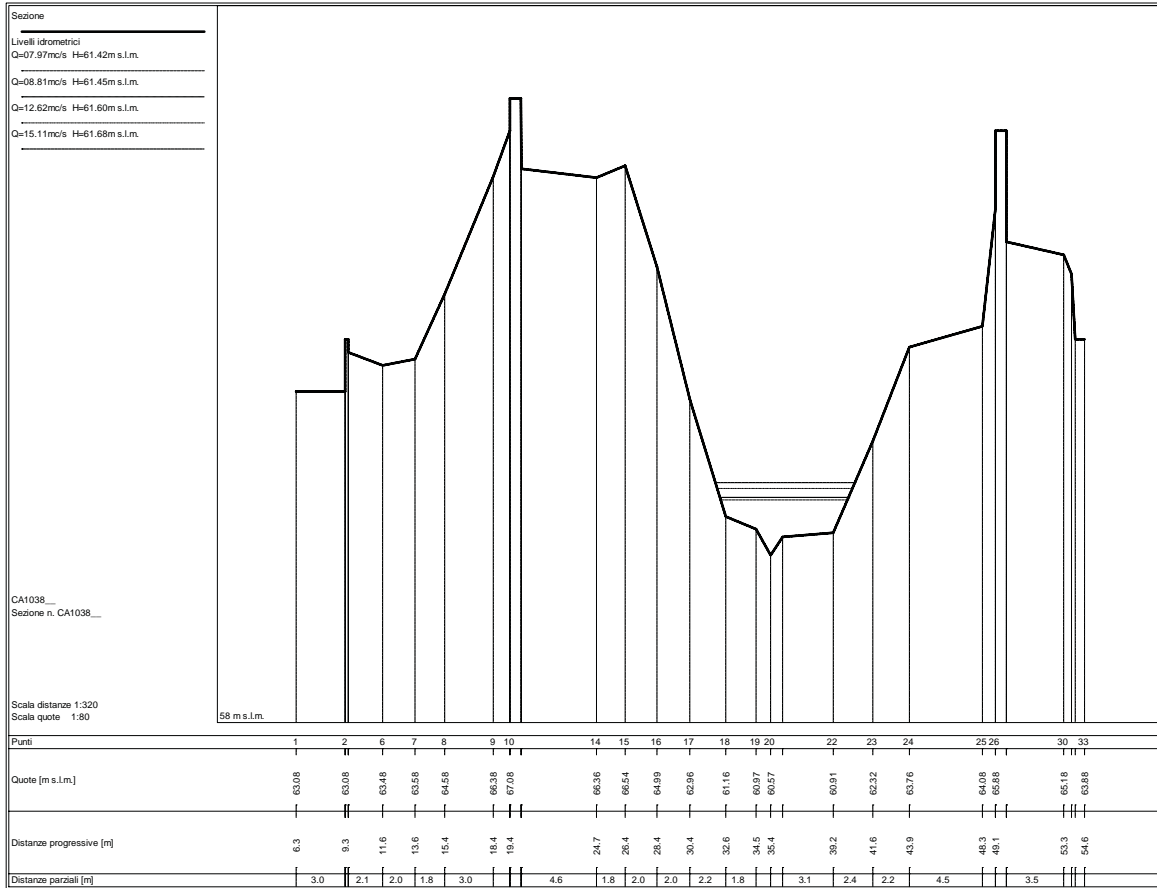

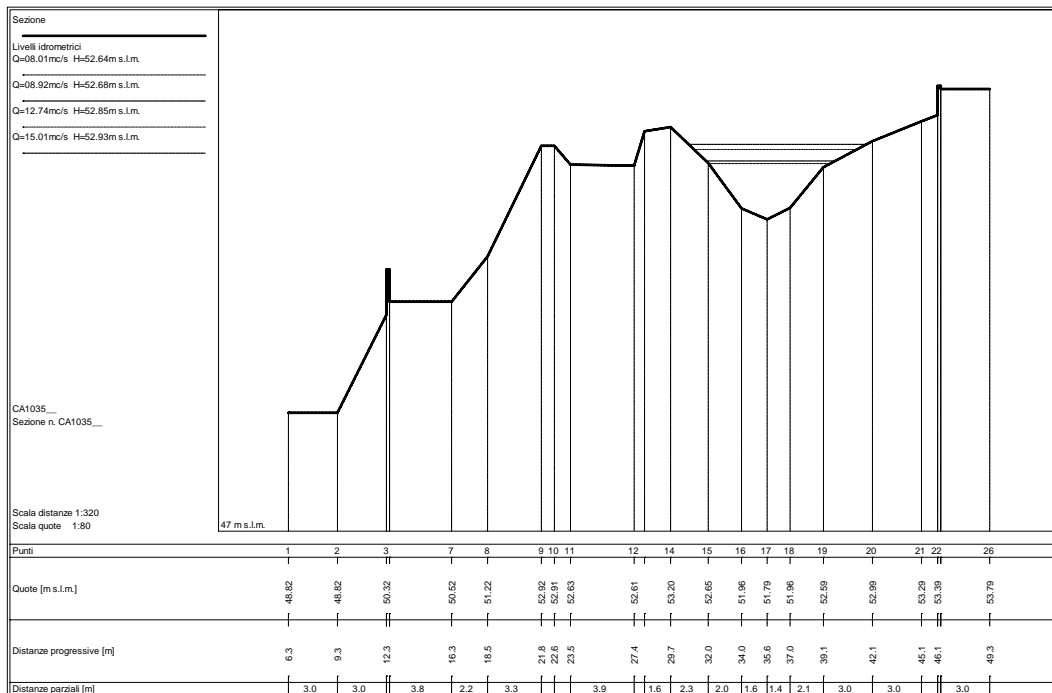
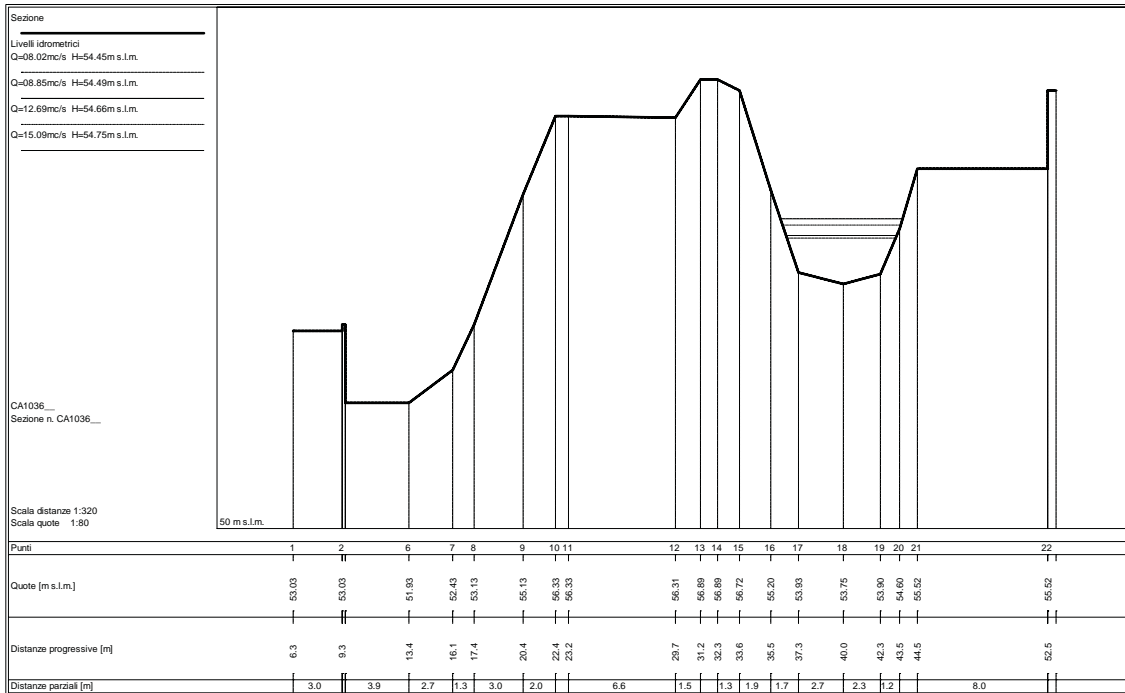

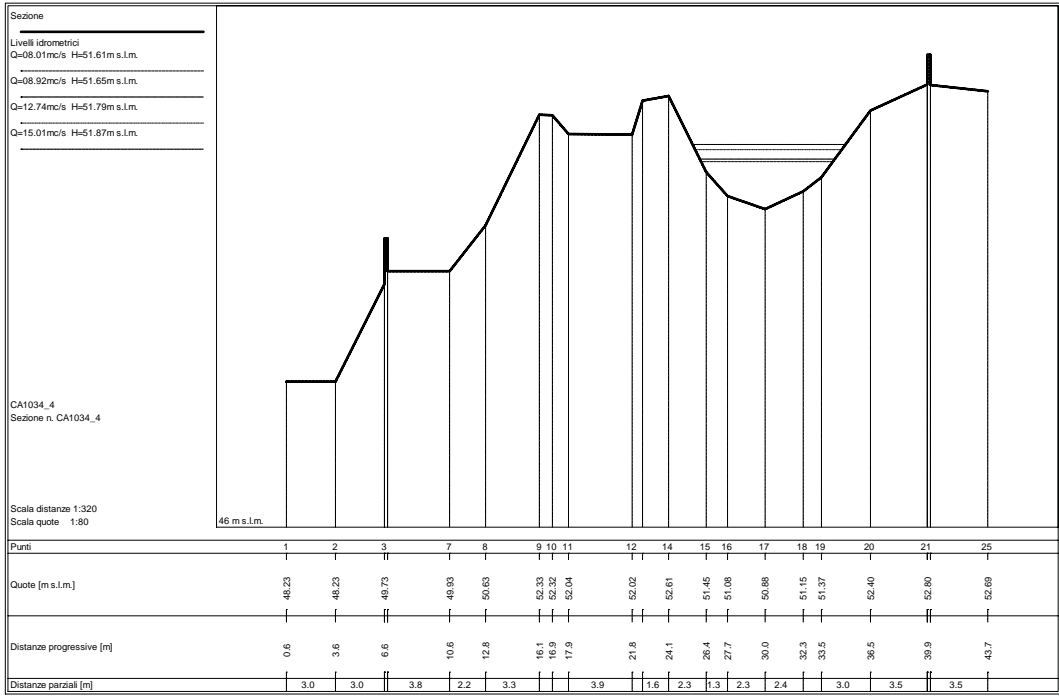
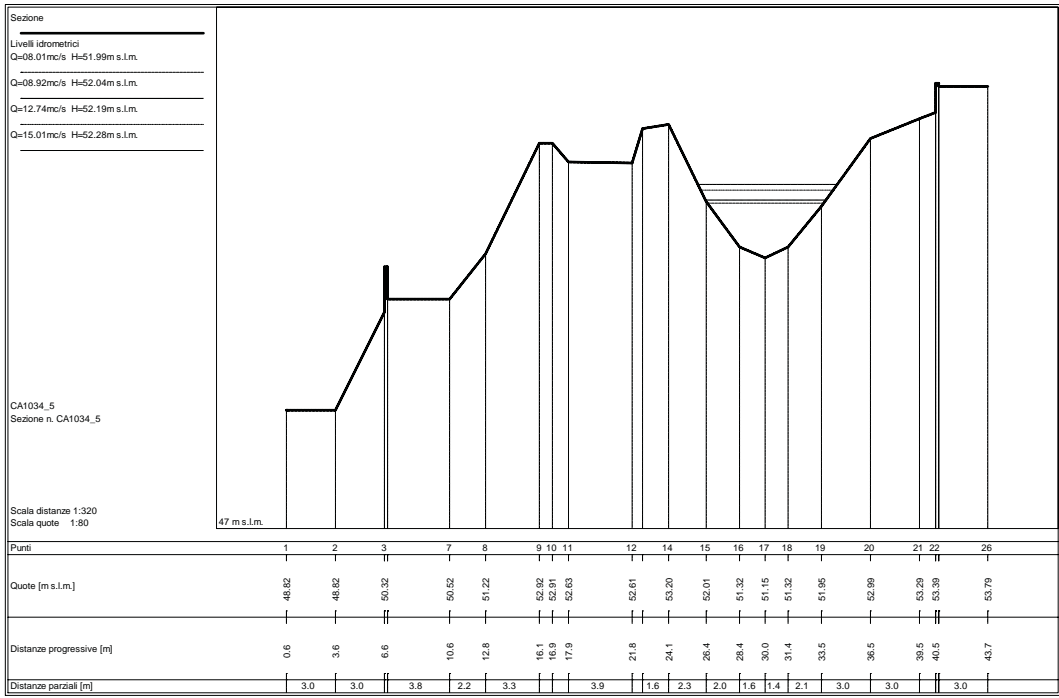

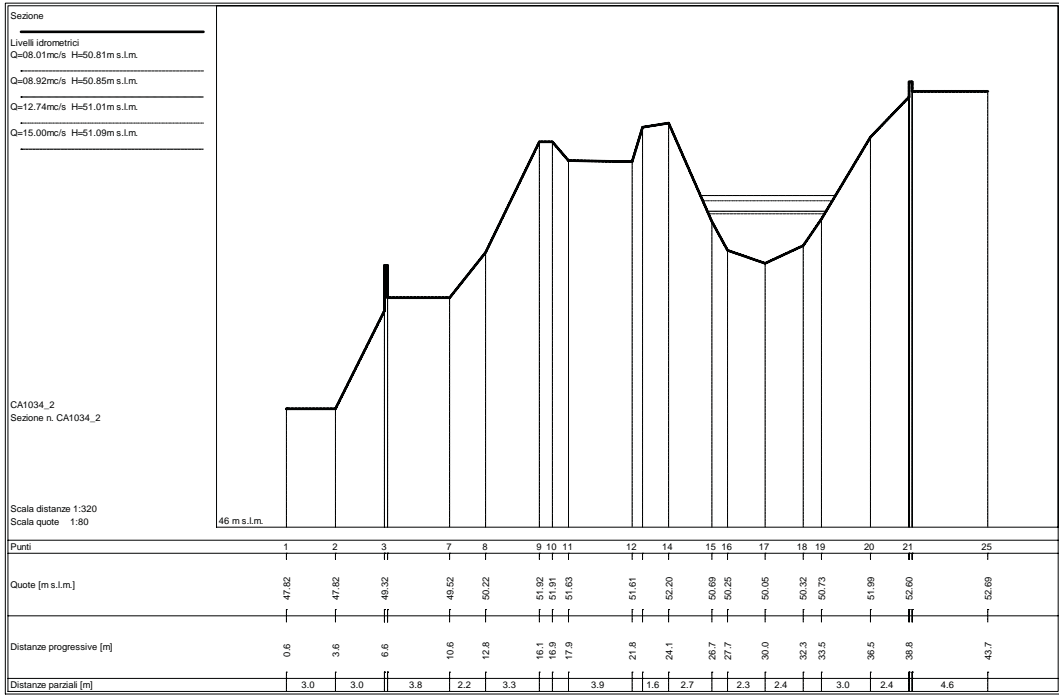
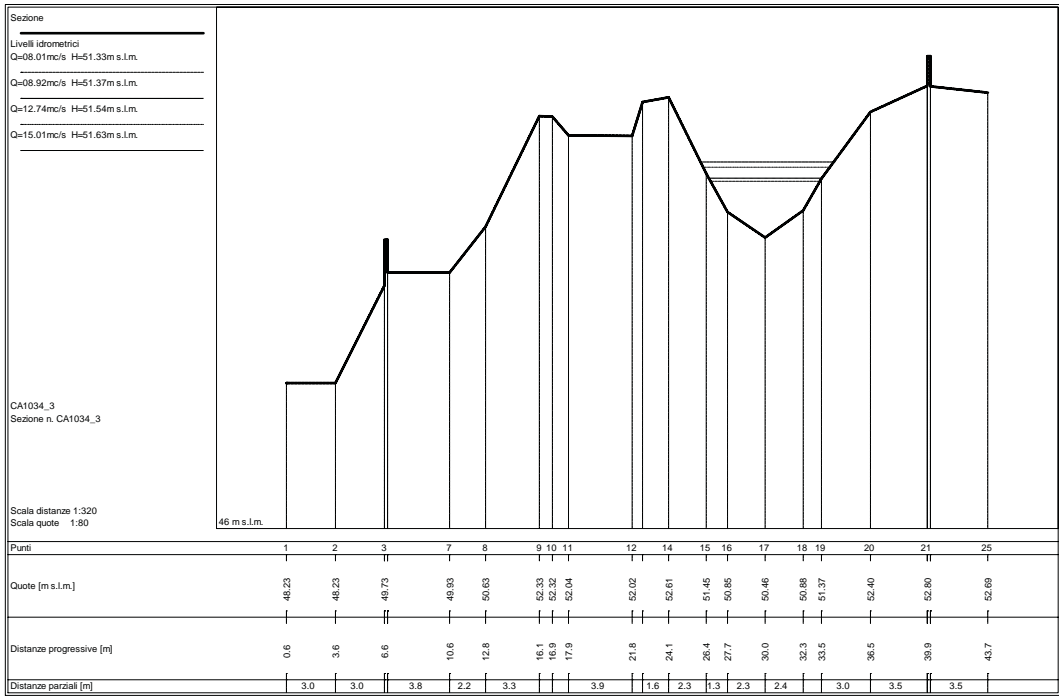

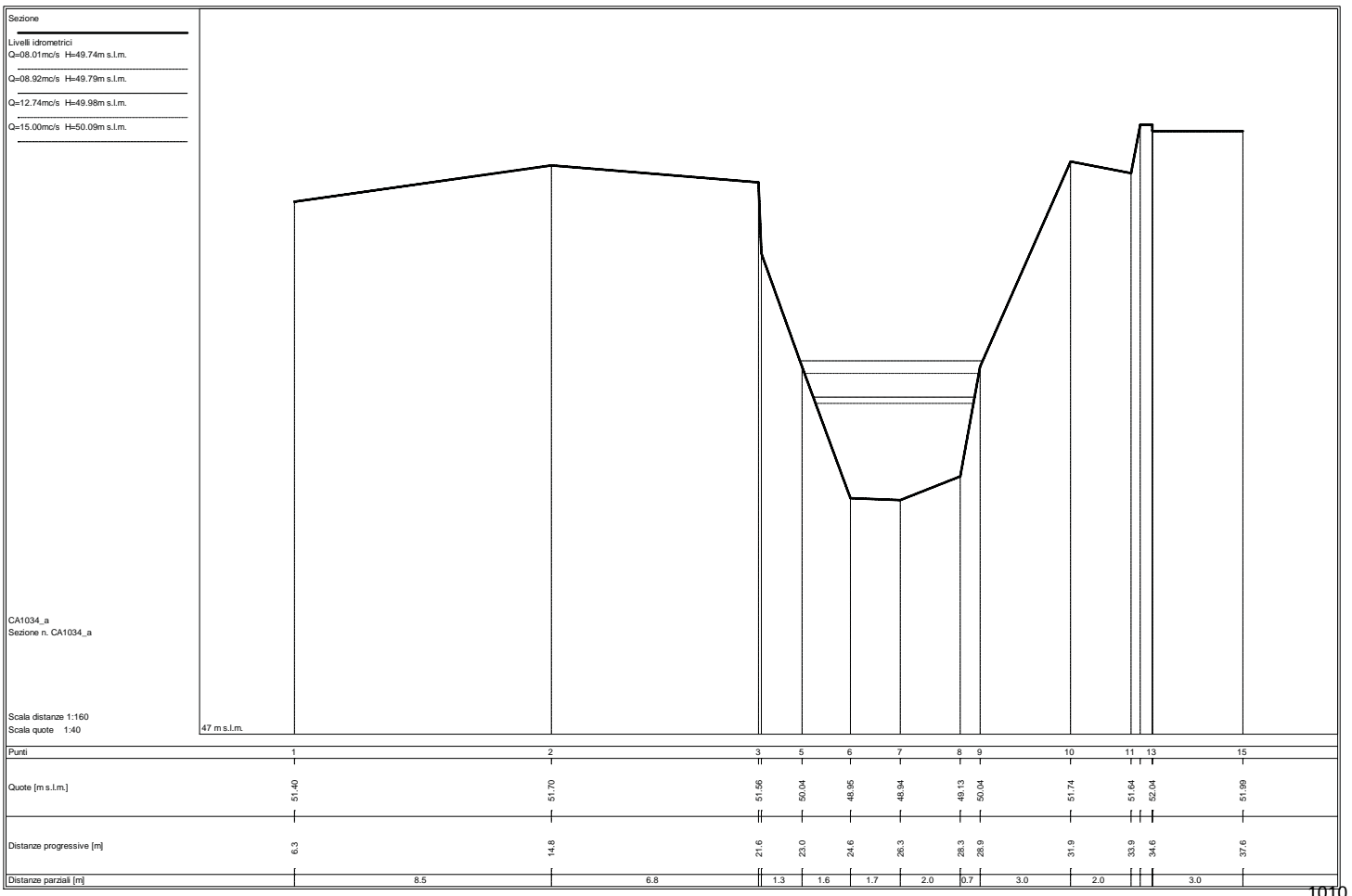
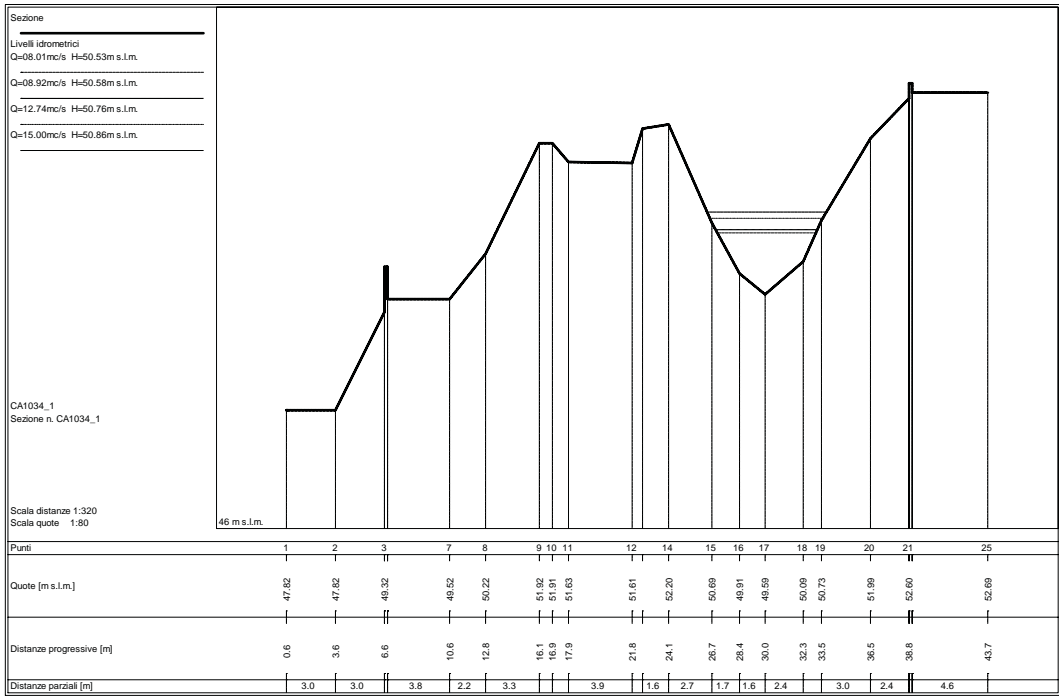

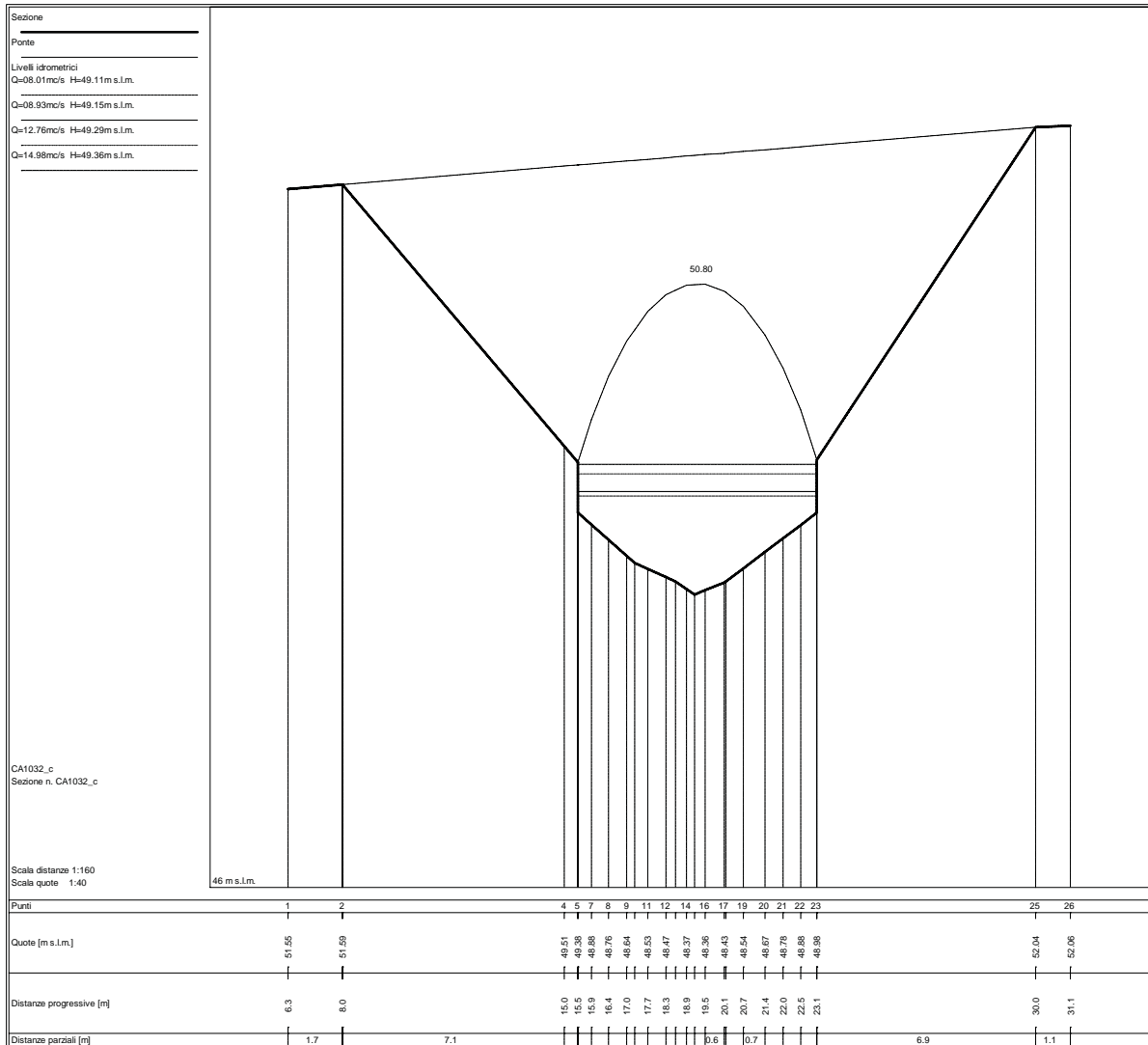
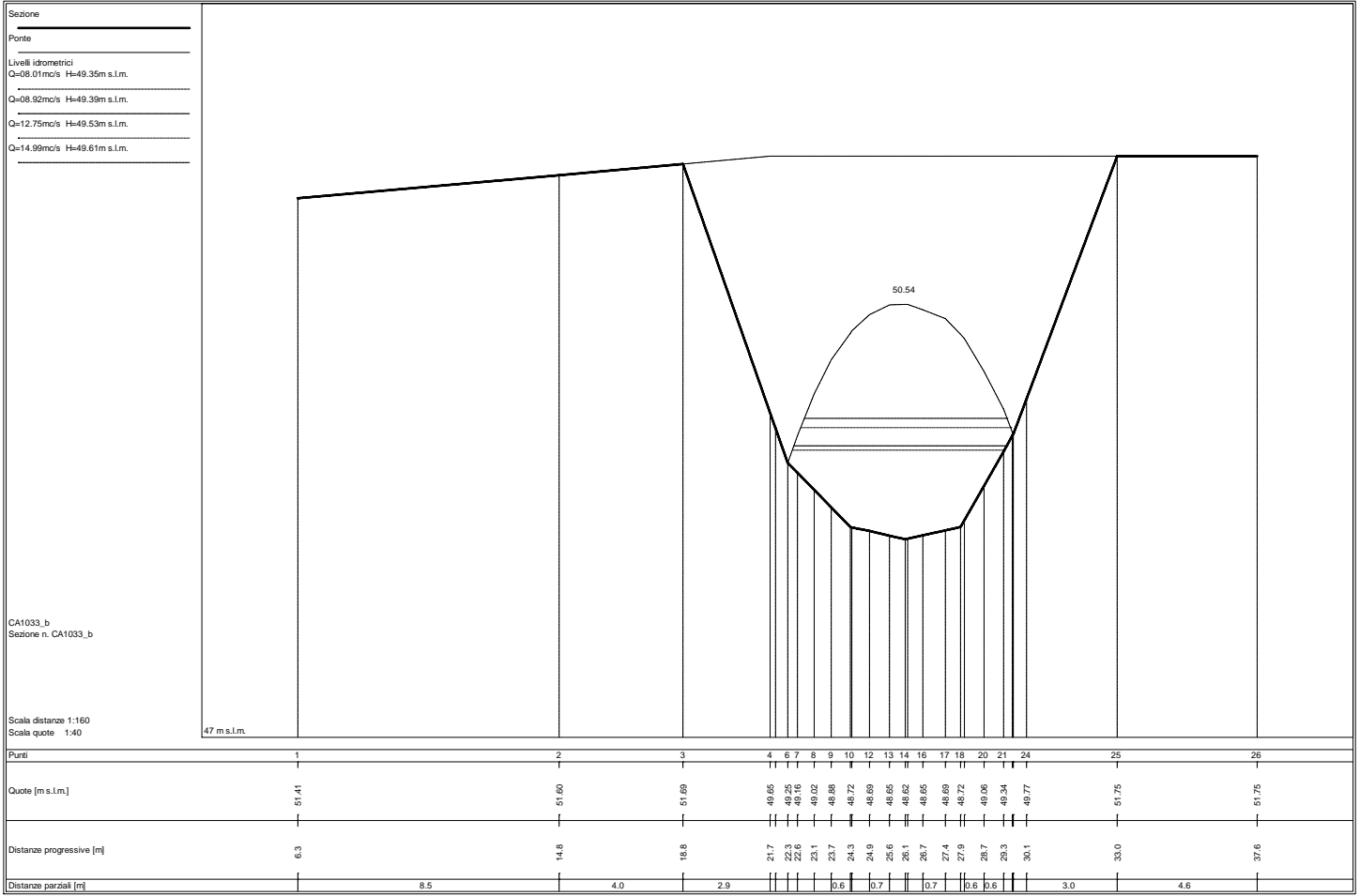

Sezione
 Livelli idrometrici
 Q=08.01mc/s H=48.93m s.l.m.
 Q=08.93mc/s H=48.97m s.l.m.
 Q=12.76mc/s H=49.11m s.l.m.
 Q=14.98mc/s H=49.18m s.l.m.

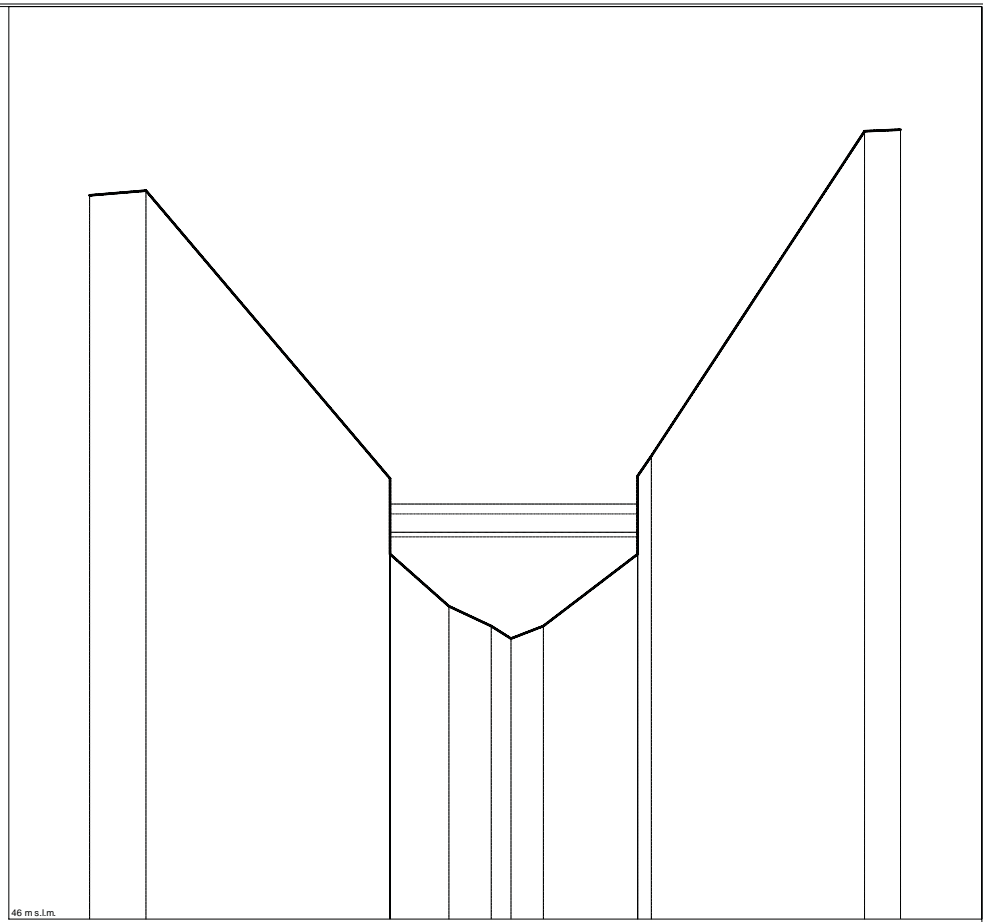

CA1031_d
 Sezione n. CA1031_d

Scala distanze 1:160
 Scala quote 1:40

46 m s.l.m.

Punti	1	2	3	5	6	7	8	9	11	12	13
Quote [m s.l.m.]	51.55	51.59	49.38	48.40	48.25	48.15	48.25	48.80	49.55	52.04	52.06
Distanze progressive [m]	6.3	8.0	15.5	17.3	18.6	19.2	20.2	23.1	23.5	30.0	31.1
Distanze parziali [m]	1.7		7.5	1.8	1.3	0.6	1.0	2.9		6.5	1.1

Sezione
 Livelli idrometrici
 Q=08.01mc/s H=48.79m s.l.m.
 Q=08.94mc/s H=48.82m s.l.m.
 Q=12.76mc/s H=48.96m s.l.m.
 Q=14.98mc/s H=49.03m s.l.m.

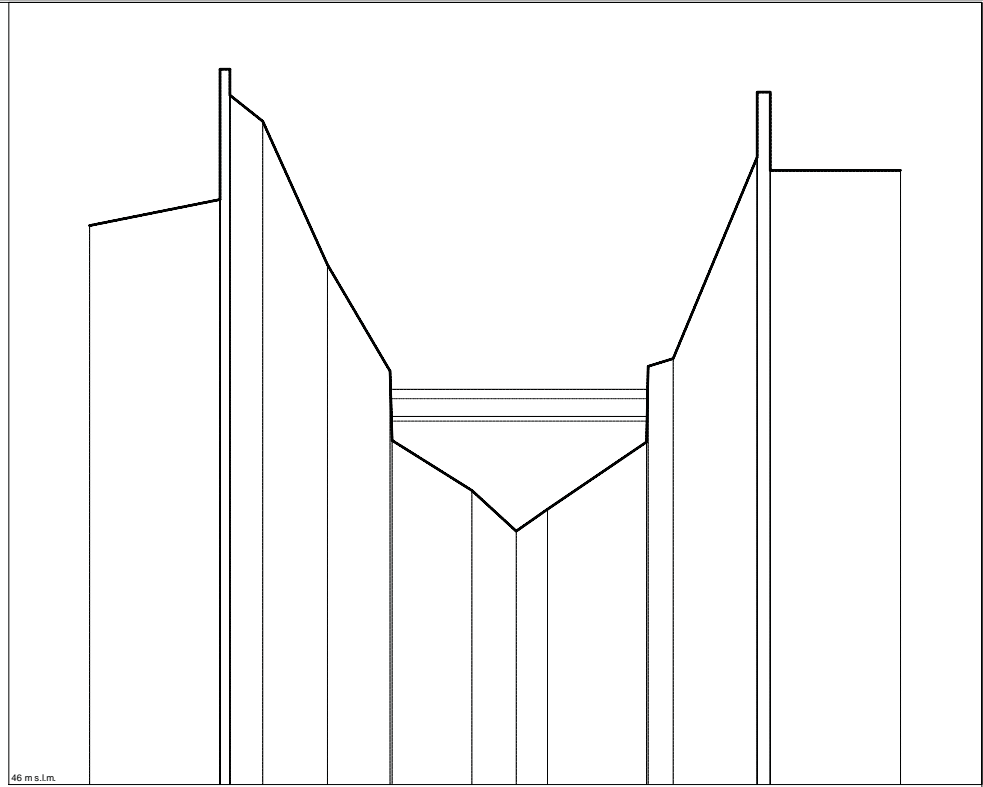

CA1030__
 Sezione n. CA1030__

Scala distanze 1:160
 Scala quote 1:40

46 m s.l.m.

Punti	1	2	6	7	8	10	11	12	13	15	16	18	20
Quote [m s.l.m.]	50.29	50.49	51.09	49.99	49.17	48.26	47.94	48.11	48.63	48.27	50.81	51.31	50.71
Distanze progressive [m]	6.3	10.3	11.6	13.5	15.5	18.0	19.3	20.3	23.3	24.1	26.7	27.1	31.1
Distanze parziali [m]		4.0	1.0	2.0	1.9	2.4	1.4	1.0	3.0	0.8	2.6		4.0

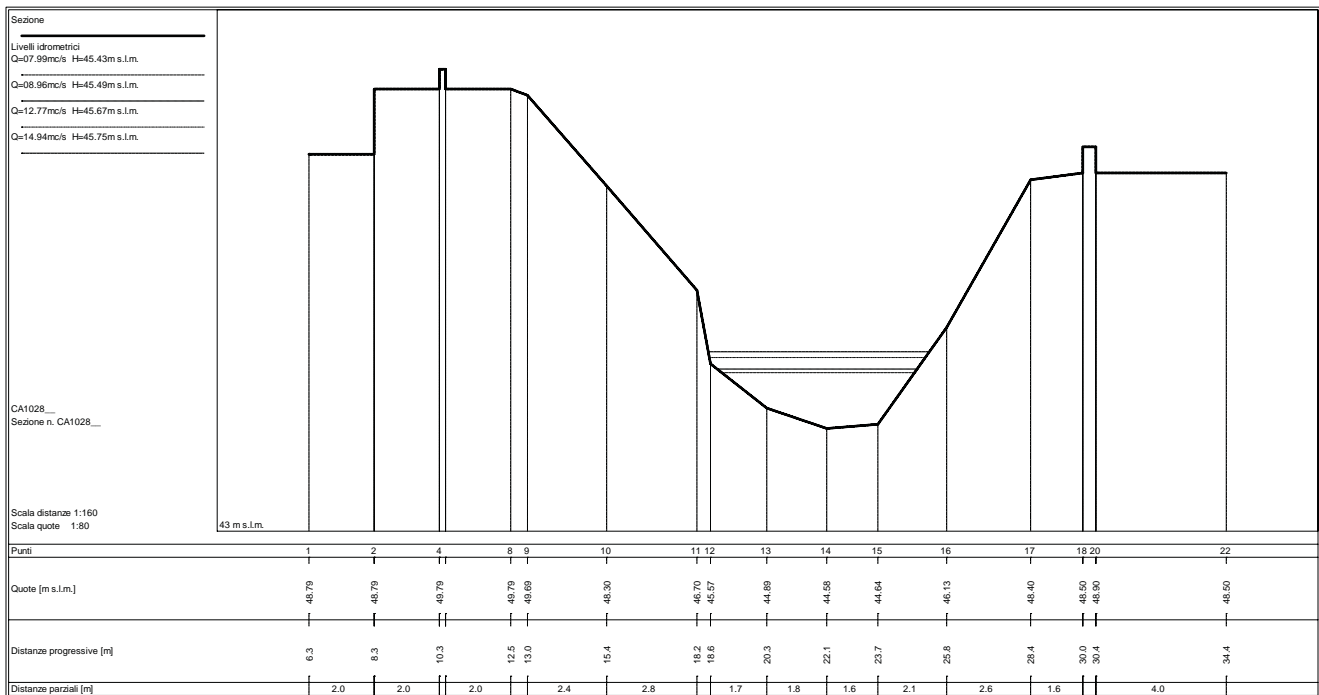
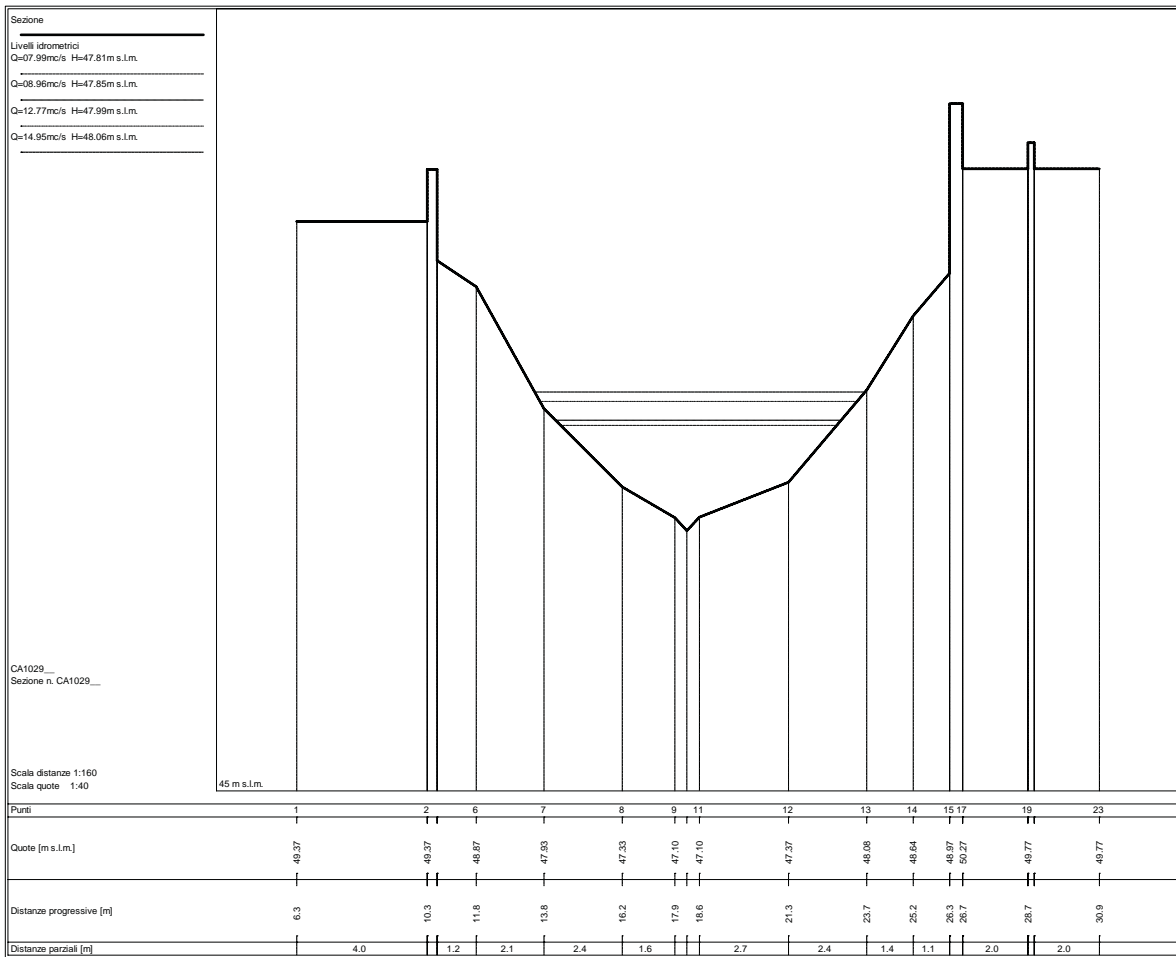

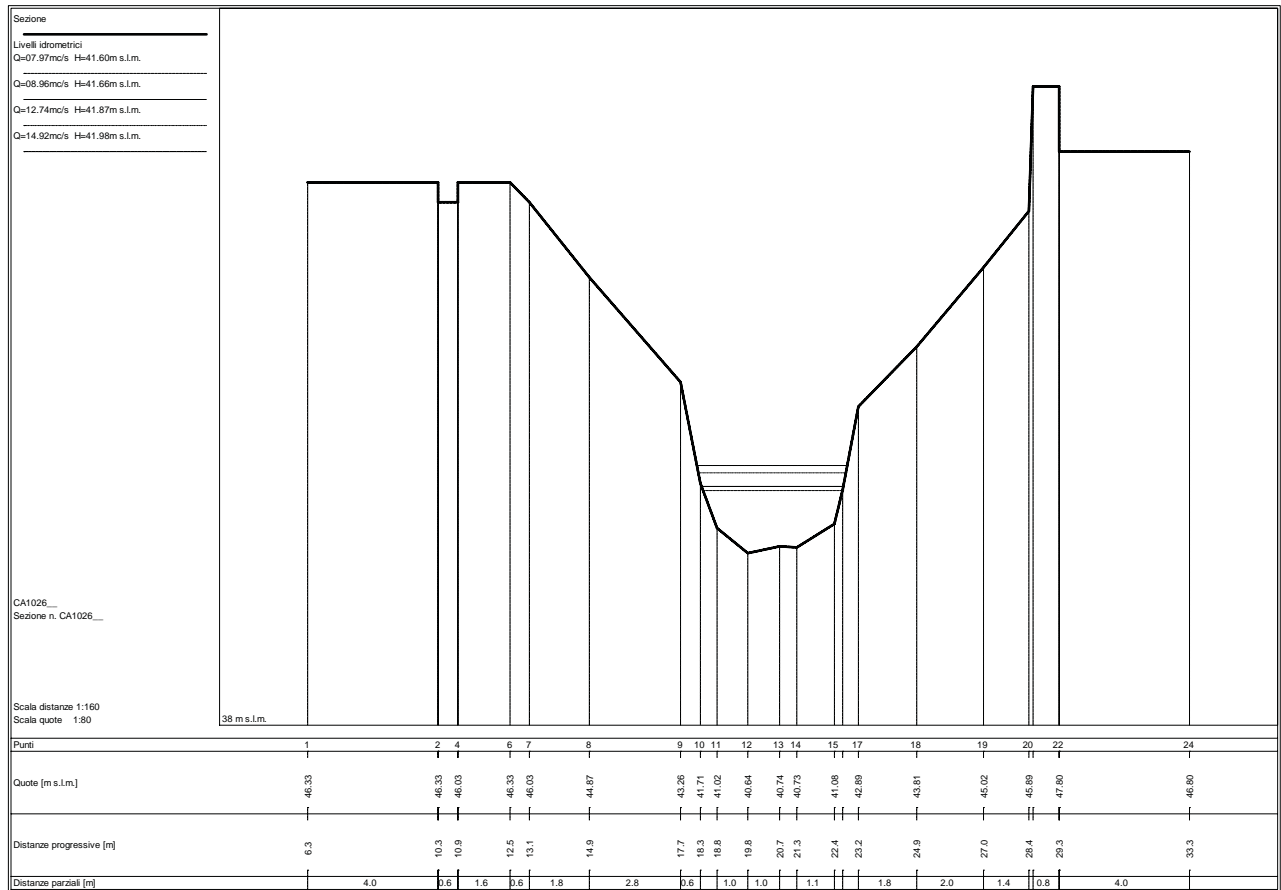
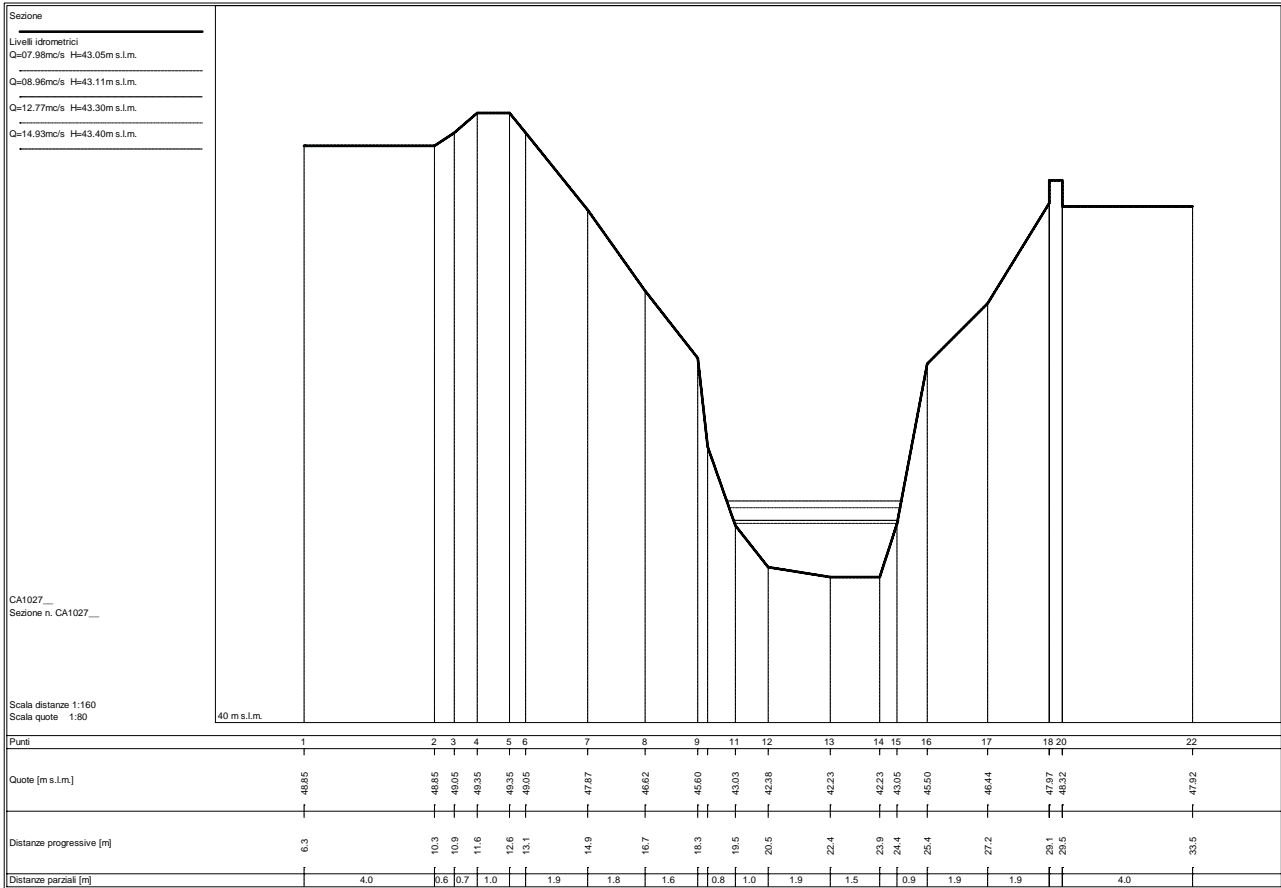

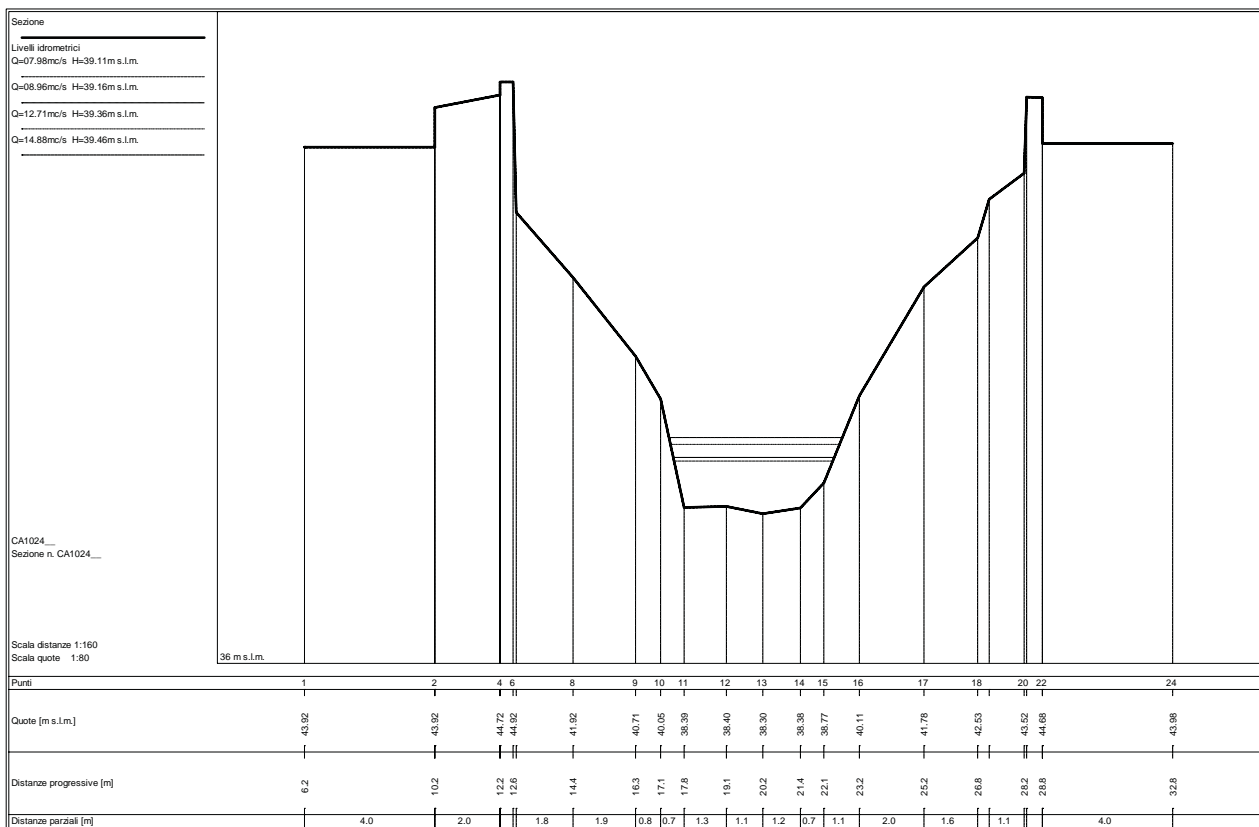
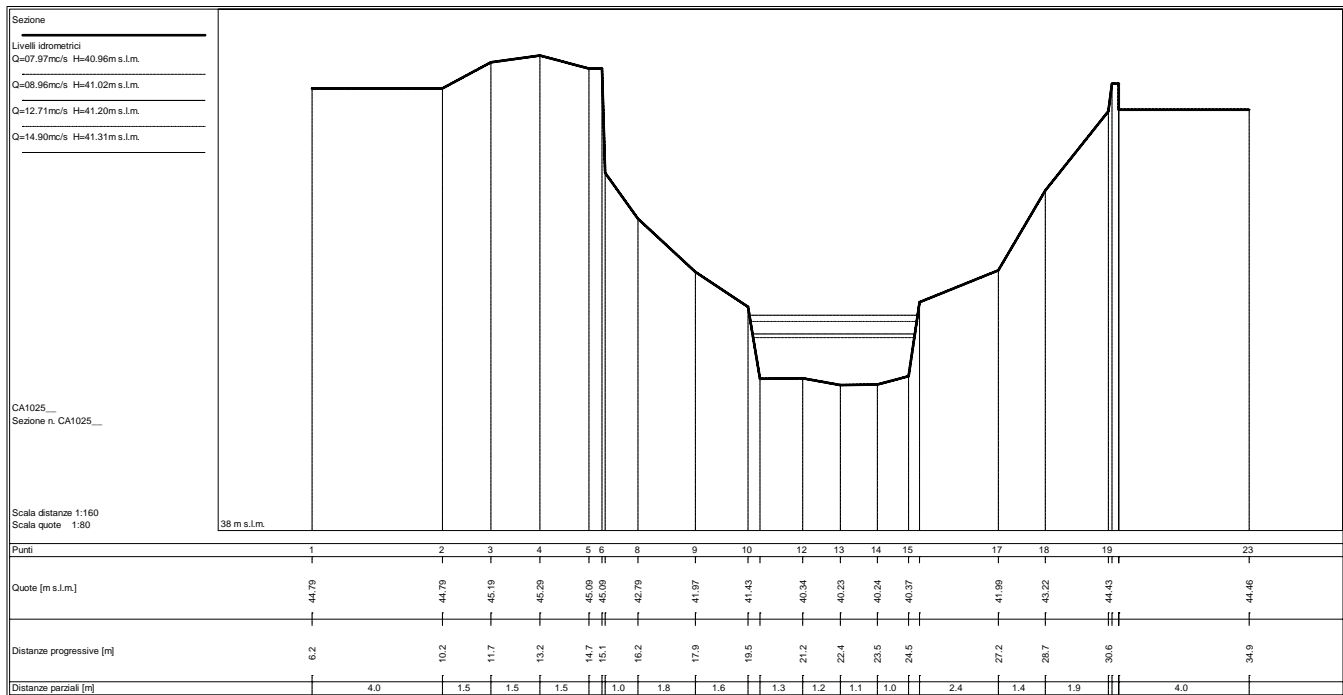

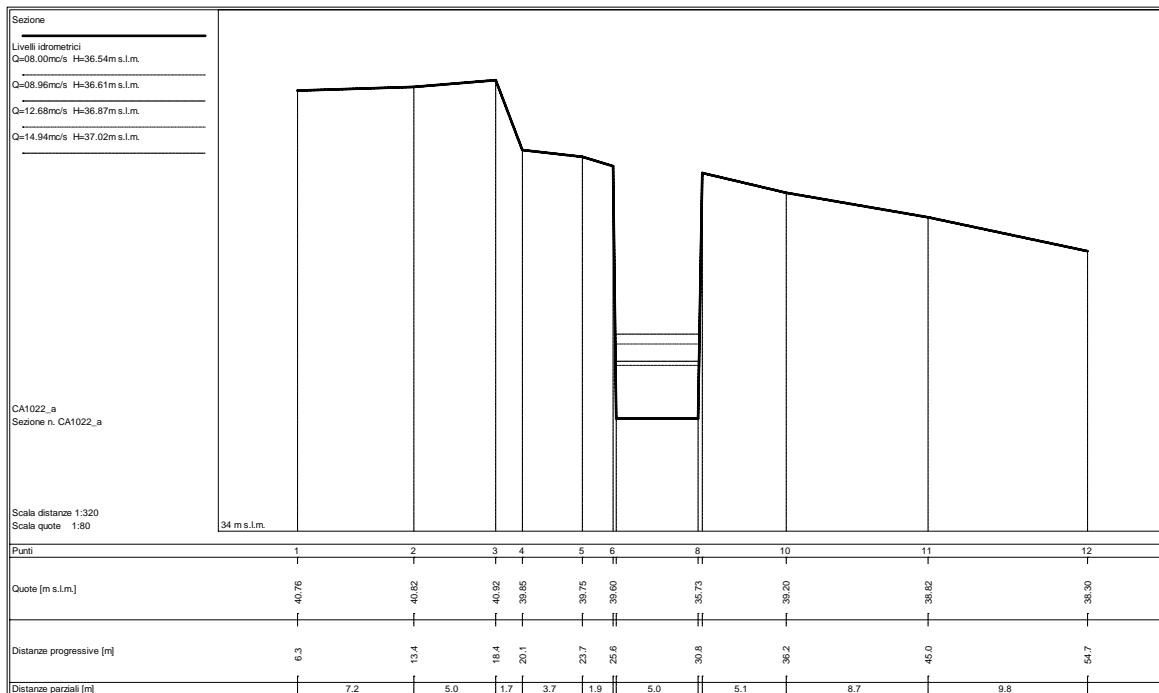
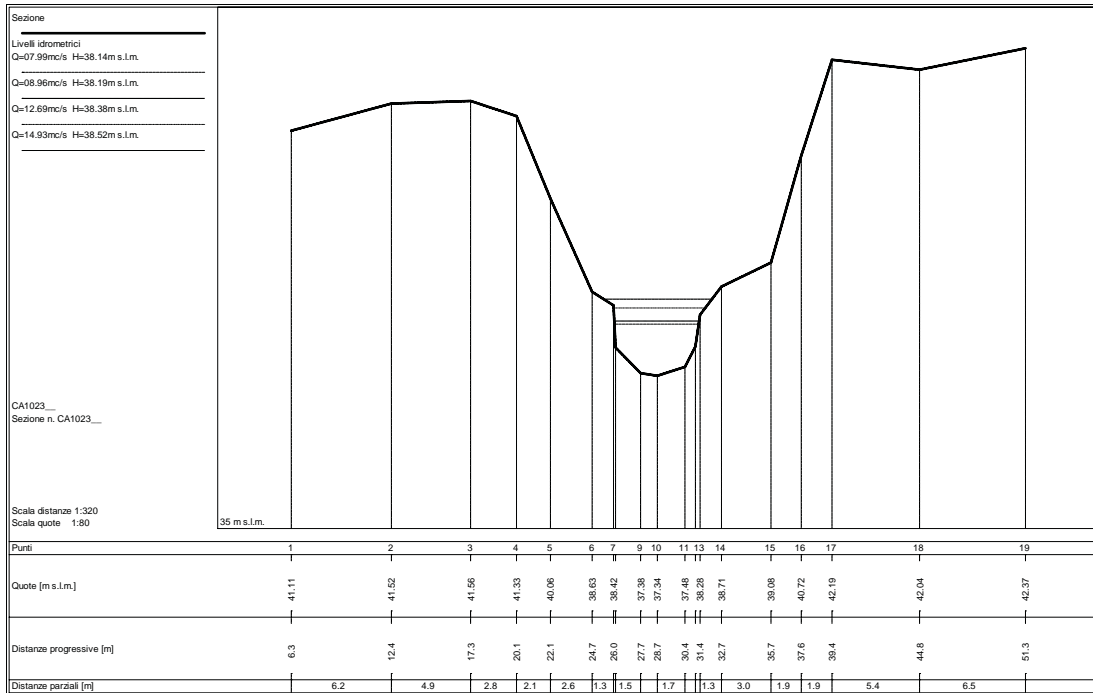

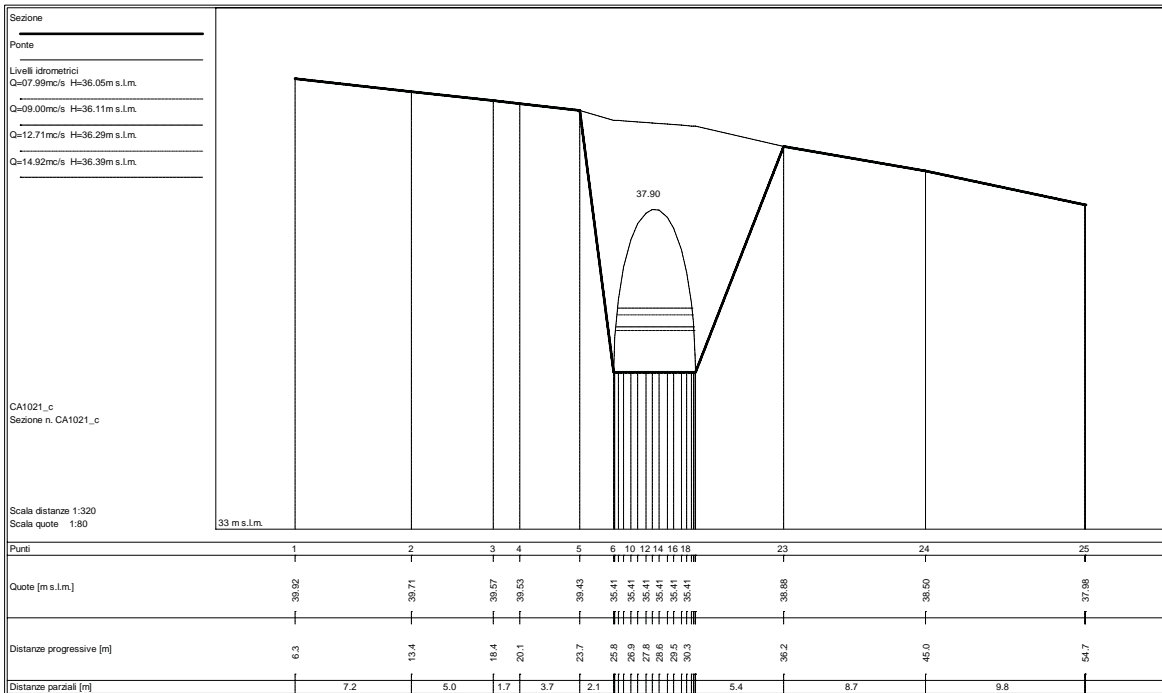
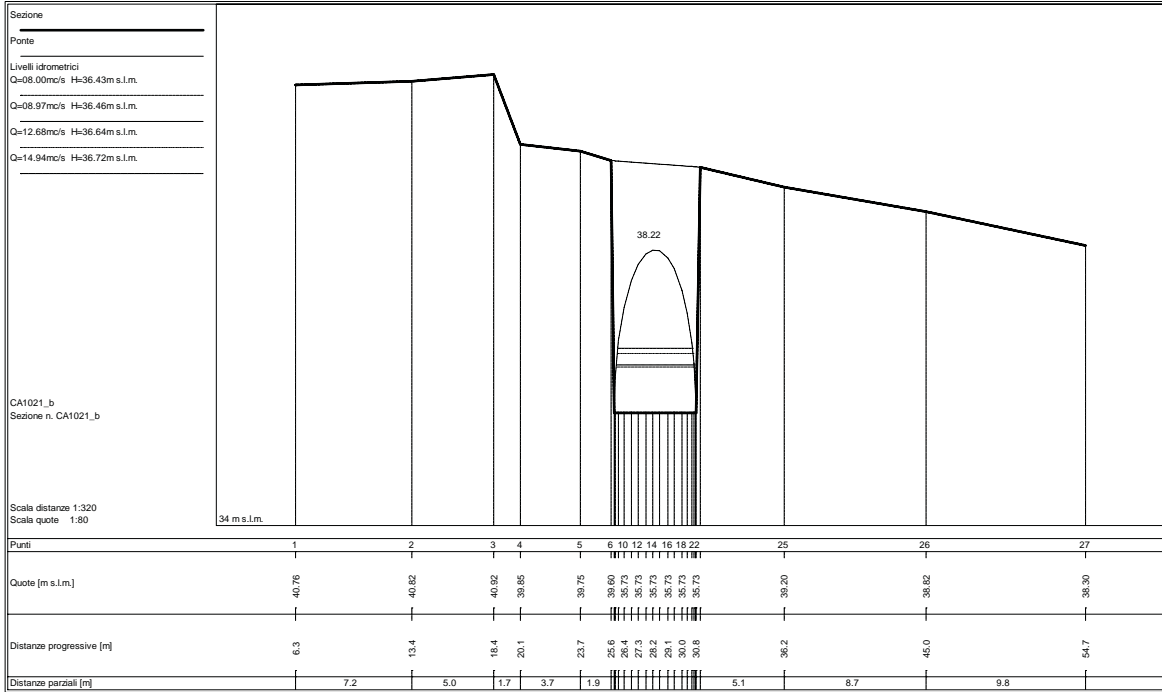

Sezione
 Livelli idrometrici
 Q=07.99mc/s H=35.70m s.l.m.
 Q=09.00mc/s H=35.76m s.l.m.
 Q=12.71mc/s H=35.93m s.l.m.
 Q=14.92mc/s H=36.03m s.l.m.

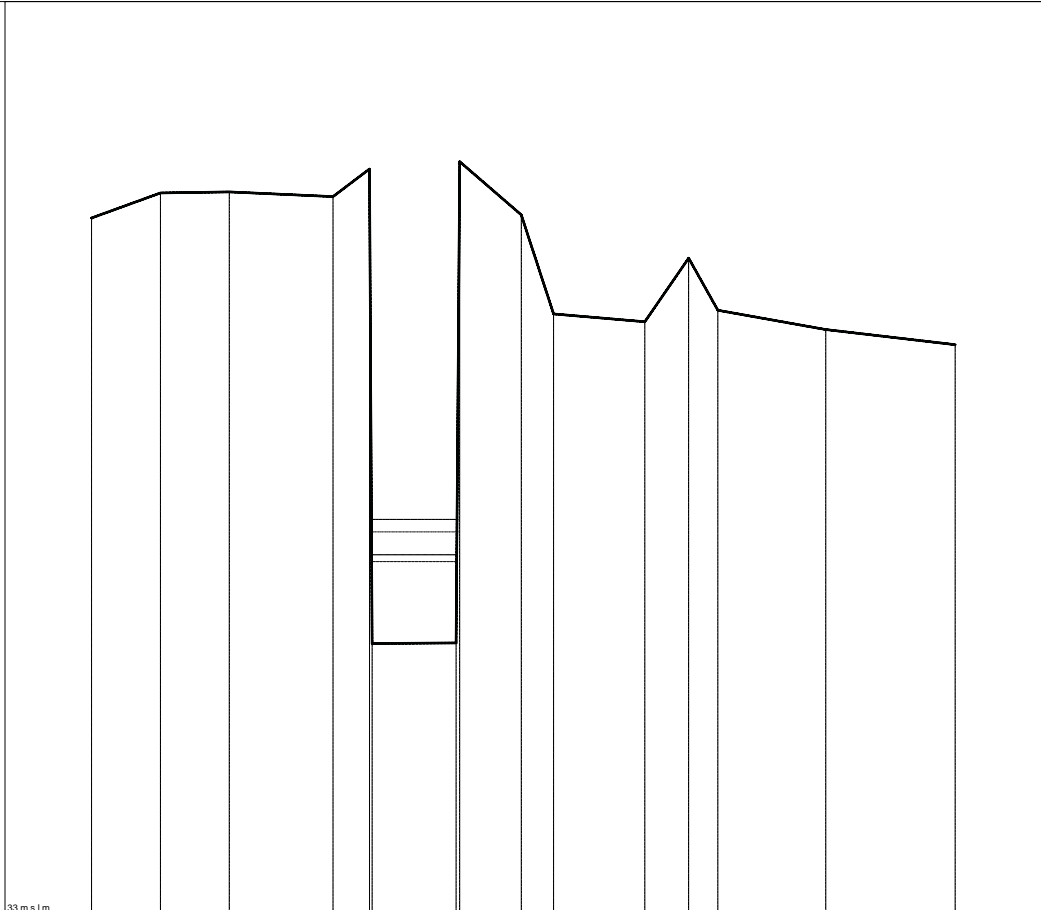

CA1020_d
 Sezione n. CA1020_d

Scala distanze 1:320
 Scala quote 1:40

Punti	1	2	3	4	5	7	9	10	11	12	13	14	15
Quote [m s.l.m.]	38.34	38.53	38.54	38.51	38.72	35.08	38.37	37.60	37.55	38.03	37.63	37.48	37.37
Distanze progressive [m]	6.3	10.5	14.7	21.1	23.3	28.6	32.6	34.6	40.2	42.9	44.7	51.3	58.3
Distanze parziali [m]	4.2	4.2	6.4	2.2	5.2	3.8	2.0	5.6	2.7	1.8	6.6	7.9	

Sezione
 Livelli idrometrici
 Q=08.00mc/s H=35.25m s.l.m.
 Q=08.99mc/s H=35.30m s.l.m.
 Q=12.69mc/s H=35.48m s.l.m.
 Q=14.94mc/s H=35.59m s.l.m.

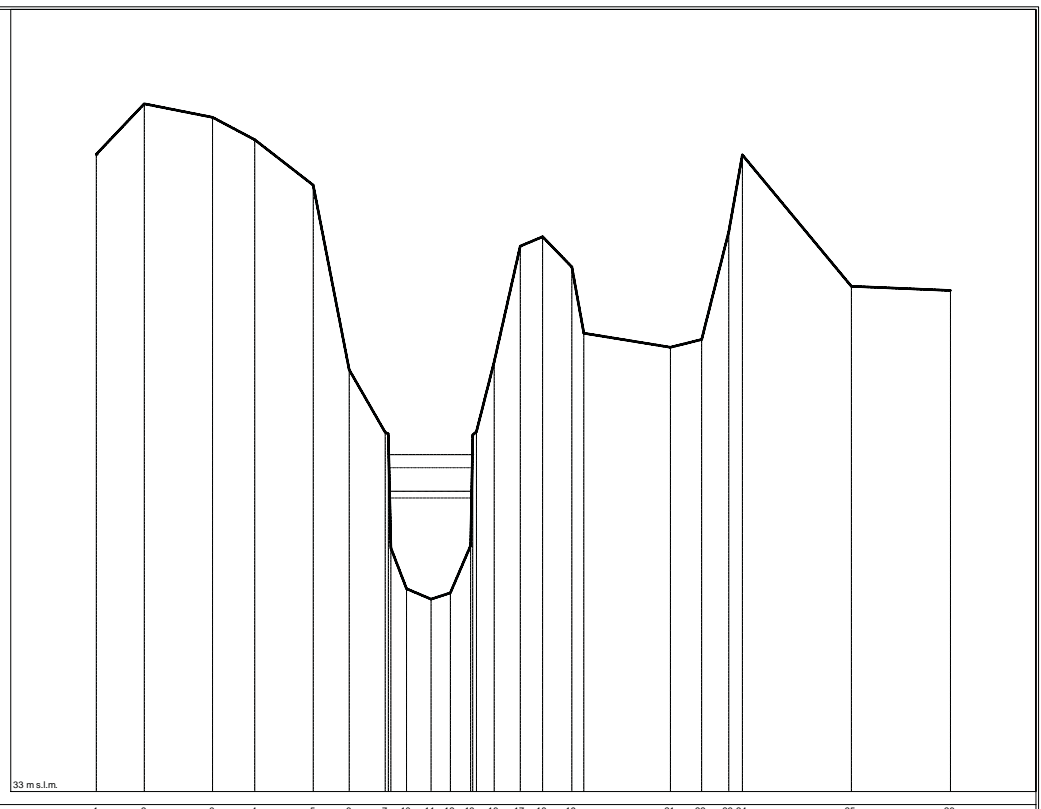

CA1019_
 Sezione n. CA1019_

Scala distanze 1:320
 Scala quote 1:40

Punti	1	2	3	4	5	6	7	10	11	12	13	16	17	18	19	21	22	23	24	25	26
Quote [m s.l.m.]	37.89	38.27	38.17	38.00	37.65	36.24	35.75	34.56	34.48	34.52	34.89	36.30	37.18	37.26	37.02	36.41	36.47	37.30	37.89	36.88	36.84
Distanze progressive [m]	6.3	9.2	13.4	16.0	19.6	21.8	24.0	25.3	26.8	28.0	29.2	30.7	32.3	33.7	35.4	41.5	43.4	45.1	45.9	52.6	58.7
Distanze parziali [m]	2.9	4.2	2.6	3.6	2.2	2.2	1.5	1.2	1.2	1.6	1.4	1.8	5.3	1.9	1.7	6.7				6.1	

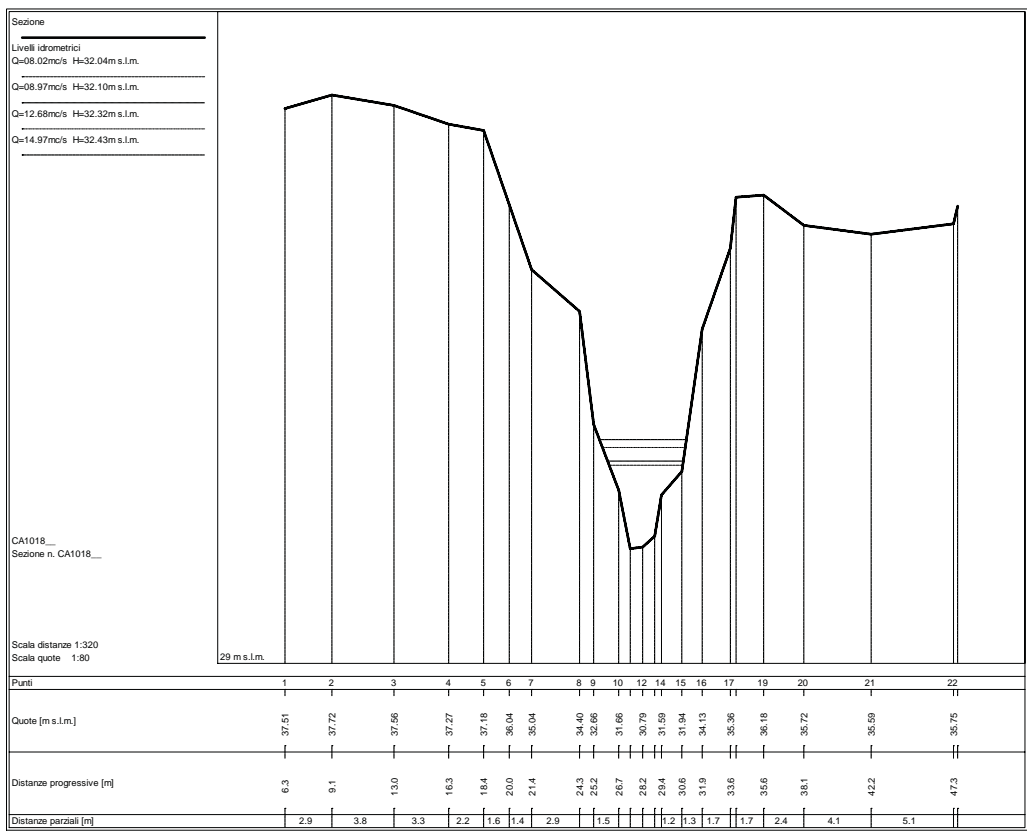
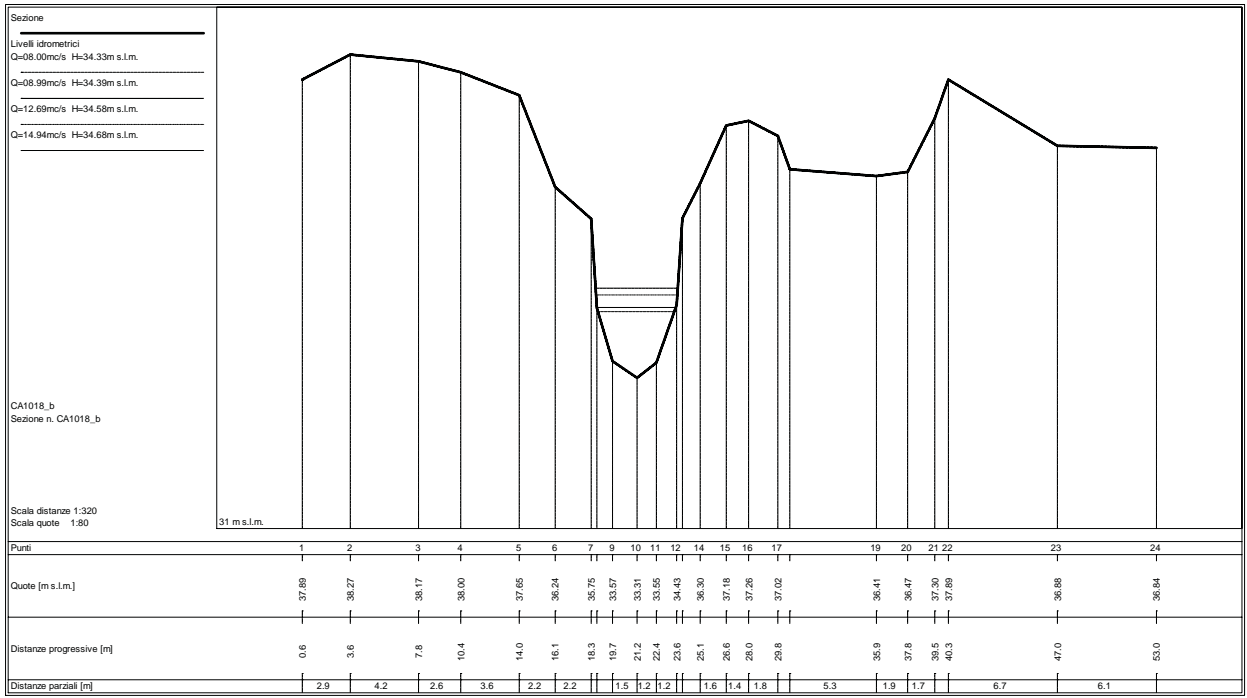

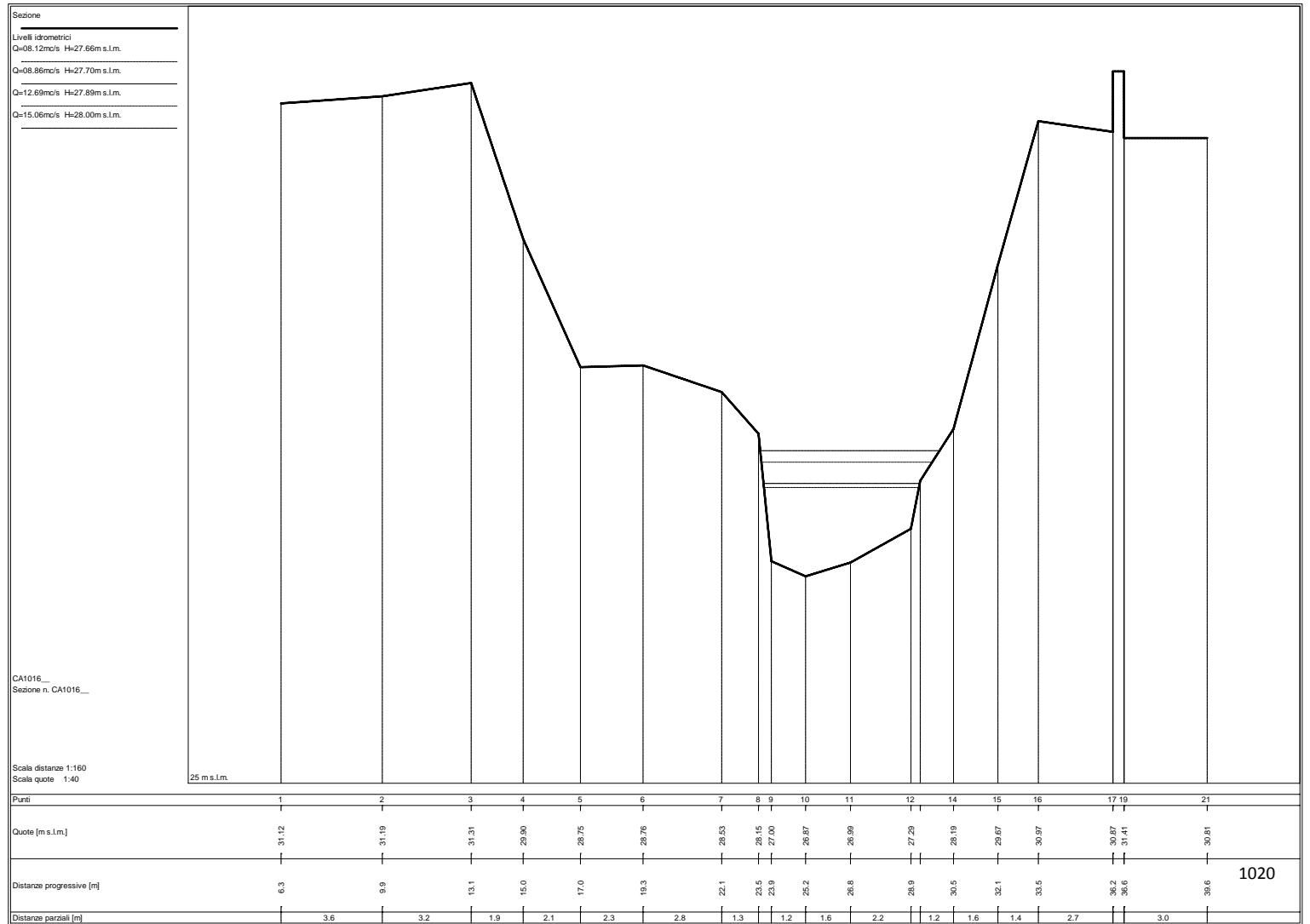
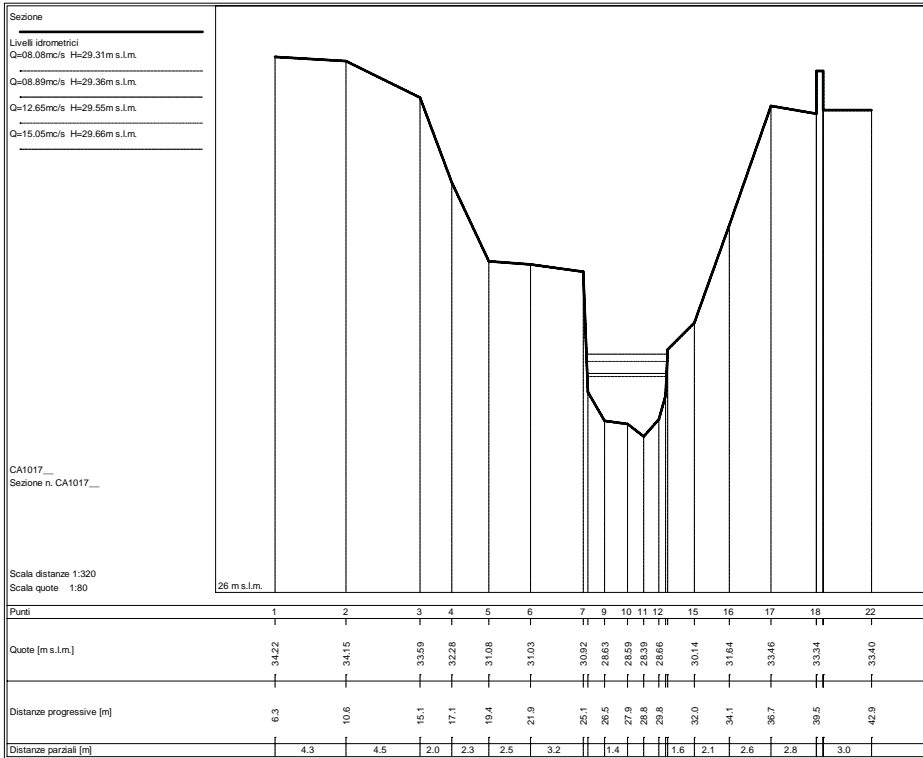

Sezione
 Livelli idrometrici
 Q=08.14mc/s H=26.06m s.l.m.
 Q=08.81mc/s H=26.11m s.l.m.
 Q=12.76mc/s H=26.35m s.l.m.
 Q=15.04mc/s H=26.47m s.l.m.

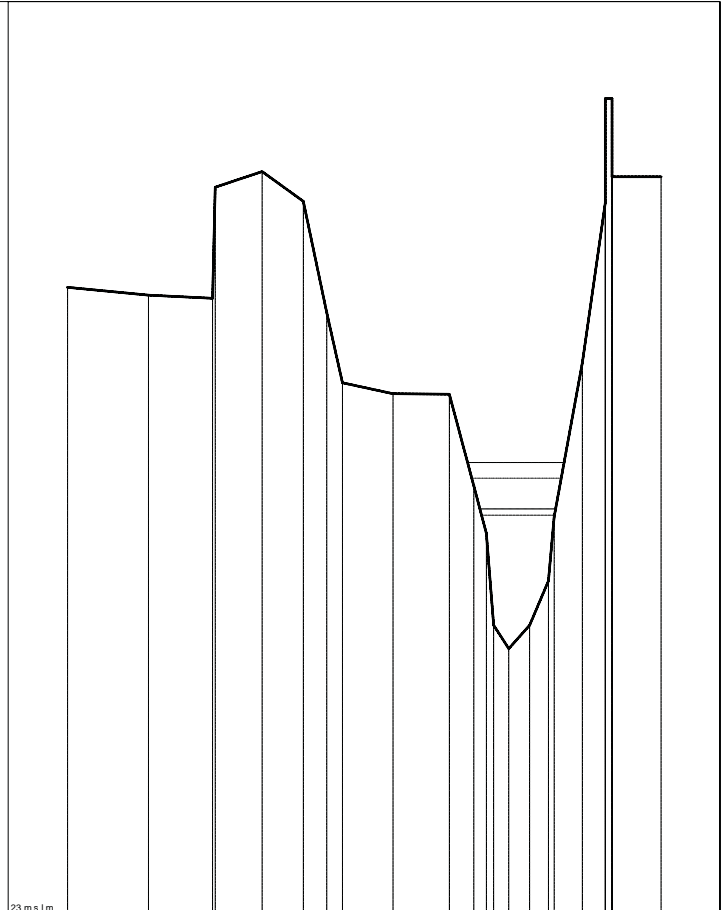

CA1015_
 Sezione n. CA1015_

Scala distanze 1:320
 Scala quote 1:40

23 m s.l.m.

Punti	1	2	3	5	6	7	8	9	10	11	12	14	15	16	18	19	23
Quote [m s.l.m.]	27.81	27.75	27.72	28.70	28.47	27.61	27.08	26.99	26.99	26.20	25.92	25.04	25.22	25.56	27.23	26.46	28.66
Distanze progressive [m]	6.3	11.2	15.1	18.2	20.7	22.2	23.1	26.2	28.7	31.2	32.0	33.3	34.6	35.8	37.8	38.3	42.7
Distanze parziali [m]		5.0	3.9	2.9	2.5	1.4	3.1	3.5	1.5	3.2	0.8	1.3	1.2	1.7	1.4	3.0	

Sezione
 Livelli idrometrici
 Q=08.16mc/s H=24.83m s.l.m.
 Q=08.83mc/s H=24.87m s.l.m.
 Q=12.83mc/s H=25.03m s.l.m.
 Q=15.04mc/s H=25.11m s.l.m.

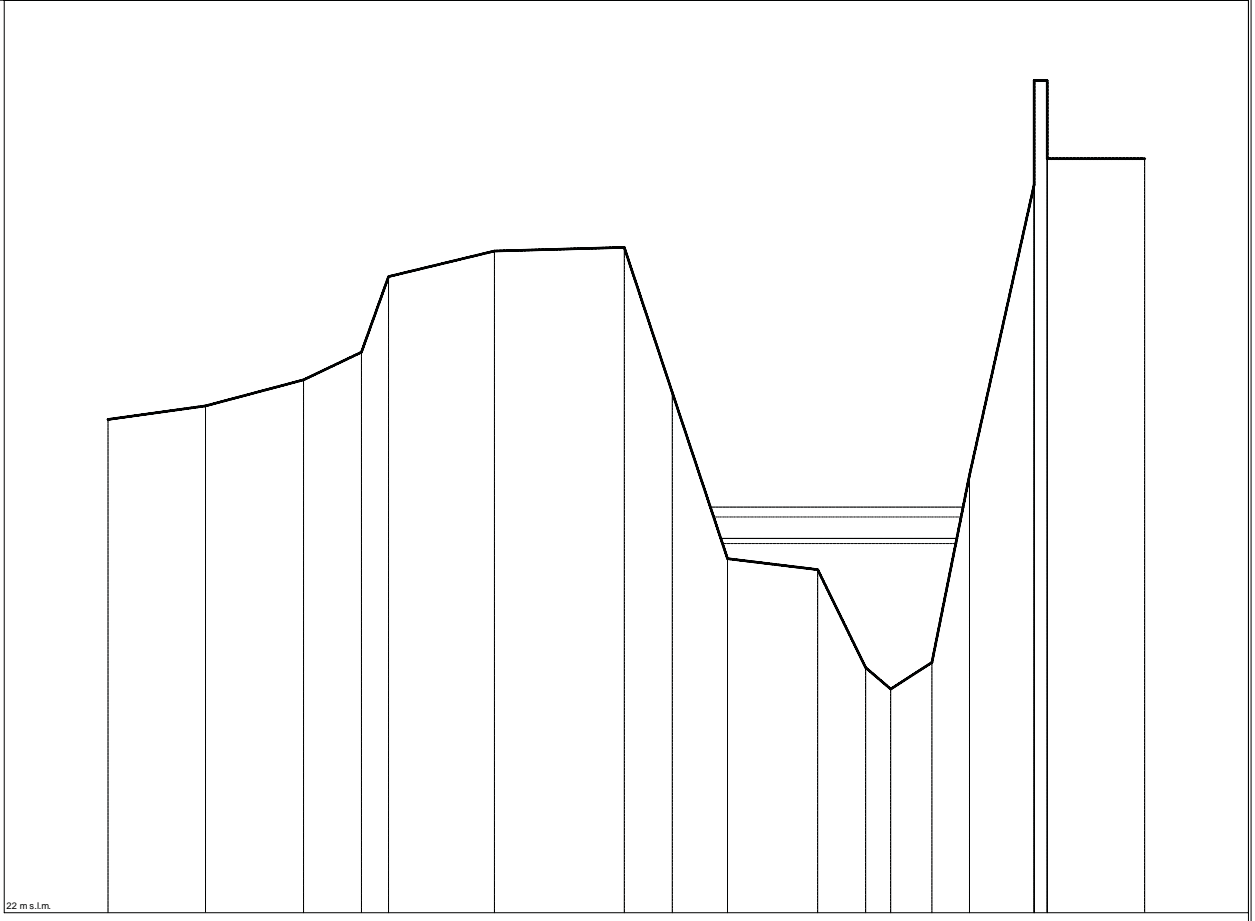

CA1014_
 Sezione n. CA1014_

Scala distanze 1:160
 Scala quote 1:40

22 m s.l.m.

Punti	1	2	3	4	5	6	7	8	9	10	11	12	13	14	15	17	19
Quote [m s.l.m.]	25.79	25.89	26.09	26.30	26.88	27.07	27.10	25.99	24.72	24.63	23.88	23.71	23.92	25.36	27.58	28.38	27.78
Distanze progressive [m]	6.5	9.5	12.5	14.3	15.1	18.4	22.3	23.8	25.5	26.3	26.8	30.5	31.8	32.9	34.9	35.3	36.3
Distanze parziali [m]		3.0	3.0	1.8	0.8	3.2	4.0	1.5	1.7	2.8	1.5	0.8	1.3	1.2	2.0	3.0	

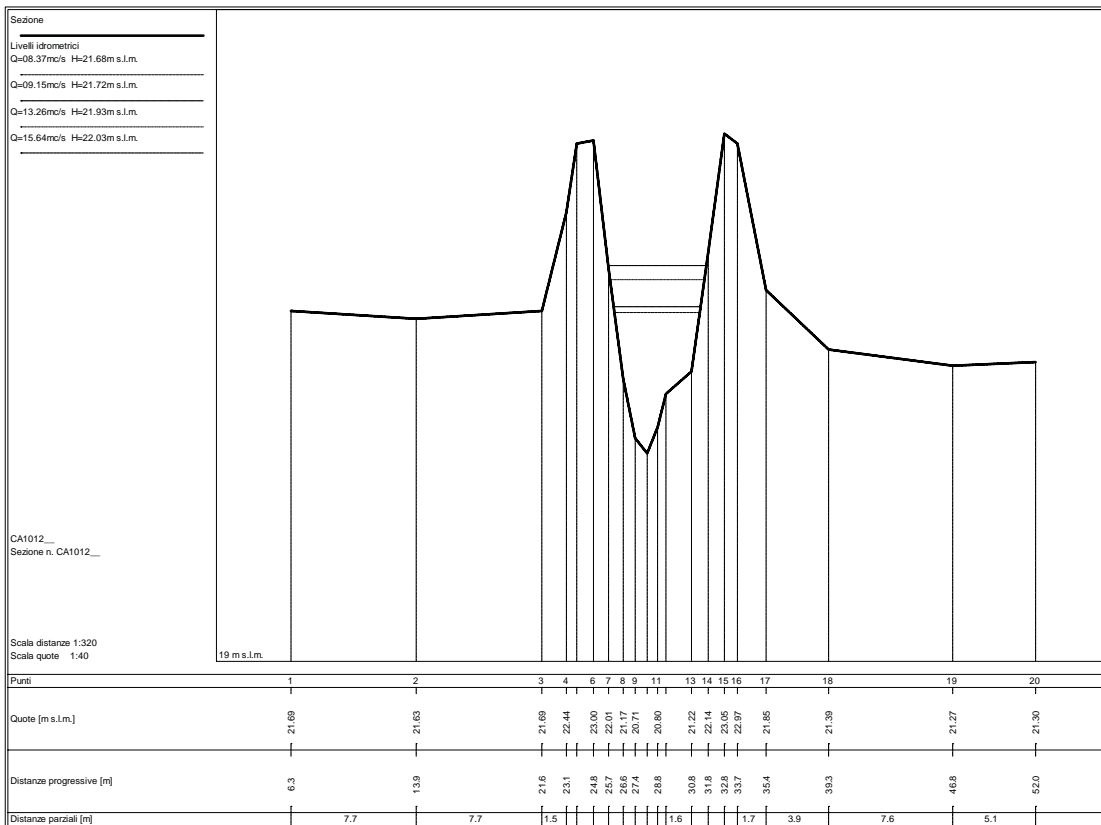
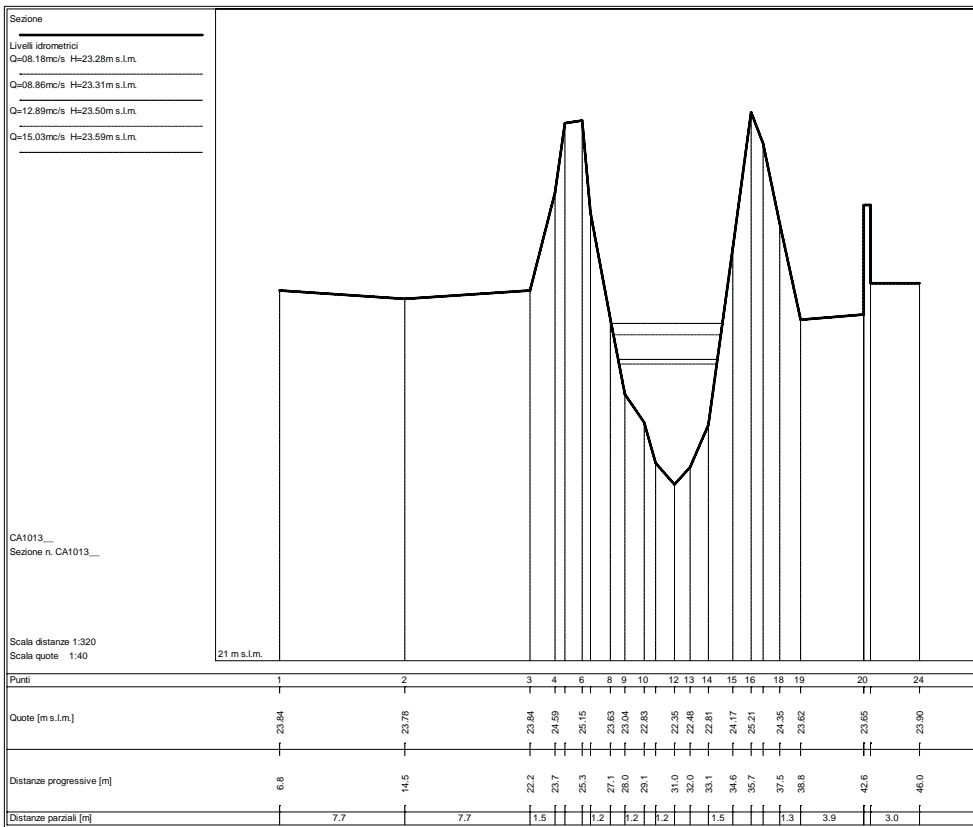

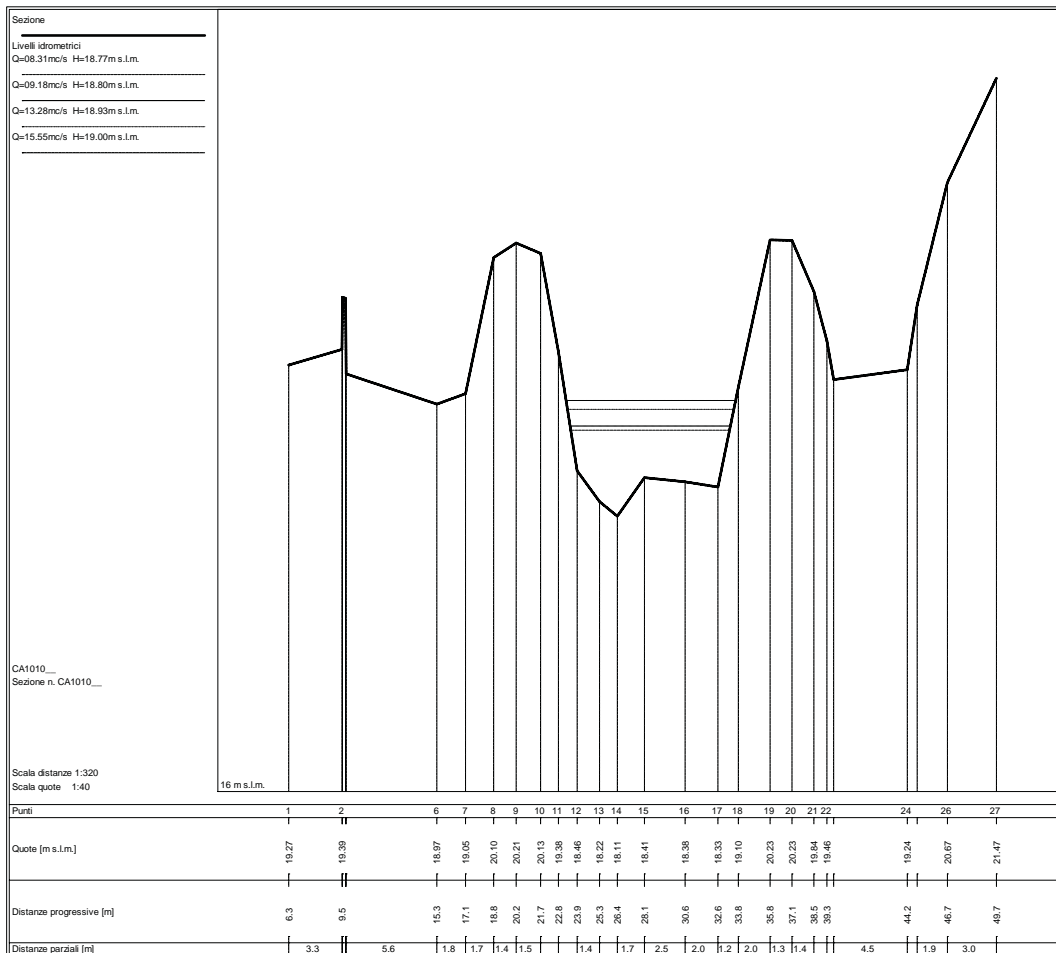
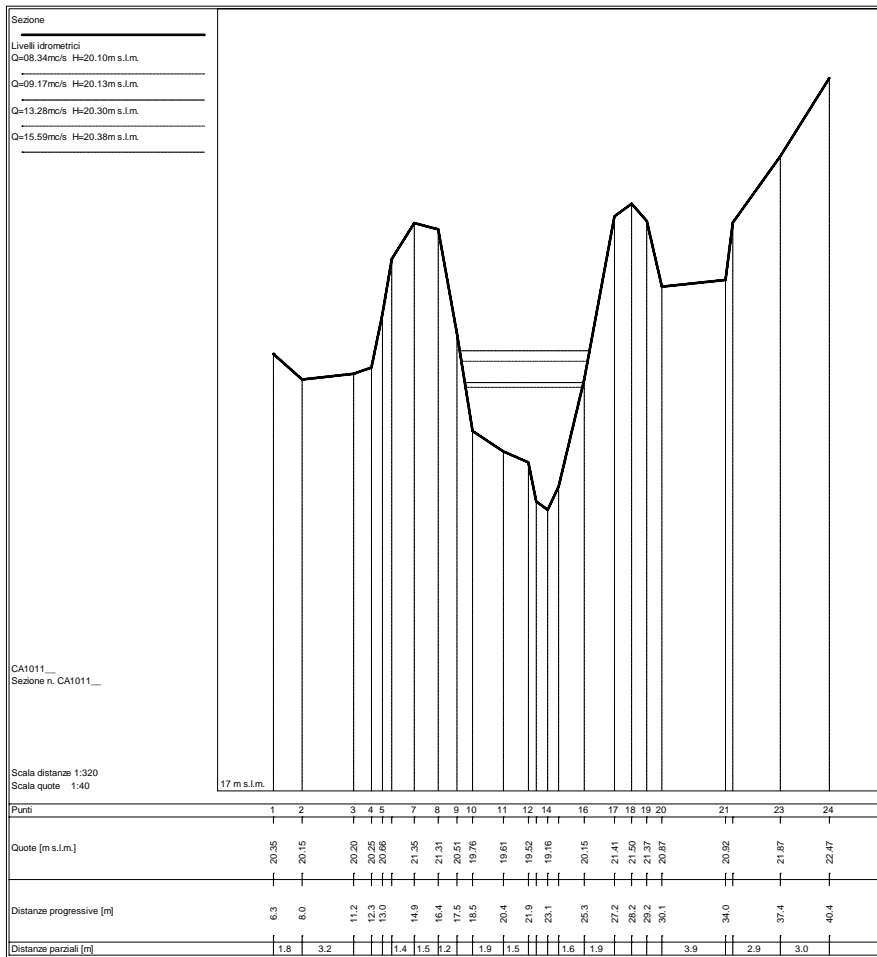

Sezione
 Livelli idrometrici
 Q=09.02mc/s H=17.67m s.l.m.
 Q=10.12mc/s H=17.71m s.l.m.
 Q=14.54mc/s H=17.87m s.l.m.
 Q=18.52mc/s H=18.41m s.l.m.

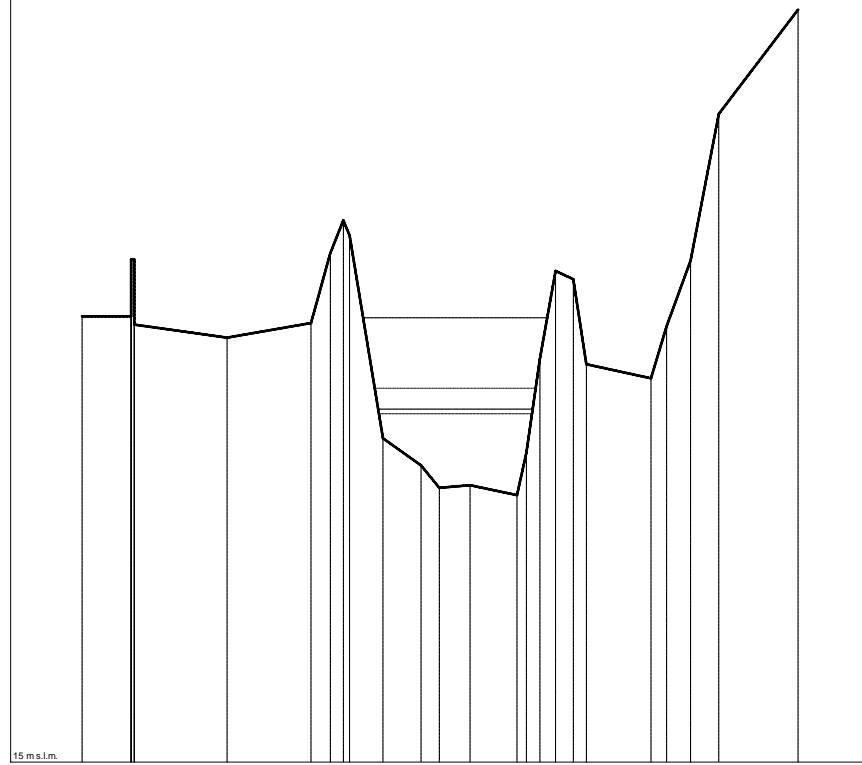

CA1009_
 Sezione n. CA1009_

Scala distanze 1:320
 Scala quote 1:40

Punti	1	2	6	7	8	9	11	12	13	14	15	17	18	19	20	21	22	23	24	25
Quote [m s.l.m.]	18.42	18.42	18.26	18.37	18.90	19.16	17.49	17.28	17.10	17.12	17.05	18.10	18.77	18.70	18.05	17.94	18.35	18.85	19.97	20.77
Distanze progressive [m]	6.6	9.6	15.5	20.6	21.8	22.6	25.0	27.4	28.5	30.4	33.2	34.7	35.6	36.7	37.5	41.5	42.4	43.9	45.6	50.5
Distanze parziali [m]	3.0	5.7	5.1	1.2	2.1	2.3	1.9	2.9							4.0	1.5	1.7	4.9		

Sezione
 Livelli idrometrici
 Q=09.02mc/s H=17.03m s.l.m.
 Q=10.11mc/s H=17.22m s.l.m.
 Q=14.49mc/s H=18.03m s.l.m.
 Q=18.83mc/s H=18.51m s.l.m.

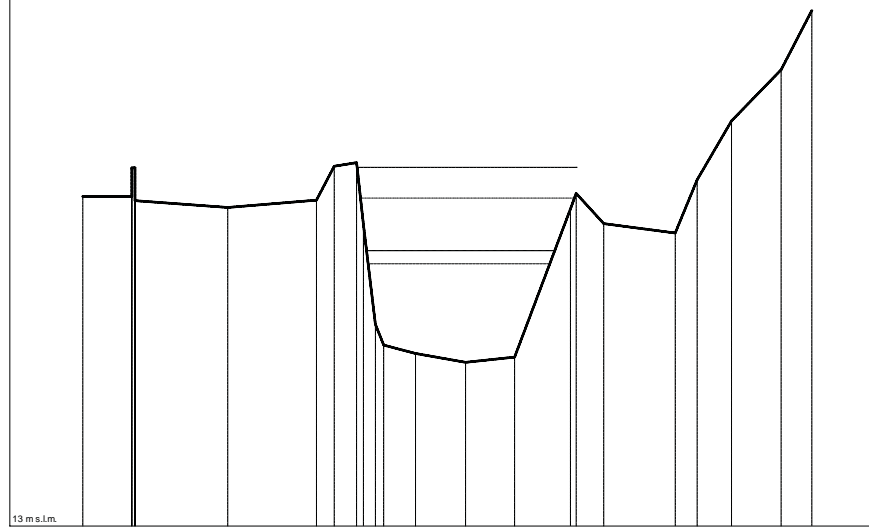

CA1008_
 Sezione n. CA1008_

Scala distanze 1:320
 Scala quote 1:80

Punti	1	2	6	7	8	9	11	13	14	15	16	18	19	20	21	22	23
Quote [m s.l.m.]	18.06	18.06	17.89	18.00	18.52	18.57	16.10	15.65	15.51	15.59	17.96	17.64	17.49	18.31	19.22	20.00	20.81
Distanze progressive [m]	6.6	9.6	15.5	21.0	22.1	23.4	24.6	27.0	30.1	33.1	36.5	38.6	43.0	44.3	46.4	48.5	51.4
Distanze parziali [m]	3.0	5.7	5.4	1.4	1.1	1.2	2.0	3.1	3.0	3.4	1.7	4.4	1.4	2.1	3.0	1.9	

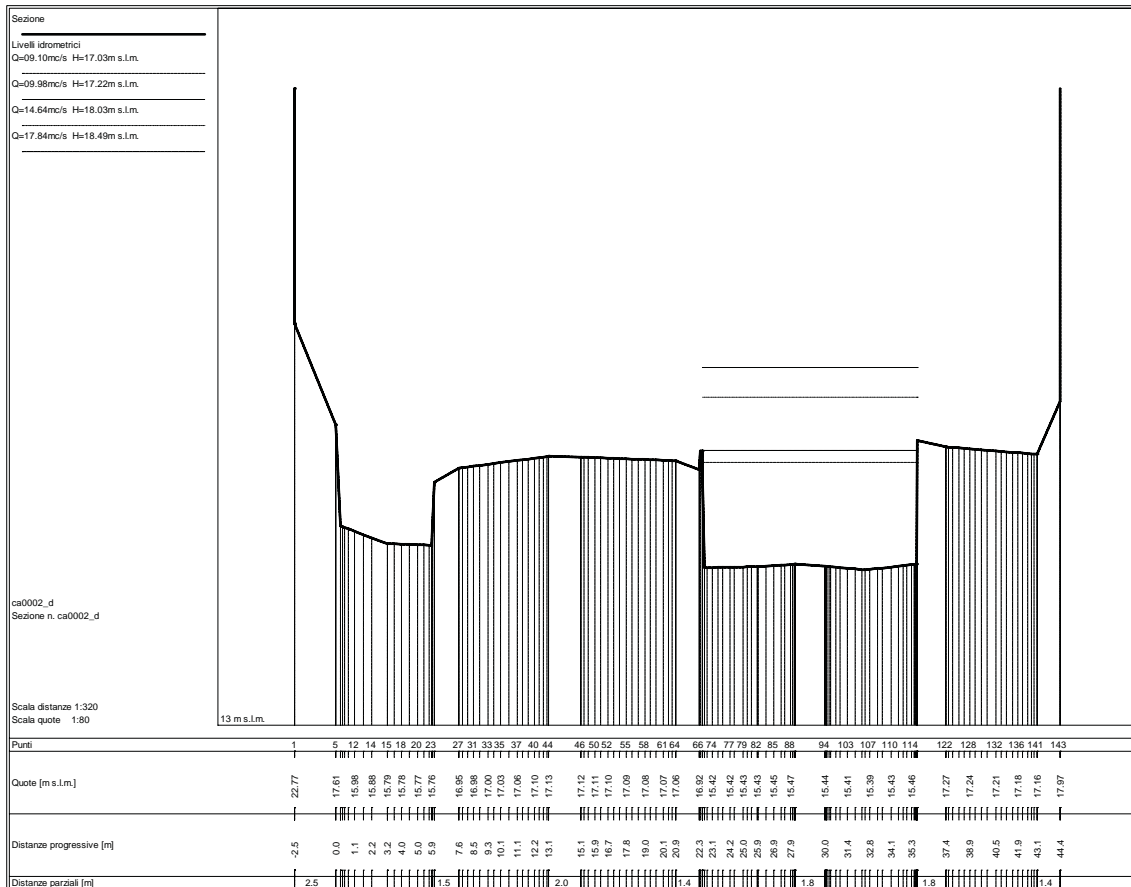
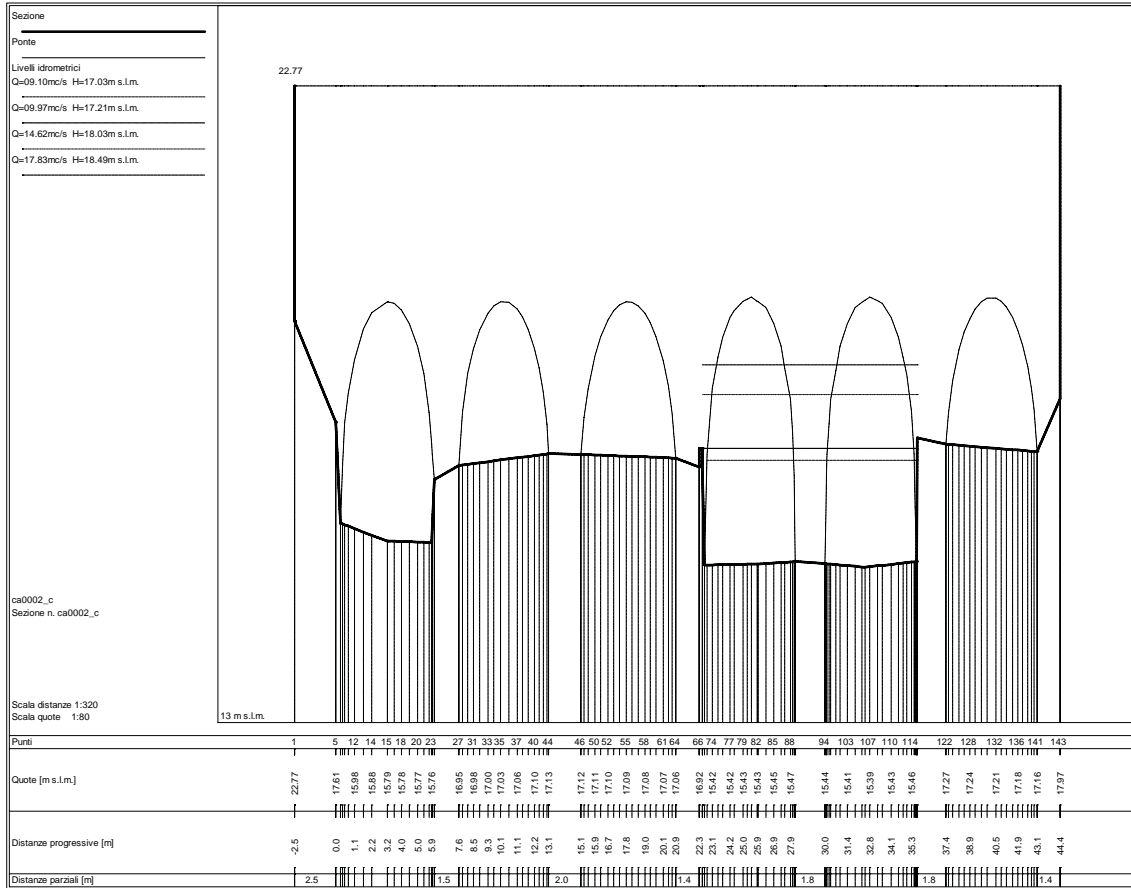

STATO ATTUALE

Sezioni fluviali torrente Canalmagro – Canalmagro_02

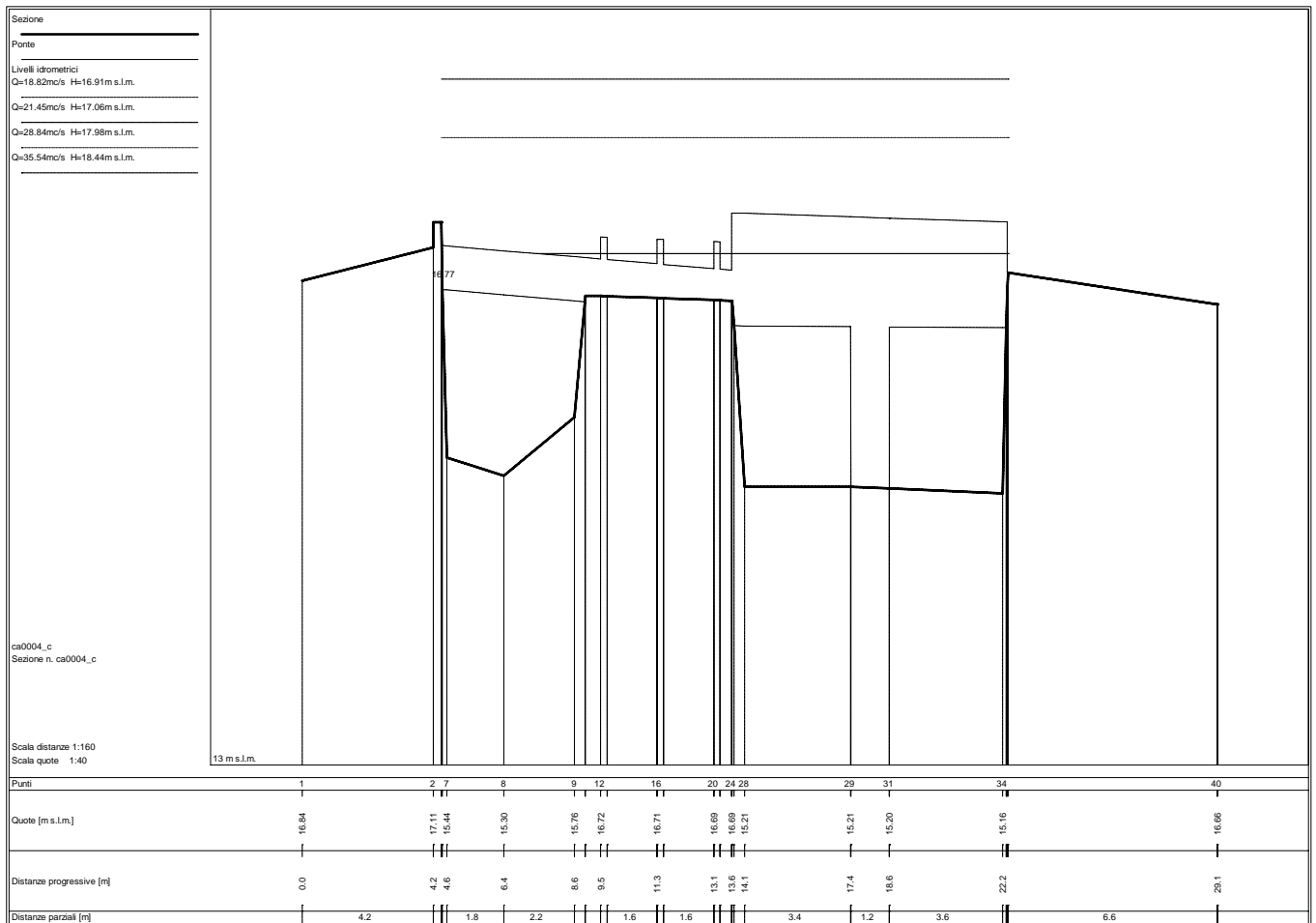
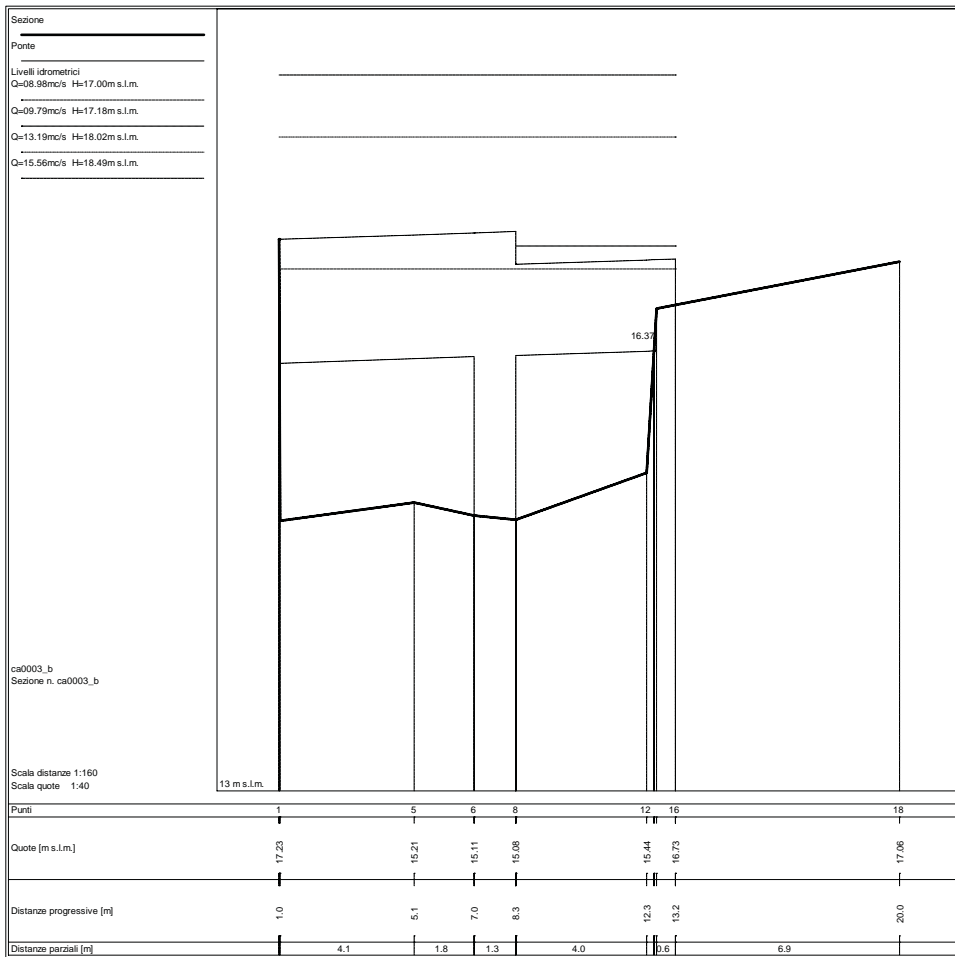

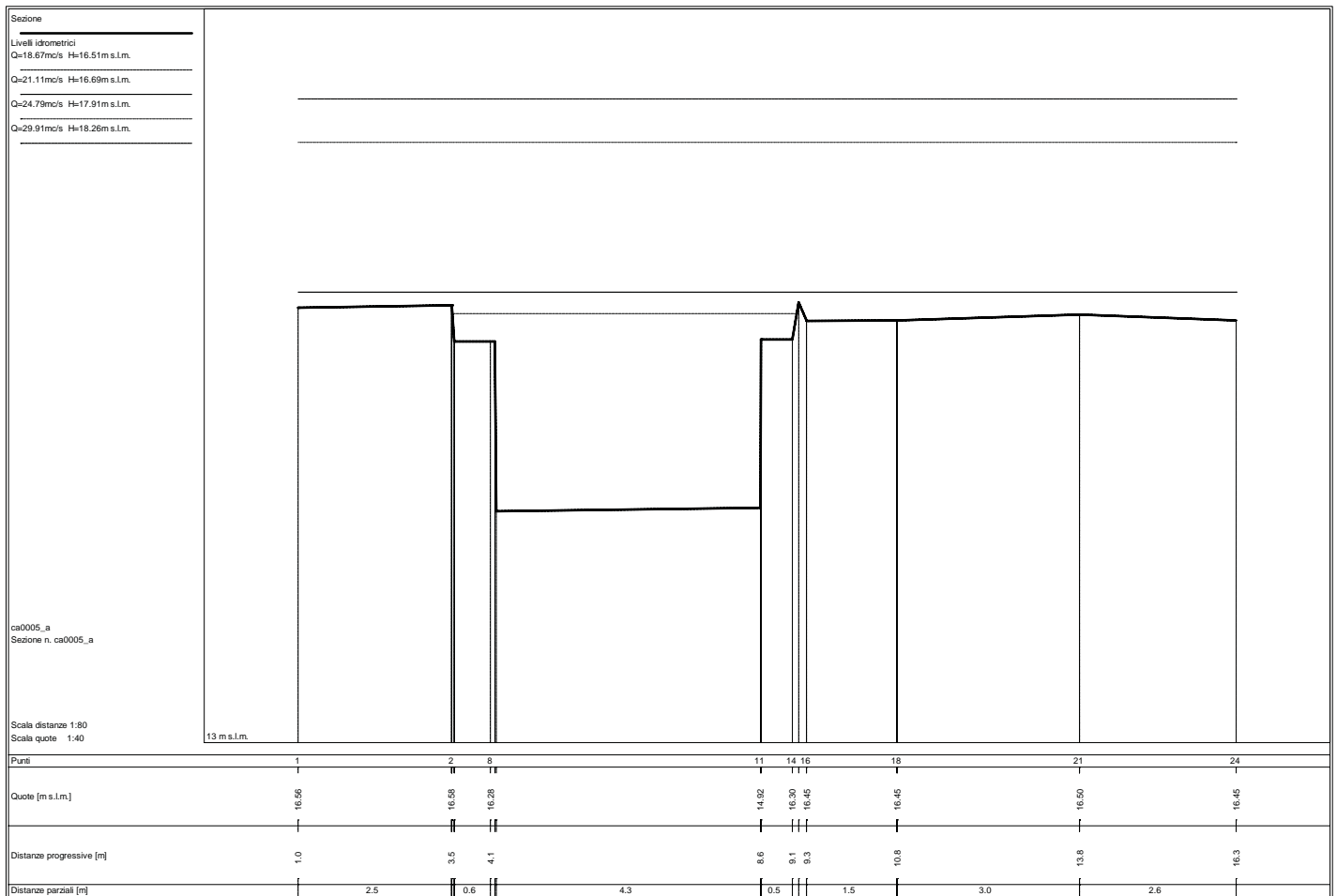
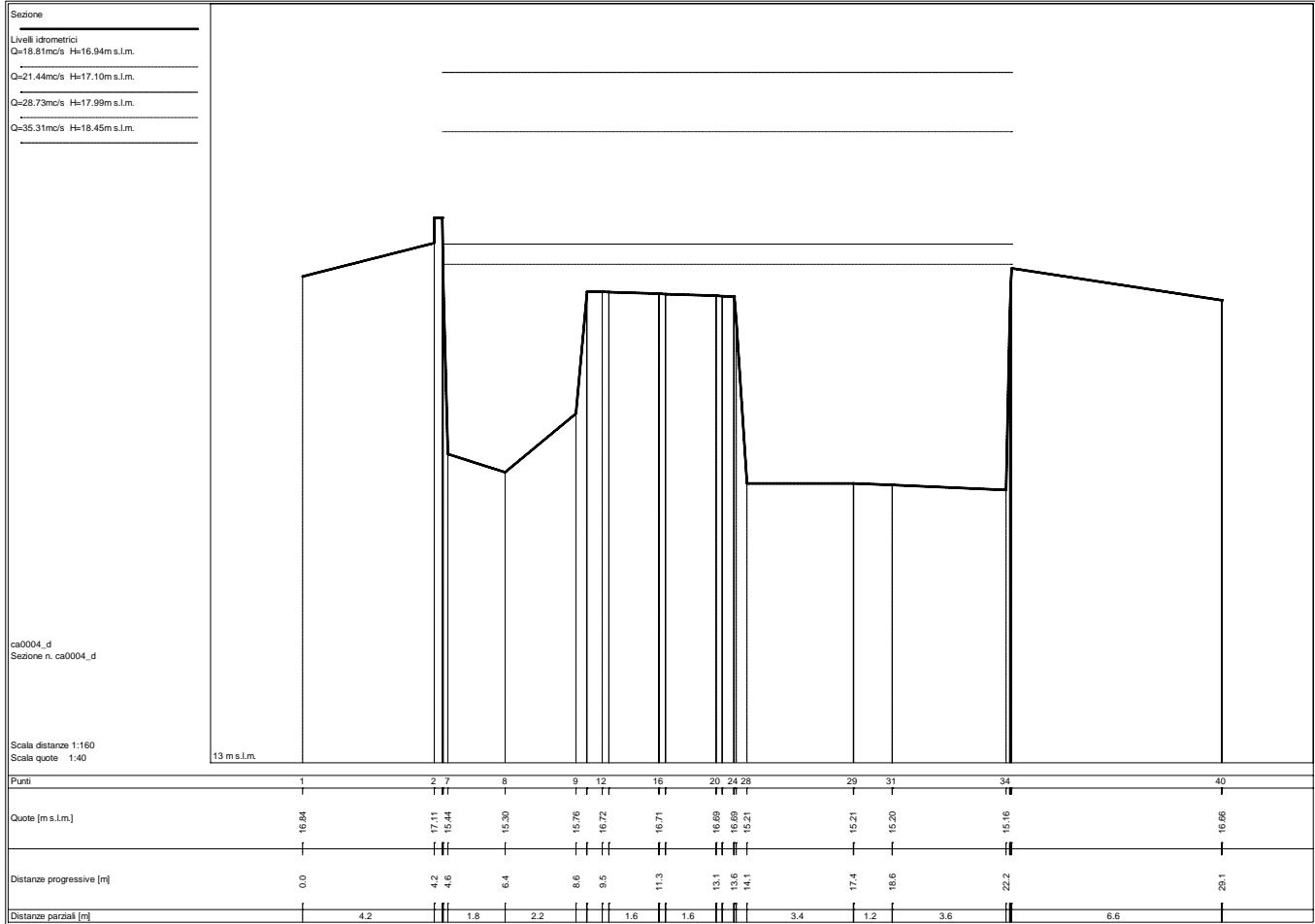

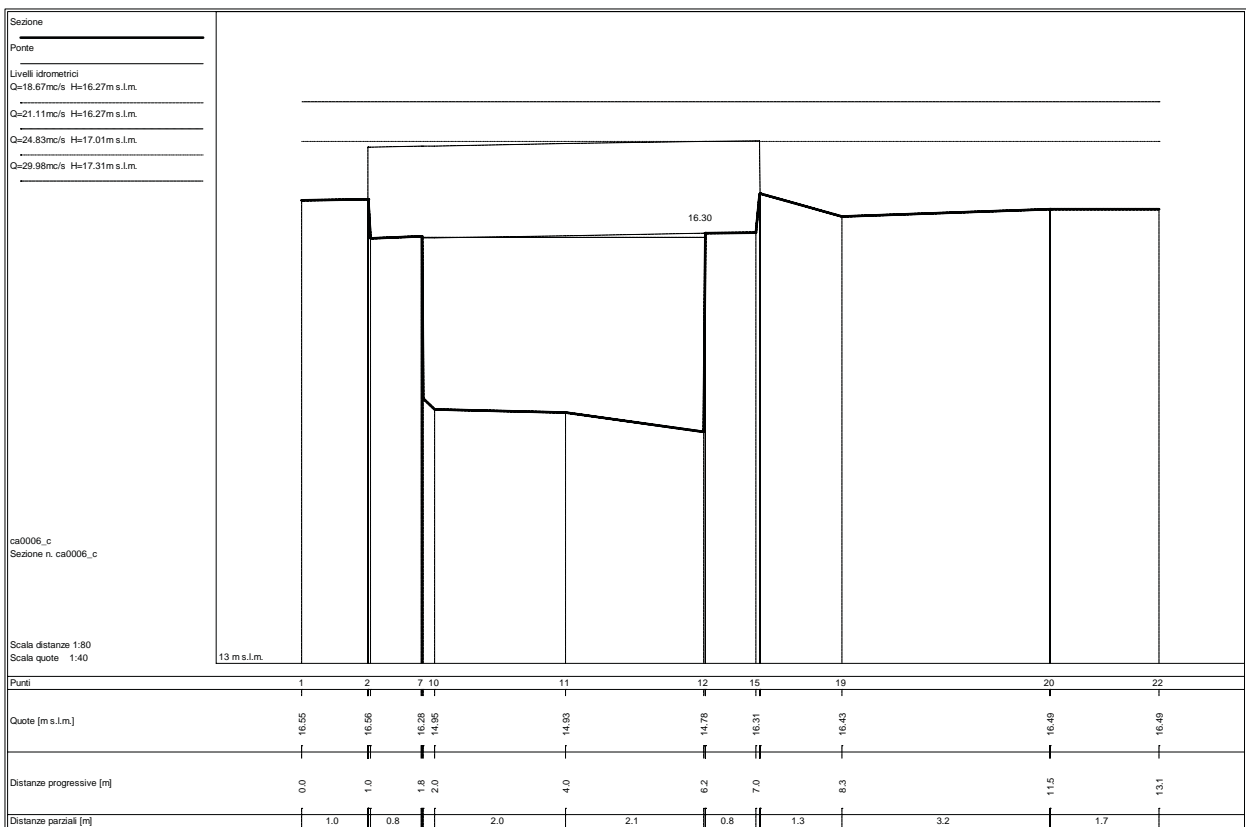
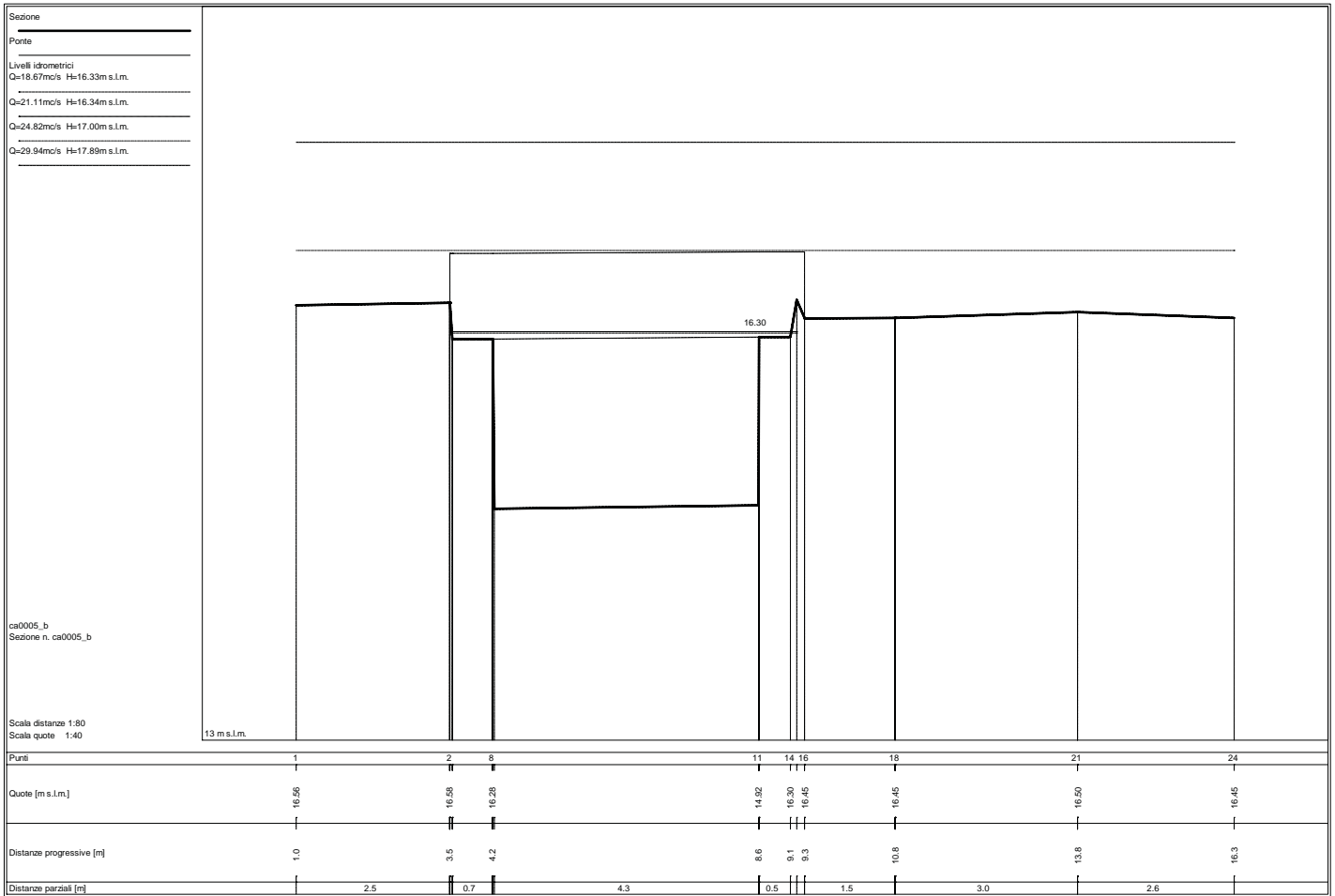

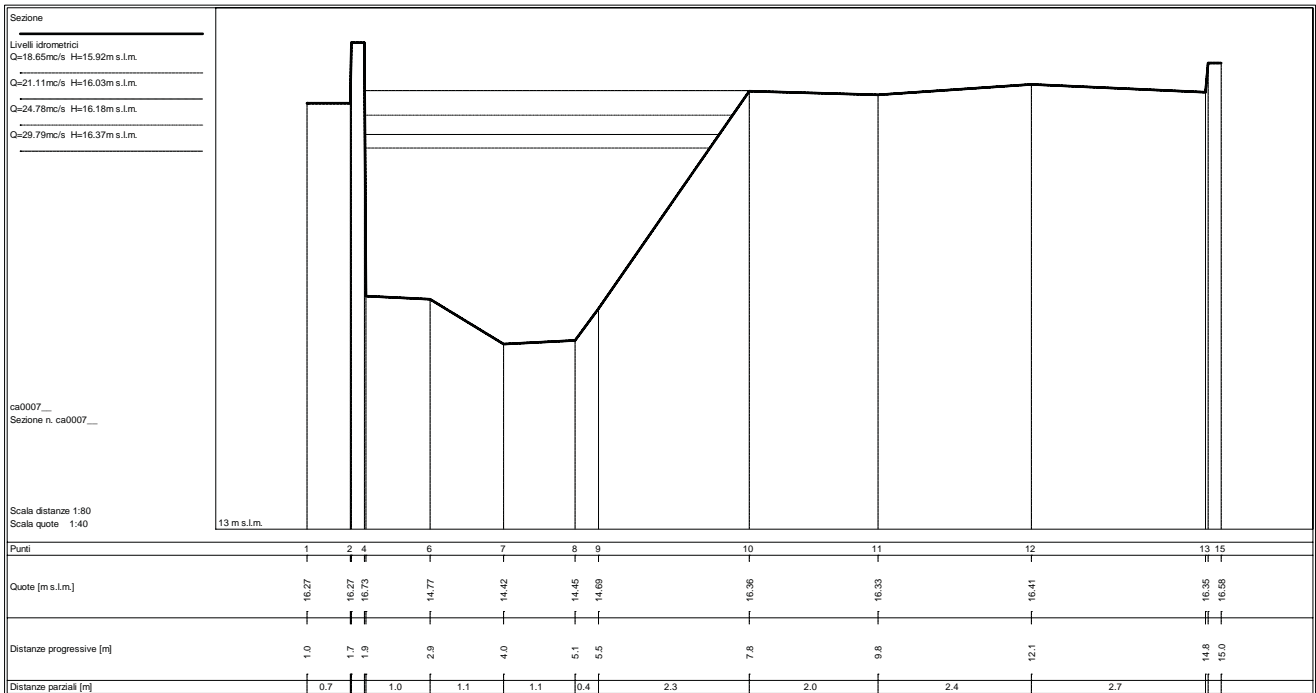
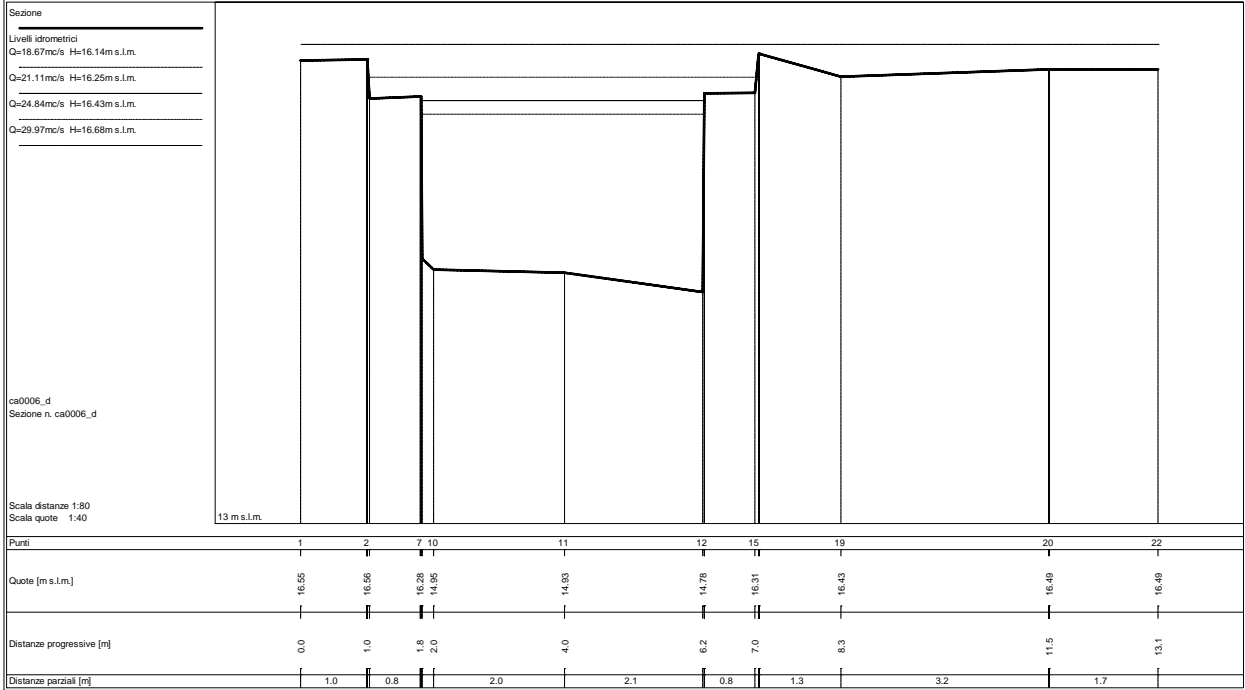

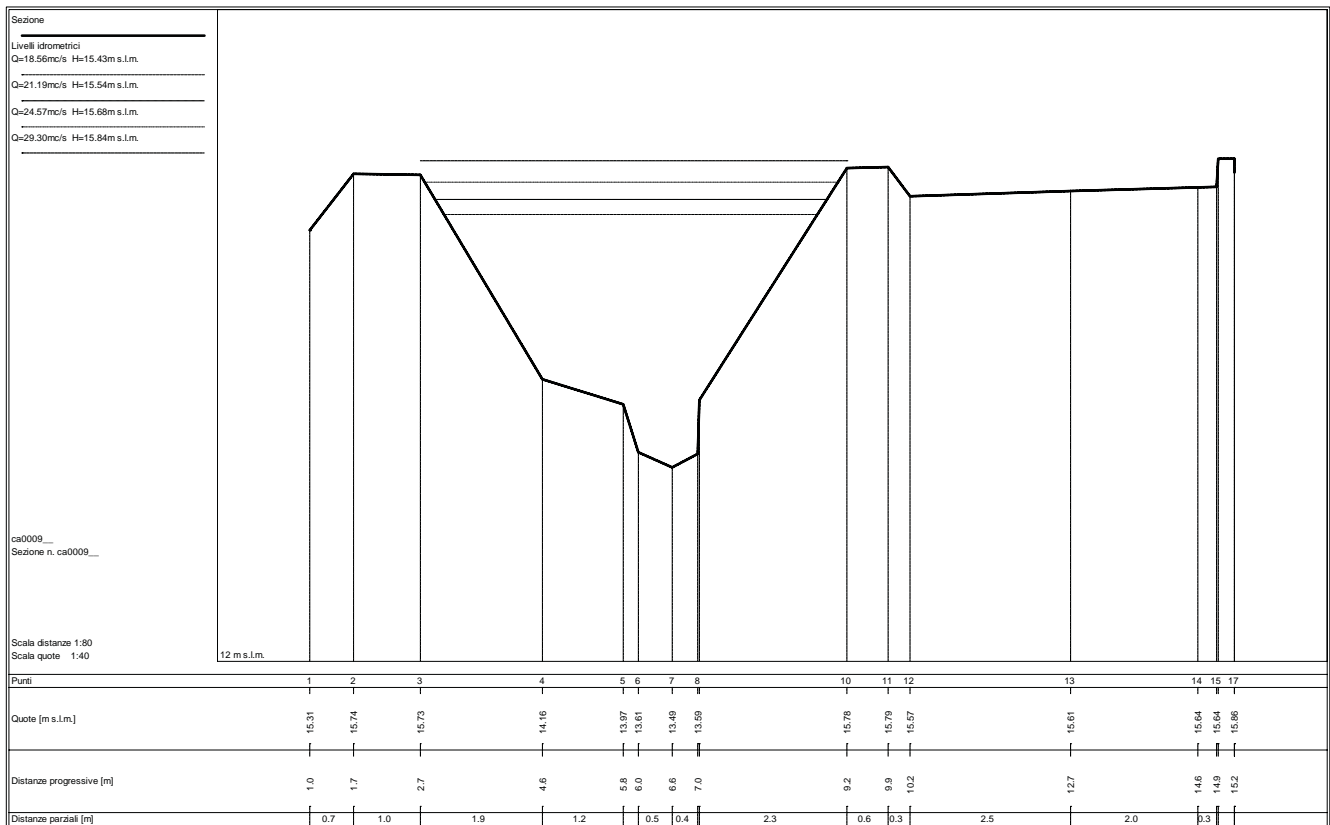
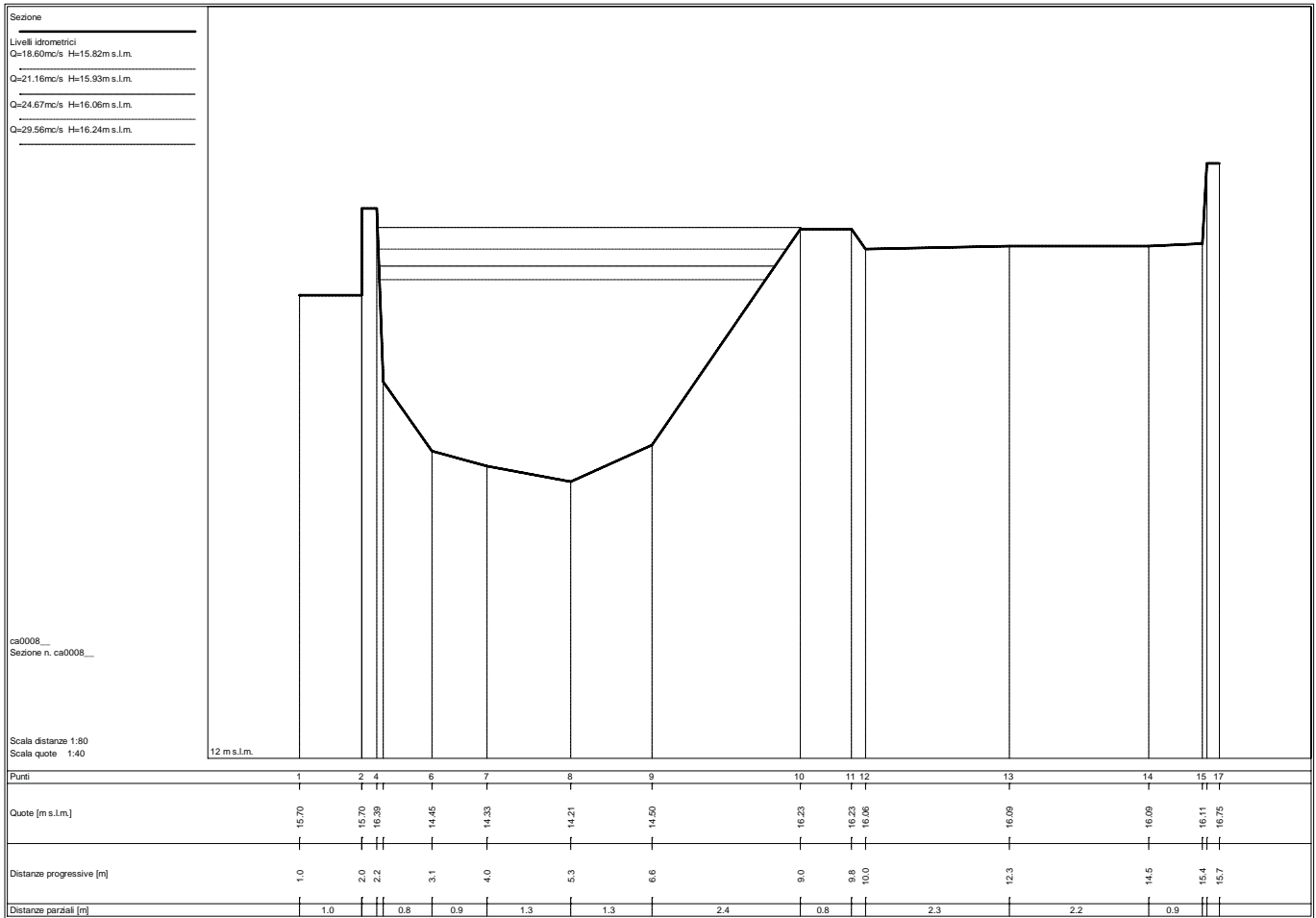

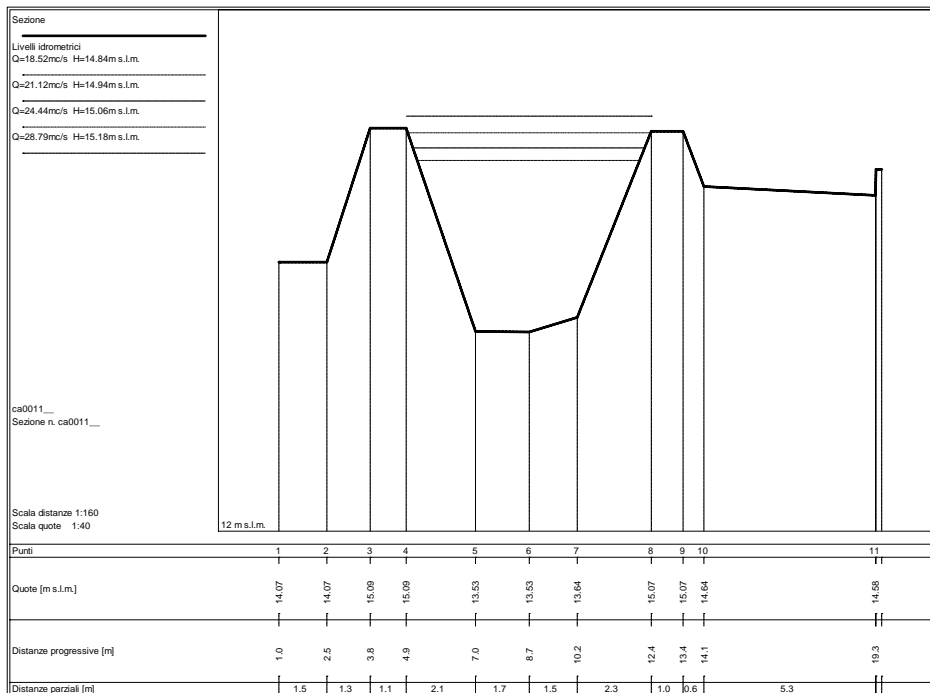
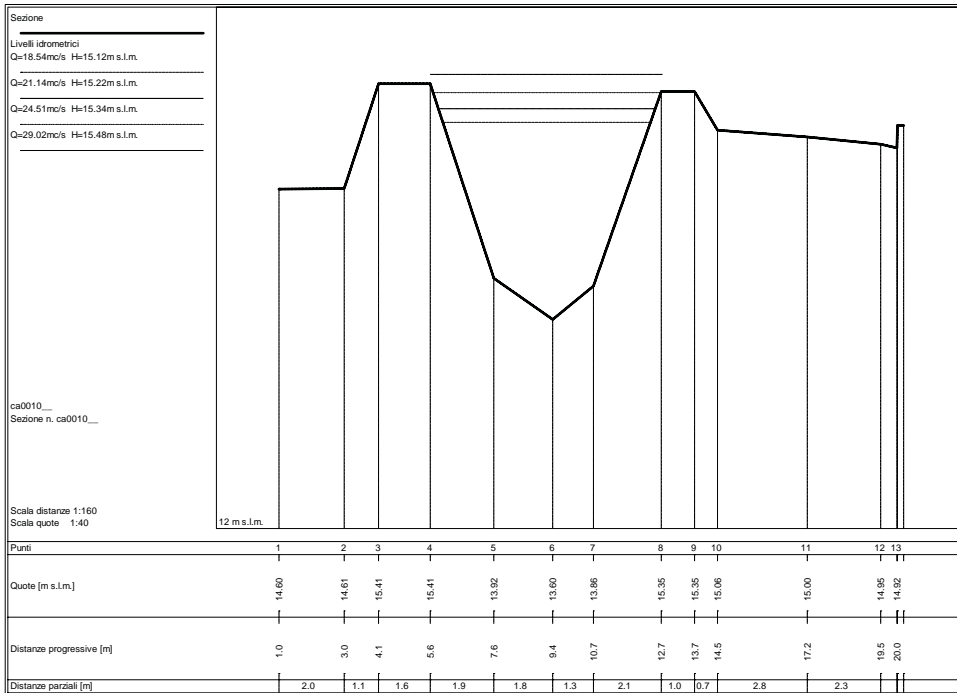

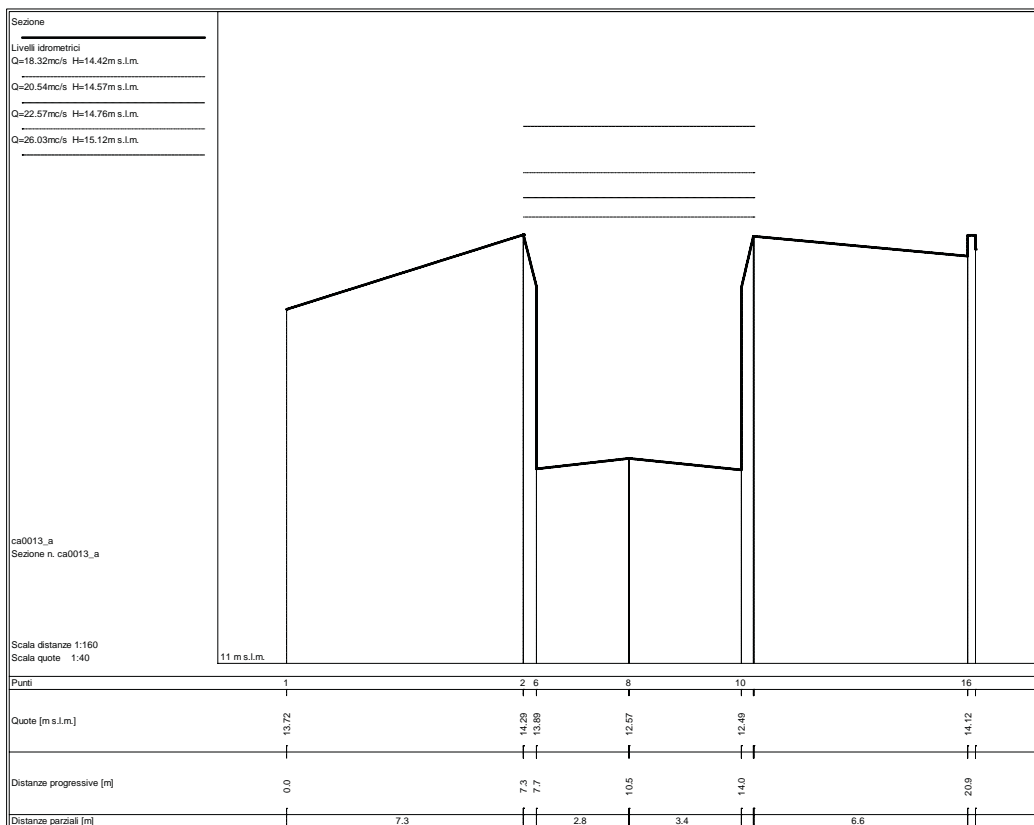
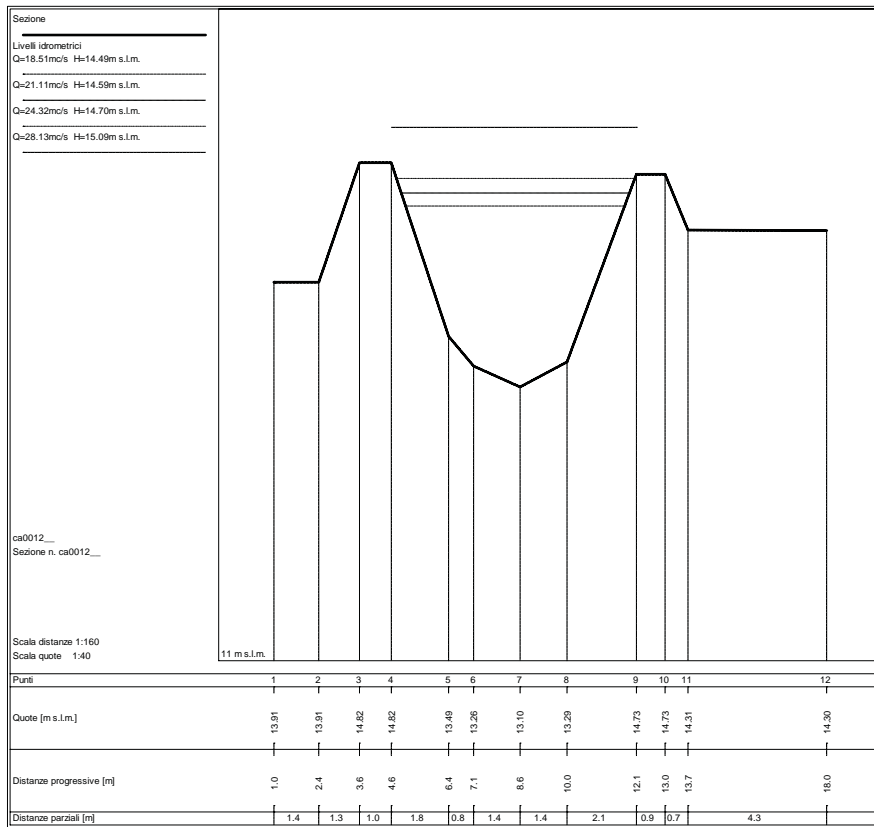

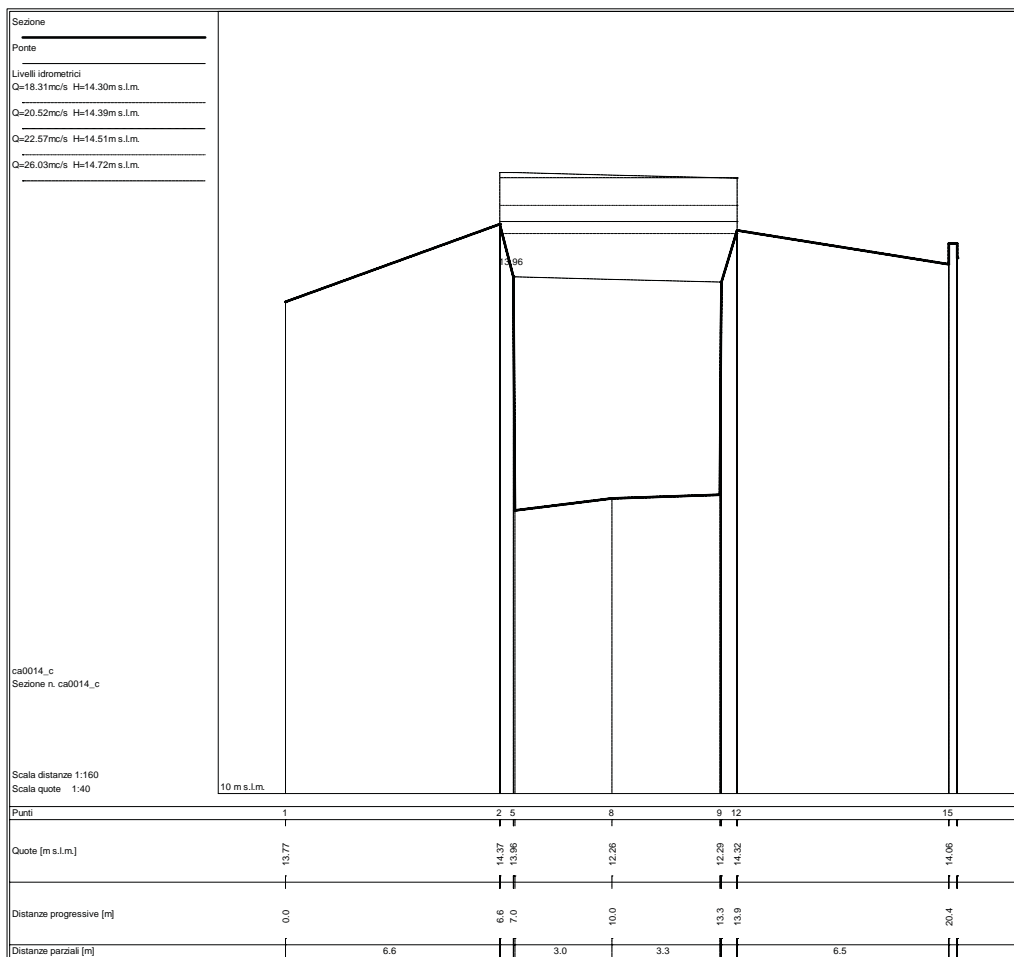
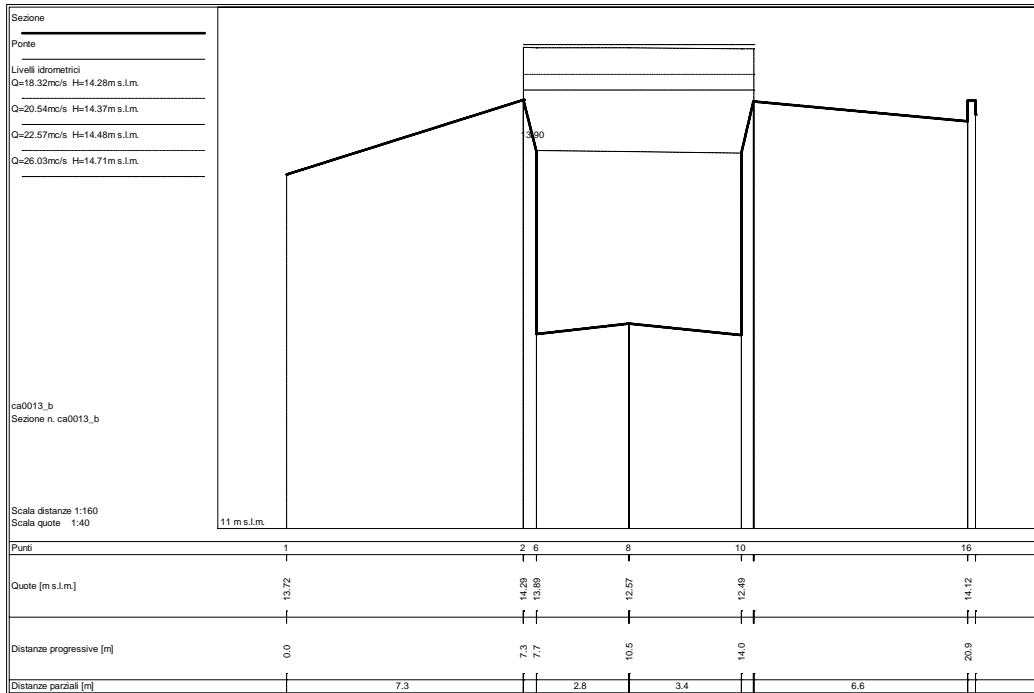

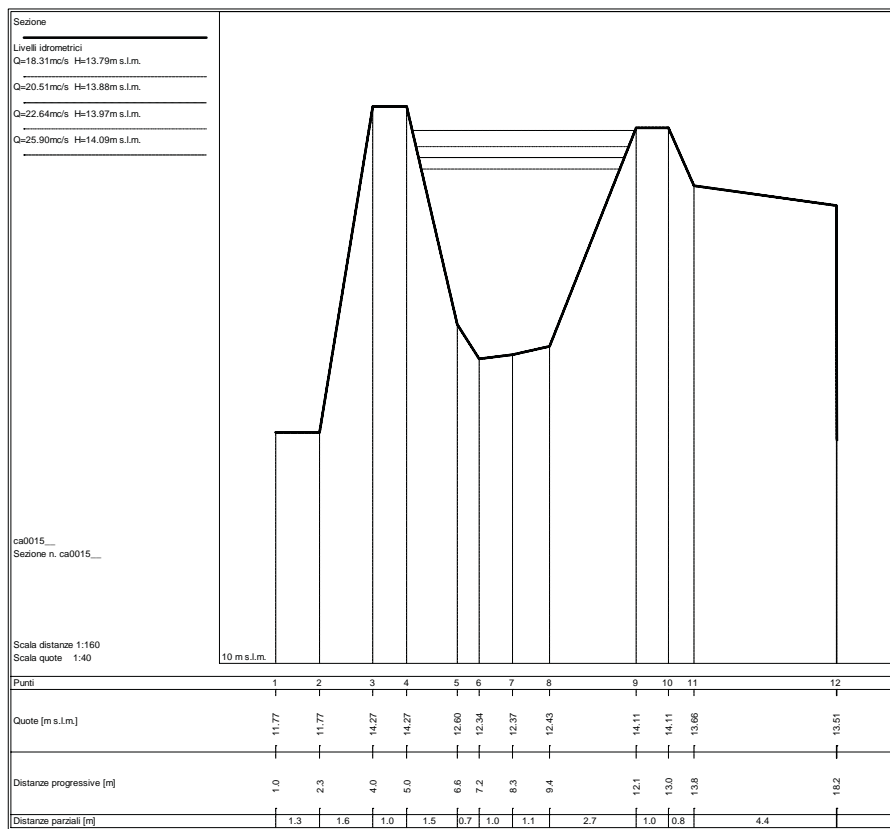
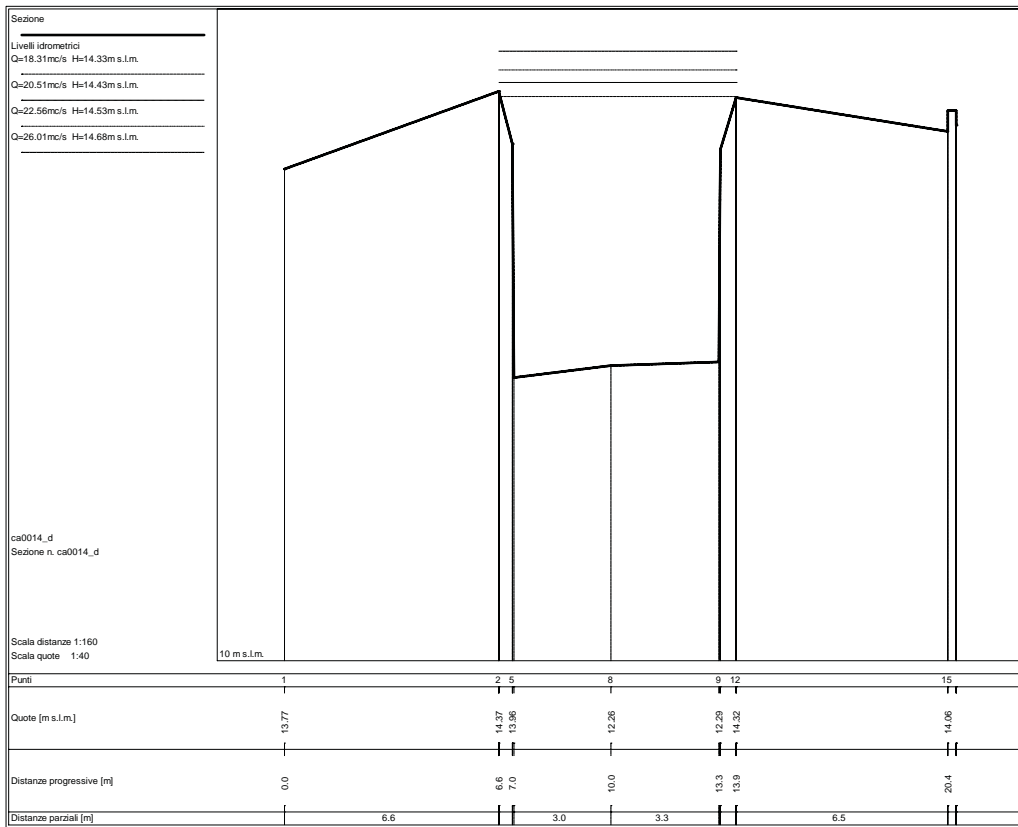

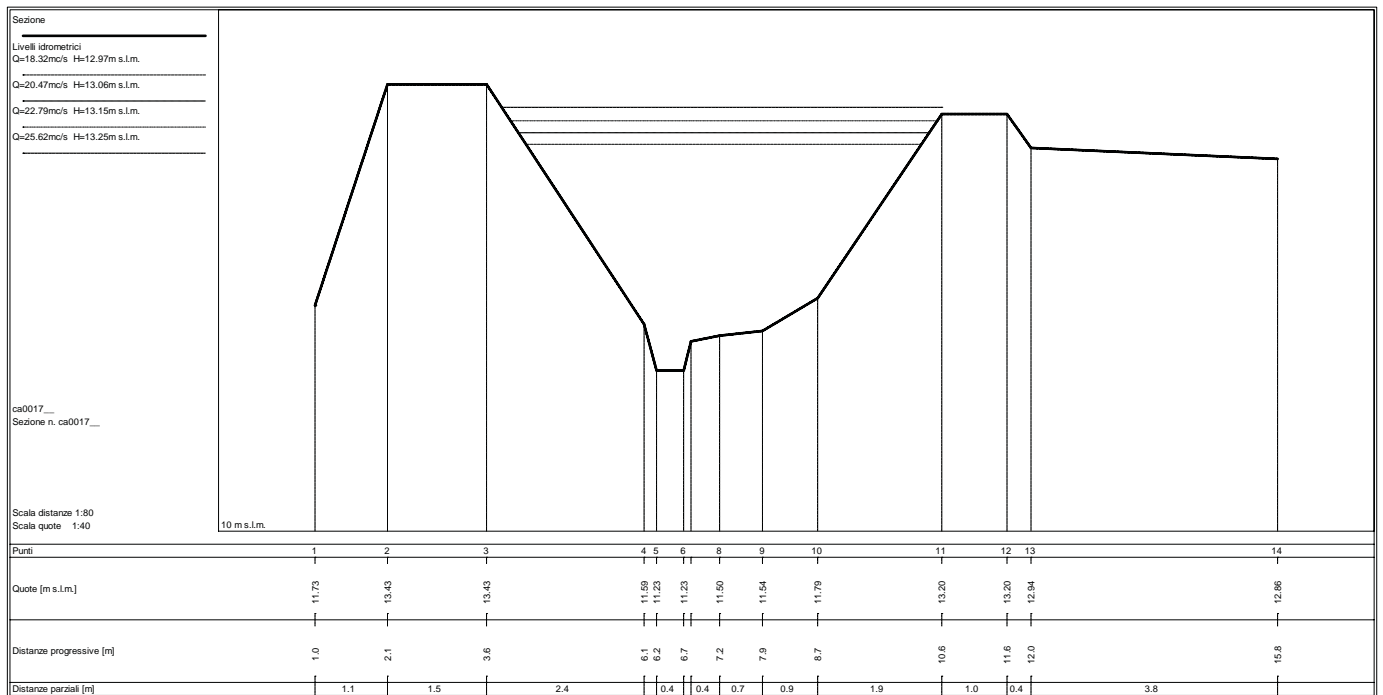
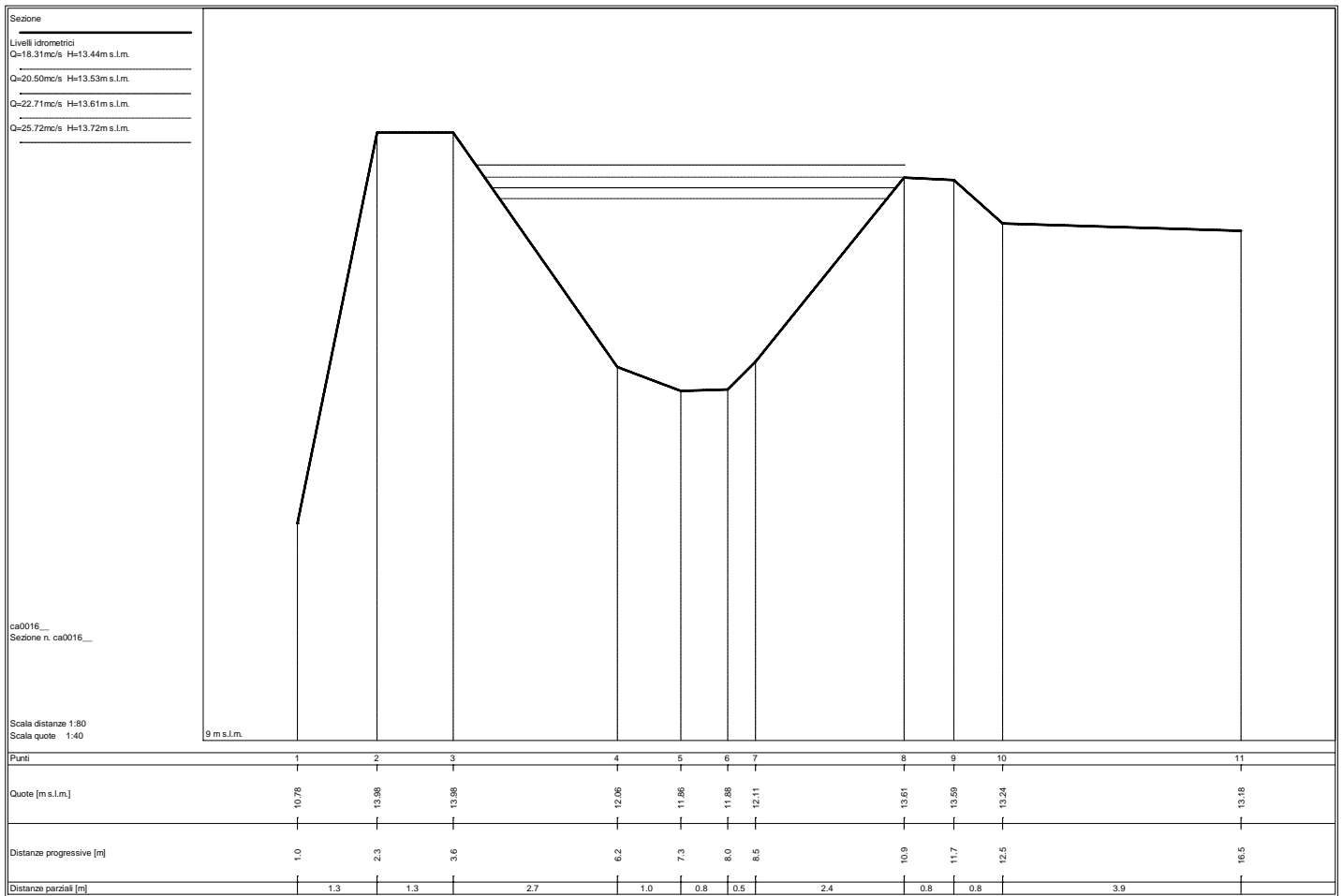

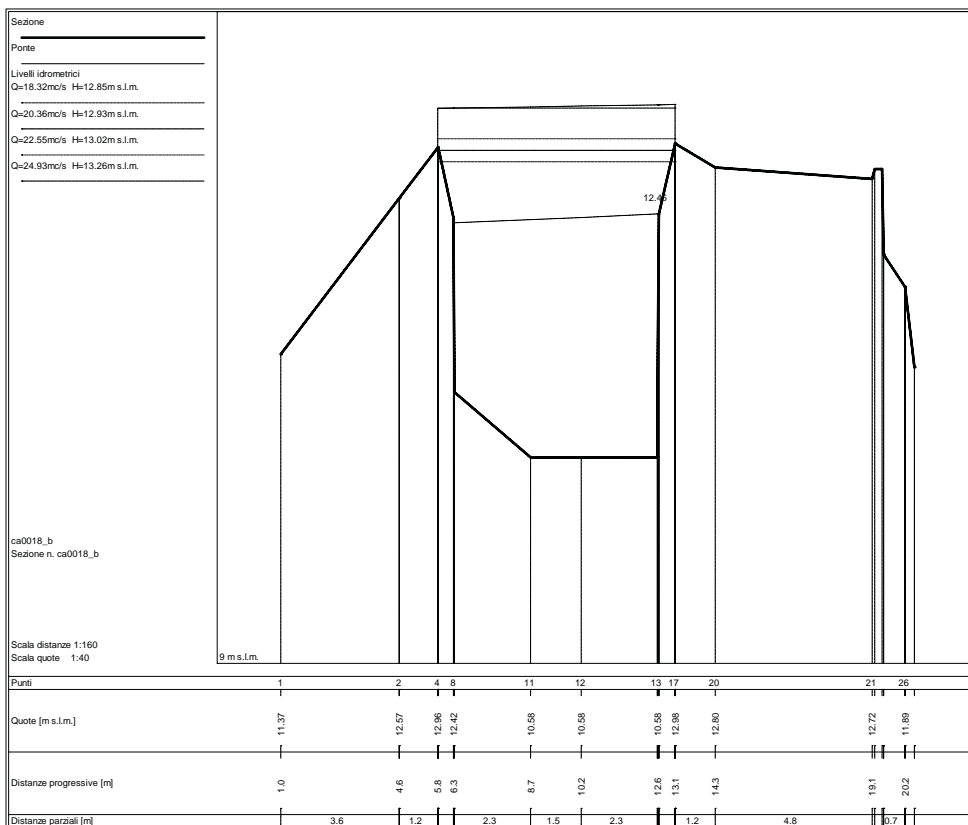
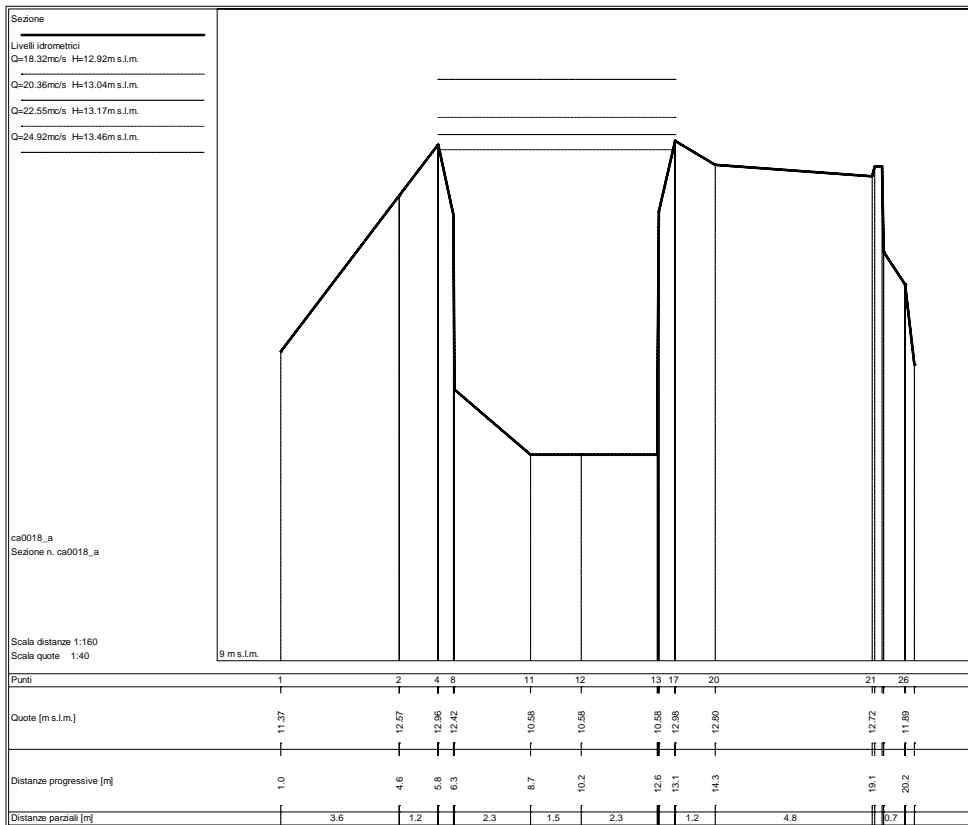

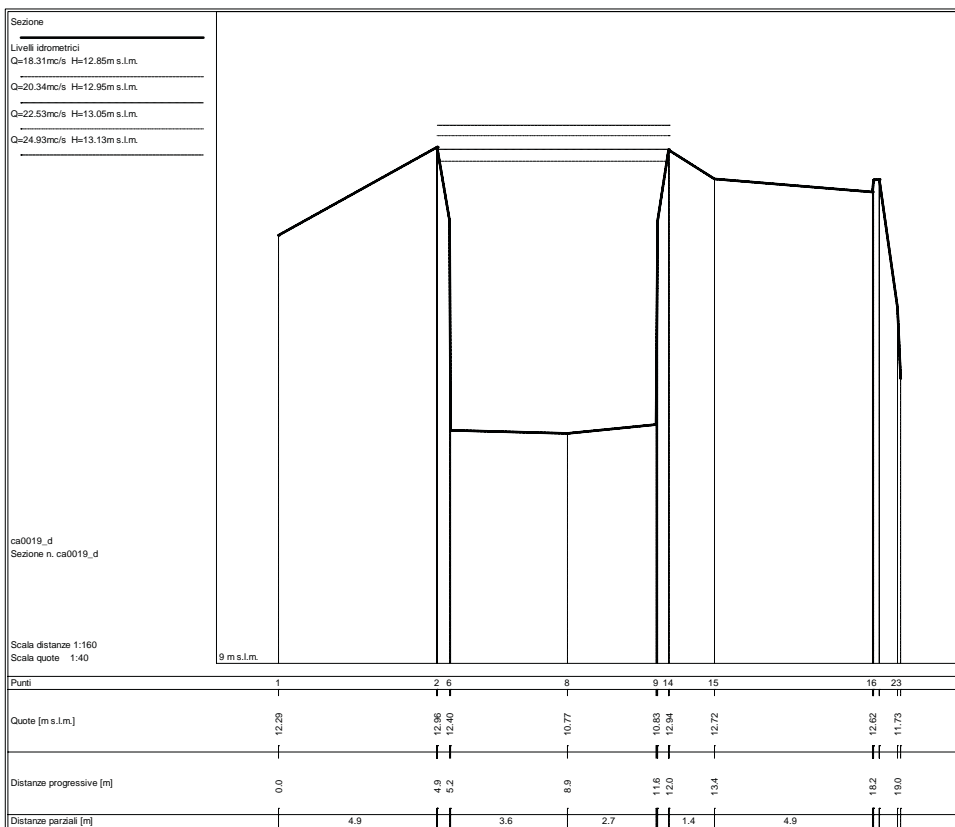
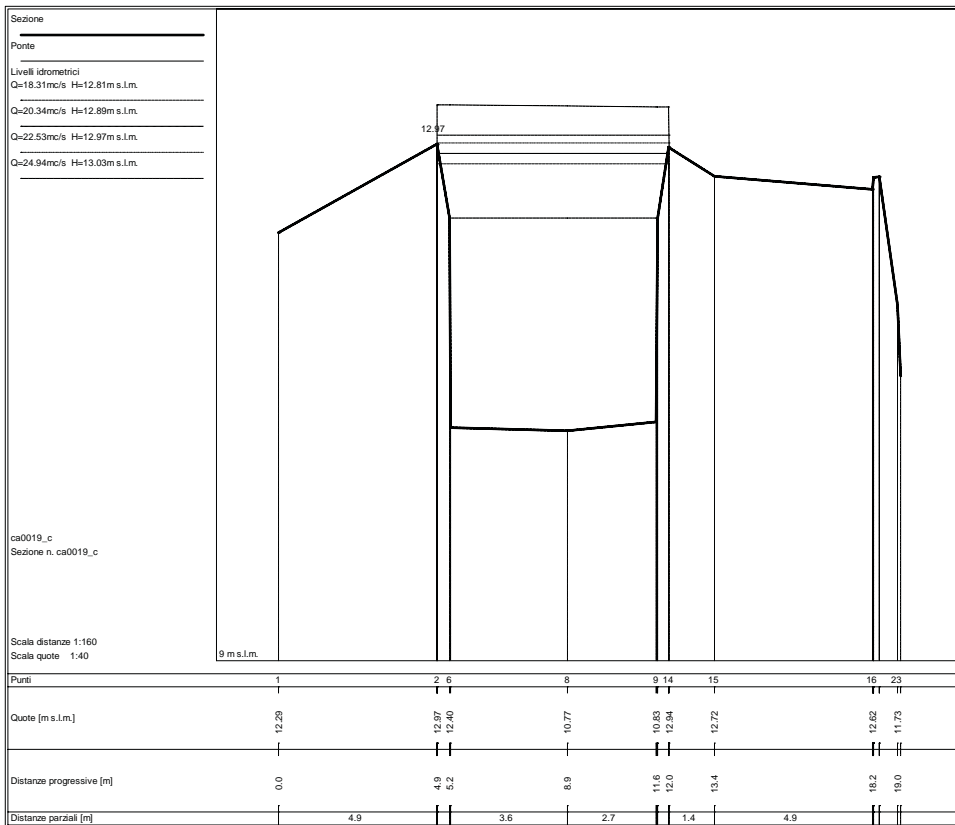

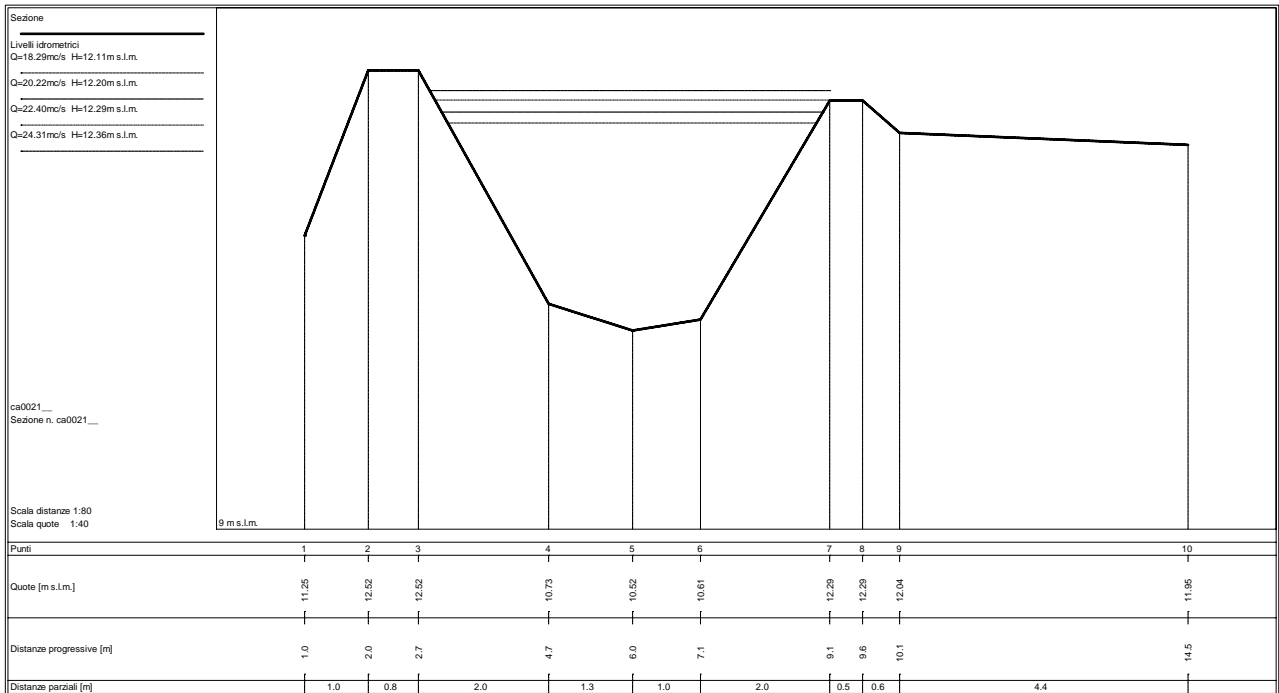
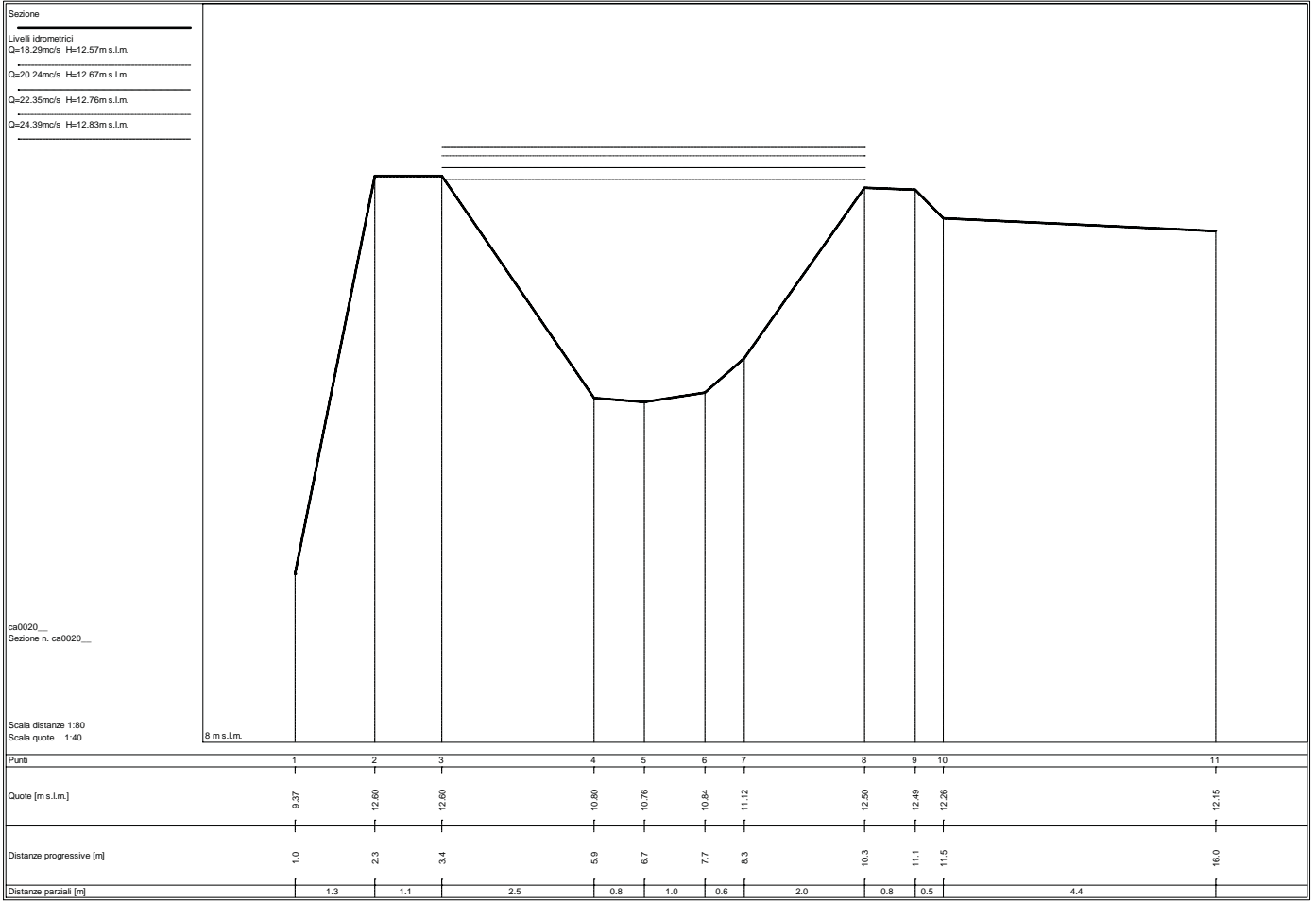

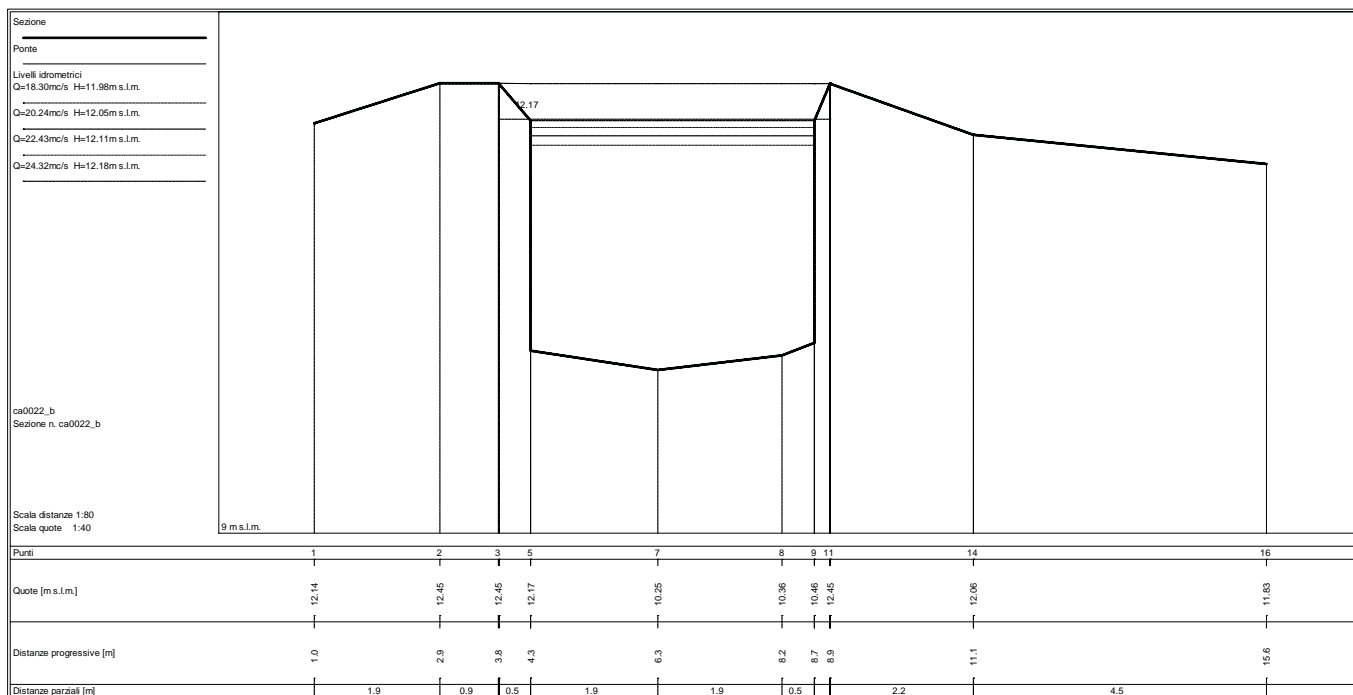
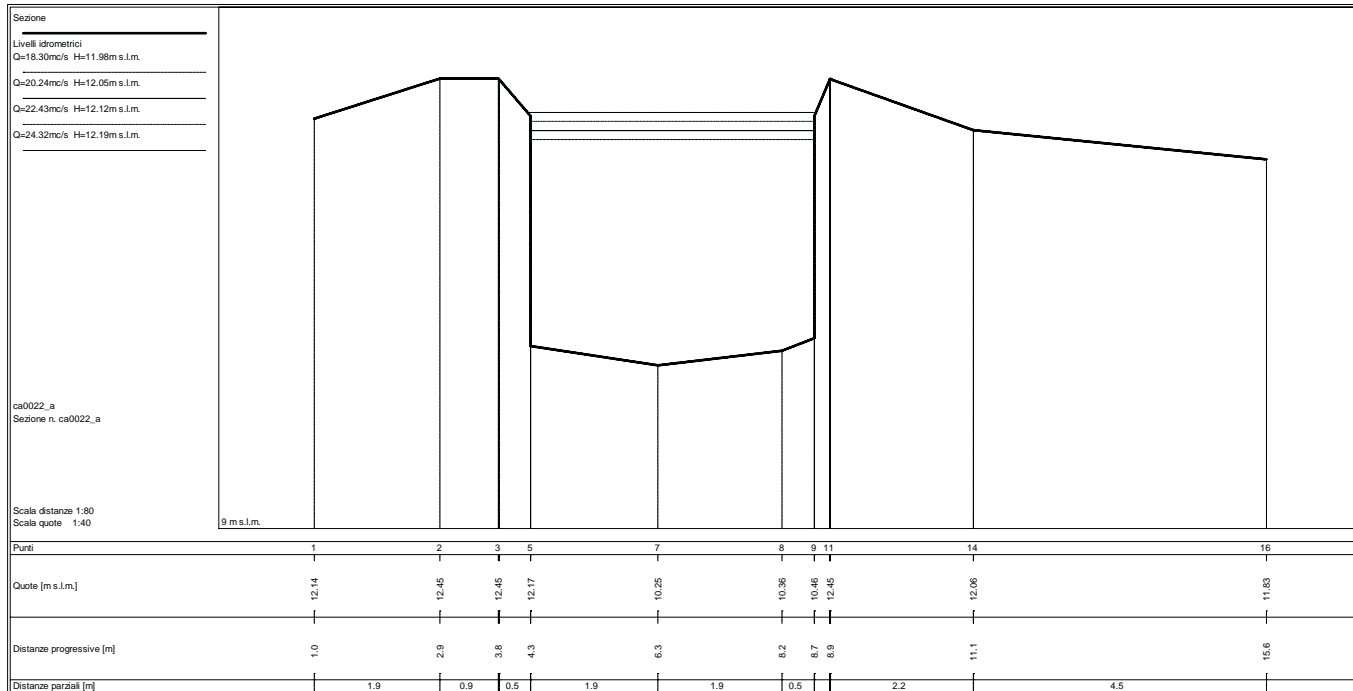

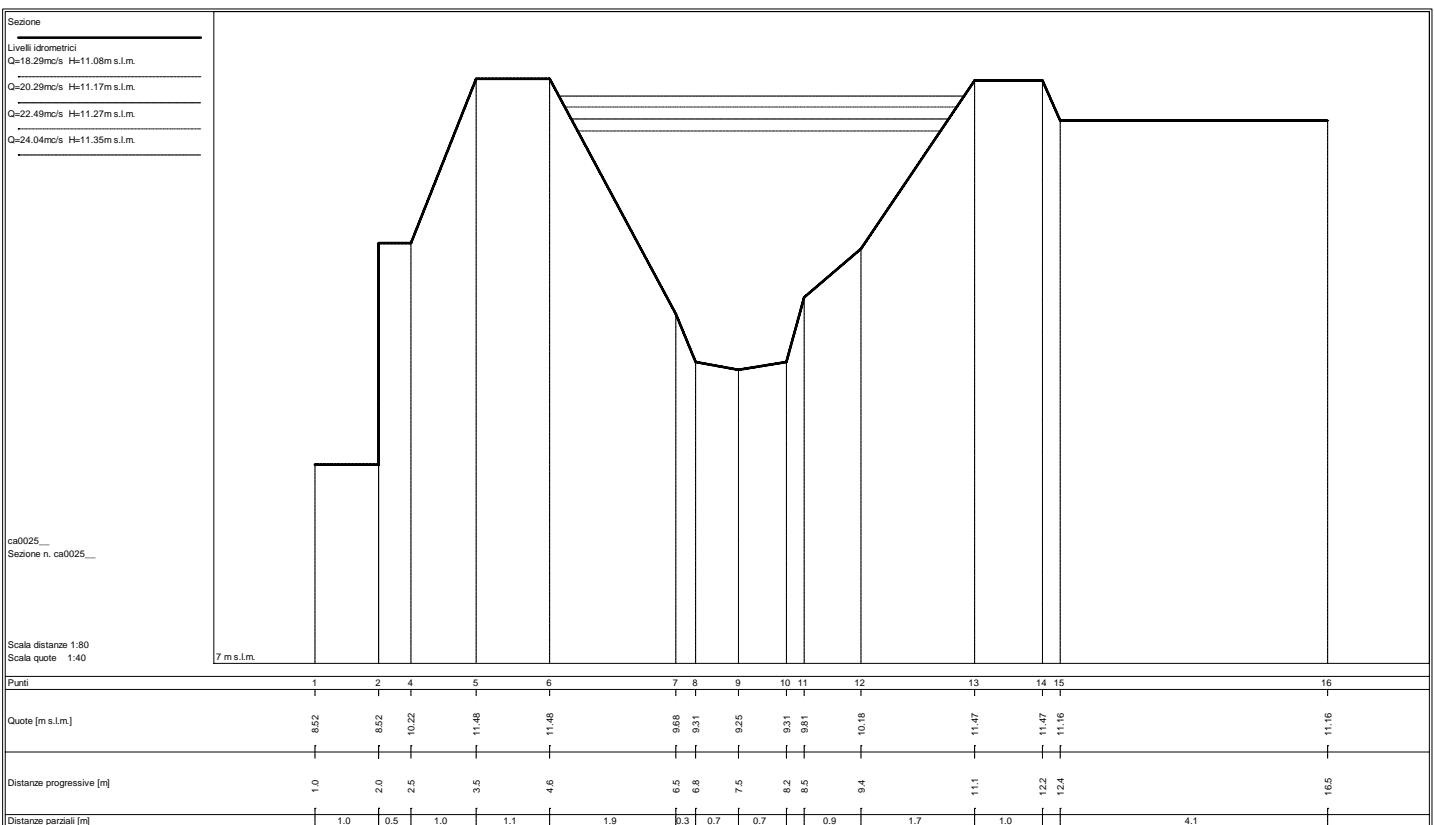
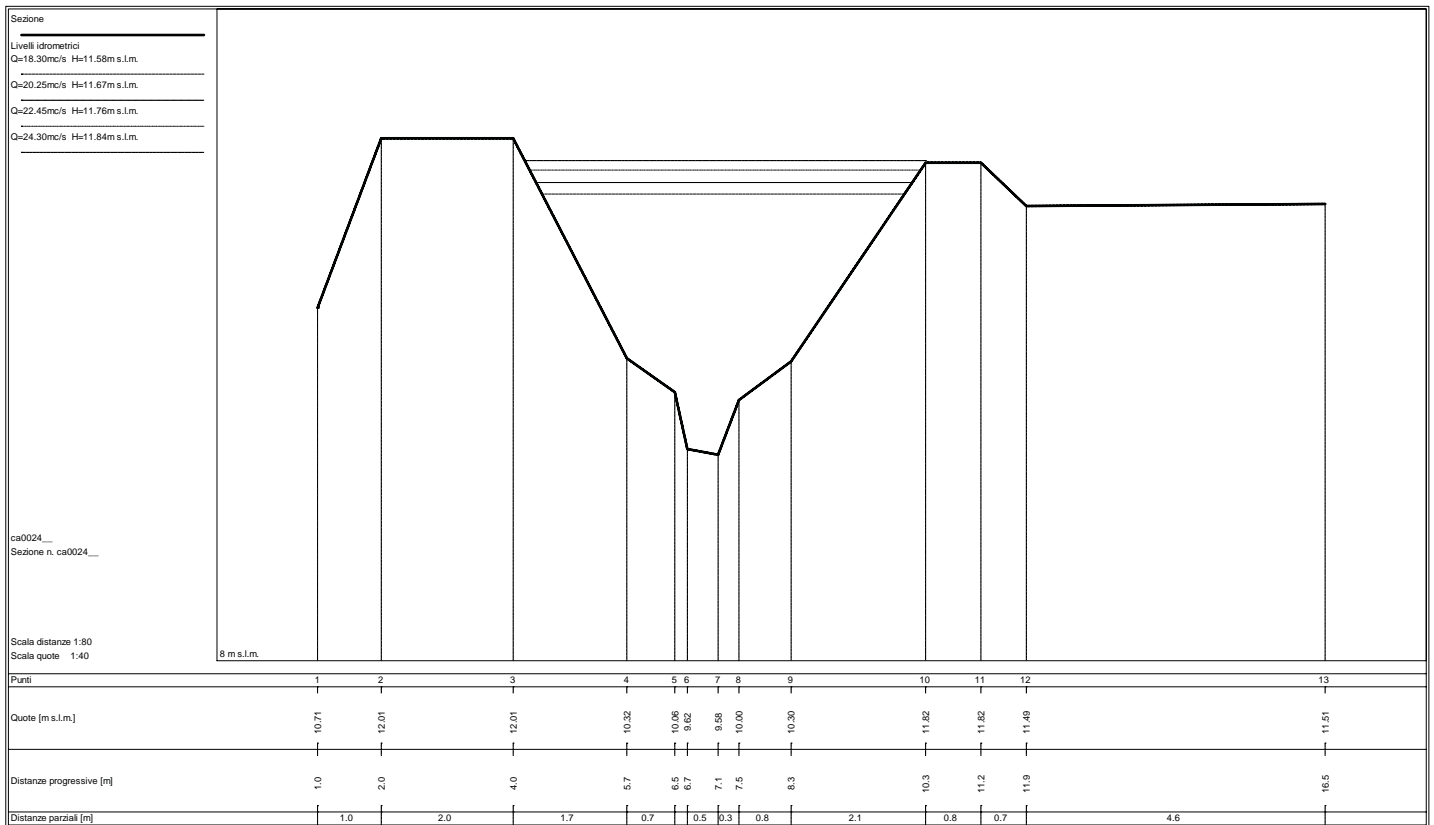

Sezione

 Livelli idrometrici
 Q=18.28mc/s H=10.81m s.l.m.

 Q=20.32mc/s H=10.90m s.l.m.

 Q=22.43mc/s H=11.14m s.l.m.

 Q=23.47mc/s H=11.20m s.l.m.

ca0026_a
 Sezione n. ca0026_a

Scala distanze 1:80
 Scala quote 1:40

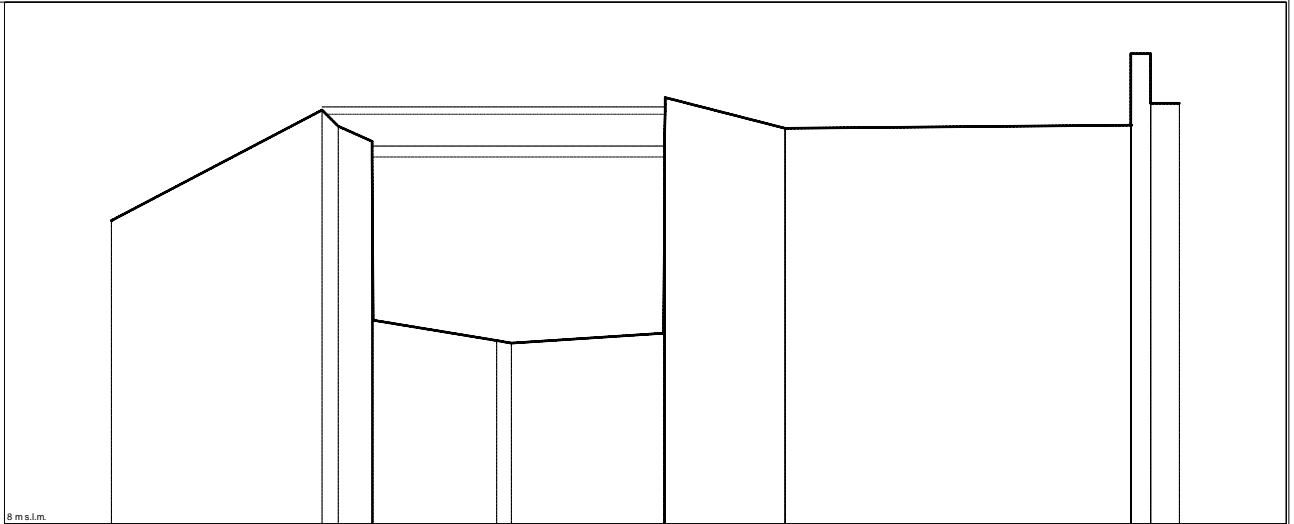

Punti	1	2	3	4	7	8	9	15	17	21	24
Quote [m s.l.m.]	10.32	11.17	11.05	10.93	9.40	9.38	9.46	11.03	11.06	11.61	11.23
Distanze progressive [m]	0.0	3.2	3.5	4.0	5.9	6.1	8.5	10.3	15.6	15.9	16.4
Distanze parziali [m]		3.2	0.5		1.9		2.3		1.8		5.3

Sezione

 Livelli idrometrici
 Q=18.28mc/s H=10.78m s.l.m.

 Q=20.32mc/s H=10.85m s.l.m.

 Q=22.42mc/s H=10.97m s.l.m.

 Q=23.47mc/s H=10.99m s.l.m.

ca0026_b
 Sezione n. ca0026_b

Scala distanze 1:80
 Scala quote 1:40

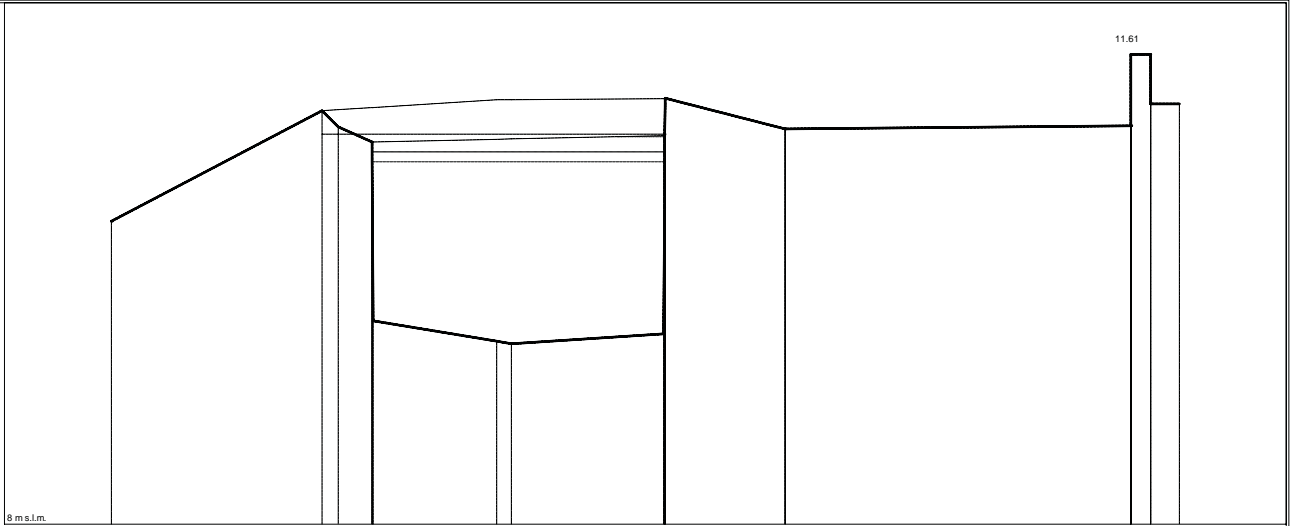

Punti	1	2	3	4	7	8	9	14	16	20	23
Quote [m s.l.m.]	10.32	11.17	11.05	10.93	9.40	9.38	9.46	11.03	11.06	11.61	11.23
Distanze progressive [m]	0.0	3.2	3.5	4.0	5.9	6.1	8.5	10.3	15.6	15.9	16.4
Distanze parziali [m]		3.2	0.5		1.9		2.3		1.8		5.3

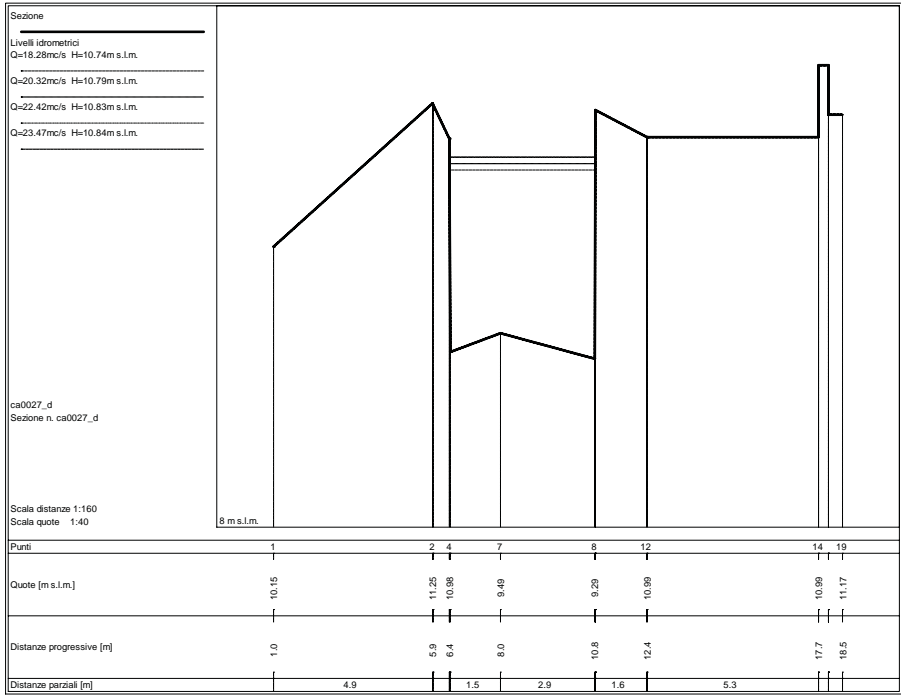
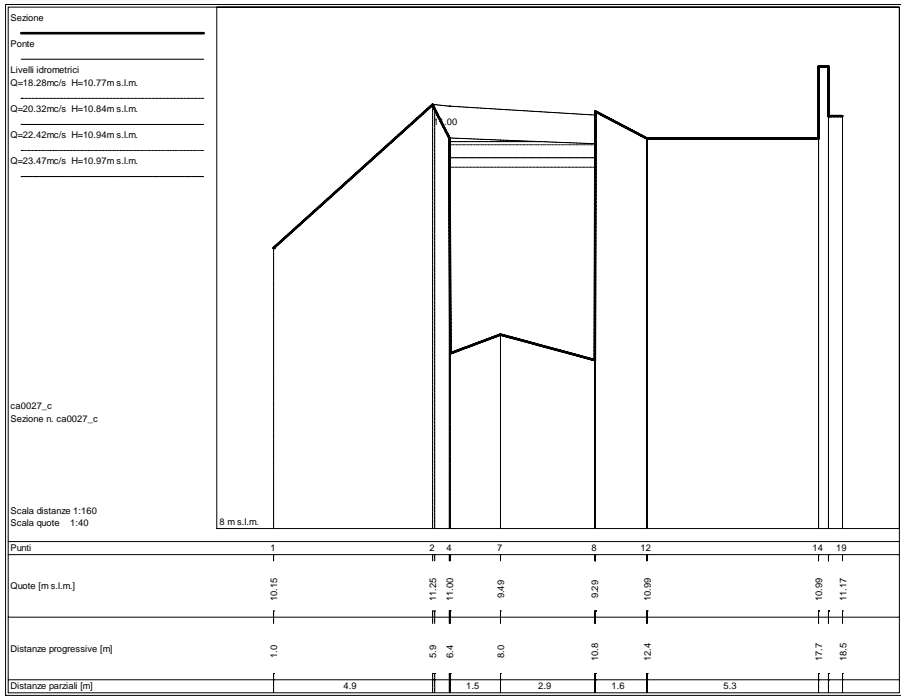

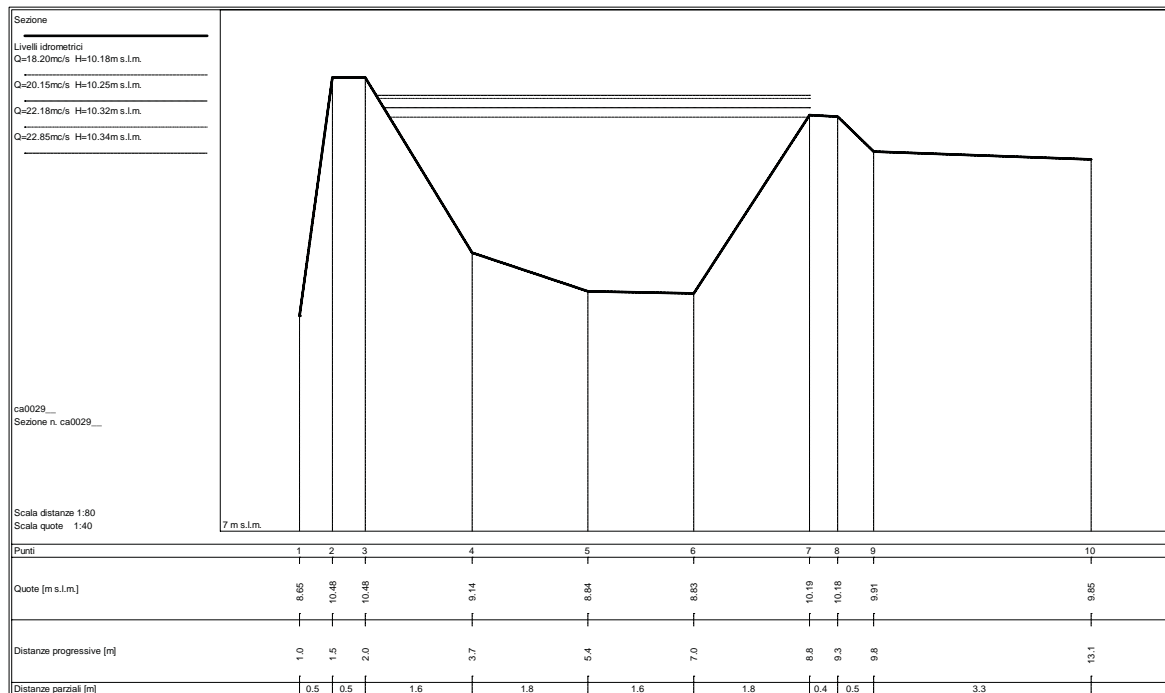
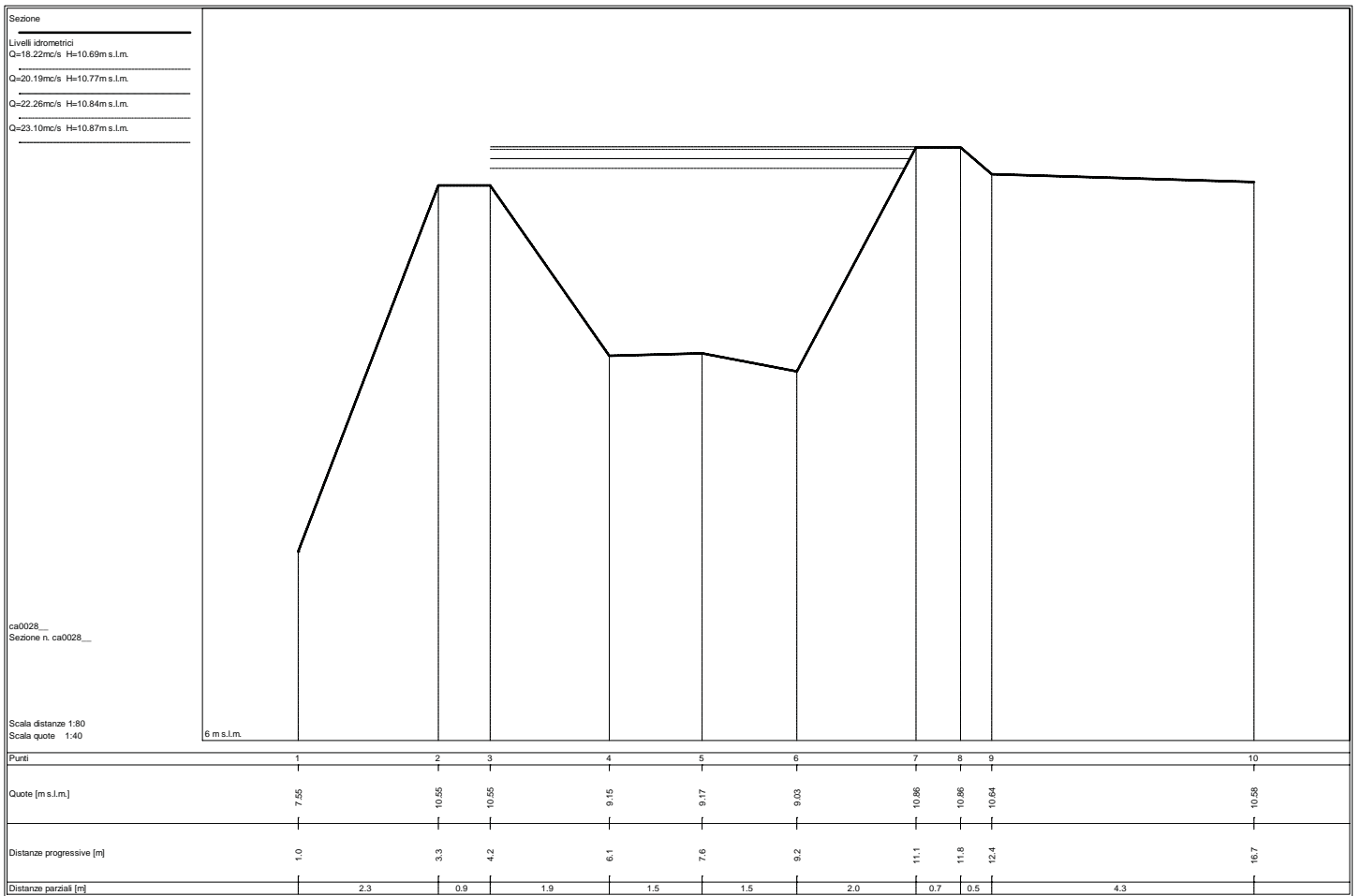

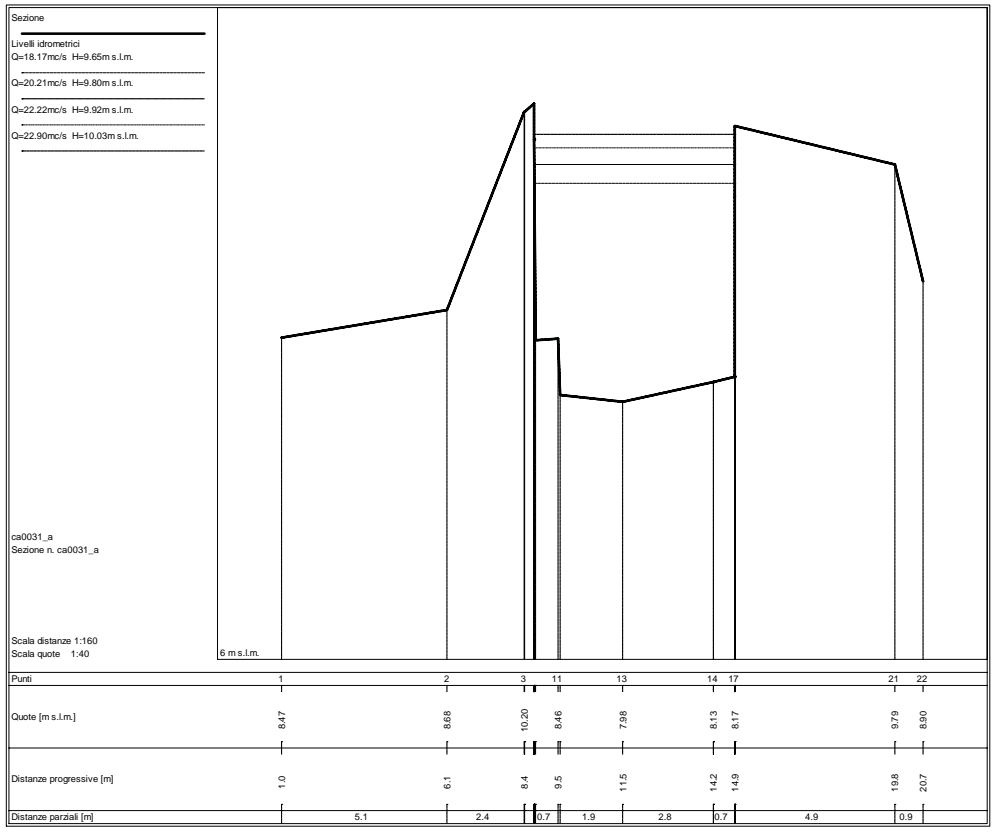
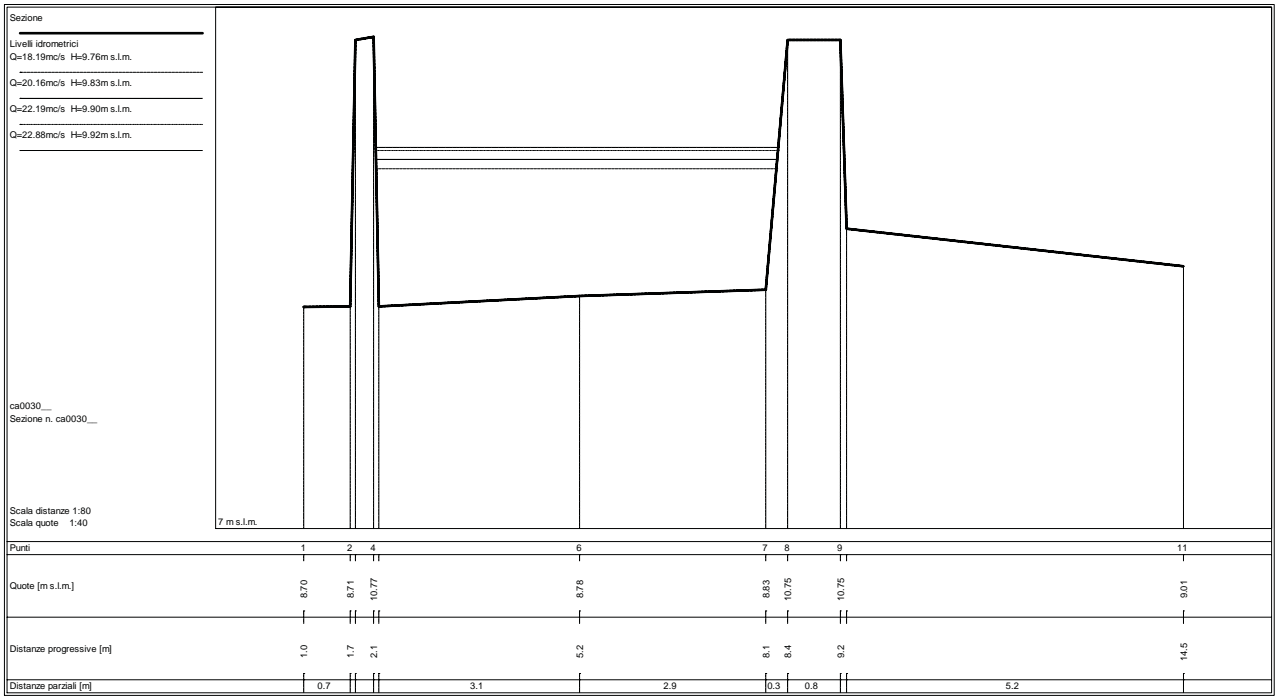

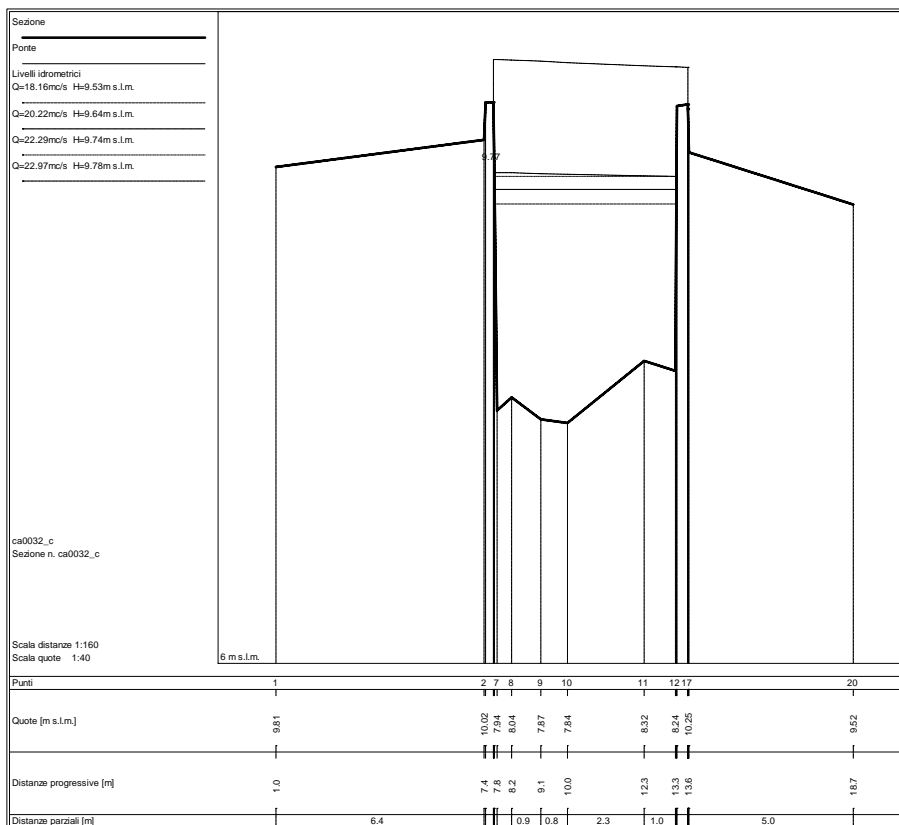
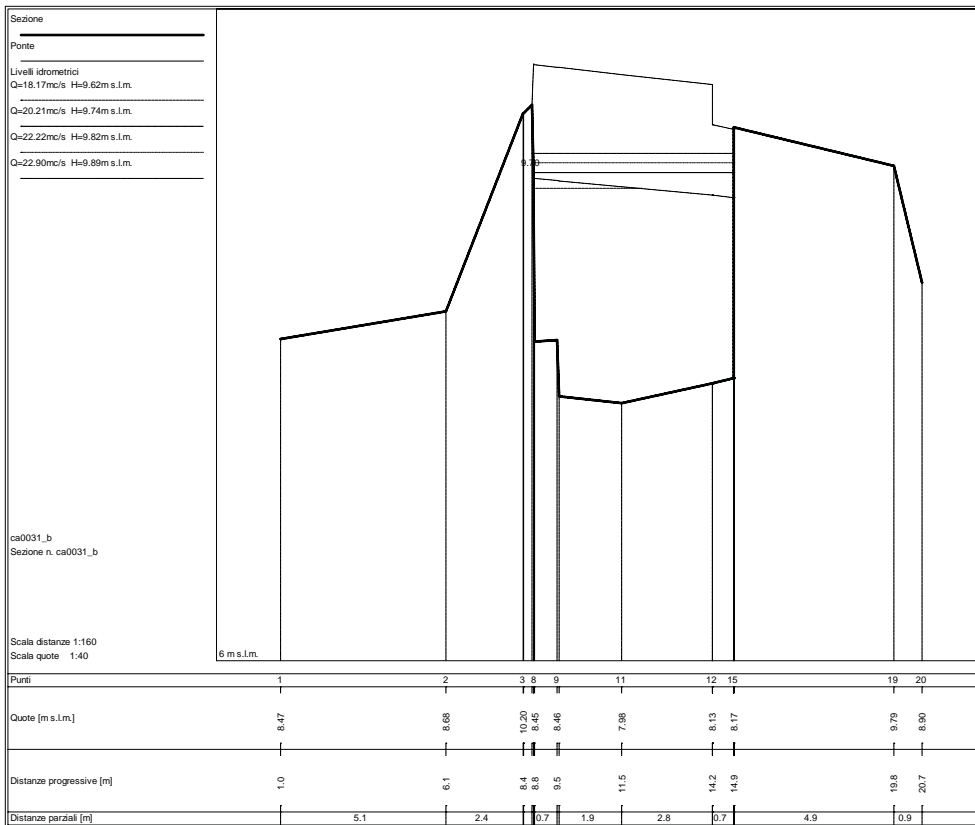

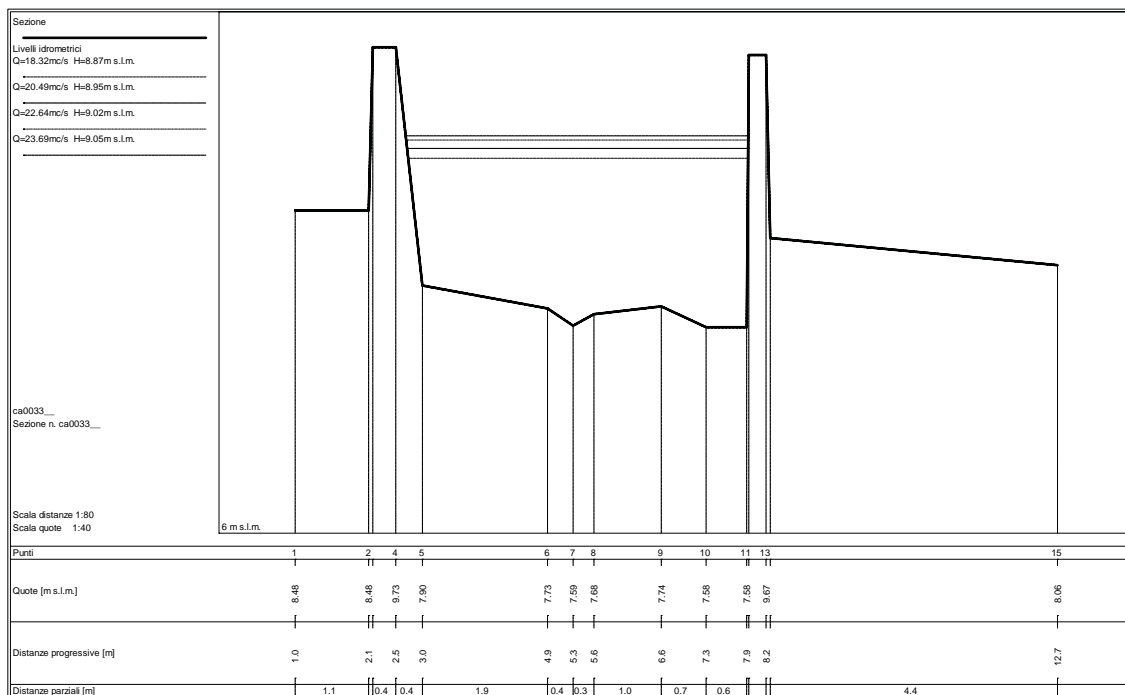
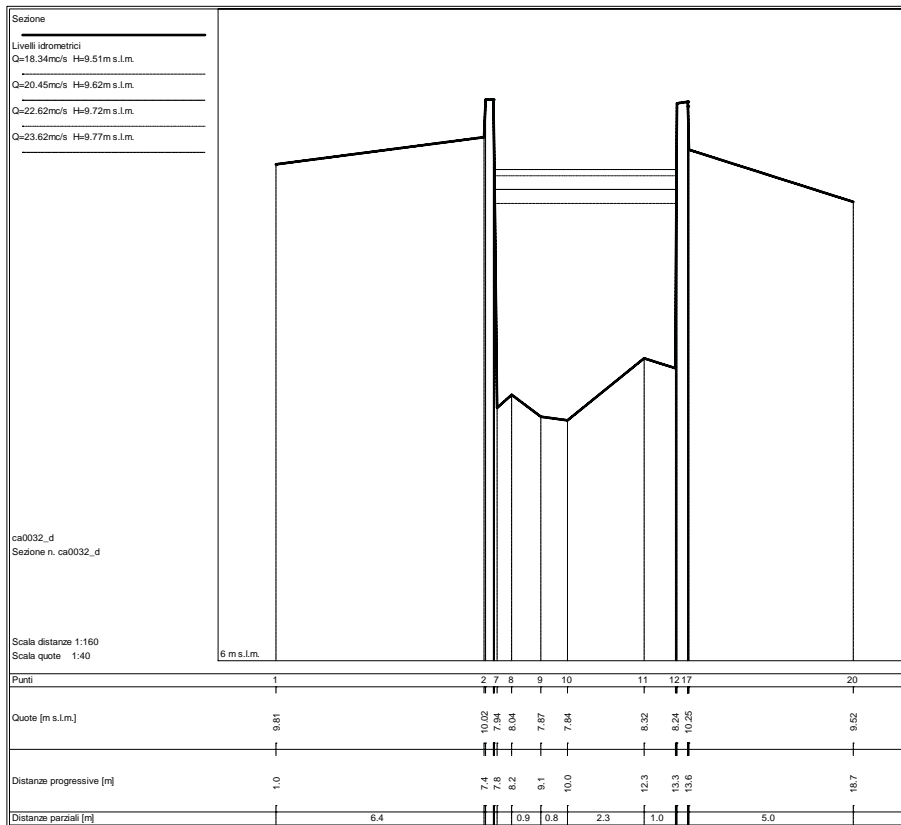

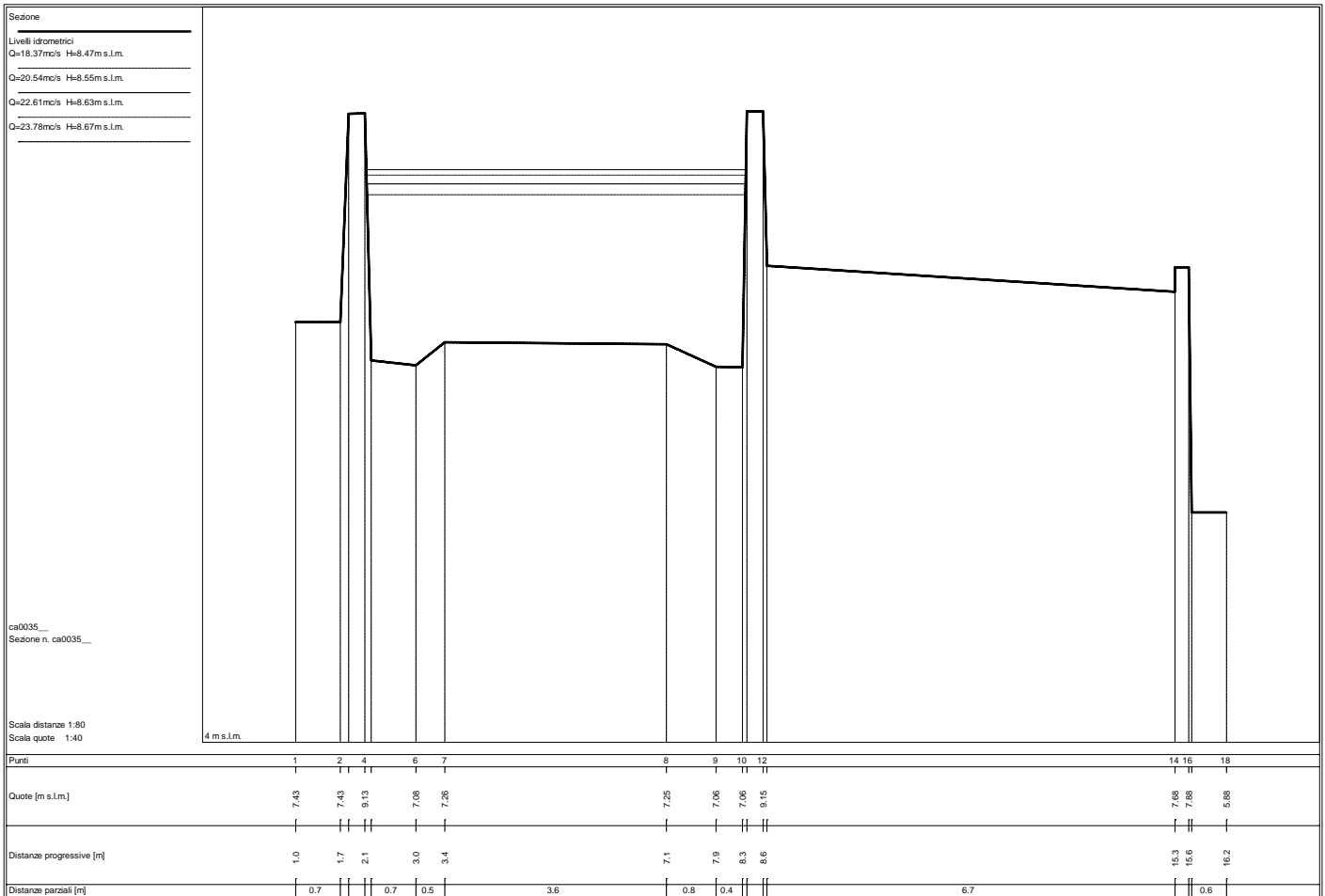
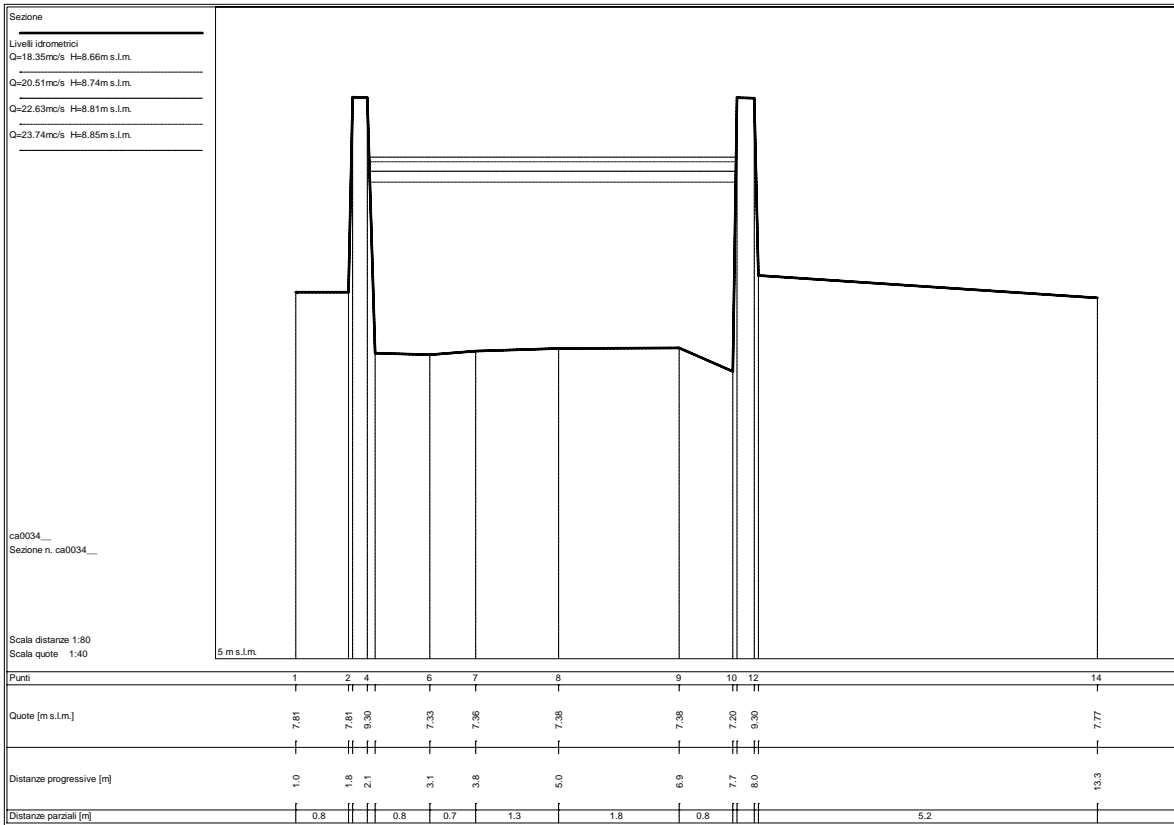

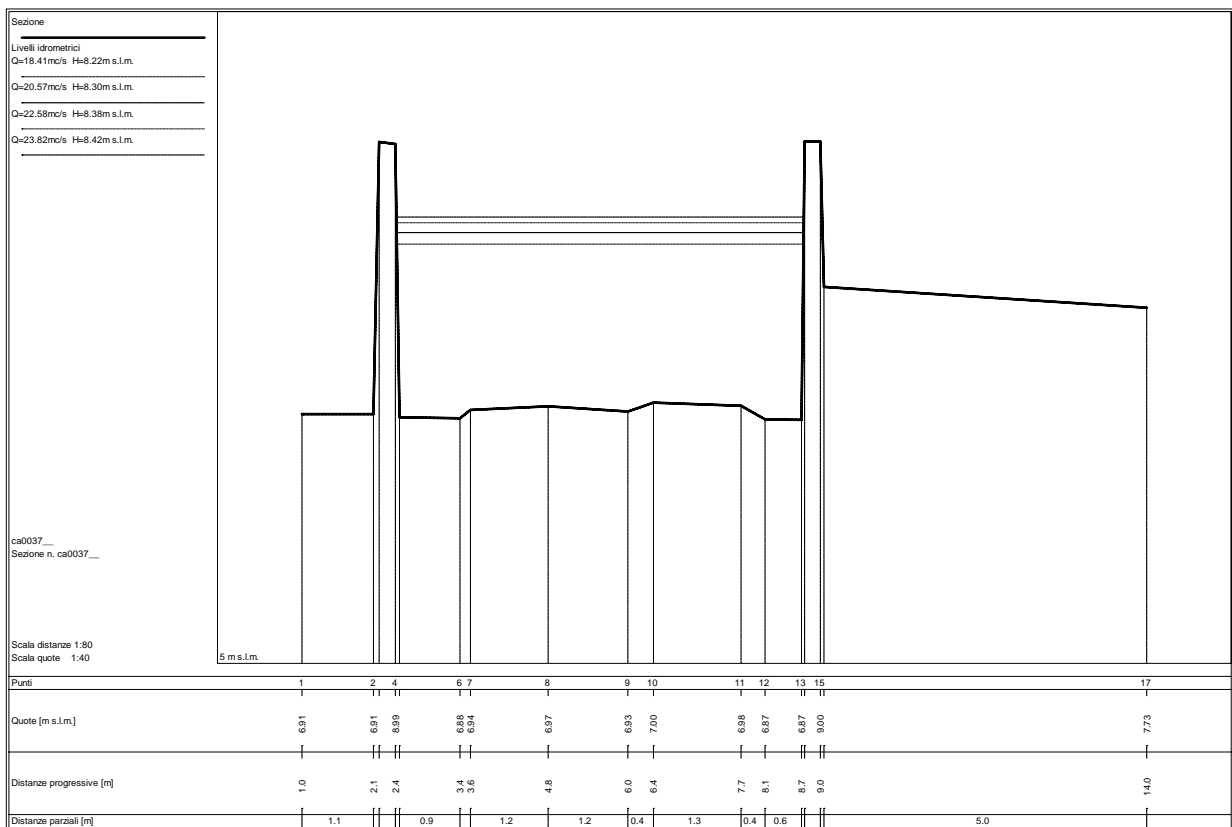
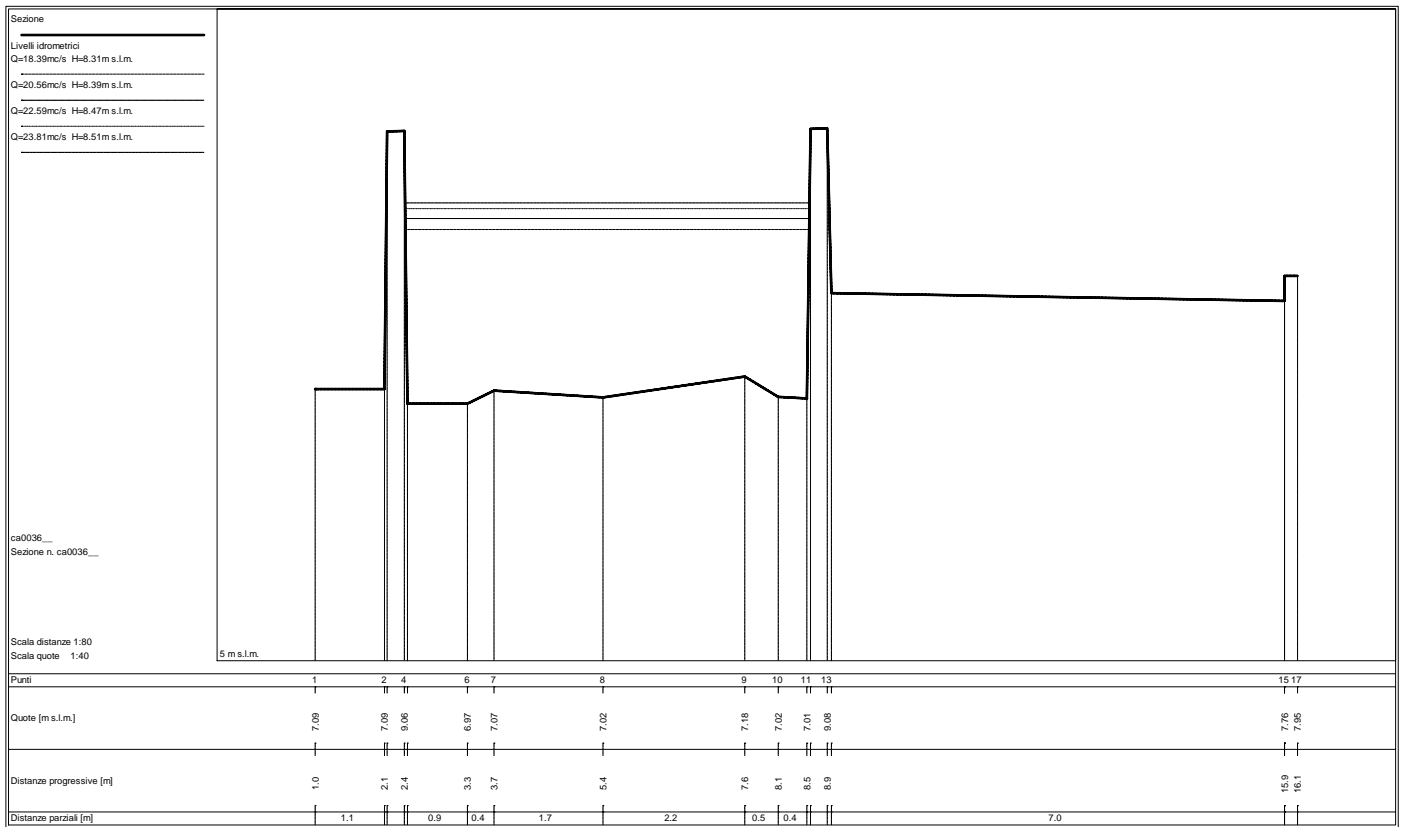

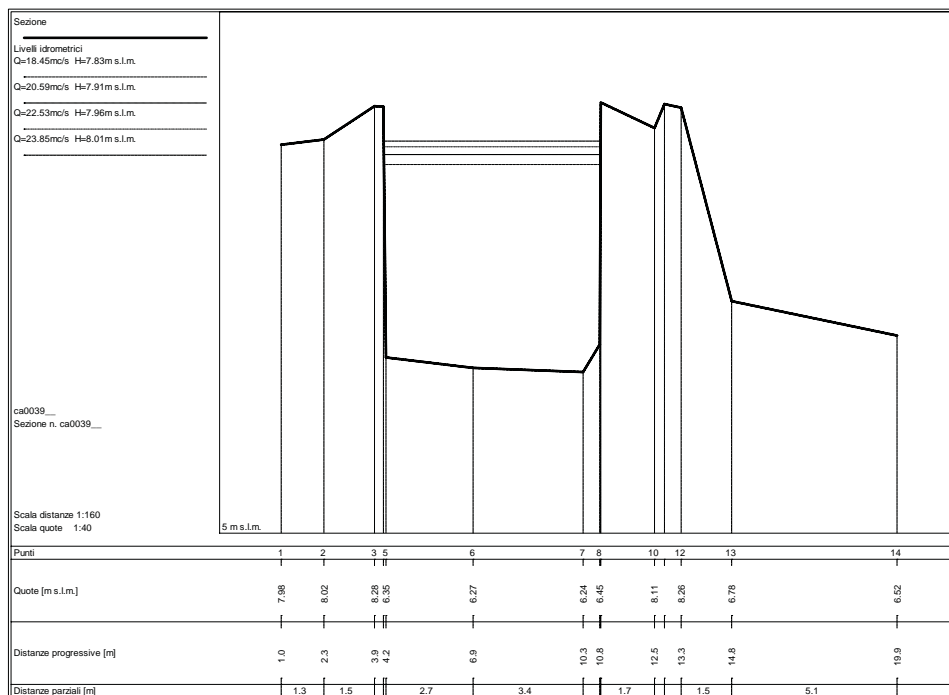
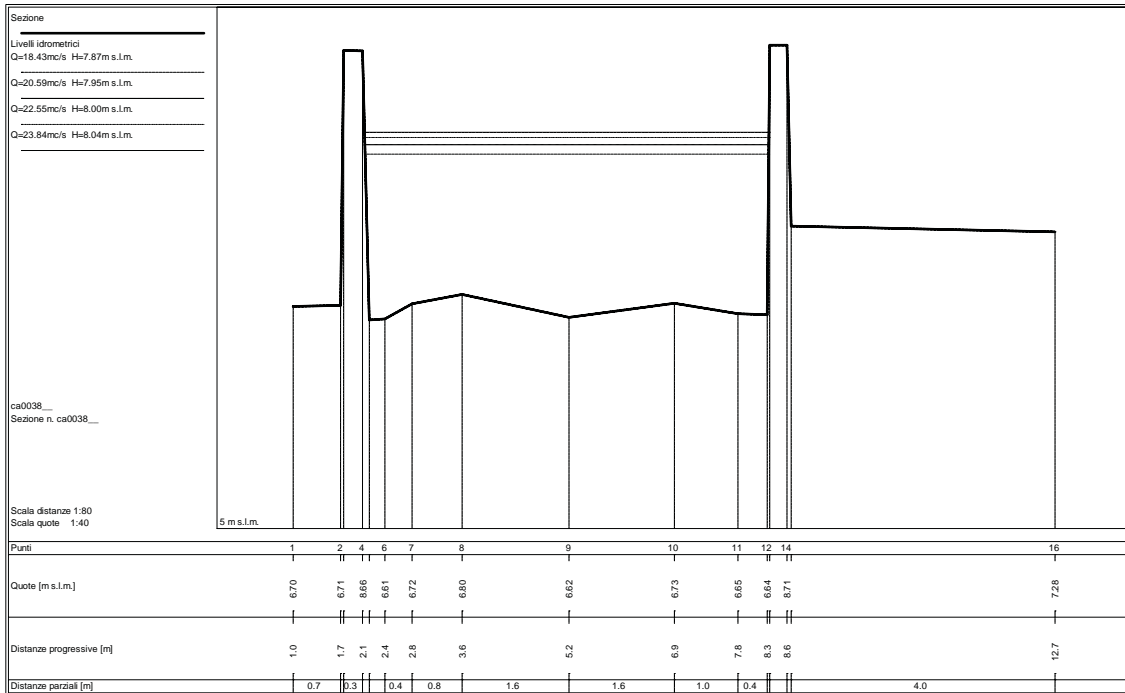

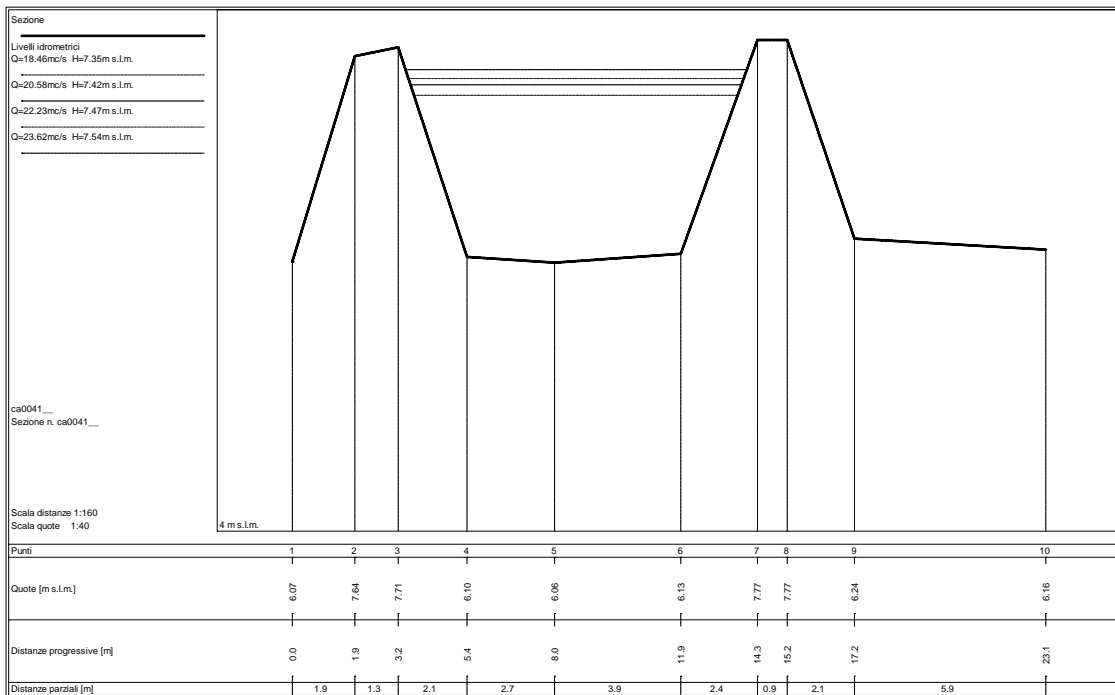
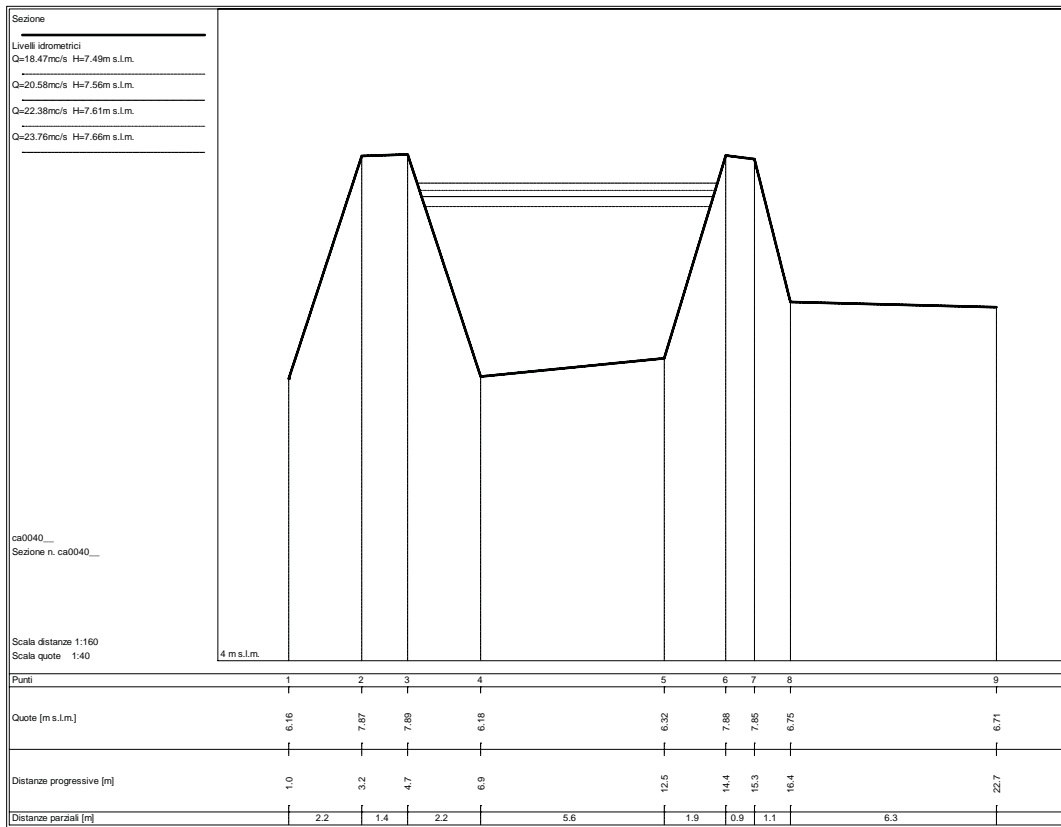

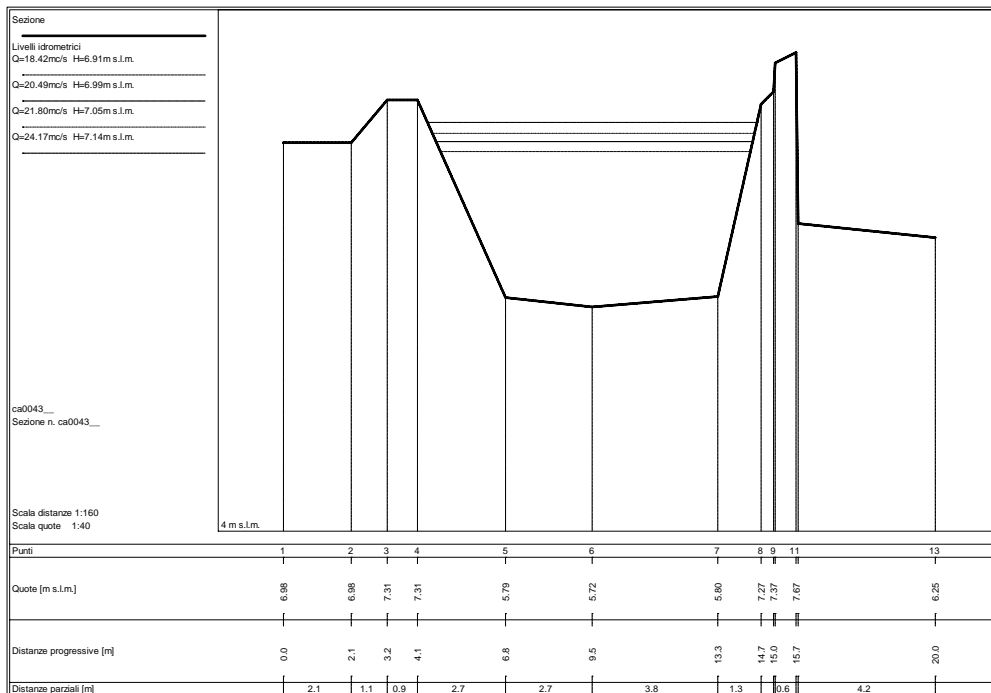
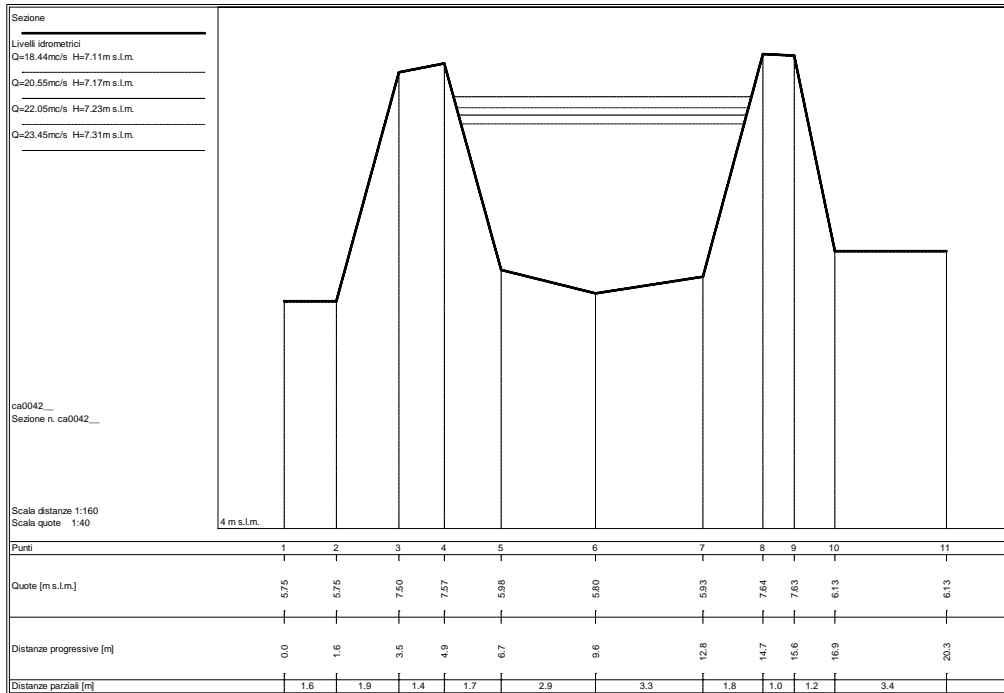

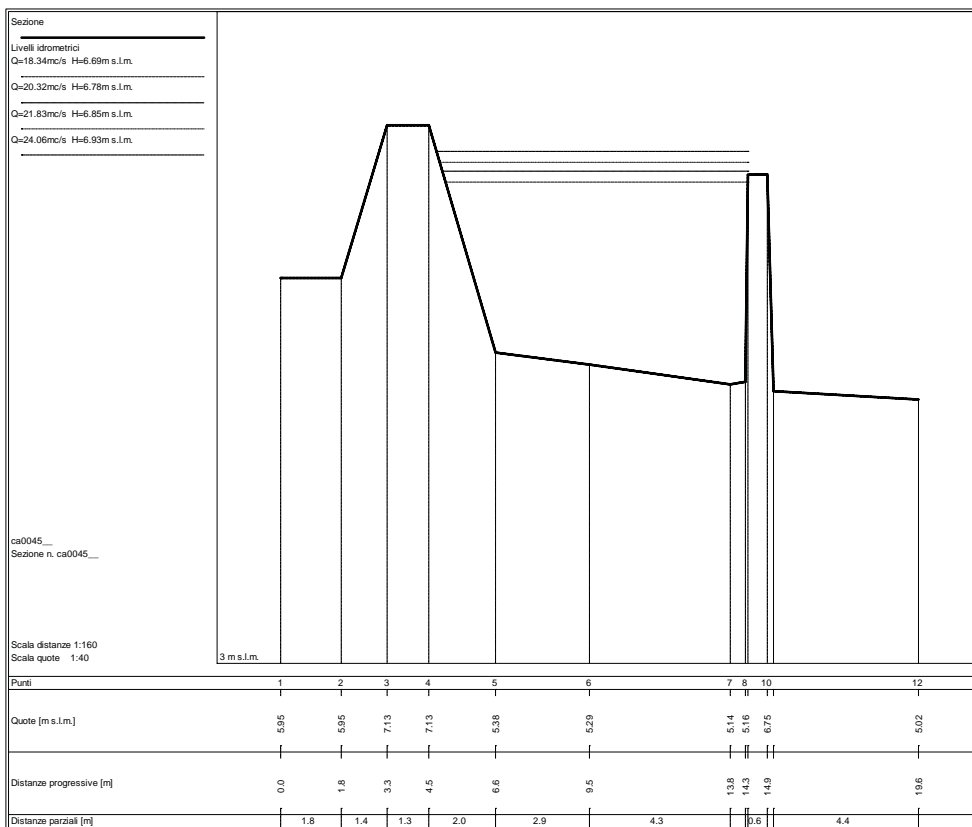
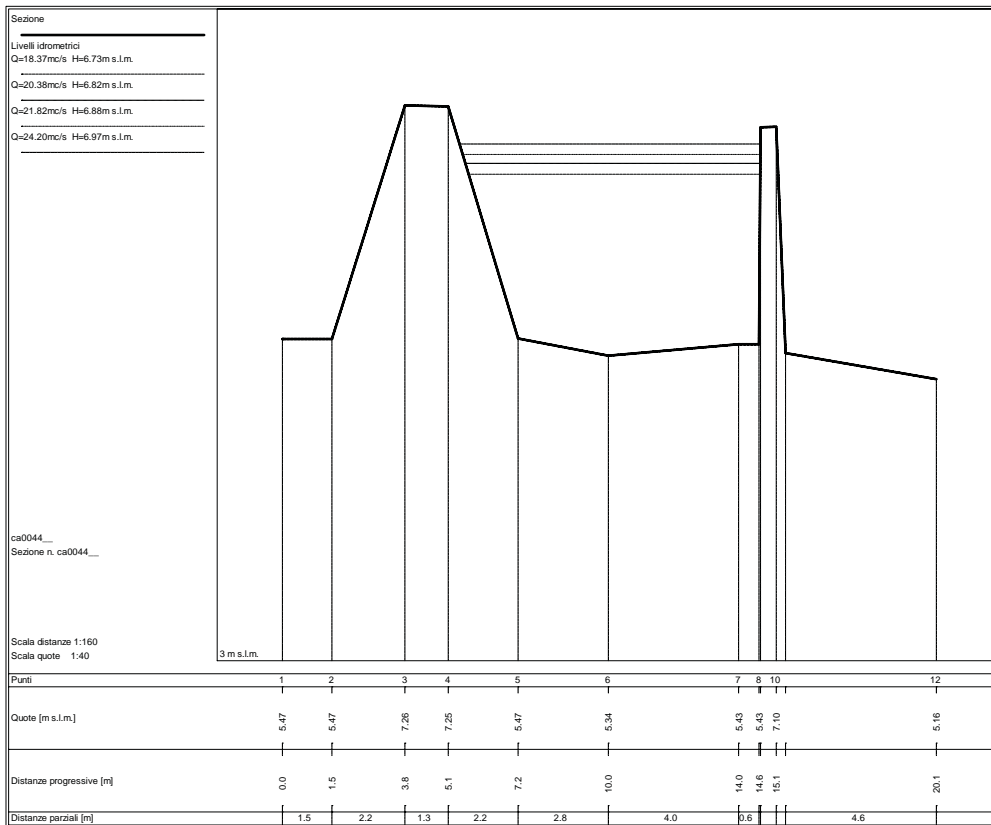

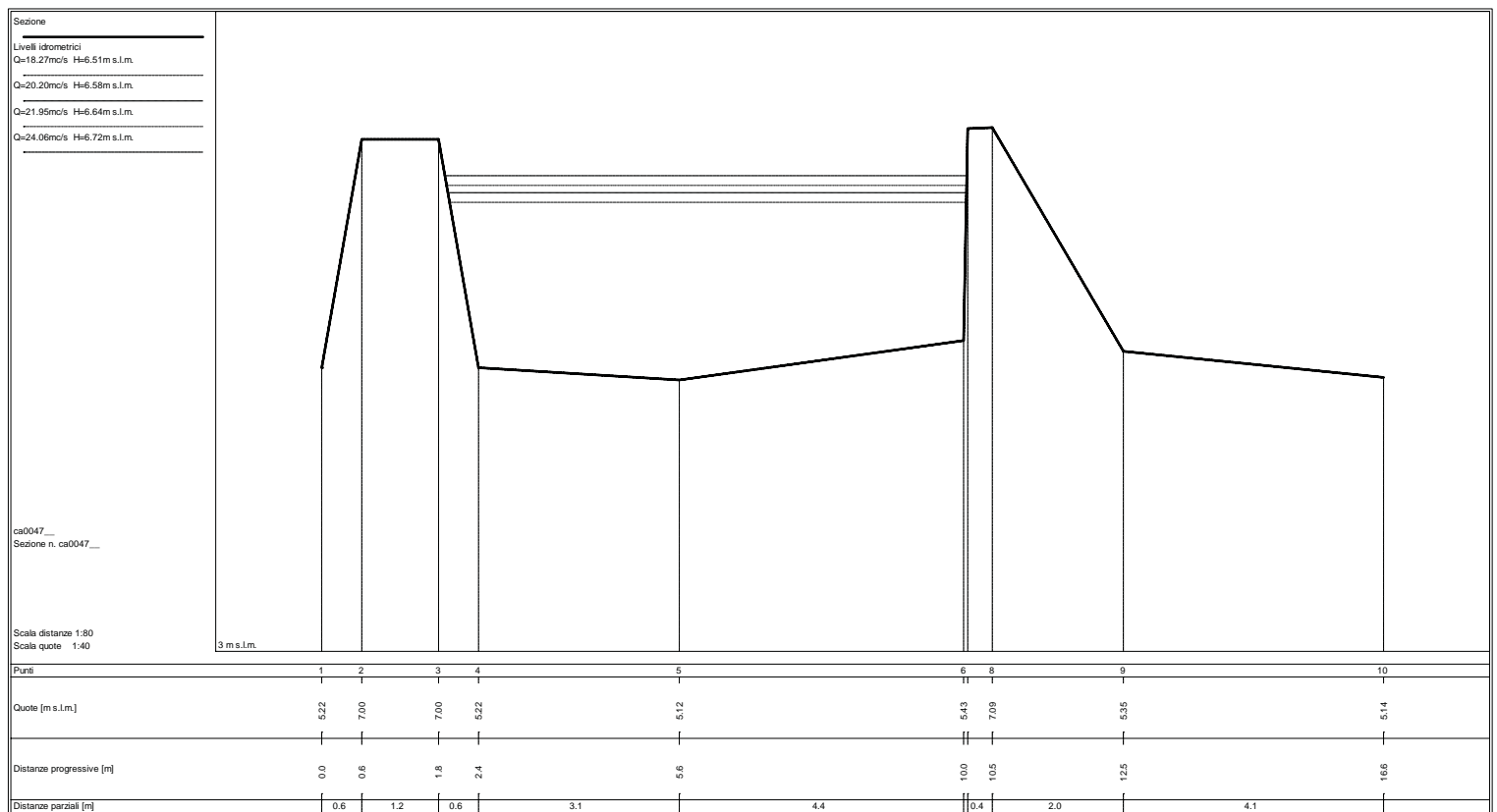
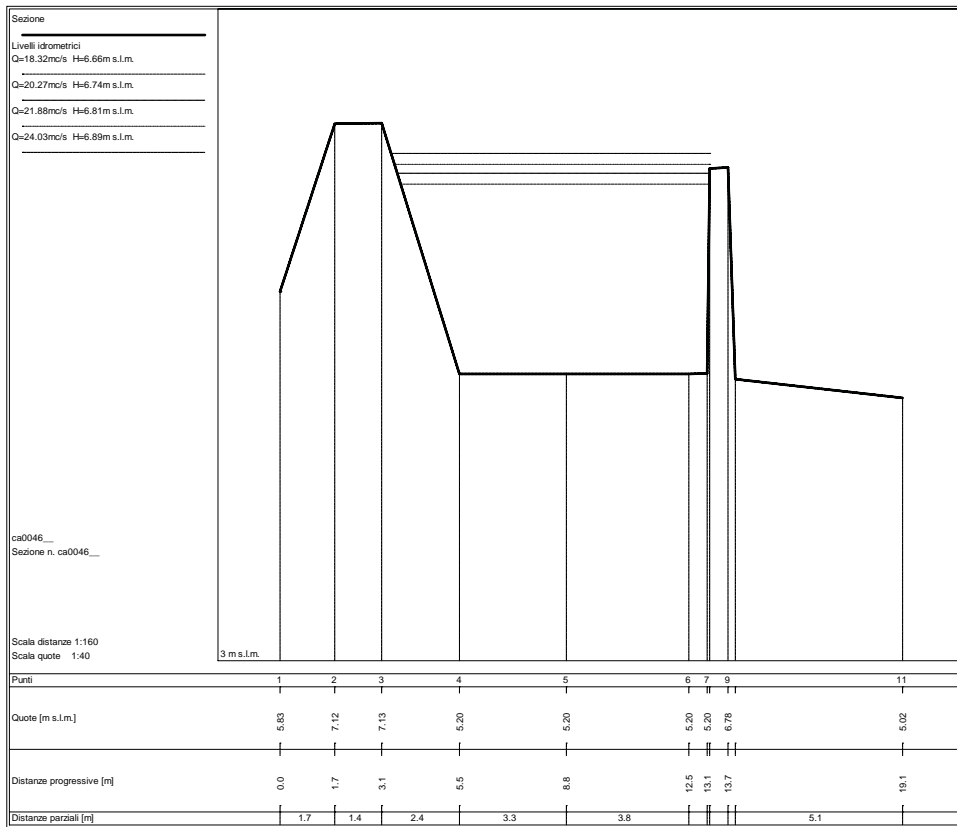

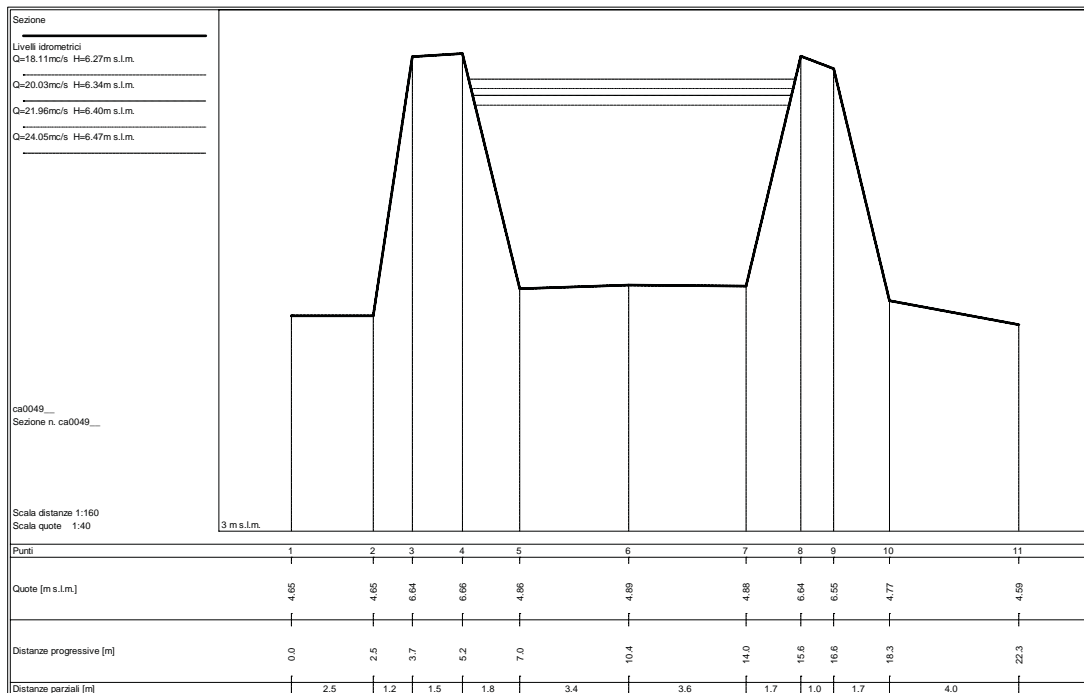
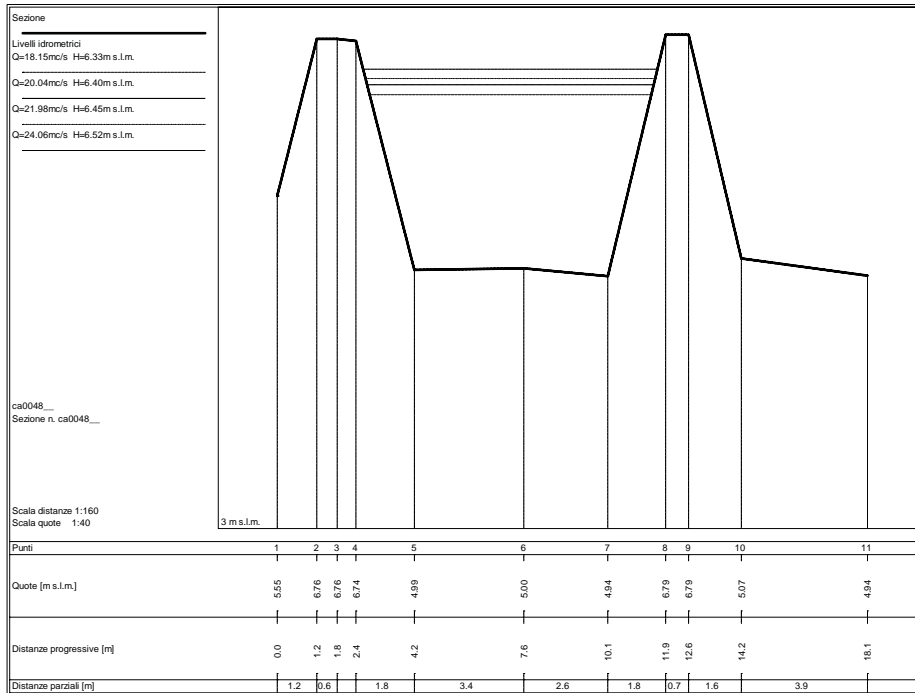

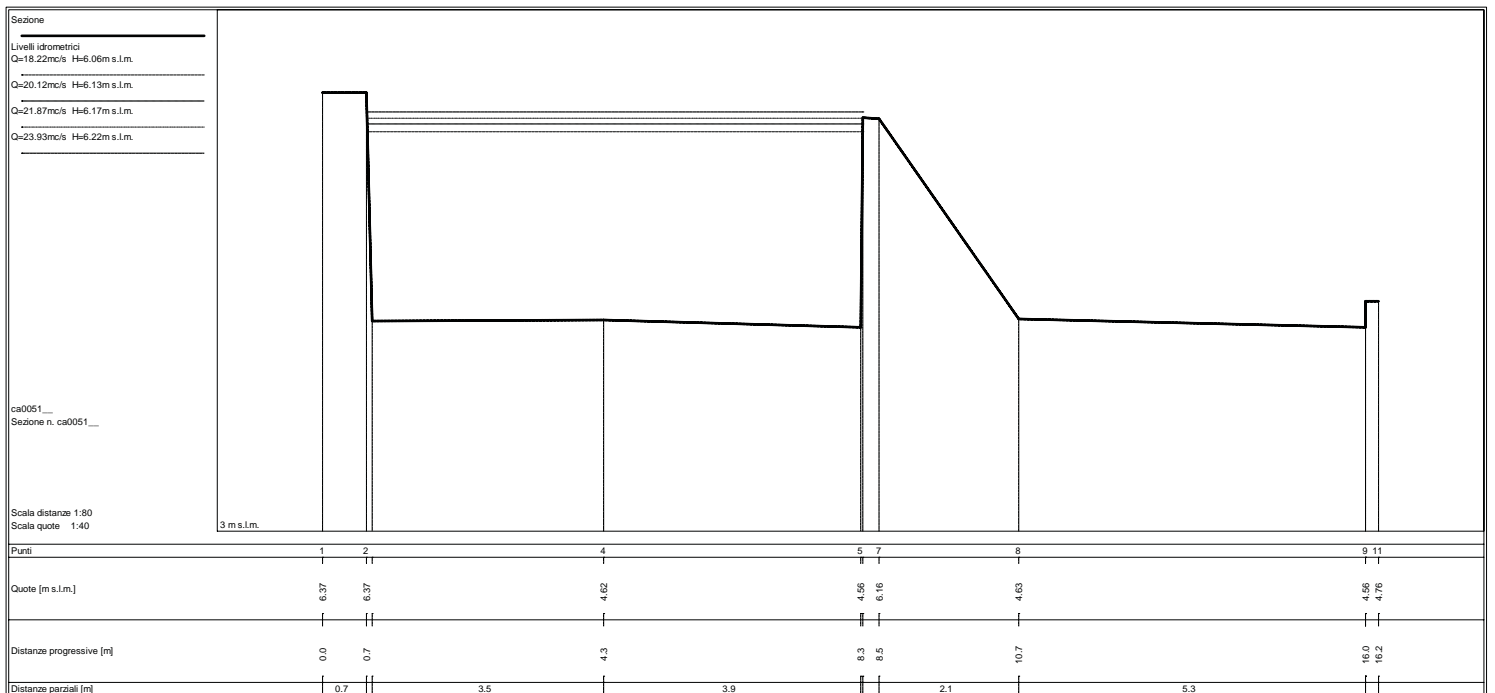
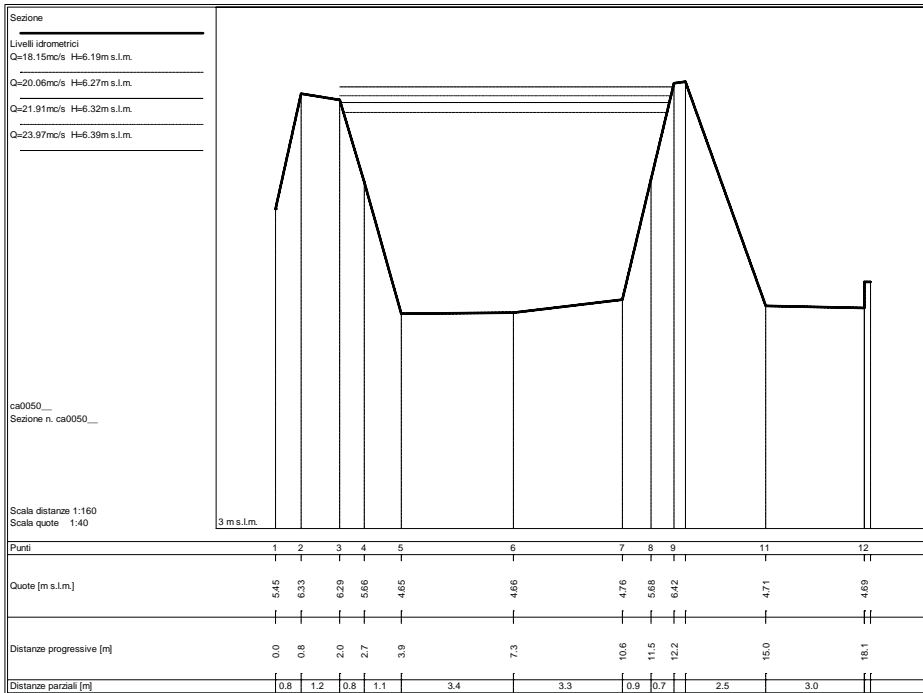

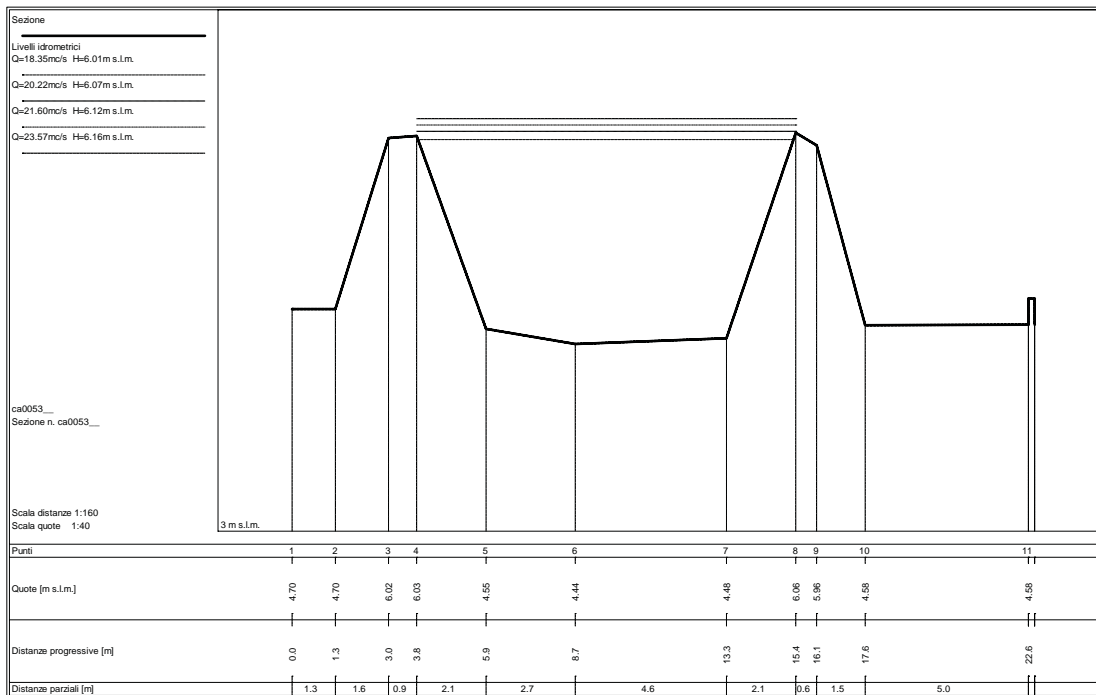
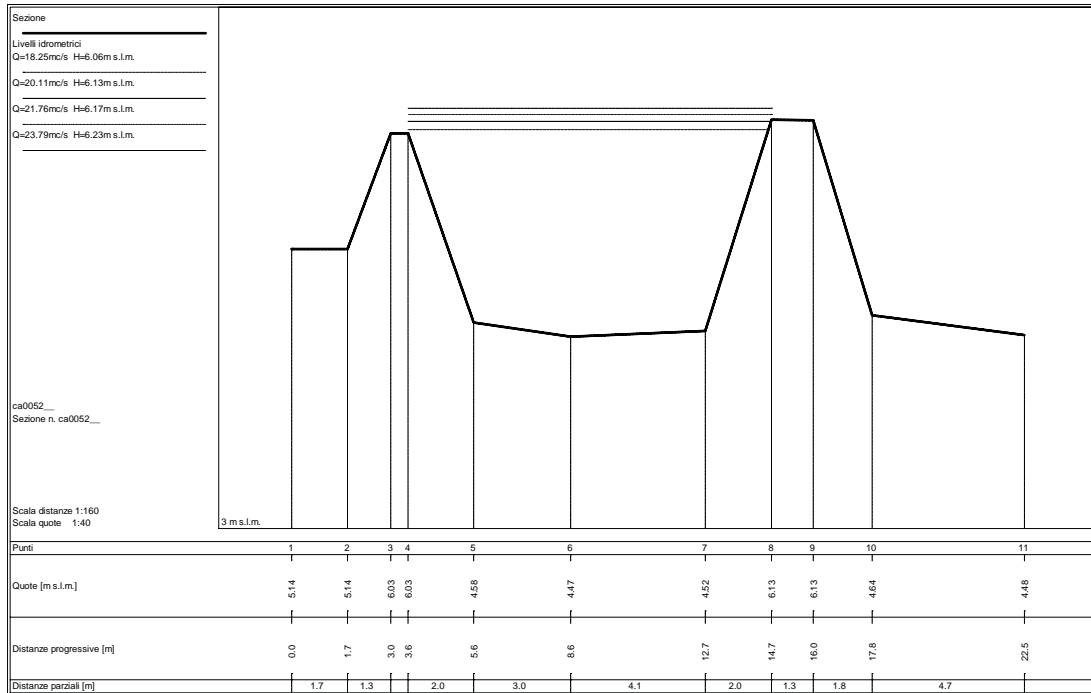

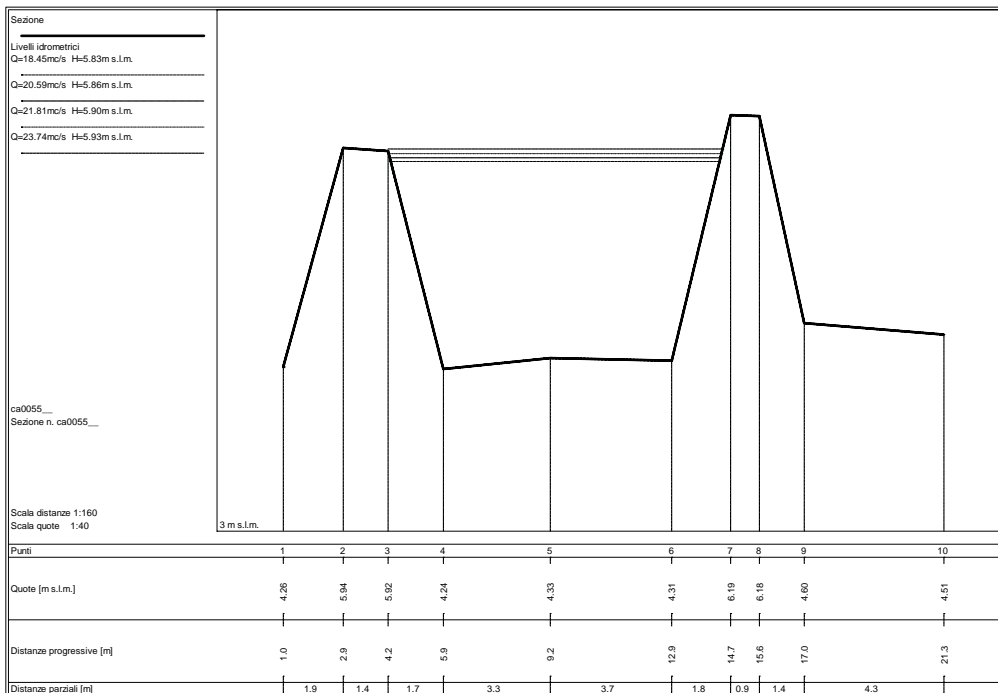
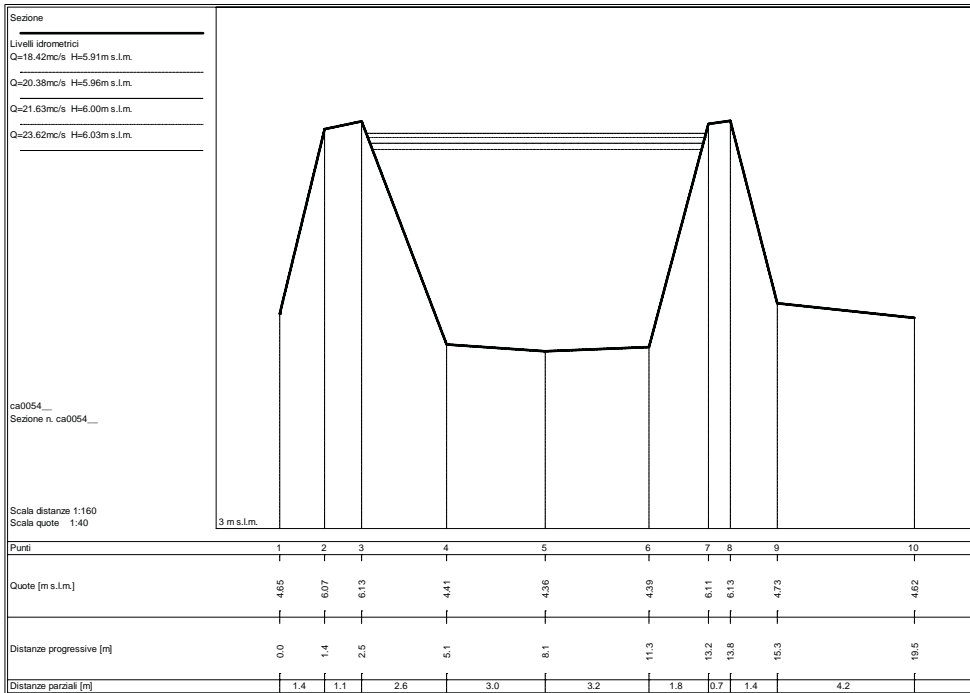

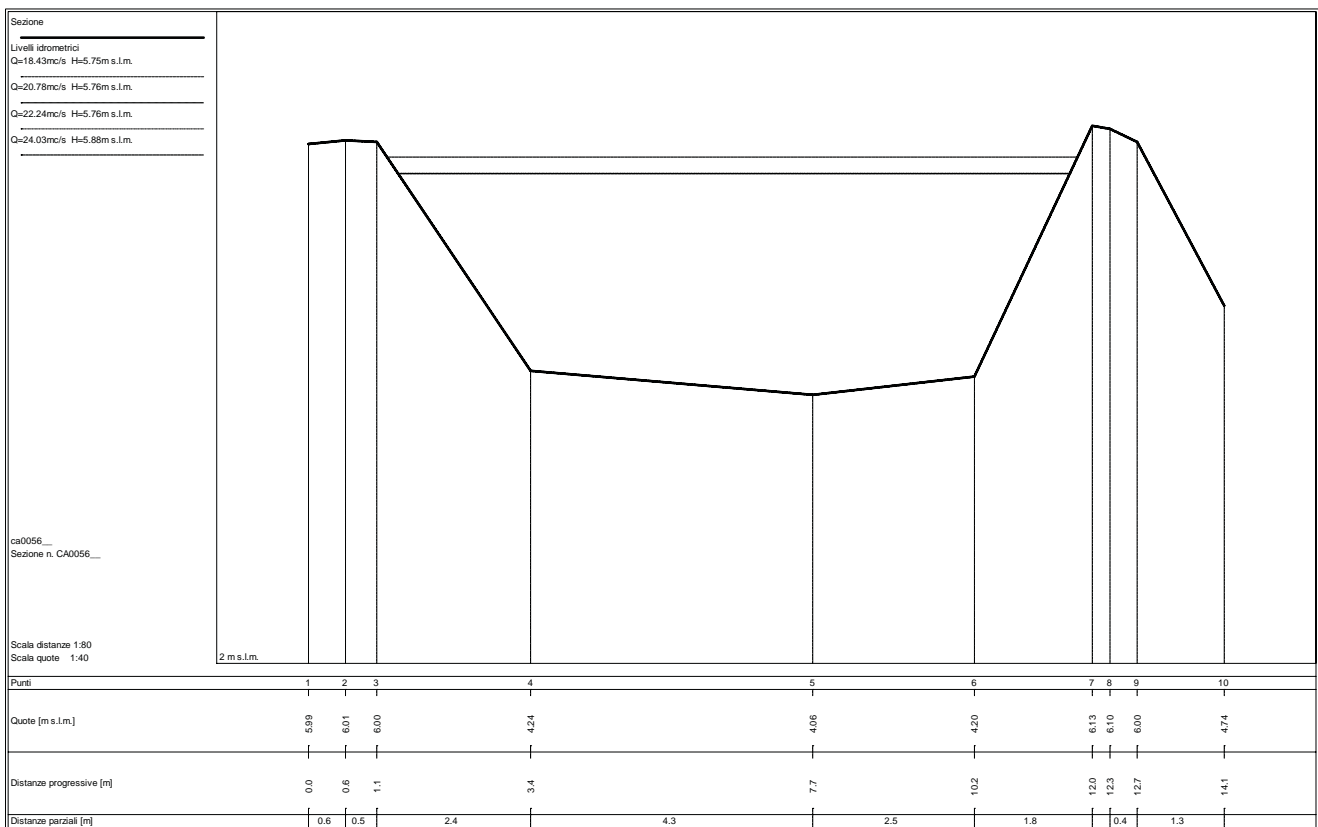
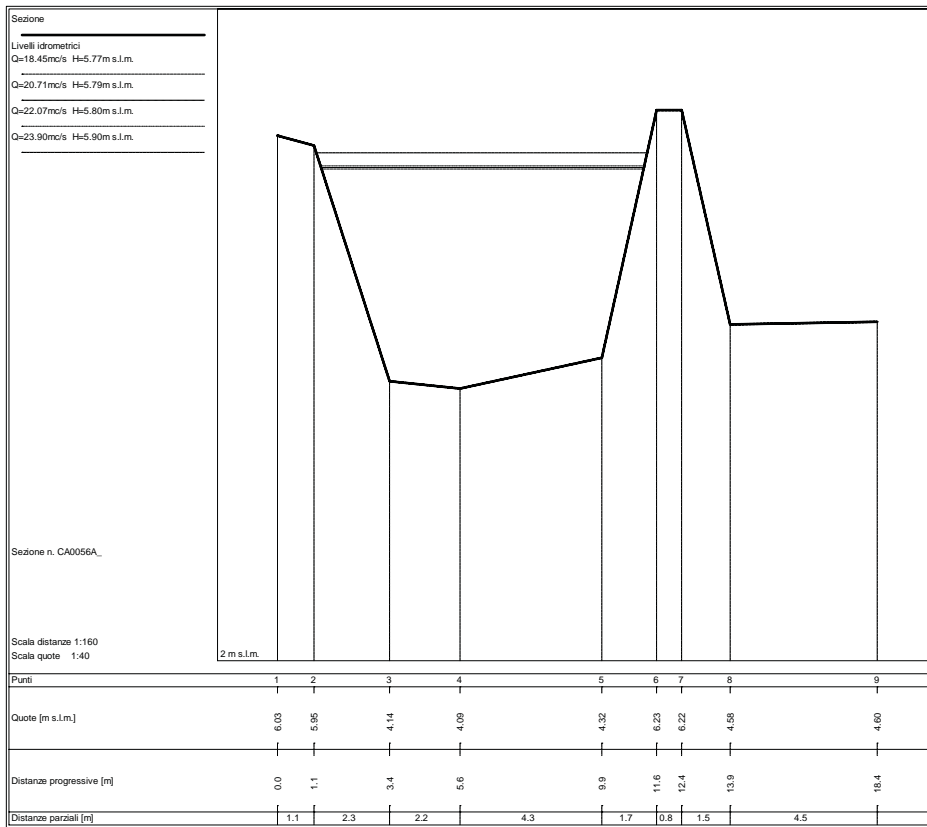

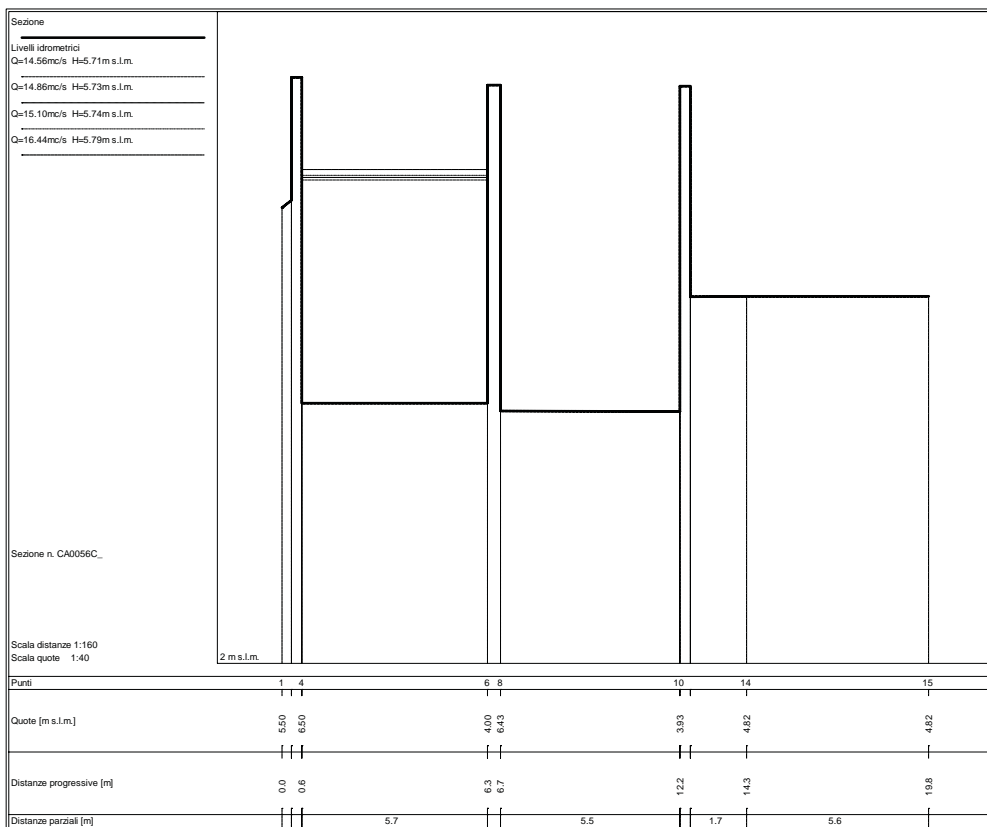
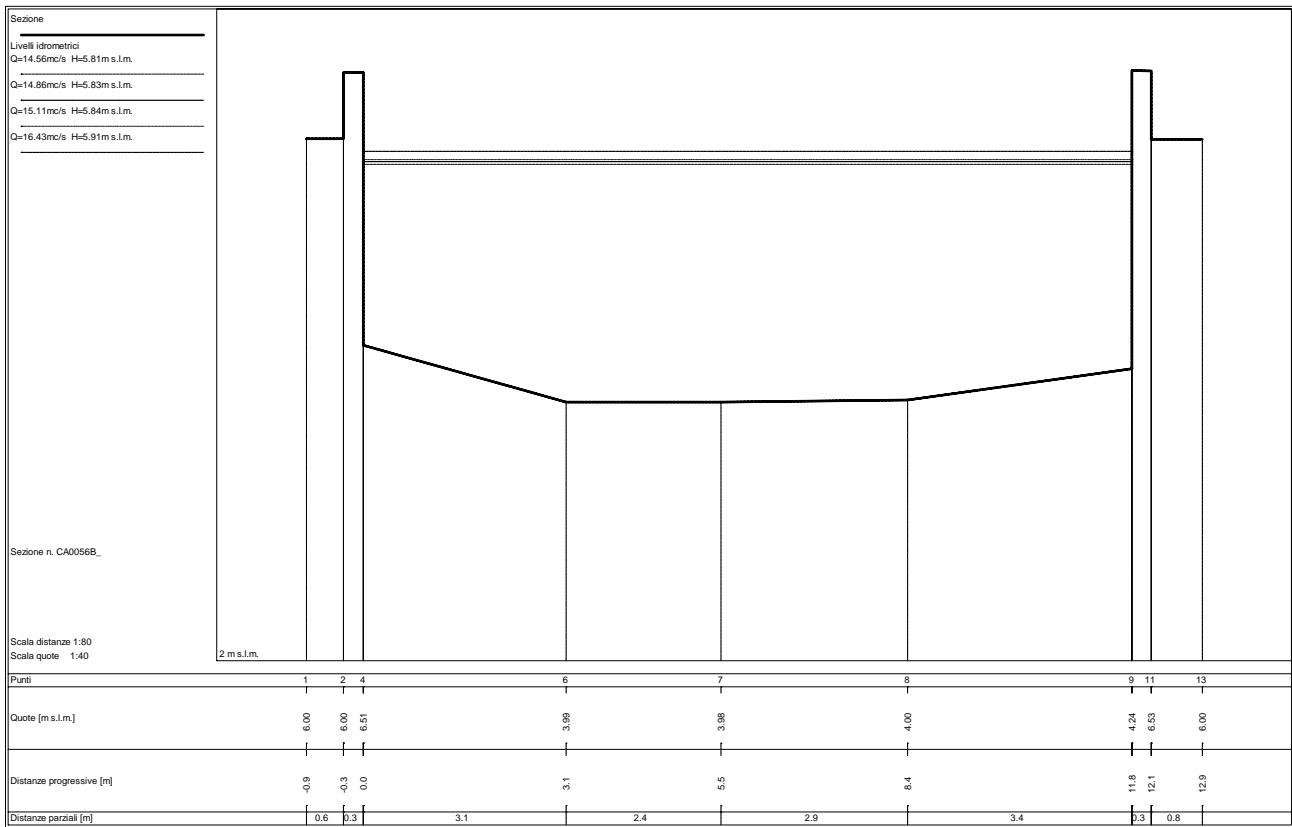

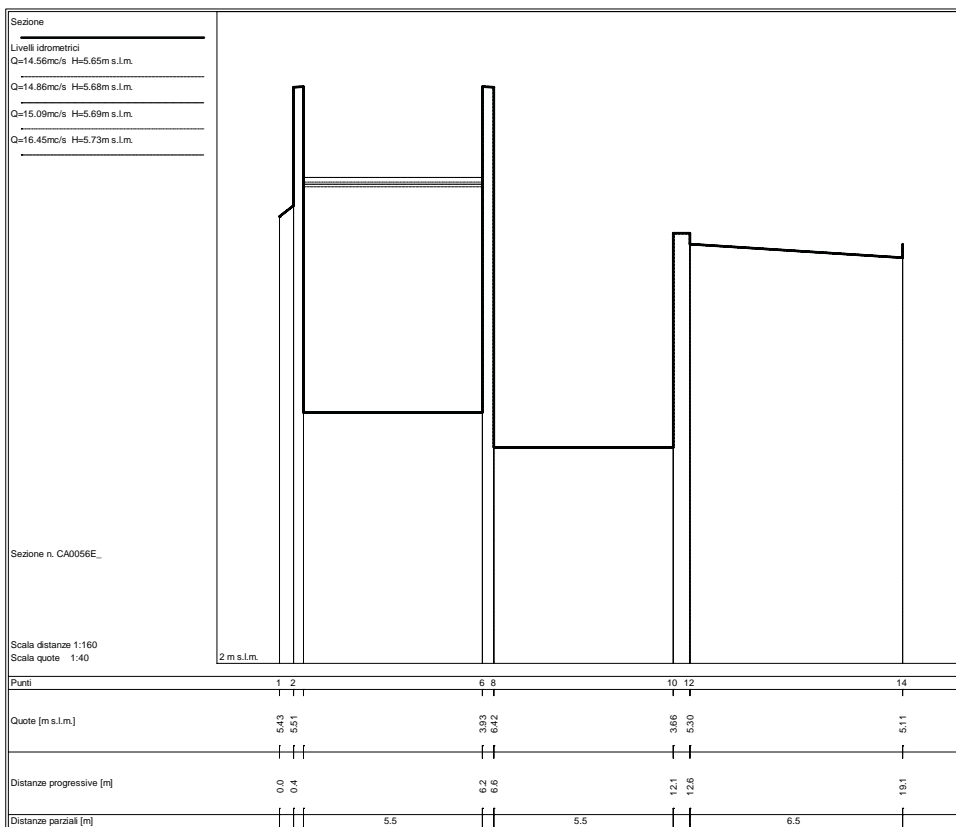
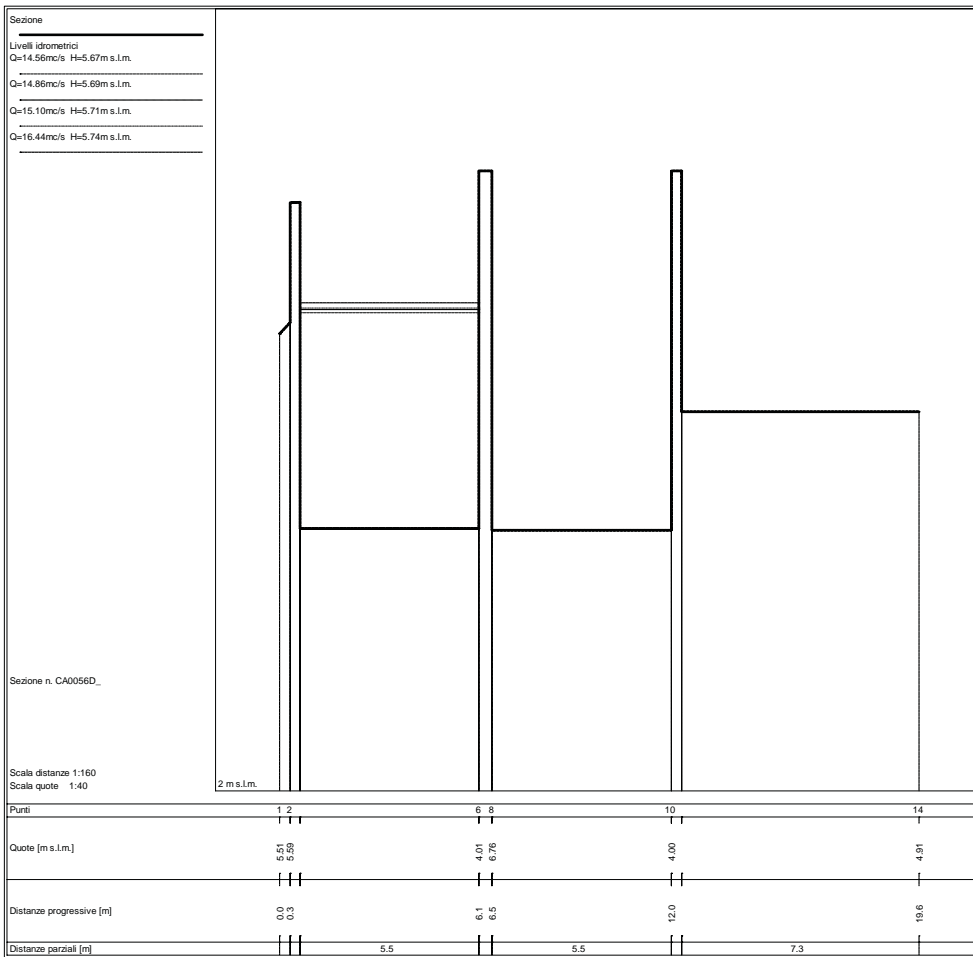

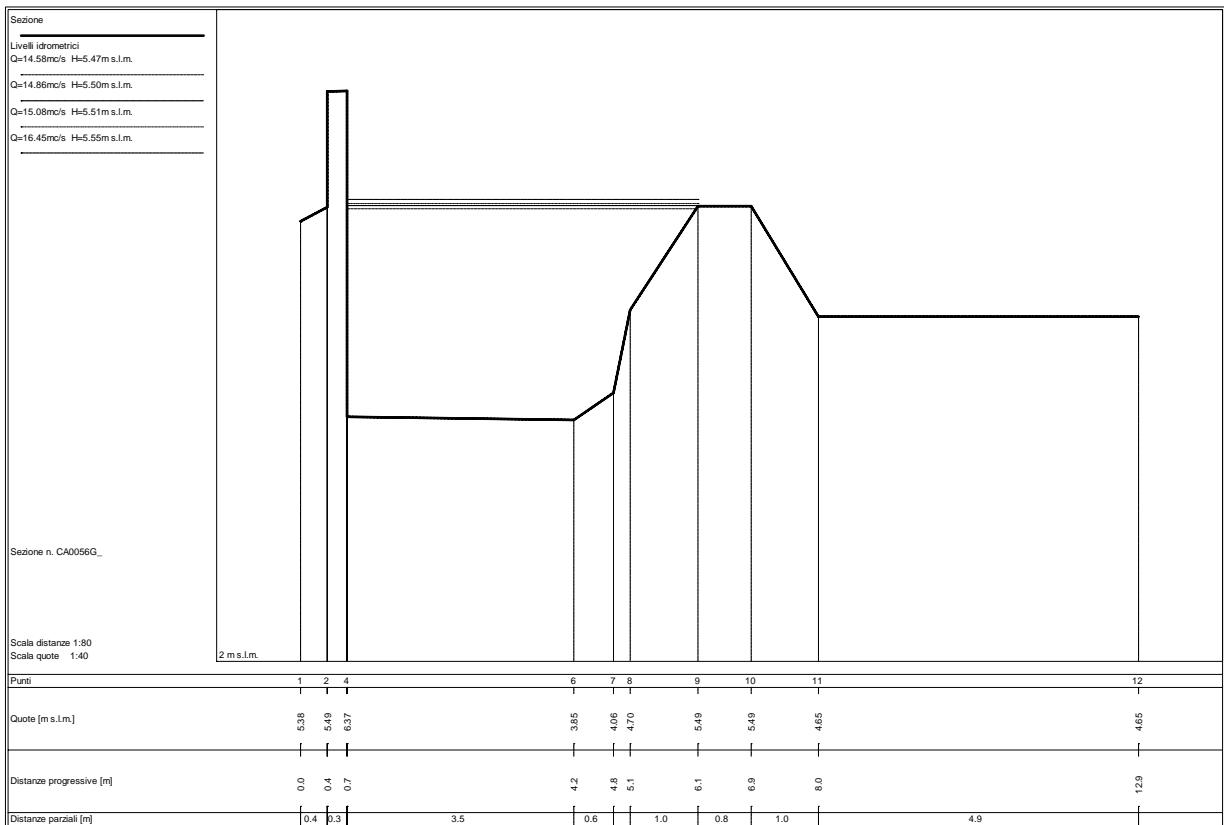
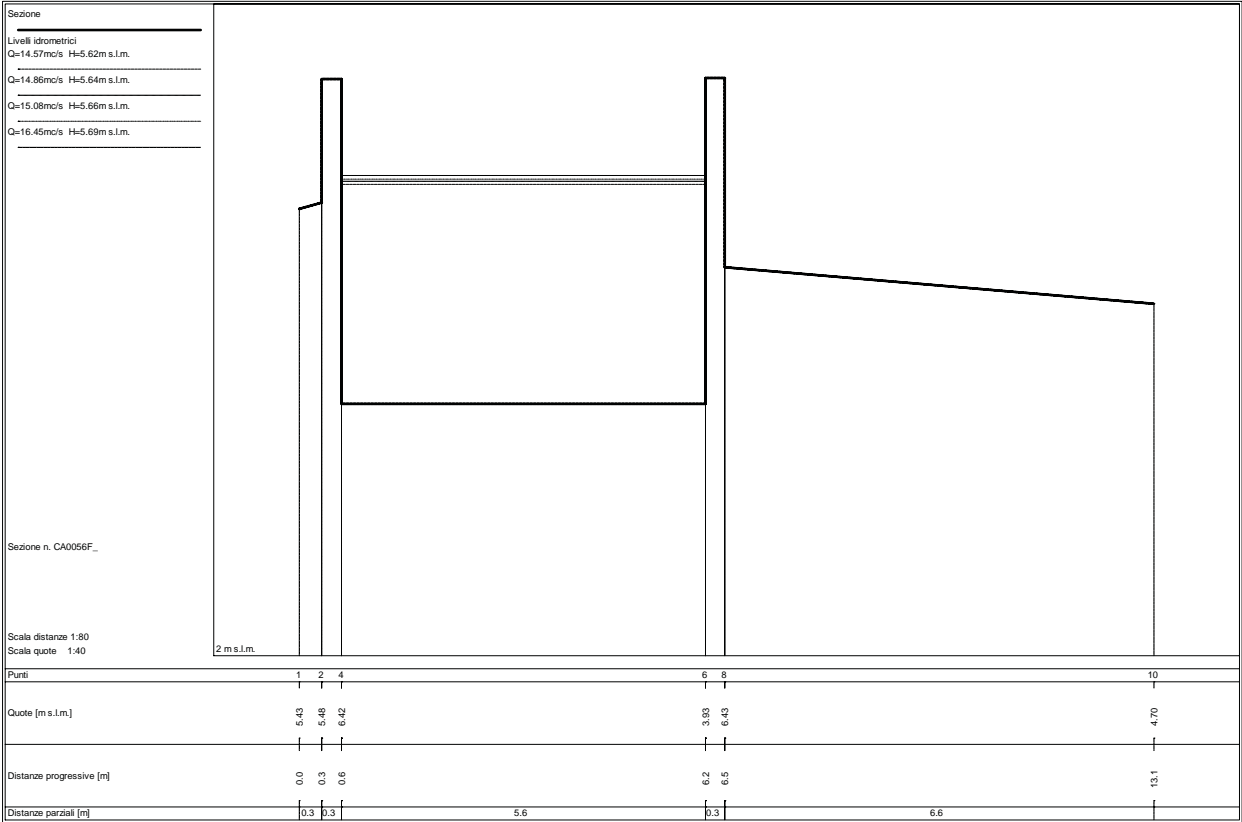

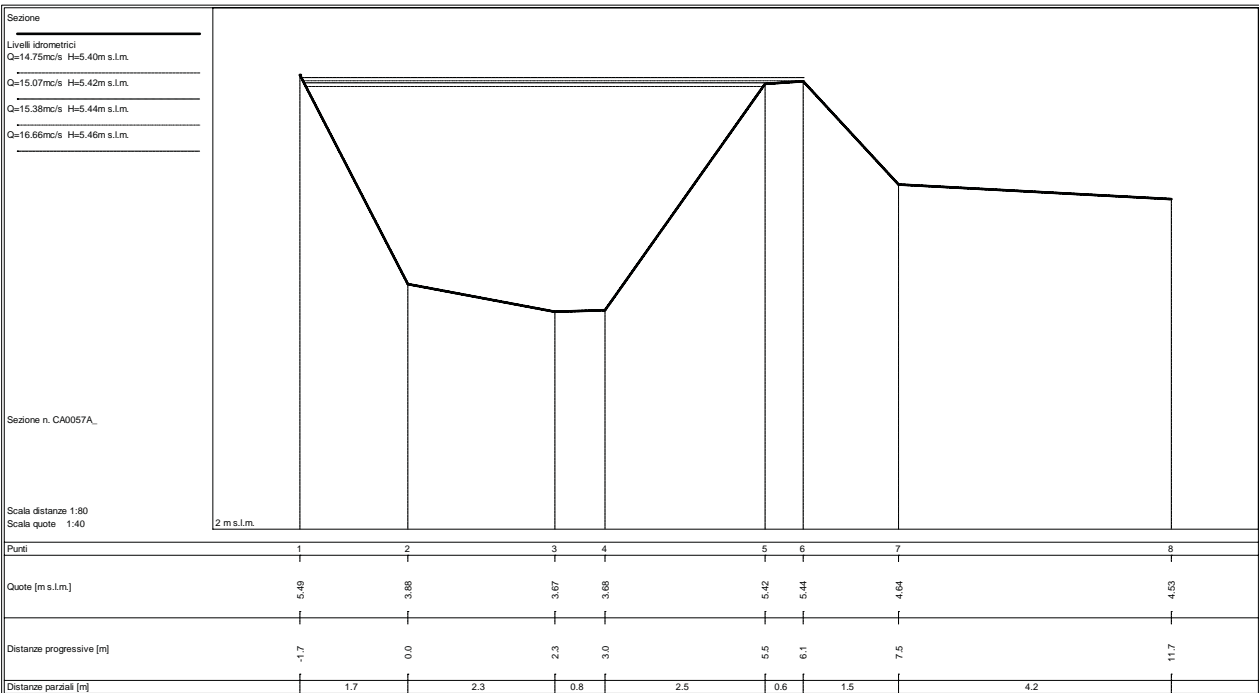
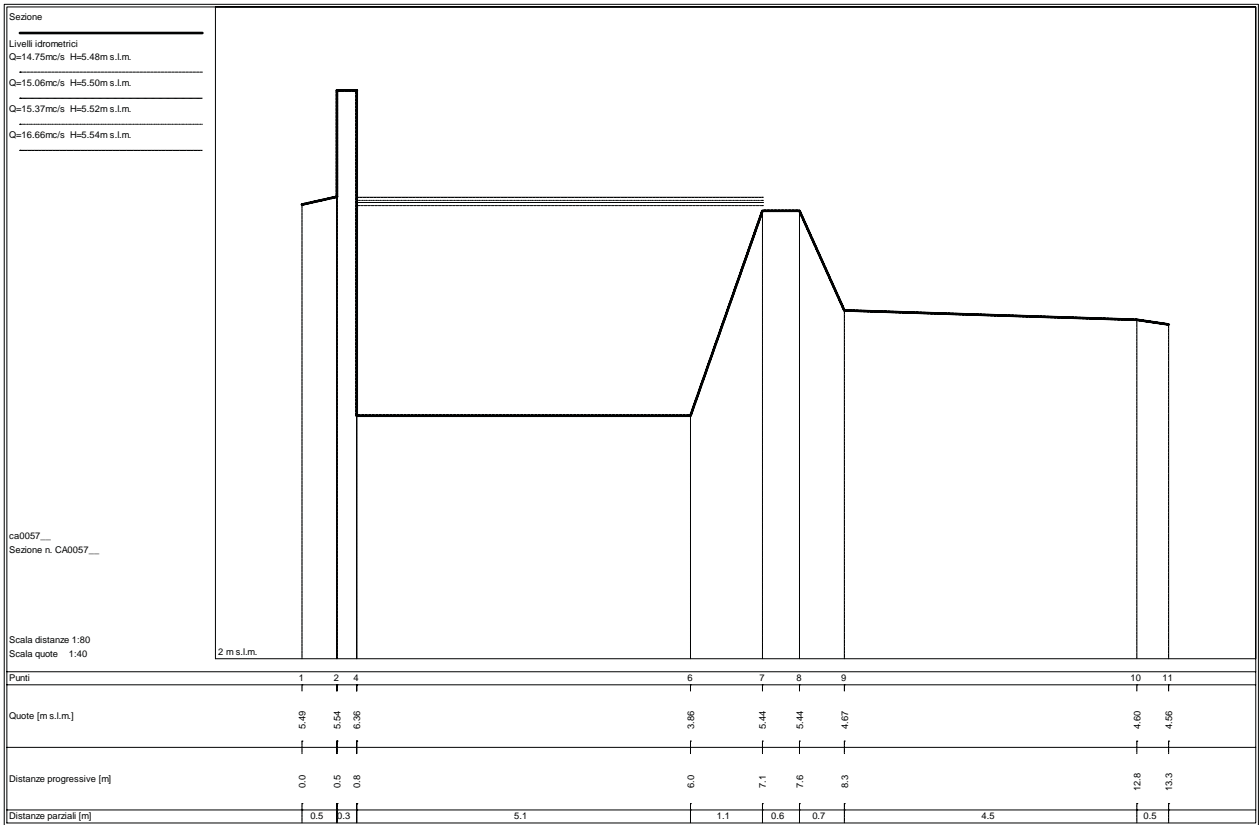

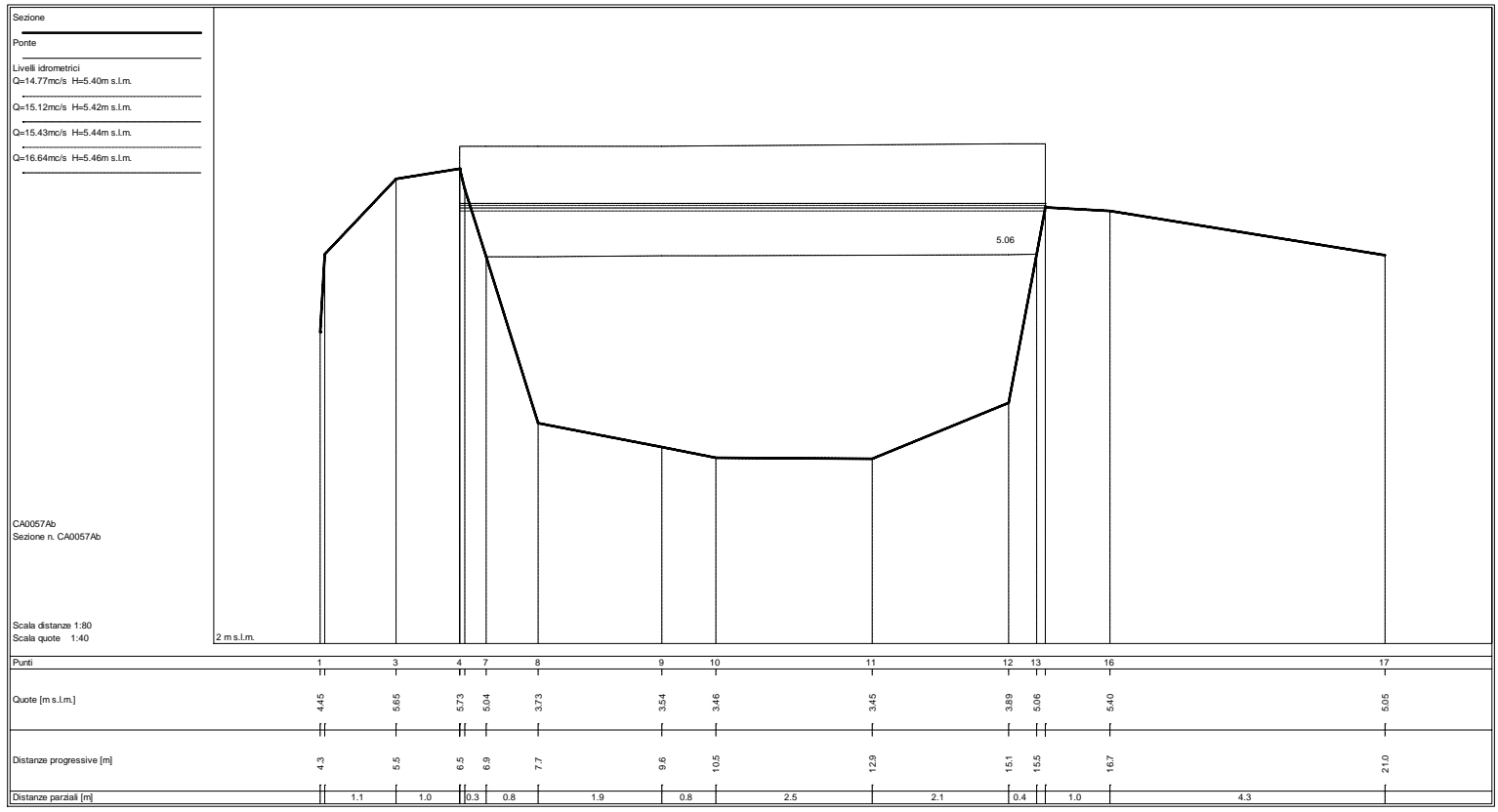
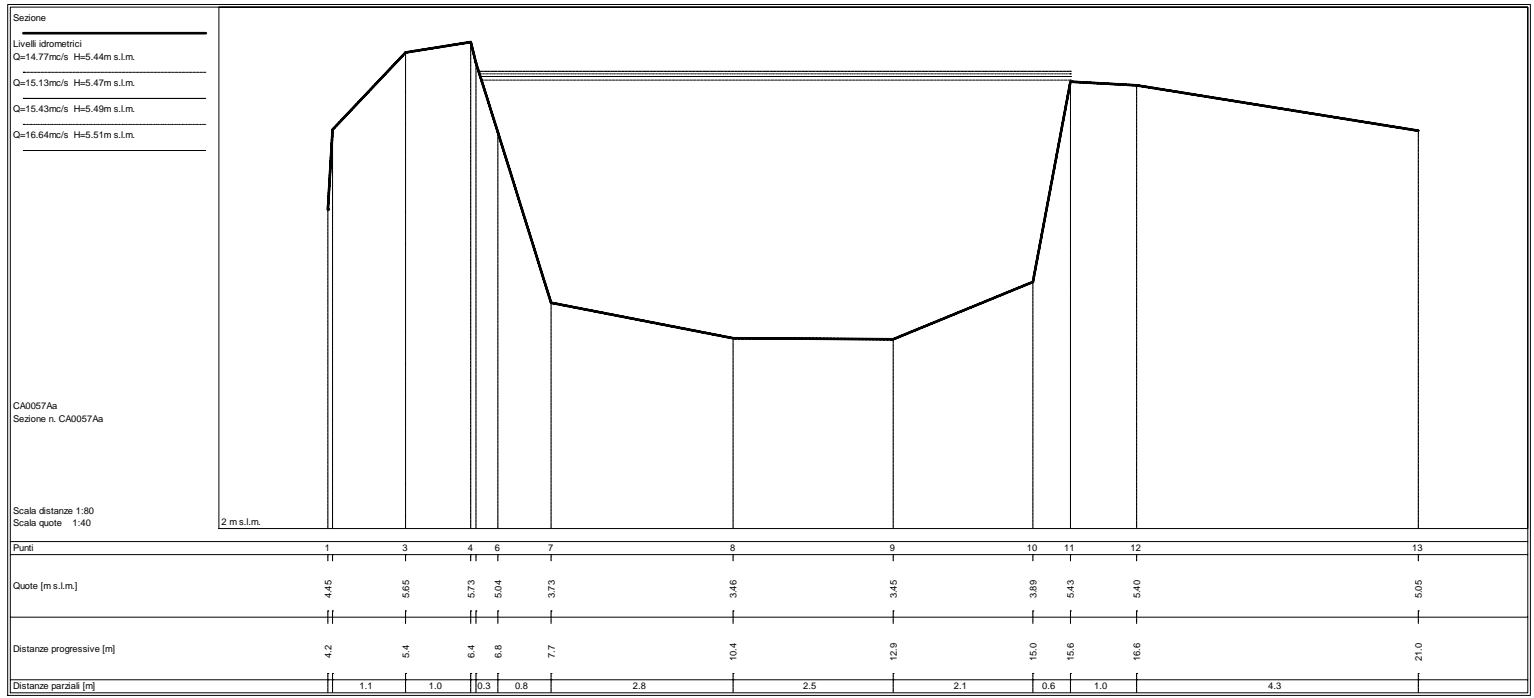

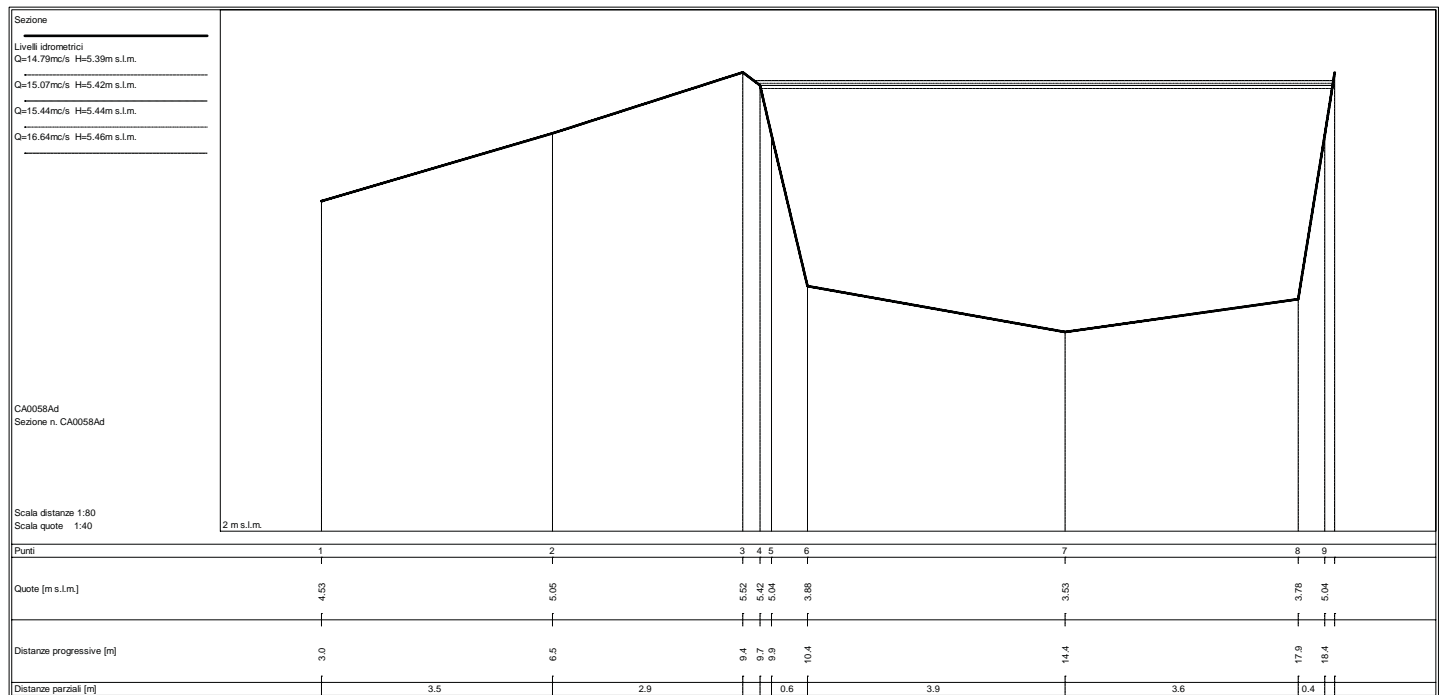
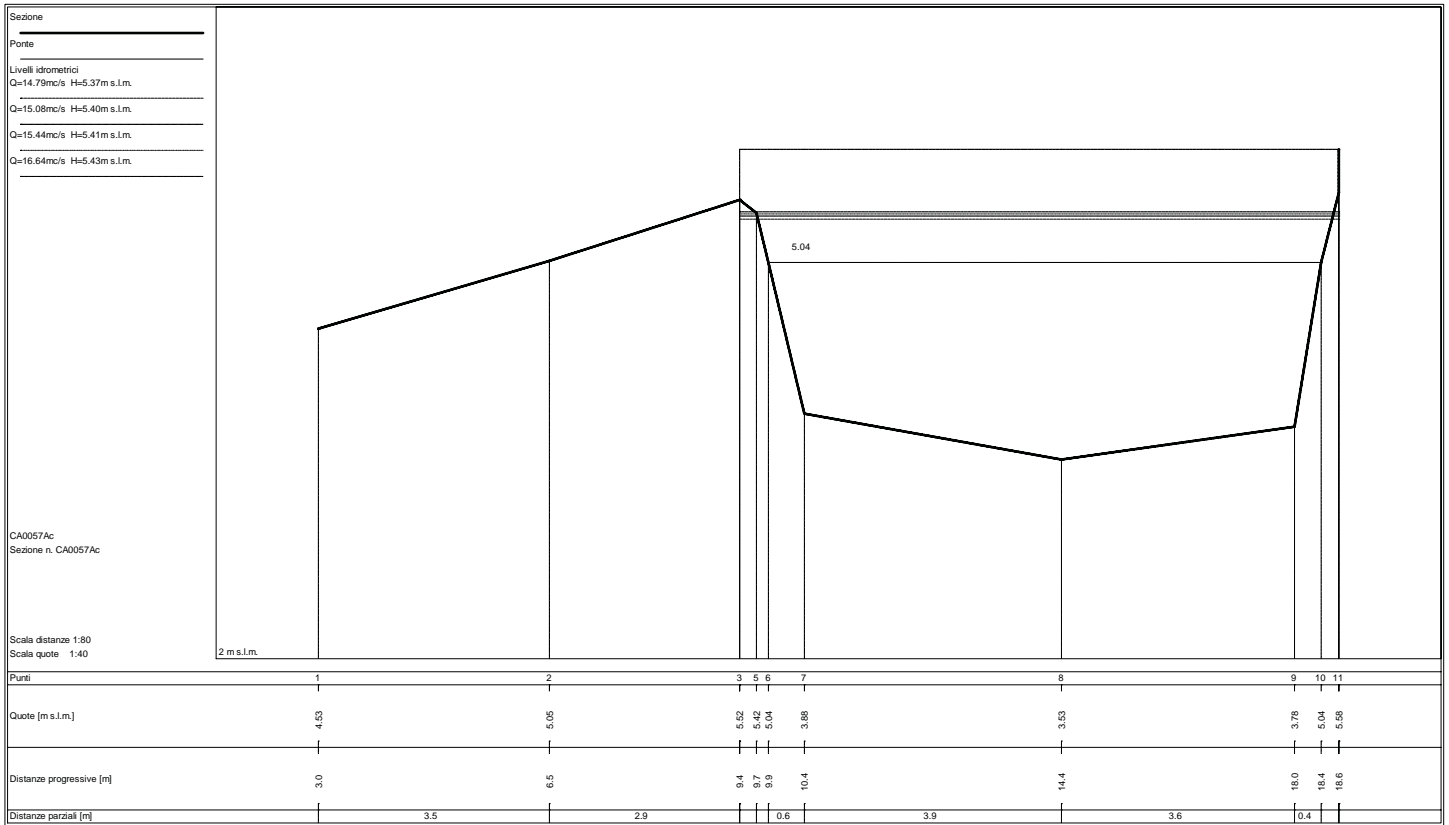

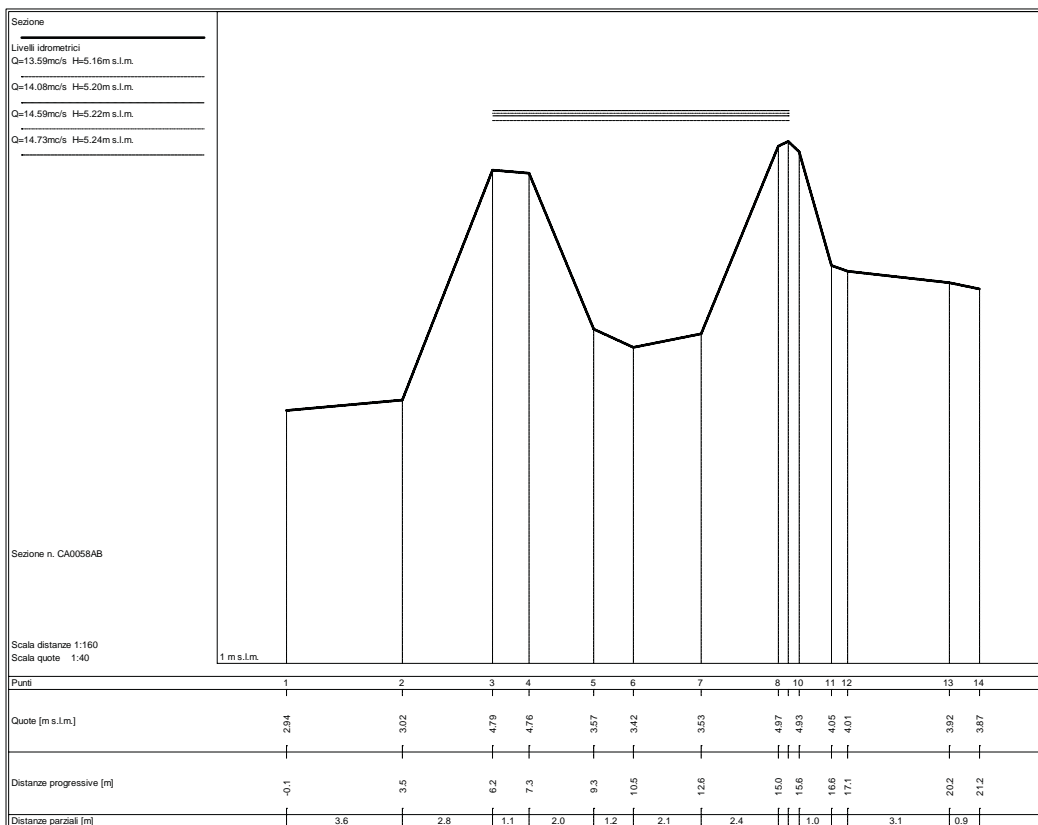
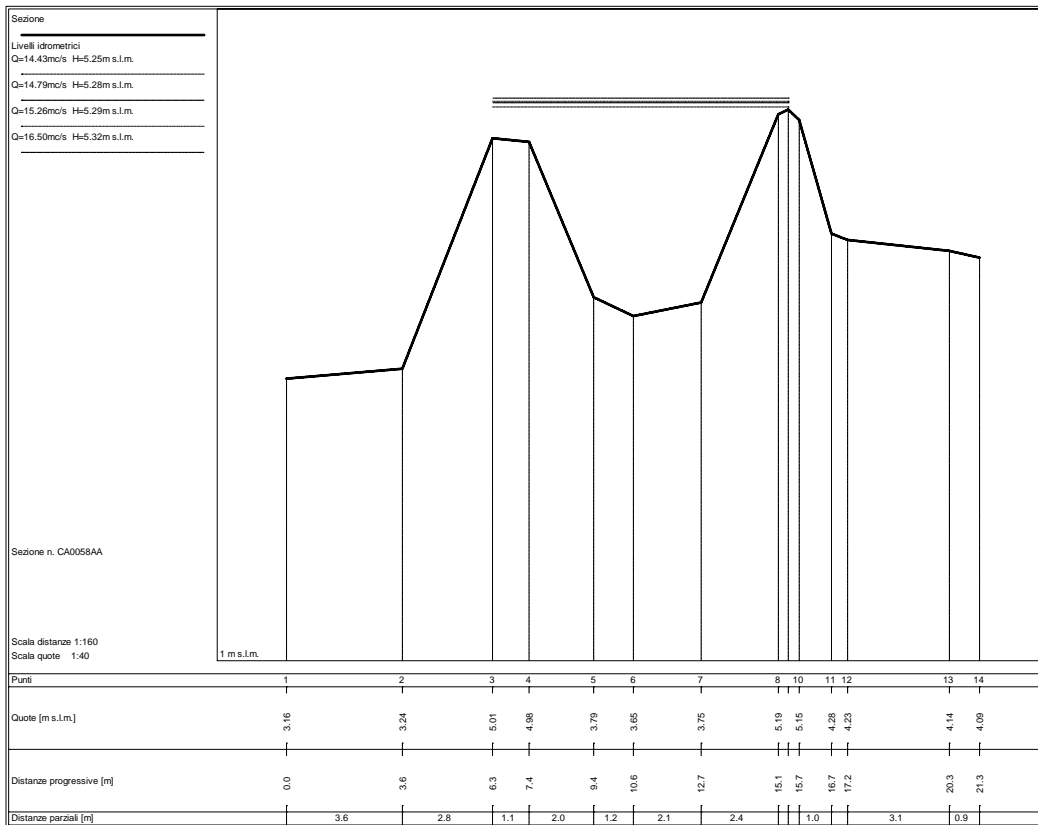

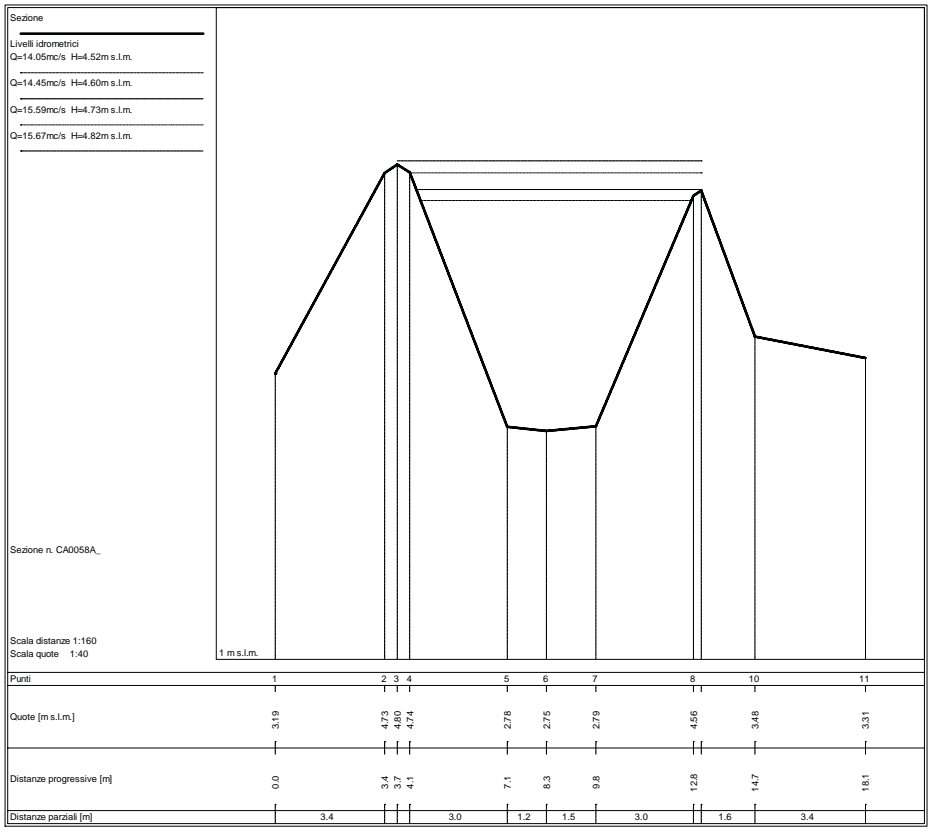
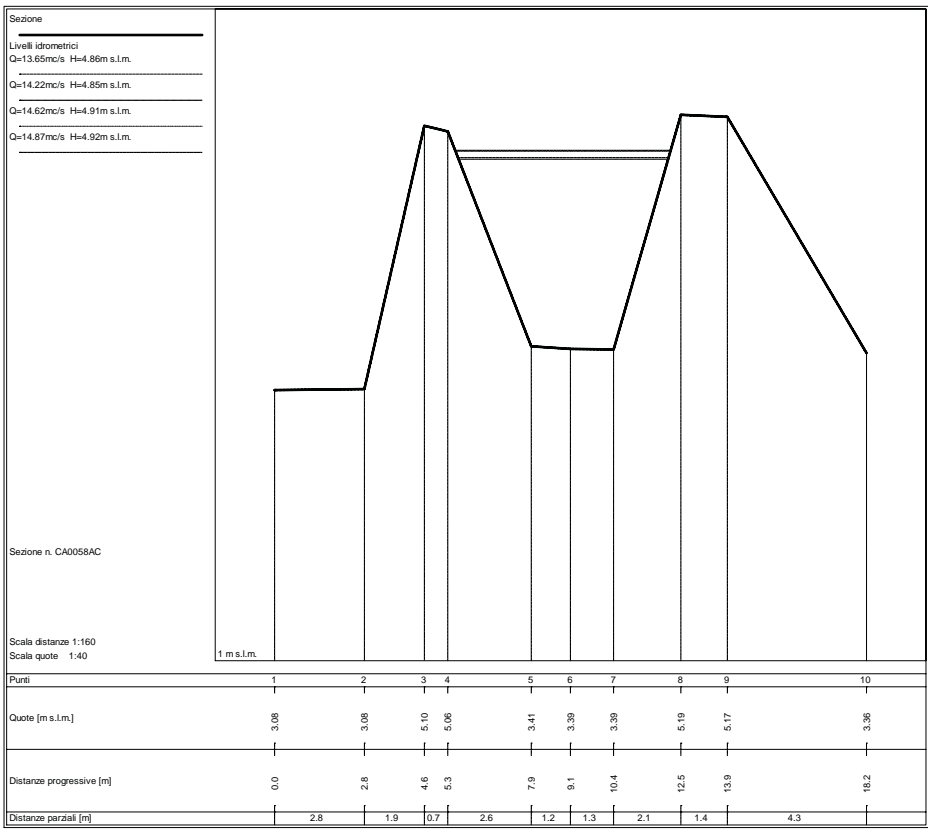

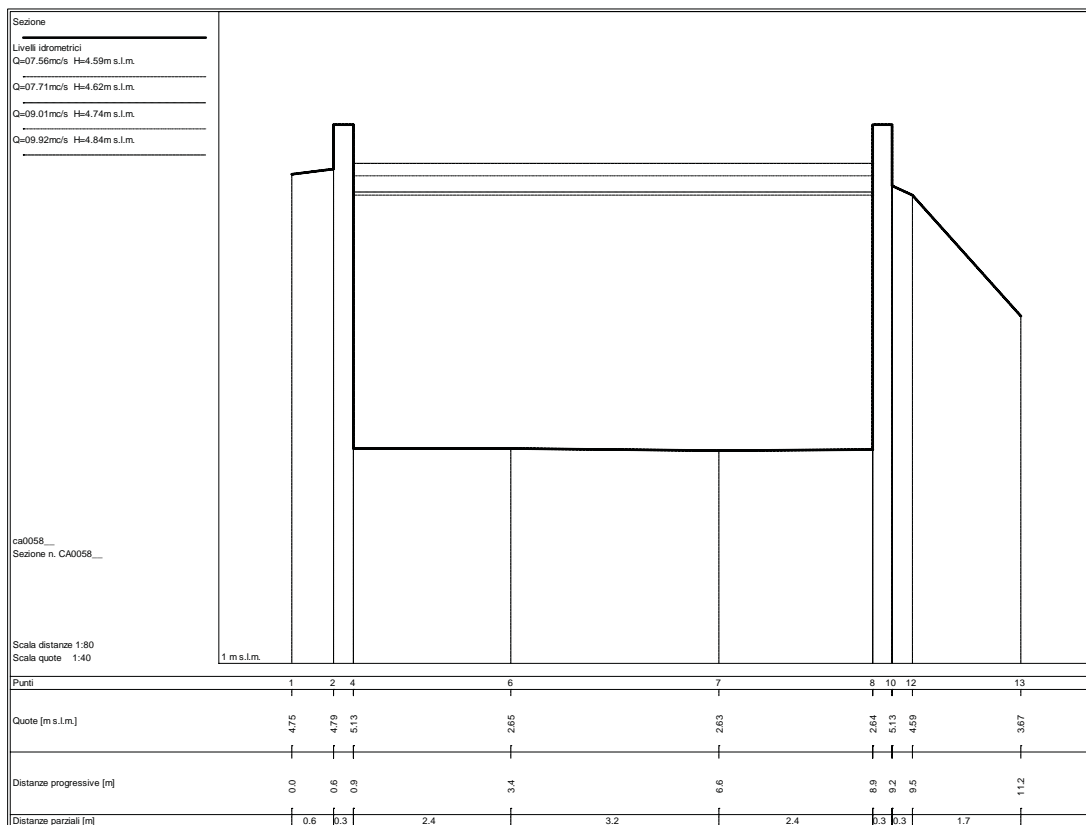
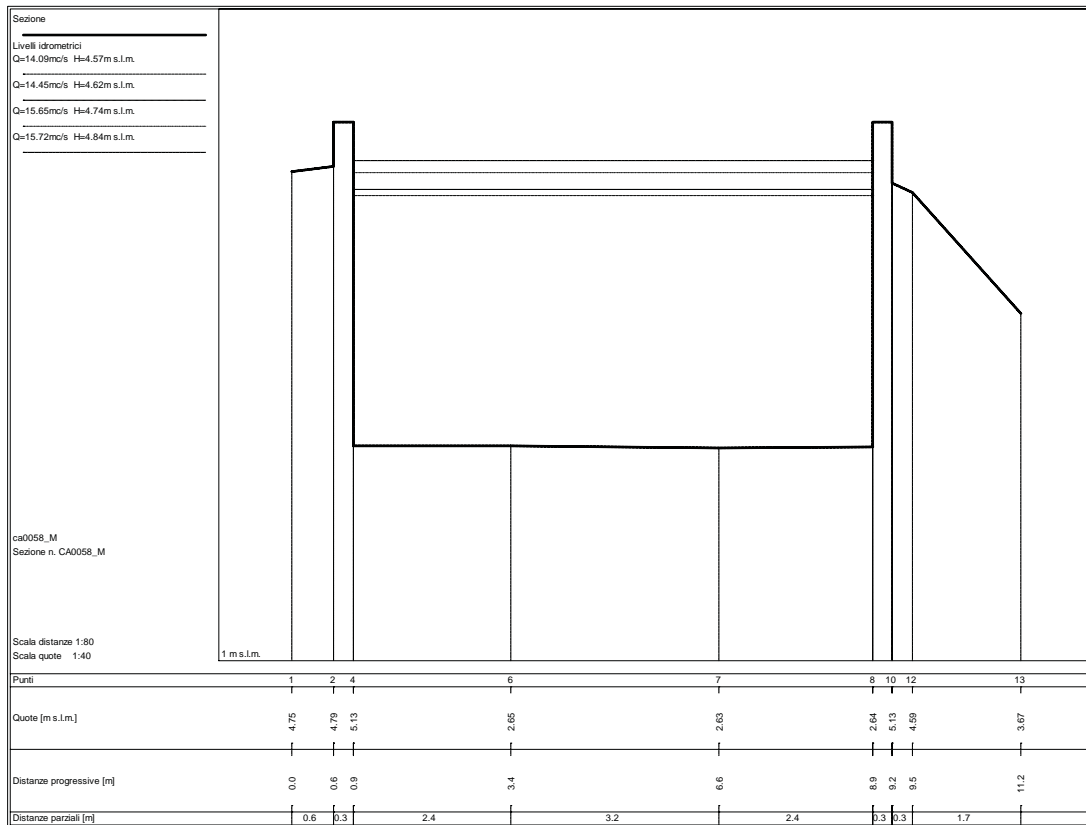

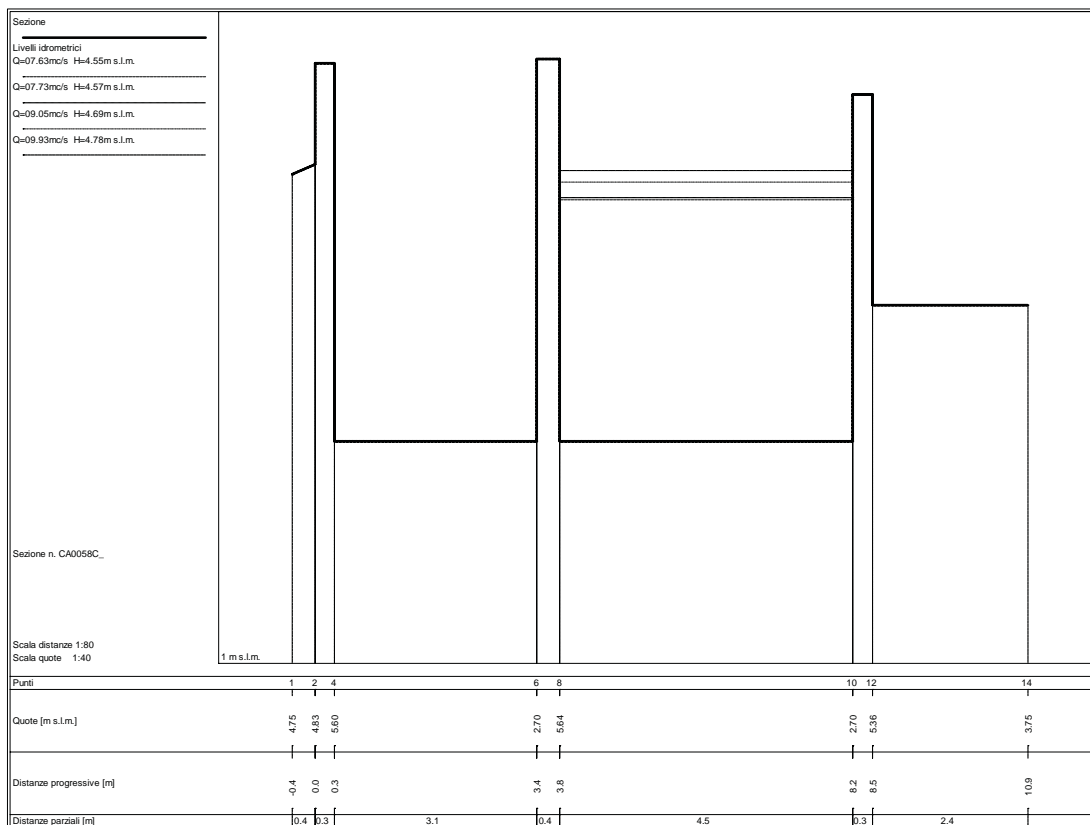
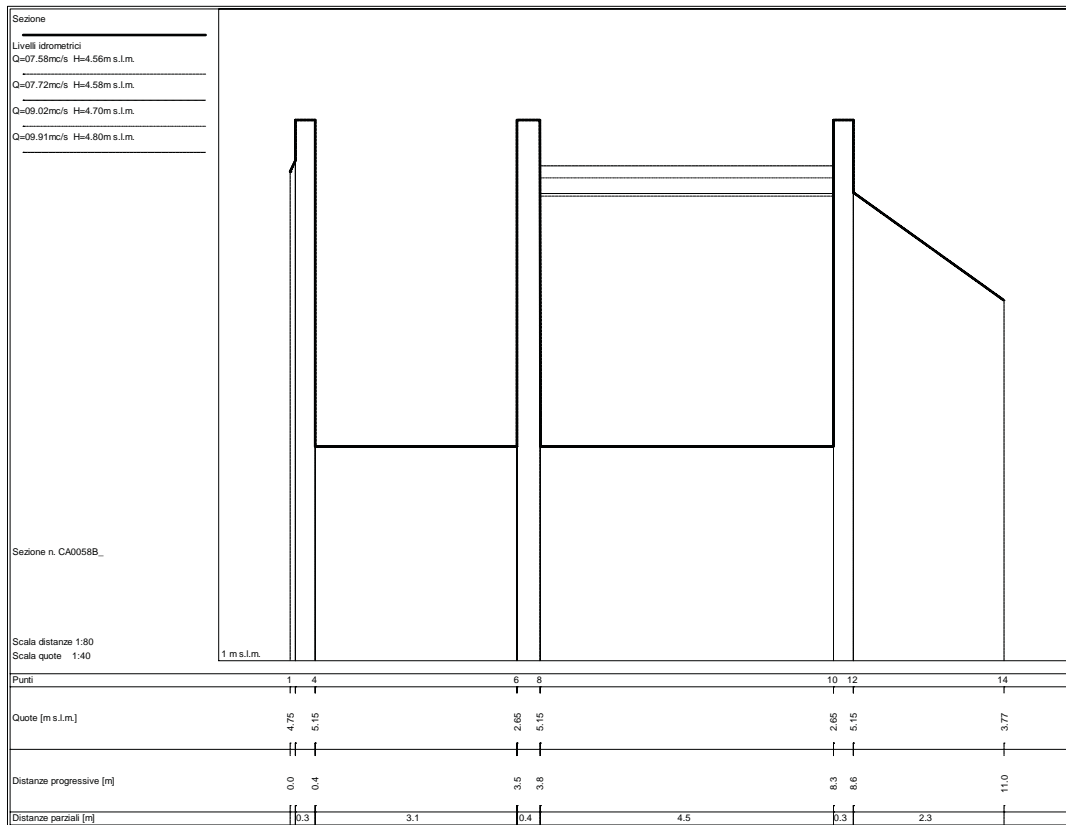

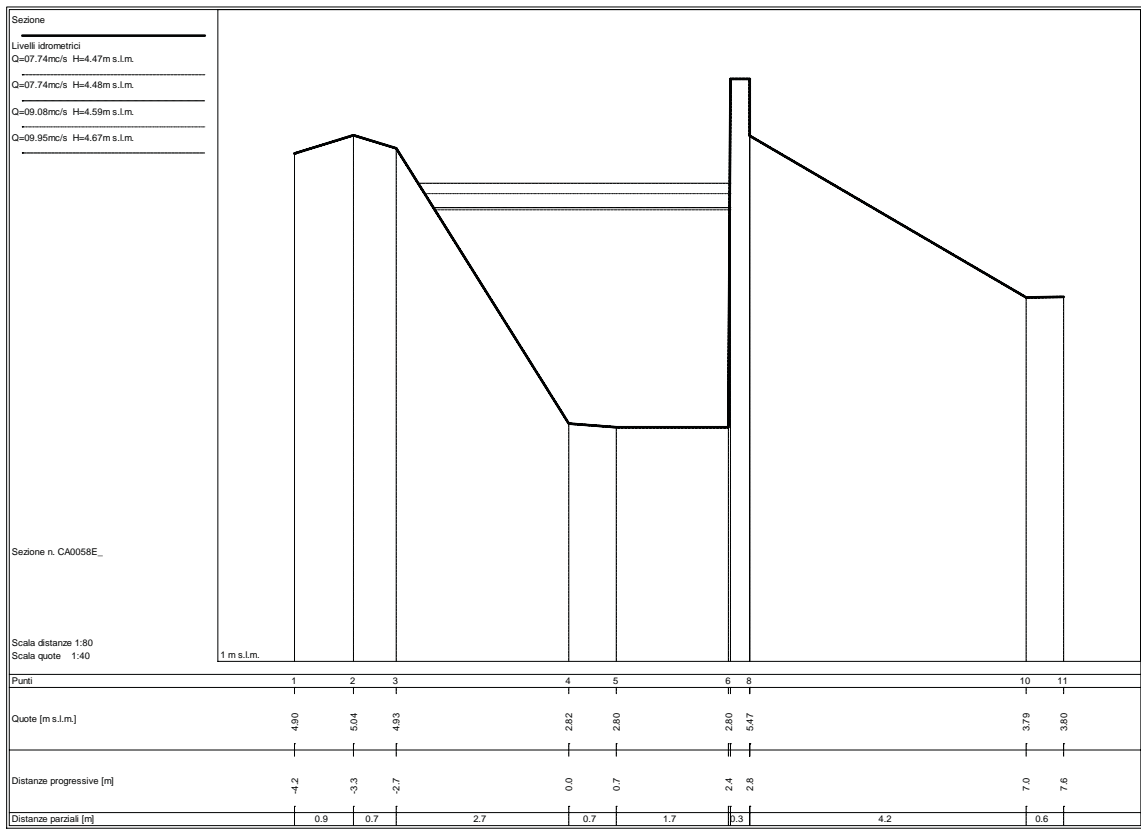
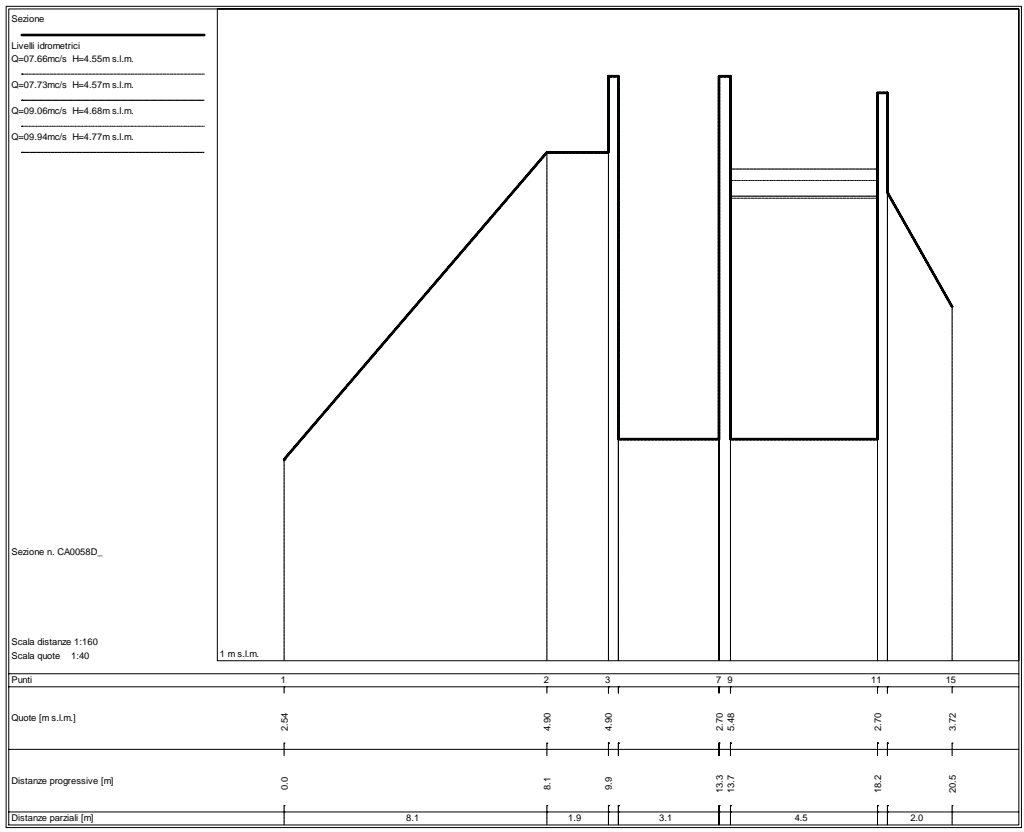

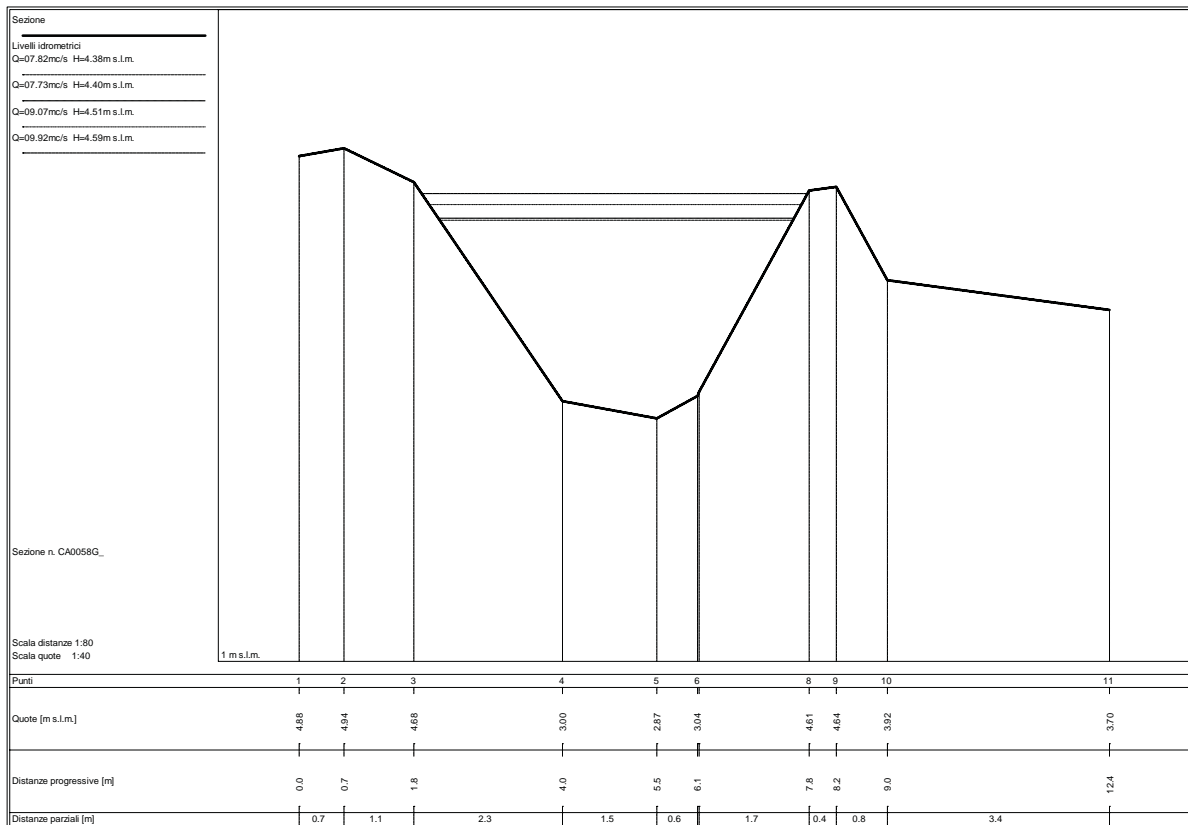
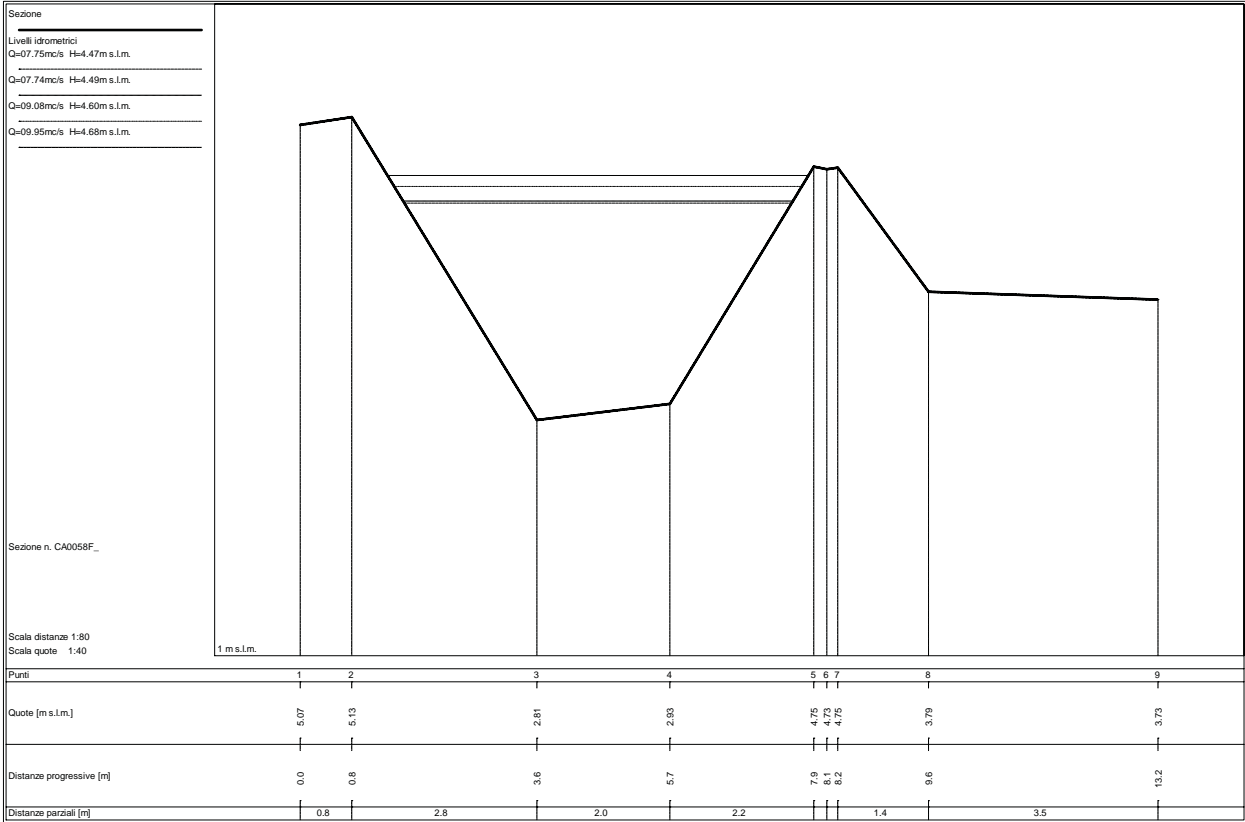

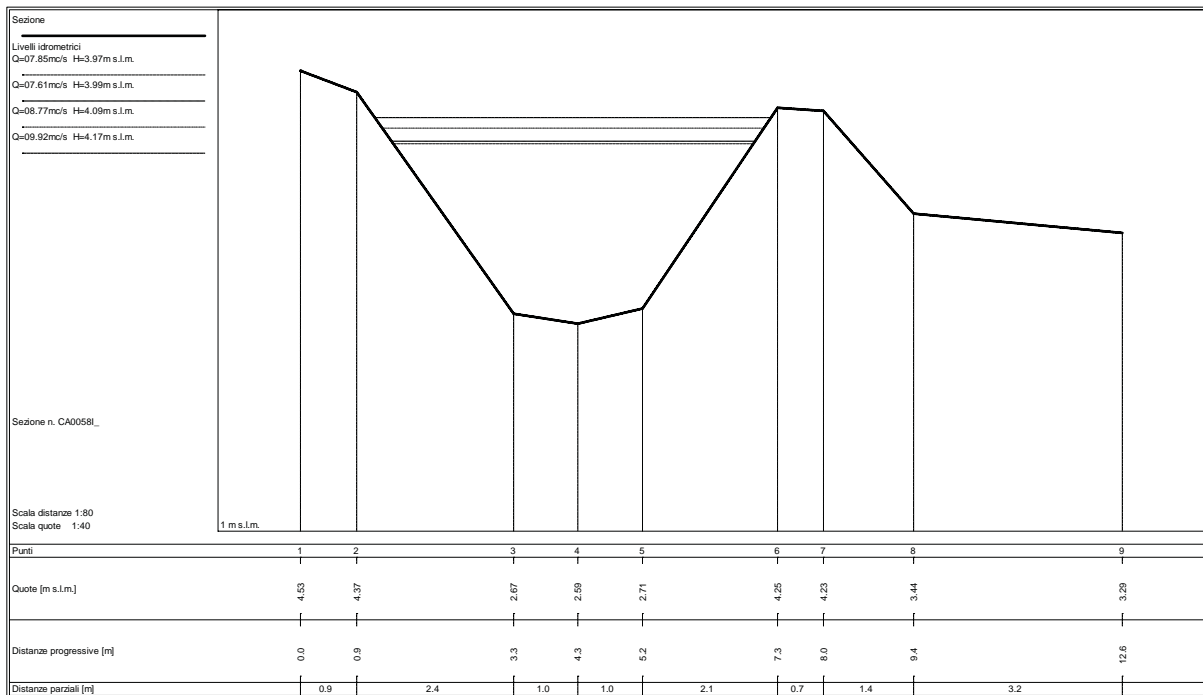
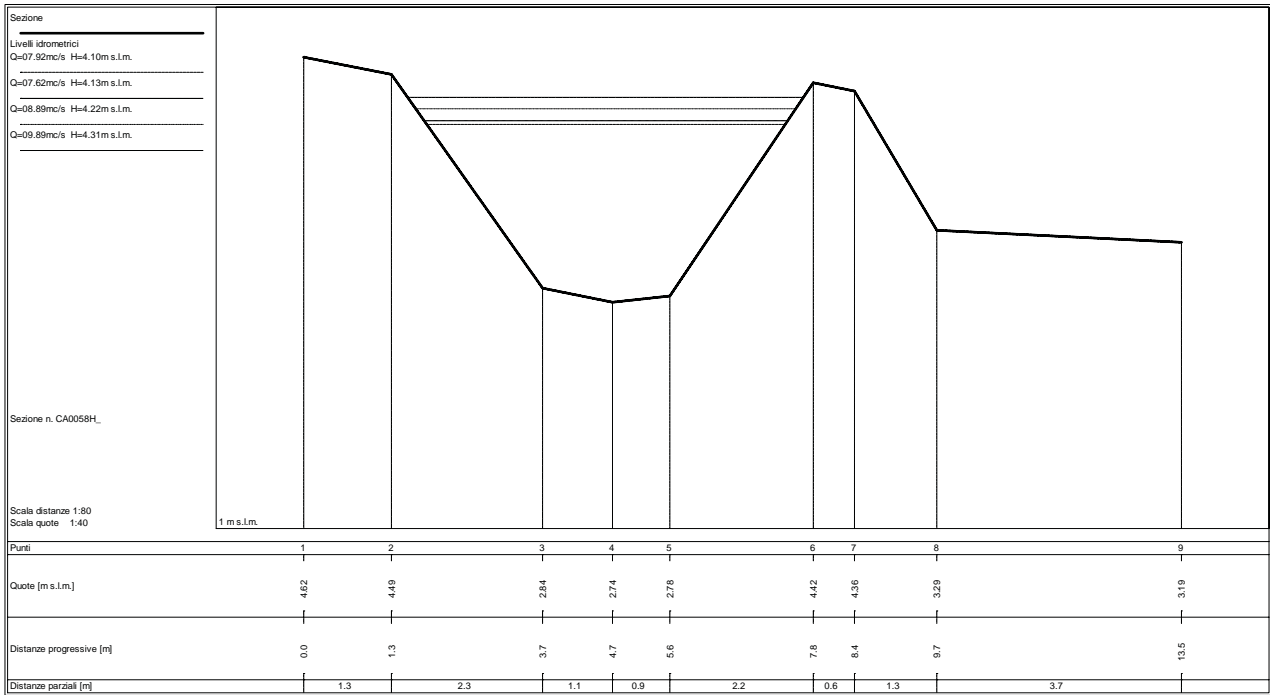

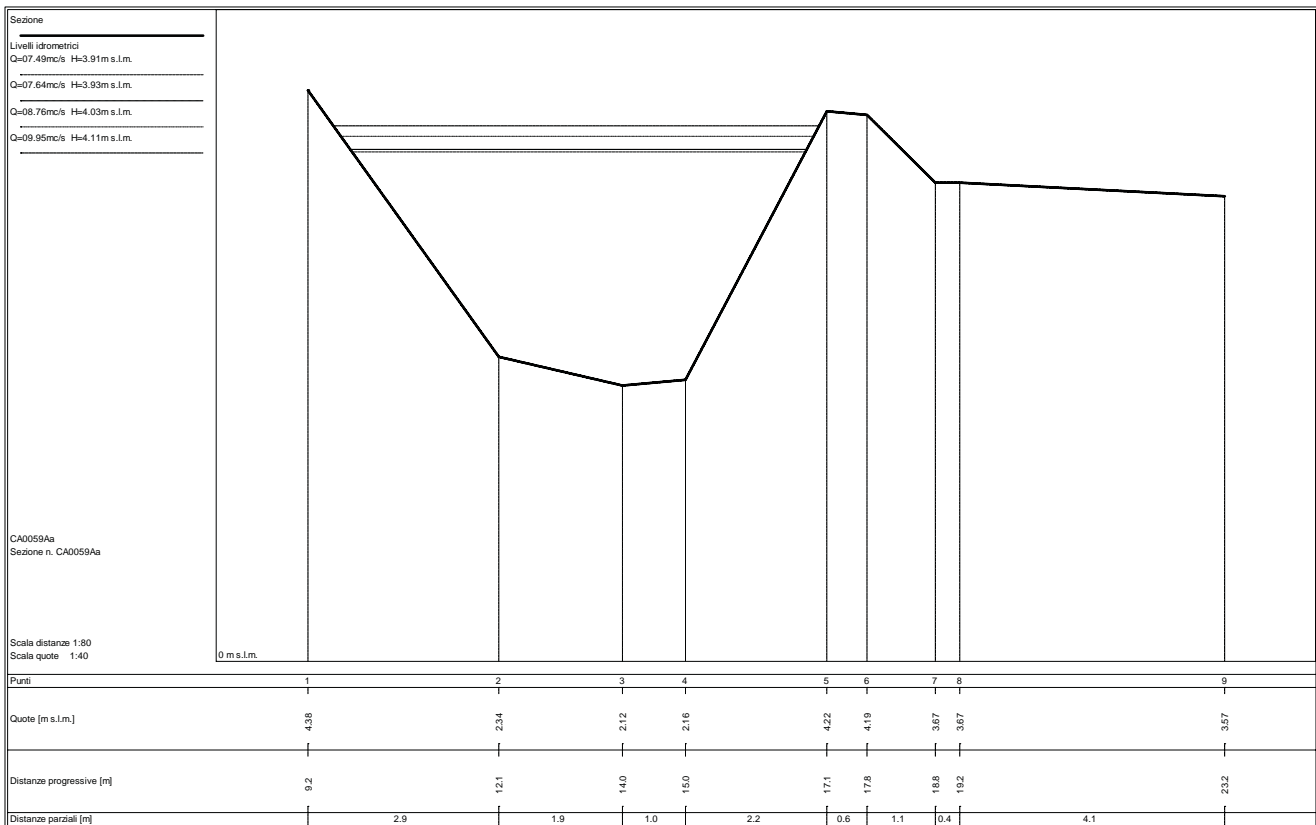
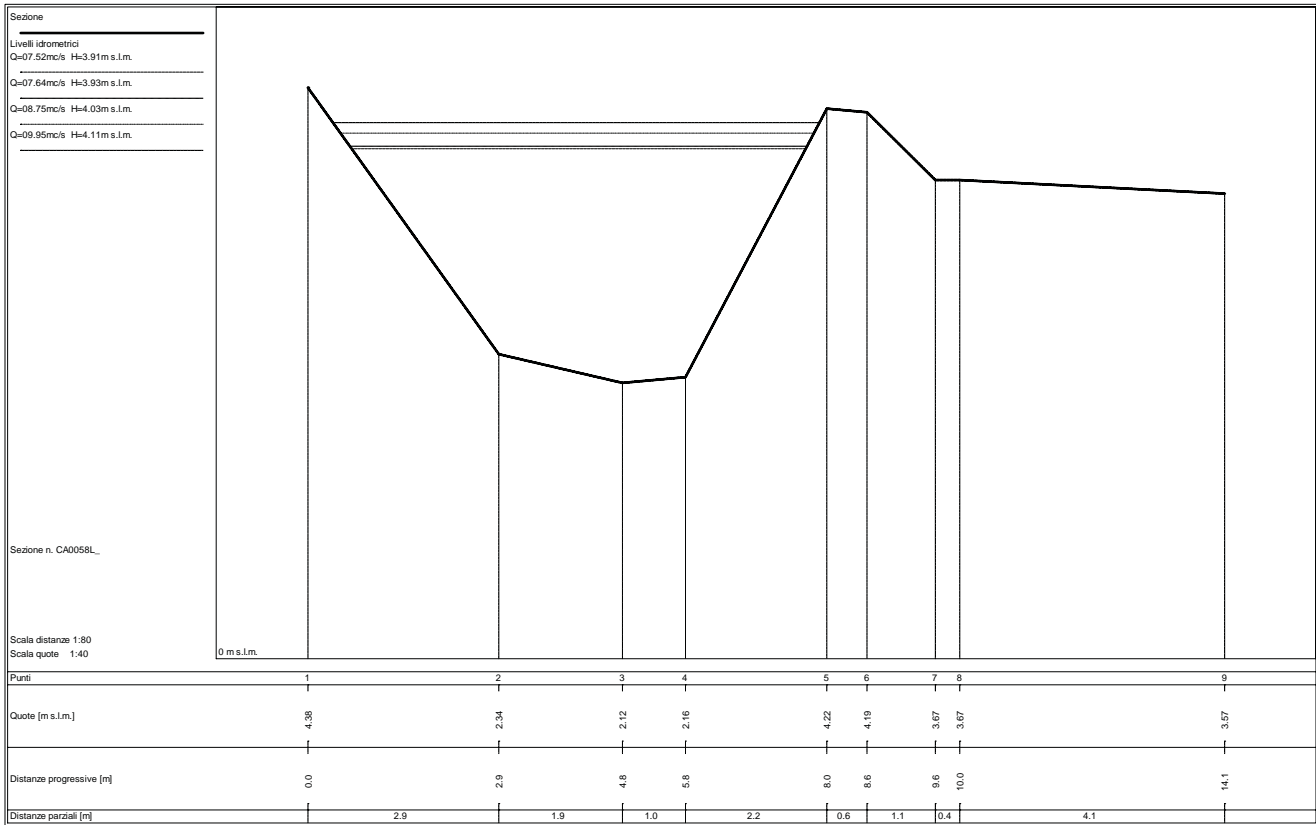

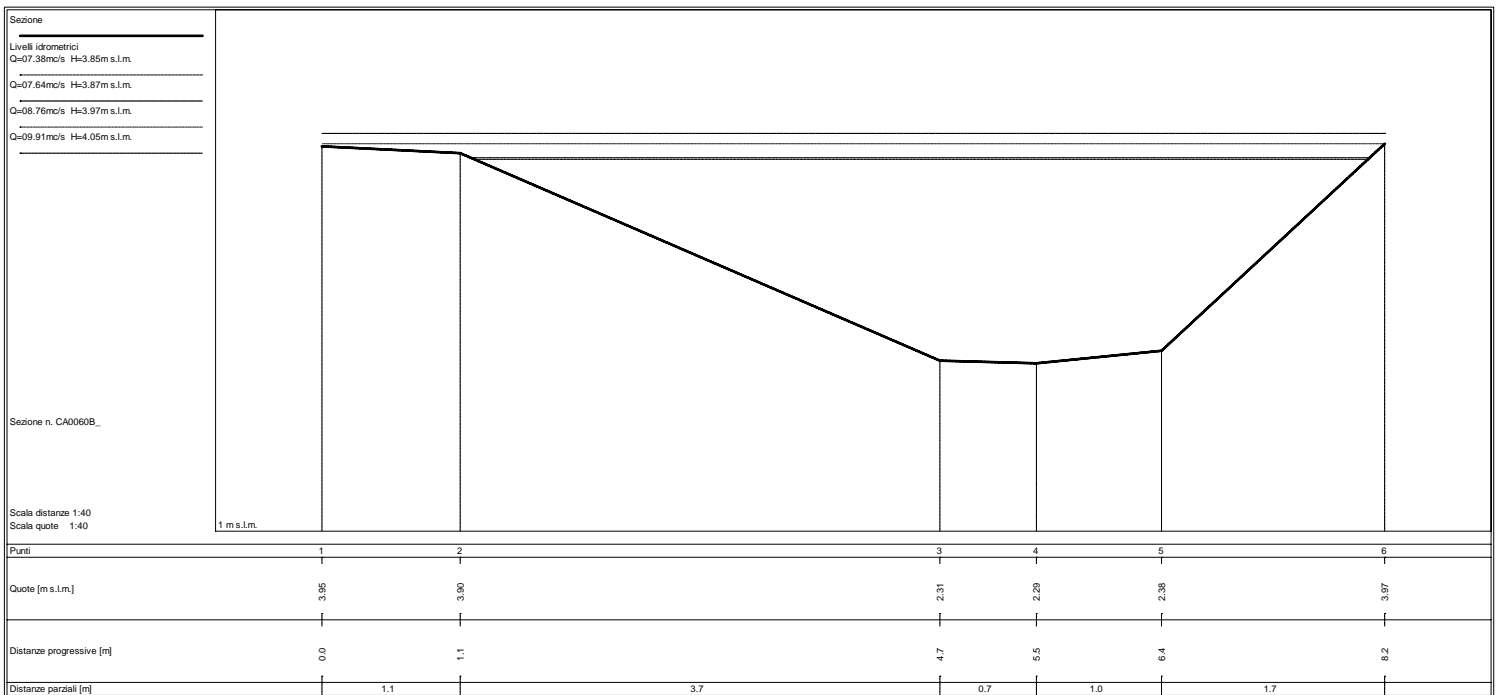
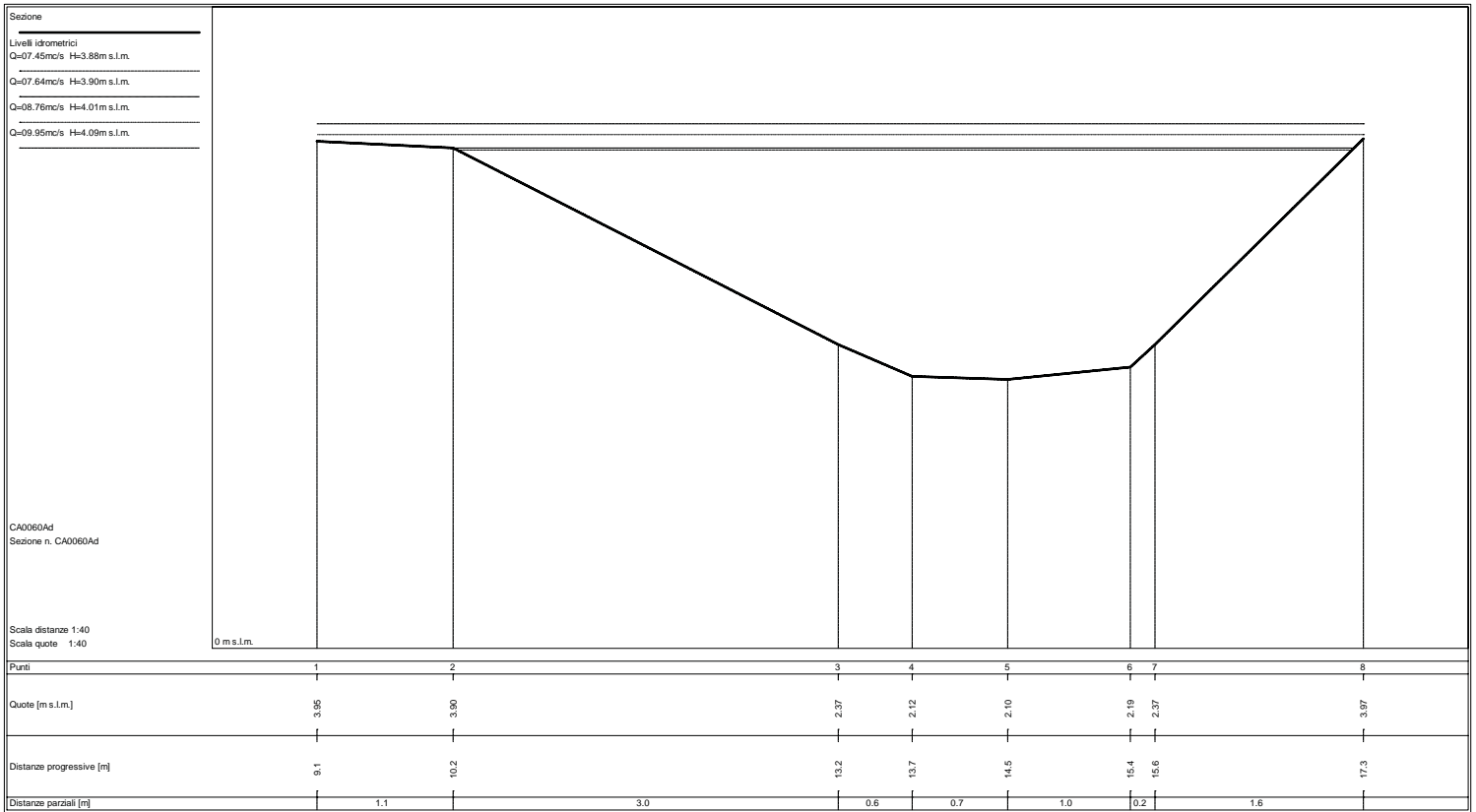

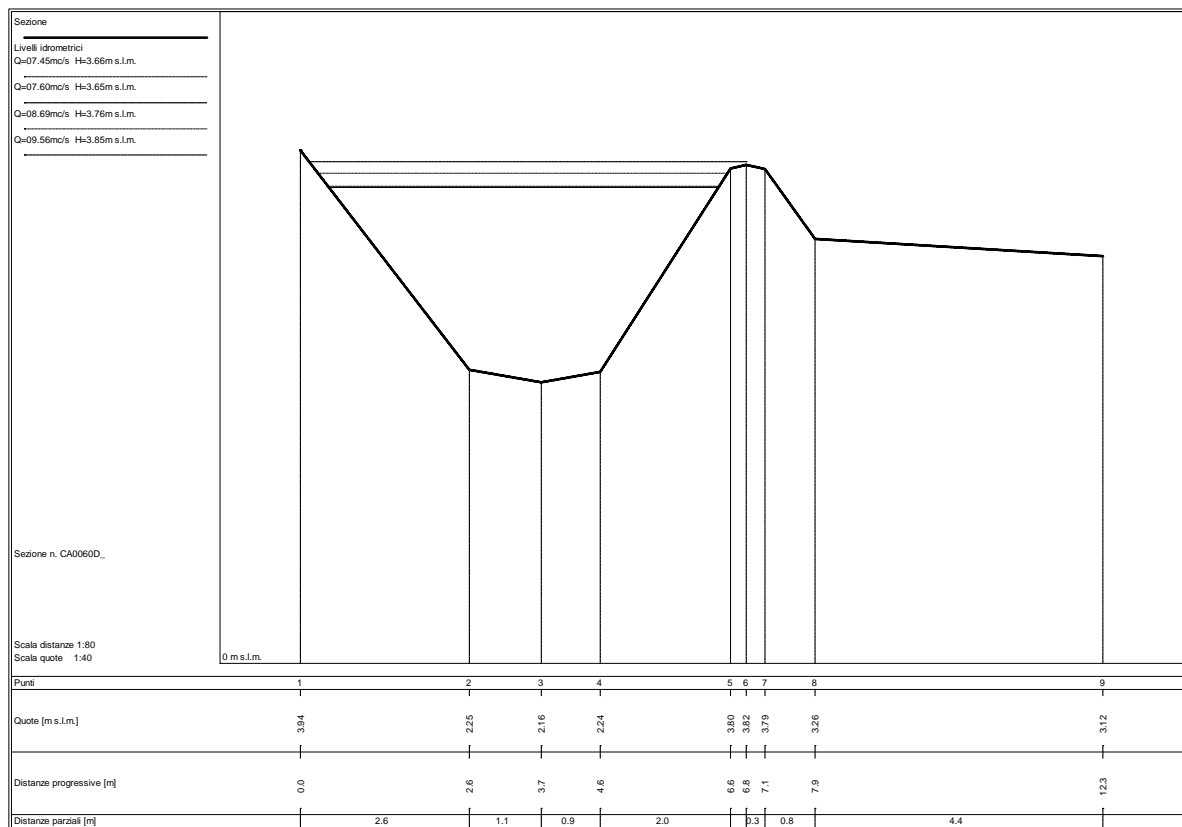
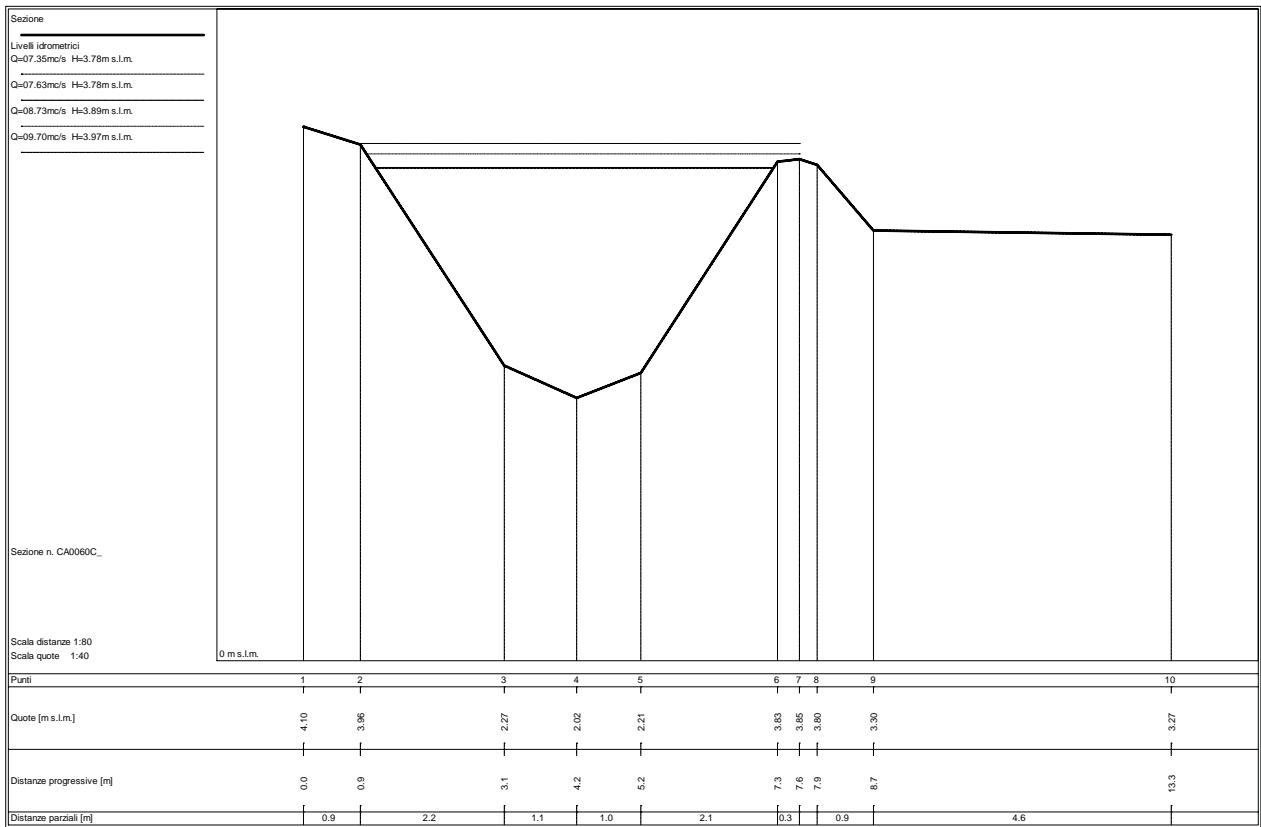

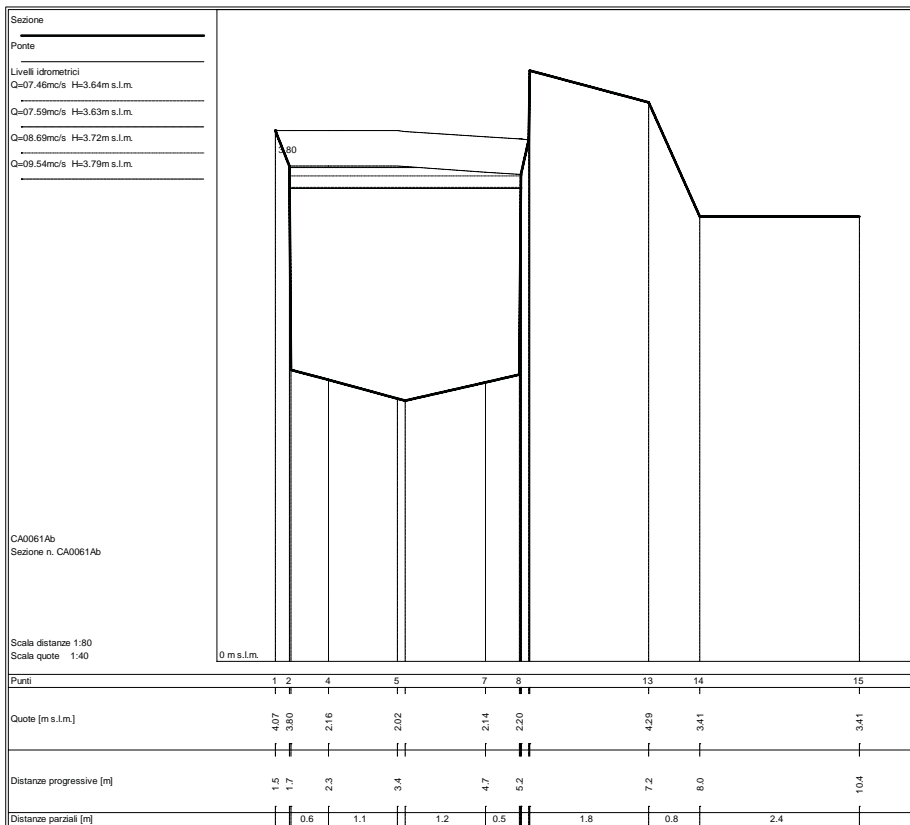
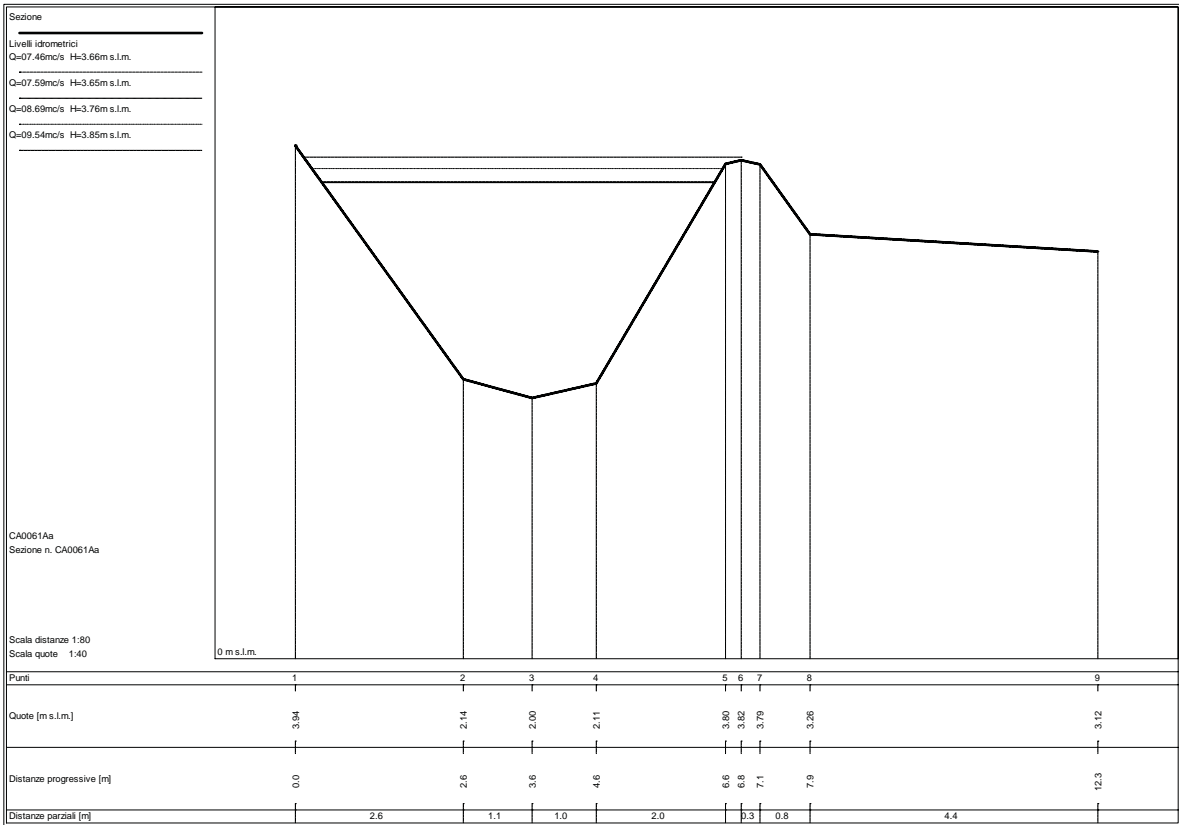

Sezione

Ponte

Livelli idrometrici

Q=07.46mc/s H=3.63m s.l.m.

Q=07.59mc/s H=3.62m s.l.m.

Q=08.68mc/s H=3.71m s.l.m.

Q=09.54mc/s H=3.78m s.l.m.

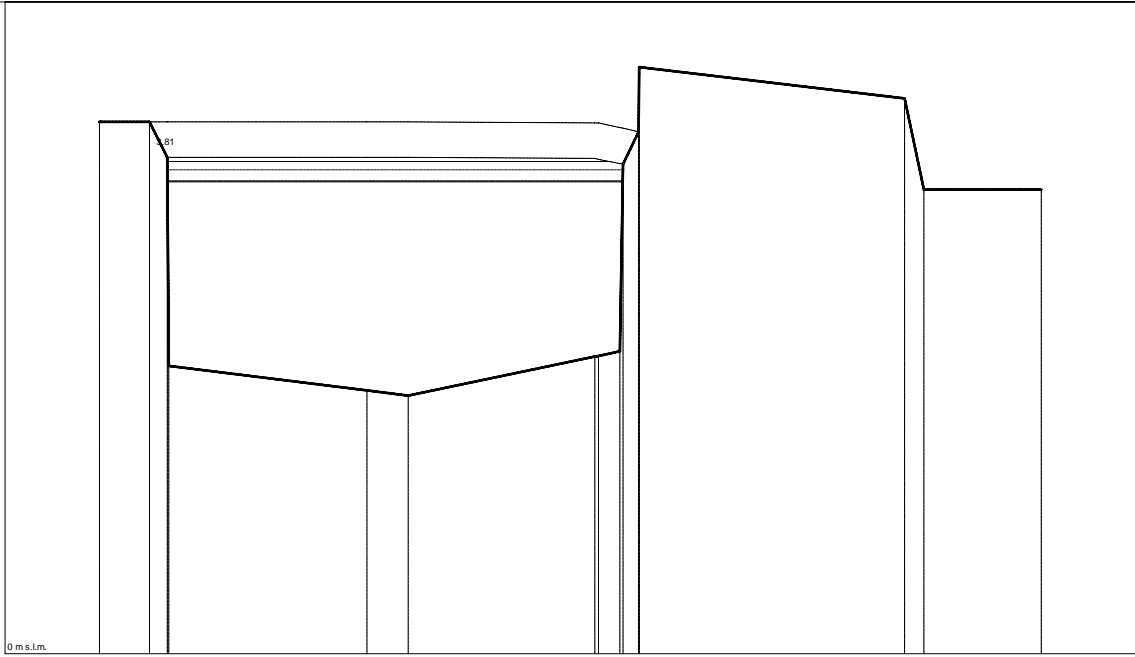

CA0062Ac
Sezione n. CA0062Ac

Scala distanze 1:40
Scala quote 1:40

Punti	1	2	3	5	6	7	9	11	13	14	15
Quote [m s.l.m.]	4.08	4.08	3.81	2.02	1.98	2.28	2.32	4.01	4.26	3.96	3.96
Distanze progressive [m]	0.9	1.3	1.5	3.0	3.3	4.7	4.9	5.1	7.1	7.3	8.2
Distanze parziali [m]	0.4		1.5	0.3	1.4	0.2		2.0	0.1	0.9	

Sezione

Livelli idrometrici

Q=07.46mc/s H=3.64m s.l.m.

Q=07.59mc/s H=3.64m s.l.m.

Q=08.68mc/s H=3.74m s.l.m.

Q=09.53mc/s H=3.81m s.l.m.

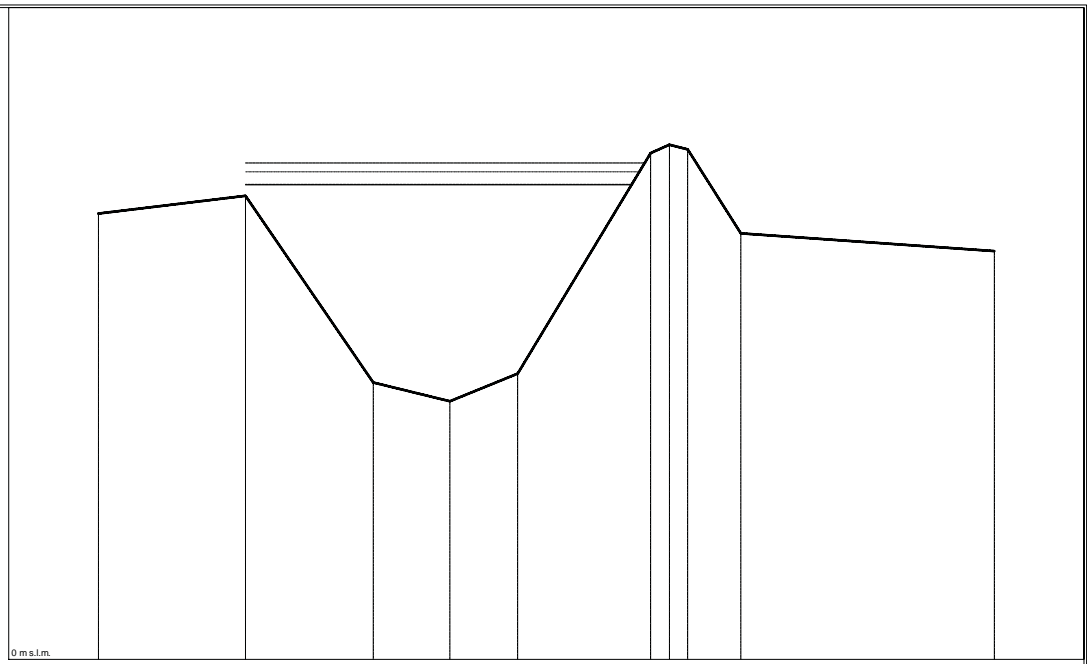

CA0062Ad
Sezione n. CA0062Ad

Scala distanze 1:80
Scala quote 1:40

Punti	1	2	3	4	5	6	7	8	9	10
Quote [m s.l.m.]	3.42	3.56	2.13	1.98	2.19	3.89	3.95	3.91	3.27	3.13
Distanze progressive [m]	2.1	0.2	2.1	3.3	4.3	6.4	6.7	6.9	7.8	11.7
Distanze parziali [m]		2.3	2.0	1.2	1.0	2.0		0.8	3.9	

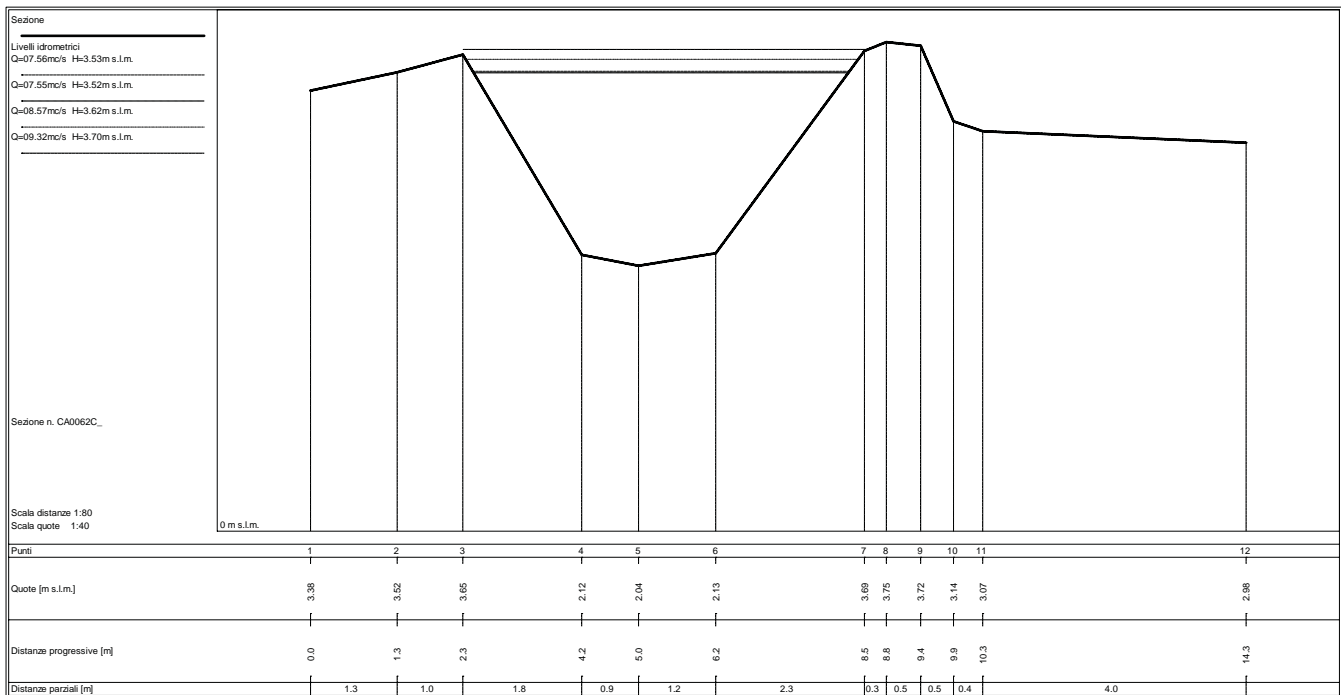
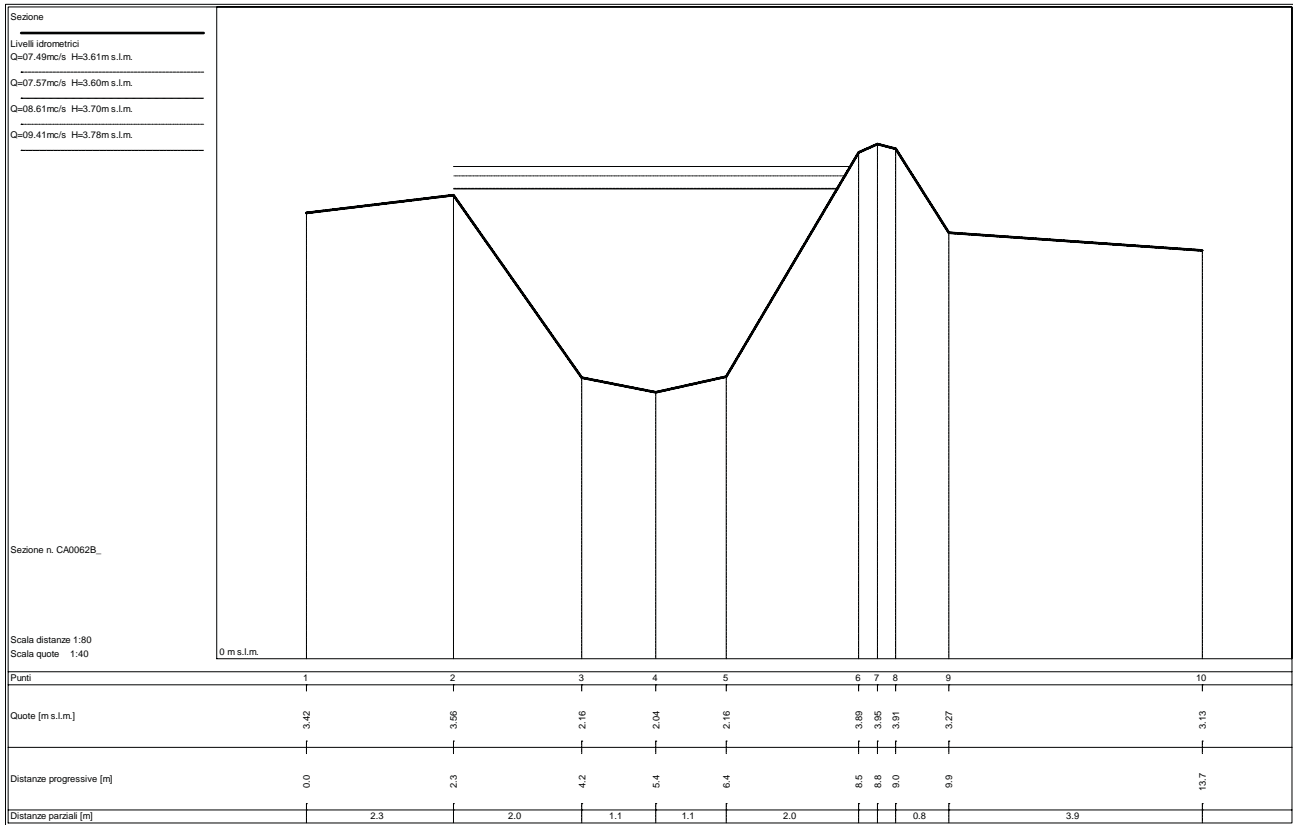

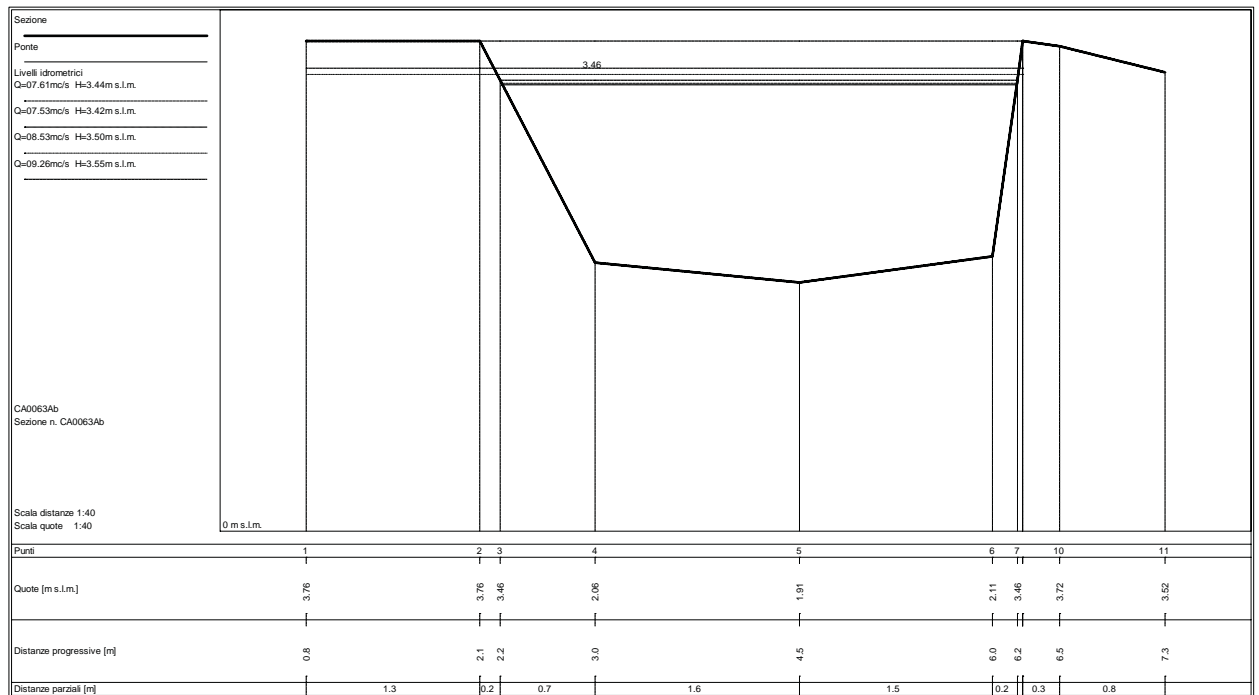
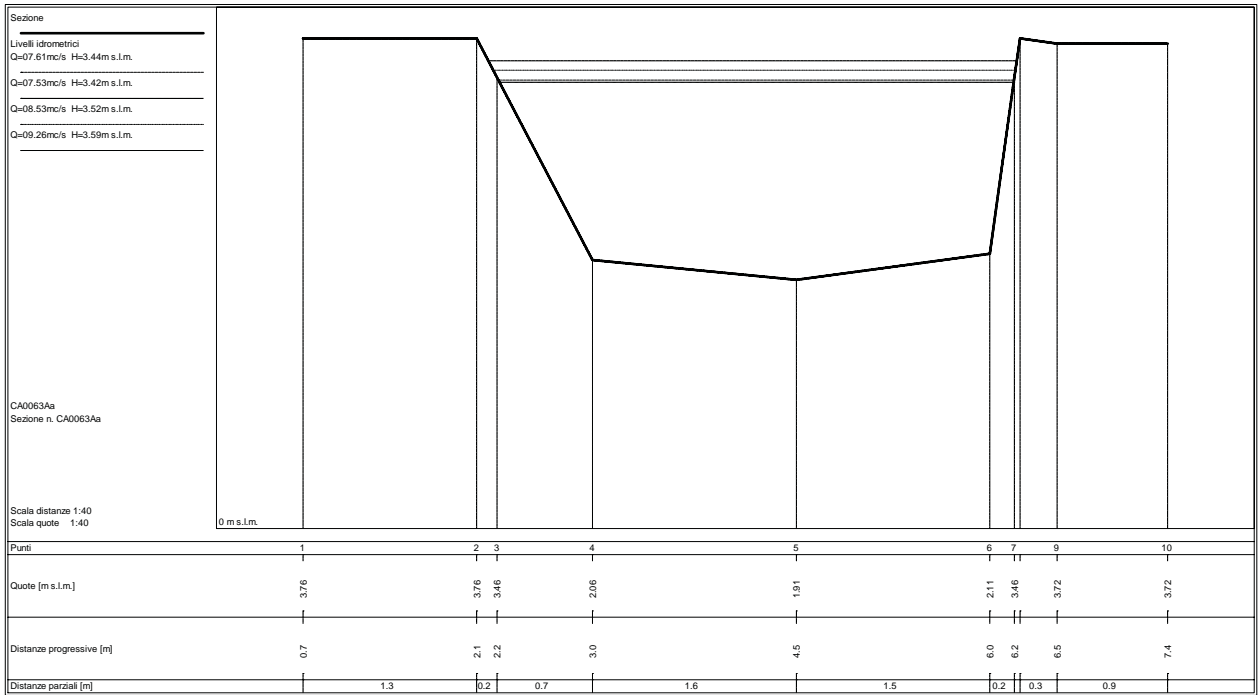

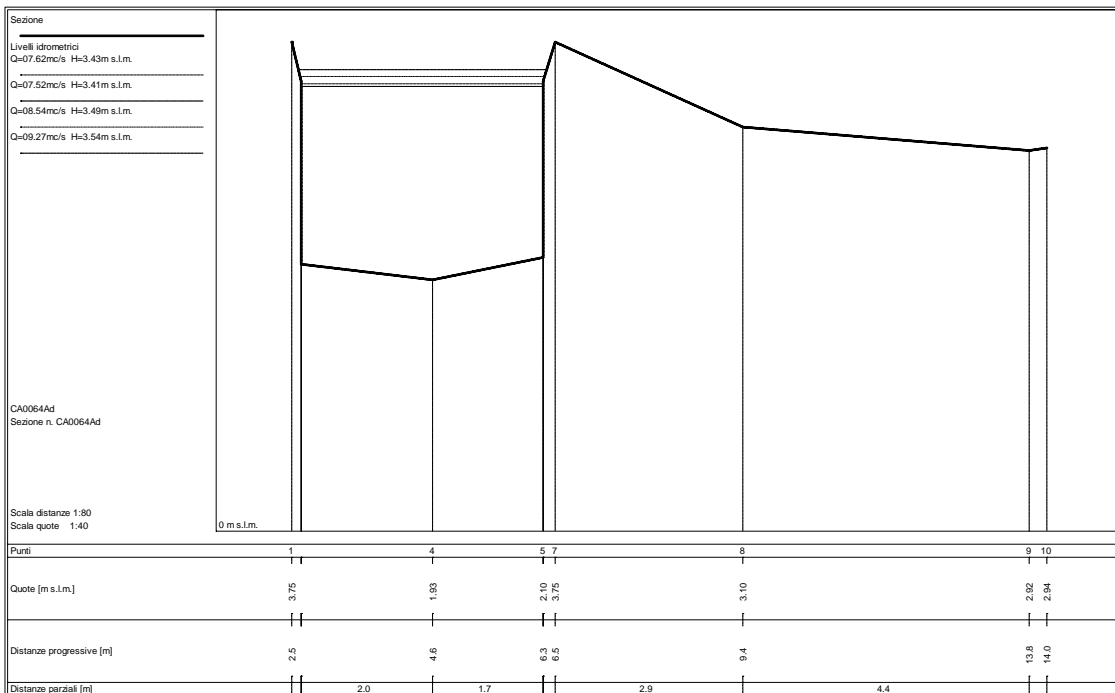
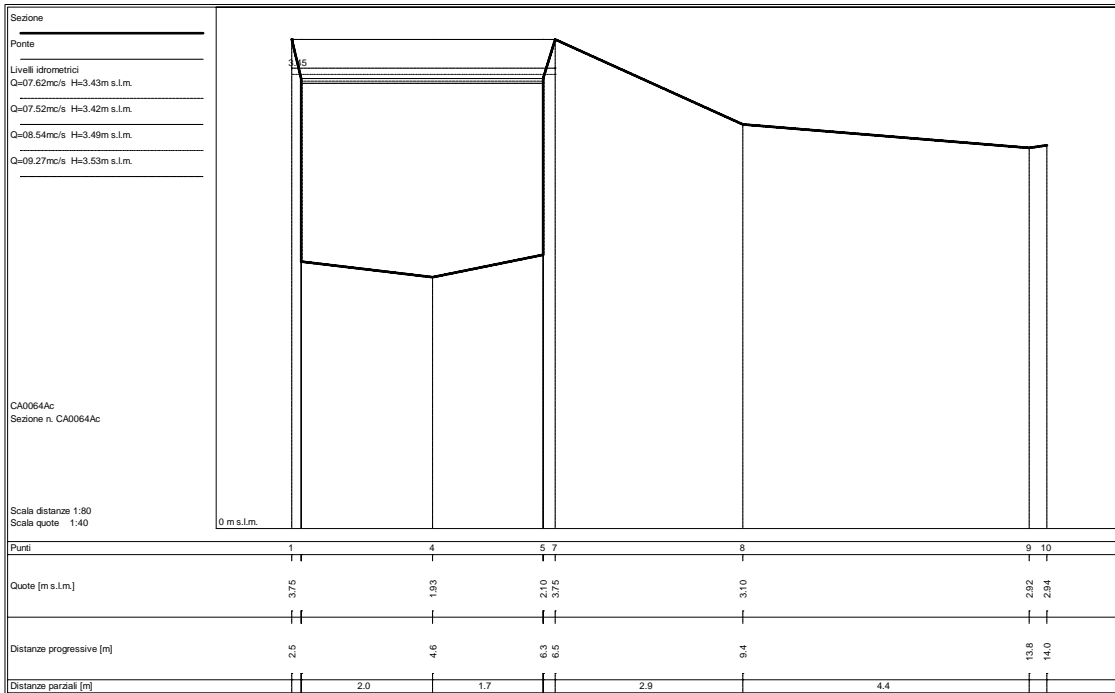

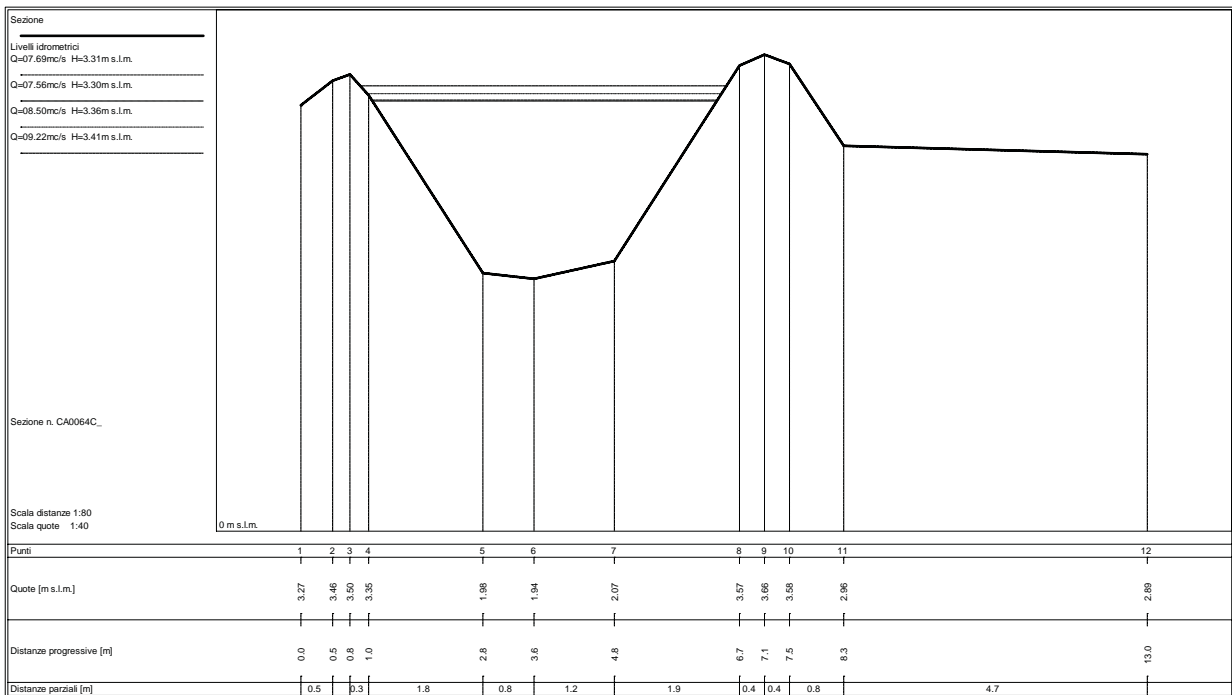
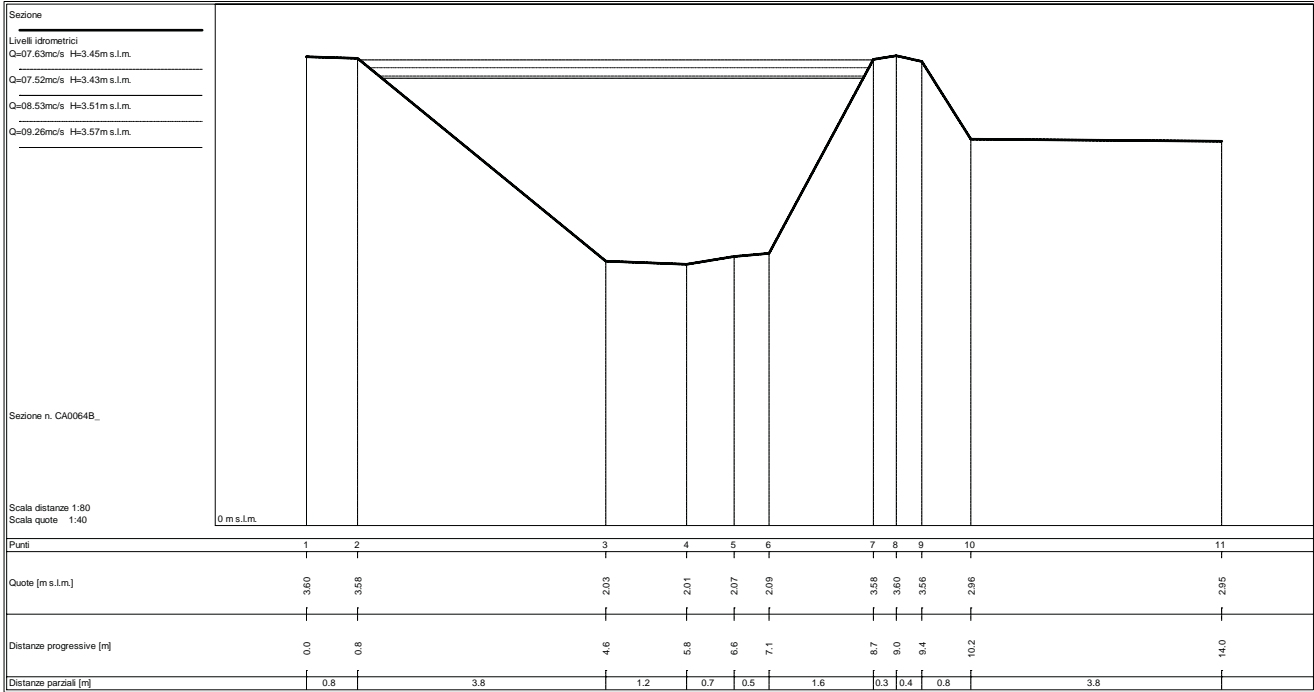

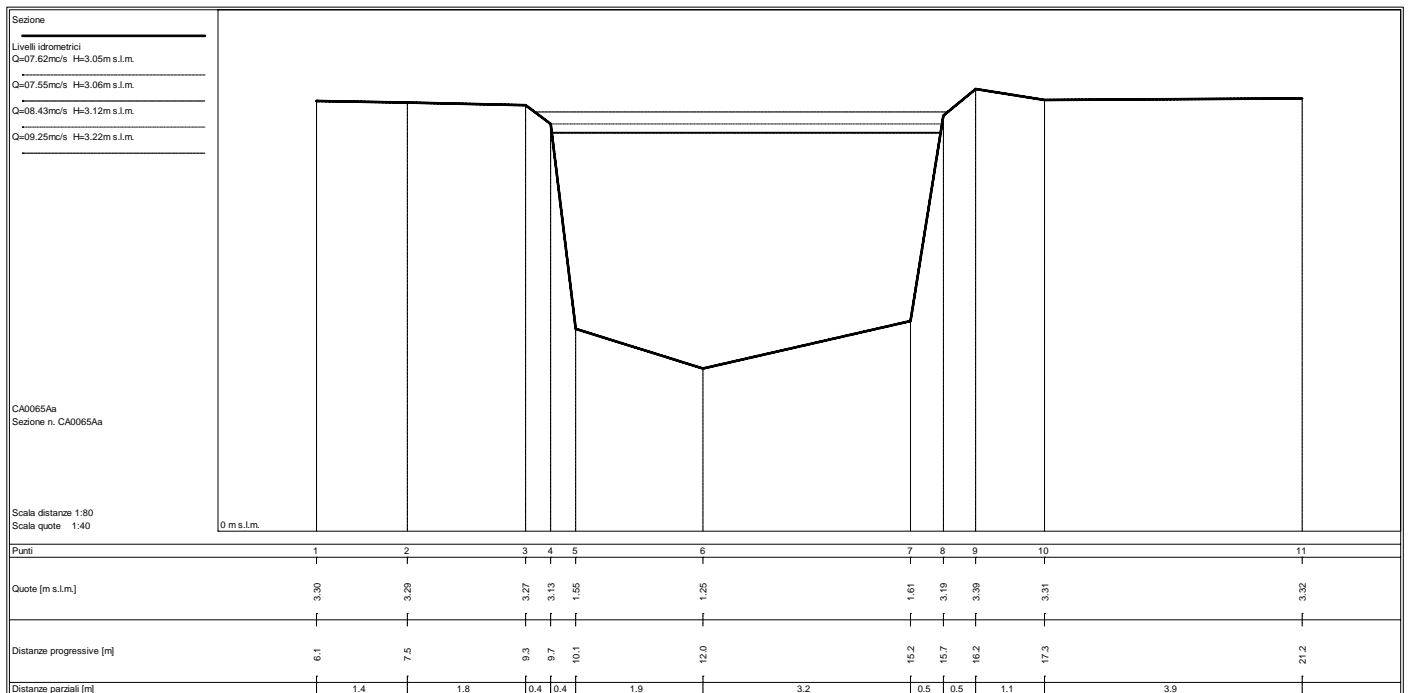
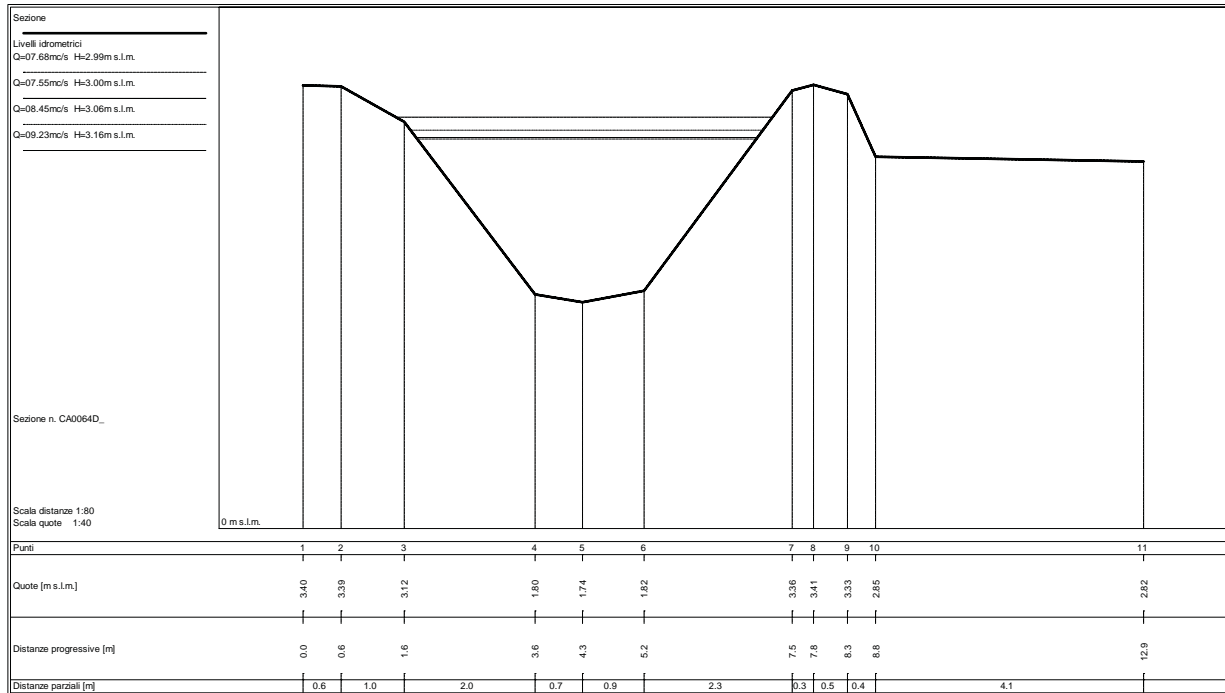

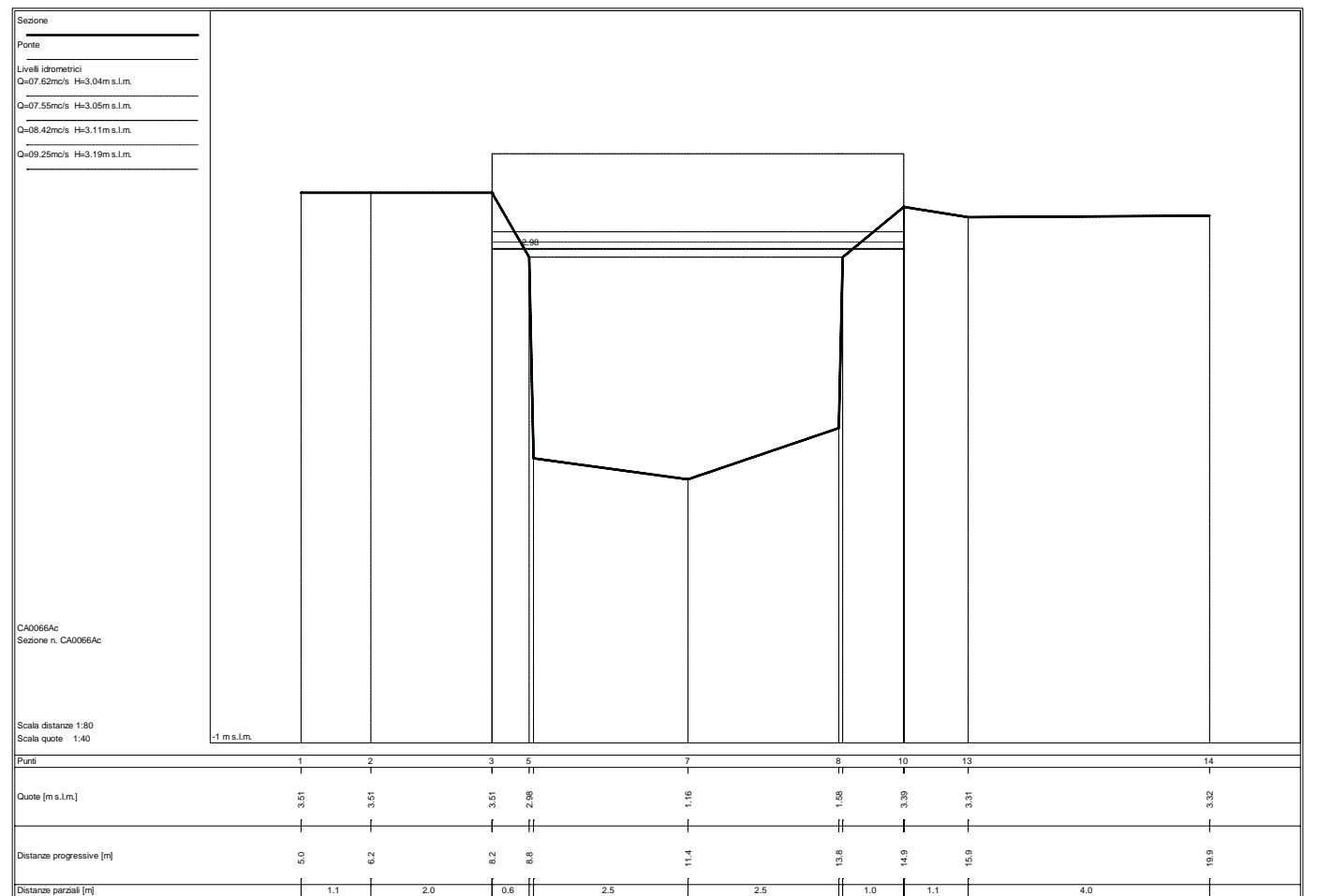
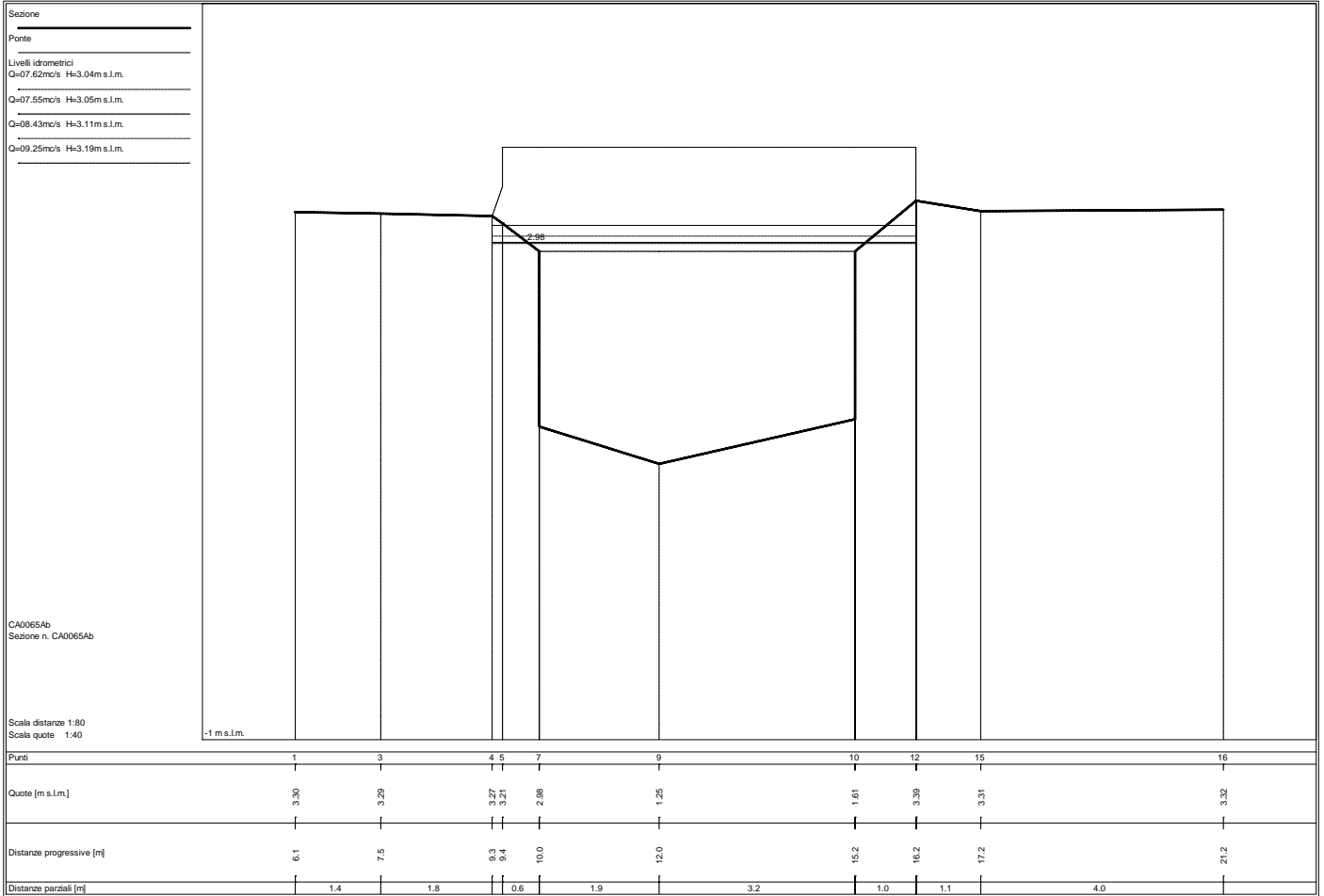

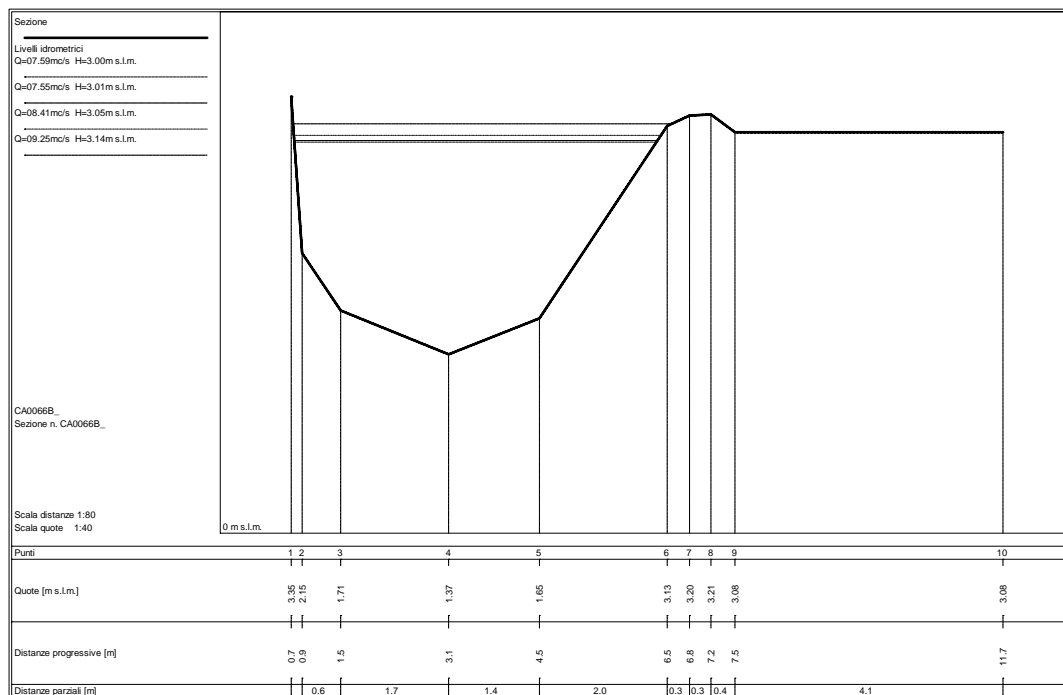
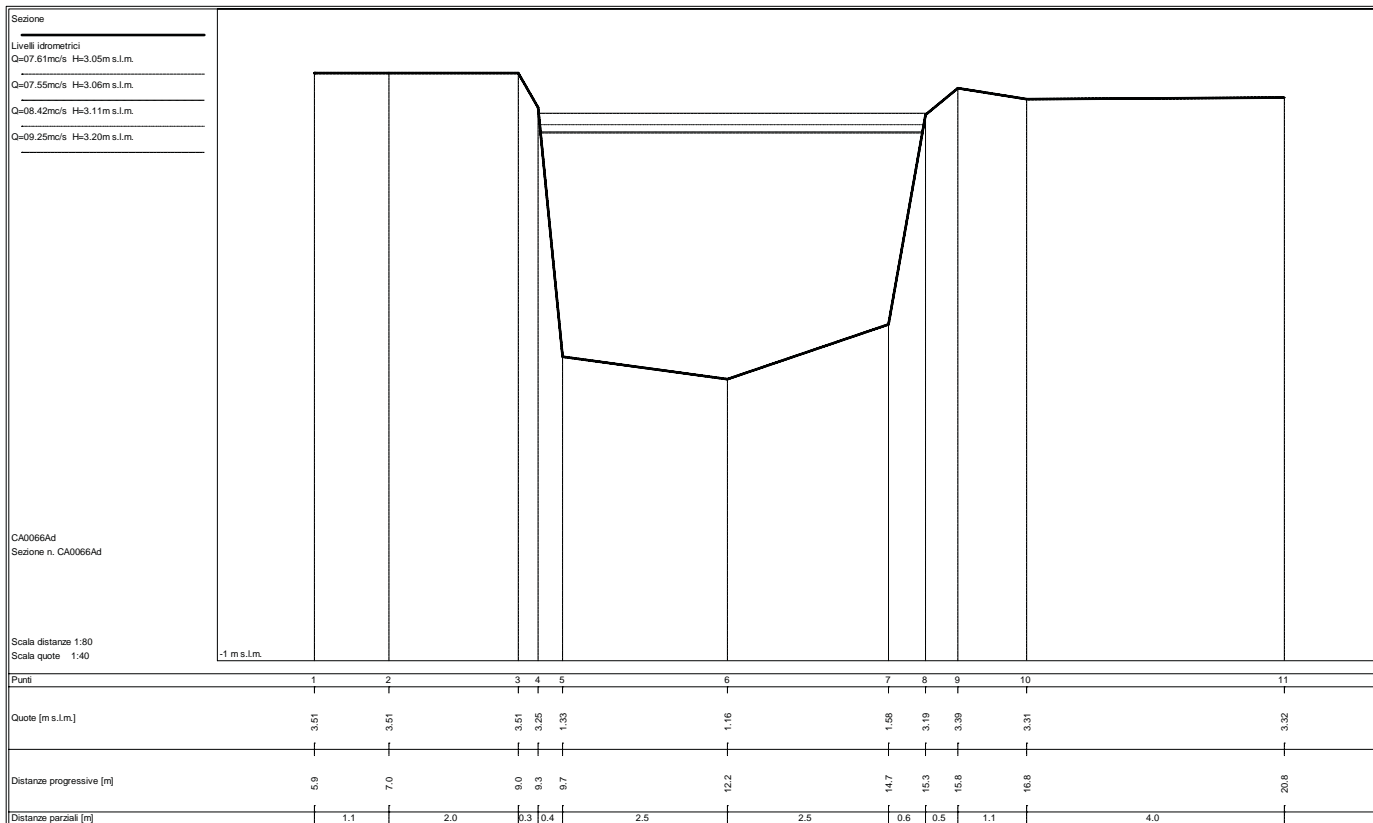

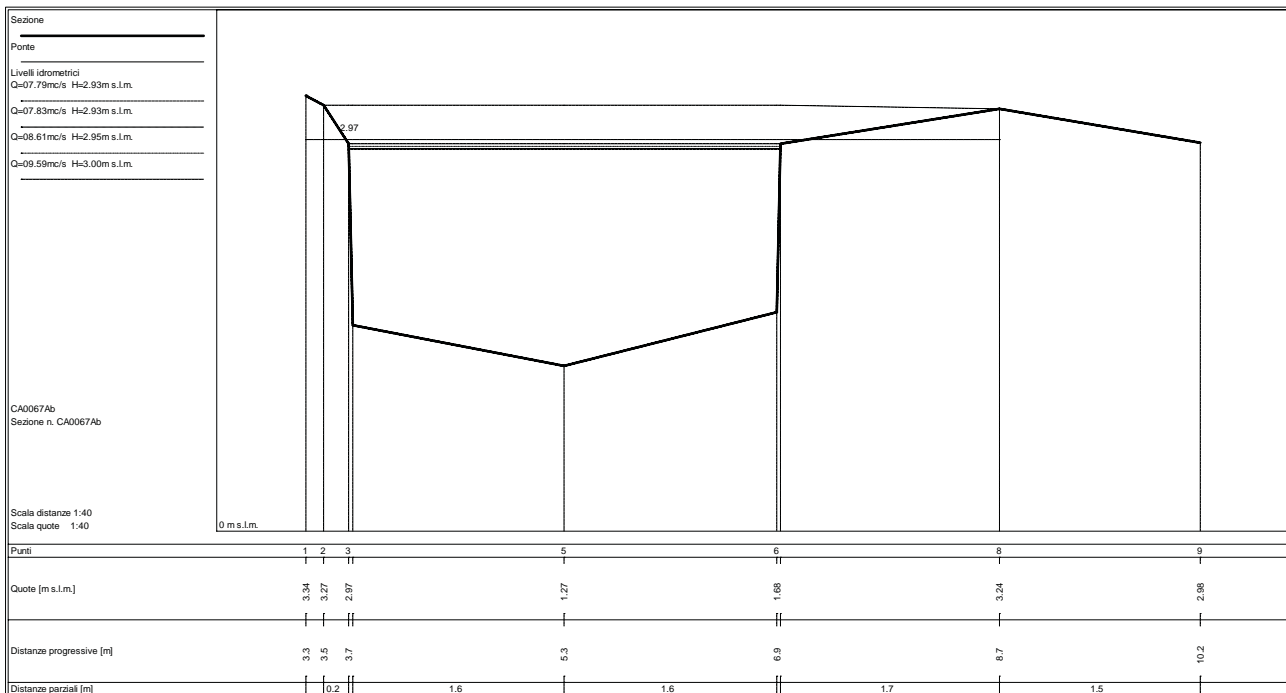
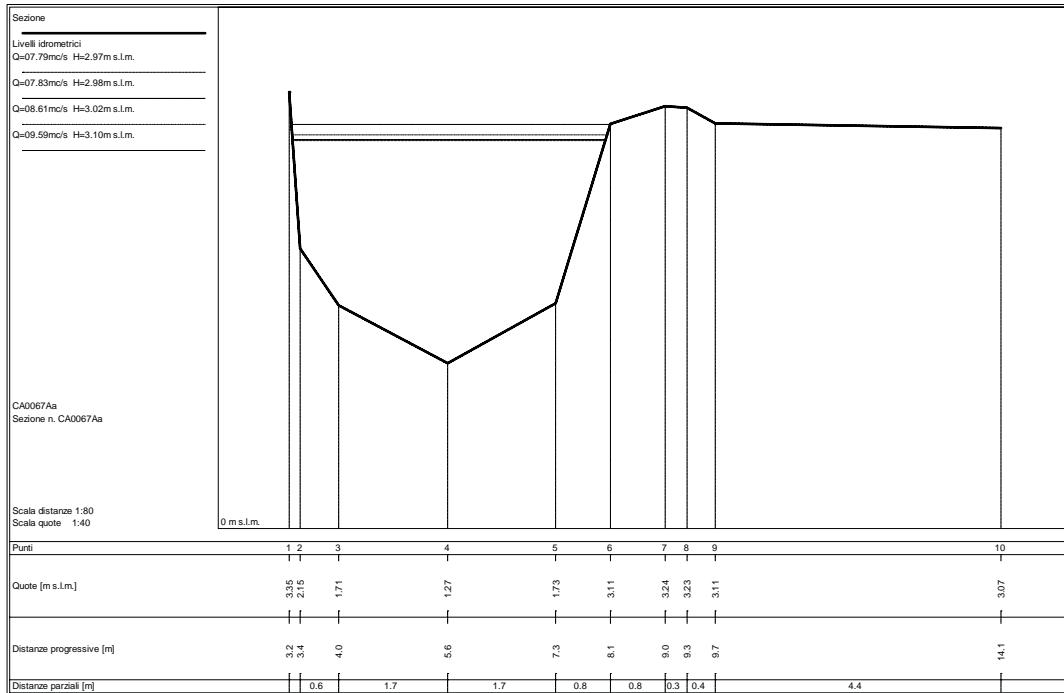

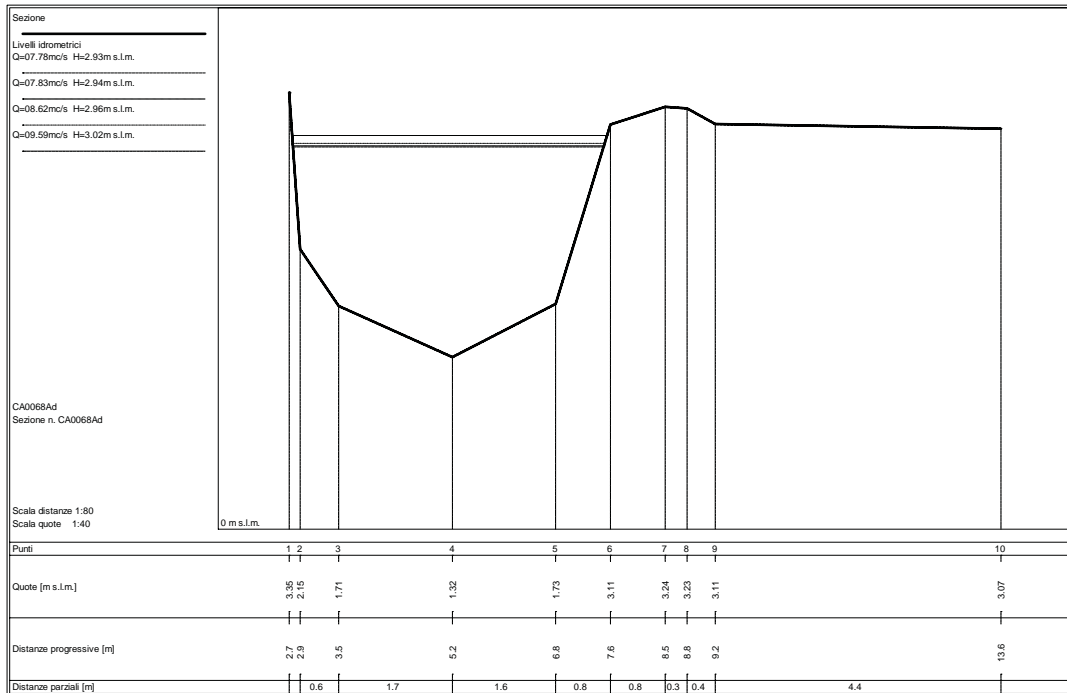
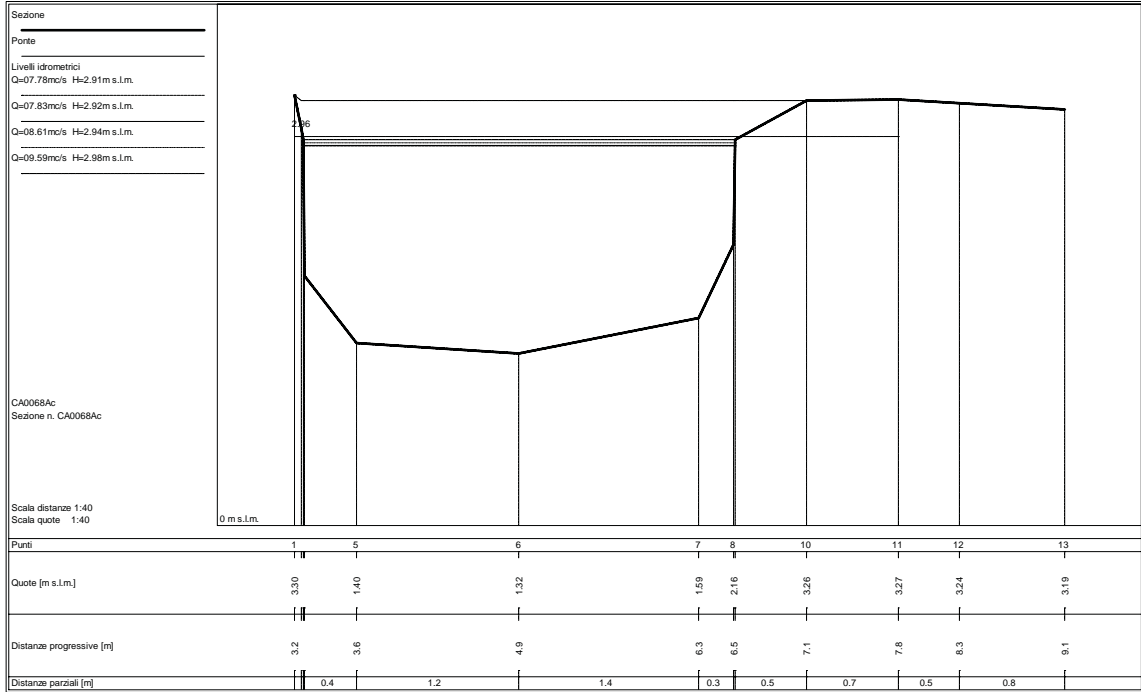

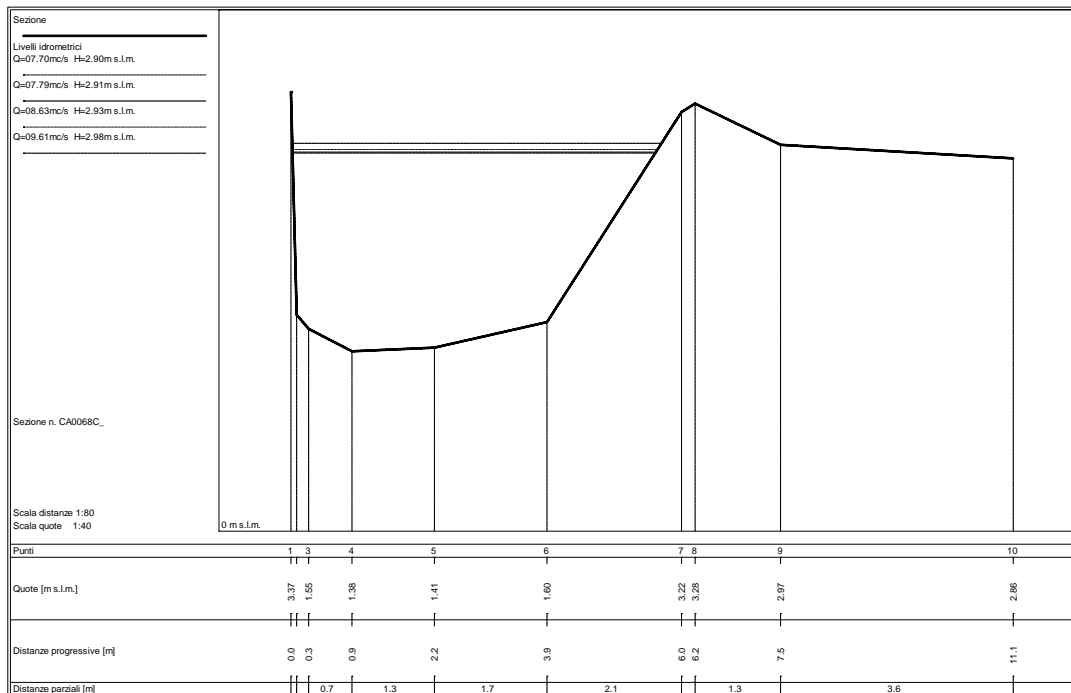
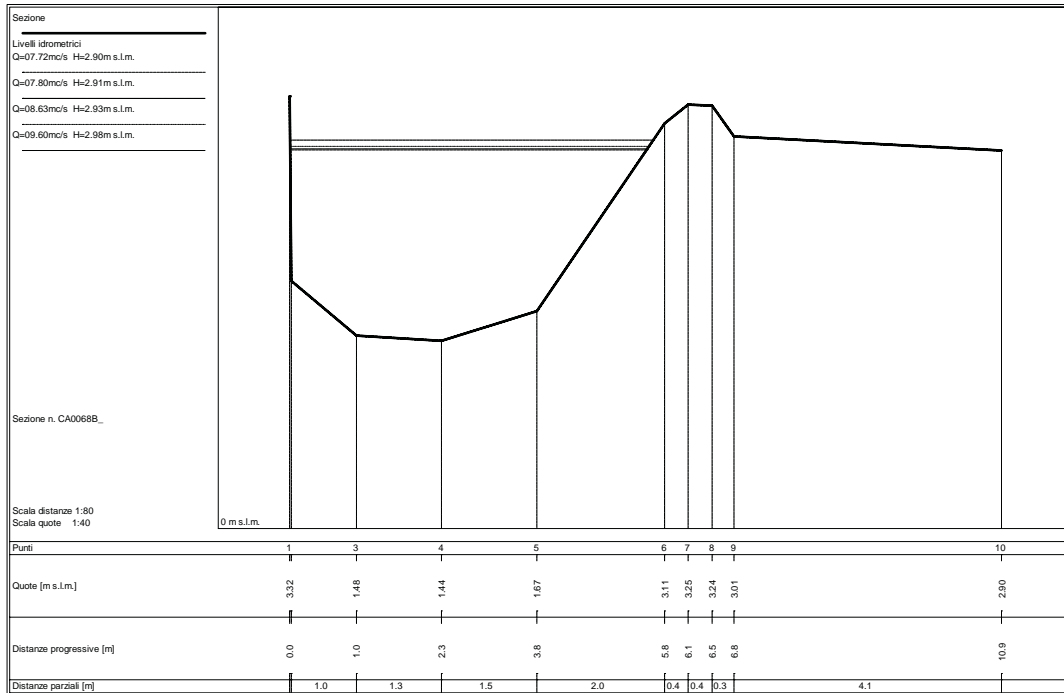

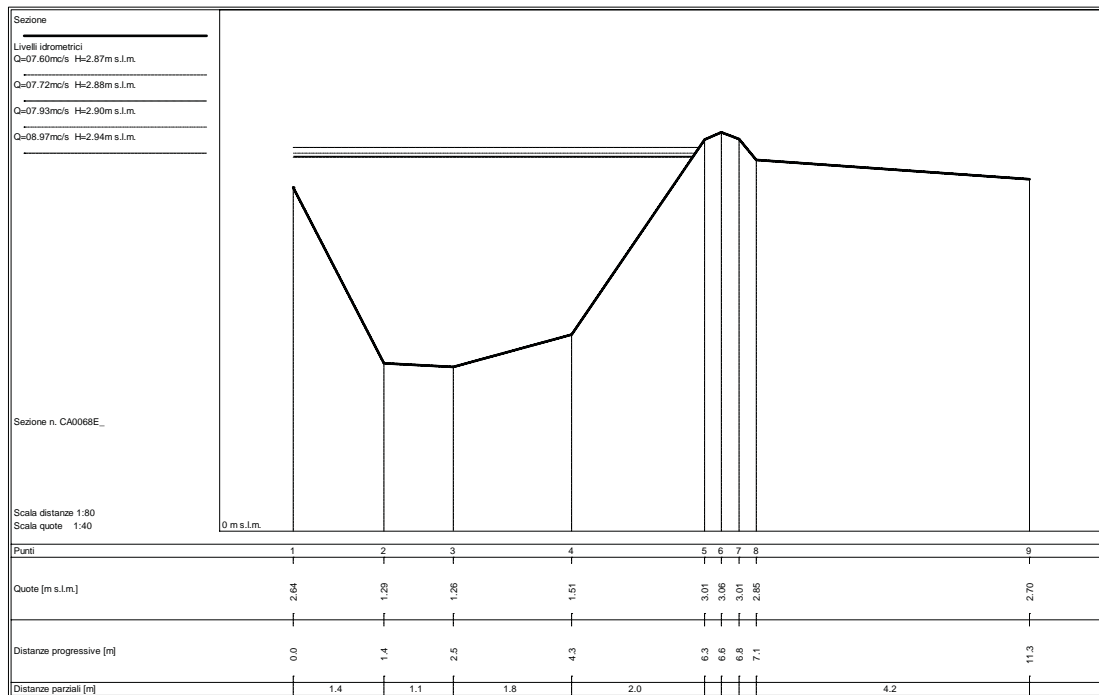
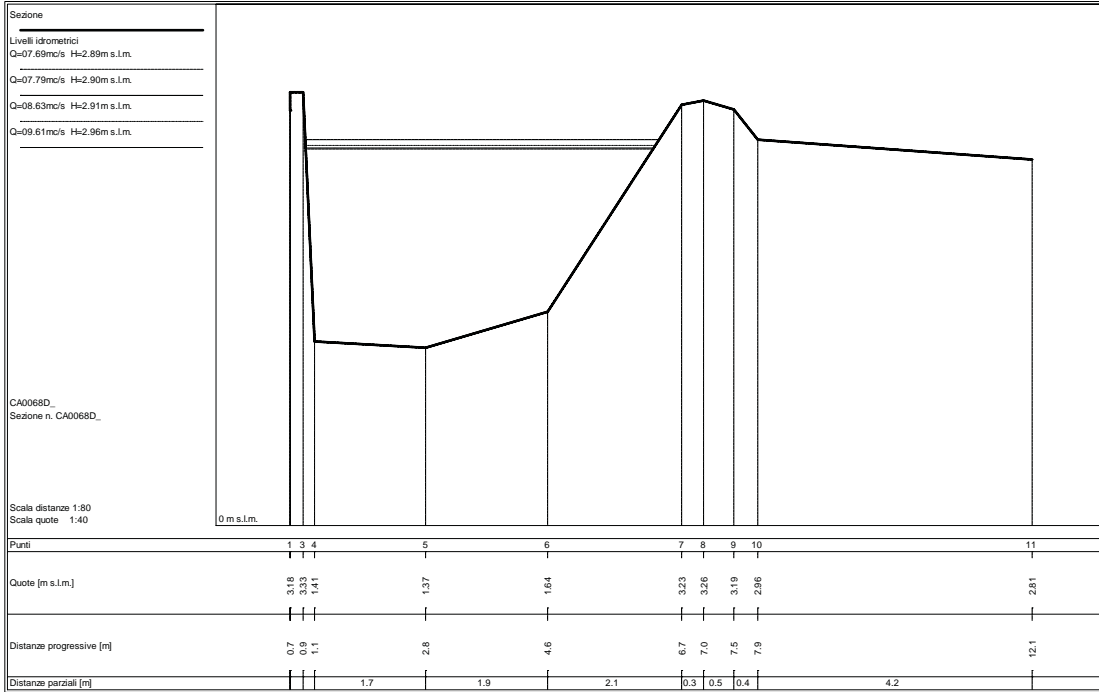

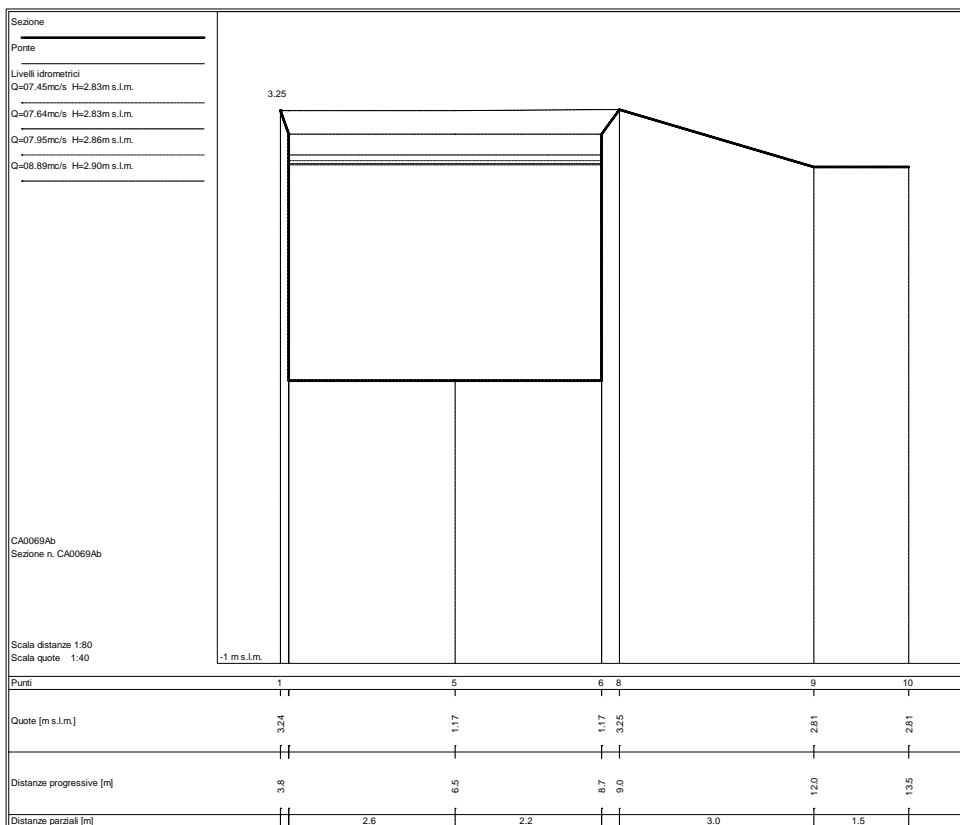
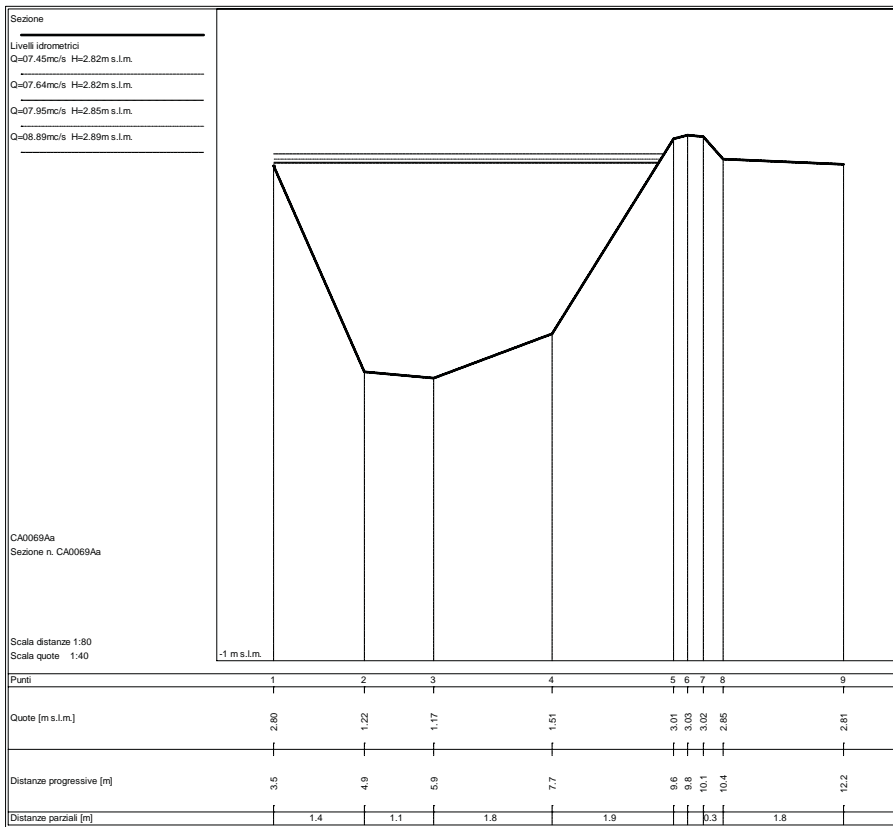

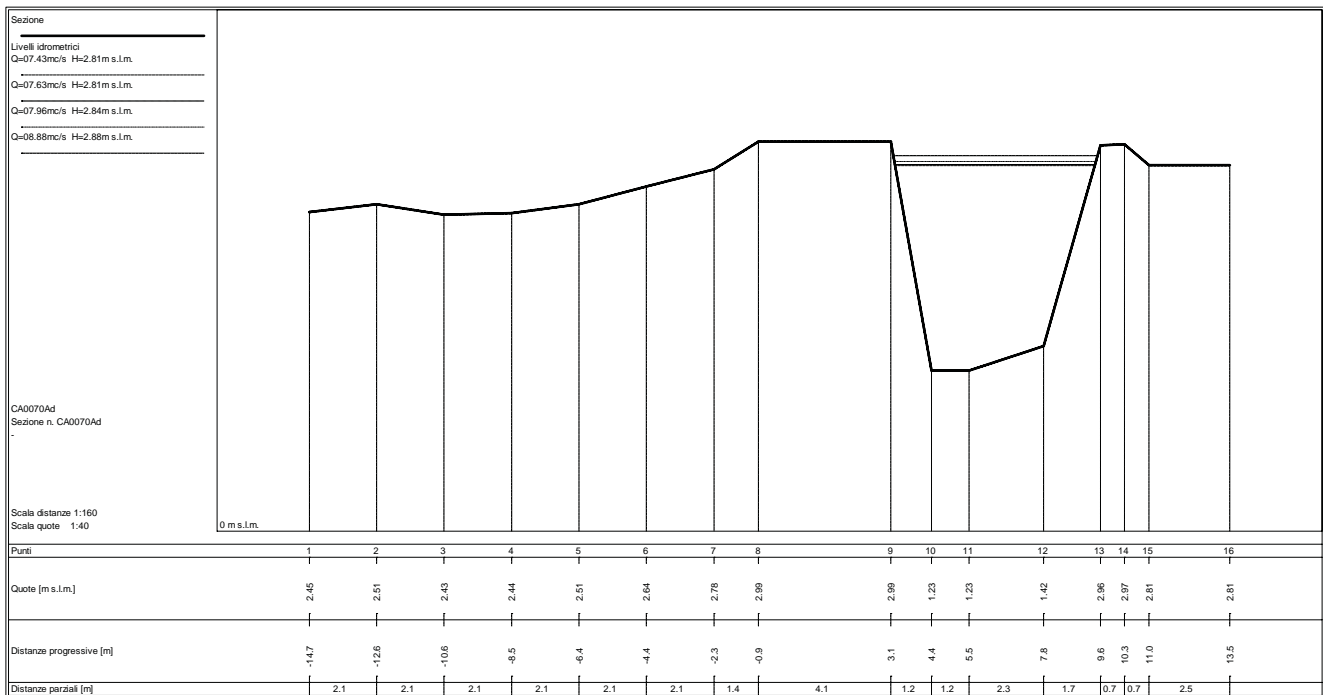
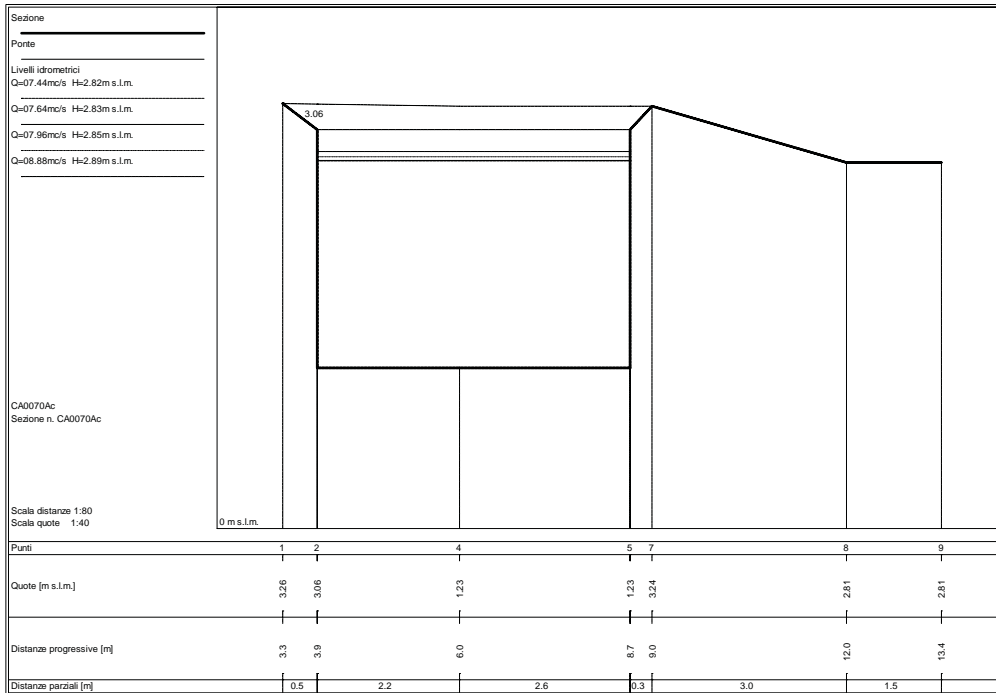

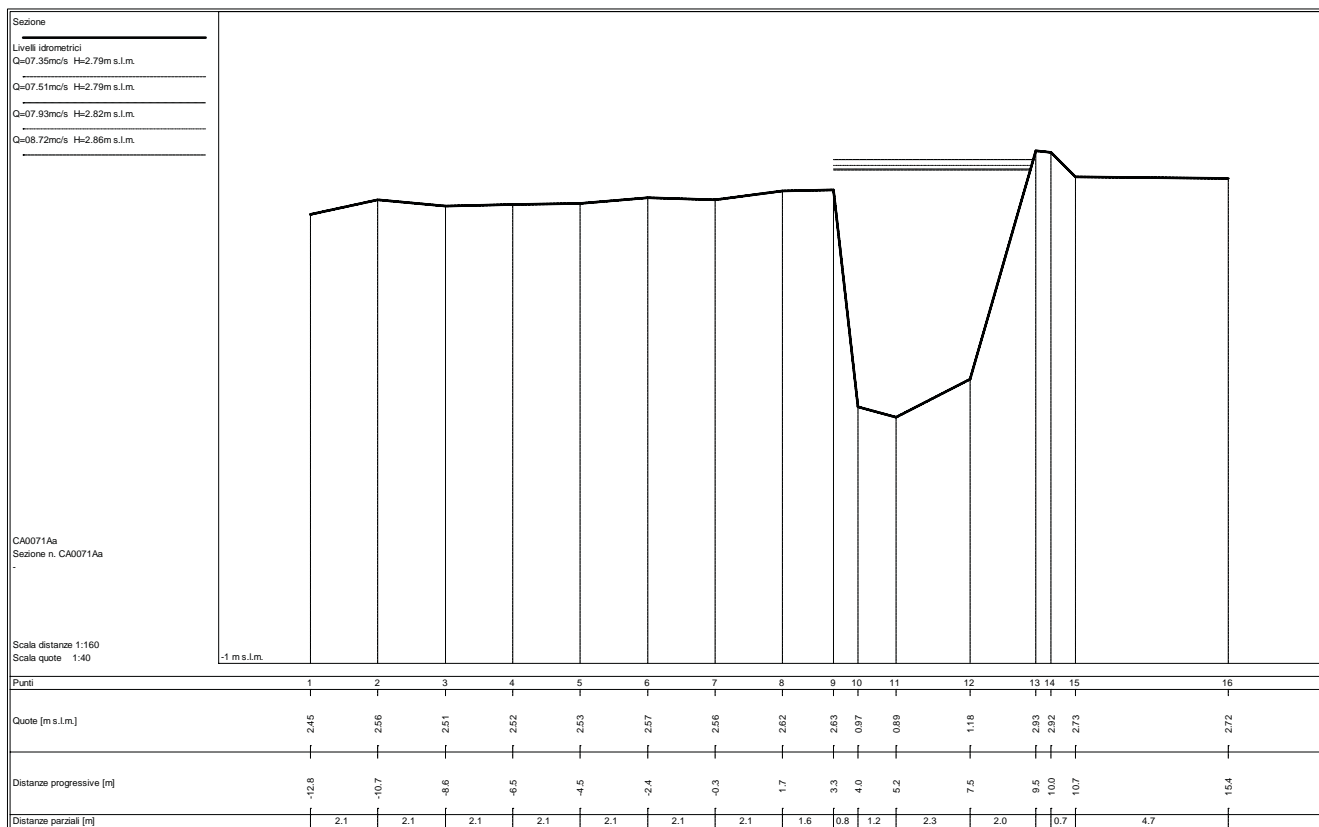
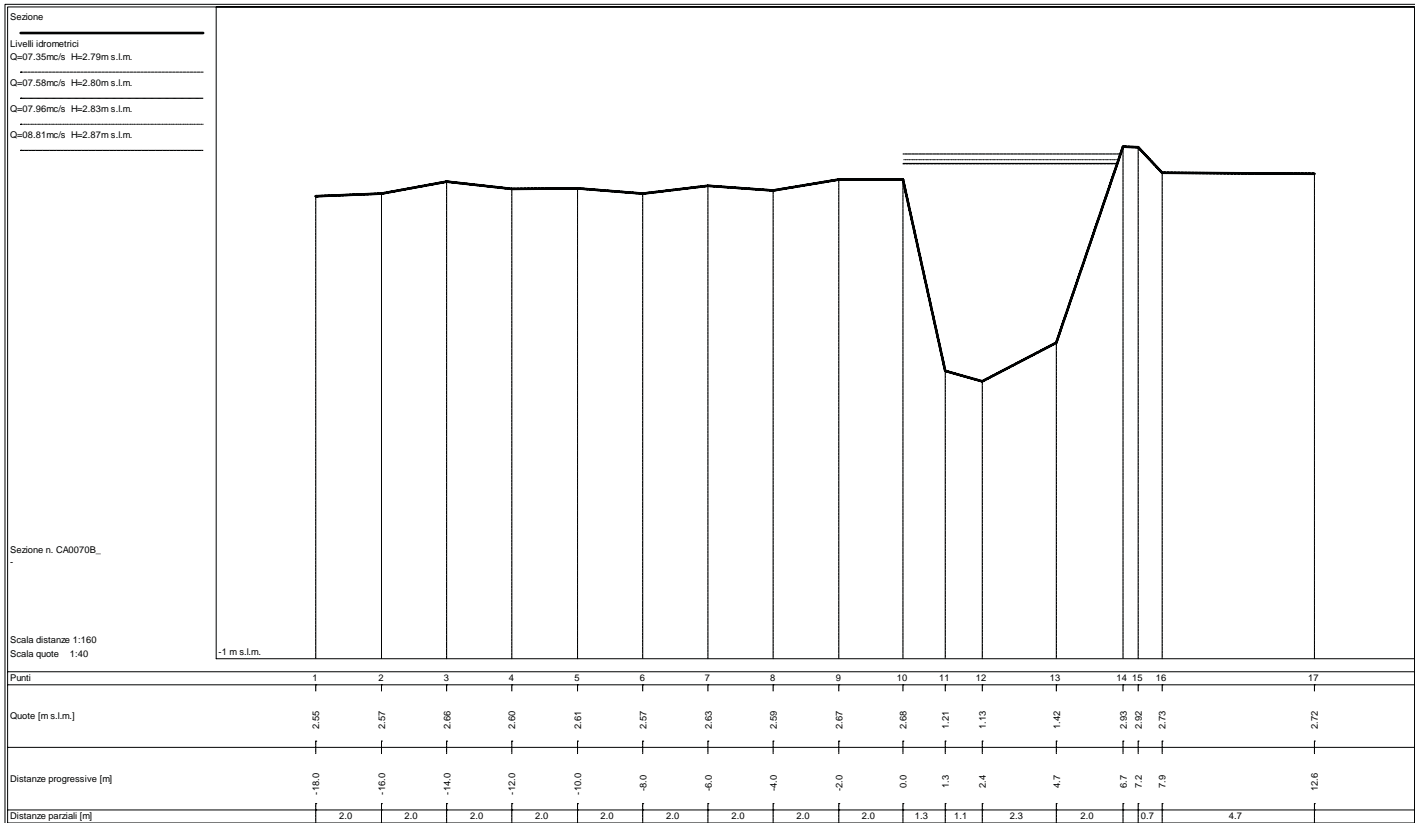

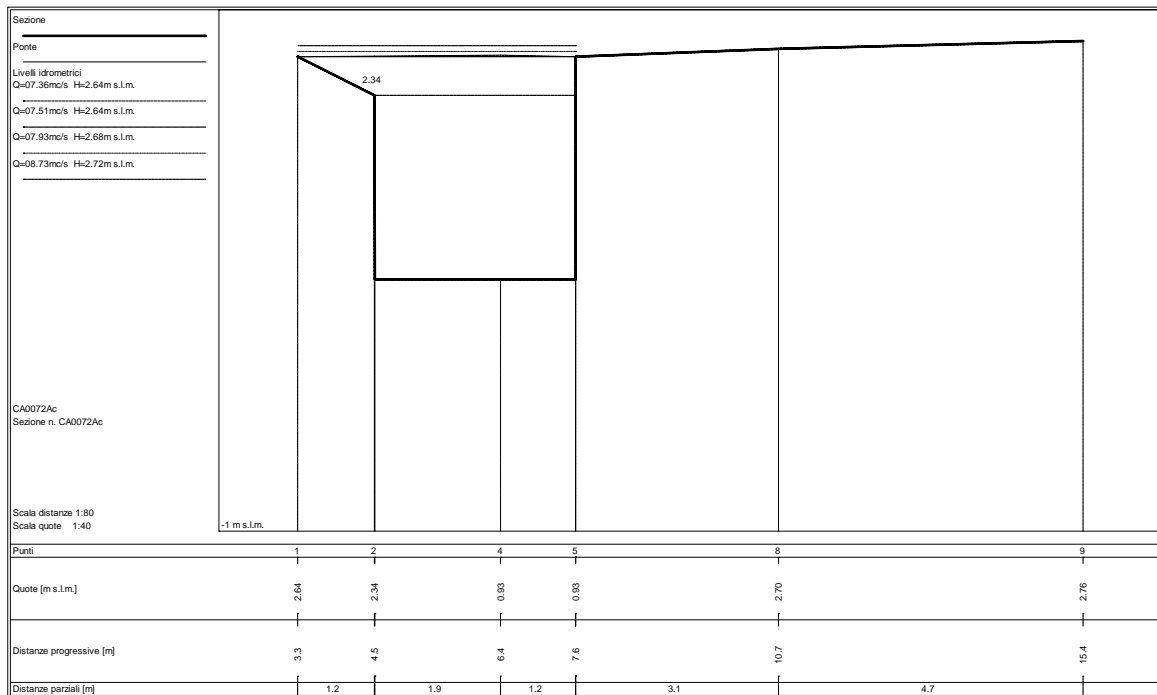
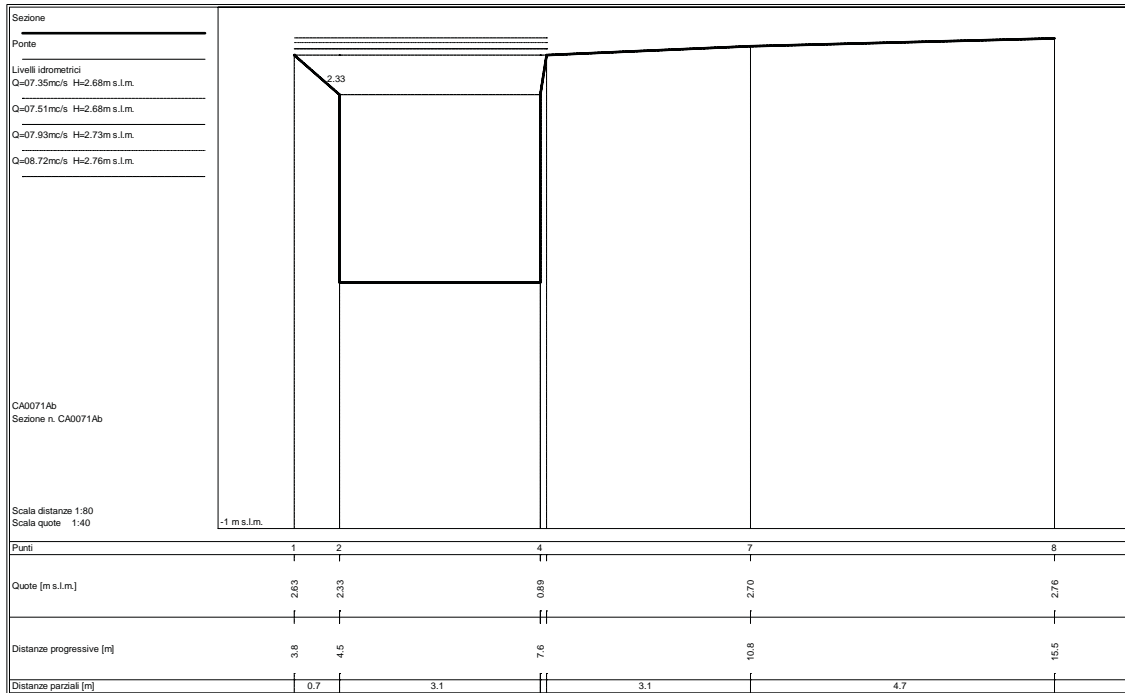

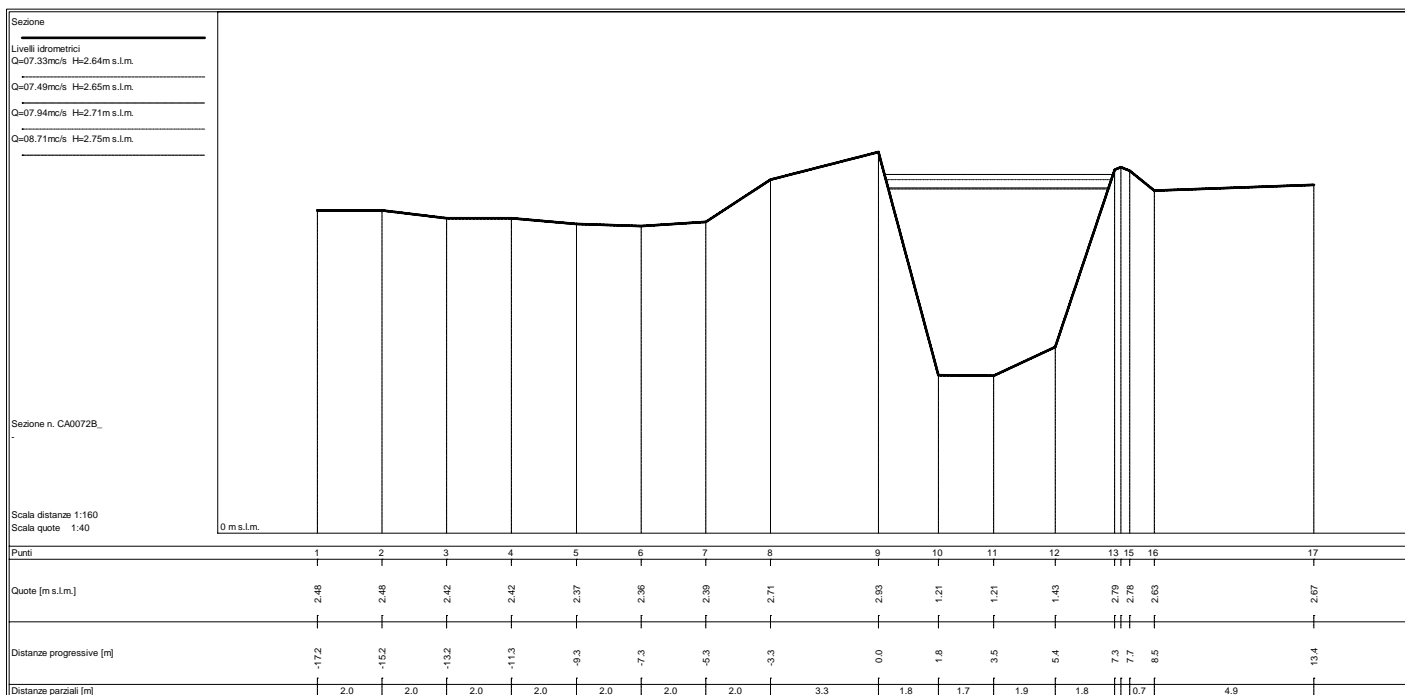
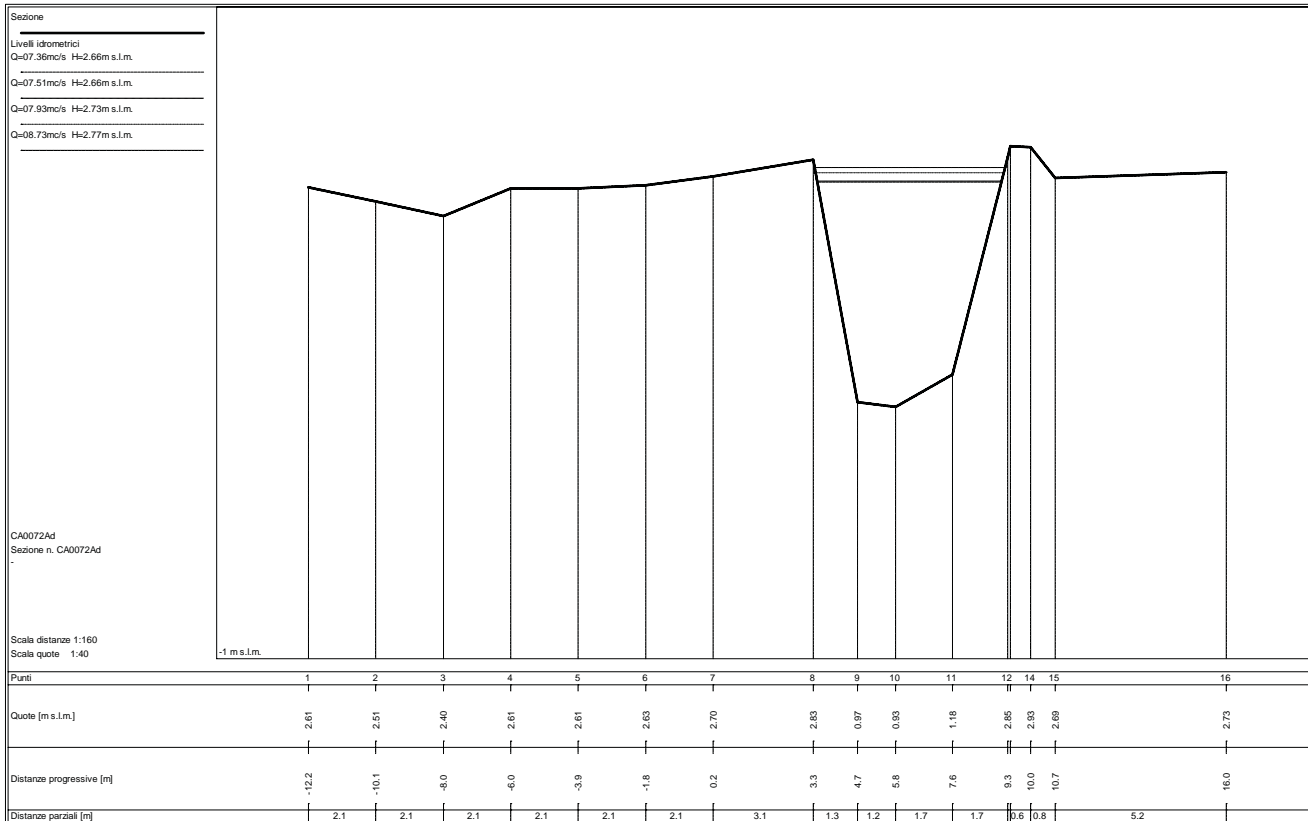

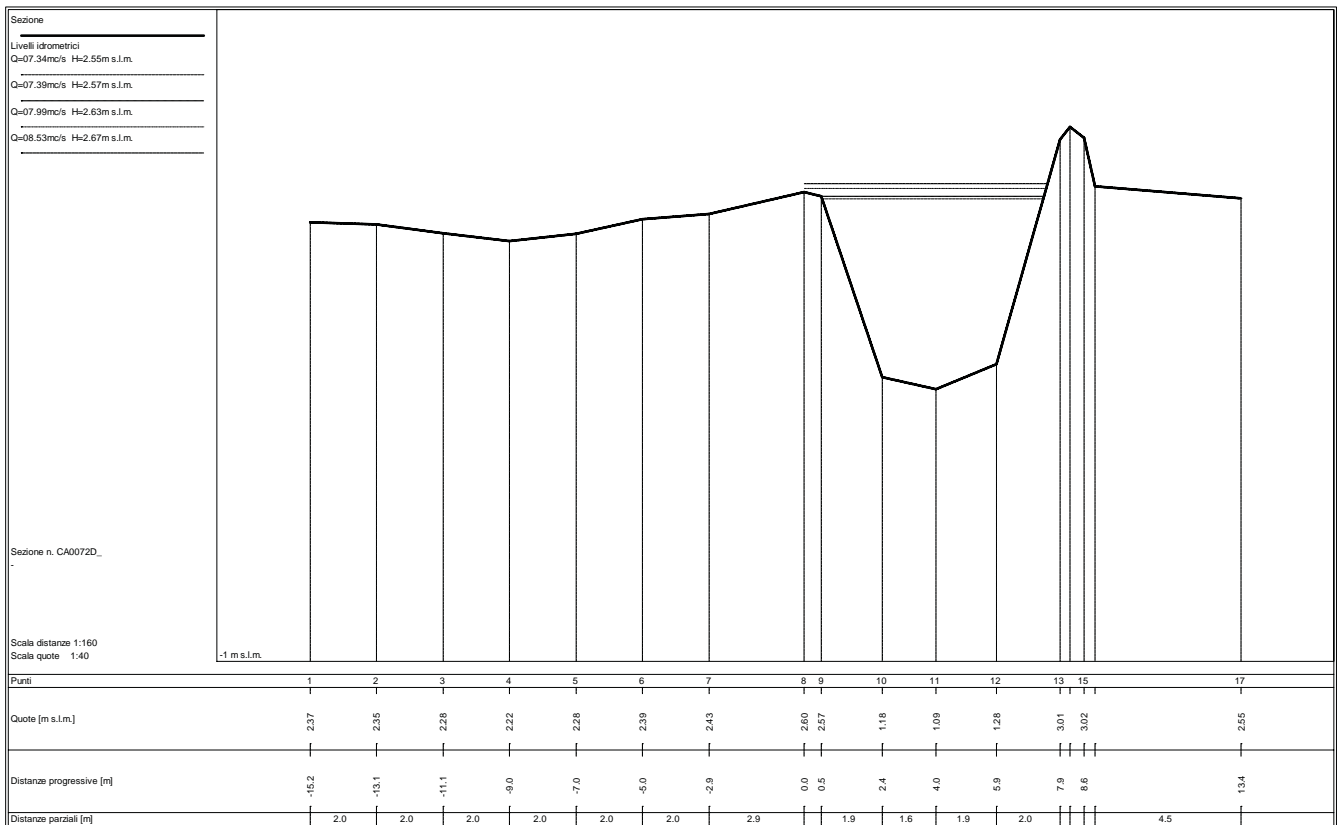
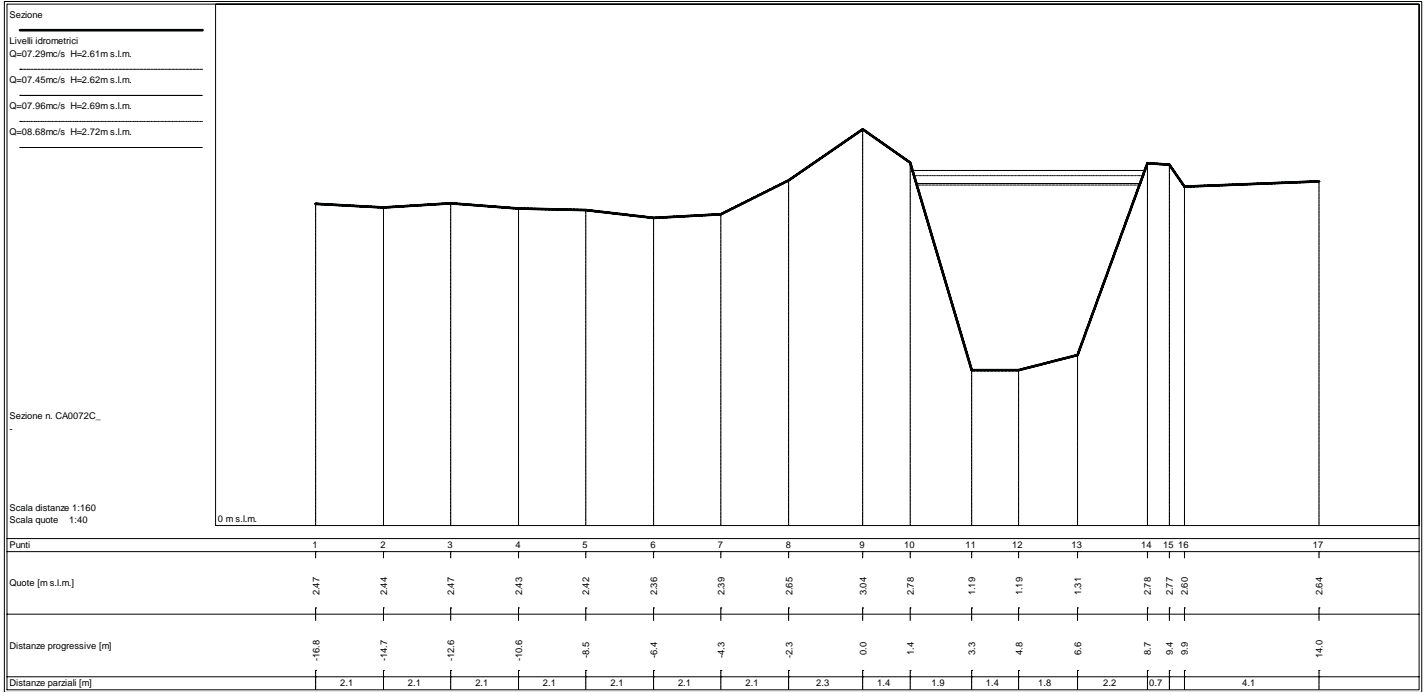

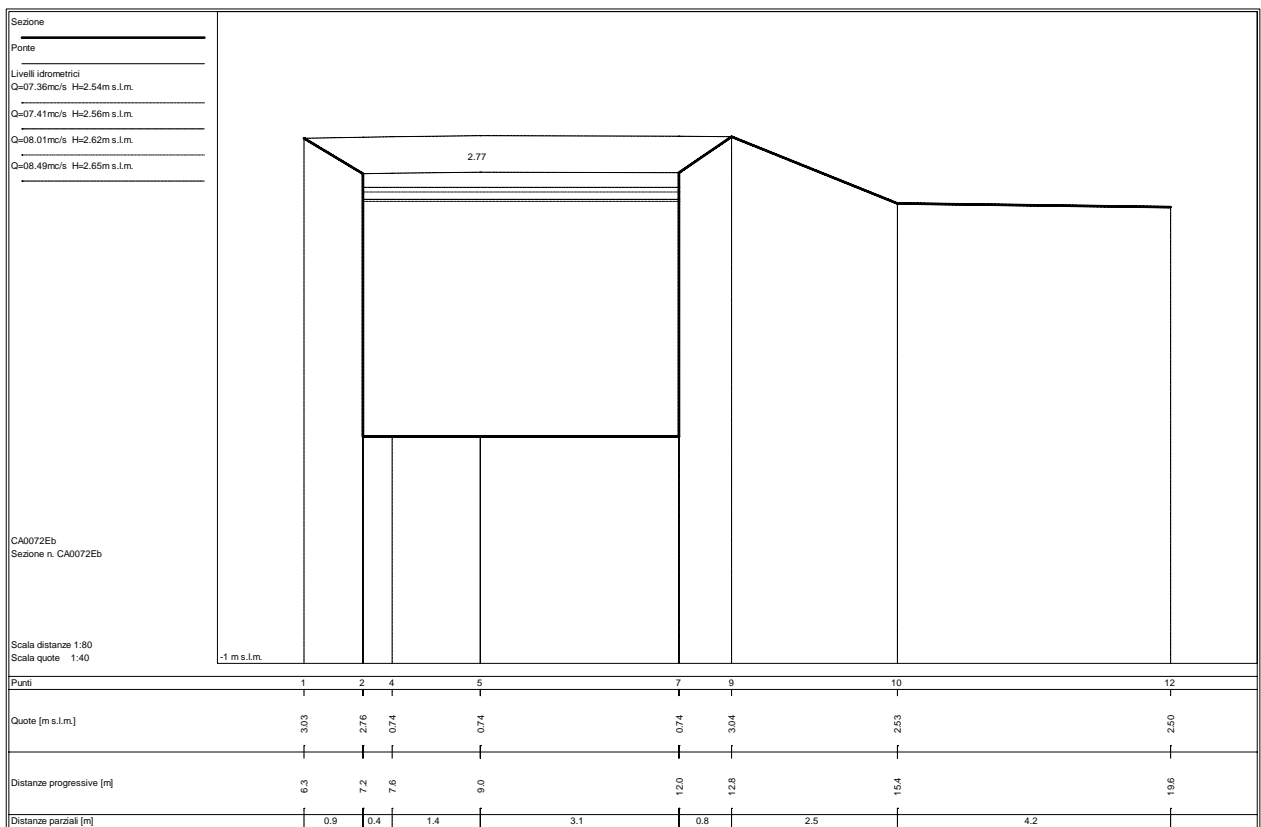
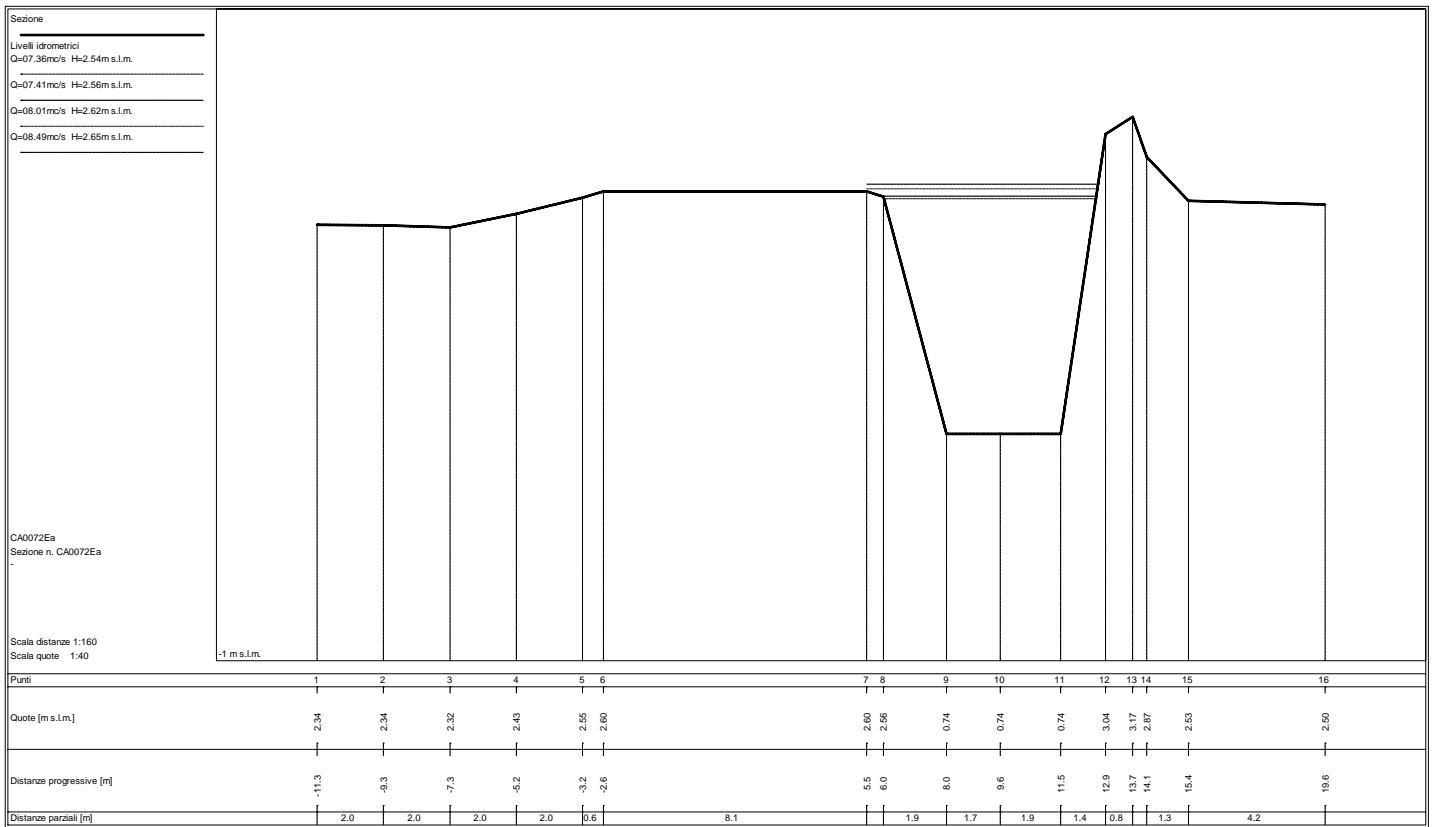

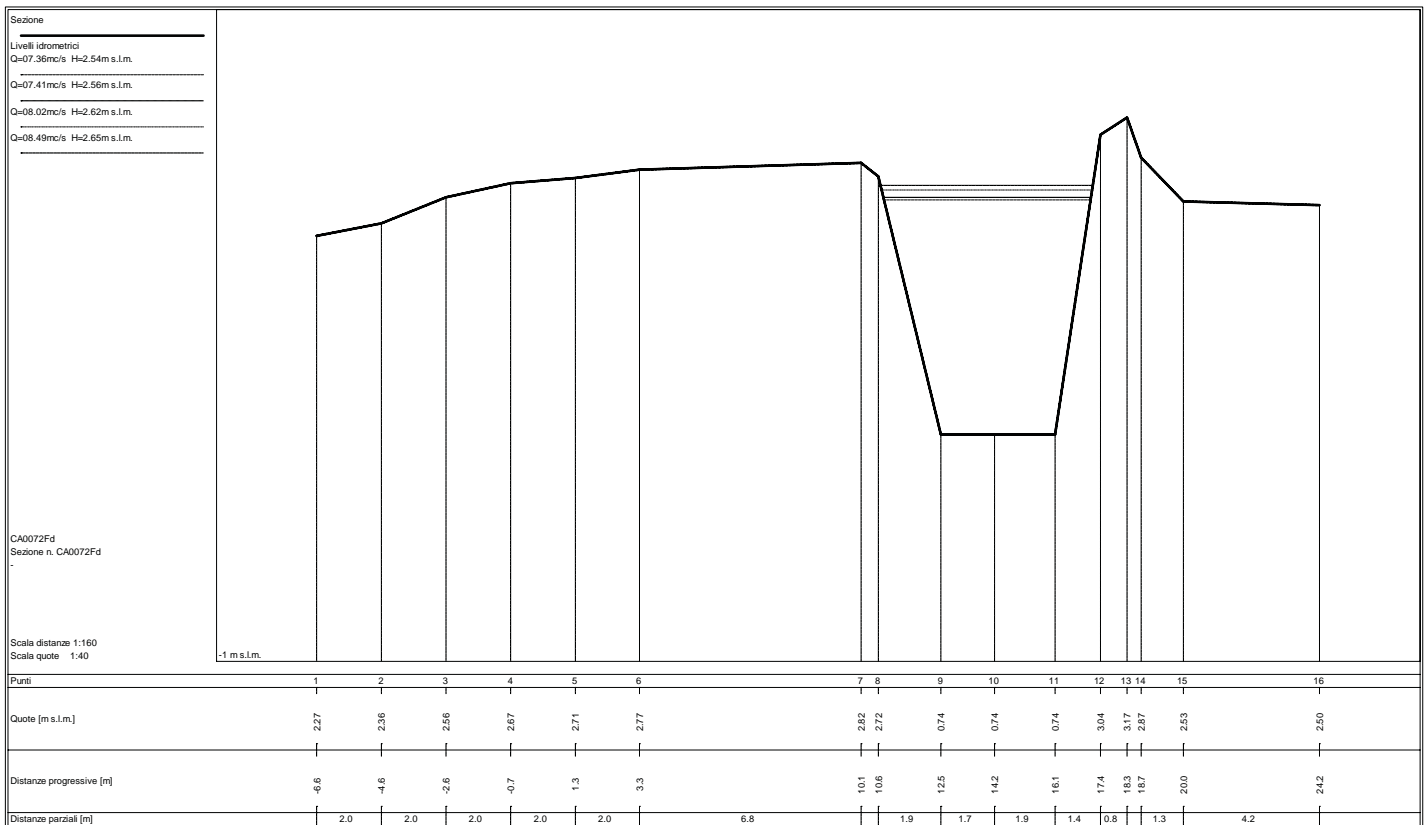
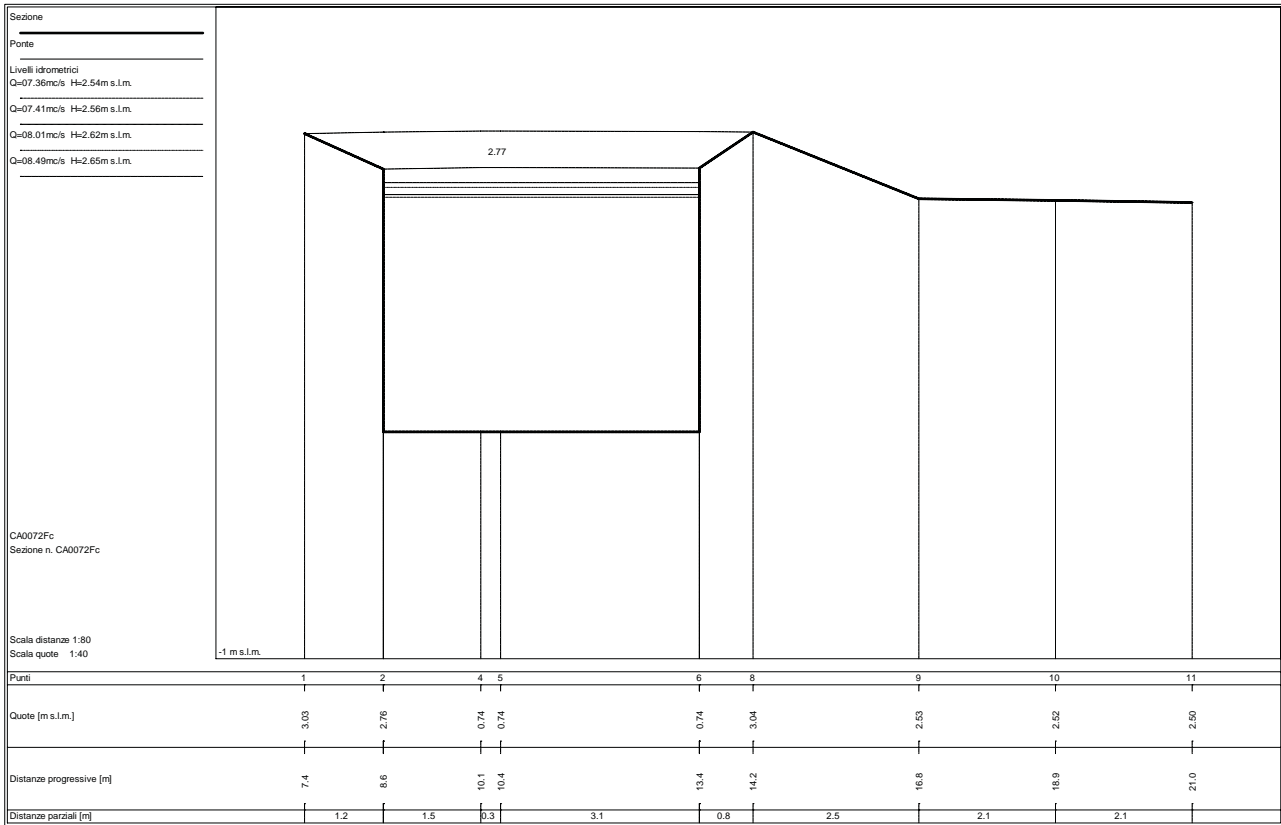

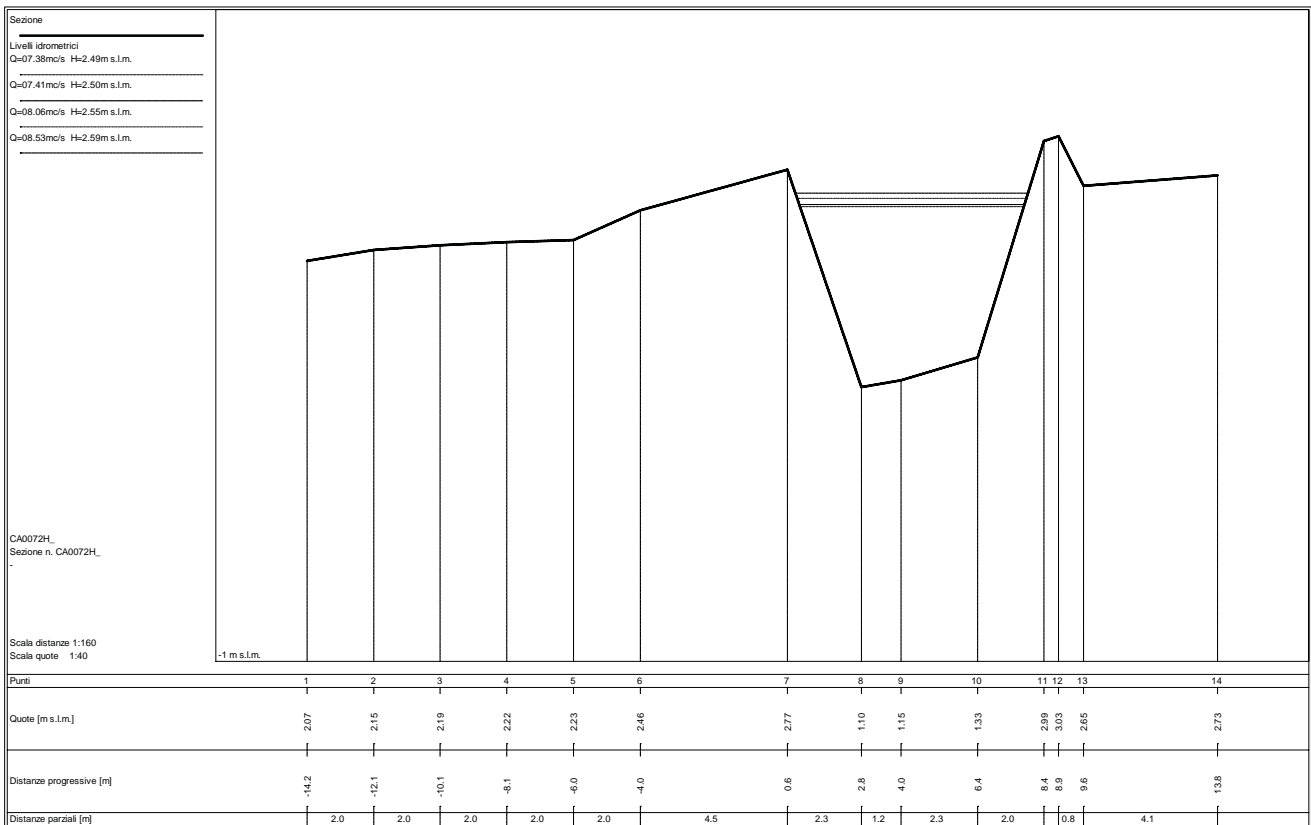
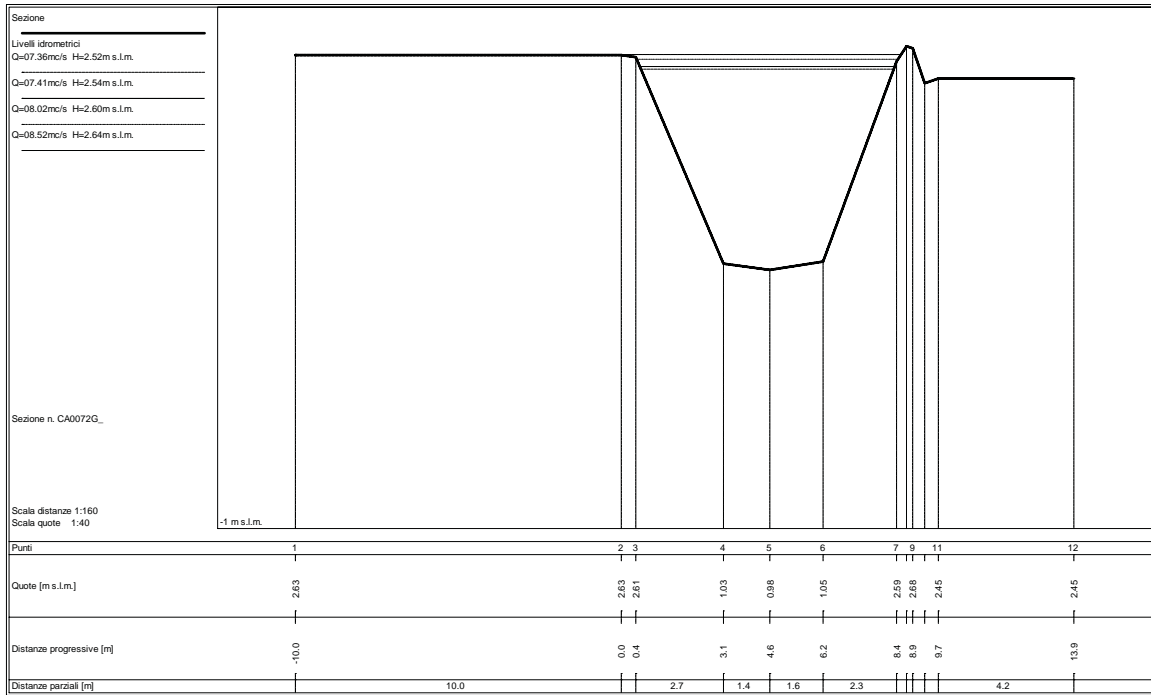

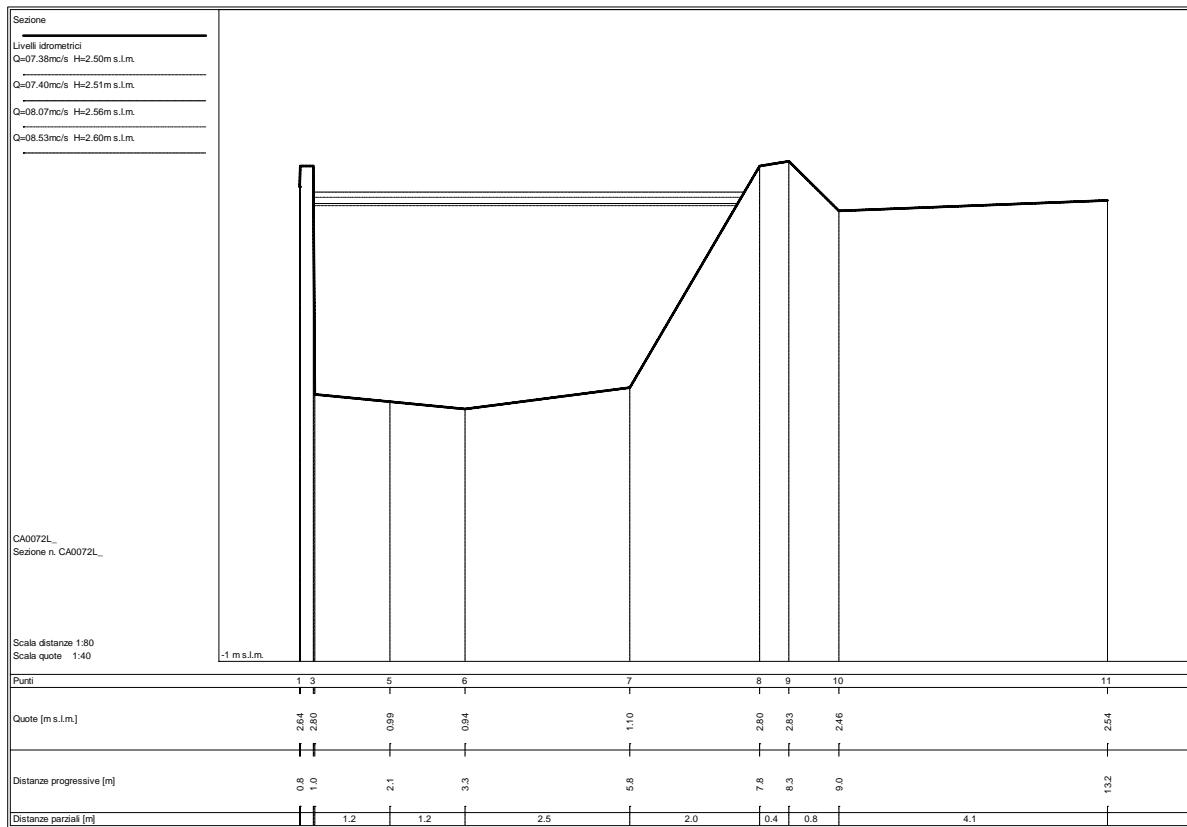
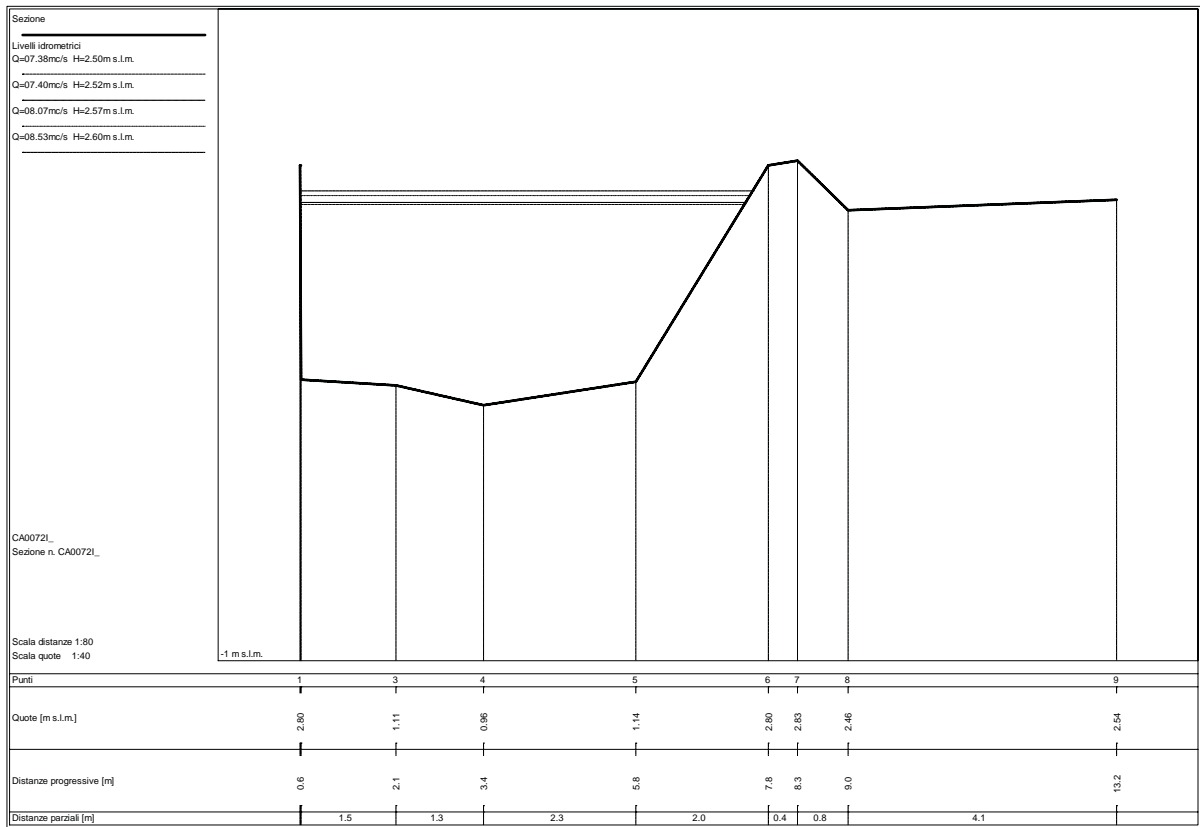

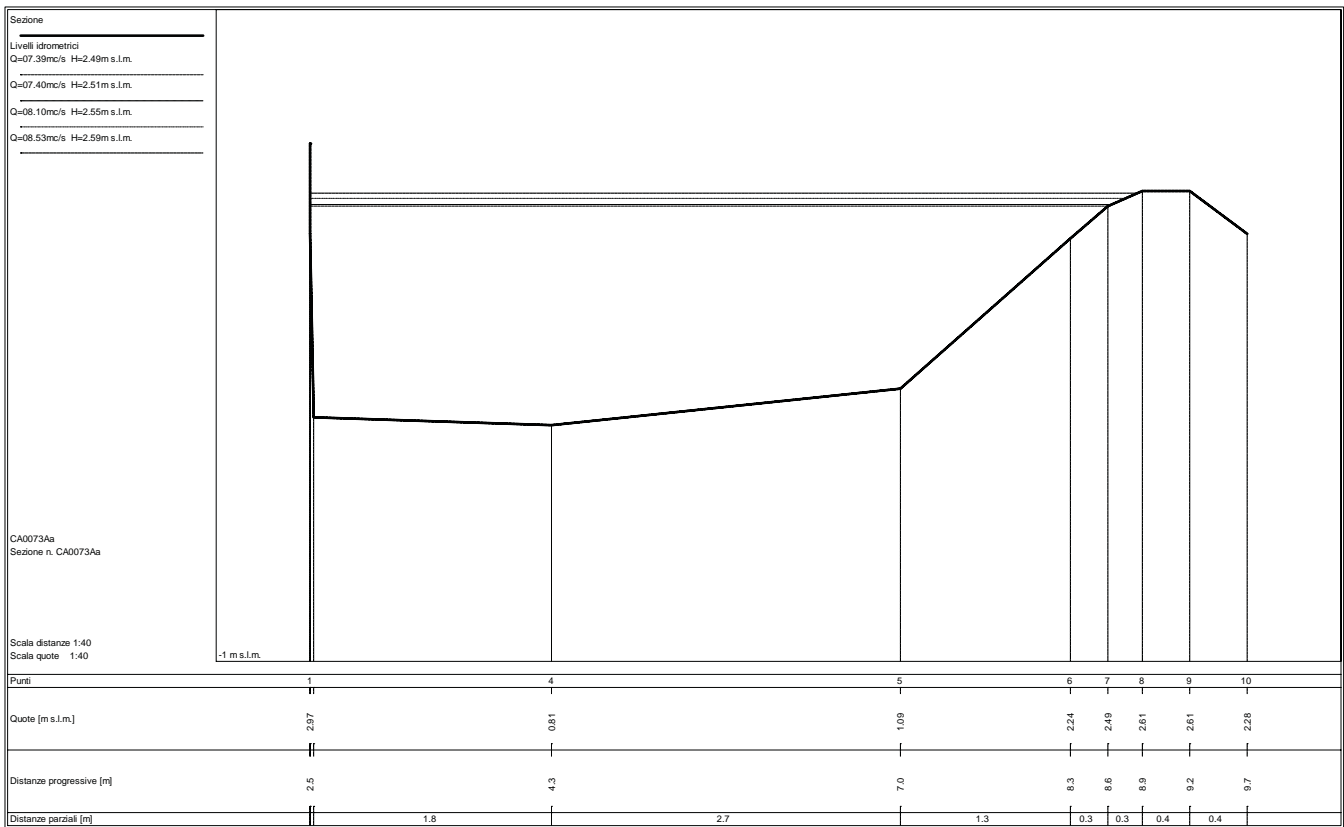
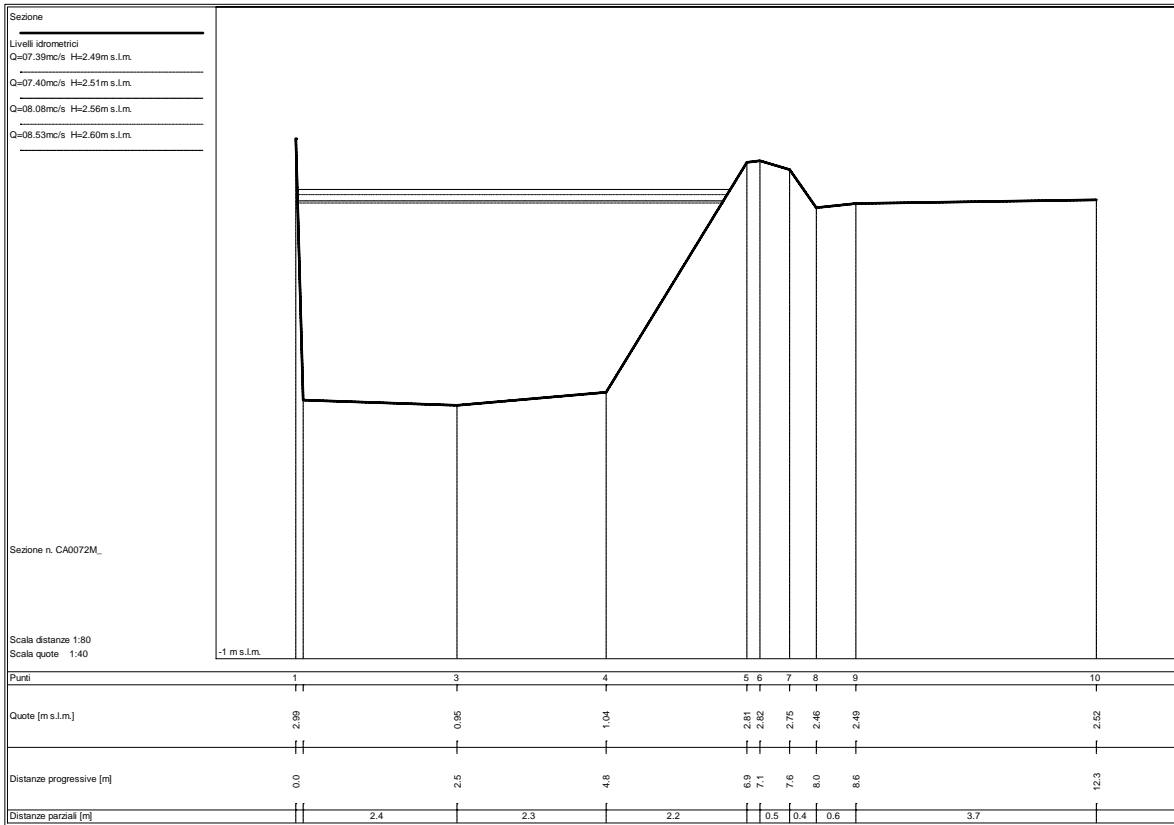

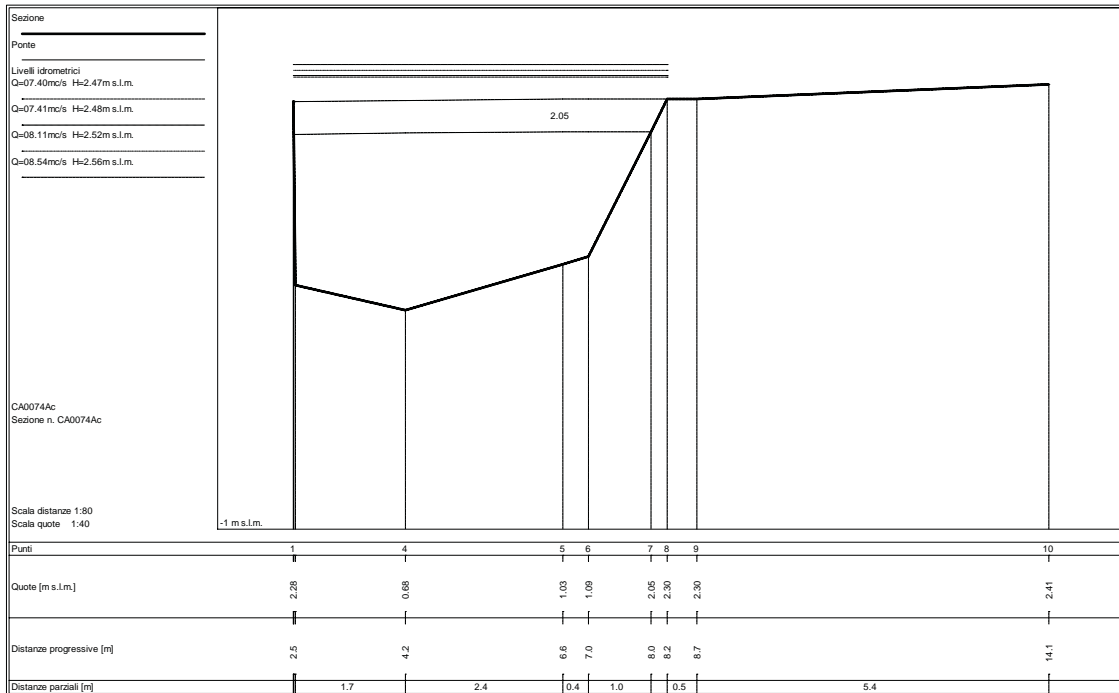
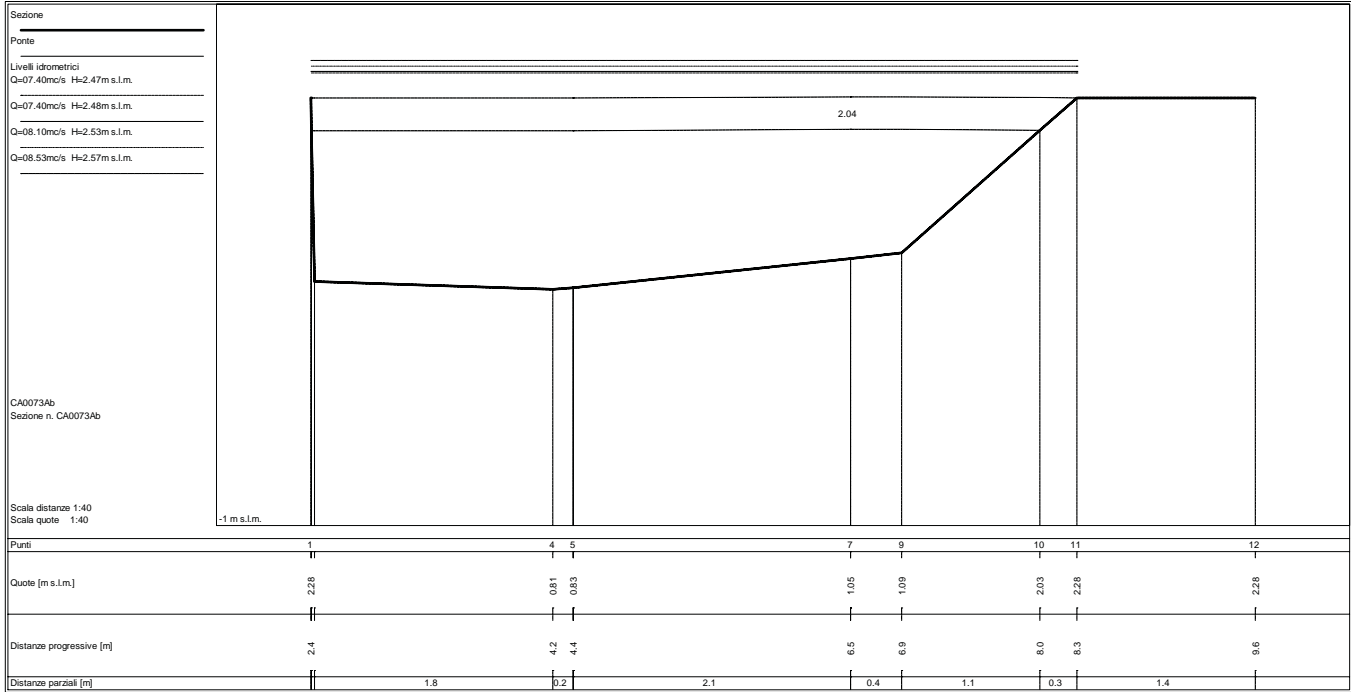

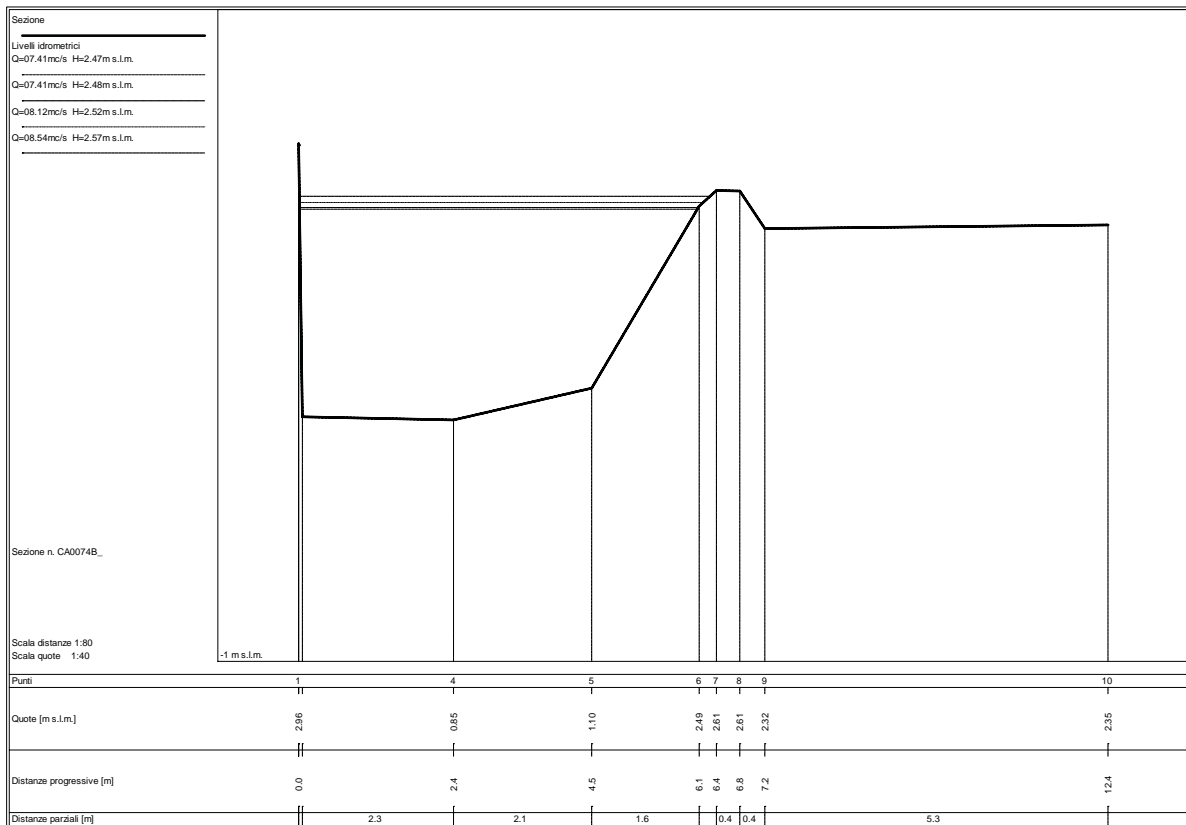
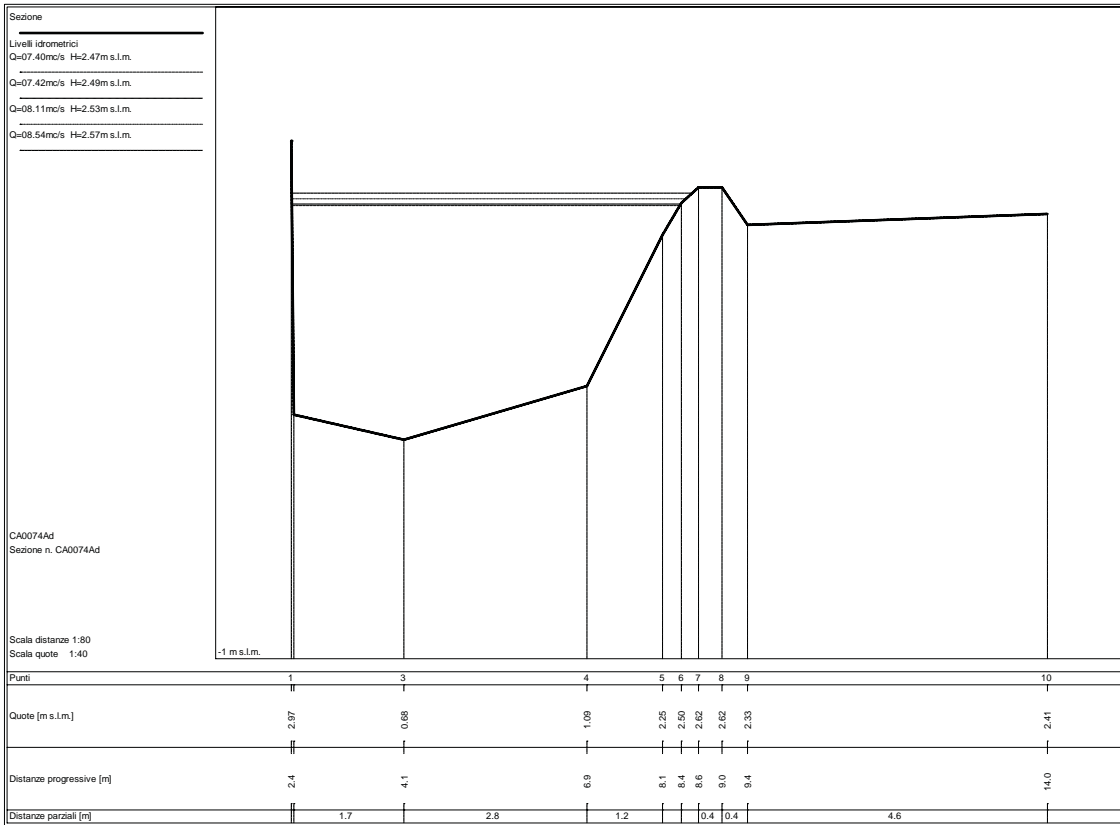

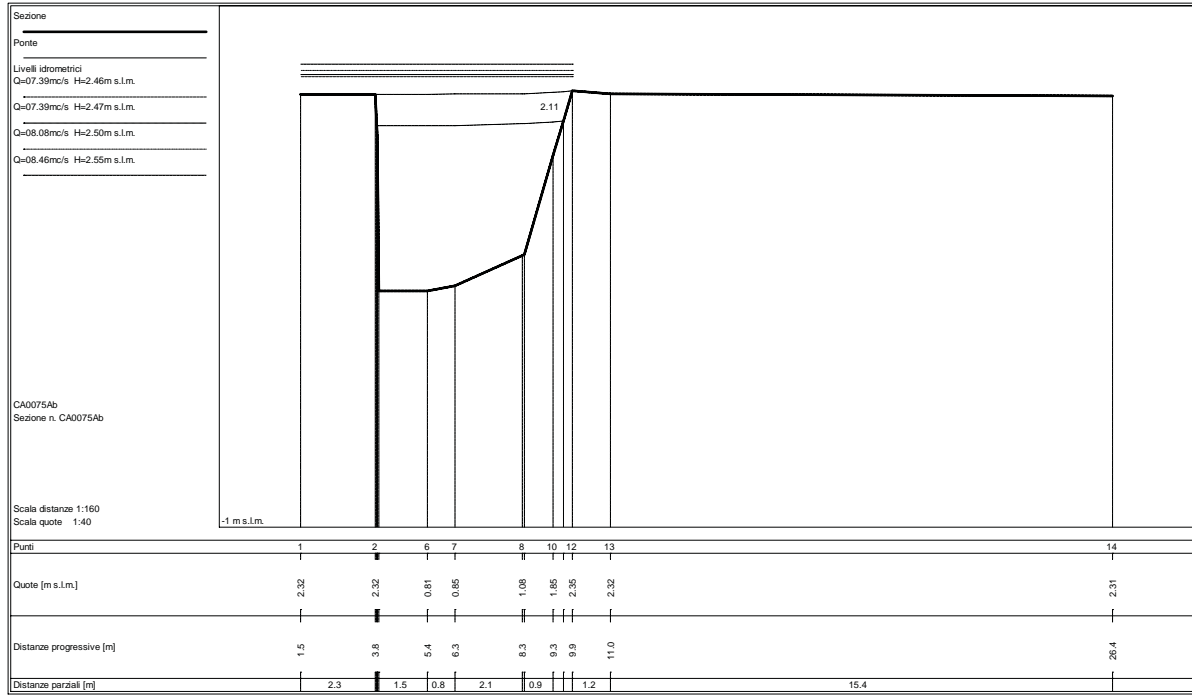
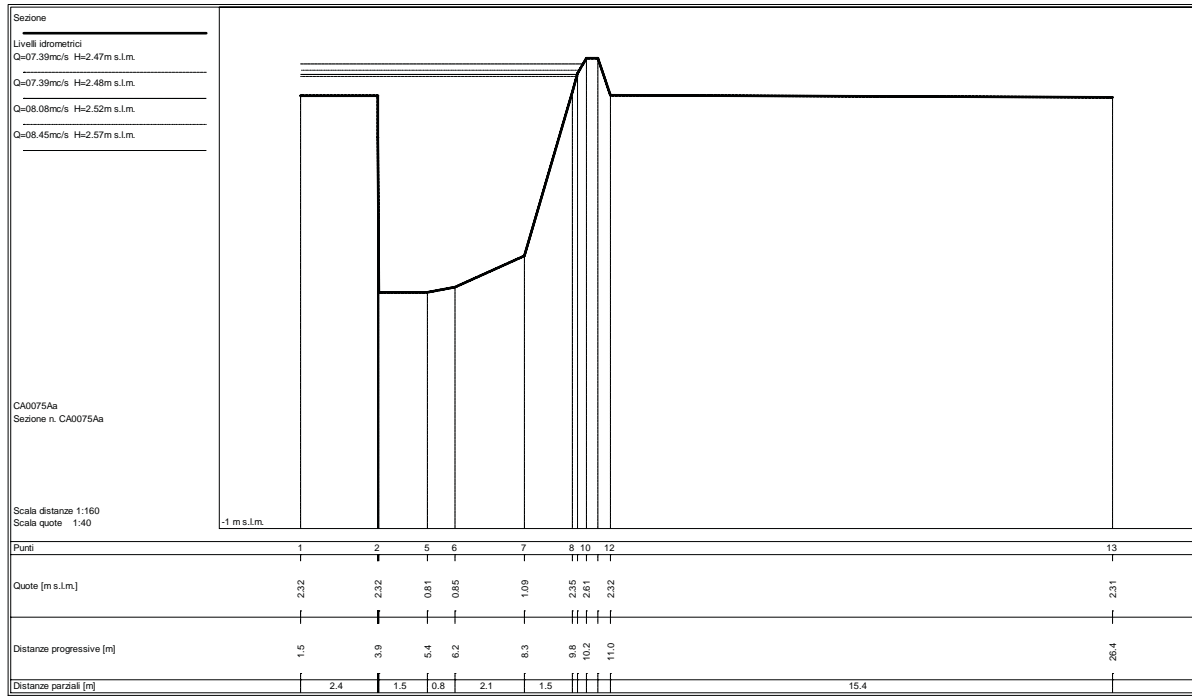

Sezione

Ponte

Livelli idrometrici
 $Q=07.40\text{mc/s}$ $H=2.46\text{m s.l.m.}$

$Q=07.40\text{mc/s}$ $H=2.47\text{m s.l.m.}$

$Q=08.08\text{mc/s}$ $H=2.50\text{m s.l.m.}$

$Q=08.46\text{mc/s}$ $H=2.55\text{m s.l.m.}$

CA0076Ac
 Sezione n. CA0076Ac

Scala distanze 1:80
 Scala quote 1:40

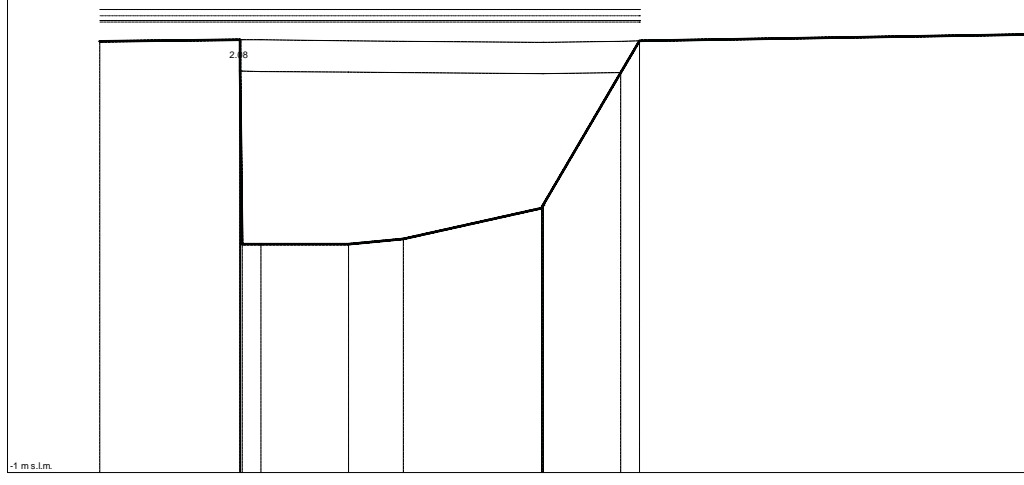

Punti	1	2	5	6	7	8	11	12	13
Quote [m s.l.m.]	2.31	2.32	0.75	0.75	0.79	1.03	2.07	2.31	2.36
Distanze progressive [m]	2.9	5.0	5.4	6.7	7.5	8.7	10.9	11.2	17.1
Distanze parziali [m]		2.1	0.3	1.3	0.8	2.1	1.2		5.9

Sezione

Livelli idrometrici
 $Q=07.40\text{mc/s}$ $H=2.46\text{m s.l.m.}$

$Q=07.40\text{mc/s}$ $H=2.48\text{m s.l.m.}$

$Q=08.08\text{mc/s}$ $H=2.51\text{m s.l.m.}$

$Q=08.45\text{mc/s}$ $H=2.56\text{m s.l.m.}$

CA0076Ad
 Sezione n. CA0076Ad

Scala distanze 1:80
 Scala quote 1:40

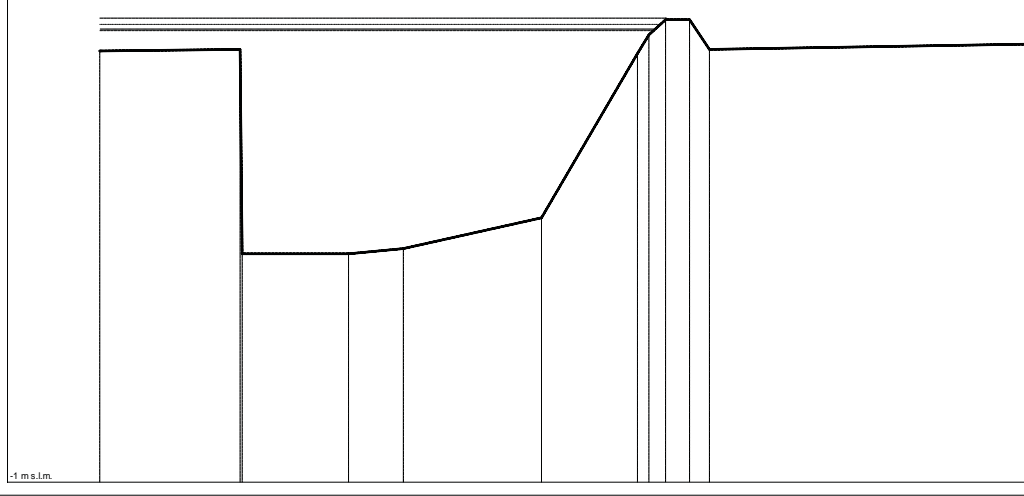

Punti	1	2	4	5	6	7	8	9	10	11	12
Quote [m s.l.m.]	2.31	2.32	0.75	0.79	1.03	2.29	2.43	2.55	2.55	2.32	2.36
Distanze progressive [m]	2.9	5.1	6.8	7.6	9.7	11.2	11.4	11.6	12.0	12.3	17.1
Distanze parziali [m]		2.1	1.6	0.8	2.1	1.5	0.4	0.3		4.8	

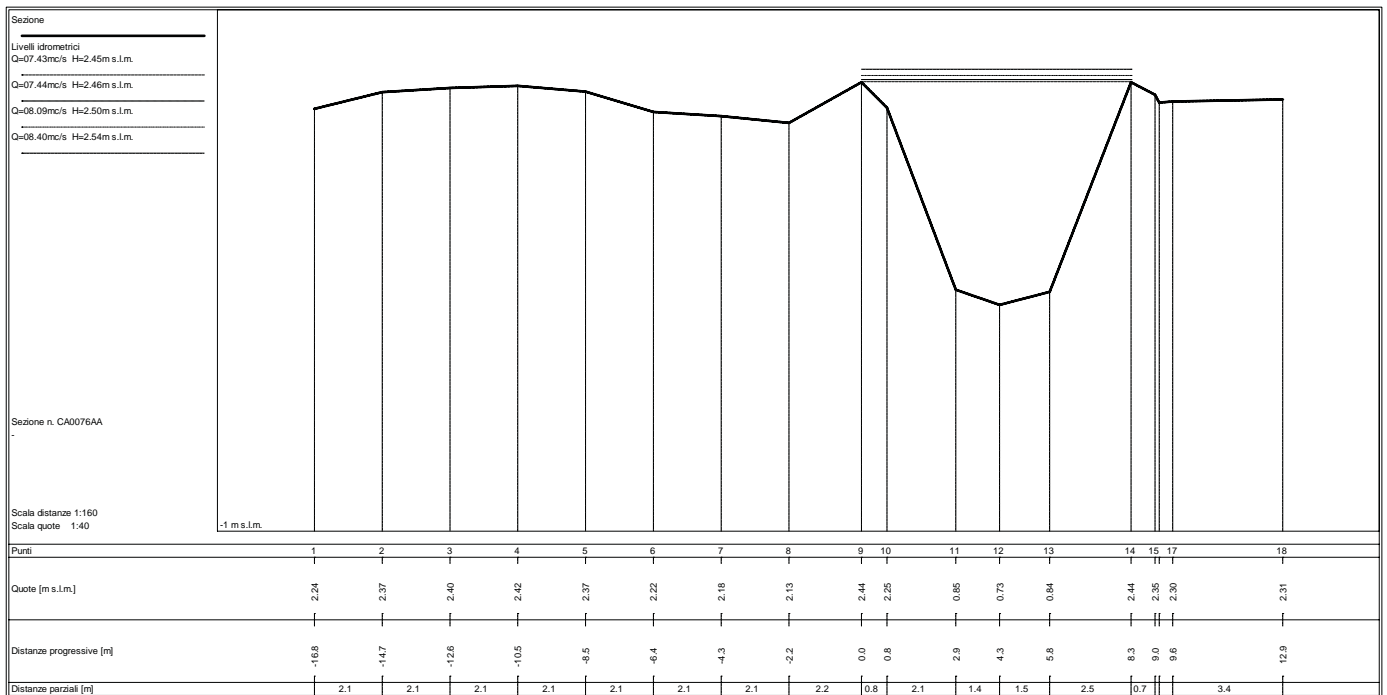
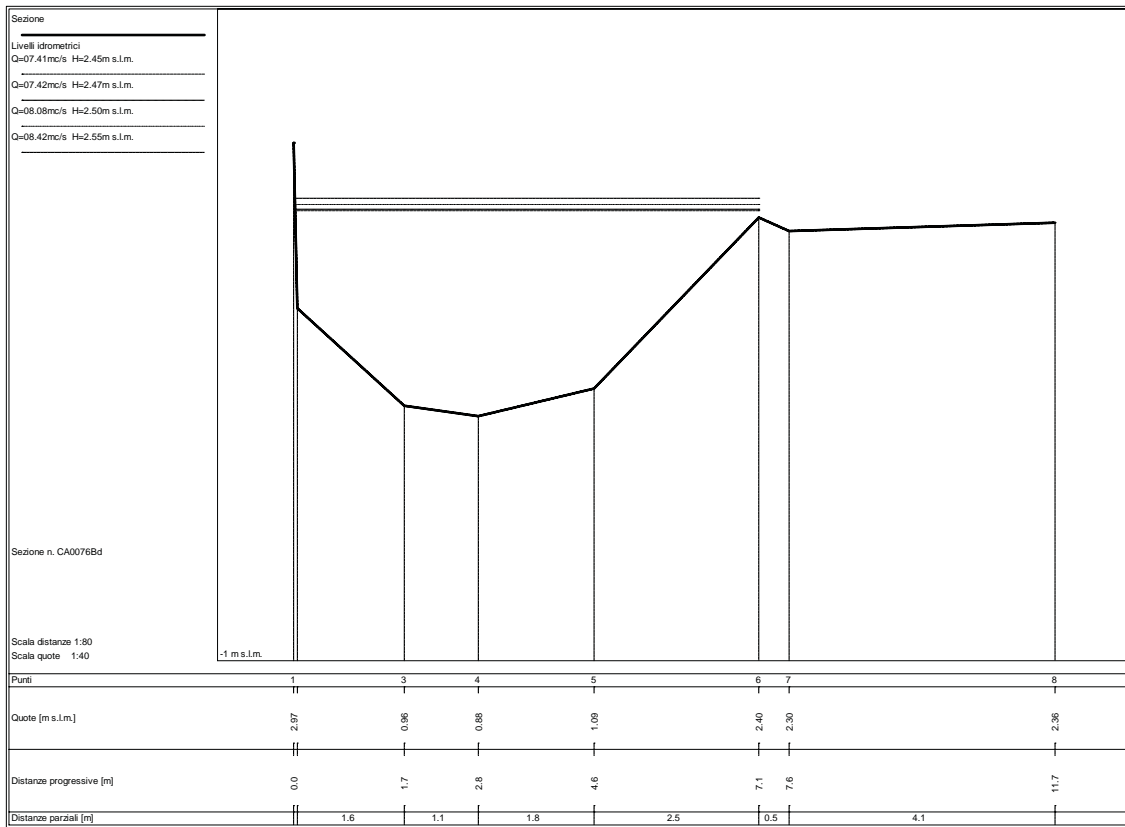

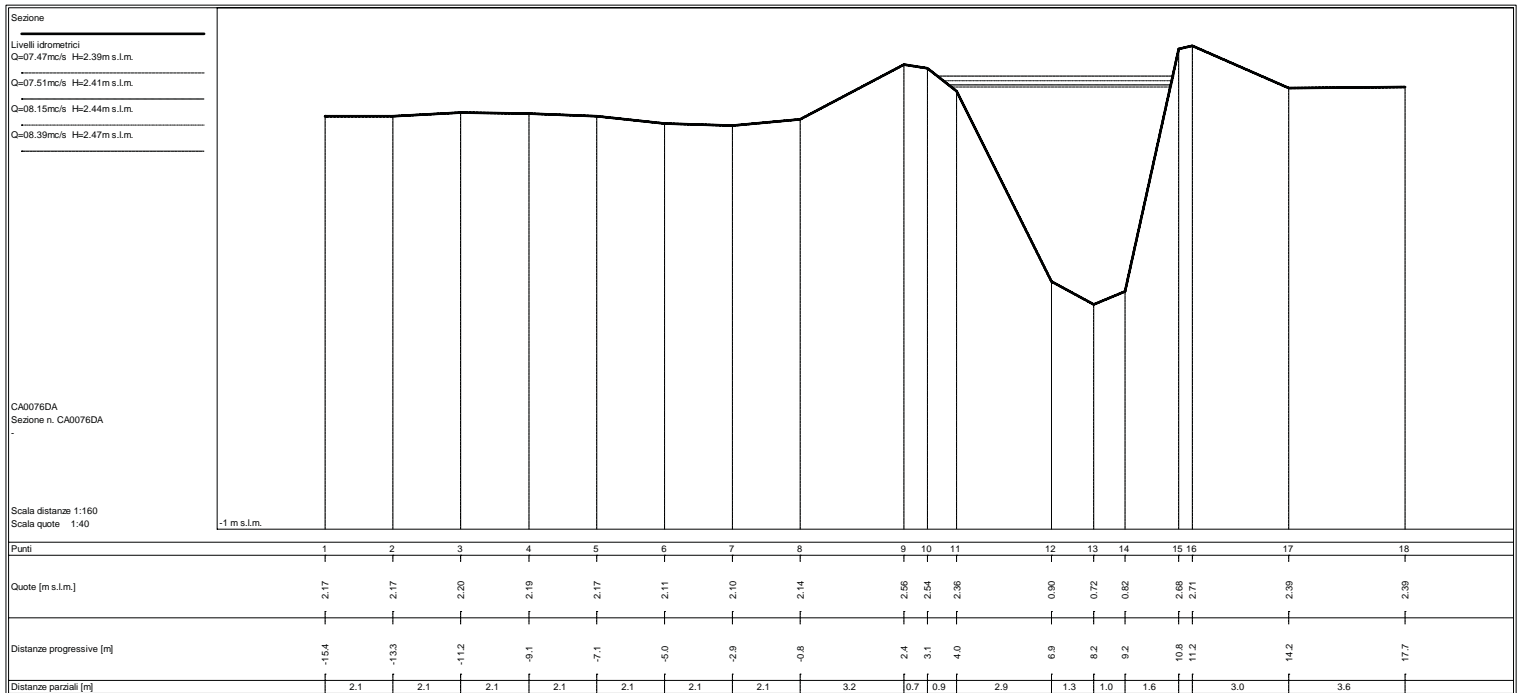
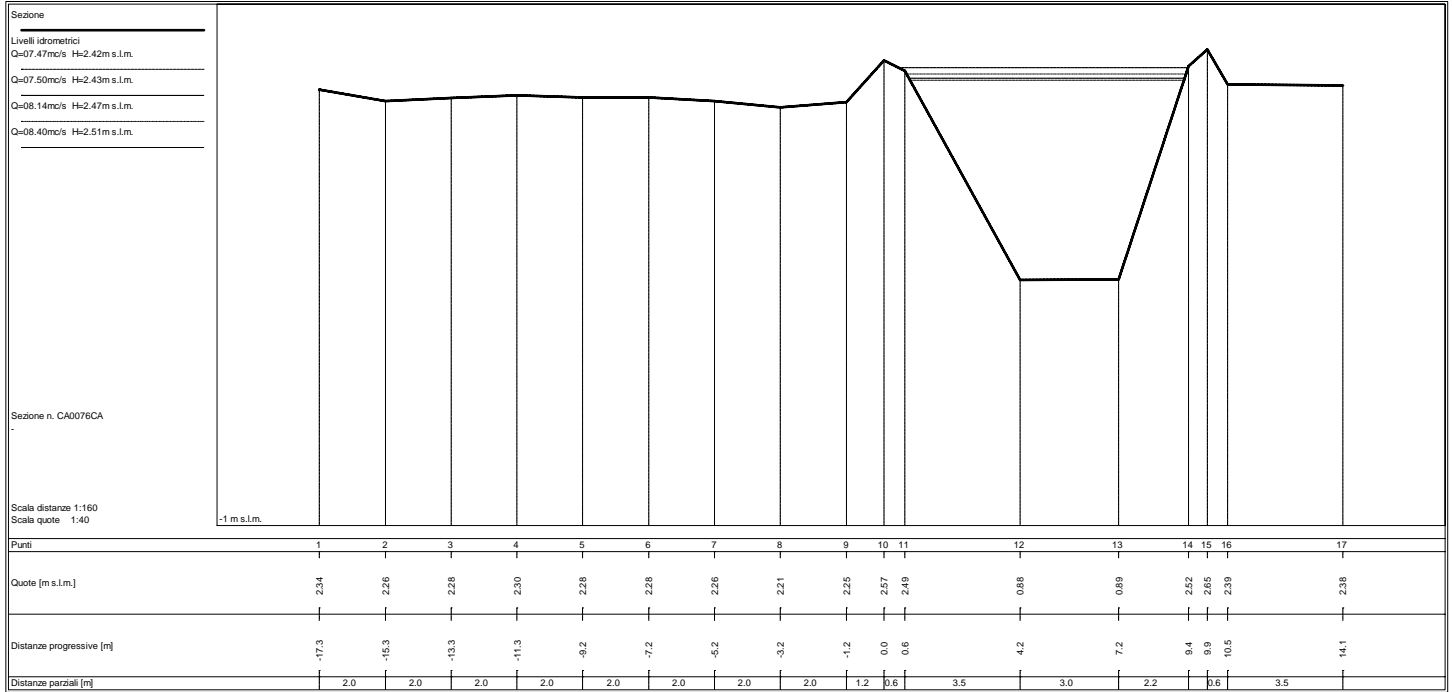

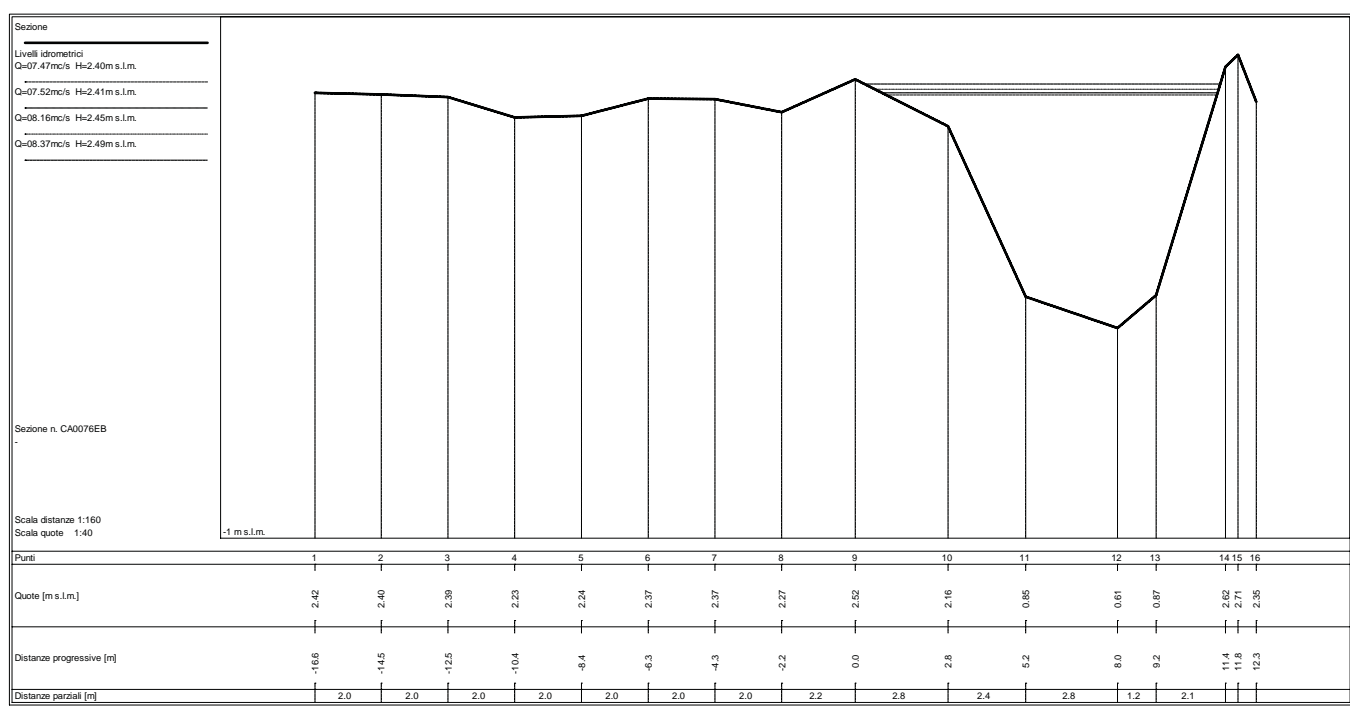
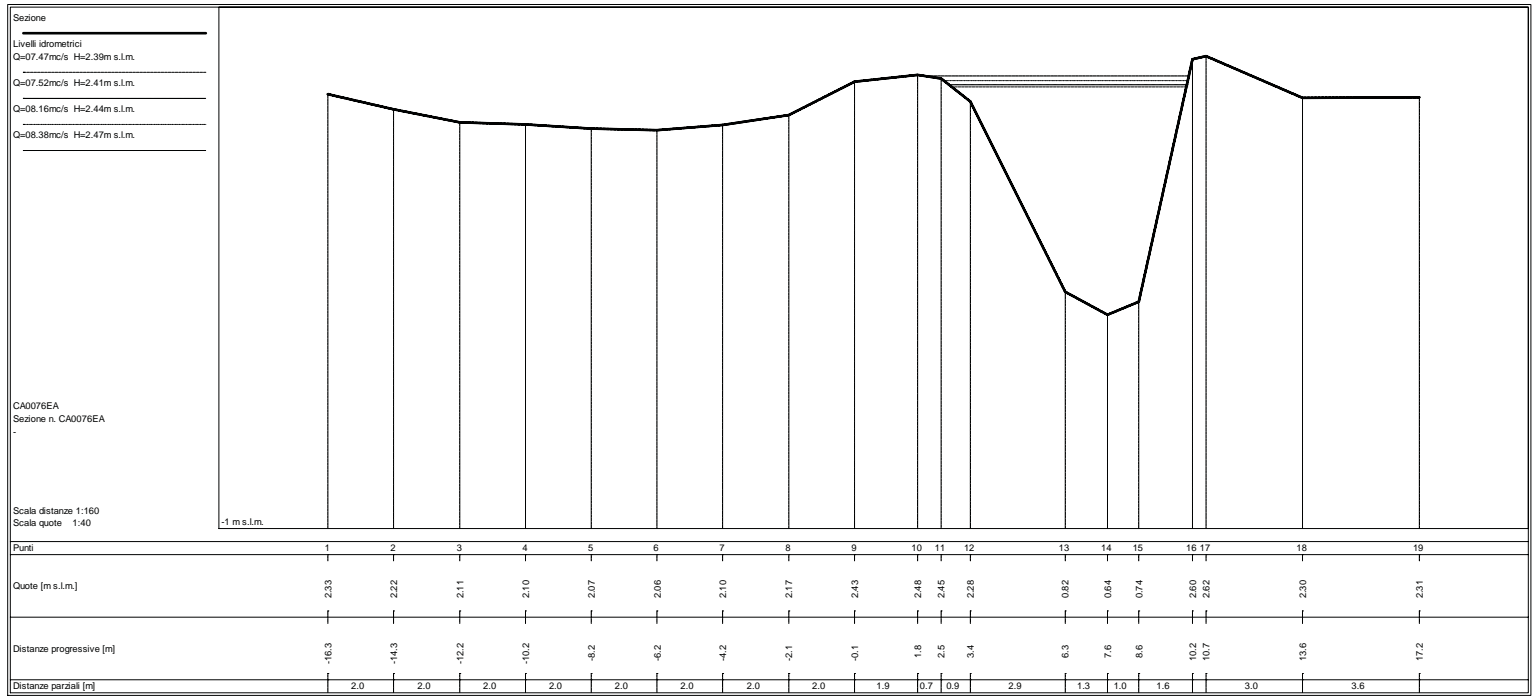

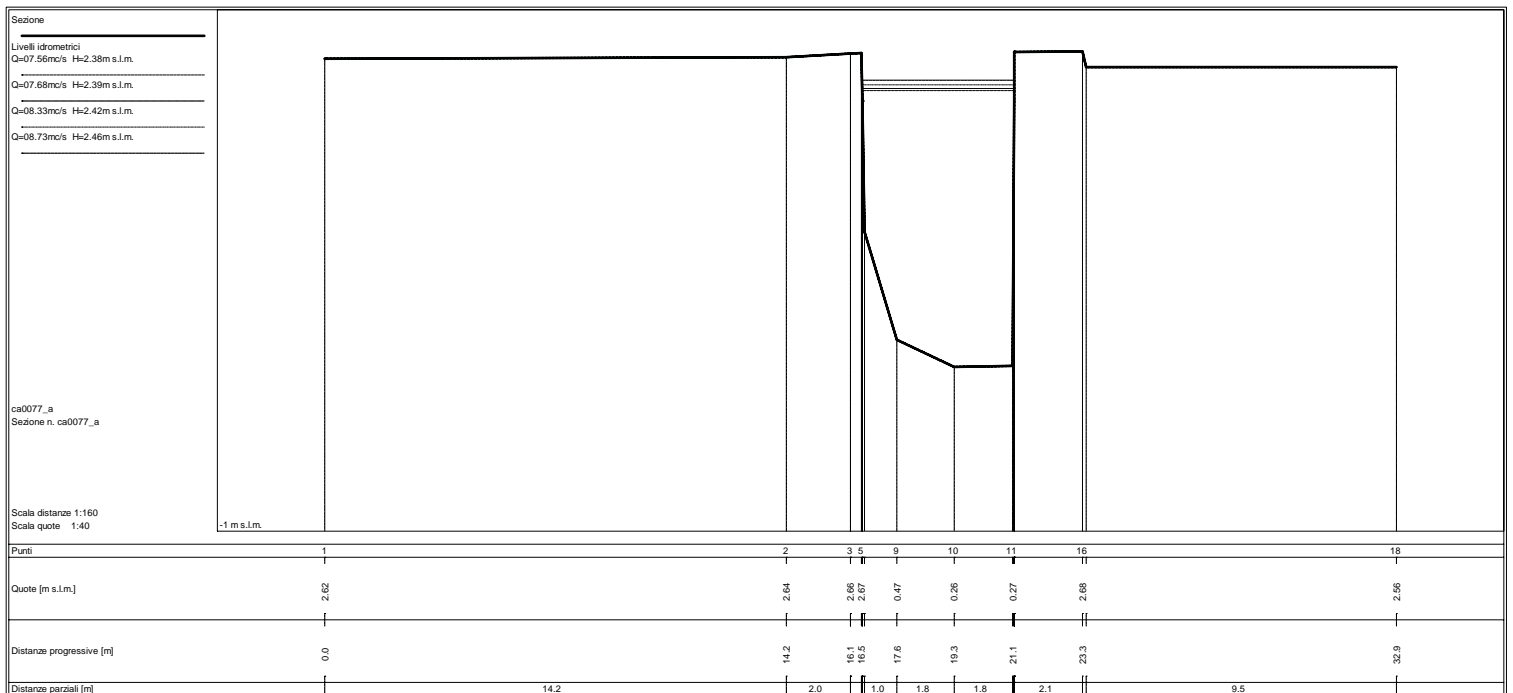
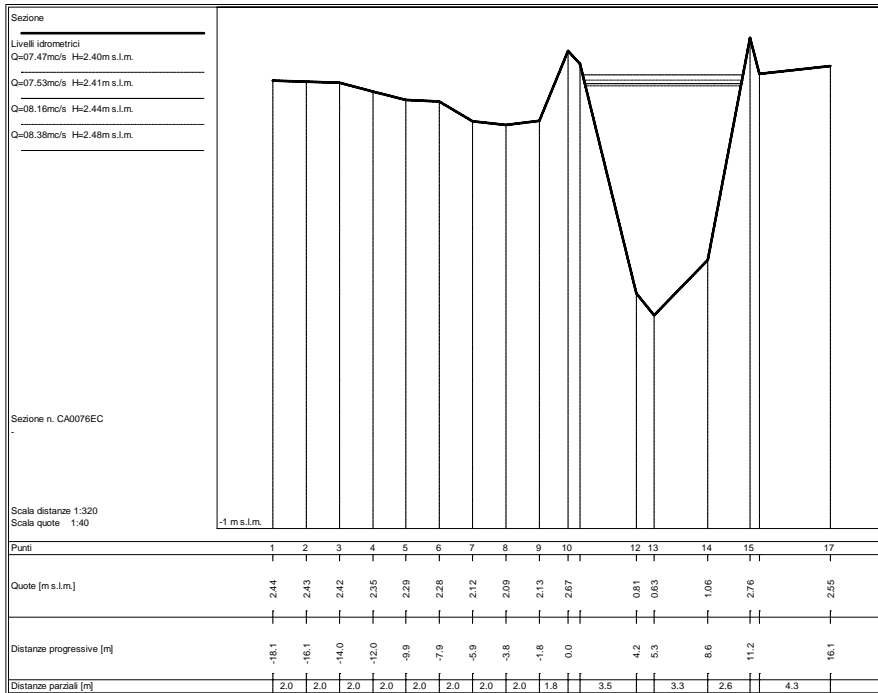

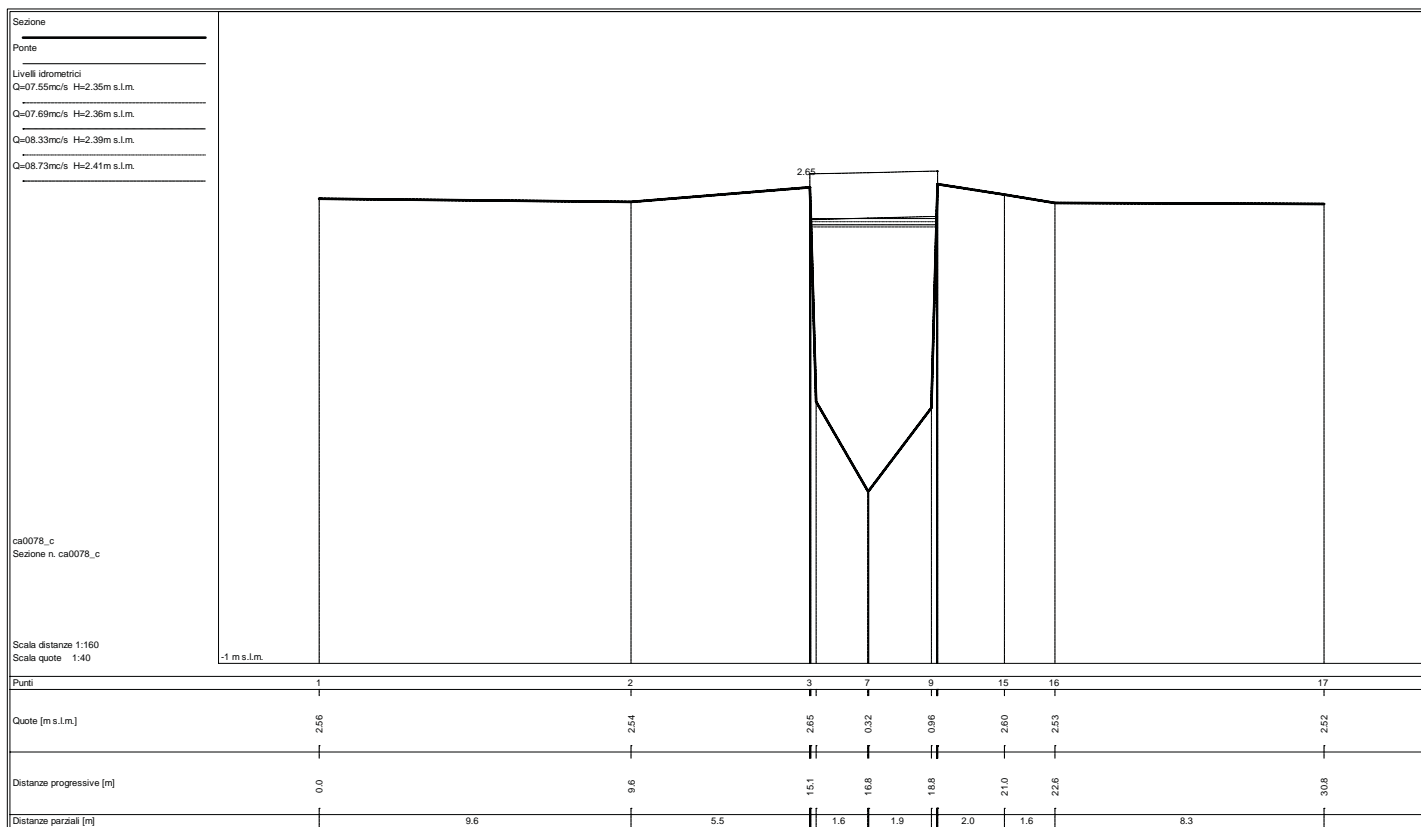
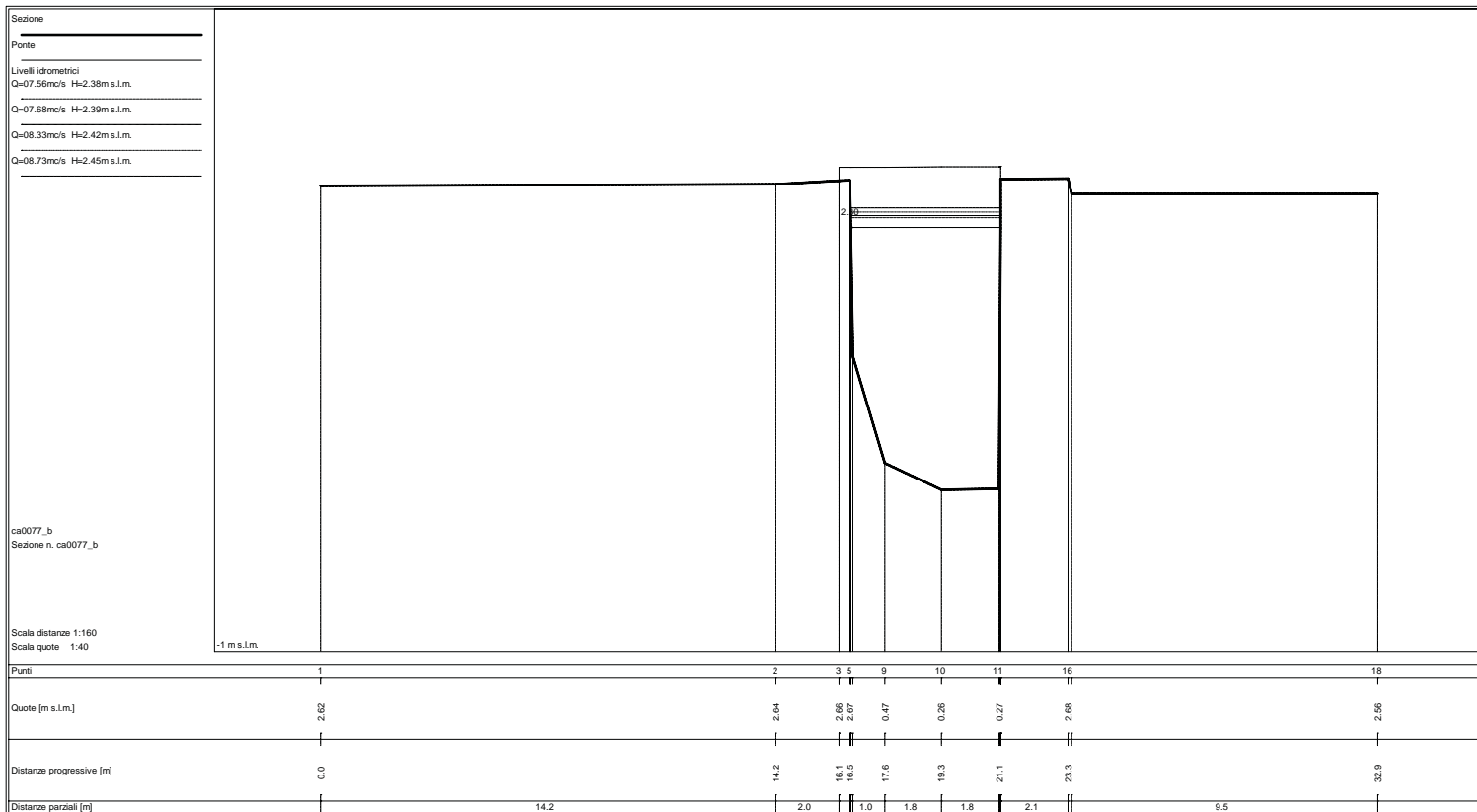

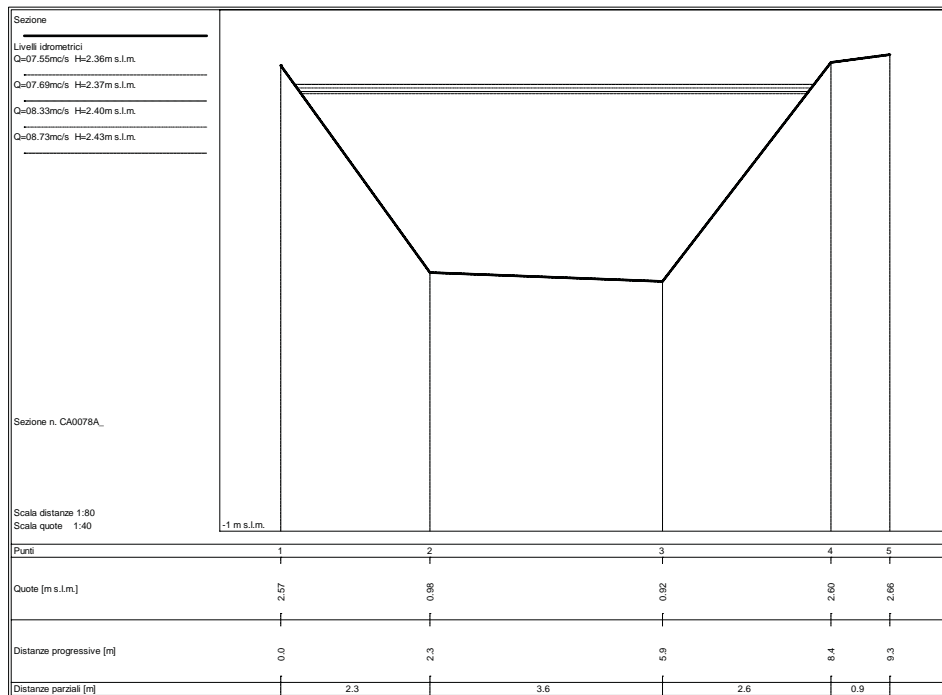
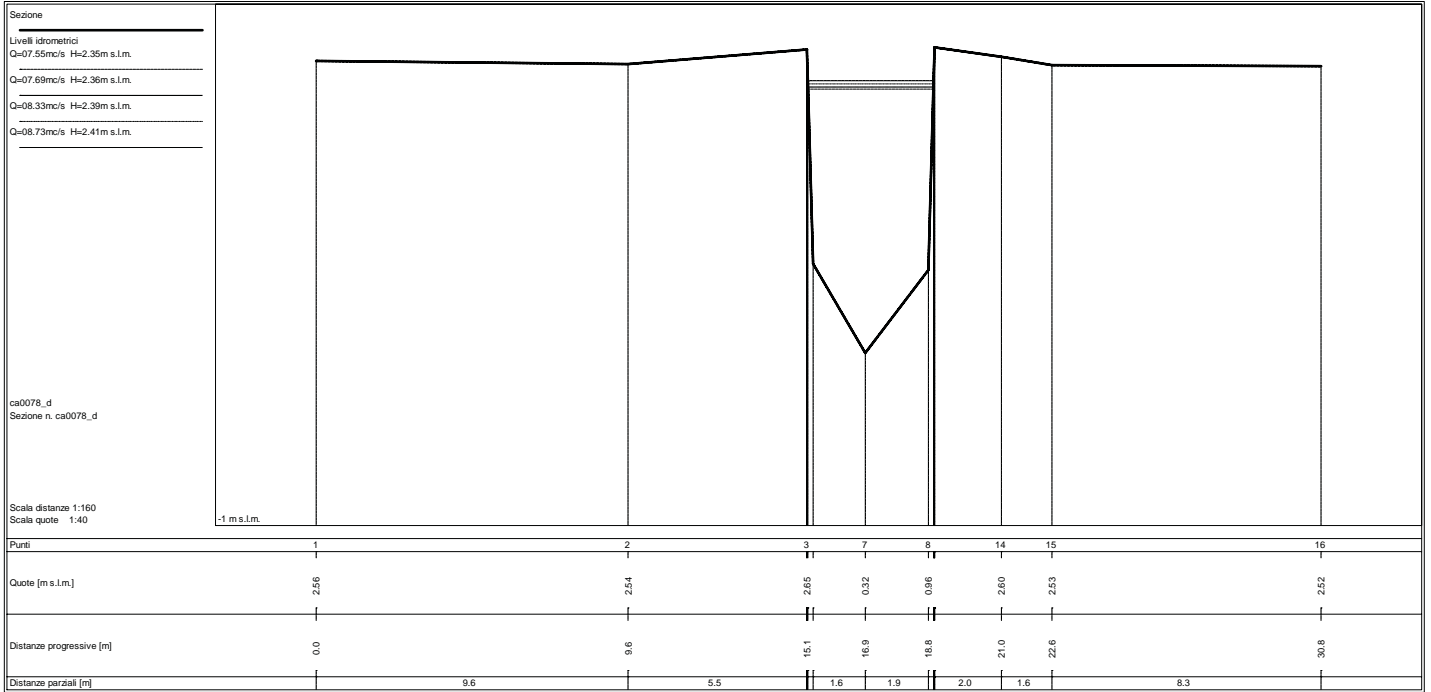

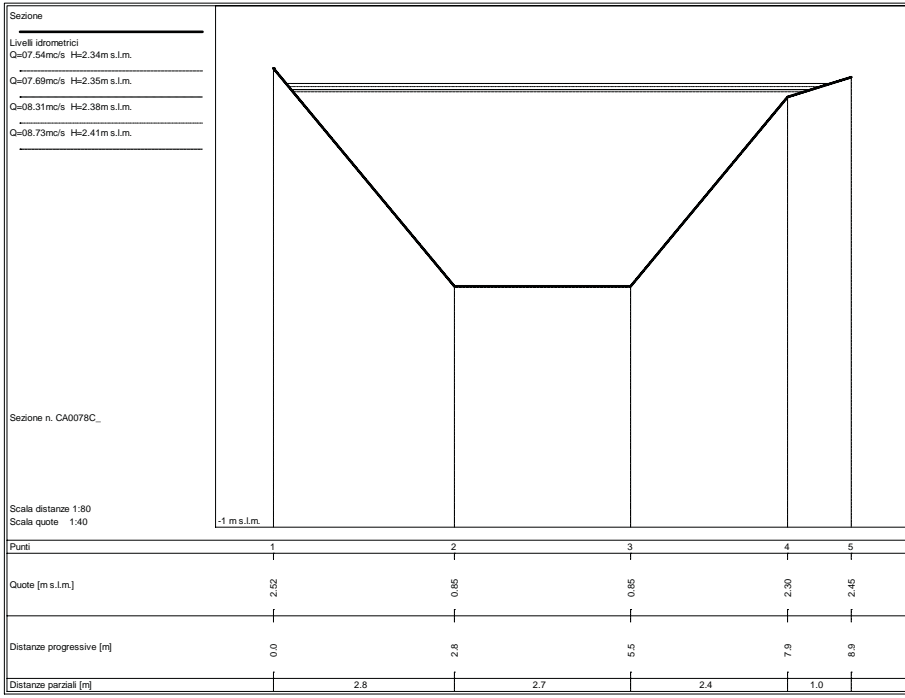
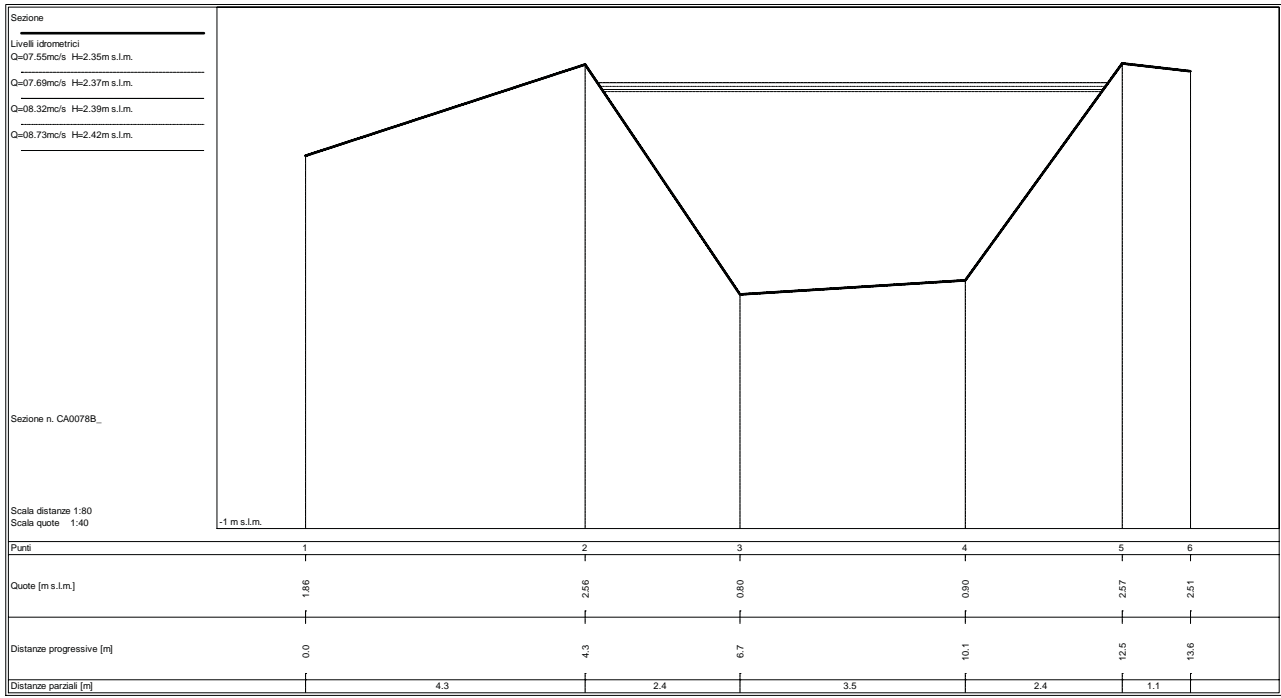

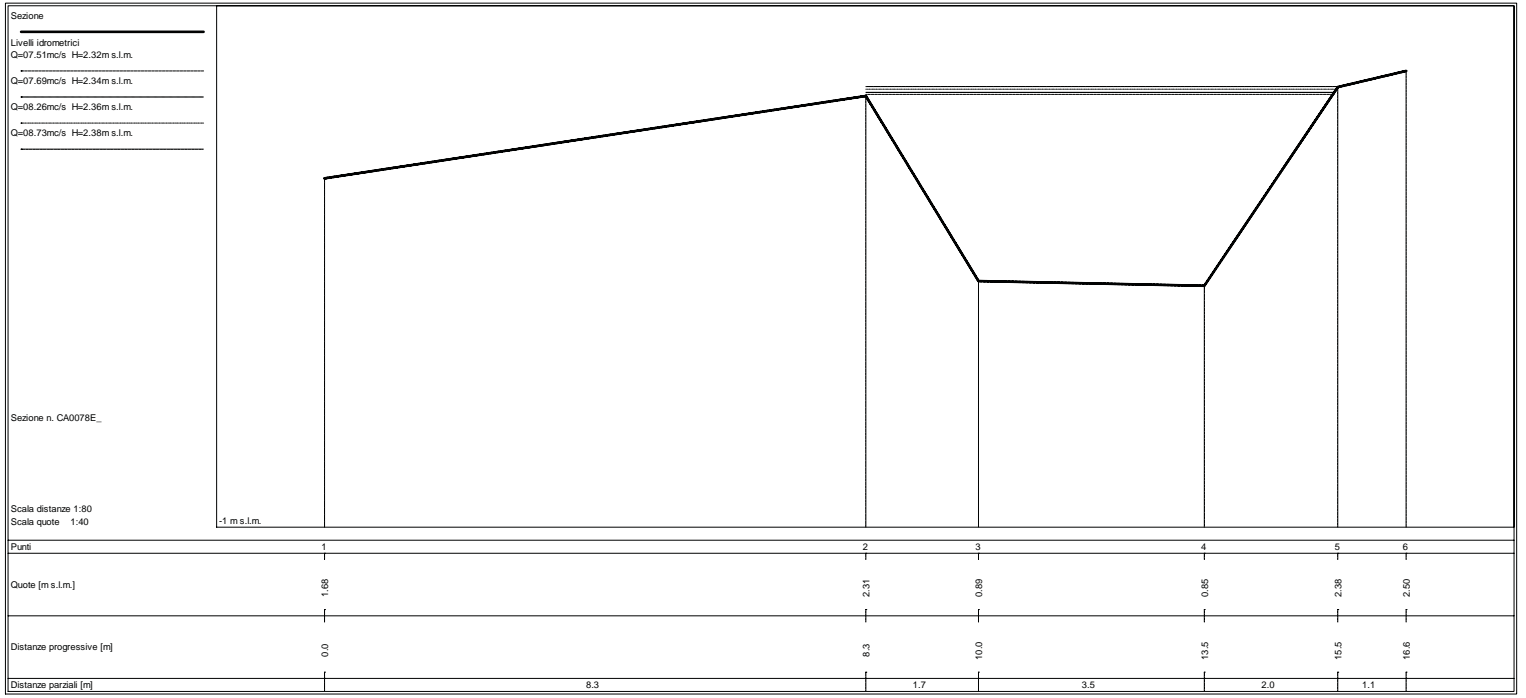
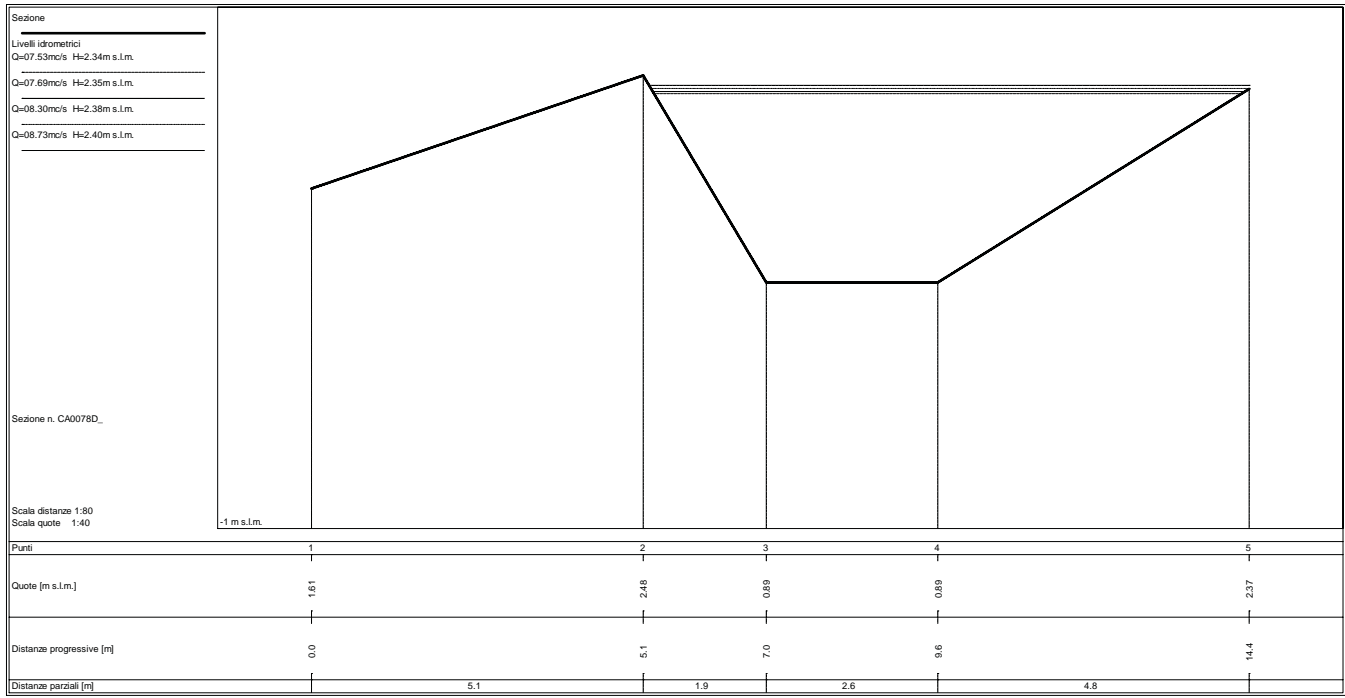

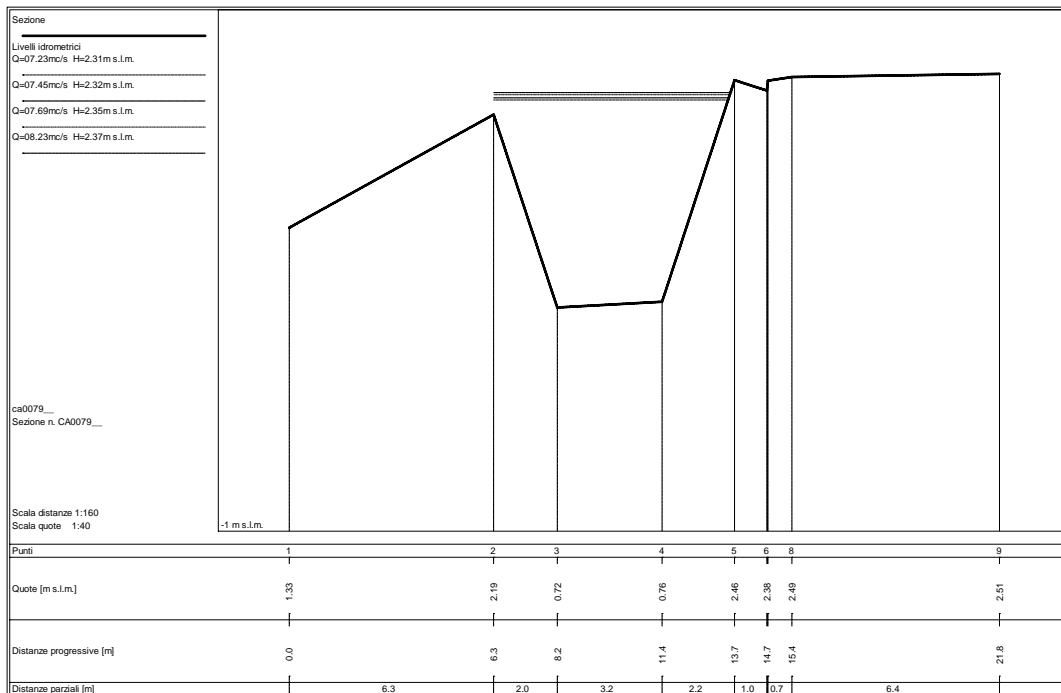
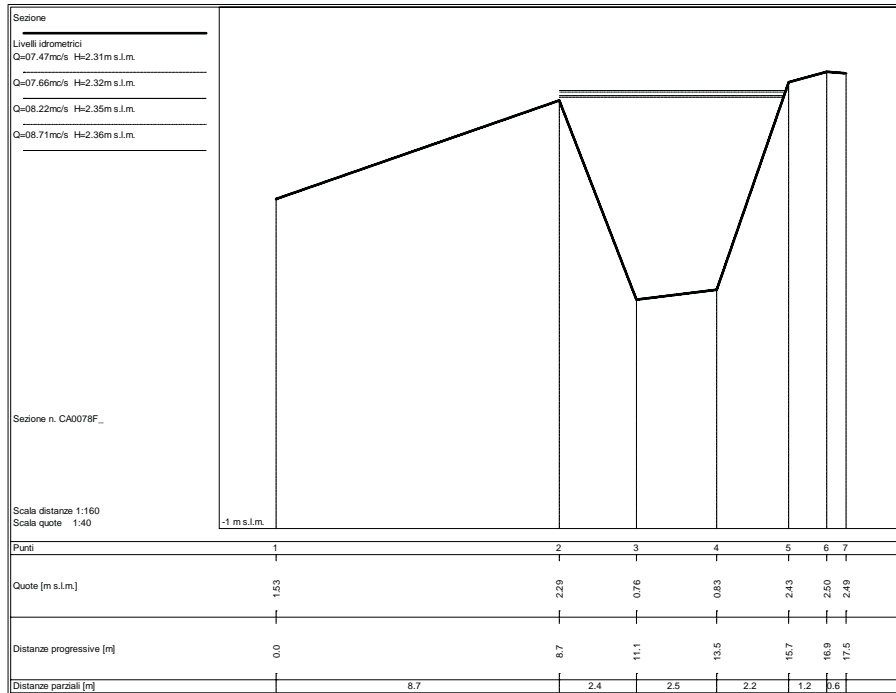

STATO ATTUALE

Sezioni fluviali canale degli Sforza

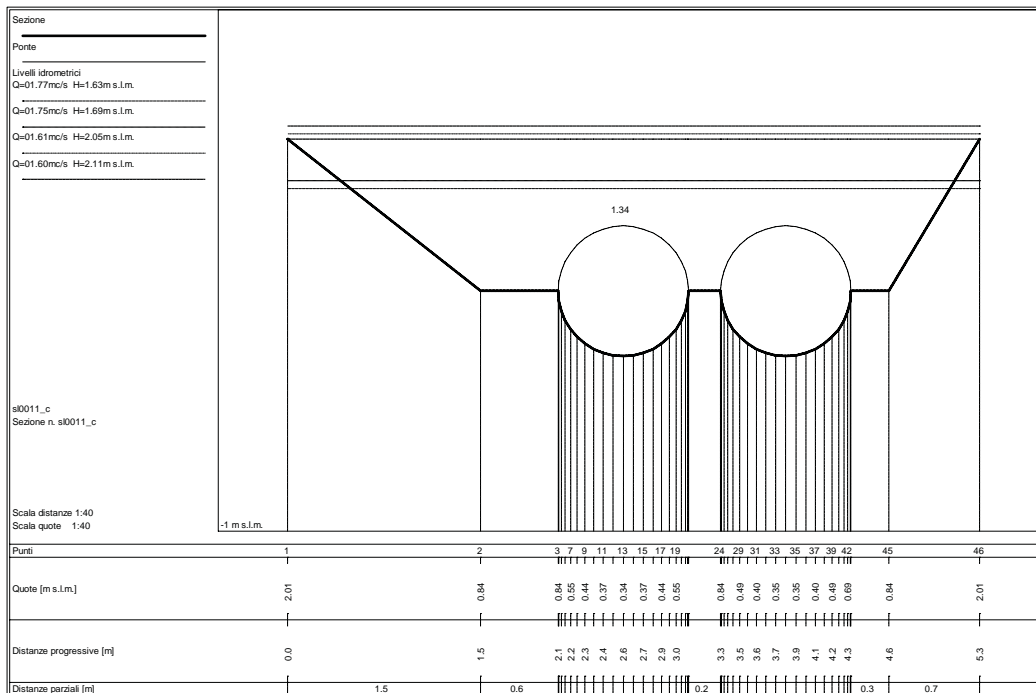
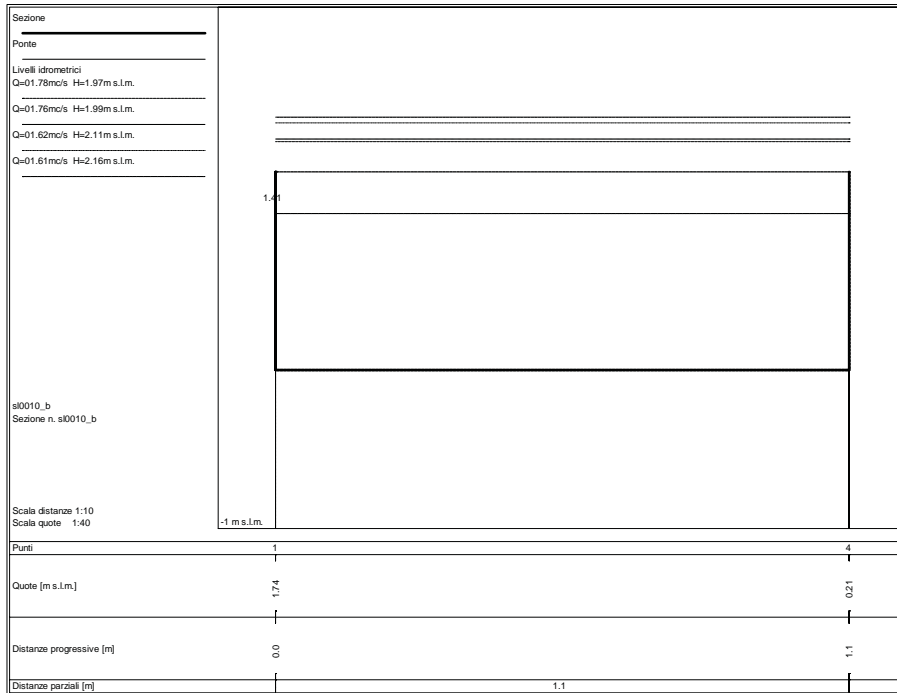

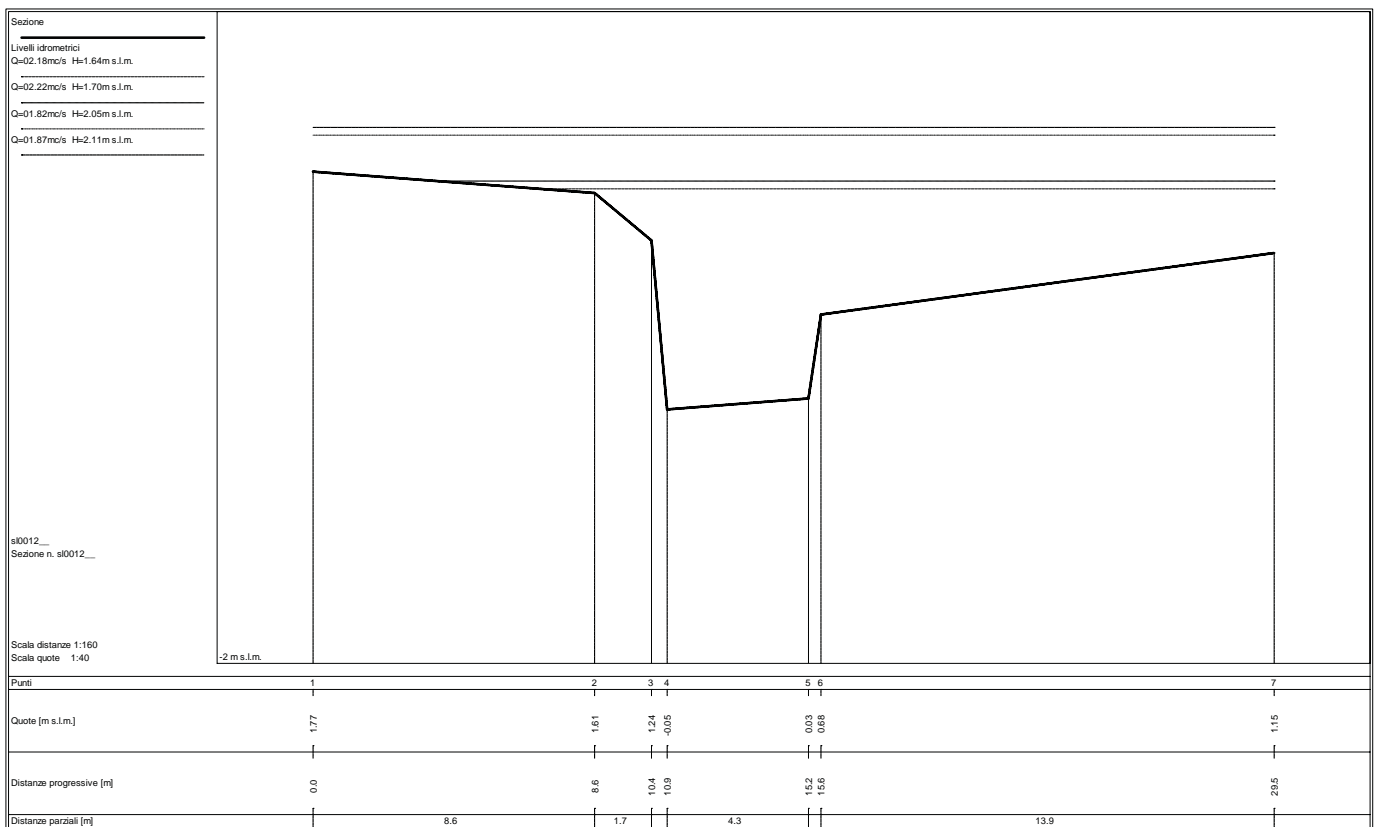
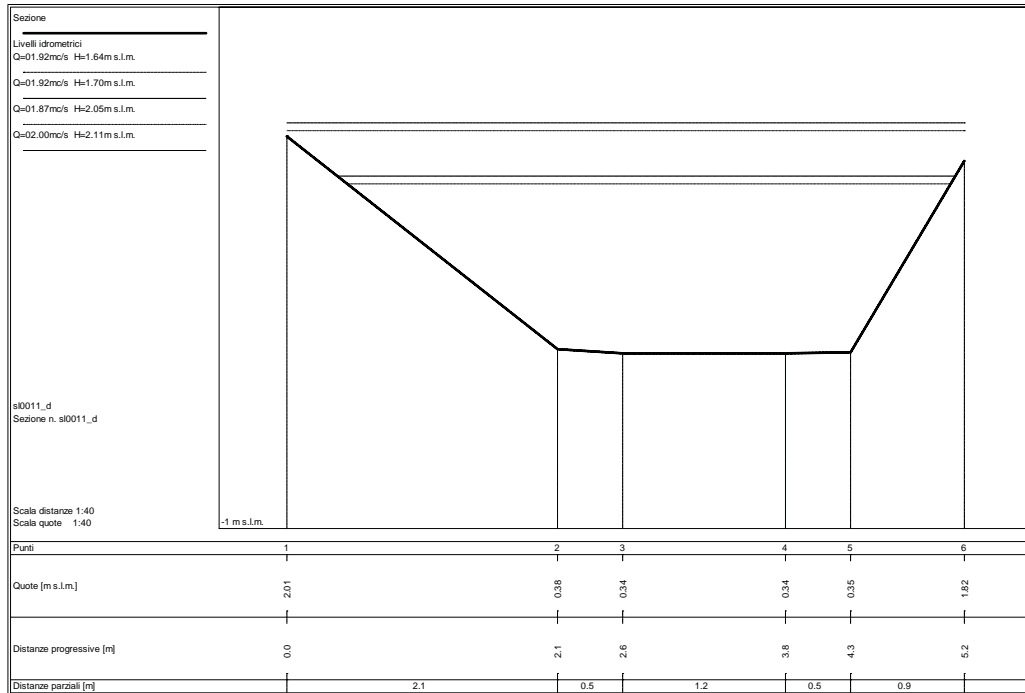

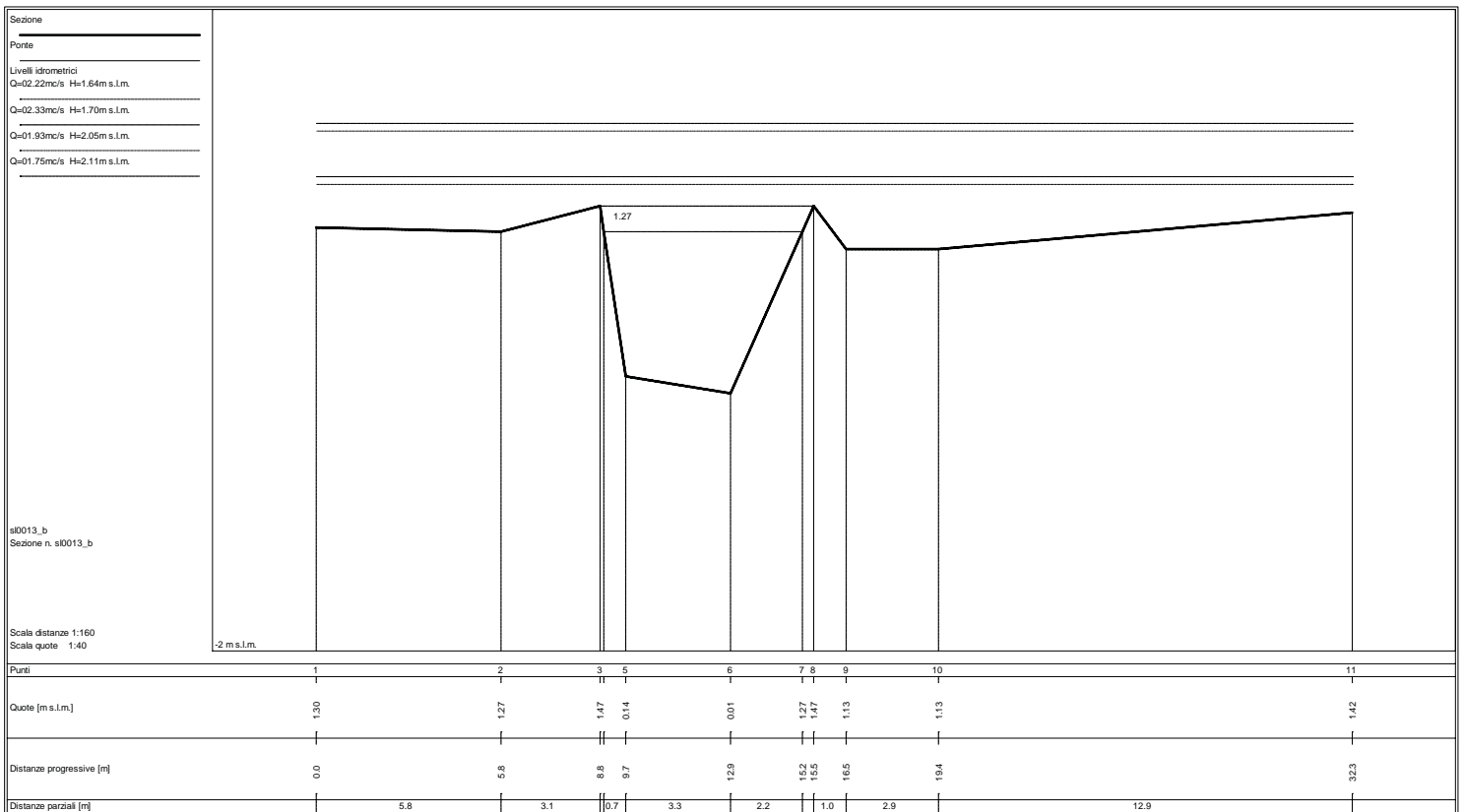
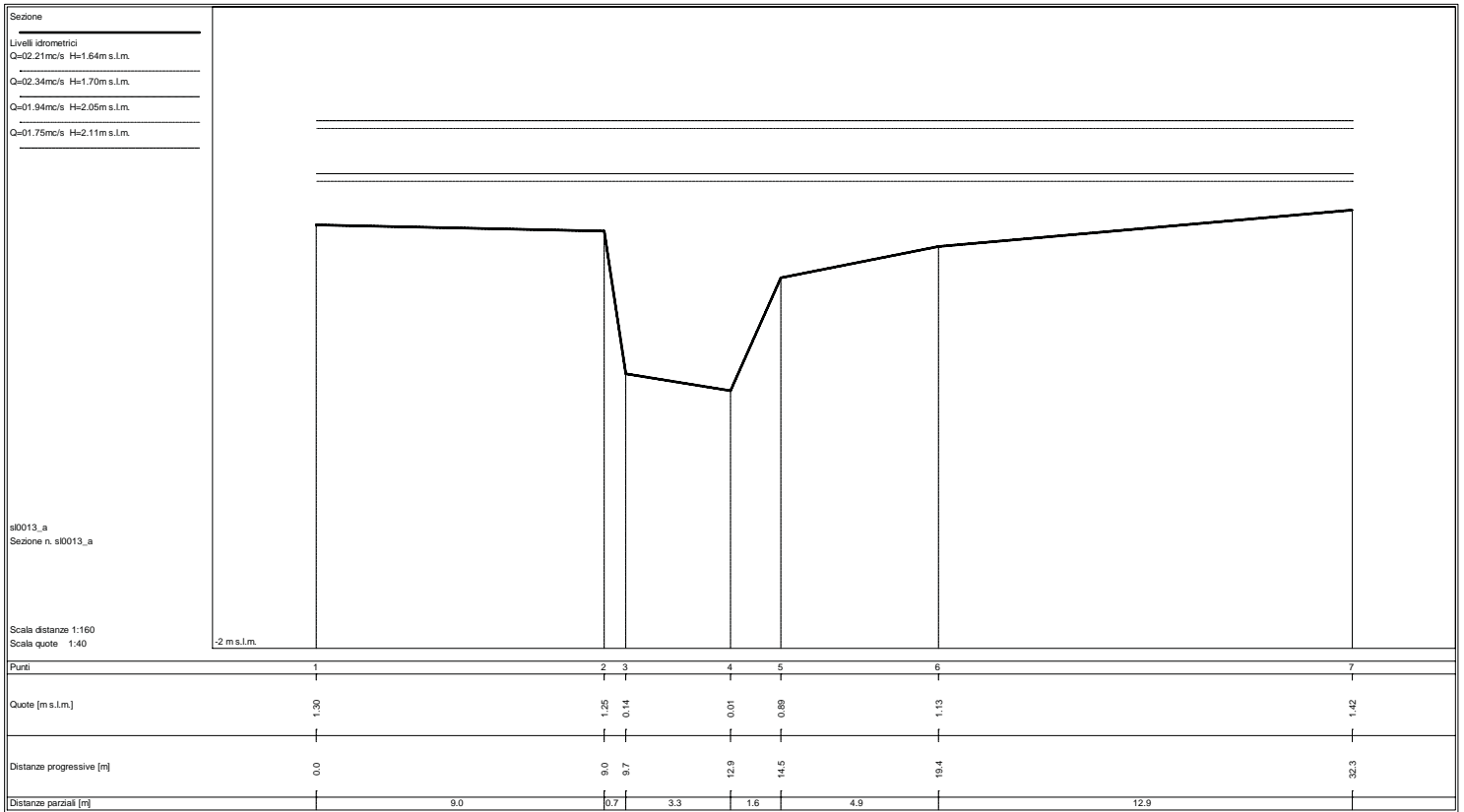

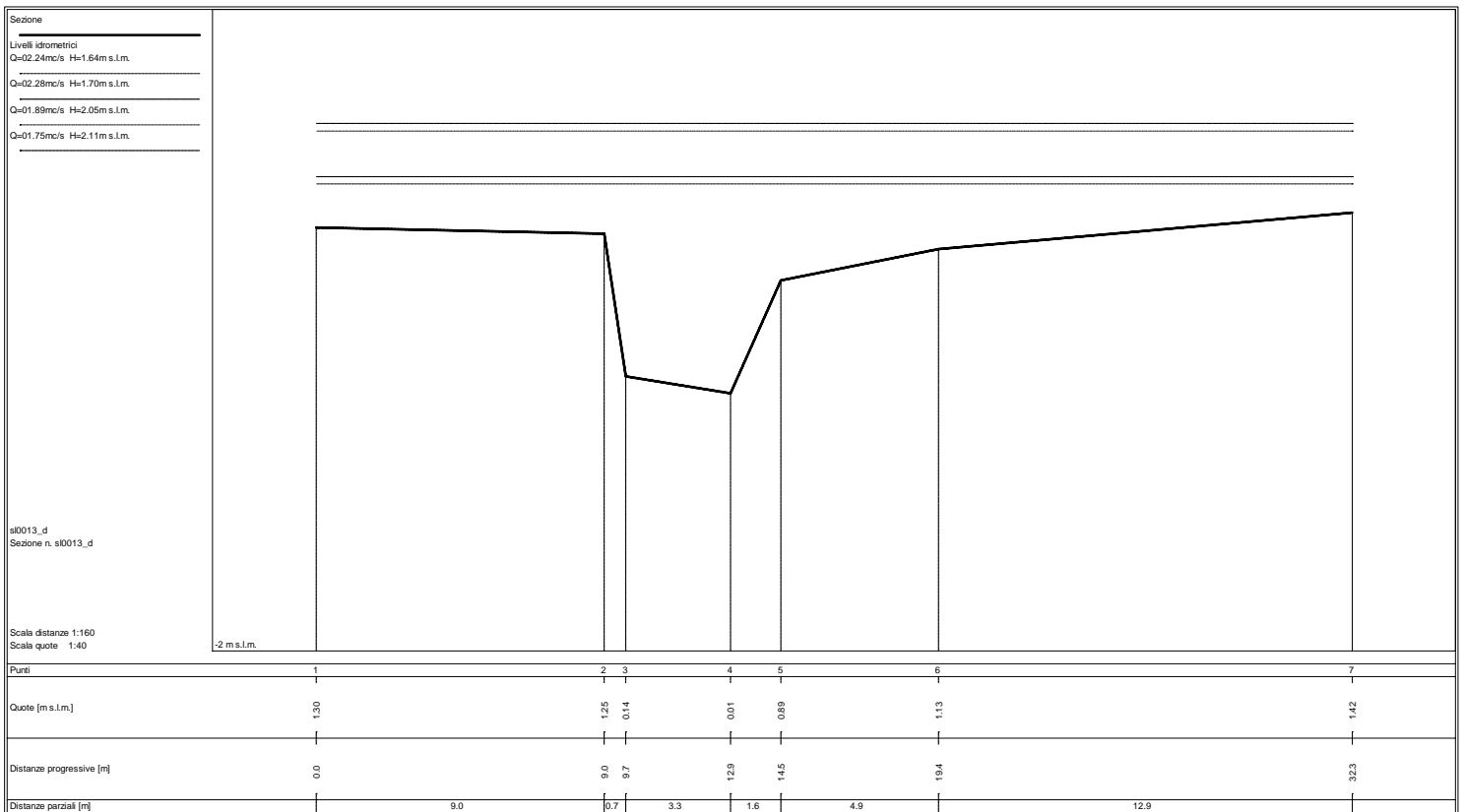
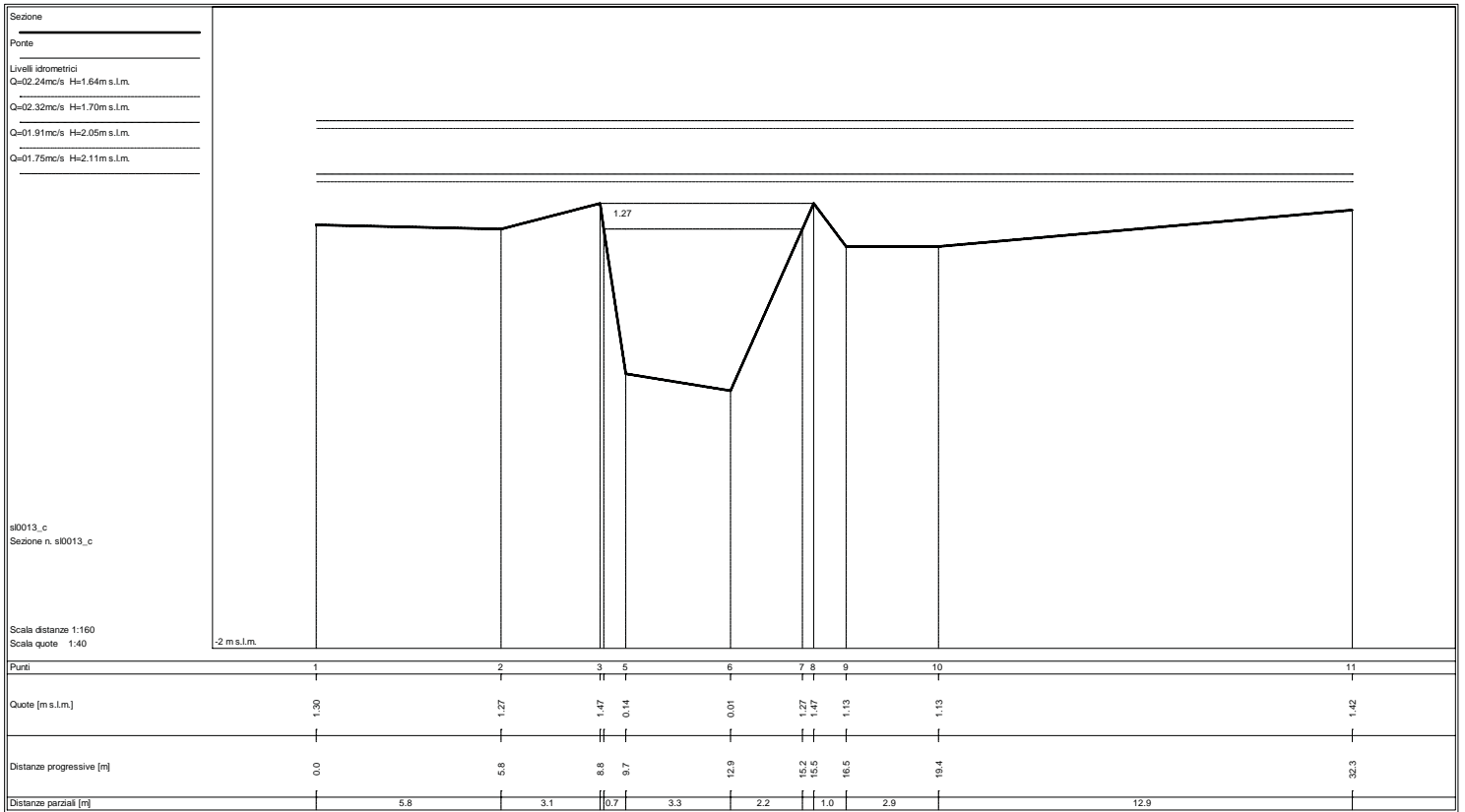

Sezione

Livelli idrometrici

Q=02.21mc/s H=1.64m s.l.m.

Q=02.08mc/s H=1.70m s.l.m.

Q=01.78mc/s H=2.05m s.l.m.

Q=01.75mc/s H=2.11m s.l.m.

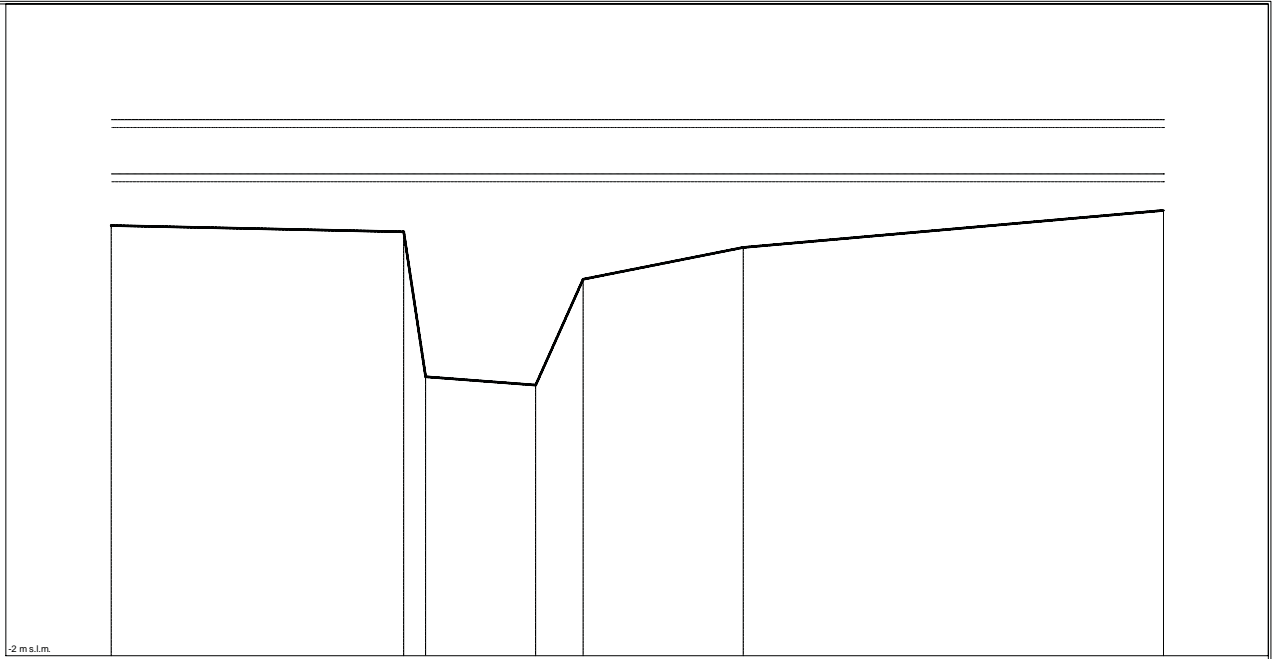

s0014_a
Sezione n. s0014_a

Scala distanze 1:160
Scala quote 1:40

Punti	1	2	3	4	5	6	7
Quote [m s.l.m.]	1.30	1.25	0.14	0.07	0.89	1.13	1.42
Distanze progressive [m]	0.0	9.0	9.7	13.0	14.5	19.4	32.3
Distanze parziali [m]		9.0	0.7	3.4	1.5	4.9	12.9

Sezione

Porte

Livelli idrometrici

Q=02.21mc/s H=1.55m s.l.m.

Q=02.08mc/s H=1.62m s.l.m.

Q=01.93mc/s H=2.04m s.l.m.

Q=01.81mc/s H=2.10m s.l.m.



s0014_b
Sezione n. s0014_b

Scala distanze 1:10
Scala quote 1:40

Punti	1	4
Quote [m s.l.m.]	1.52	0.07
Distanze progressive [m]	0.0	2.0
Distanze parziali [m]		2.0

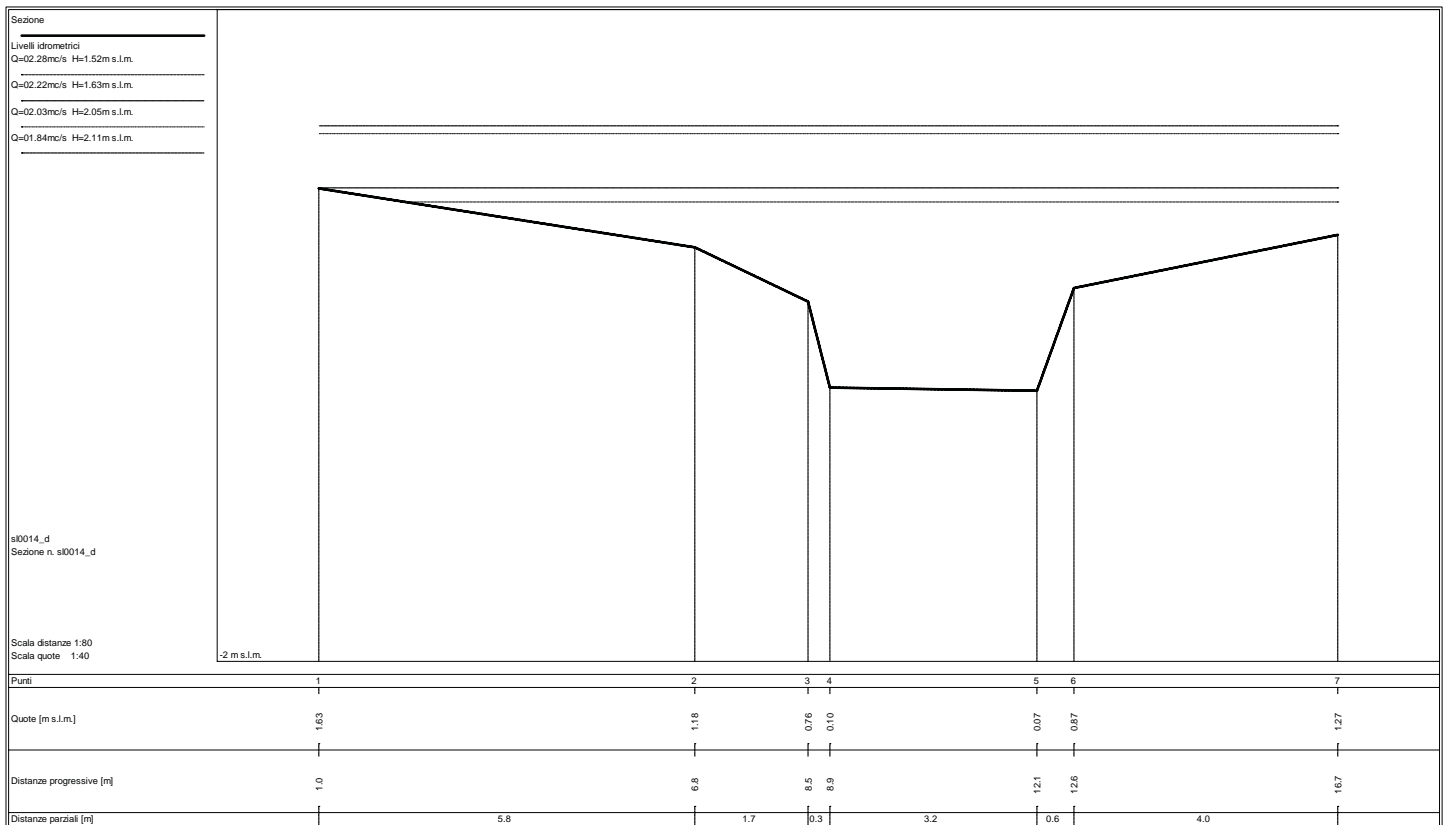
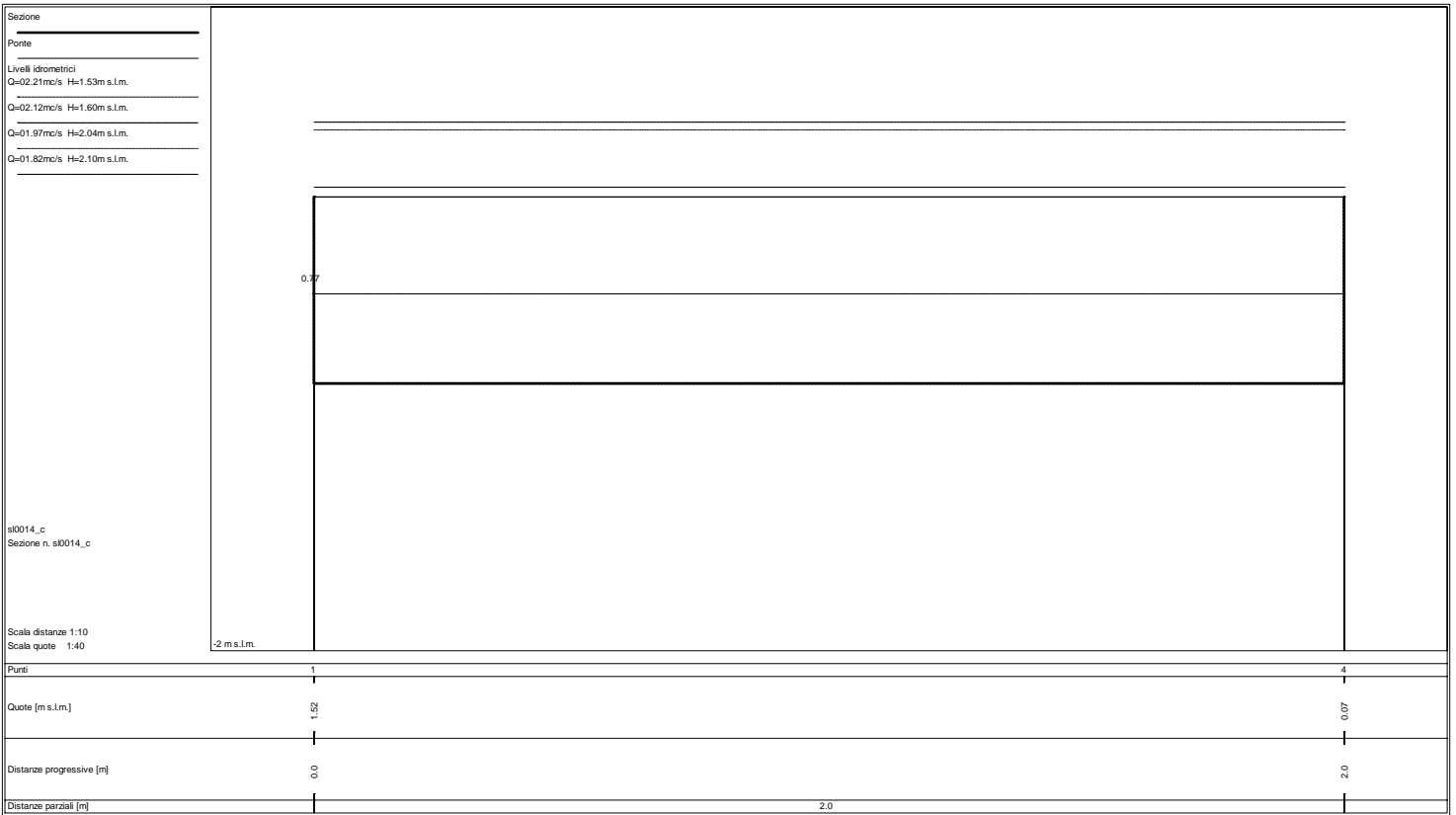

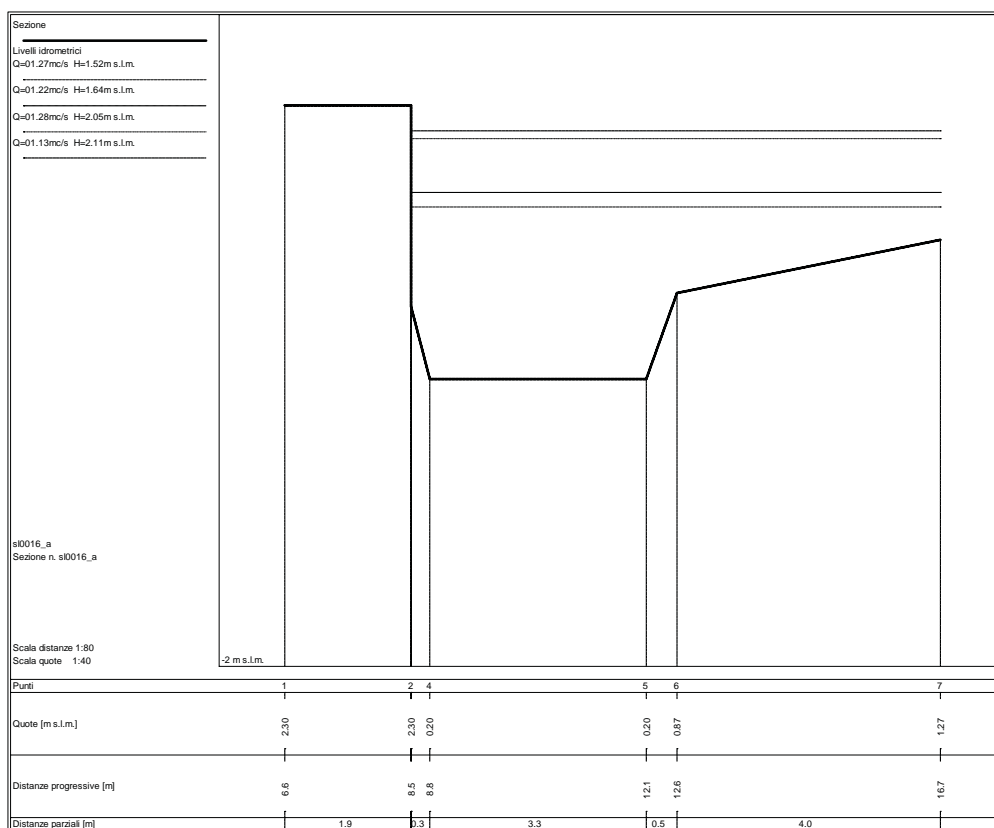
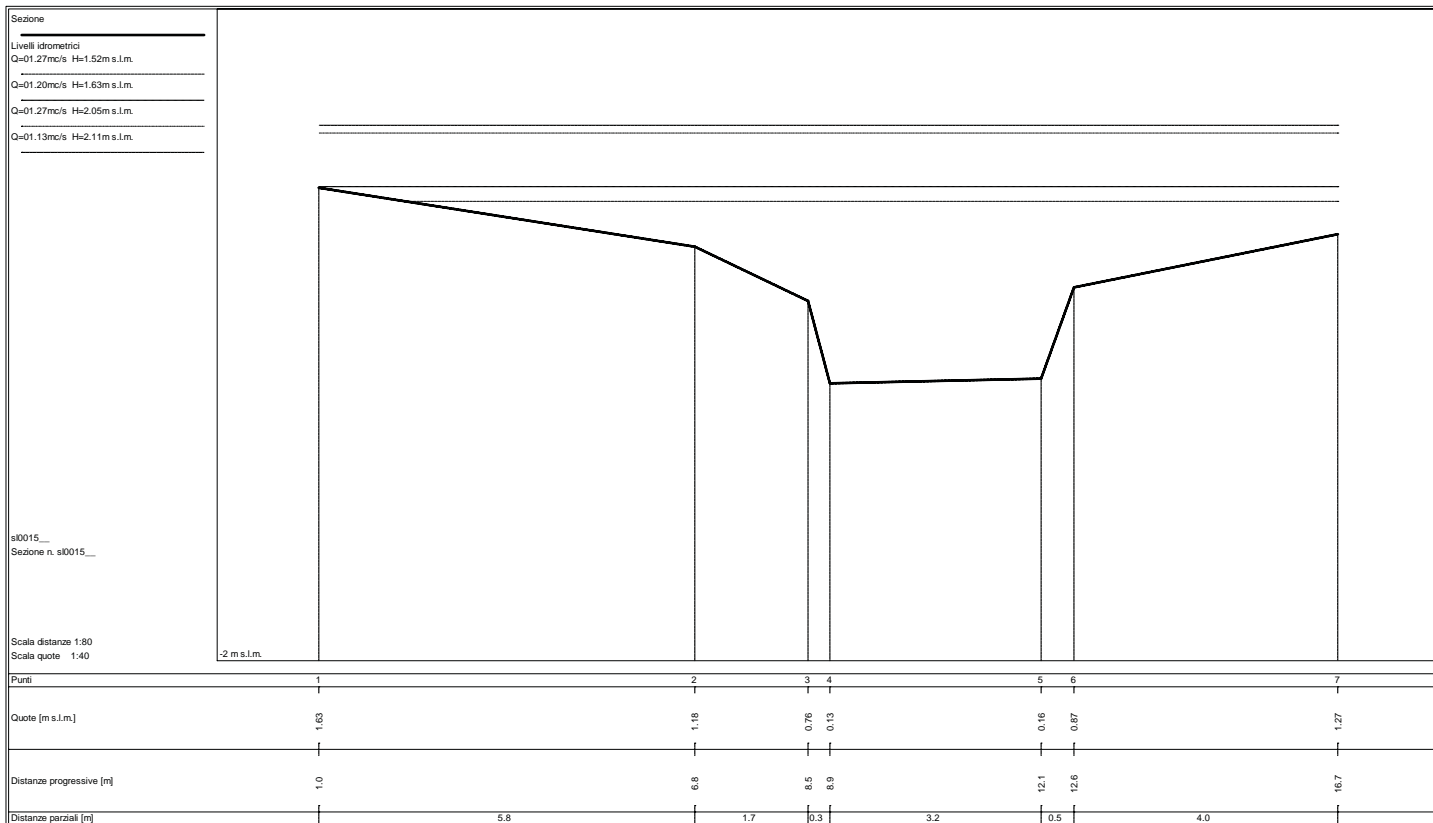

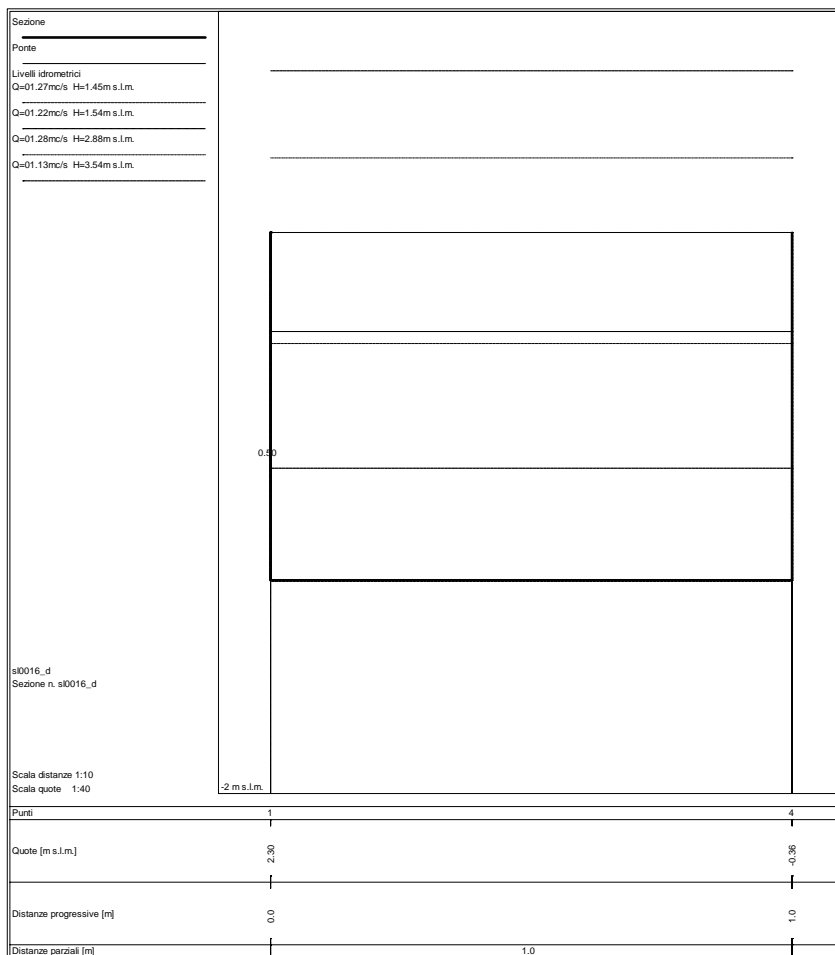
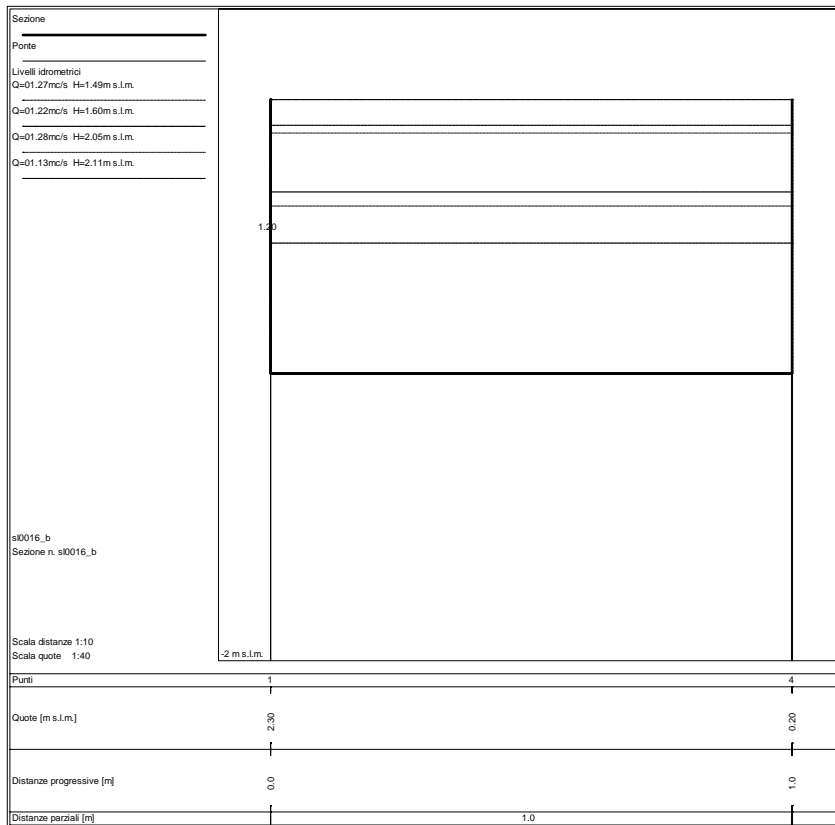

STATO ATTUALE

Sezioni fluviali fosso del Sale

