

**COMUNE DI MASSA**  
 Provincia di Massa Carrara



PROGETTO:

**STUDIO IDROLOGICO E IDRAULICO PER LA REVISIONE DELLA PERICOLOSITA'  
 IDRAULICA DEI PRINCIPALI CORSI D'ACQUA NEL COMUNE DI MASSA**

OGGETTO:

**ALLEGATO B1**  
**Sezioni fluviali e livelli idrici fosso Brugiano**

|                         |                   |                             |                    |                                 |                                      |
|-------------------------|-------------------|-----------------------------|--------------------|---------------------------------|--------------------------------------|
| ELABORATO:<br><b>B1</b> | REV:<br><b>01</b> | DATA:<br><b>Maggio 2010</b> | SCALA:<br><b>-</b> | NUMERO COMMESSA:<br><b>L523</b> | NOME FILE:<br><b>Allegato_B1.pdf</b> |
|-------------------------|-------------------|-----------------------------|--------------------|---------------------------------|--------------------------------------|

**PHYSIS**  
 INGEGNERIA PER L'AMBIENTE

Via Bonifacio Lupi, 1  
 50129 - Firenze

PROGETTISTA:  
 Dott. Ing. David Settesoldi

COLLABORATORI:  
 Dott. Ing. Andrea Badiani  
 Dott. Silvia Angelini

|      |          |                       |  |
|------|----------|-----------------------|--|
| 02   |          |                       |  |
| 01   | 07/05/10 | SECONDA EMISSIONE     |  |
| 00   | 05/02/09 | PRIMA EMISSIONE       |  |
| REV. | DATA     | DESCRIZIONE MODIFICHE |  |

|  |  |  |
|--|--|--|
|  |  |  |
|--|--|--|

## INDICE

|                         |     |
|-------------------------|-----|
| Fosso Becaro            | 2   |
| Fosso Dalmine           | 13  |
| Fosso Silcia – ramo a   | 38  |
| Fosso Silcia – ramo b   | 60  |
| Fosso Silcia – ramo c   | 64  |
| Fosso Lodolina          | 79  |
| Fosso di Mezzo – ramo a | 86  |
| Fosso di Mezzo – ramo b | 108 |
| Fosso di Mezzo – ramo c | 130 |
| Fosso Connettore 1      | 137 |
| Fosso Connettore 2      | 140 |
| Fosso Brugiano – ramo a | 145 |
| Fosso Brugiano – ramo b | 156 |
| Fosso Brugiano – ramo c | 163 |
| Fosso Tornabuoni        | 173 |

## **FOSSO BECARO**

Sezione

\_\_\_\_\_  
 Livelli idrometrici  
 Q=0.77mc/s H=1.95m s.l.m.  
 \_\_\_\_\_  
 Q=0.97mc/s H=2.06m s.l.m.  
 \_\_\_\_\_  
 Q=1.80mc/s H=2.56m s.l.m.  
 \_\_\_\_\_

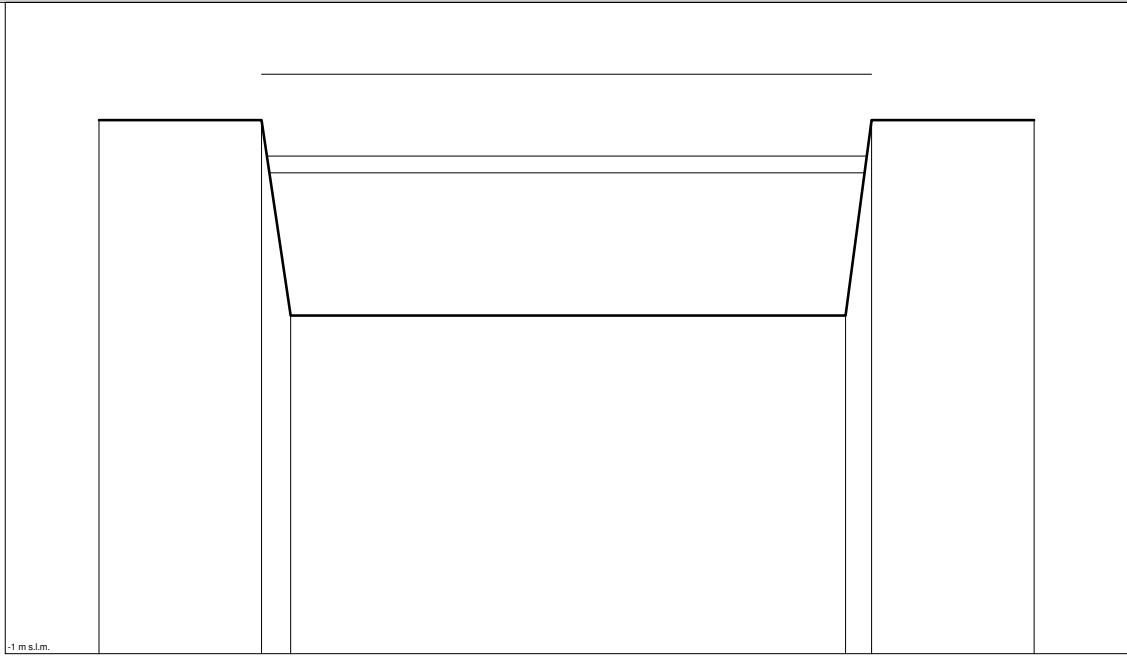

BEa009A\_  
 Sezione n. BEa009A\_

Scala distanze 1:16  
 Scala quote 1:32

|                          |      |      |      |      |      |      |
|--------------------------|------|------|------|------|------|------|
| Punti                    | 1    | 2    | 3    | 4    | 5    | 6    |
| Quote [m s.l.m.]         | 2.28 | 2.28 | 1.08 | 1.08 | 2.28 | 2.28 |
| Distanze progressive [m] | 0.0  | 0.5  | 0.6  | 2.3  | 2.4  | 2.9  |
| Distanze parziali [m]    |      | 0.5  | 0.1  | 1.7  | 0.1  | 0.5  |

Sezione

\_\_\_\_\_  
 Ponte  
 Livelli idrometrici  
 Q=0.77mc/s H=1.91m s.l.m.  
 \_\_\_\_\_  
 Q=0.97mc/s H=2.00m s.l.m.  
 \_\_\_\_\_  
 Q=1.80mc/s H=2.42m s.l.m.  
 \_\_\_\_\_

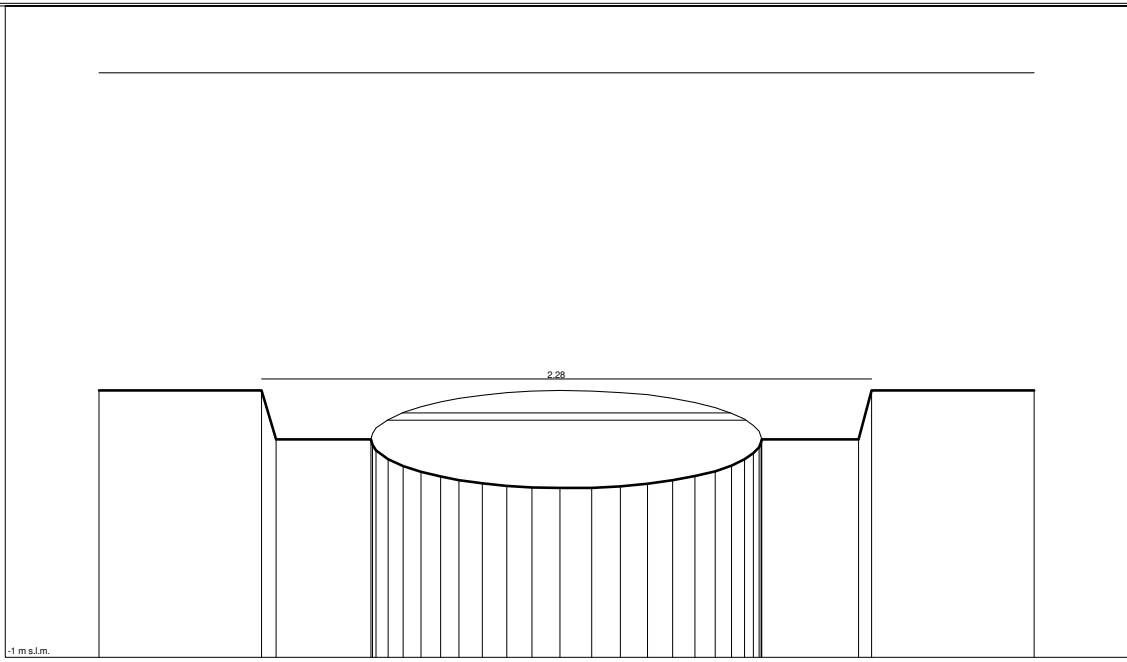

BEa009B\_  
 Sezione n. BEa009B\_

Scala distanze 1:16  
 Scala quote 1:64

|                          |      |      |      |      |      |      |      |      |      |      |      |      |      |      |      |      |      |      |      |      |      |      |      |      |      |
|--------------------------|------|------|------|------|------|------|------|------|------|------|------|------|------|------|------|------|------|------|------|------|------|------|------|------|------|
| Punti                    | 1    | 2    | 3    | 4    | 7    | 8    | 9    | 10   | 11   | 12   | 13   | 14   | 15   | 16   | 17   | 18   | 19   | 20   | 21   | 22   | 23   | 25   | 28   | 29   | 30   |
| Quote [m s.l.m.]         | 2.28 | 2.28 | 1.68 | 1.68 | 1.43 | 1.35 | 1.28 | 1.22 | 1.18 | 1.14 | 1.11 | 1.09 | 1.08 | 1.08 | 1.10 | 1.13 | 1.17 | 1.20 | 1.29 | 1.36 | 1.43 | 1.56 | 1.68 | 2.28 | 2.28 |
| Distanze progressive [m] | 0.0  | 0.5  | 0.5  | 0.8  | 0.9  | 0.9  | 1.0  | 1.1  | 1.1  | 1.2  | 1.3  | 1.3  | 1.4  | 1.5  | 1.6  | 1.7  | 1.8  | 1.9  | 1.9  | 1.9  | 2.0  | 2.0  | 2.3  | 2.4  | 2.9  |
| Distanze parziali [m]    |      | 0.5  |      | 0.3  |      |      | 0.1  | 0.1  | 0.1  | 0.1  | 0.1  | 0.1  | 0.1  | 0.1  | 0.1  | 0.1  | 0.1  | 0.1  | 0.1  | 0.1  | 0.1  | 0.1  | 0.3  |      | 0.5  |

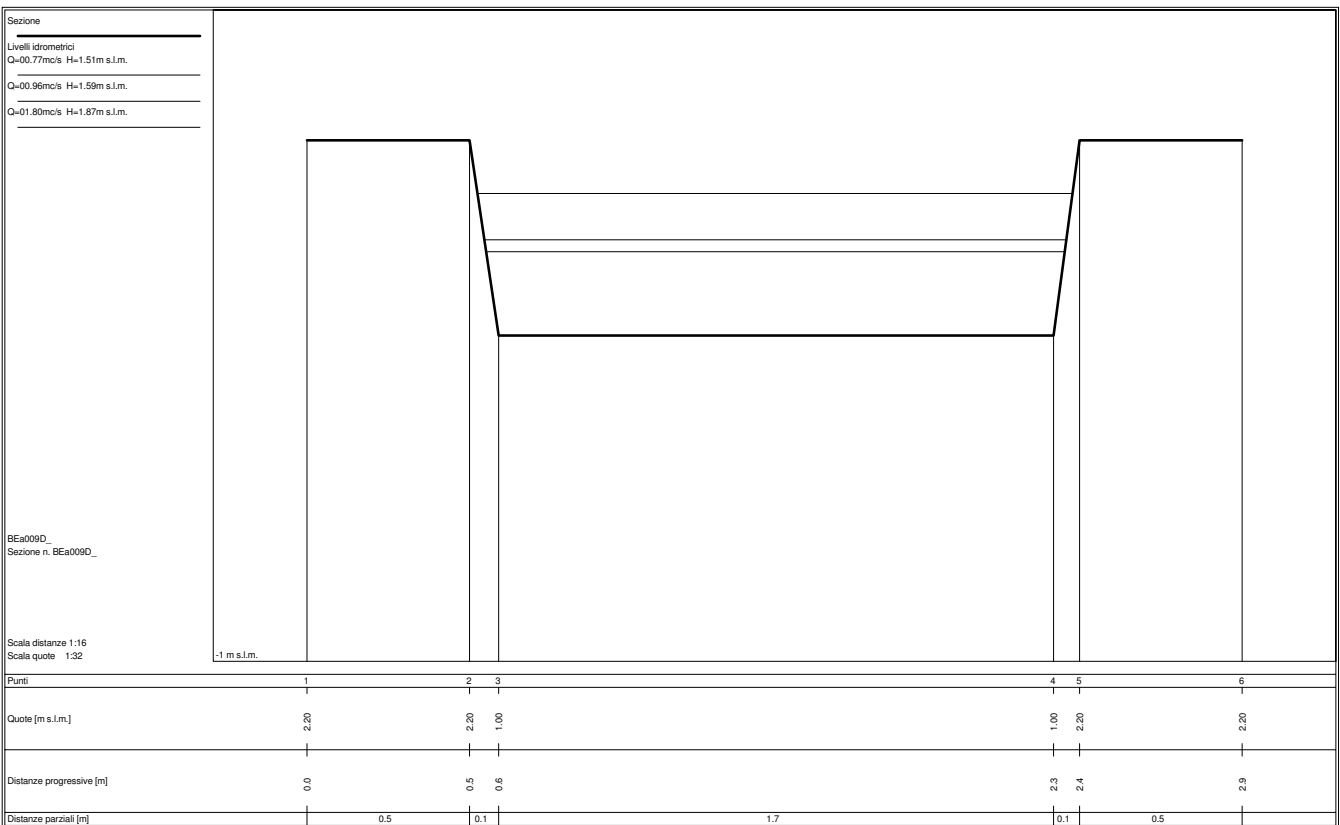
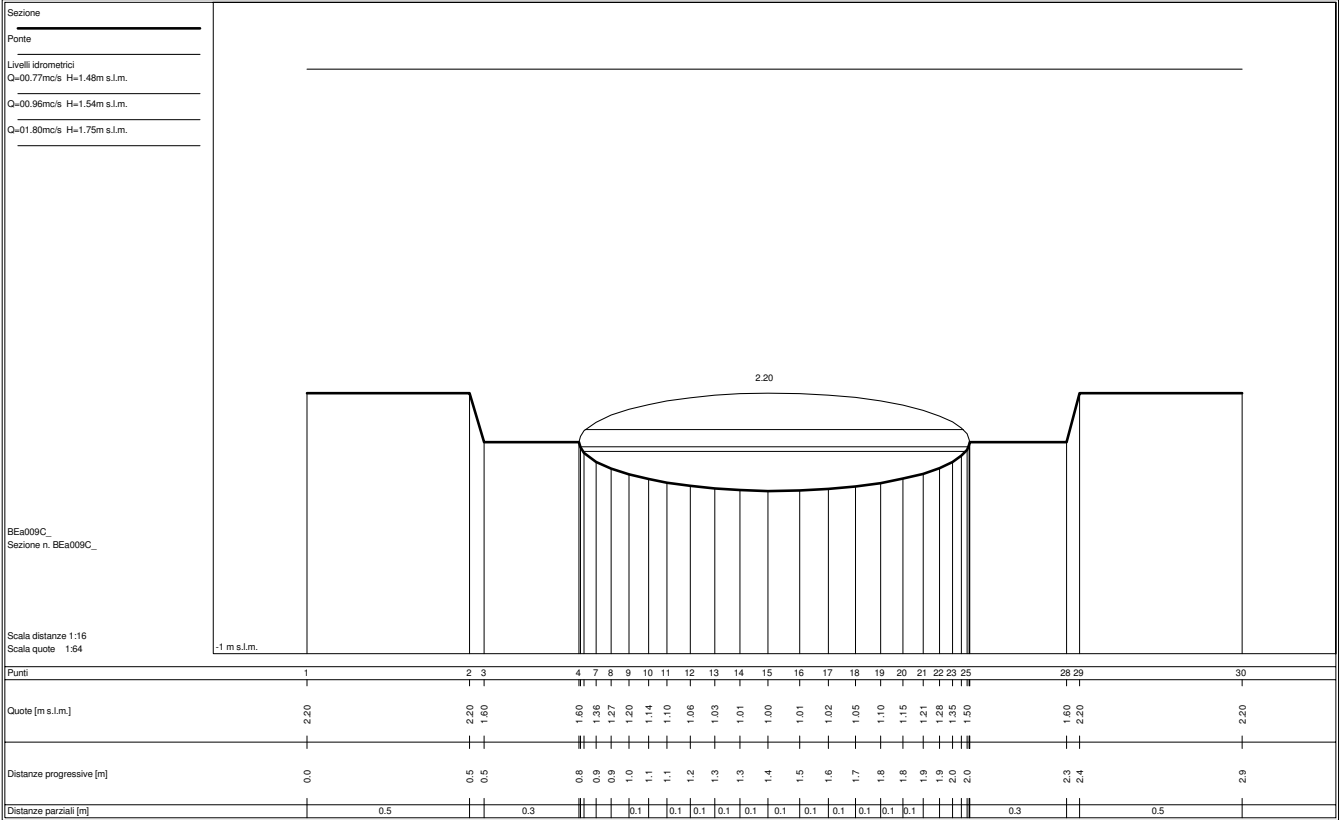

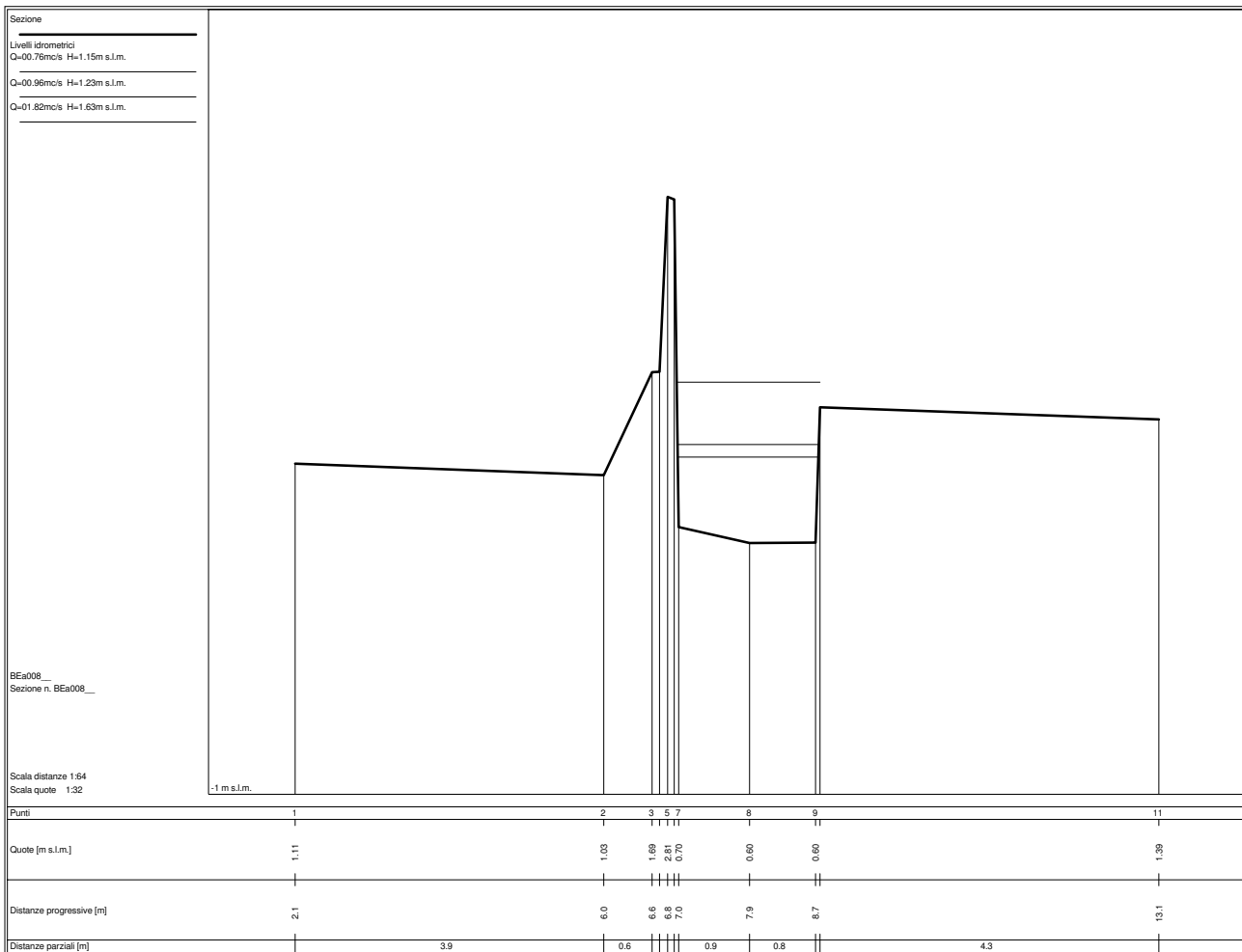
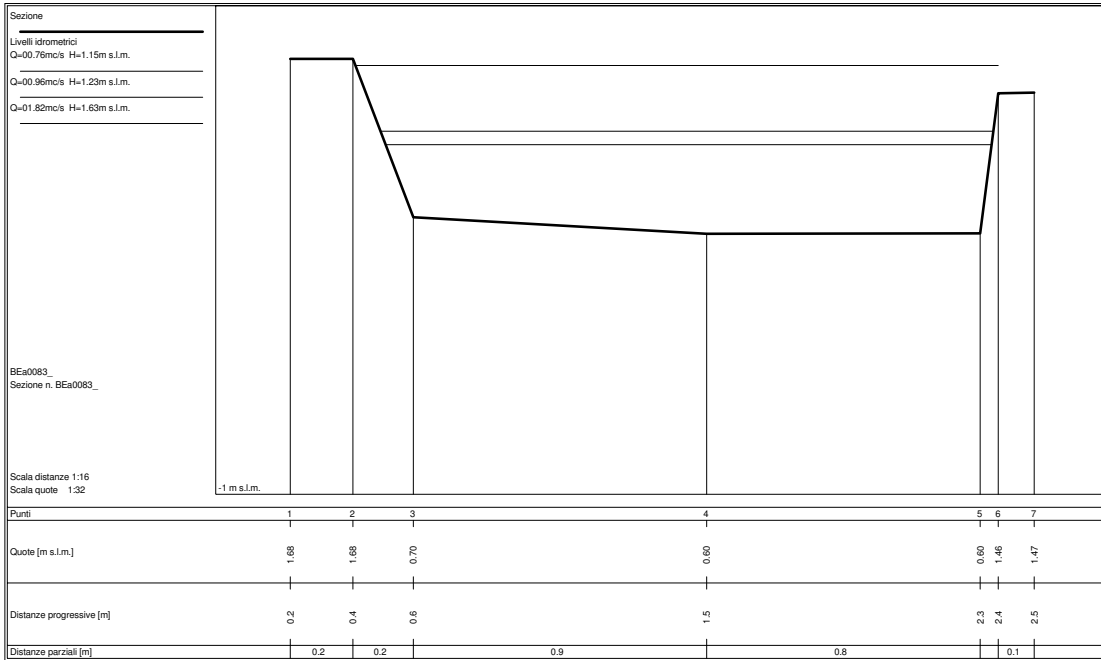

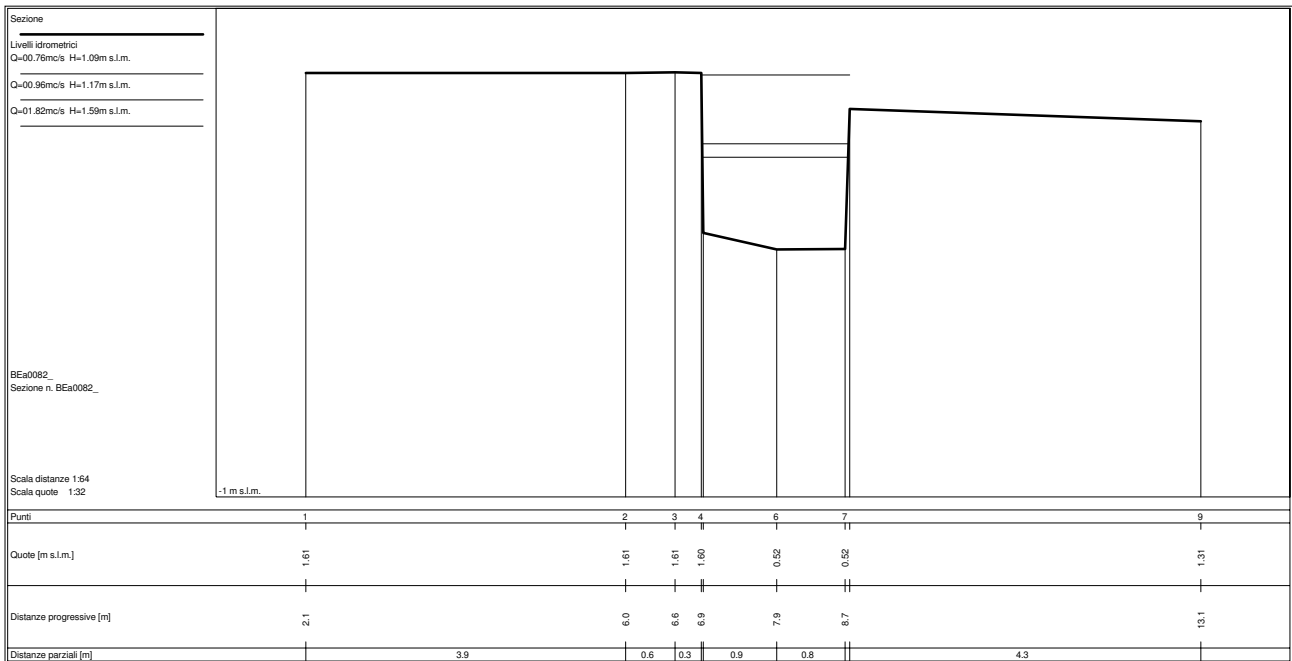
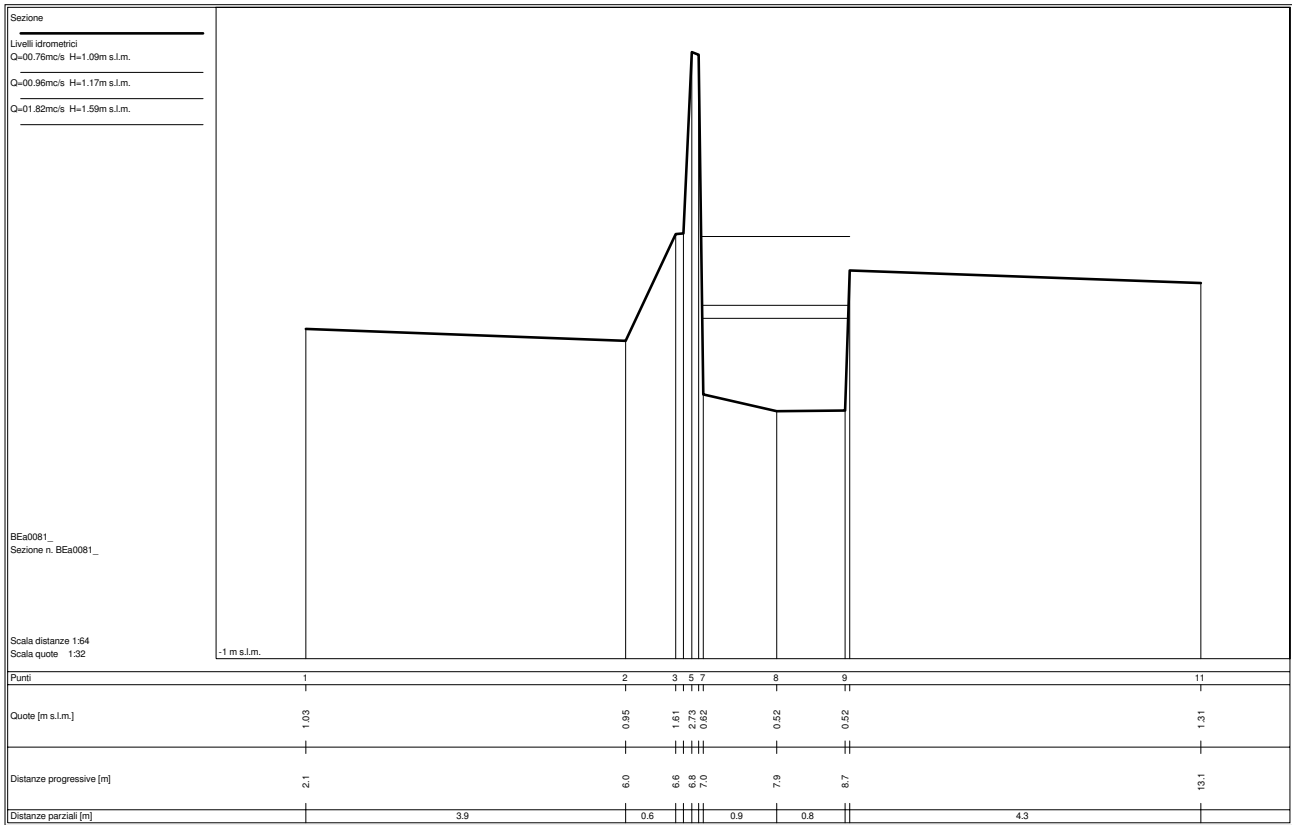

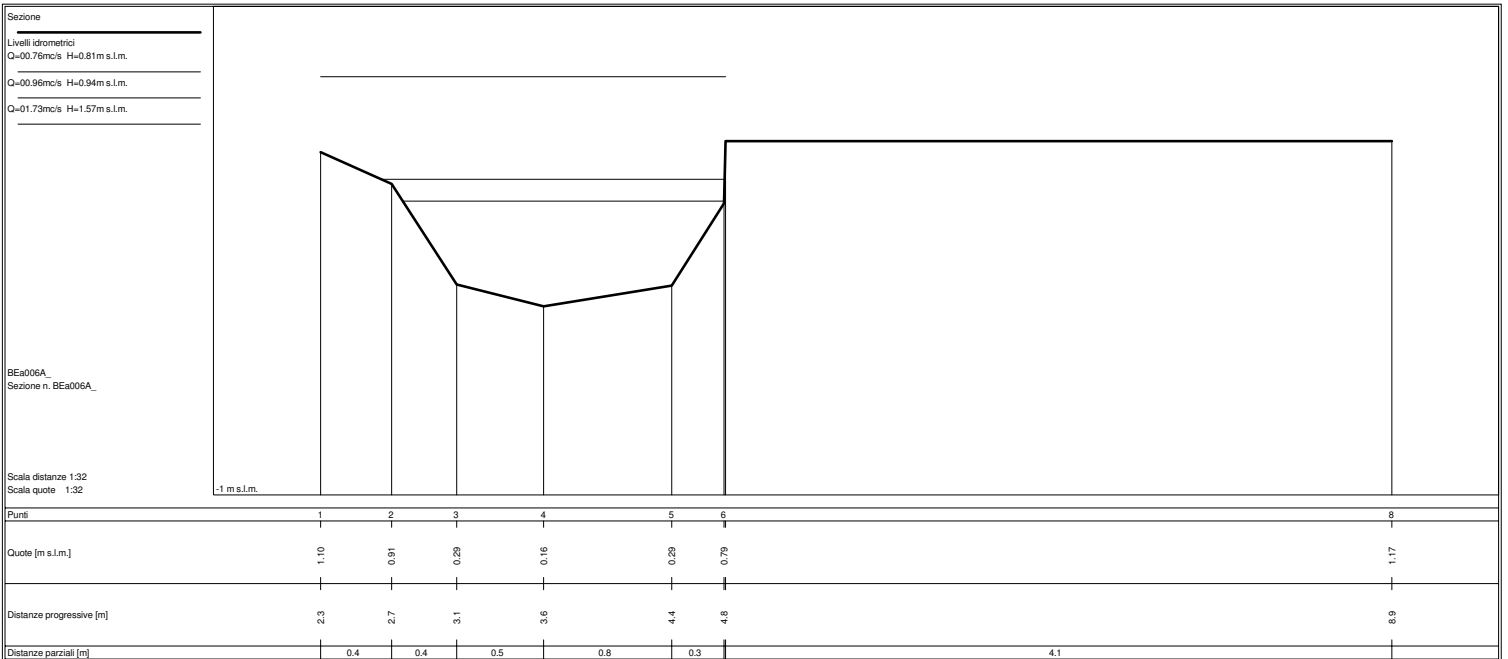
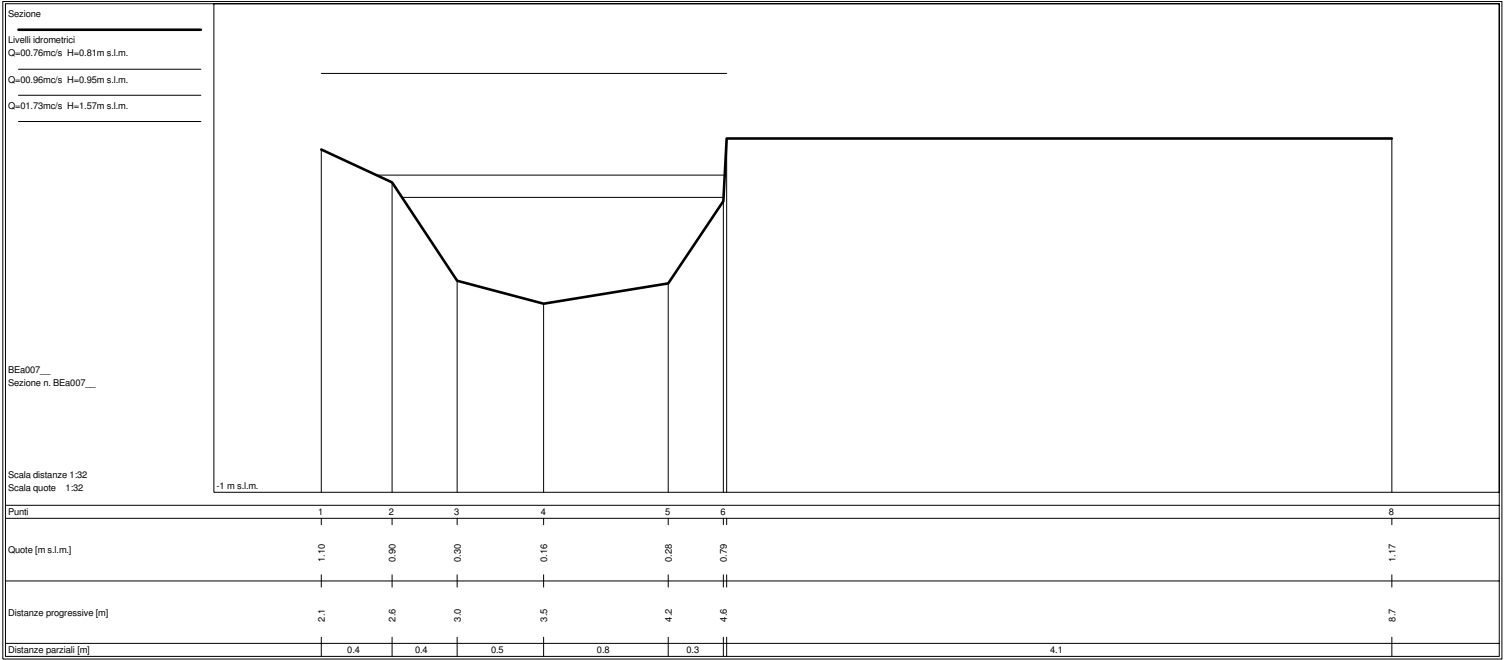



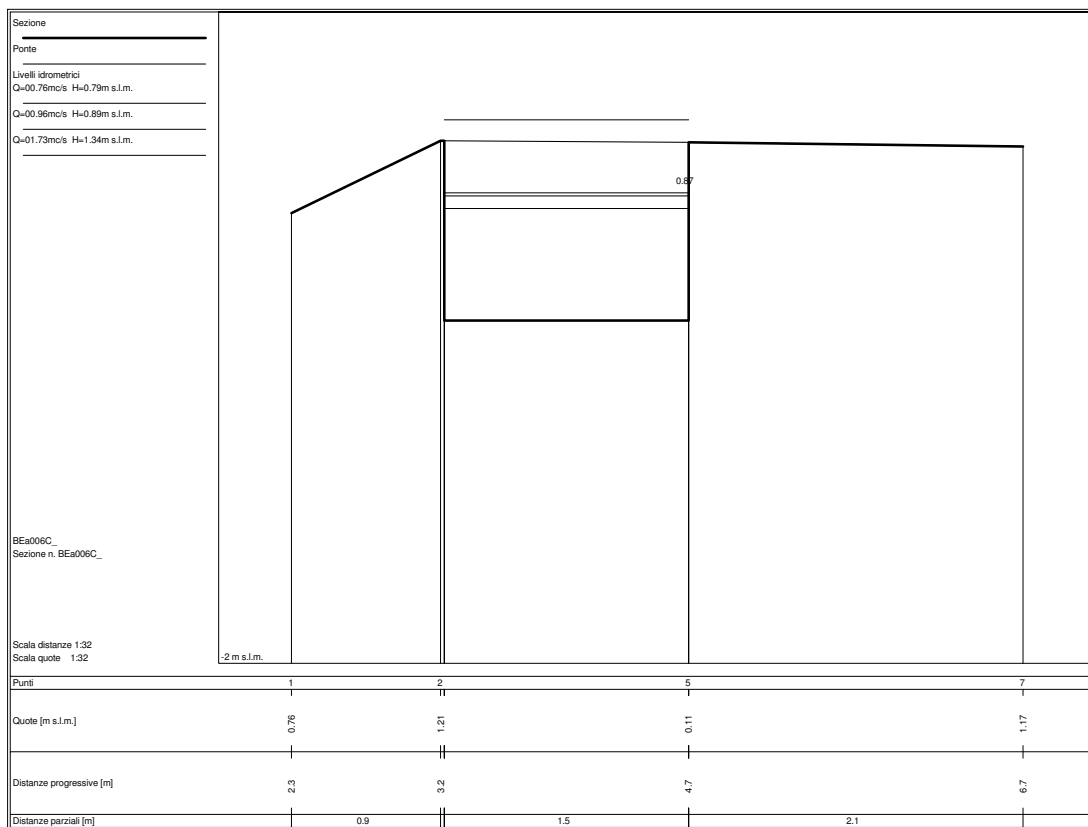
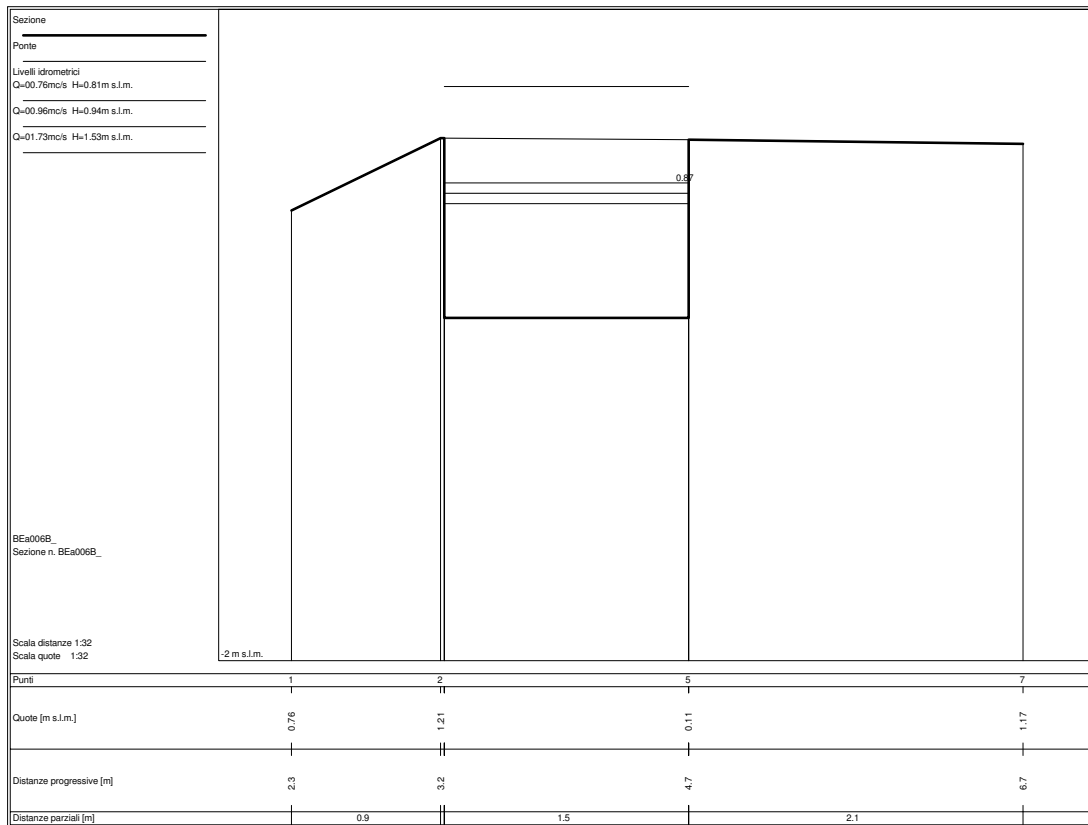

Sezione  
 Livelli idrometrici  
 Q=00.76mc/s H=0.79m s.l.m.  
 Q=00.96mc/s H=0.88m s.l.m.  
 Q=01.73mc/s H=1.36m s.l.m.

BEa005D\_  
 Sezione n. BEa005D\_

Scala distanze 1:32  
 Scala quote 1:32

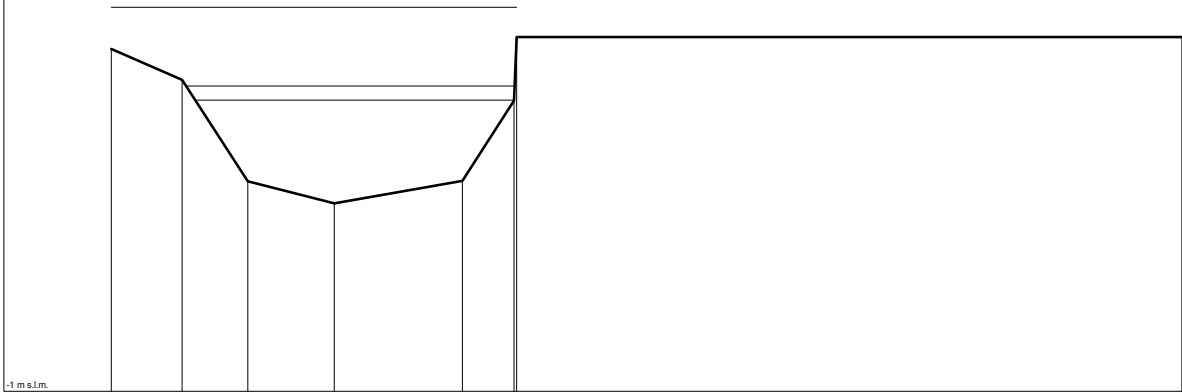

|                          |      |      |      |      |      |      |      |
|--------------------------|------|------|------|------|------|------|------|
| Punti                    | 1    | 2    | 3    | 4    | 5    | 6    | 8    |
| Quote [m s.l.m.]         | 1.10 | 0.91 | 0.29 | 0.16 | 0.29 | 0.79 | 1.18 |
| Distanze progressive [m] | 1.8  | 2.2  | 2.6  | 3.1  | 3.9  | 4.2  | 8.3  |
| Distanze parziali [m]    | 0.4  | 0.4  | 0.5  | 0.8  | 0.3  | 4.1  |      |

Sezione  
 Livelli idrometrici  
 Q=00.76mc/s H=0.78m s.l.m.  
 Q=00.96mc/s H=0.87m s.l.m.  
 Q=01.73mc/s H=1.36m s.l.m.

BEa004\_  
 Sezione n. BEa004\_

Scala distanze 1:32  
 Scala quote 1:32

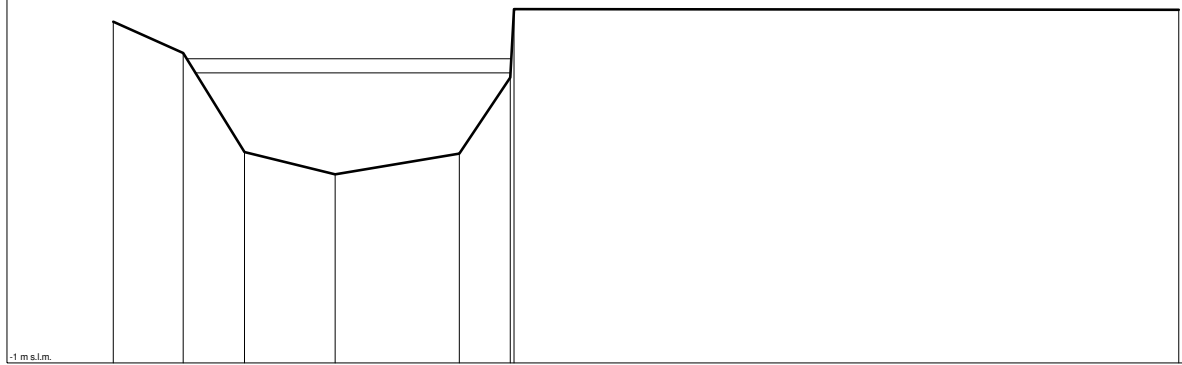

|                          |      |      |      |      |      |      |      |
|--------------------------|------|------|------|------|------|------|------|
| Punti                    | 1    | 2    | 3    | 4    | 5    | 6    | 8    |
| Quote [m s.l.m.]         | 1.10 | 0.90 | 0.30 | 0.16 | 0.29 | 0.75 | 1.17 |
| Distanze progressive [m] | 1.7  | 2.2  | 2.5  | 3.1  | 3.9  | 4.2  | 8.3  |
| Distanze parziali [m]    | 0.4  | 0.4  | 0.6  | 0.8  | 0.3  | 4.1  |      |

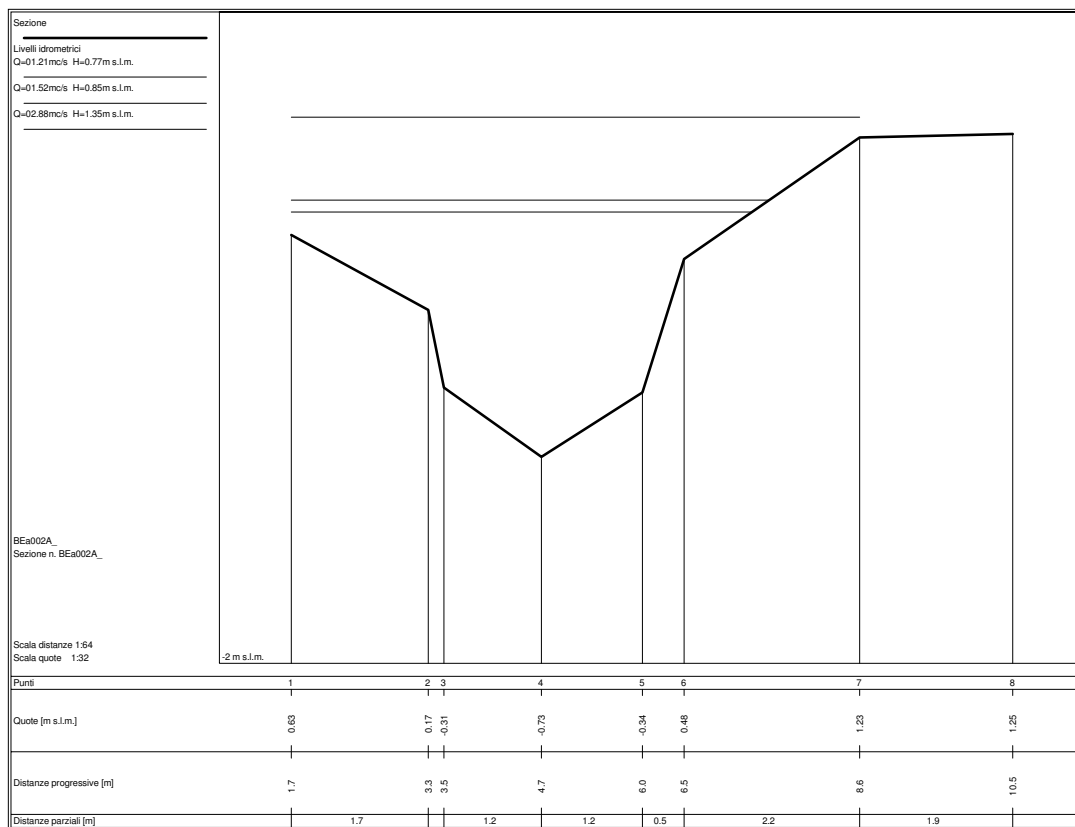
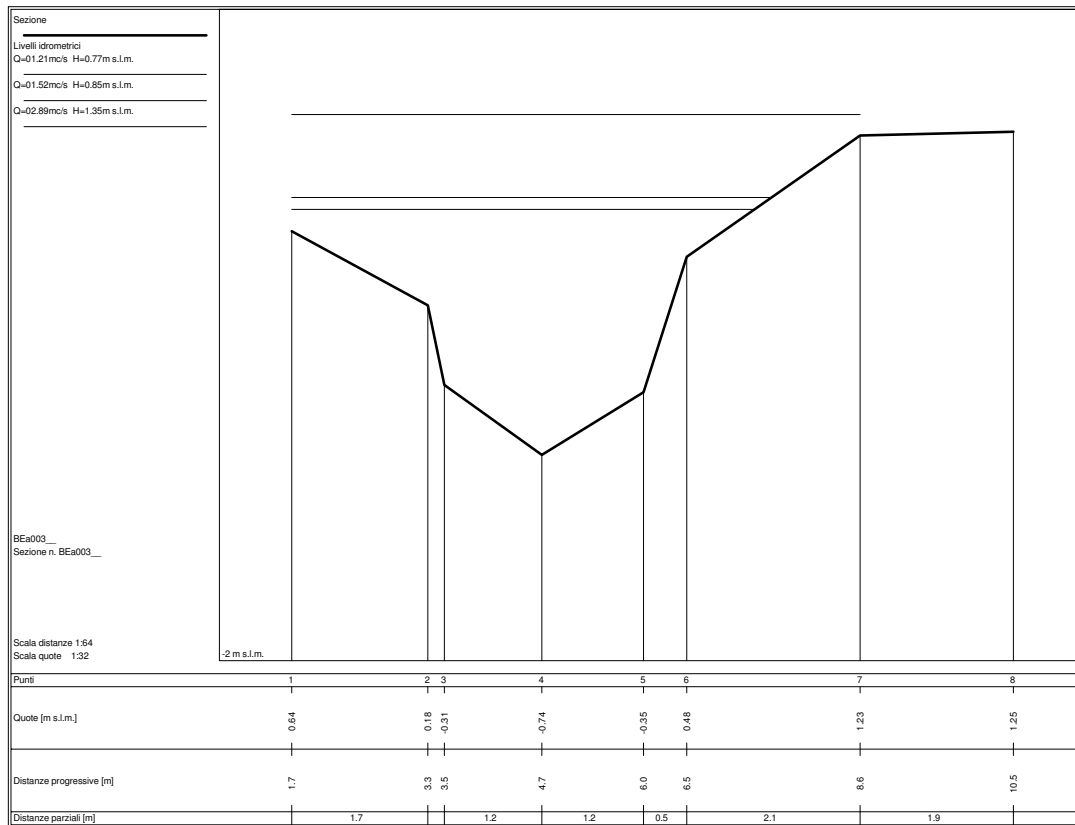

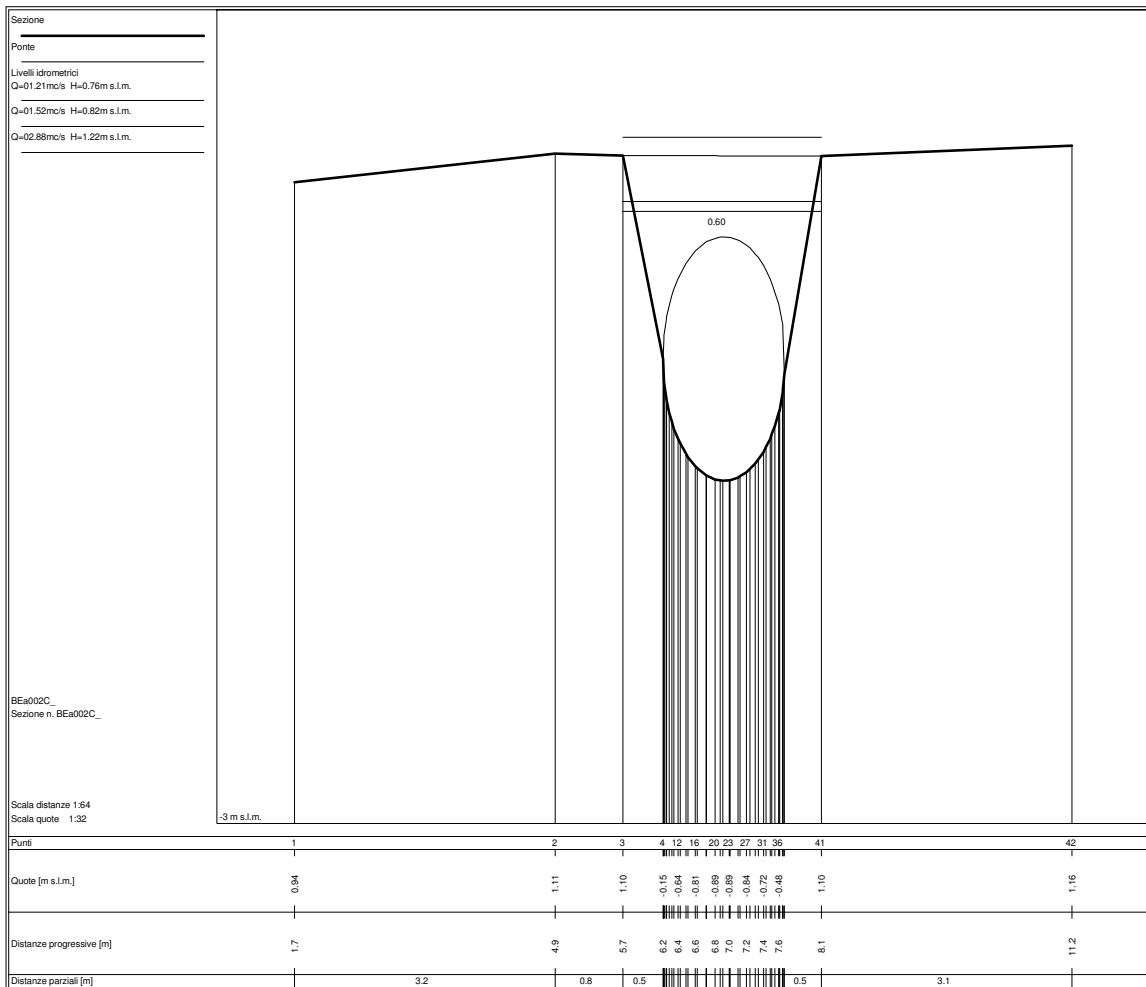
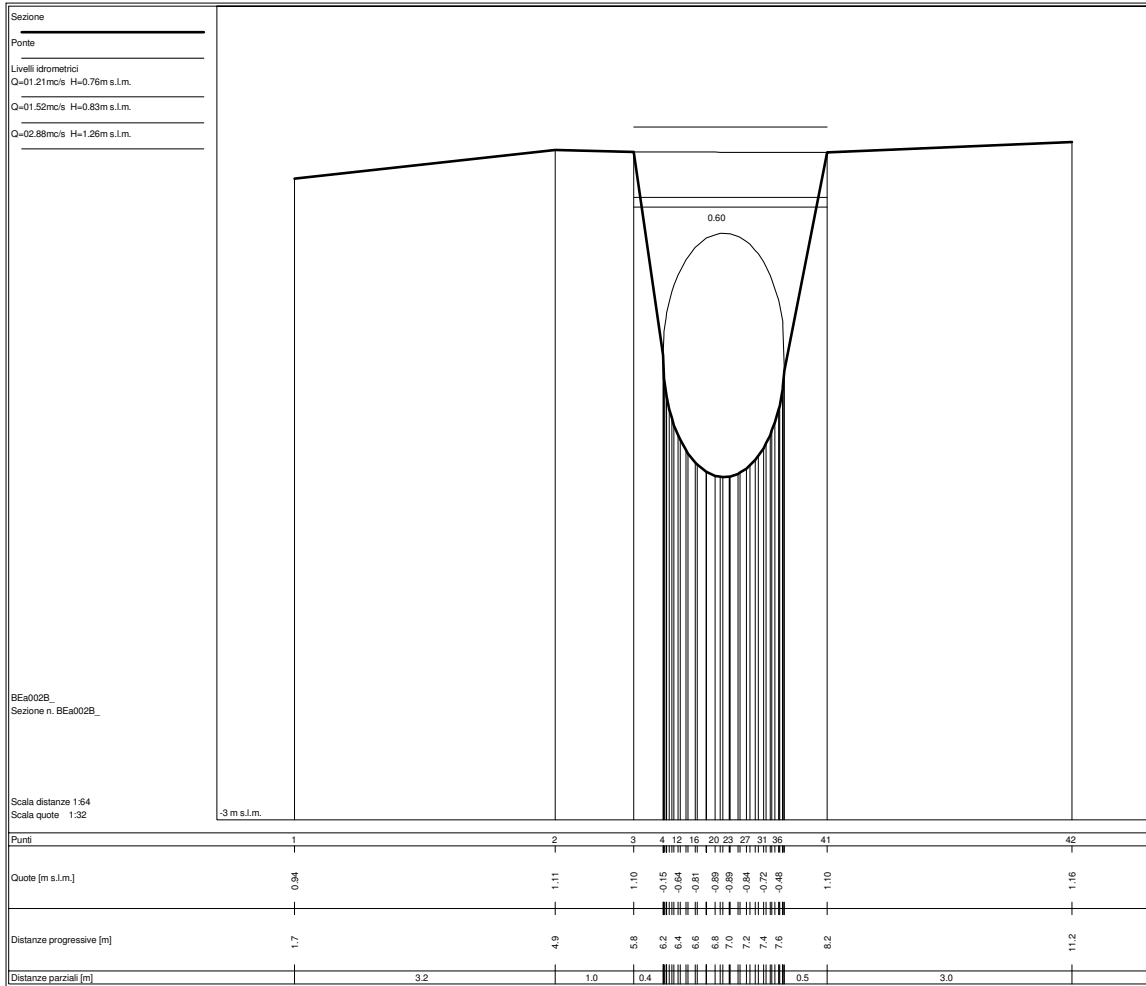

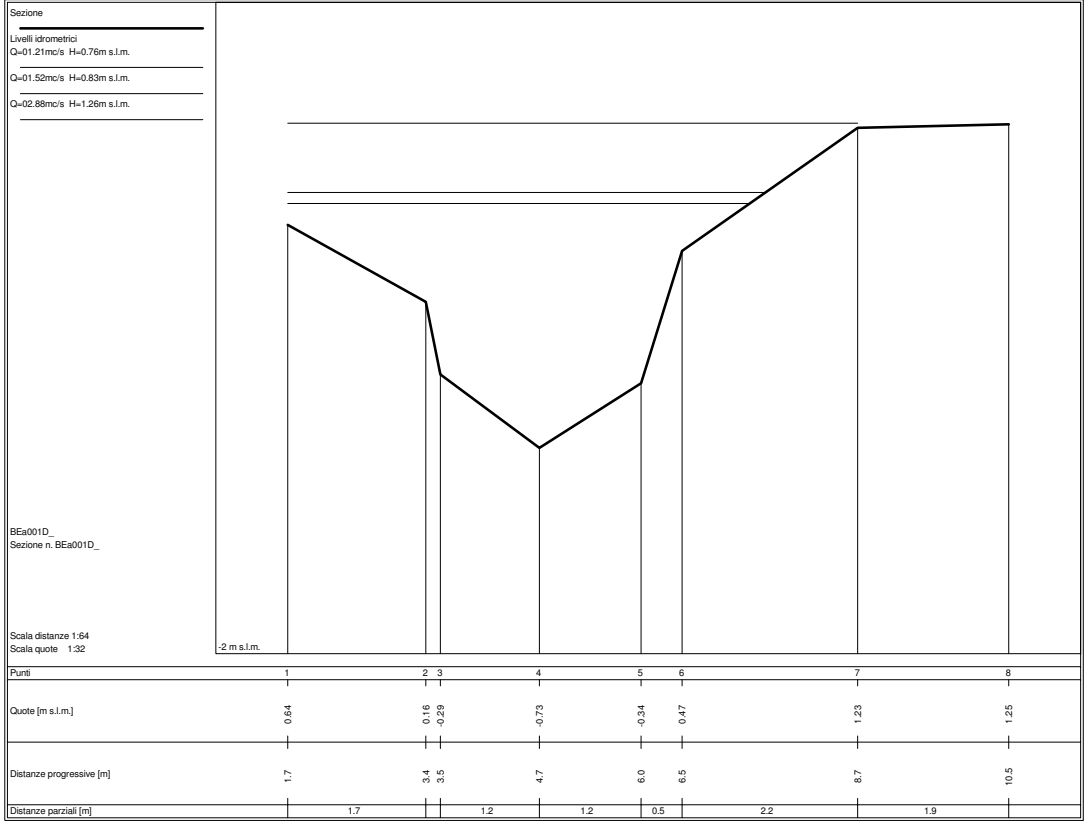

## **FOSSO DALMINE**

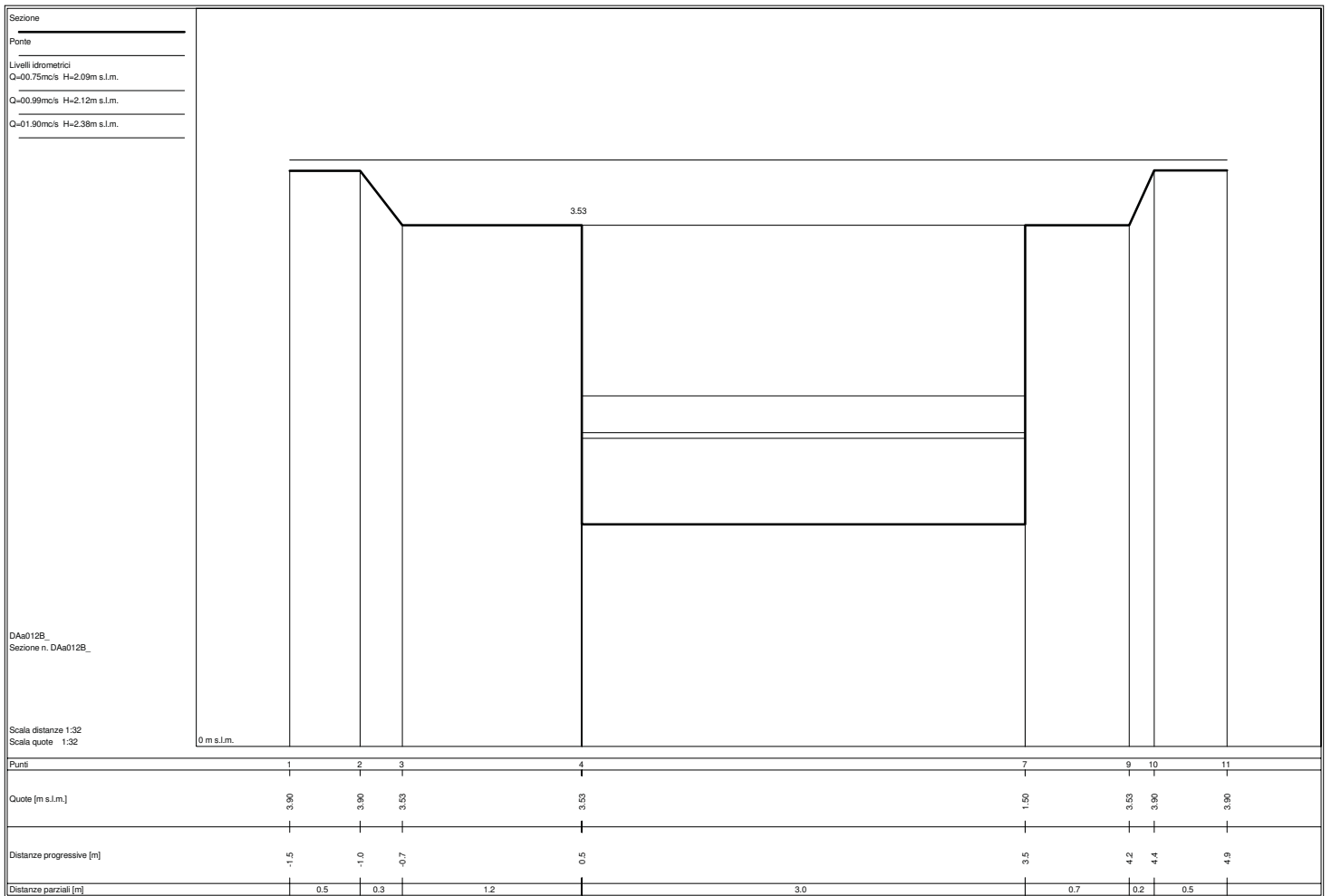
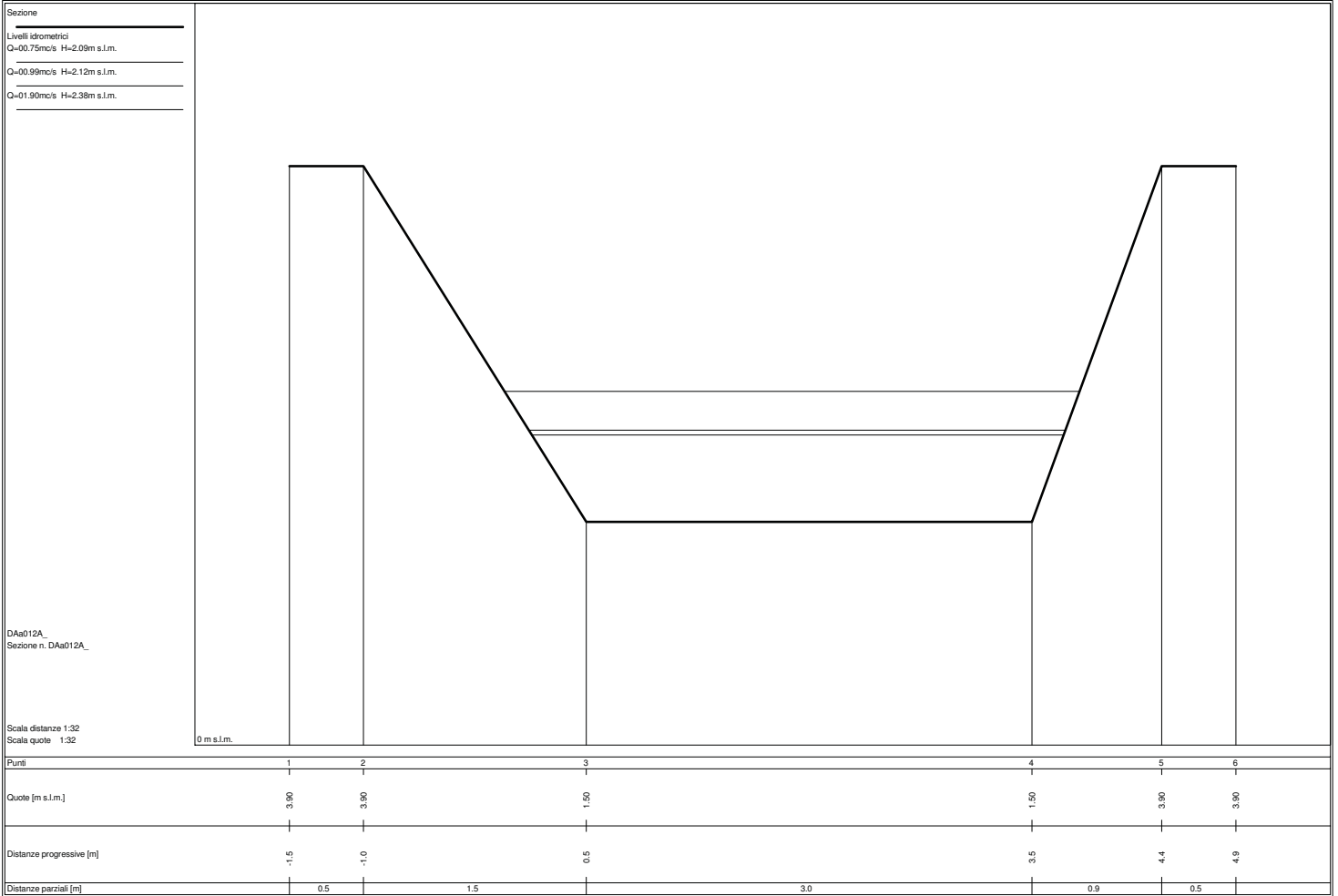

Sezione  
 Ponte  
 Livelli idrometrici  
 Q=00.80mc/s H=2.07m s.l.m.  
 Q=00.99mc/s H=2.10m s.l.m.  
 Q=01.93mc/s H=2.33m s.l.m.

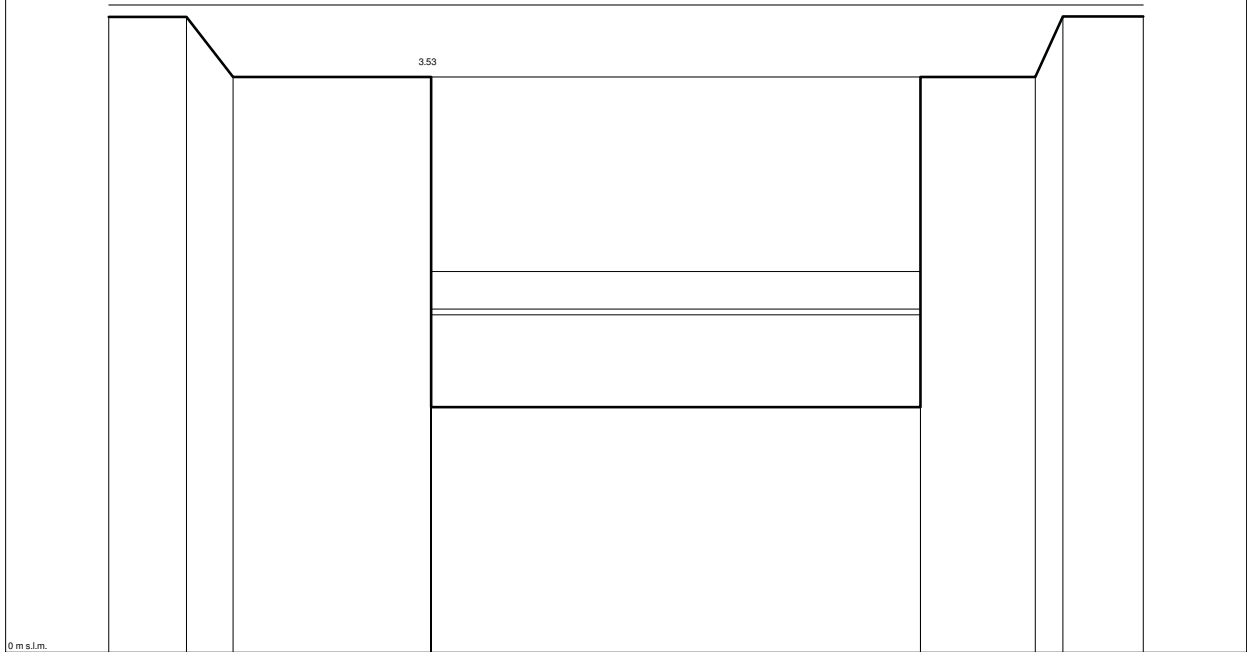

DAa012C  
 Sezione n. DAa012C\_

Scala distanze 1:32  
 Scala quote 1:32

|                          |      |      |      |      |      |      |      |      |
|--------------------------|------|------|------|------|------|------|------|------|
| Punti                    | 1    | 2    | 3    | 4    | 7    | 9    | 10   | 11   |
| Quote [m s.l.m.]         | 3.90 | 3.90 | 3.53 | 3.53 | 1.51 | 3.53 | 3.90 | 3.90 |
| Distanze progressive [m] | -1.5 | -1.0 | -0.7 | 0.5  | 3.5  | 4.2  | 4.4  | 4.9  |
| Distanze parziali [m]    |      | 0.5  | 0.3  | 1.2  | 3.0  | 0.7  | 0.2  | 0.5  |

Sezione  
 Livelli idrometrici  
 Q=00.81mc/s H=2.07m s.l.m.  
 Q=00.99mc/s H=2.11m s.l.m.  
 Q=01.93mc/s H=2.35m s.l.m.

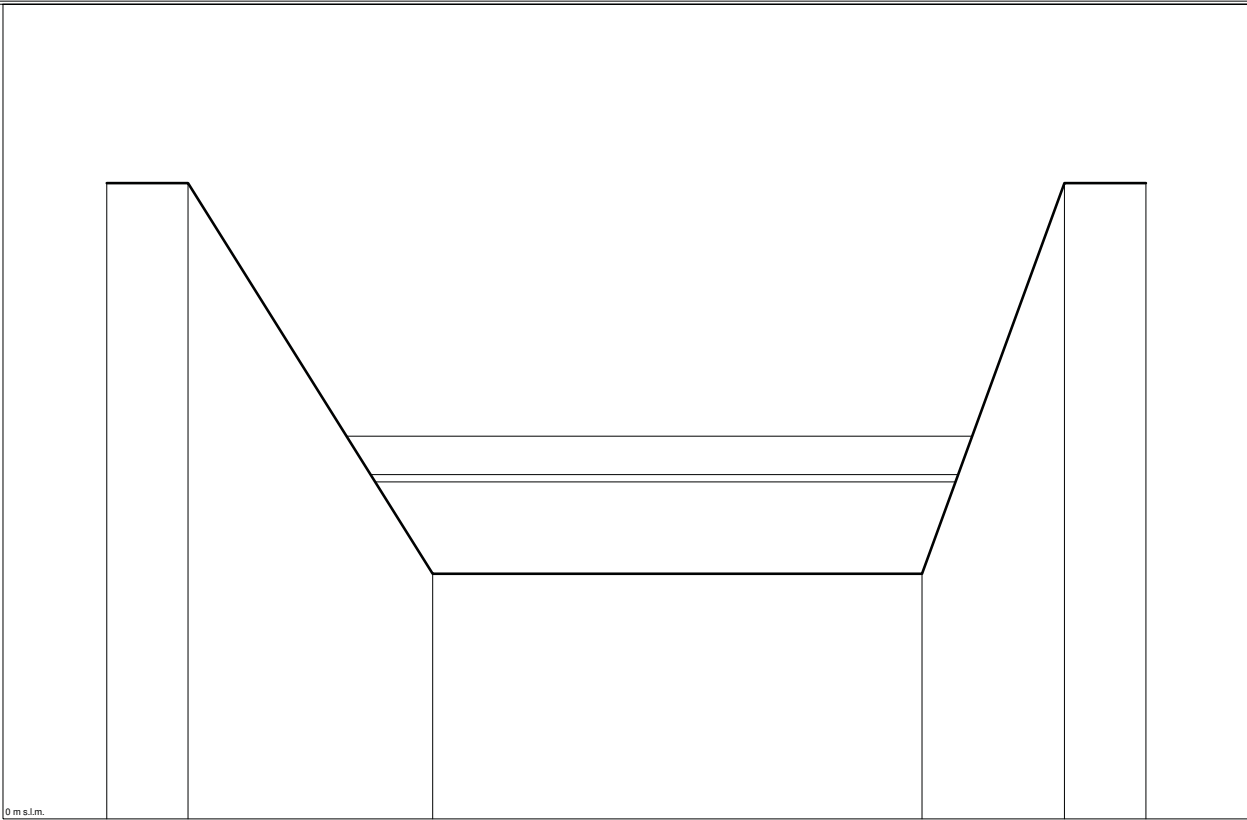

DAa012D  
 Sezione n. DAa012D\_

Scala distanze 1:32  
 Scala quote 1:32

|                          |      |      |      |      |      |      |
|--------------------------|------|------|------|------|------|------|
| Punti                    | 1    | 2    | 3    | 4    | 5    | 6    |
| Quote [m s.l.m.]         | 3.90 | 3.90 | 1.50 | 1.50 | 3.90 | 3.90 |
| Distanze progressive [m] | -1.5 | -1.0 | 0.5  | 3.5  | 4.4  | 4.9  |
| Distanze parziali [m]    |      | 0.5  | 1.5  | 3.0  | 0.9  | 0.5  |



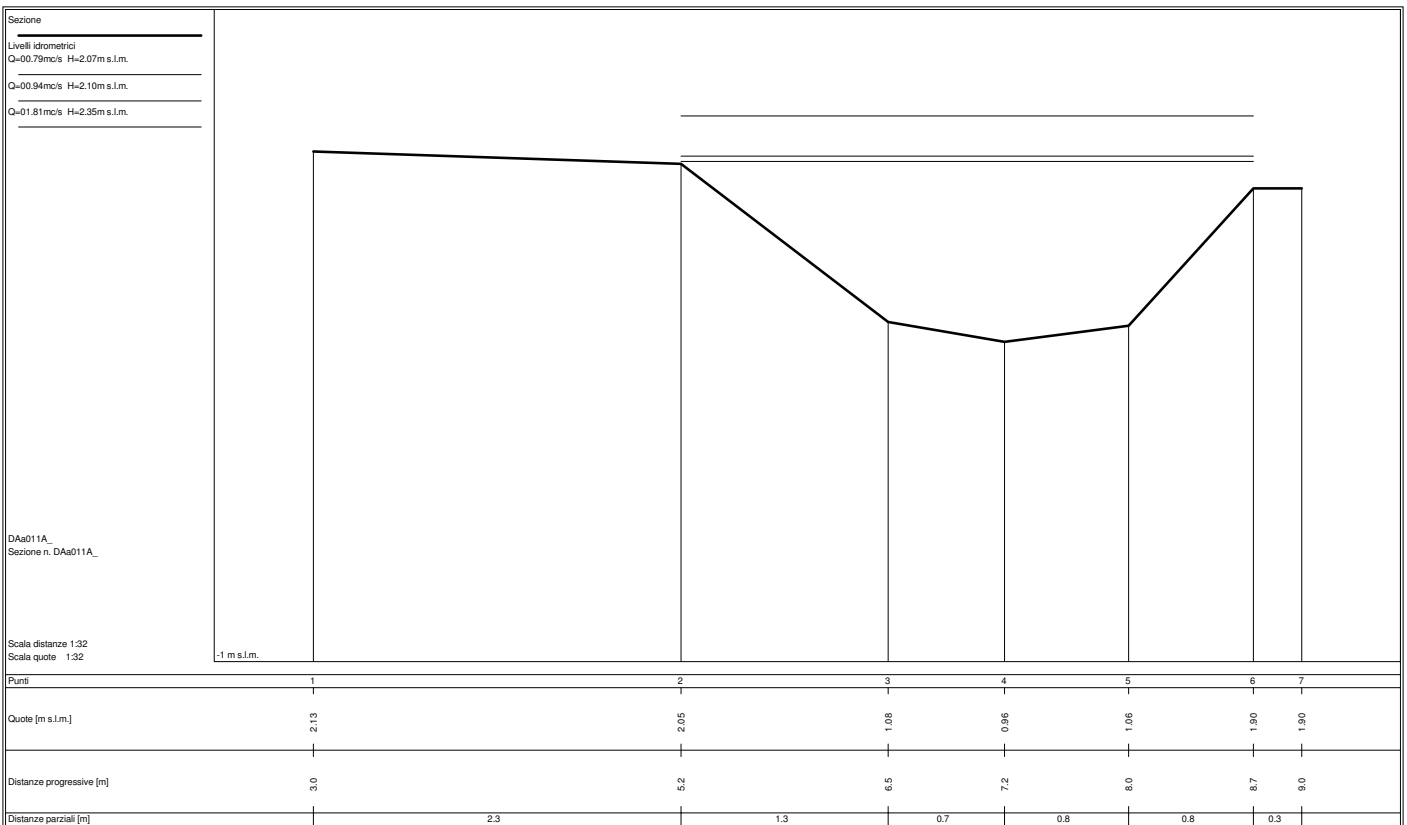
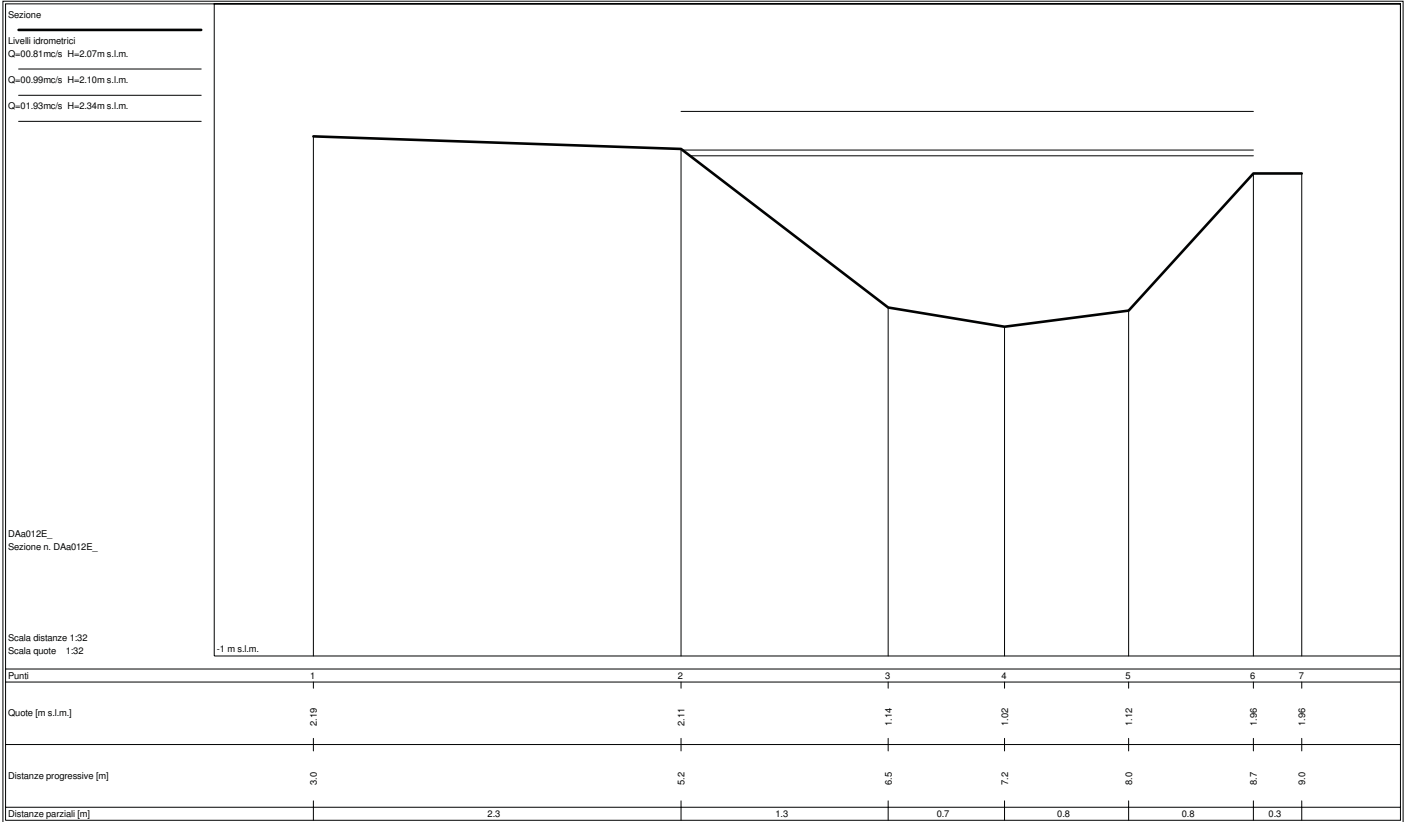

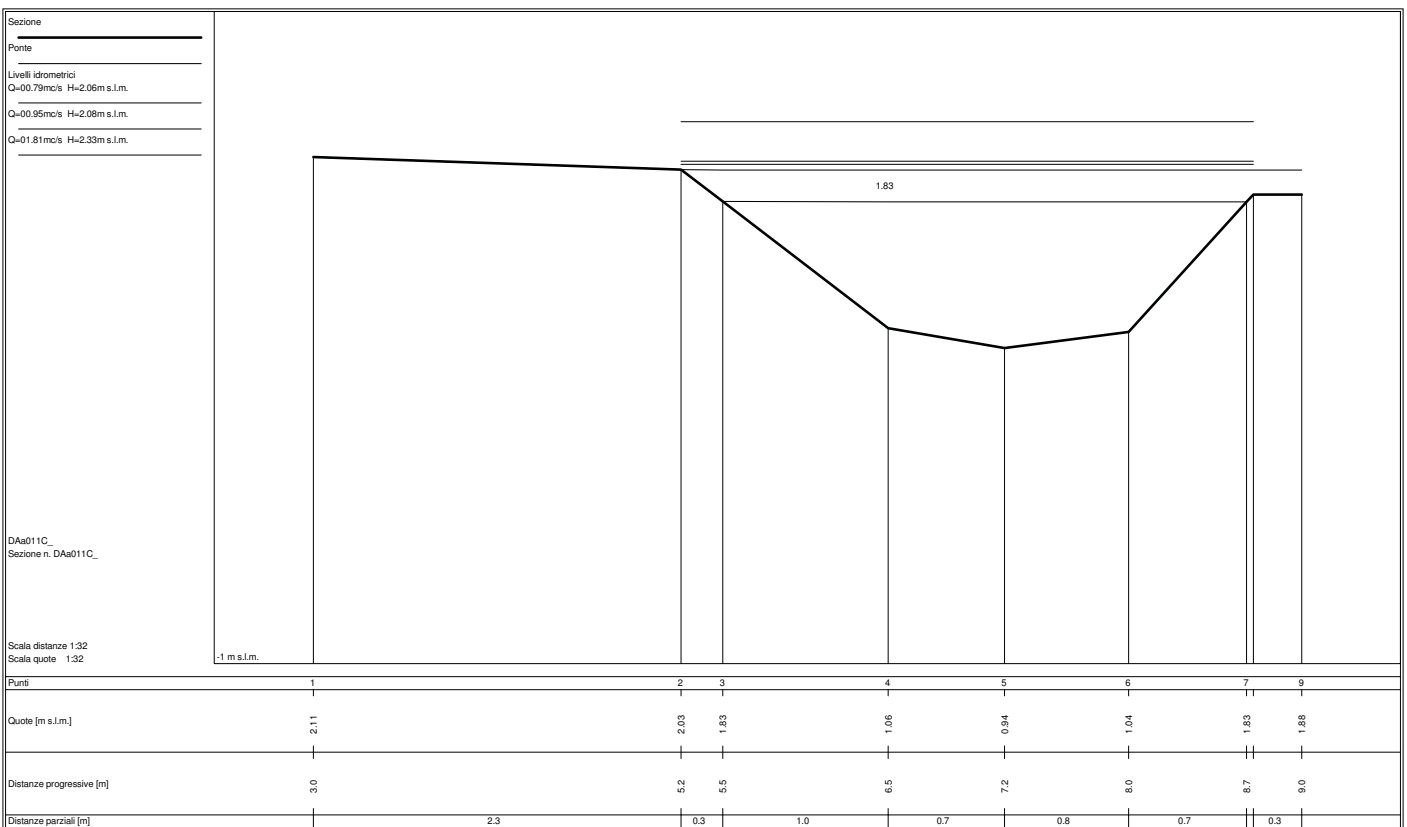
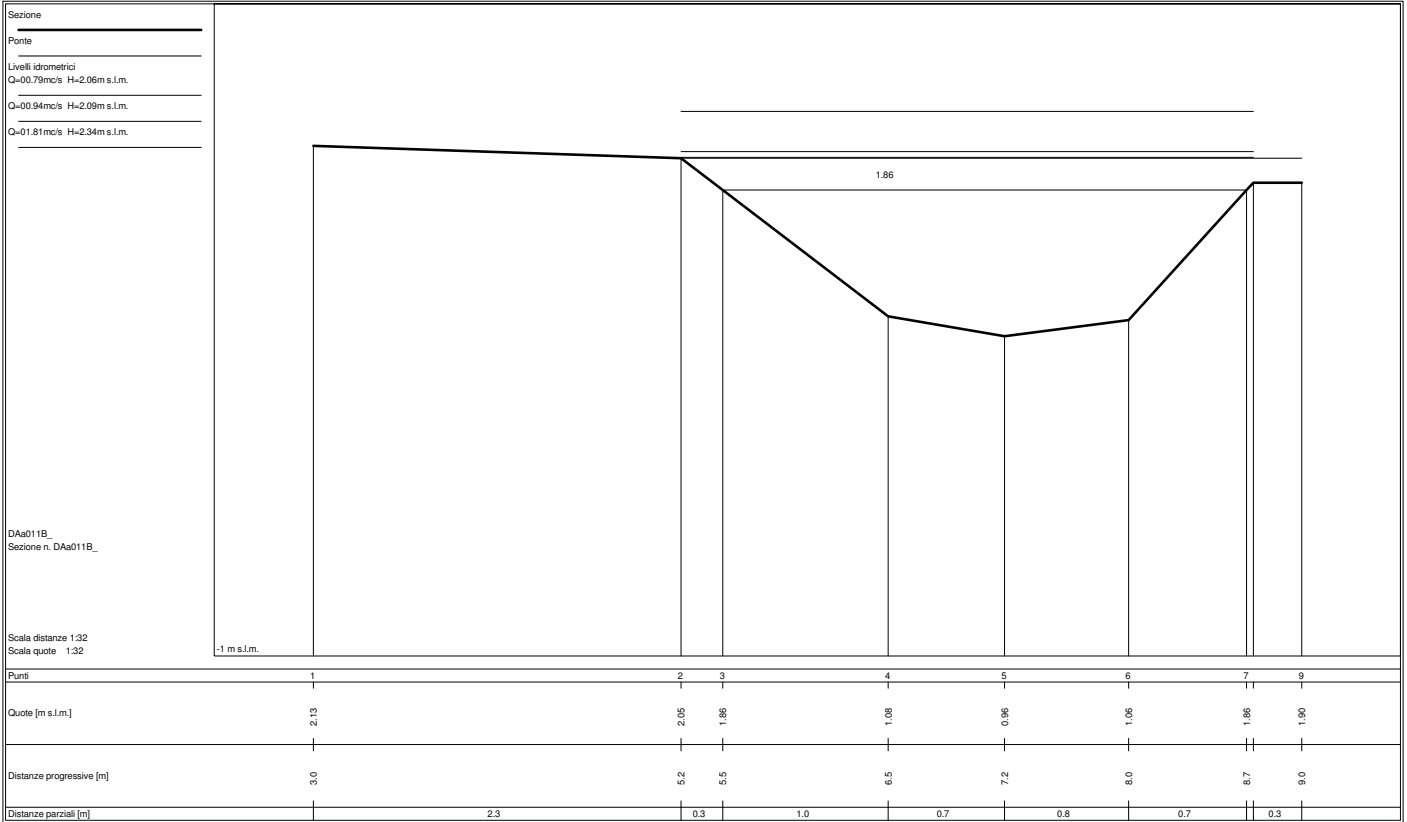

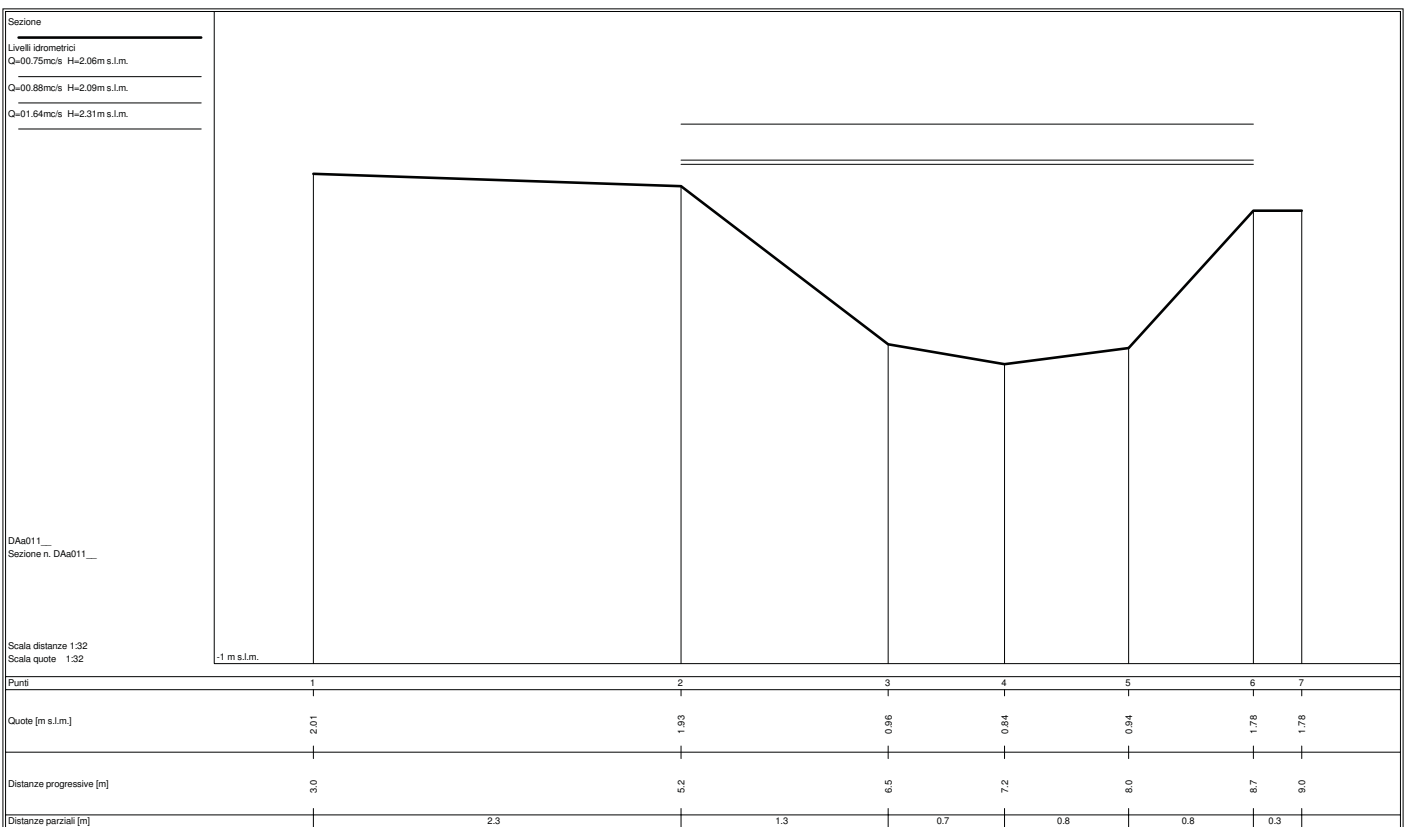
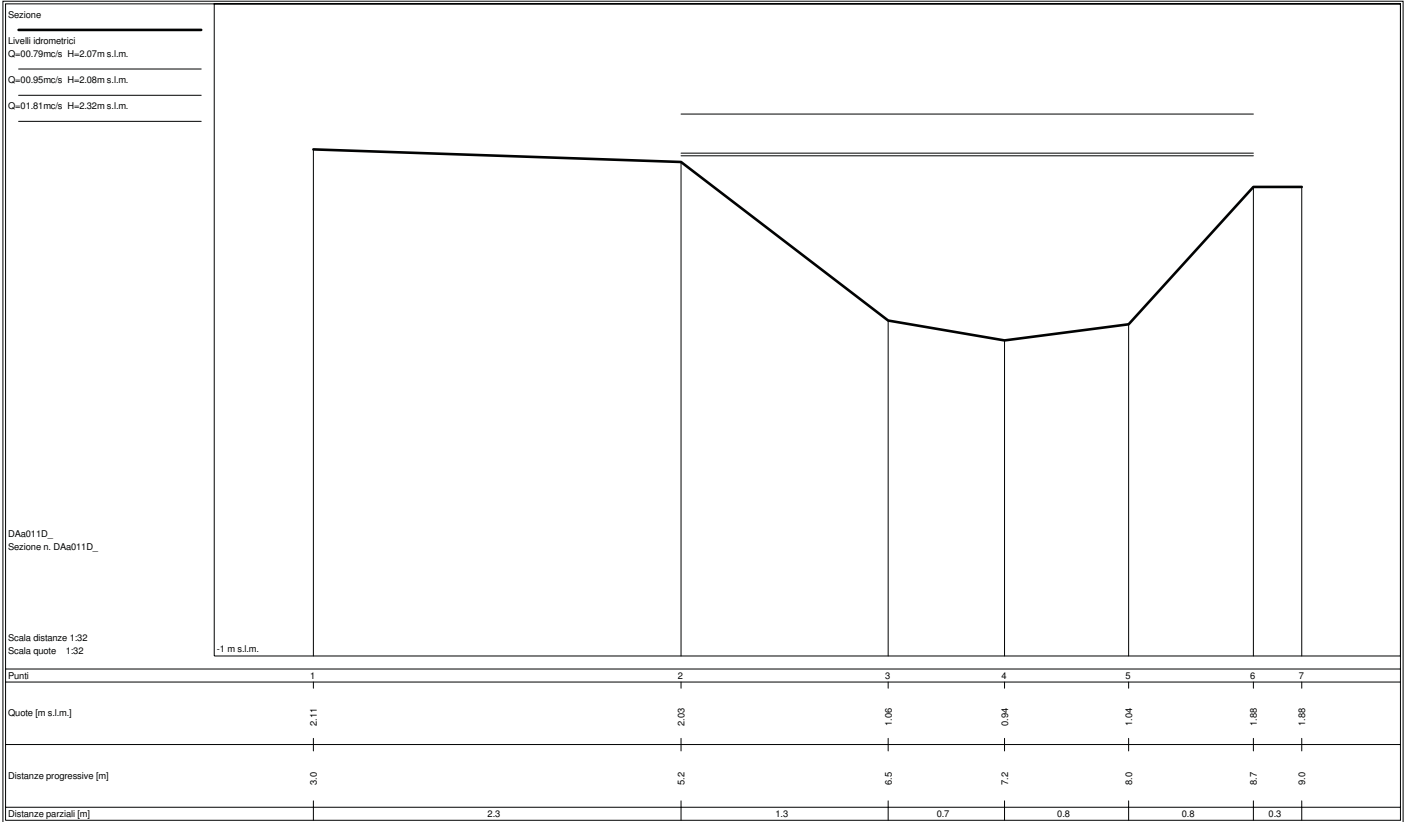

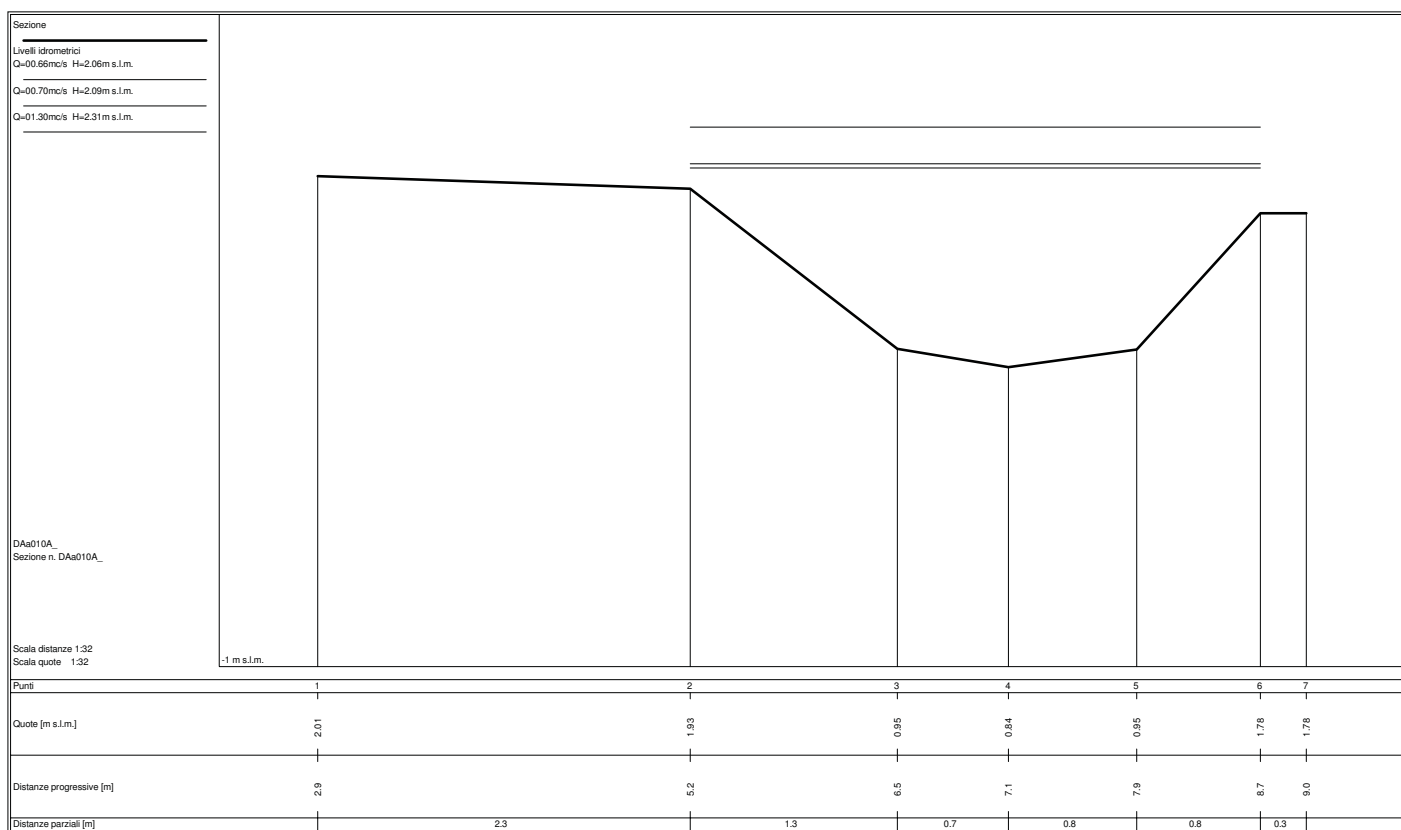
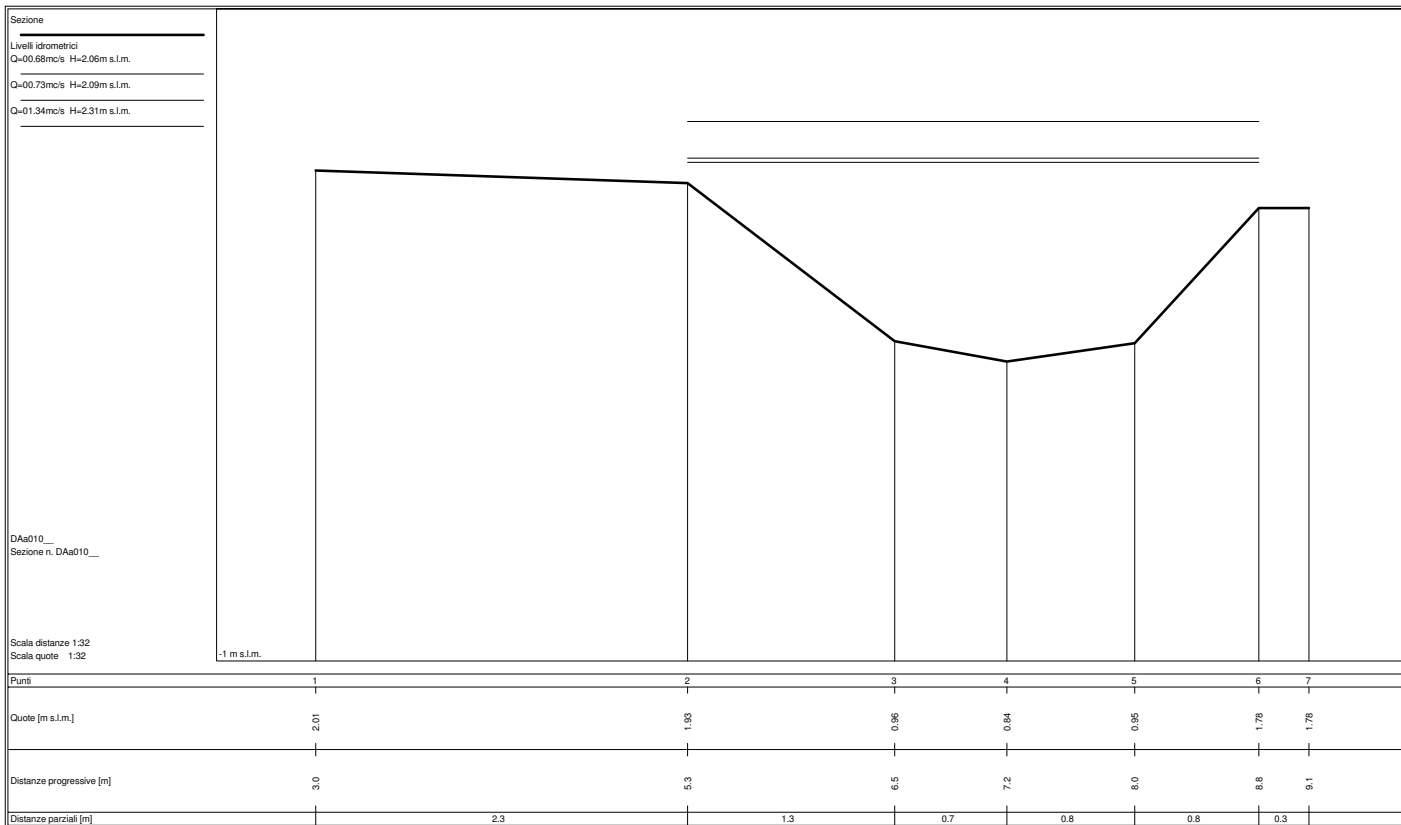

Sezione  
 Ponte  
 Livelli idrometrici  
 Q=00.66mc/s H=2.06m s.l.m.  
 Q=00.70mc/s H=2.08m s.l.m.  
 Q=01.30mc/s H=2.31m s.l.m.

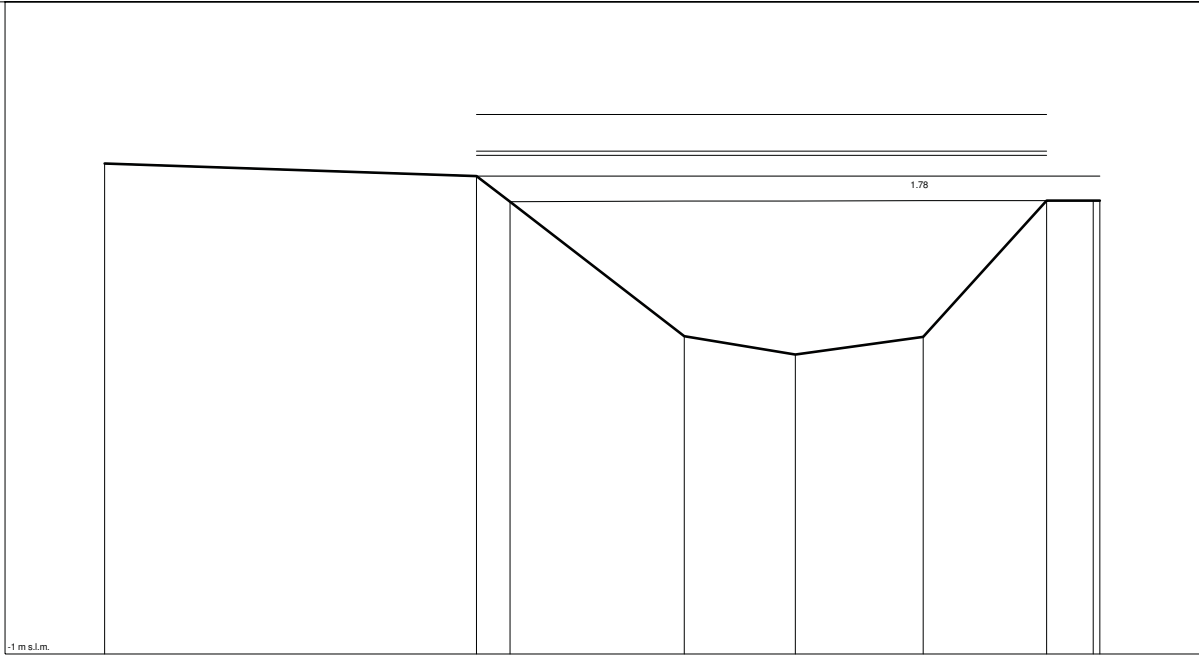

DAA010B\_  
 Sezione n. DAA010B\_

Scala distanze 1:32  
 Scala quote 1:32

|                          |      |      |      |      |      |      |      |      |
|--------------------------|------|------|------|------|------|------|------|------|
| Punti                    | 1    | 2    | 3    | 4    | 5    | 6    | 7    | 8    |
| Quote [m s.l.m.]         | 2.01 | 1.93 | 1.77 | 0.95 | 0.84 | 0.95 | 1.78 | 1.78 |
| Distanze progressive [m] | 2.9  | 5.2  | 5.4  | 6.5  | 7.1  | 7.9  | 8.7  | 9.0  |
| Distanze parziali [m]    |      | 2.3  | 0.2  | 1.1  | 0.7  | 0.8  | 0.8  | 0.3  |

Sezione  
 Ponte  
 Livelli idrometrici  
 Q=00.66mc/s H=2.06m s.l.m.  
 Q=00.70mc/s H=2.08m s.l.m.  
 Q=01.30mc/s H=2.31m s.l.m.

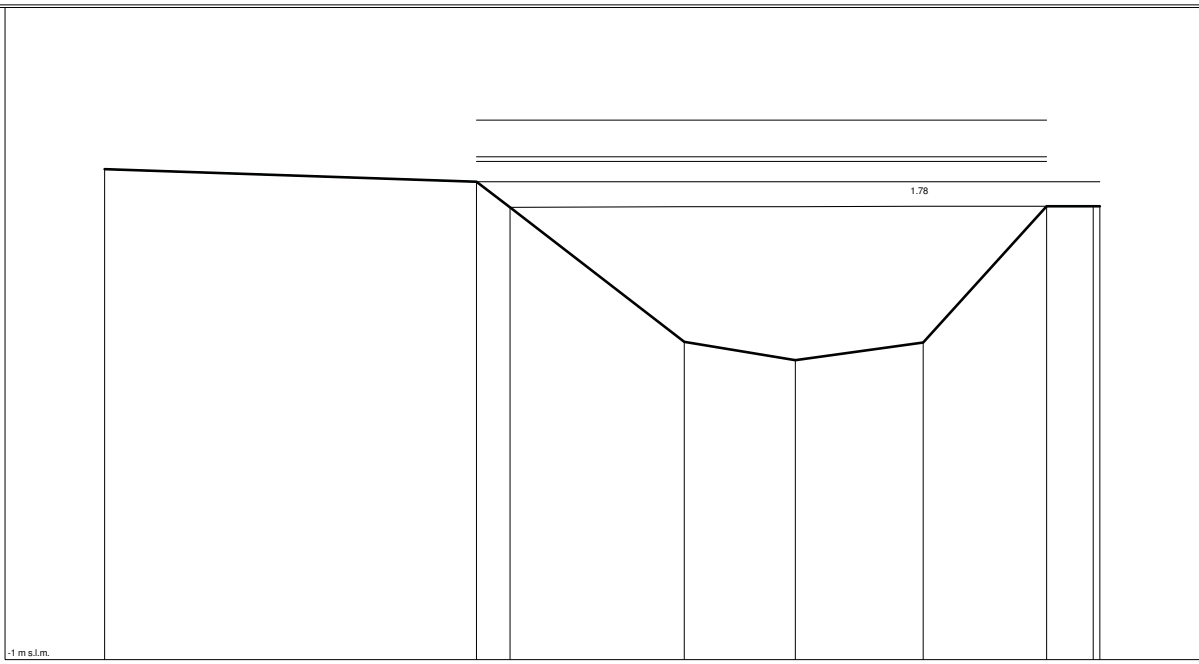

DAA010C\_  
 Sezione n. DAA010C\_

Scala distanze 1:32  
 Scala quote 1:32

|                          |      |      |      |      |      |      |      |      |
|--------------------------|------|------|------|------|------|------|------|------|
| Punti                    | 1    | 2    | 3    | 4    | 5    | 6    | 7    | 8    |
| Quote [m s.l.m.]         | 2.01 | 1.93 | 1.77 | 0.95 | 0.84 | 0.95 | 1.78 | 1.78 |
| Distanze progressive [m] | 2.9  | 5.2  | 5.4  | 6.5  | 7.1  | 7.9  | 8.7  | 9.0  |
| Distanze parziali [m]    |      | 2.3  | 0.2  | 1.1  | 0.7  | 0.8  | 0.8  | 0.3  |

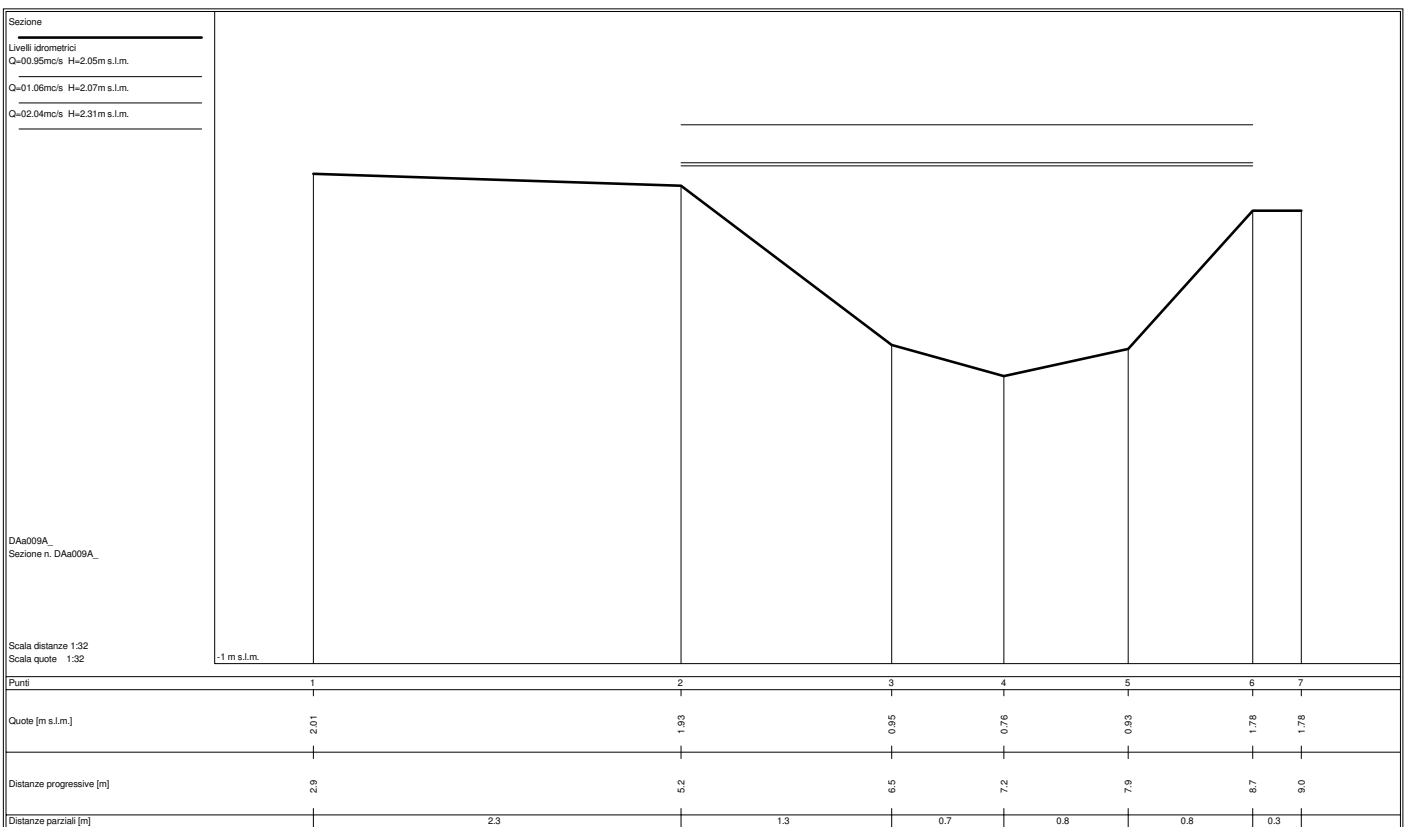
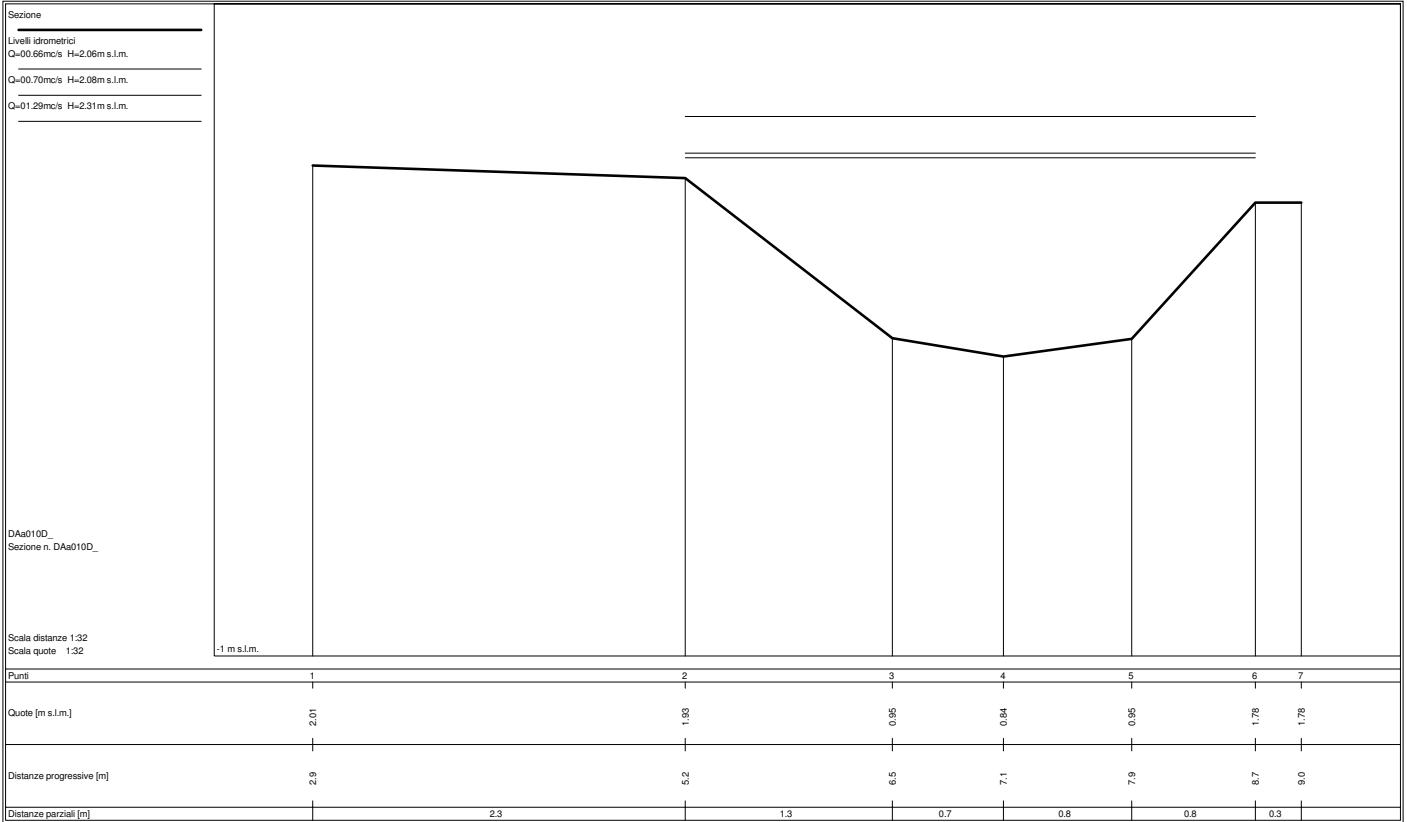

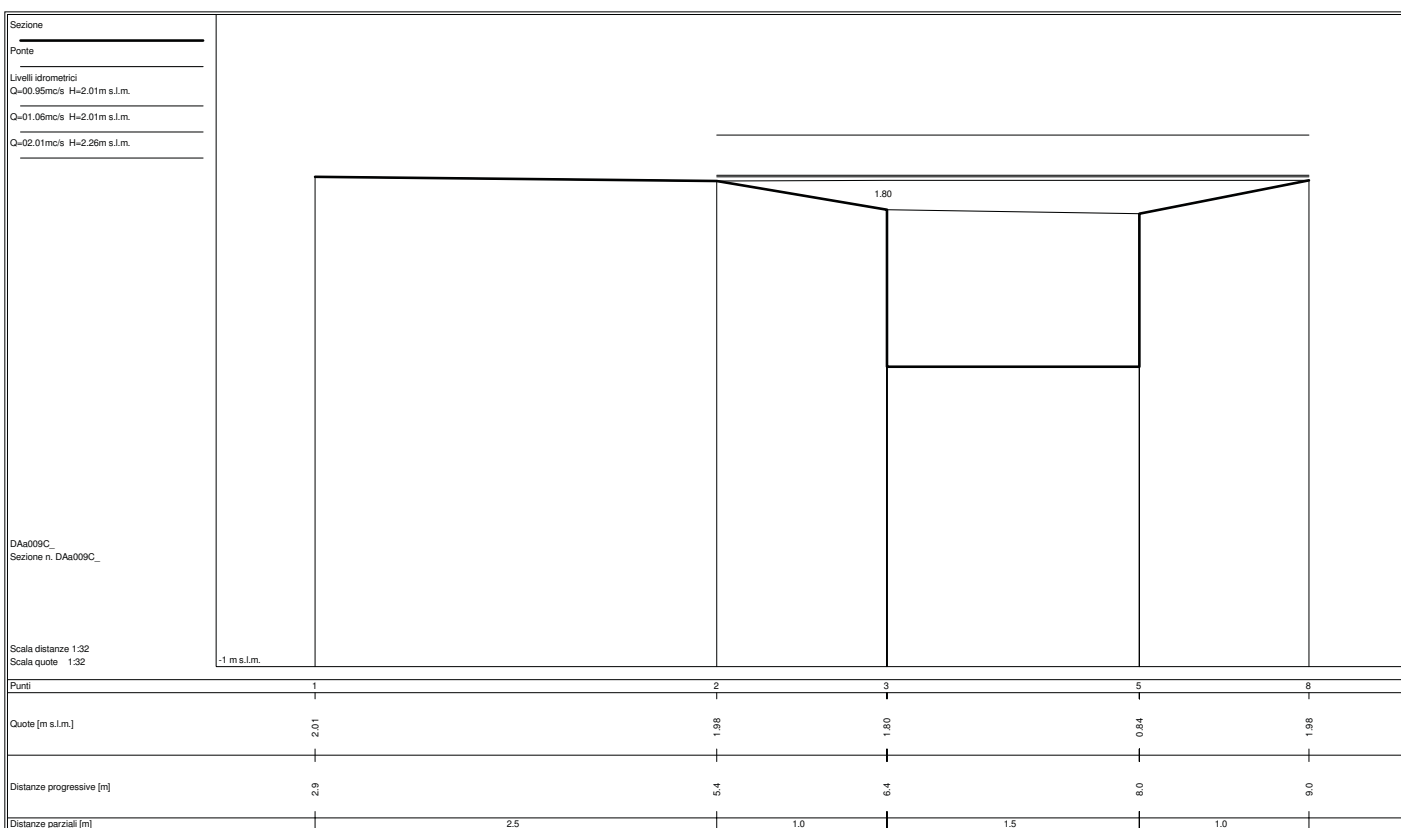
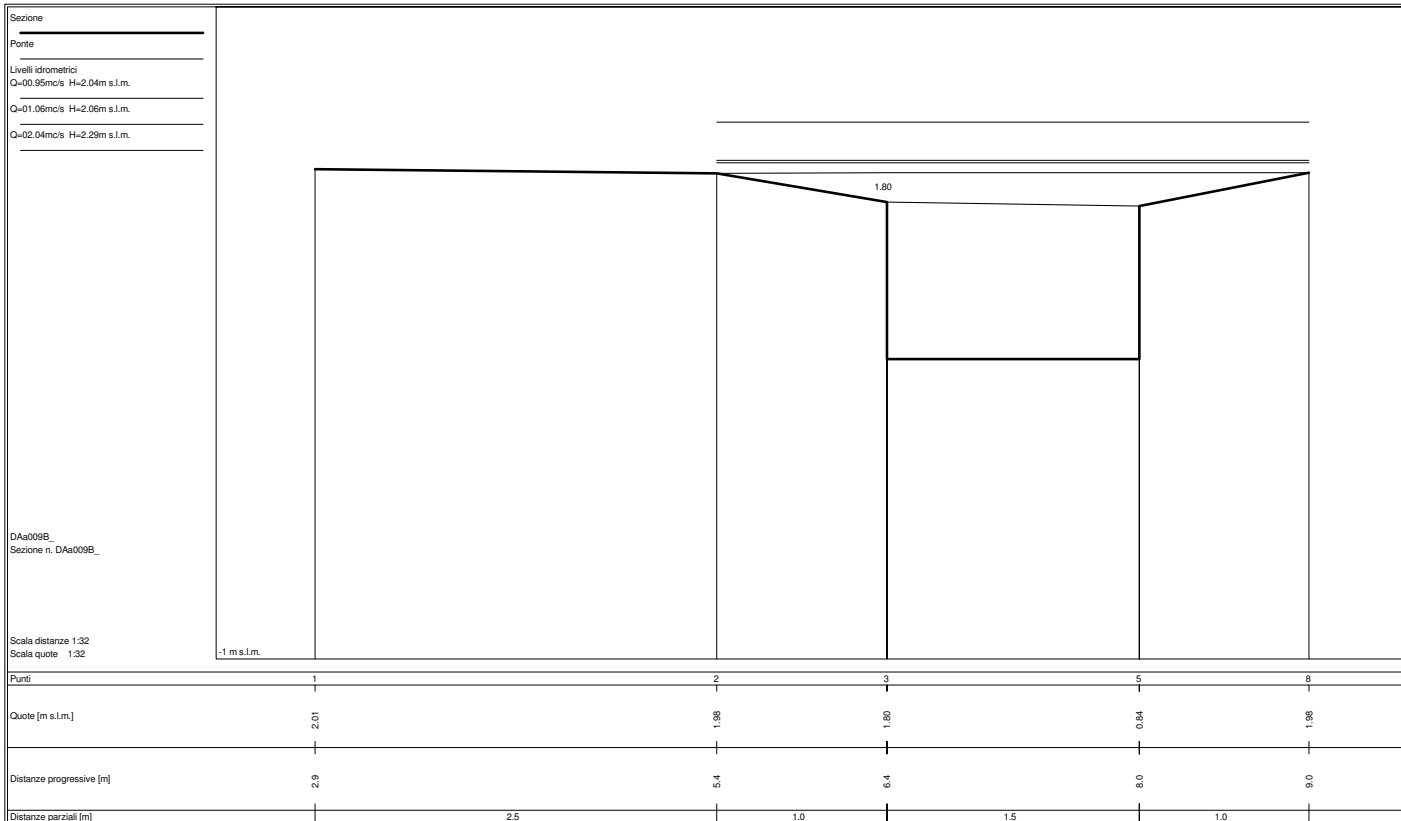

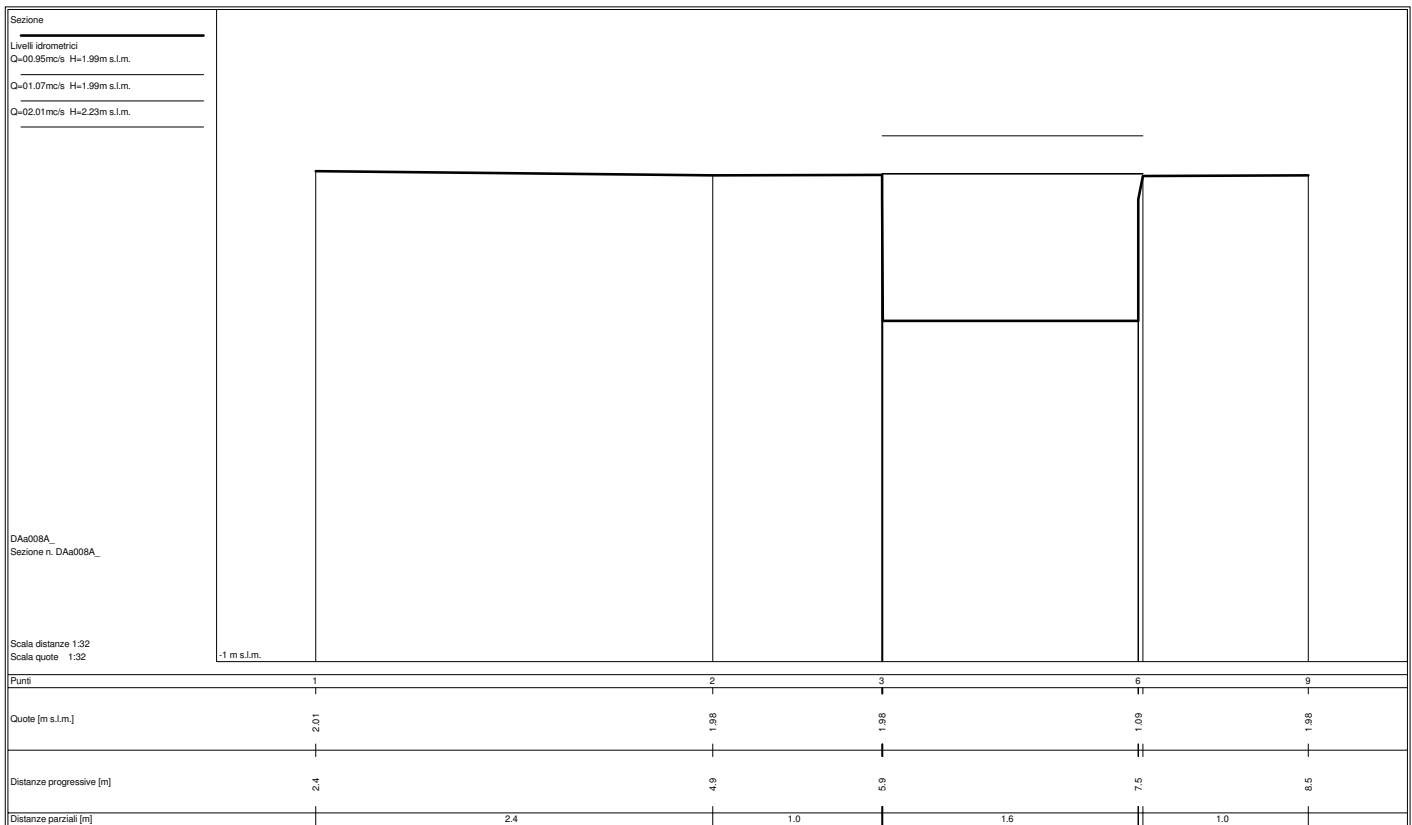
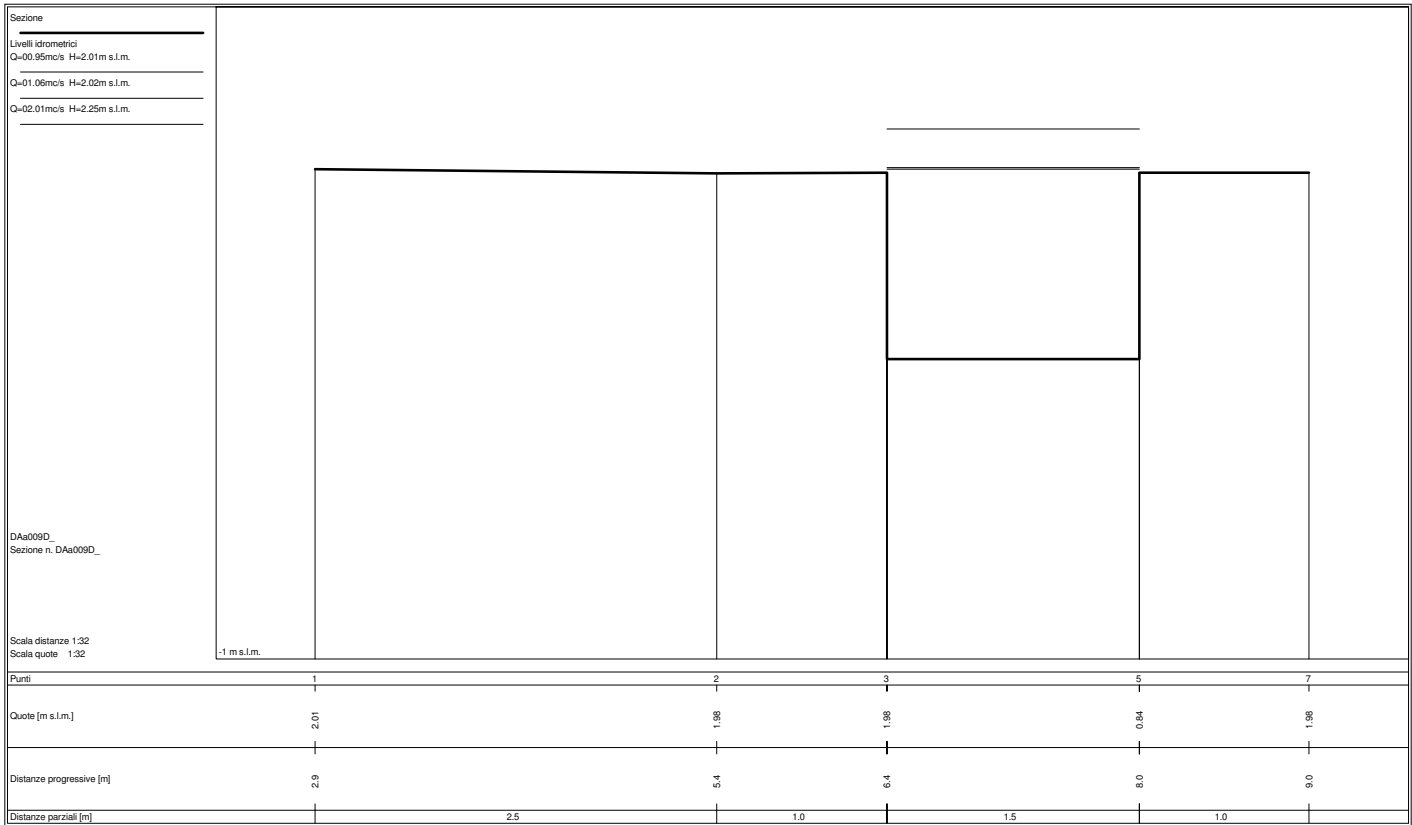



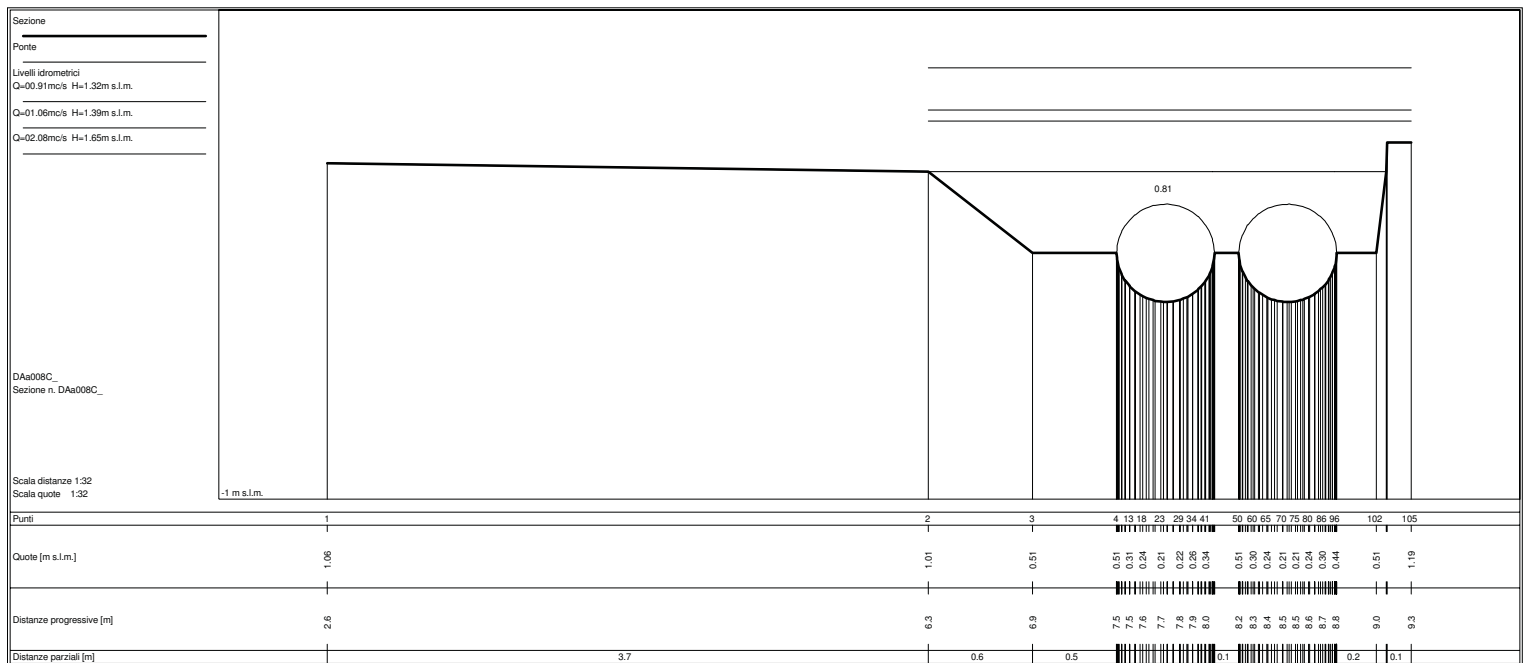
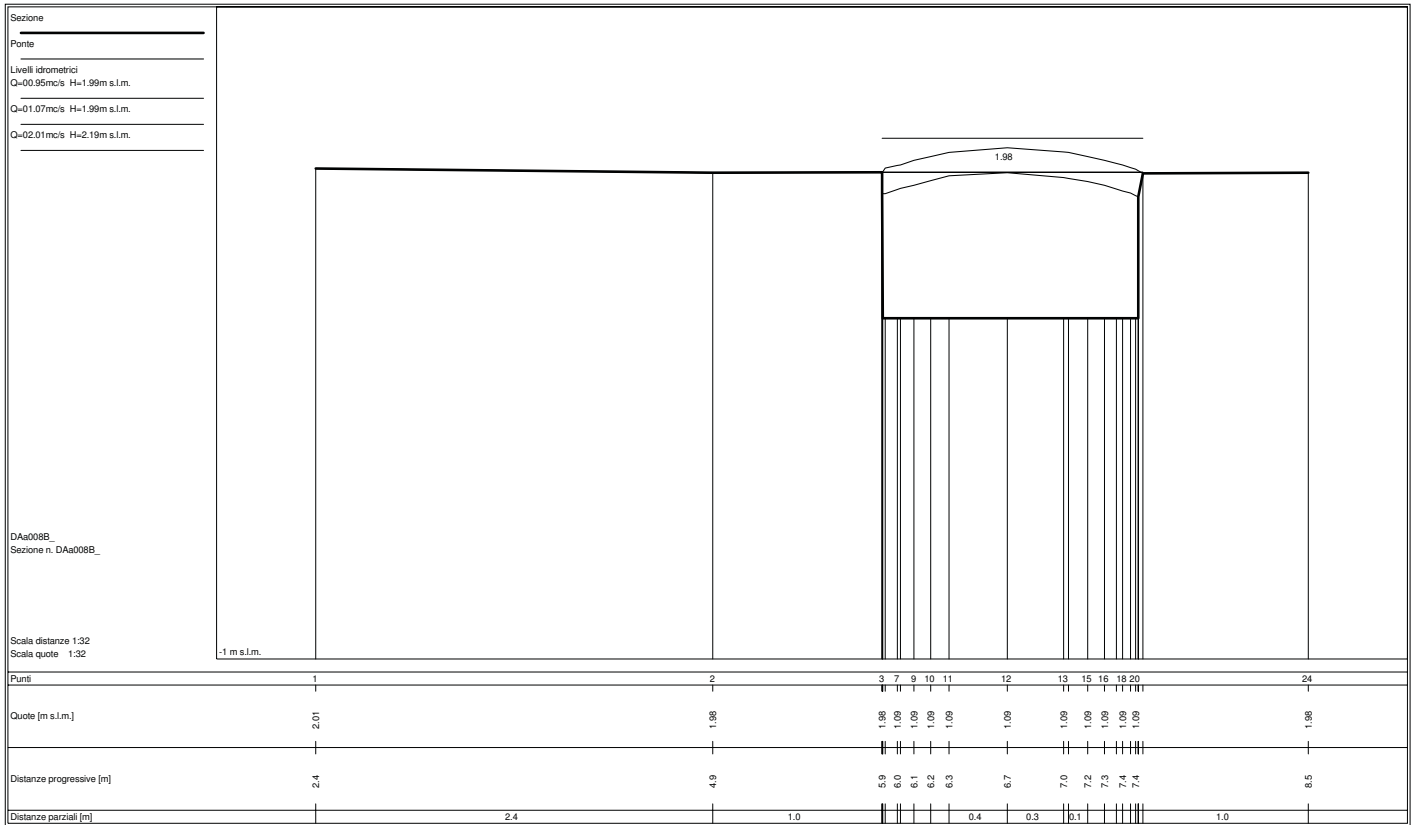

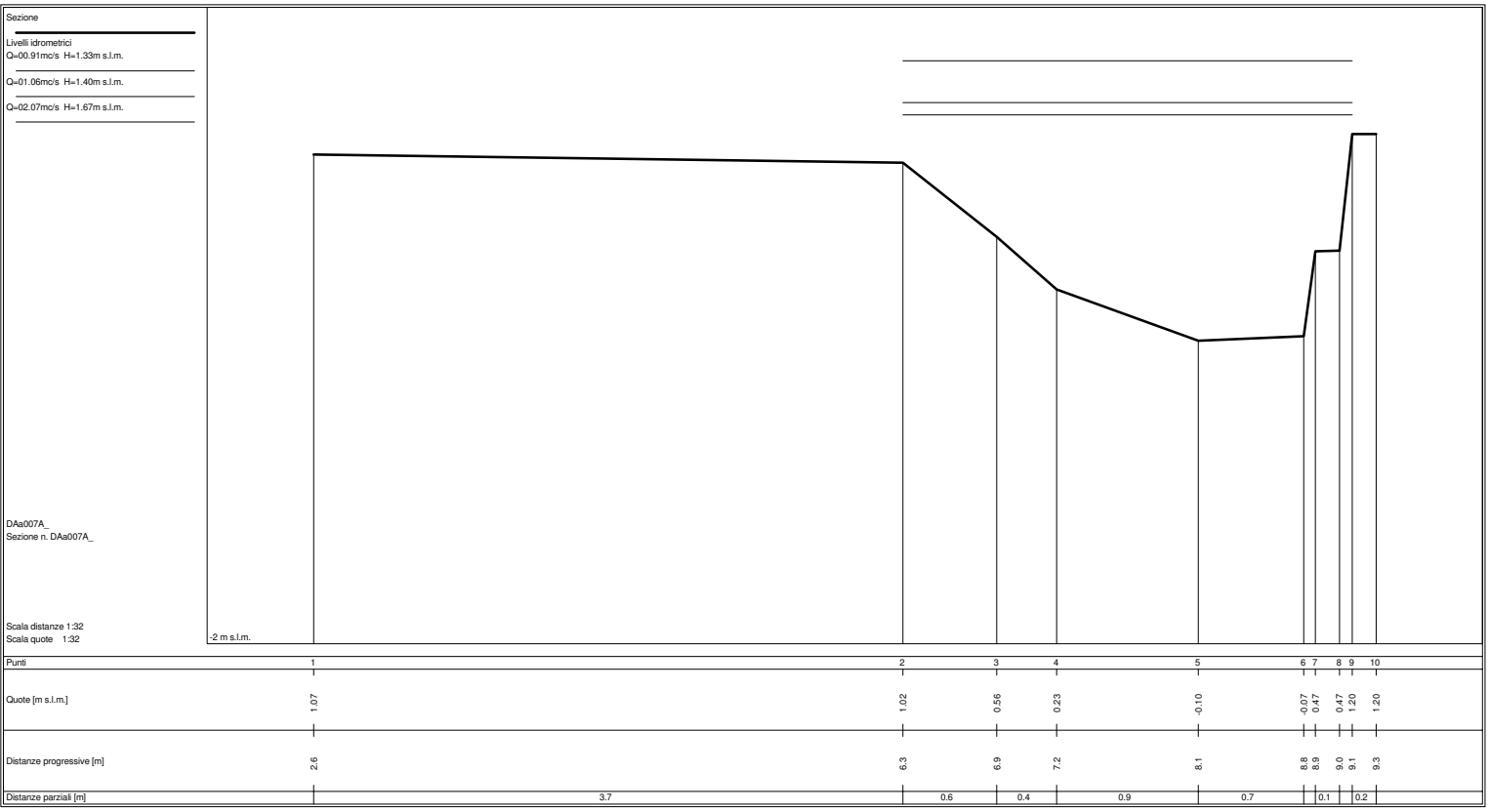
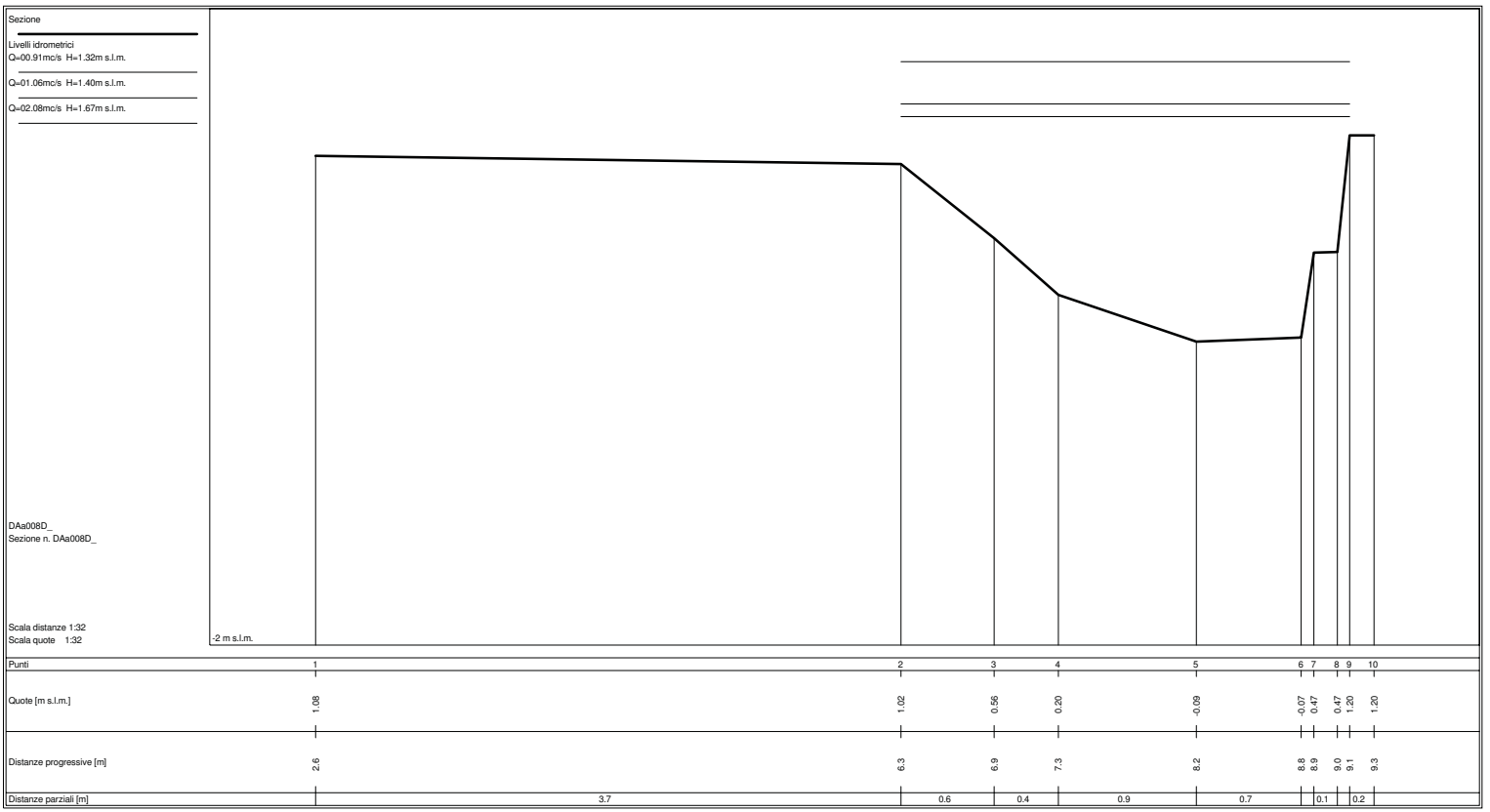

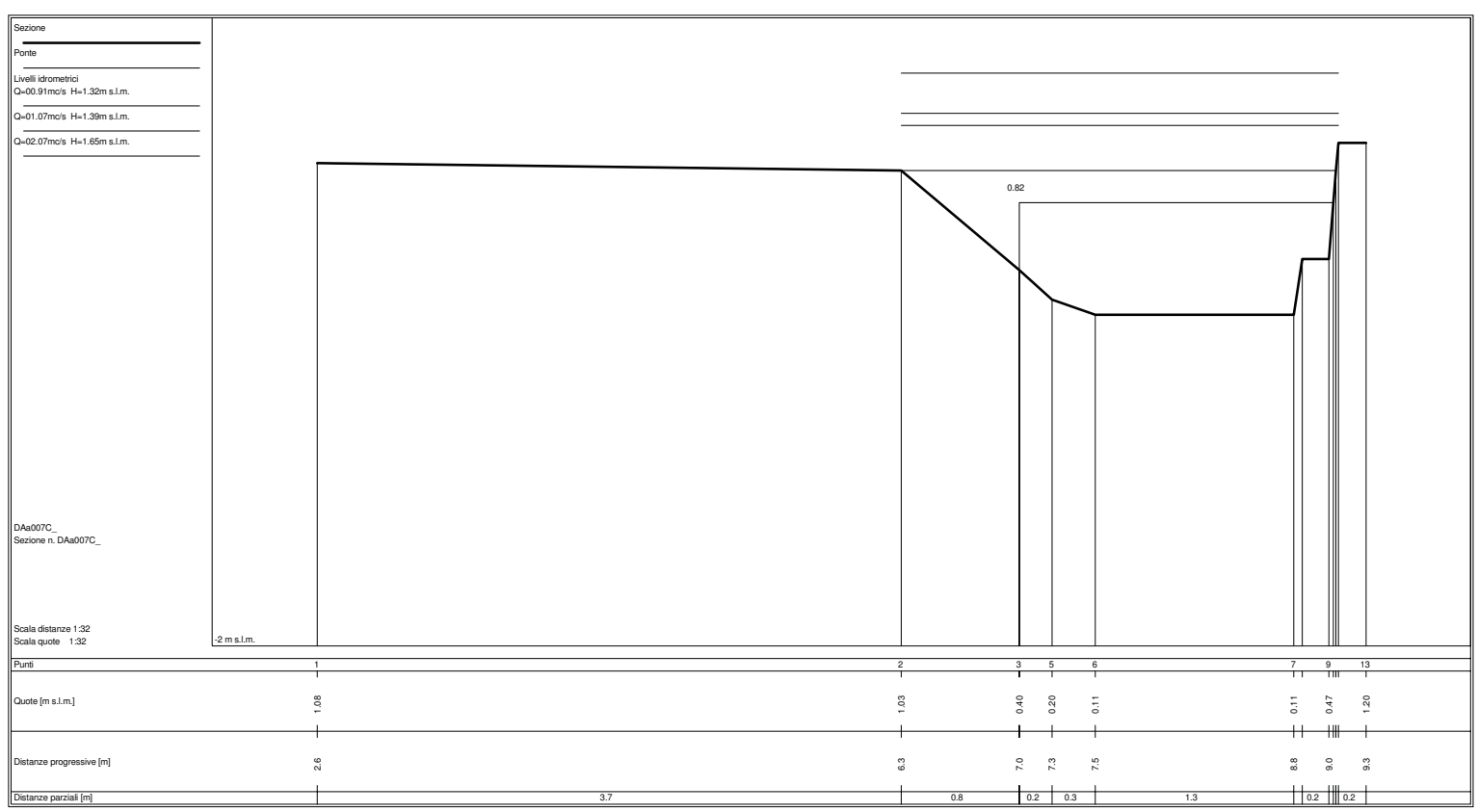
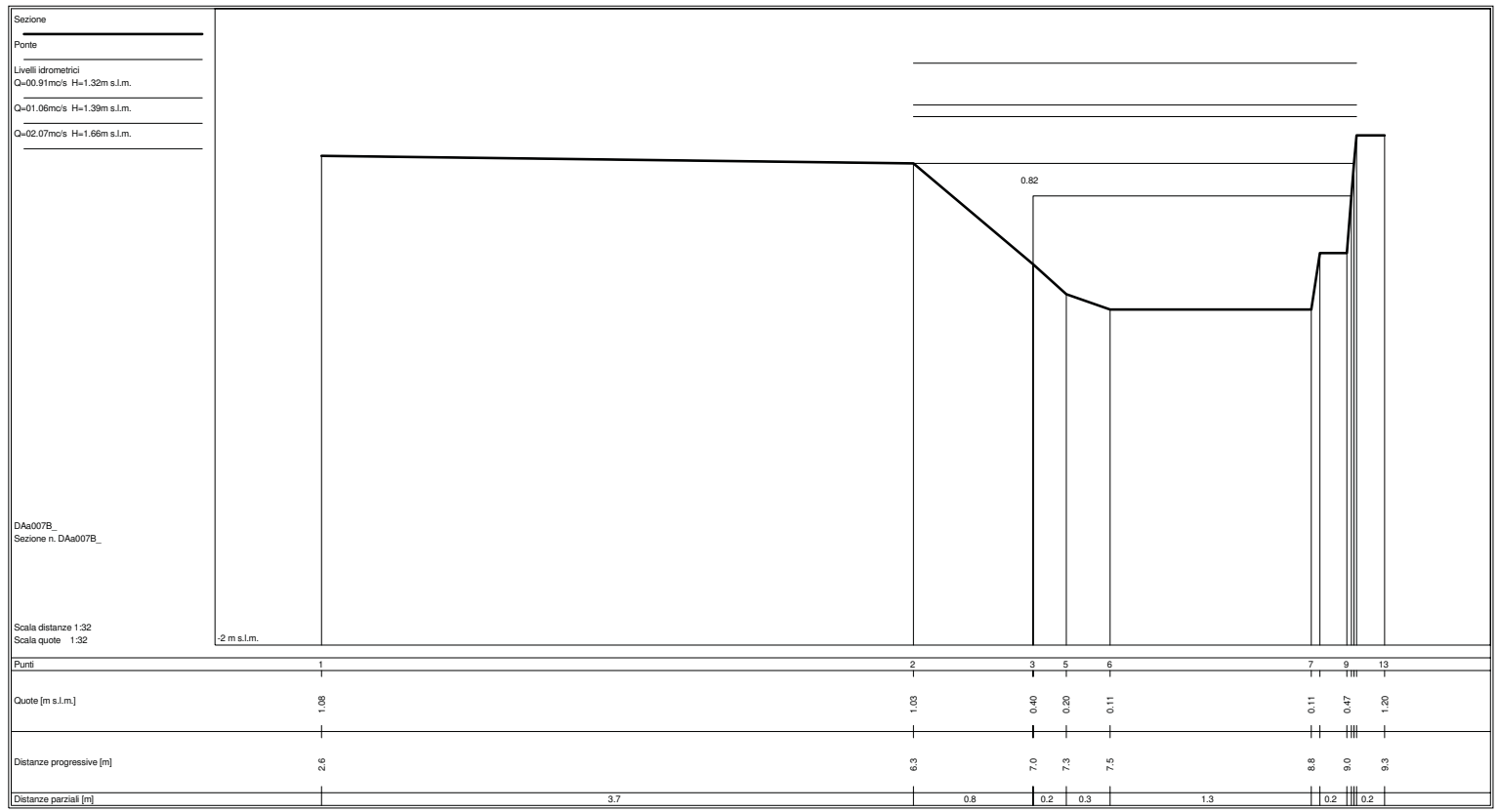

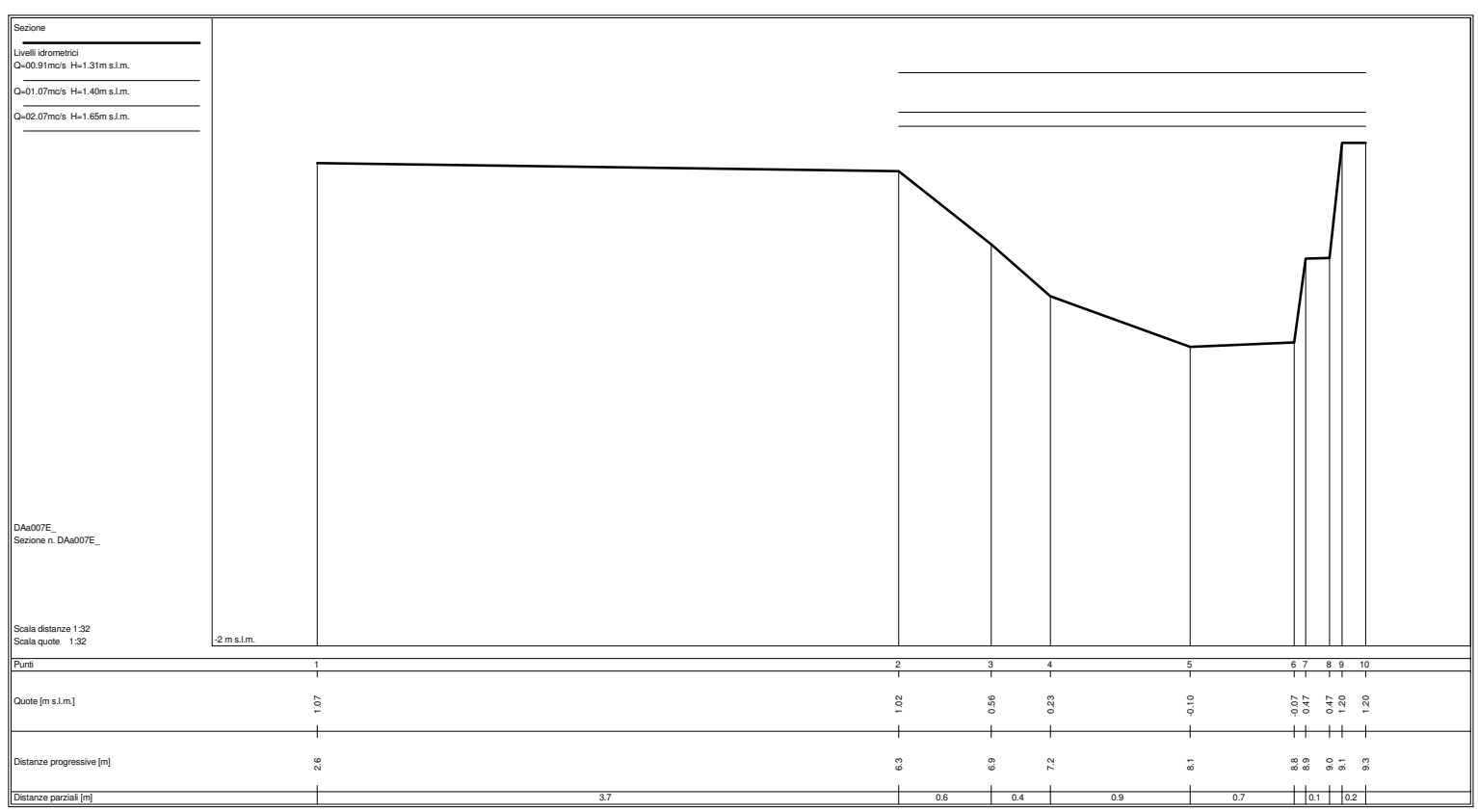
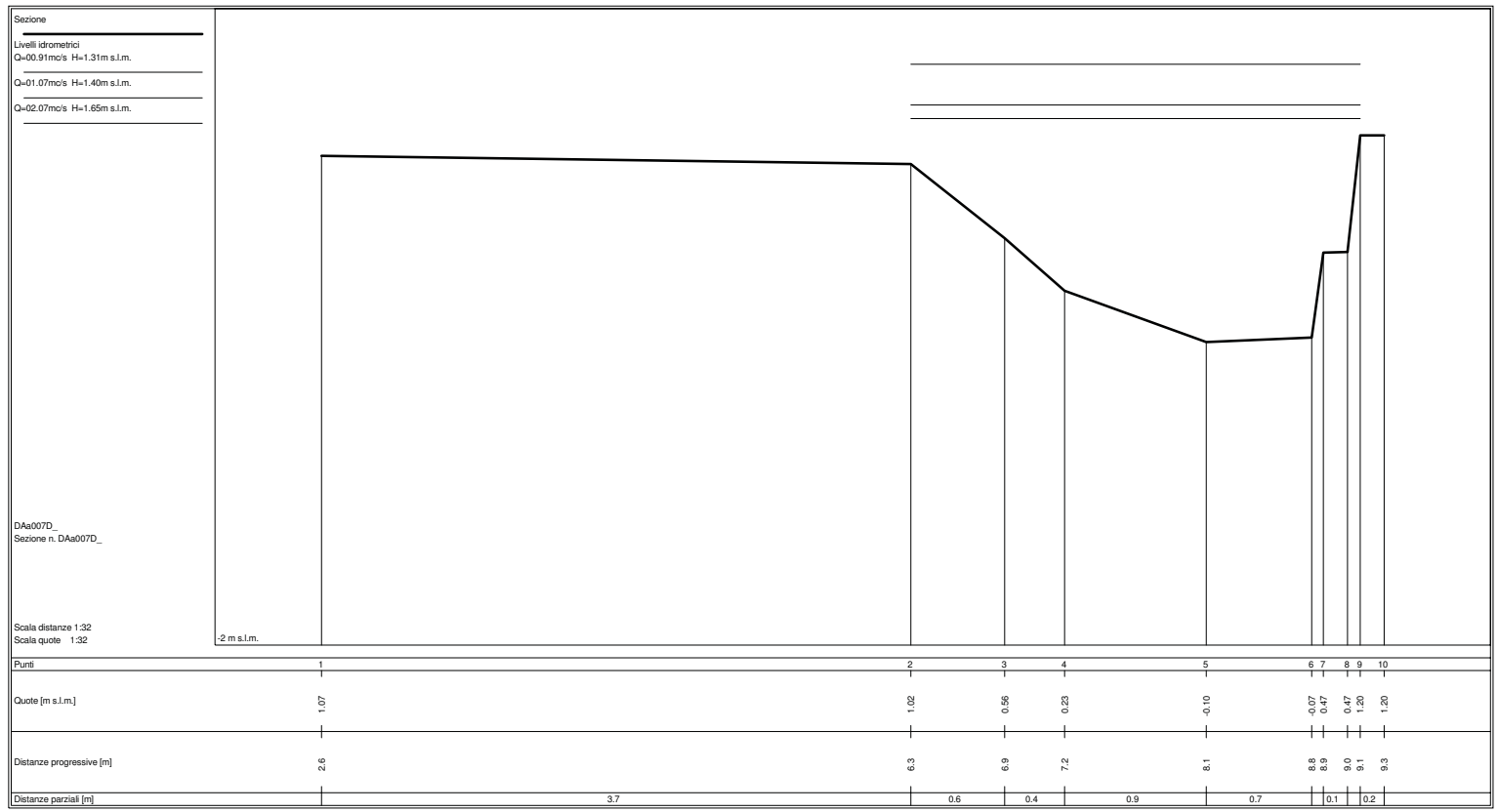

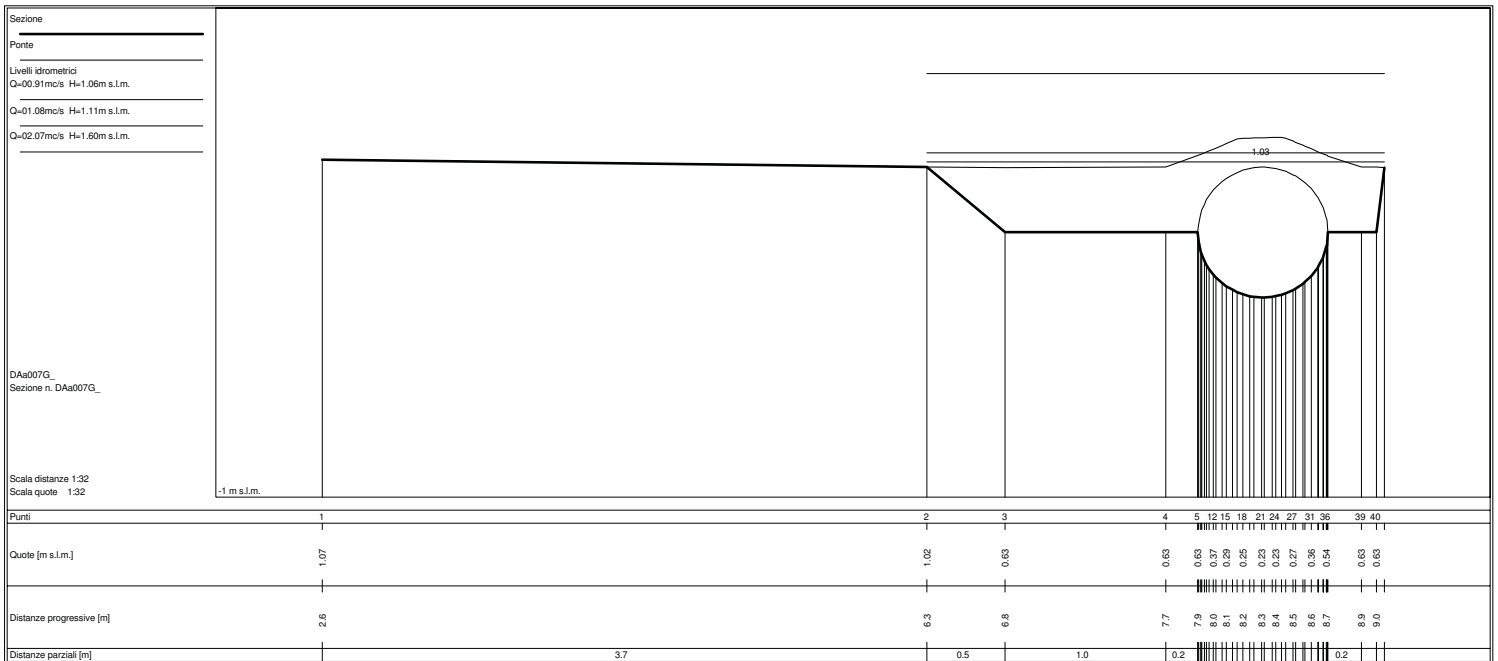
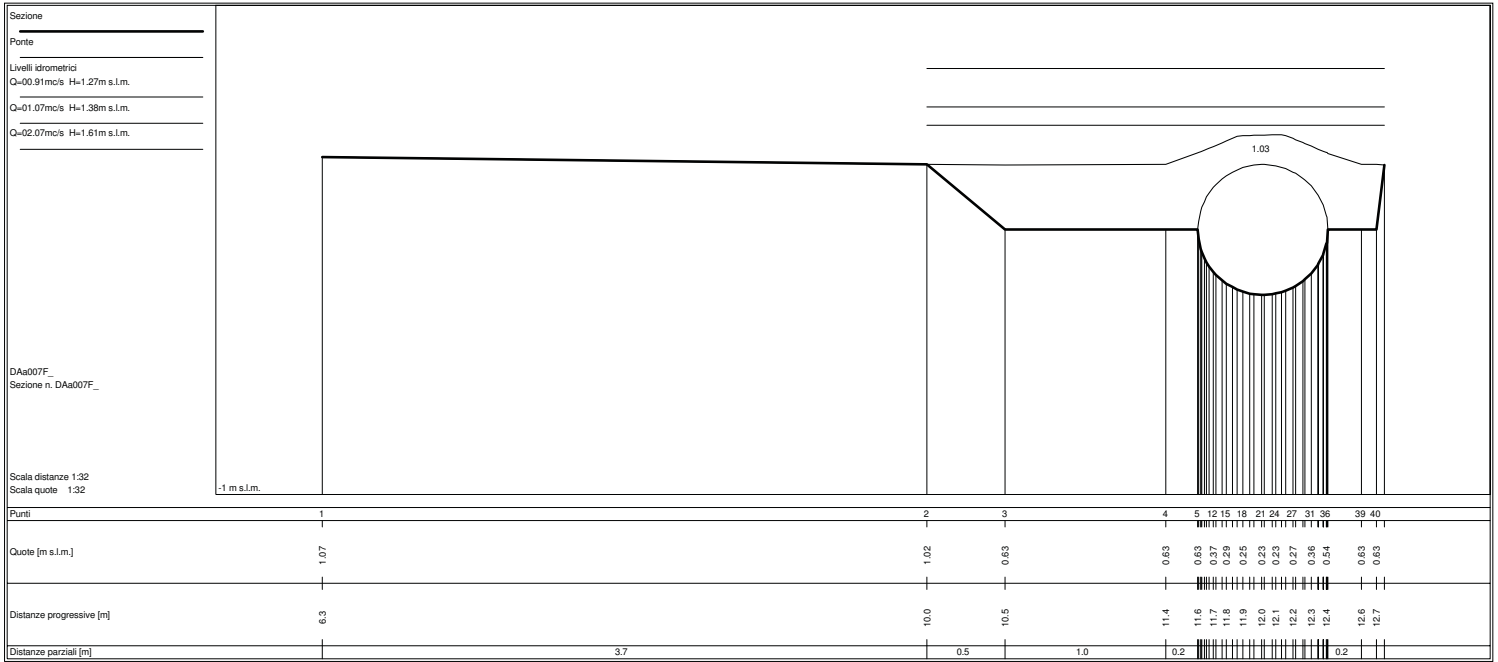

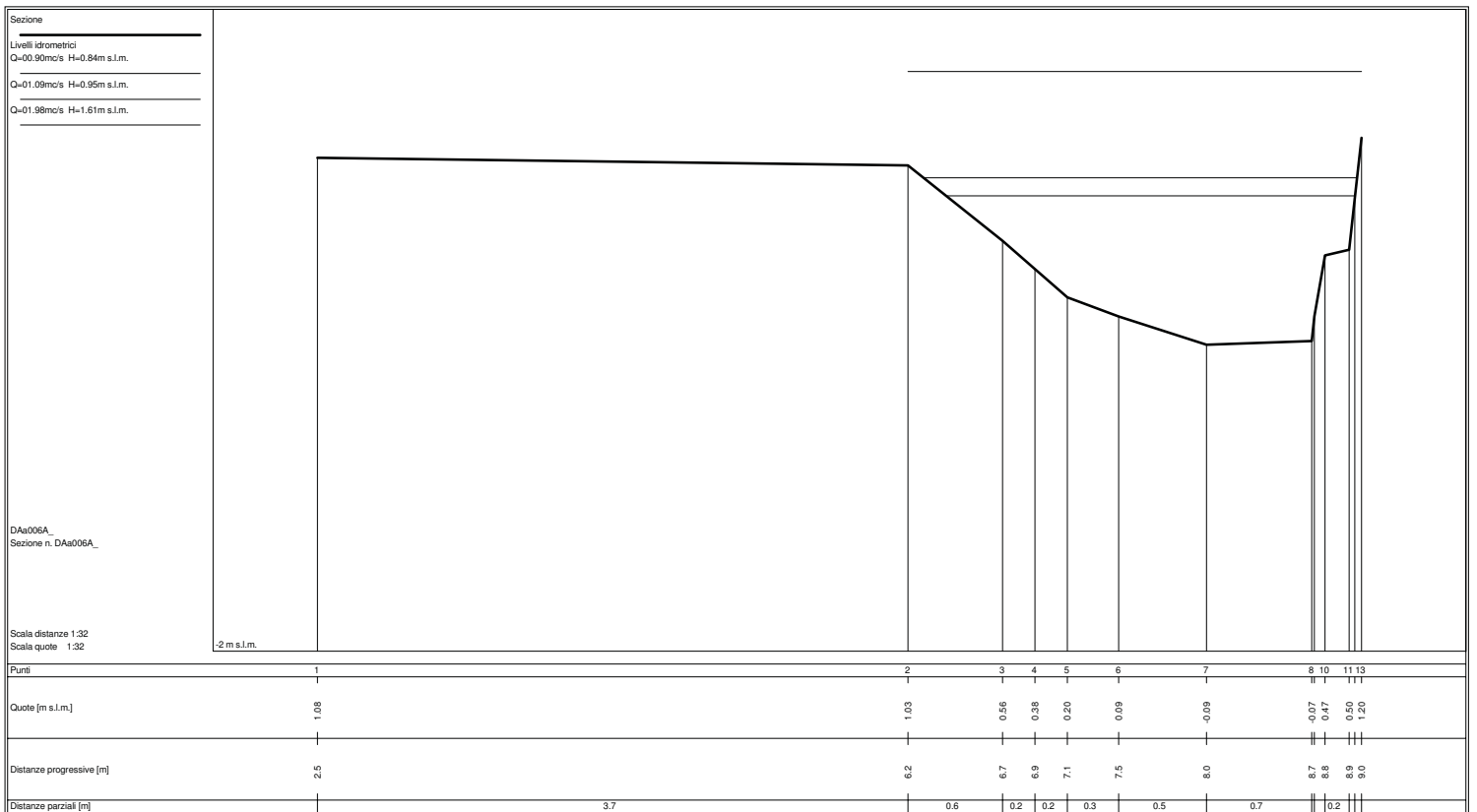
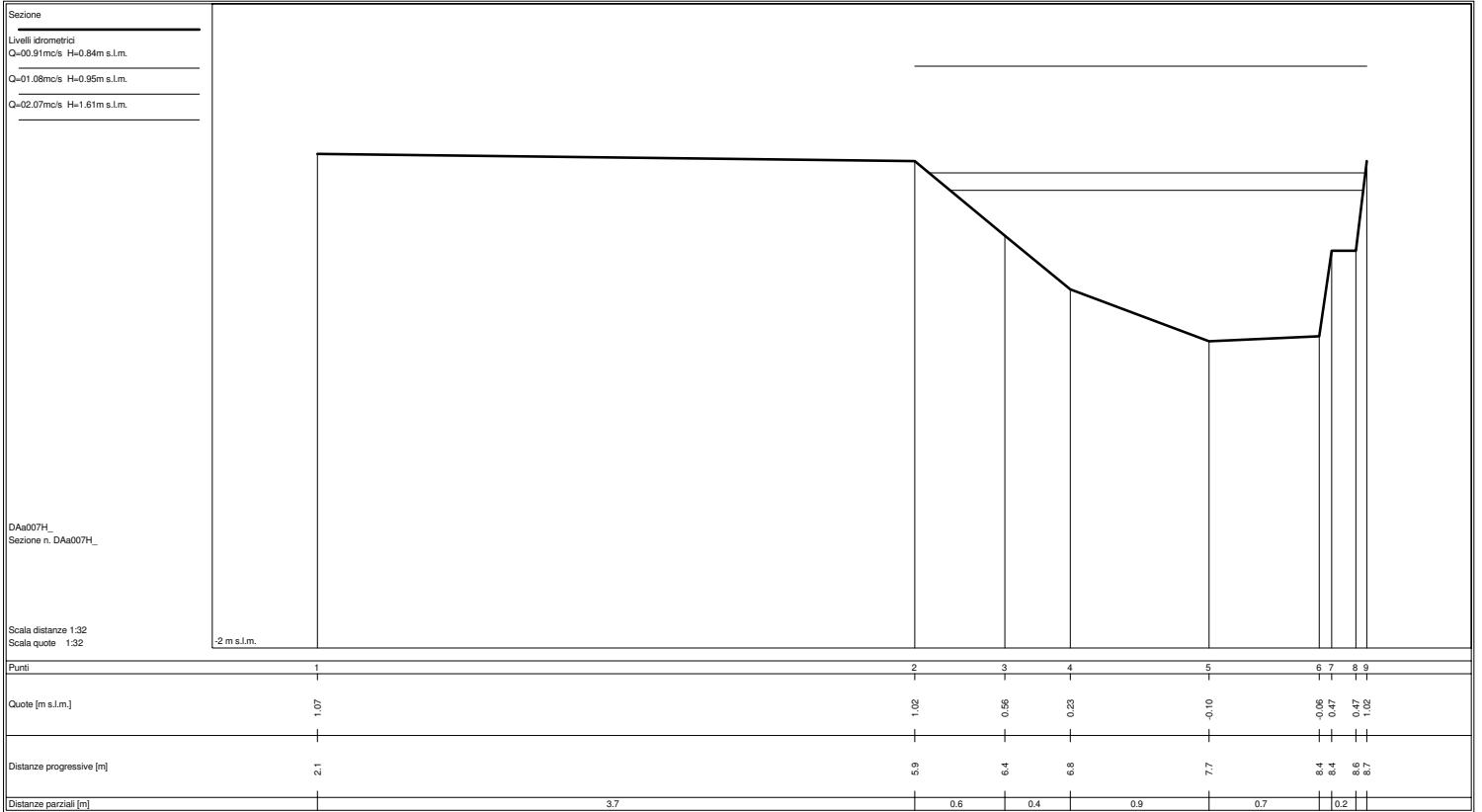

Sezione  
 Ponte  
 Livelli idrometrici  
 Q=00.90mc/s H=0.83m s.l.m.  
 Q=01.09mc/s H=0.93m s.l.m.  
 Q=01.97mc/s H=1.61m s.l.m.

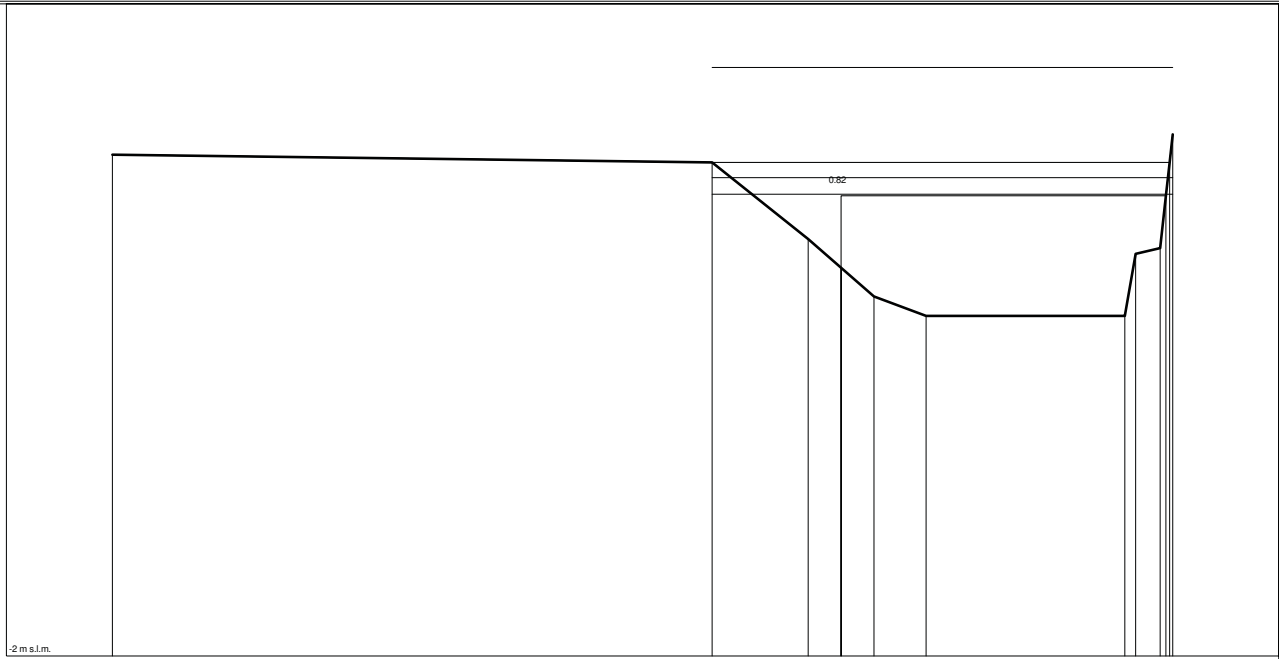

DAa006B  
 Sezione n. DAa006B\_

Scala distanze 1:32  
 Scala quote 1:32

|                          |      |      |      |      |      |      |      |      |      |      |
|--------------------------|------|------|------|------|------|------|------|------|------|------|
| Punti                    | 1    | 2    | 3    | 4    | 6    | 7    | 8    | 9    | 10   | 13   |
| Quote [m s.l.m.]         | 1.08 | 1.03 | 0.96 | 0.38 | 0.20 | 0.09 | 0.09 | 0.47 | 0.50 | 1.20 |
| Distanze progressive [m] | 2.5  | 6.2  | 6.7  | 6.9  | 7.1  | 7.5  | 8.7  | 8.8  | 8.9  | 9.0  |
| Distanze parziali [m]    |      | 3.7  | 0.6  | 0.2  | 0.2  | 0.3  | 1.2  | 0.2  |      |      |

Sezione  
 Ponte  
 Livelli idrometrici  
 Q=00.90mc/s H=0.83m s.l.m.  
 Q=01.09mc/s H=0.92m s.l.m.  
 Q=01.95mc/s H=1.60m s.l.m.

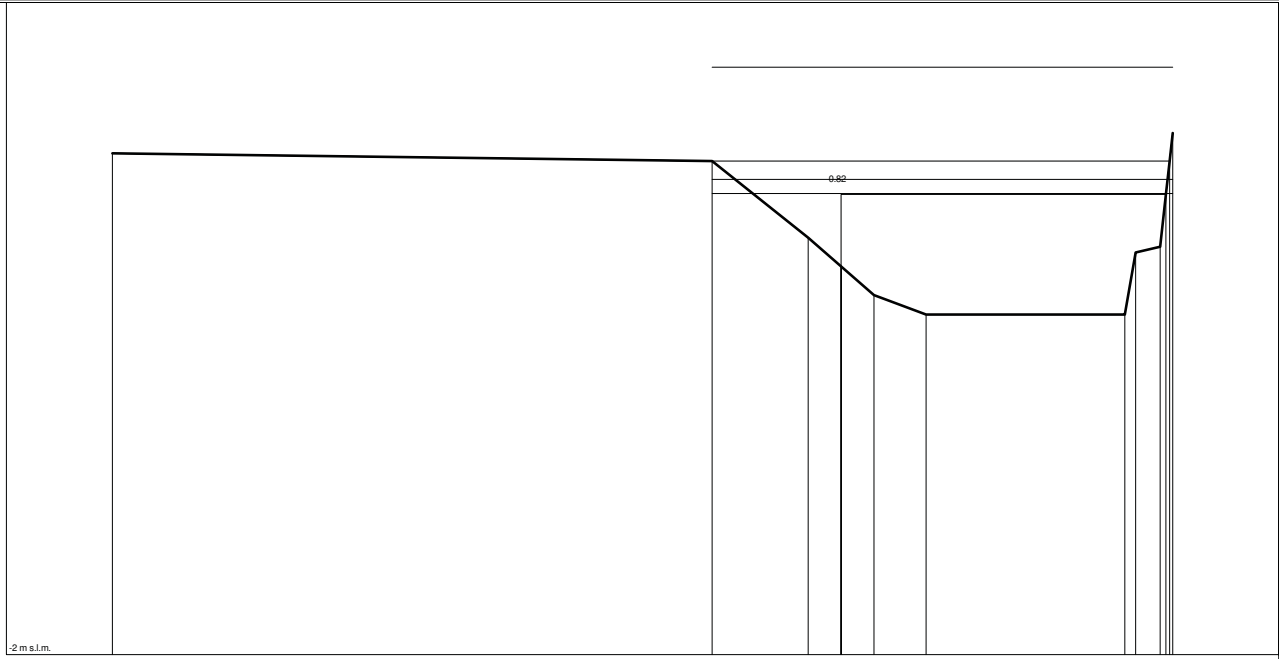

DAa006C  
 Sezione n. DAa006C\_

Scala distanze 1:32  
 Scala quote 1:32

|                          |      |      |      |      |      |      |      |      |      |      |
|--------------------------|------|------|------|------|------|------|------|------|------|------|
| Punti                    | 1    | 2    | 3    | 4    | 6    | 7    | 8    | 9    | 10   | 13   |
| Quote [m s.l.m.]         | 1.08 | 1.03 | 0.96 | 0.38 | 0.20 | 0.09 | 0.09 | 0.47 | 0.50 | 1.20 |
| Distanze progressive [m] | 2.5  | 6.2  | 6.7  | 6.9  | 7.1  | 7.5  | 8.7  | 8.8  | 8.9  | 9.0  |
| Distanze parziali [m]    |      | 3.7  | 0.6  | 0.2  | 0.2  | 0.3  | 1.2  | 0.2  |      |      |

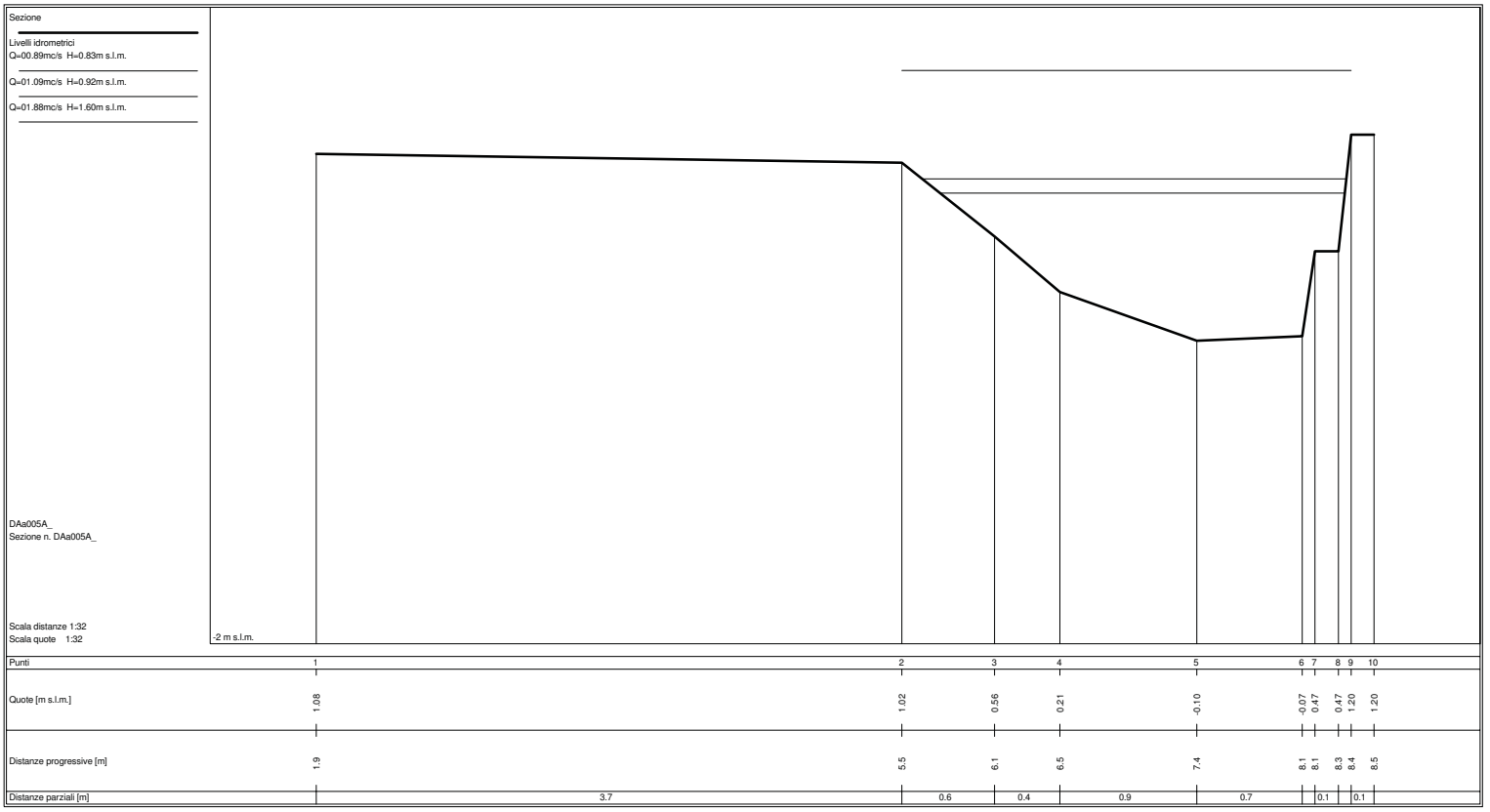
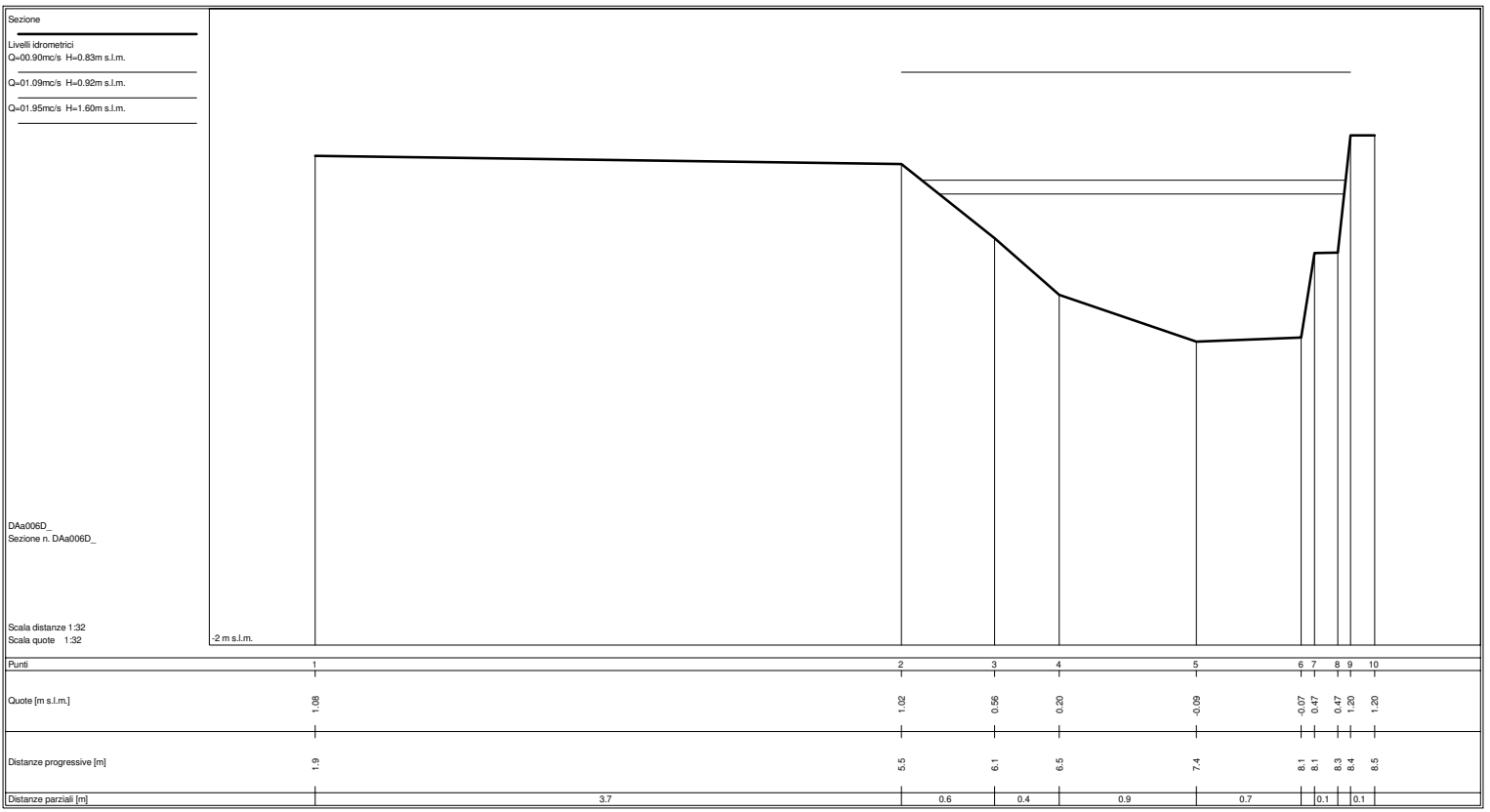





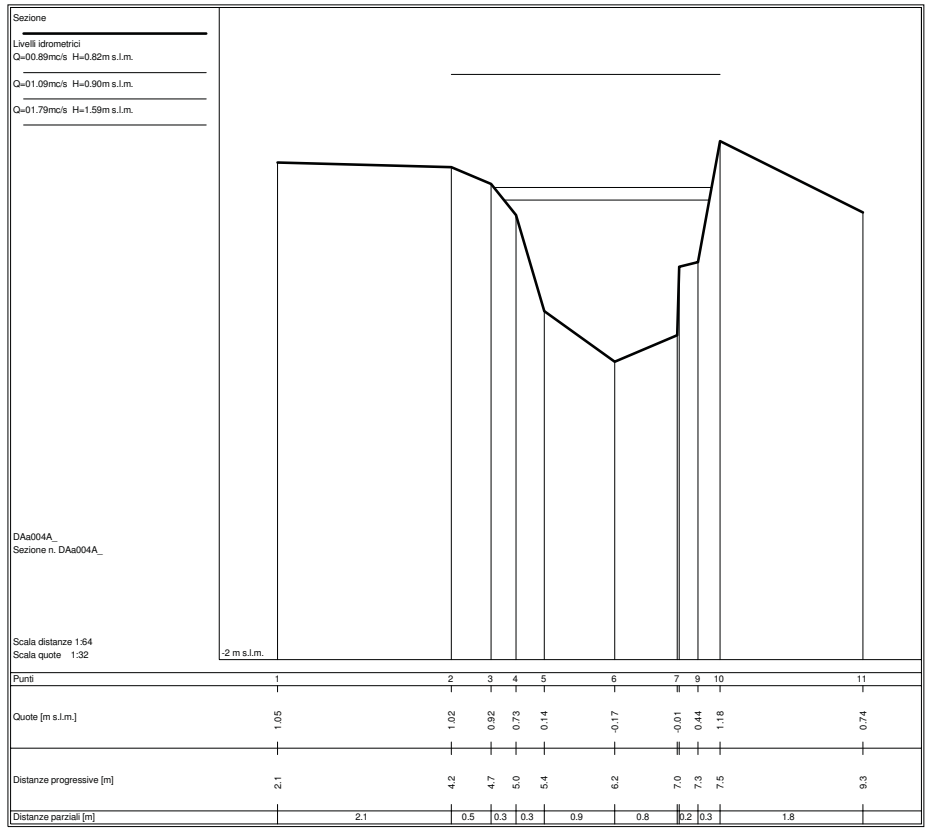
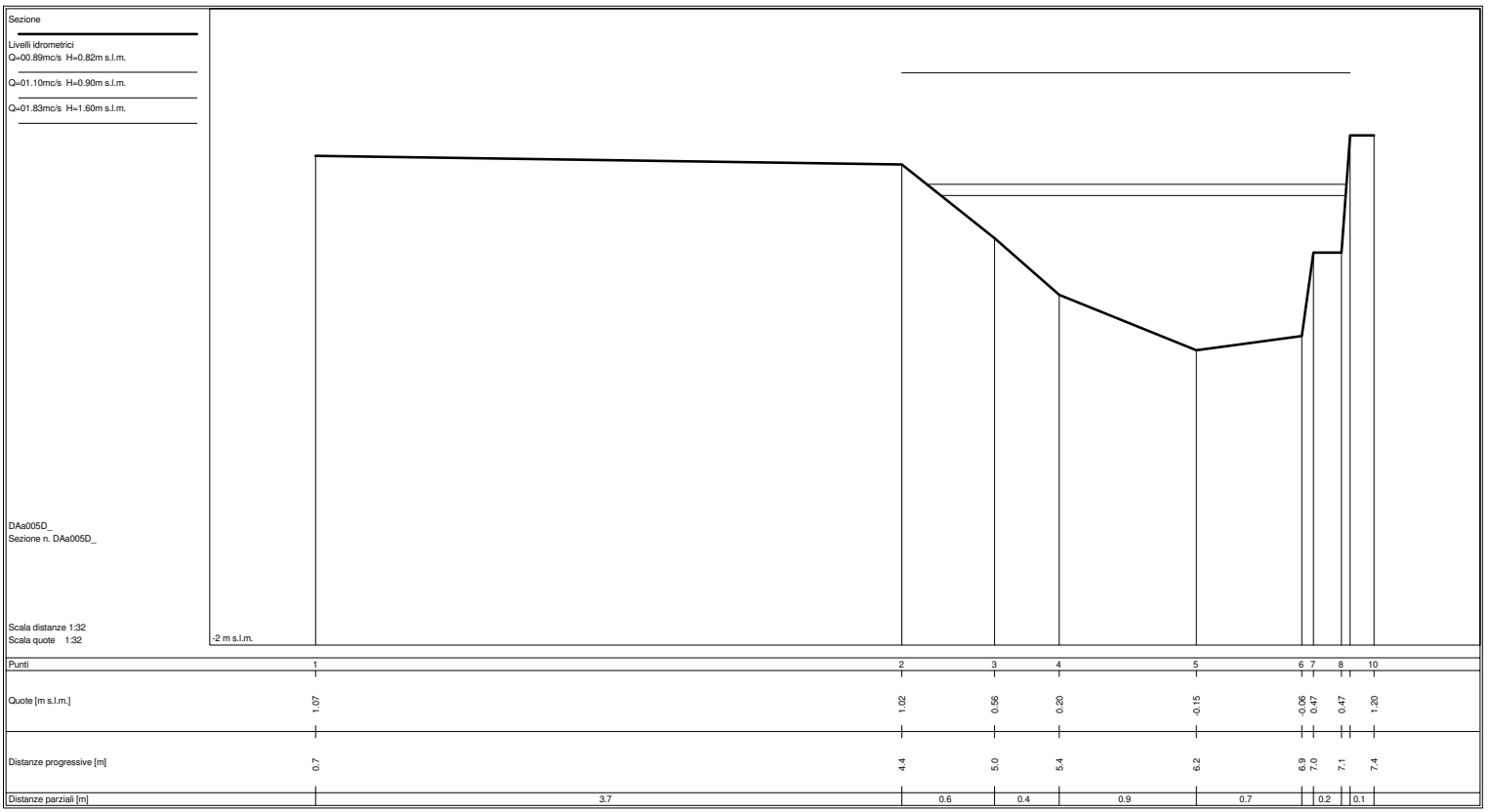

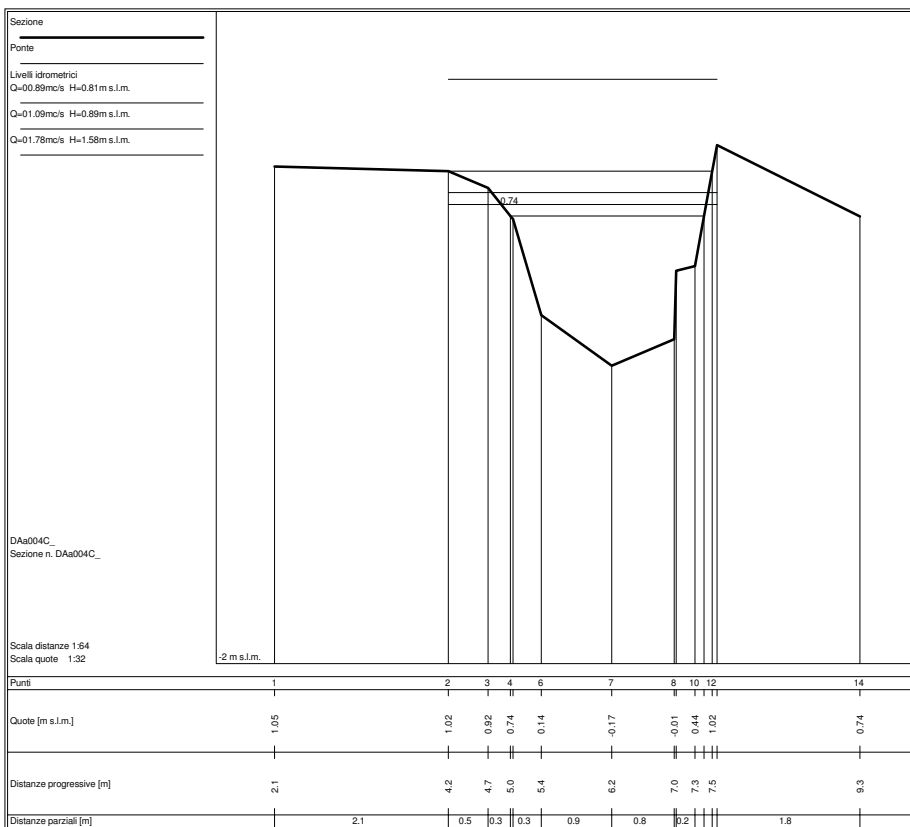
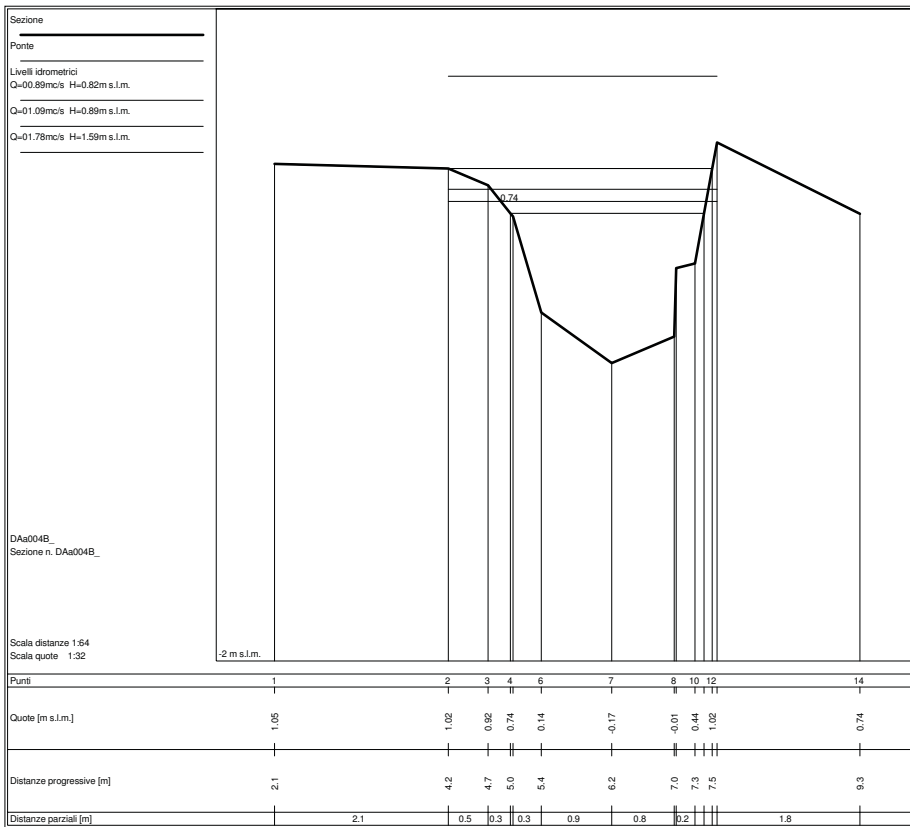

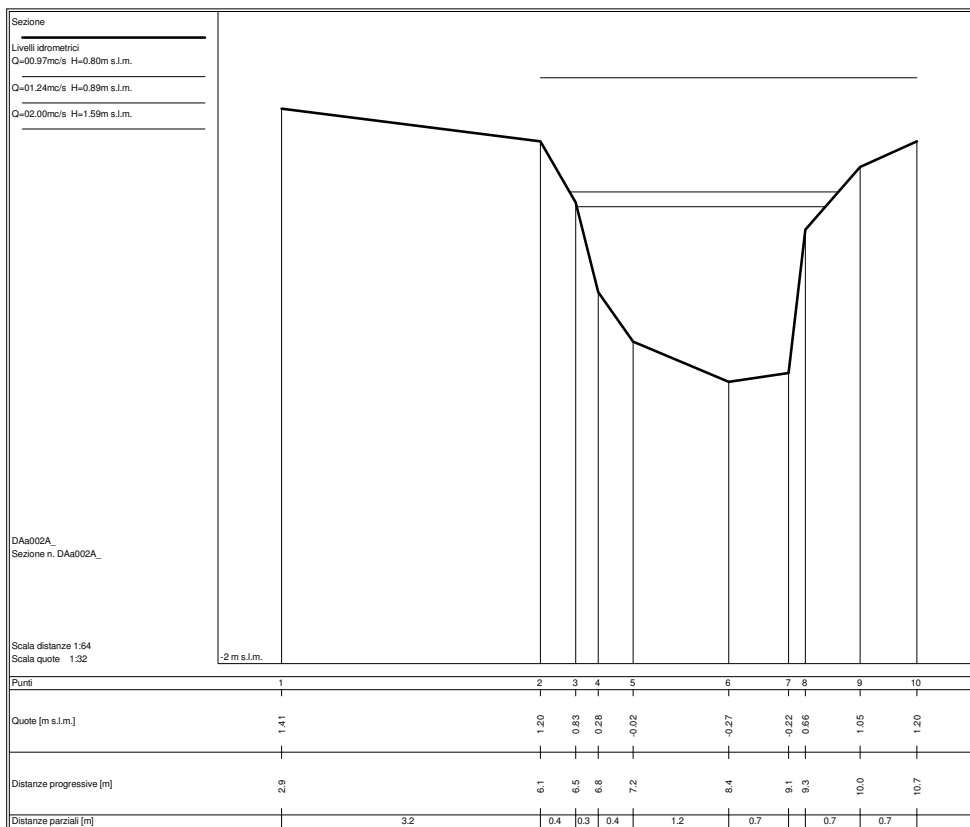
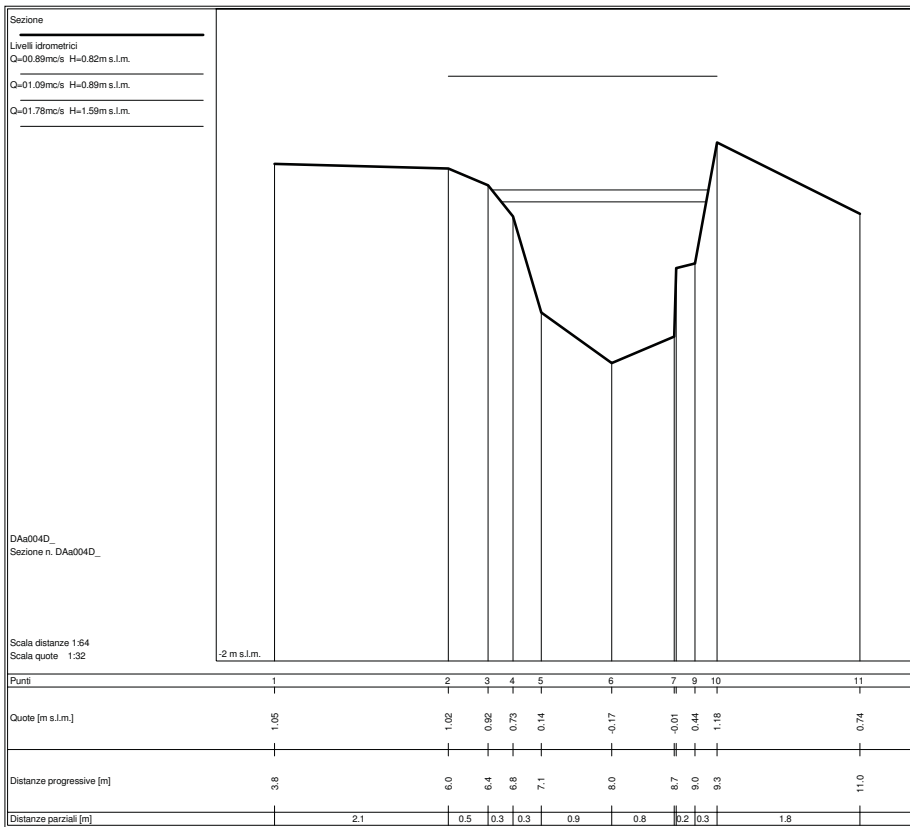

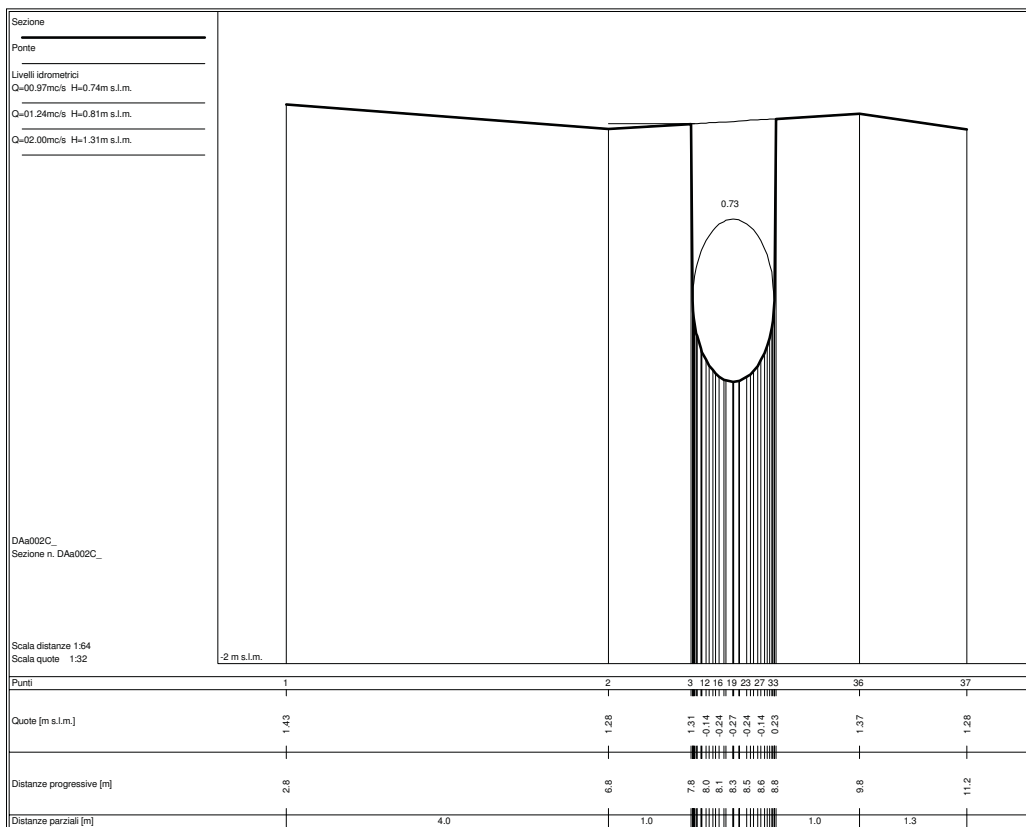
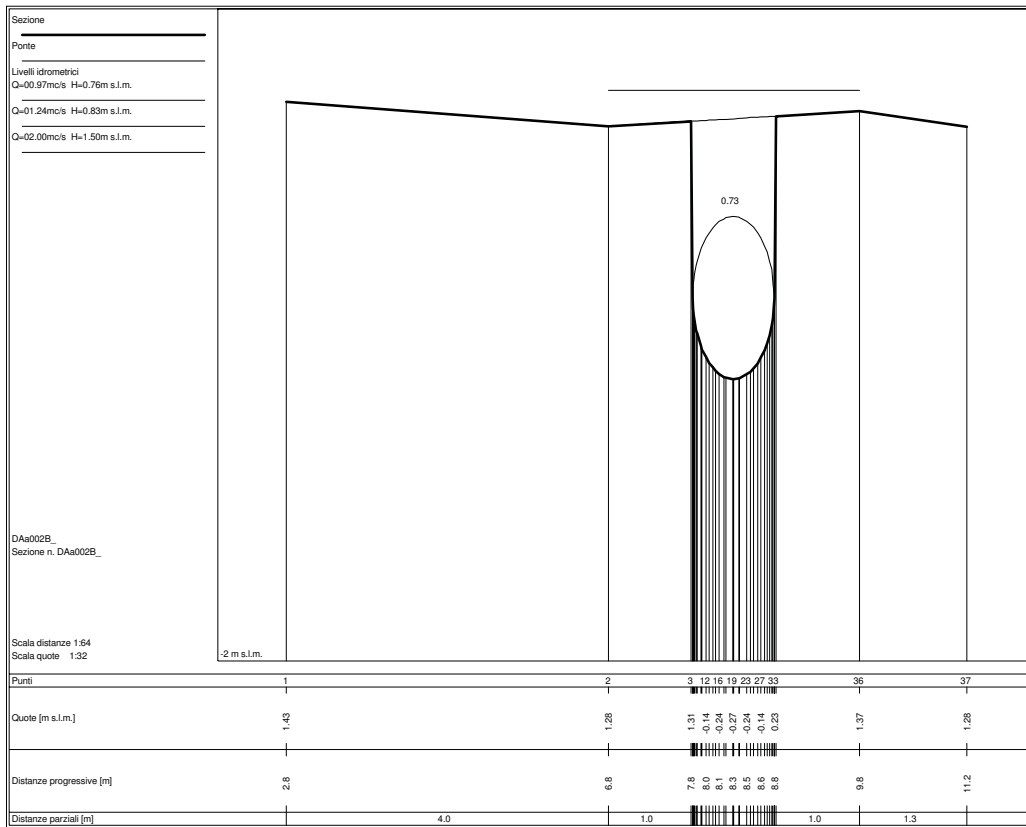

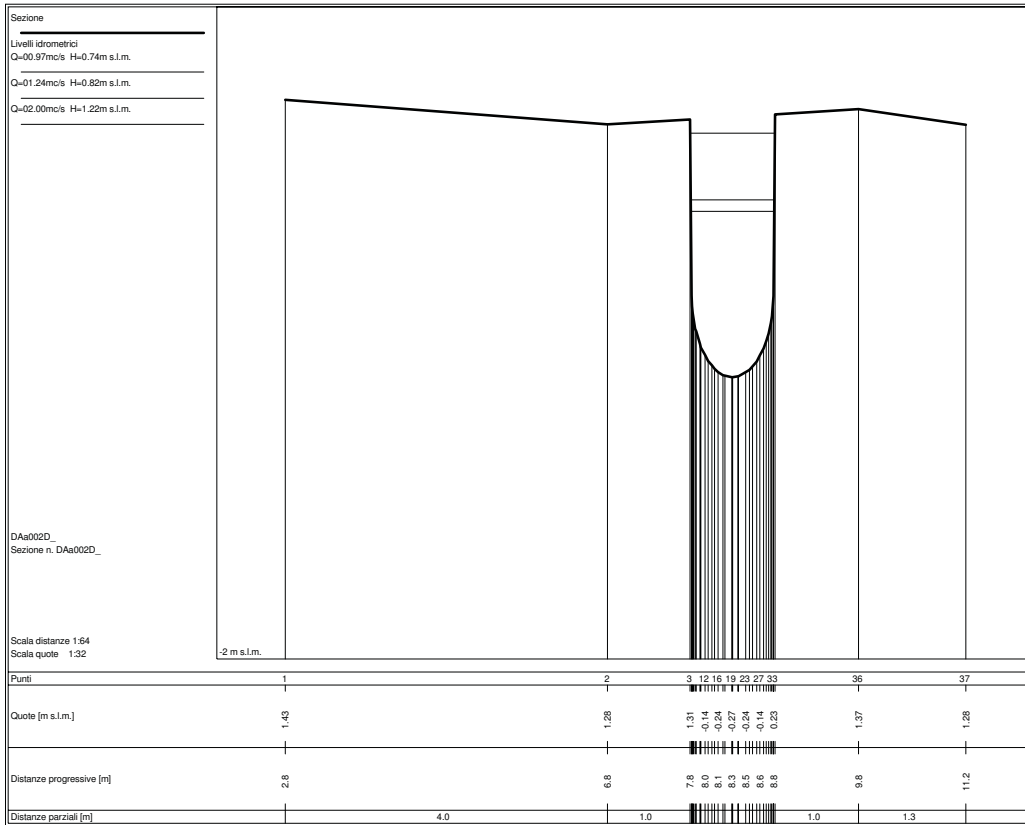

## **FOSSO SILCIA – RAMO A**

Sezione  
 Livelli idrometrici  
 Q=00.45mc/s H=1.75m s.l.m.  
 Q=00.55mc/s H=1.81m s.l.m.  
 Q=01.07mc/s H=1.96m s.l.m.

Stao014  
 Sezione n. Stao014

Scala distanze 1:64  
 Scala quote 1:32

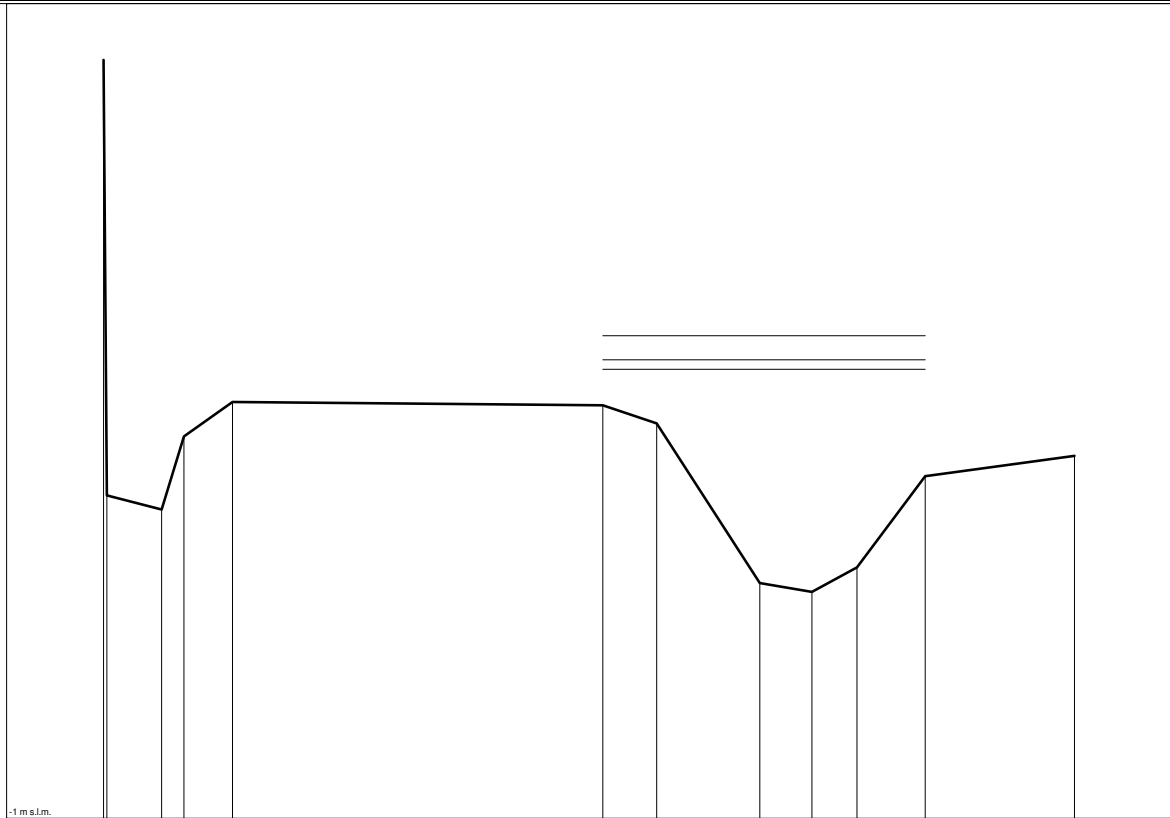

|                          |      |      |      |      |      |      |      |      |      |      |      |
|--------------------------|------|------|------|------|------|------|------|------|------|------|------|
| Punti                    | 1    | 3    | 4    | 5    | 6    | 7    | 8    | 9    | 10   | 11   | 12   |
| Quote [m s.l.m.]         | 3.65 | 0.90 | 1.34 | 1.55 | 1.53 | 1.42 | 0.44 | 0.39 | 0.54 | 1.10 | 1.22 |
| Distanze progressive [m] | 2.2  | 3.0  | 3.2  | 3.8  | 8.4  | 9.0  | 10.3 | 10.9 | 11.5 | 12.3 | 14.2 |
| Distanze parziali [m]    |      | 0.7  | 0.3  | 0.6  | 4.5  | 0.7  | 1.3  | 0.6  | 0.6  | 0.8  | 1.8  |

Sezione  
 Livelli idrometrici  
 Q=00.44mc/s H=1.76m s.l.m.  
 Q=00.55mc/s H=1.82m s.l.m.  
 Q=01.04mc/s H=1.98m s.l.m.

Stao013  
 Sezione n. Stao013

Scala distanze 1:64  
 Scala quote 1:64

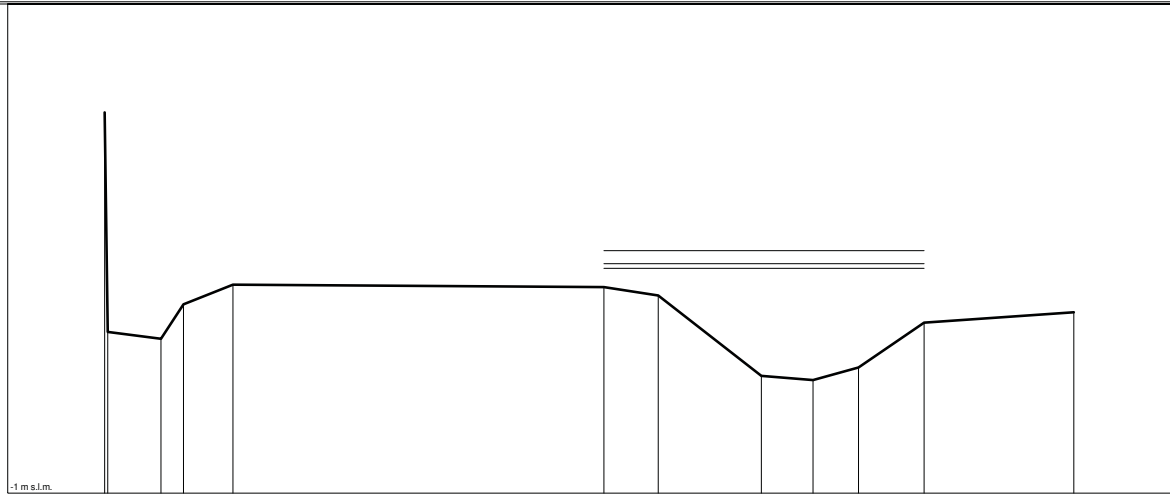

|                          |      |      |      |      |      |      |      |      |      |      |      |
|--------------------------|------|------|------|------|------|------|------|------|------|------|------|
| Punti                    | 1    | 3    | 4    | 5    | 6    | 7    | 8    | 9    | 10   | 11   | 12   |
| Quote [m s.l.m.]         | 3.68 | 0.89 | 1.32 | 1.56 | 1.53 | 1.43 | 0.44 | 0.39 | 0.54 | 1.09 | 1.22 |
| Distanze progressive [m] | 2.2  | 2.9  | 3.2  | 3.8  | 8.3  | 9.0  | 10.3 | 10.9 | 11.5 | 12.3 | 14.1 |
| Distanze parziali [m]    |      | 0.7  | 0.3  | 0.6  | 4.6  | 0.7  | 1.3  | 0.6  | 0.6  | 0.8  | 1.8  |



Sezione  
 Livelli idrometrici  
 Q=00.43mc/s H=1.75m s.l.m.  
 Q=00.53mc/s H=1.82m s.l.m.  
 Q=00.98mc/s H=1.98m s.l.m.

Sta012A\_  
 Sezione n. Sta012A\_

Scala distanze 1:64  
 Scala quote 1:64

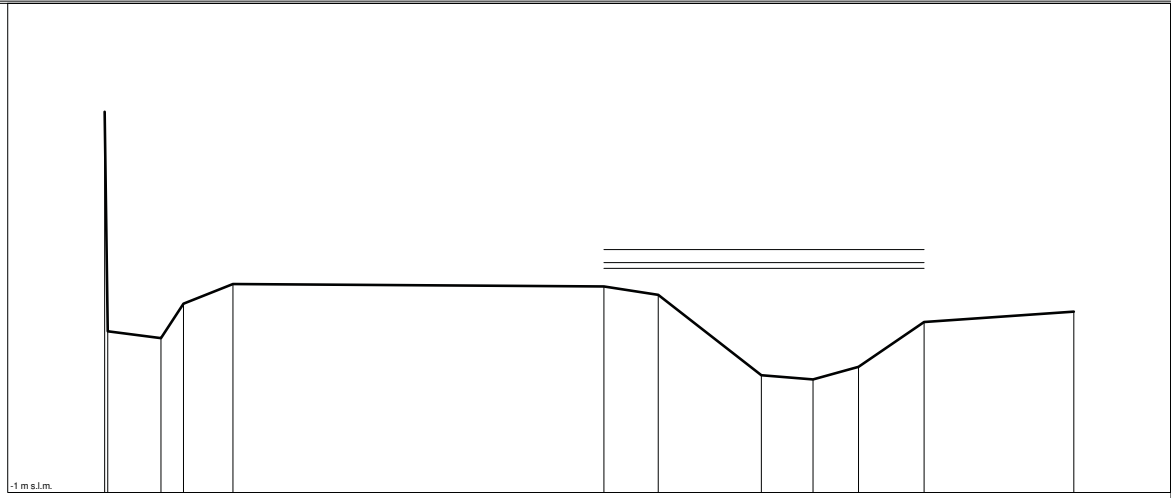

| Punti                    | 1    | 3    | 4    | 5    | 6    | 7    | 8    | 9    | 10   | 11   | 12   |
|--------------------------|------|------|------|------|------|------|------|------|------|------|------|
| Quote [m s.l.m.]         | 3.83 | 0.89 | 1.32 | 1.56 | 1.53 | 1.43 | 0.44 | 0.39 | 0.54 | 1.09 | 1.22 |
| Distanze progressive [m] | 2.2  | 2.9  | 3.2  | 3.8  | 8.3  | 9.0  | 10.3 | 10.9 | 11.5 | 12.3 | 14.1 |
| Distanze parziali [m]    | 0.7  | 0.3  | 0.6  | 4.6  | 0.7  | 1.3  | 0.6  | 0.6  | 0.8  | 1.8  |      |

Sezione  
 Porte  
 Livelli idrometrici  
 Q=00.43mc/s H=1.75m s.l.m.  
 Q=00.54mc/s H=1.82m s.l.m.  
 Q=00.98mc/s H=1.96m s.l.m.

Sta012B\_  
 Sezione n. Sta012B\_

Scala distanze 1:64  
 Scala quote 1:32

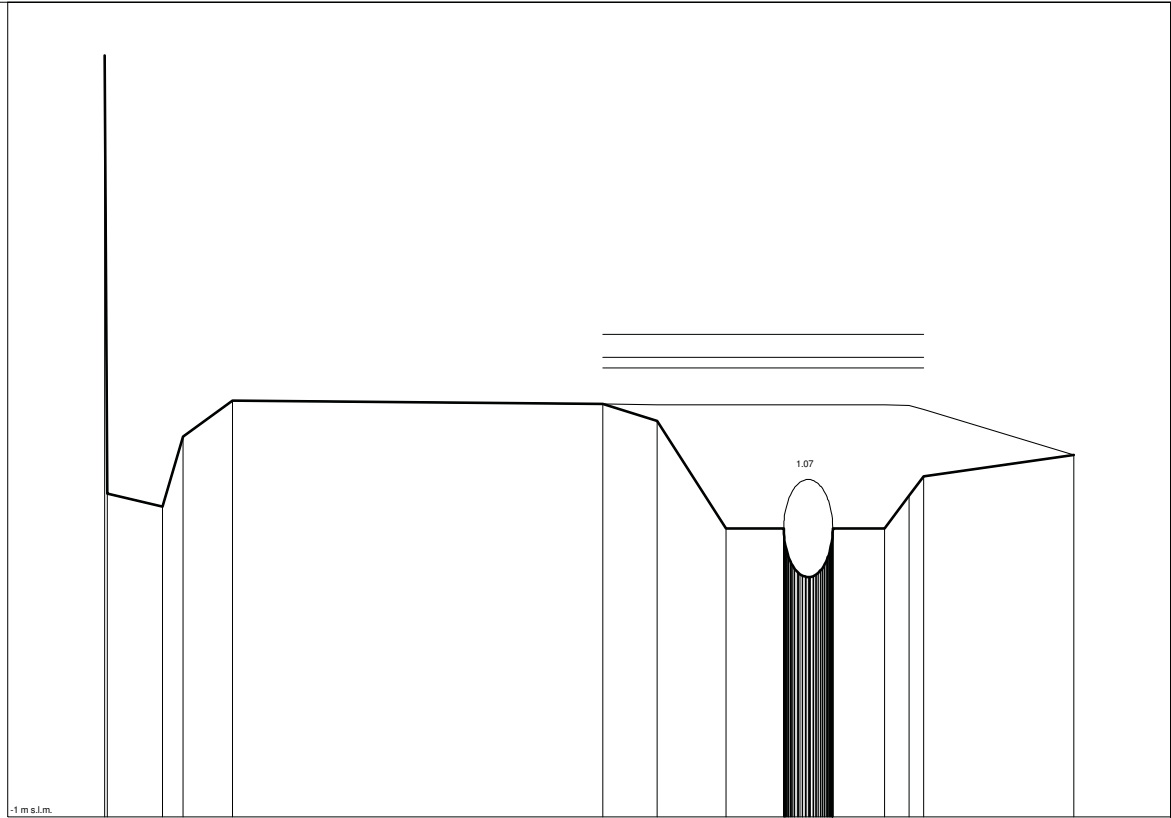

| Punti                    | 1    | 3    | 4    | 5    | 6    | 7    | 8    | 9    | 24   | 33   | 42   | 58   | 59   | 60   | 61   |
|--------------------------|------|------|------|------|------|------|------|------|------|------|------|------|------|------|------|
| Quote [m s.l.m.]         | 3.67 | 0.90 | 1.33 | 1.56 | 1.53 | 1.43 | 0.77 | 0.77 | 0.47 | 0.47 | 0.54 | 0.77 | 0.97 | 1.09 | 1.22 |
| Distanze progressive [m] | 2.2  | 2.9  | 3.2  | 3.8  | 8.3  | 9.0  | 9.9  | 10.6 | 10.9 | 10.9 | 11.1 | 11.8 | 12.1 | 12.3 | 14.1 |
| Distanze parziali [m]    | 0.7  | 0.3  | 0.6  | 4.5  | 0.7  | 0.8  | 0.7  | 0.6  | 0.3  | 0.3  | 1.8  |      |      |      |      |

Sezione  
 Ponte  
 Livelli idrometrici  
 Q=00.45mc/s H=1.57m s.l.m.  
 Q=00.70mc/s H=1.76m s.l.m.  
 Q=01.01mc/s H=1.97m s.l.m.

Sta012CA  
 Sezione n. Sta012CA

Scala distanze 1:64  
 Scala quote 1:32

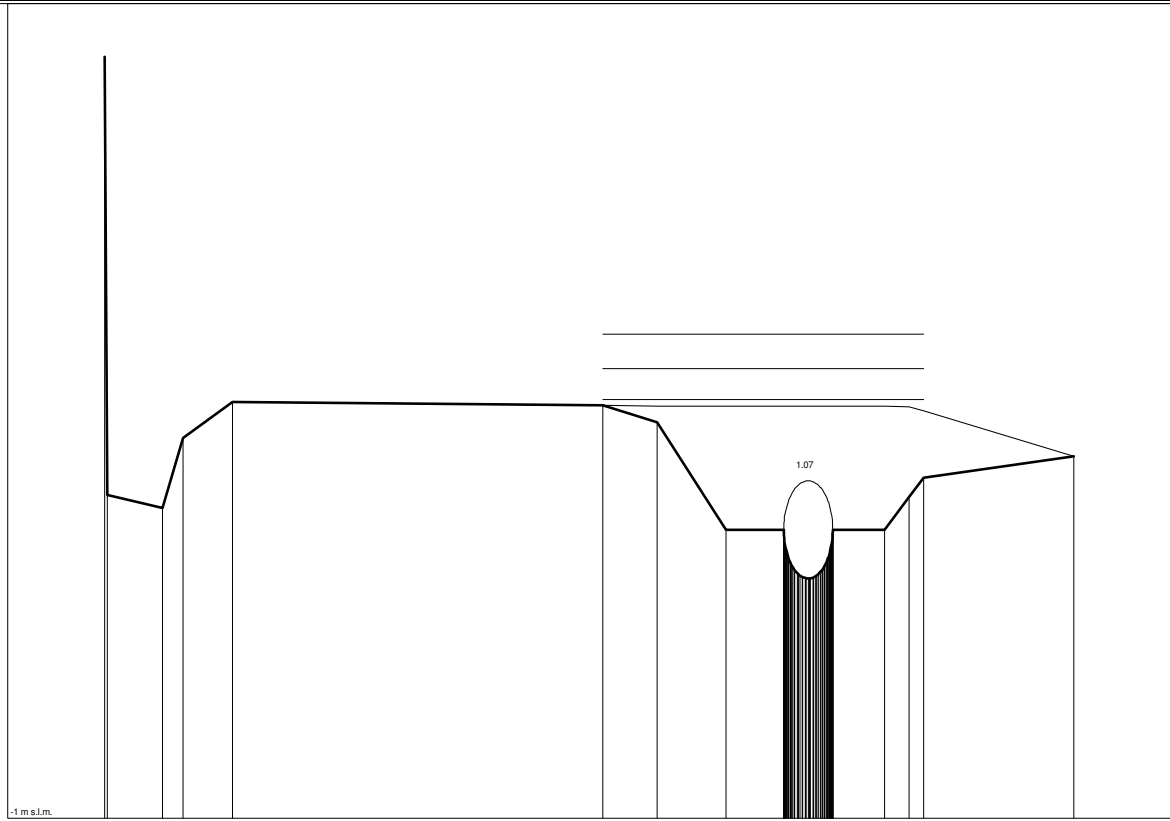

|                          |      |      |      |      |     |      |      |      |      |      |      |      |      |      |      |      |
|--------------------------|------|------|------|------|-----|------|------|------|------|------|------|------|------|------|------|------|
| Punti                    | 1    | 3    | 4    | 5    |     | 6    | 7    | 8    | 9    | 24   | 33   | 42   | 58   | 59   | 60   | 61   |
| Quote [m s.l.m.]         | 3.67 | 0.90 | 1.33 | 1.56 |     | 1.53 | 1.43 | 0.77 | 0.77 | 0.47 | 0.47 | 0.54 | 0.77 | 0.97 | 1.09 | 1.22 |
| Distanze progressive [m] | 2.2  | 2.9  | 3.2  | 3.8  |     | 8.3  | 9.0  | 9.9  | 10.6 | 10.9 | 10.9 | 11.1 | 11.8 | 12.1 | 12.3 | 14.1 |
| Distanze parziali [m]    | 0.7  | 0.3  | 0.6  |      | 4.5 | 0.7  | 0.8  | 0.7  |      |      |      |      | 0.6  | 0.3  |      | 1.8  |

Sezione  
 Ponte  
 Livelli idrometrici  
 Q=00.45mc/s H=1.37m s.l.m.  
 Q=00.70mc/s H=1.73m s.l.m.  
 Q=01.01mc/s H=2.03m s.l.m.

Sta012C  
 Sezione n. Sta012C

Scala distanze 1:64  
 Scala quote 1:32

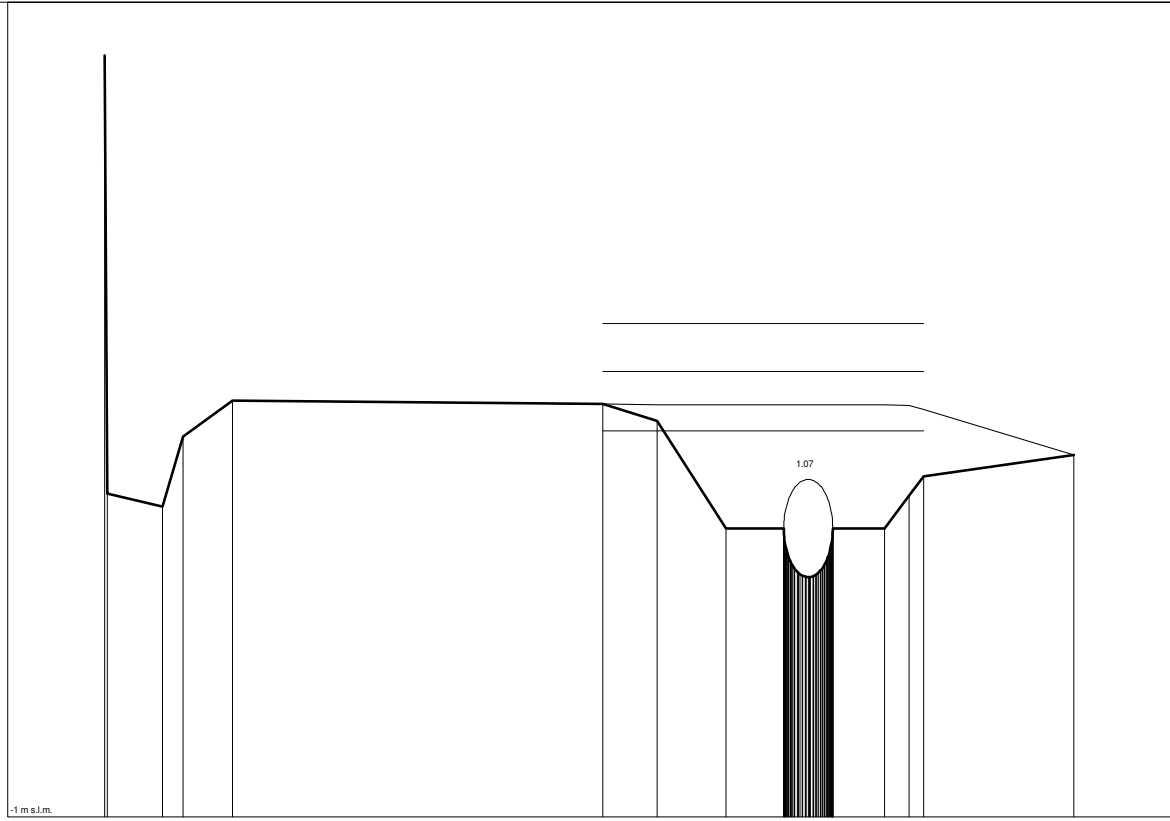

|                          |      |      |      |      |     |      |      |      |      |      |      |      |      |      |      |      |
|--------------------------|------|------|------|------|-----|------|------|------|------|------|------|------|------|------|------|------|
| Punti                    | 1    | 3    | 4    | 5    |     | 6    | 7    | 8    | 9    | 24   | 33   | 42   | 58   | 59   | 60   | 61   |
| Quote [m s.l.m.]         | 3.67 | 0.90 | 1.33 | 1.56 |     | 1.53 | 1.43 | 0.77 | 0.77 | 0.47 | 0.47 | 0.54 | 0.77 | 0.97 | 1.09 | 1.22 |
| Distanze progressive [m] | 2.2  | 2.9  | 3.2  | 3.8  |     | 8.3  | 9.0  | 9.9  | 10.6 | 10.9 | 10.9 | 11.1 | 11.8 | 12.1 | 12.3 | 14.1 |
| Distanze parziali [m]    | 0.7  | 0.3  | 0.6  |      | 4.5 | 0.7  | 0.8  | 0.7  |      |      |      |      | 0.6  | 0.3  |      | 1.8  |

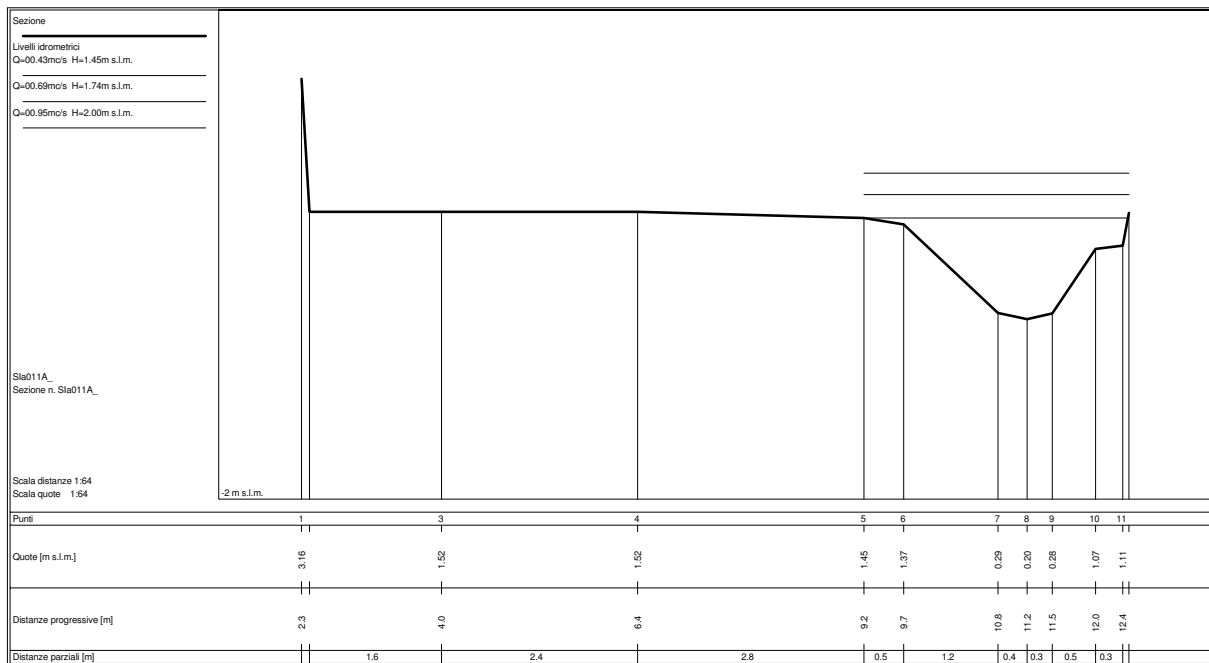
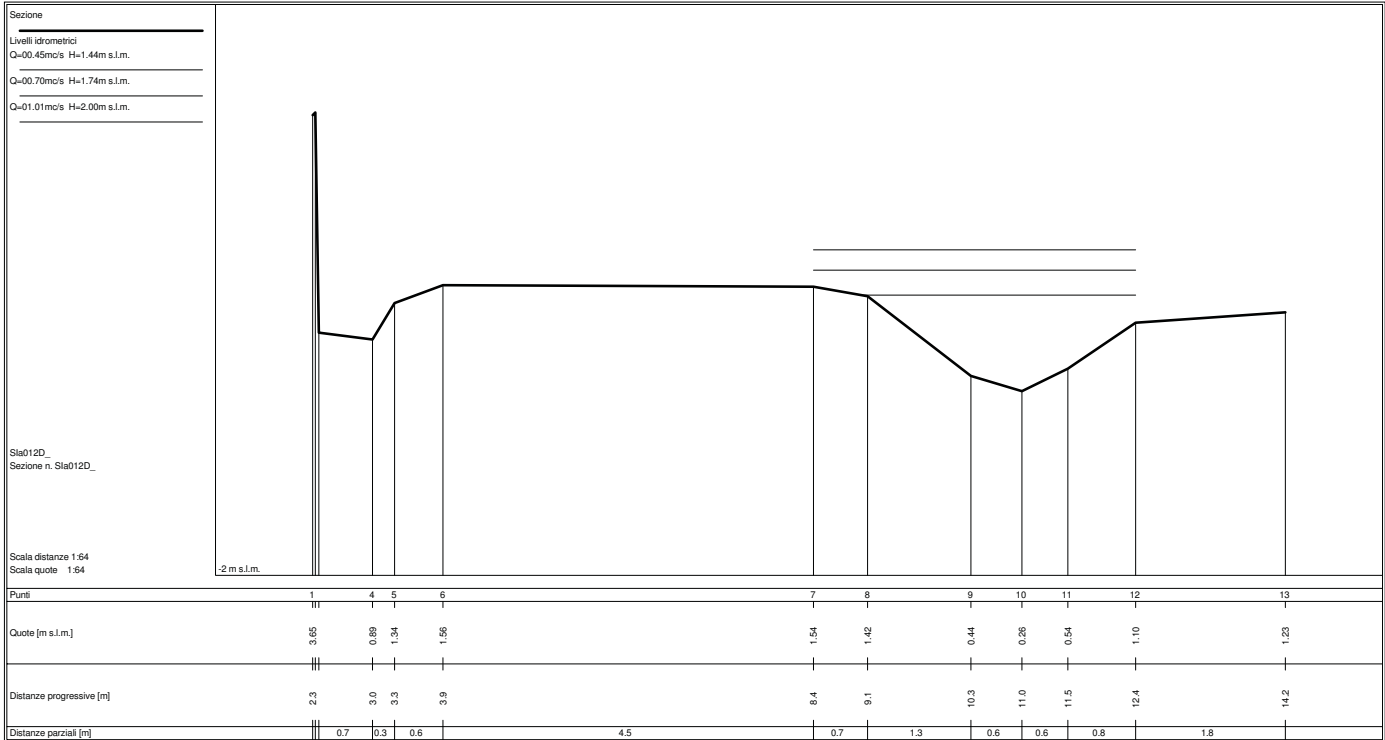

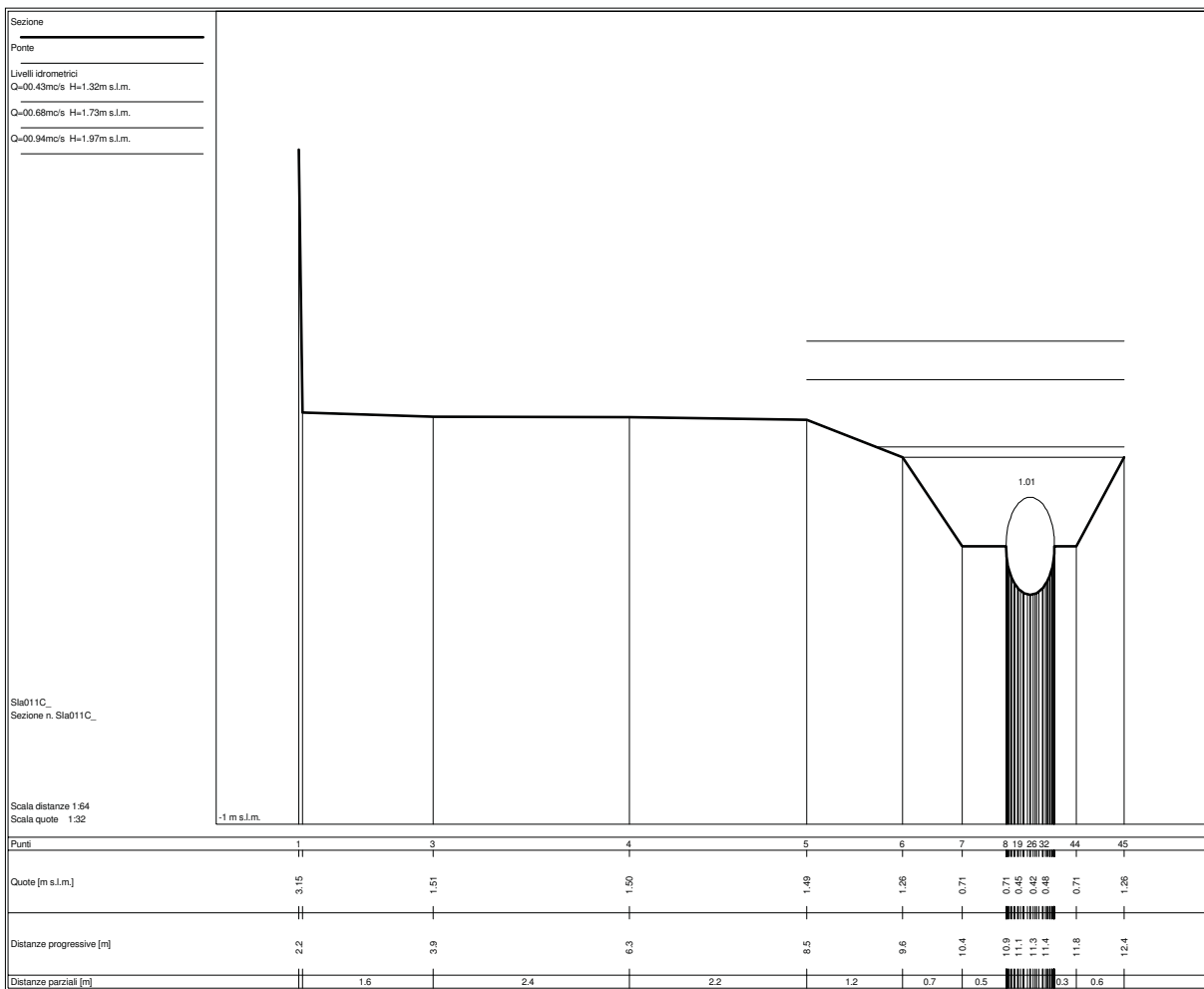
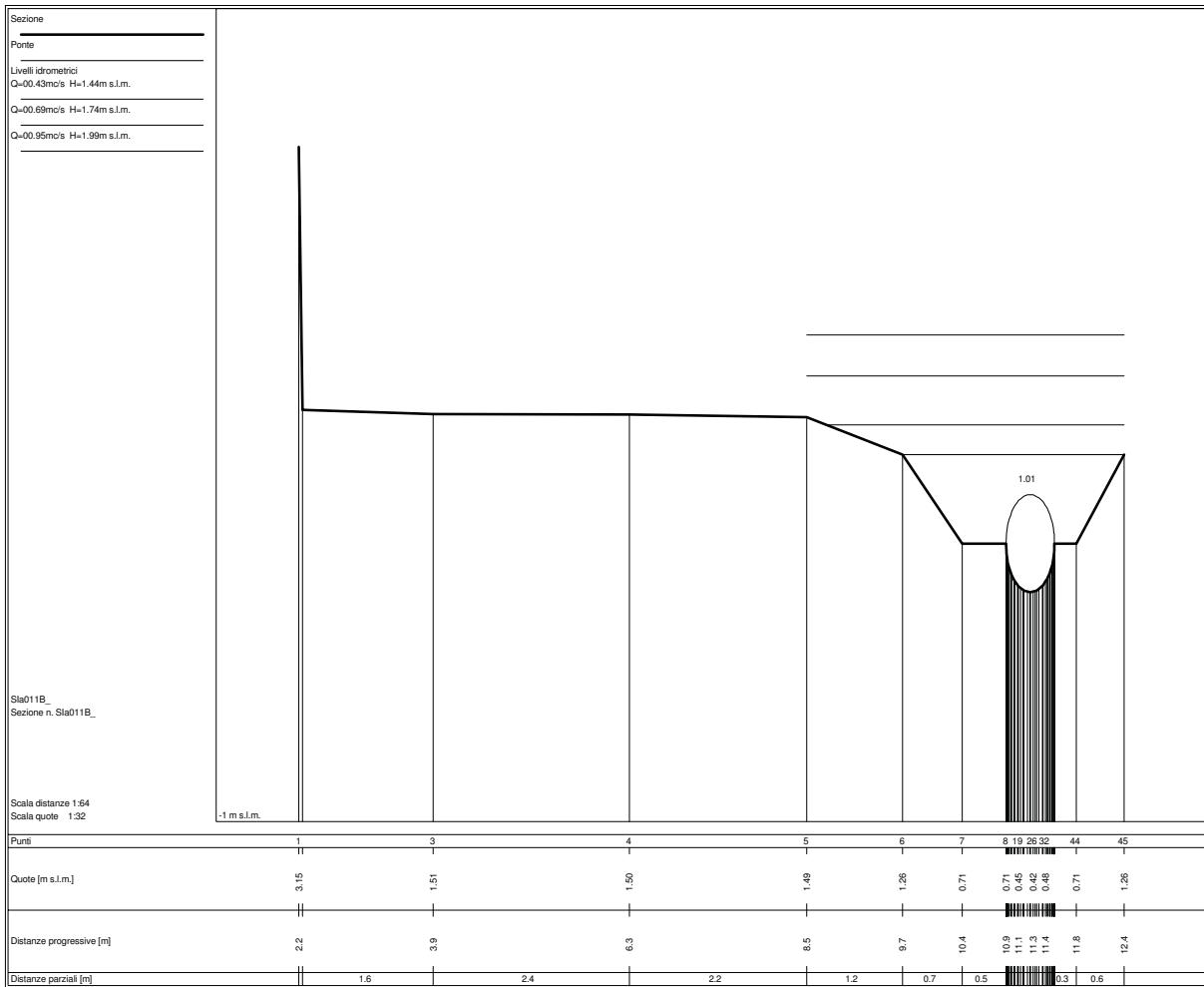

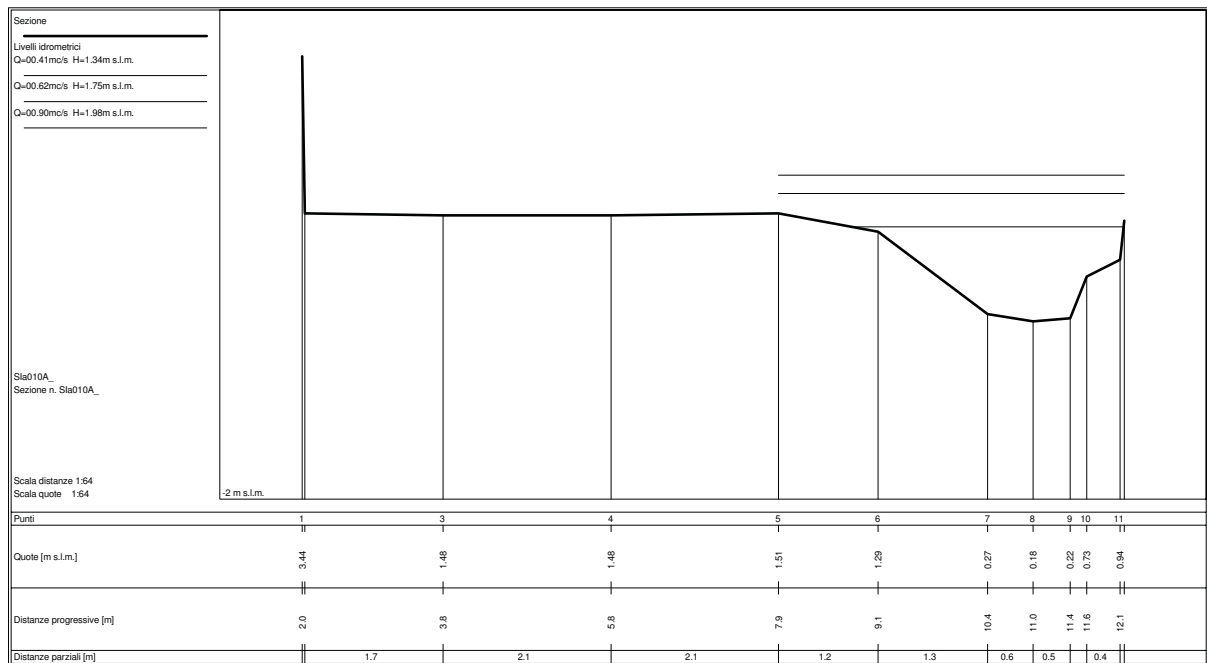
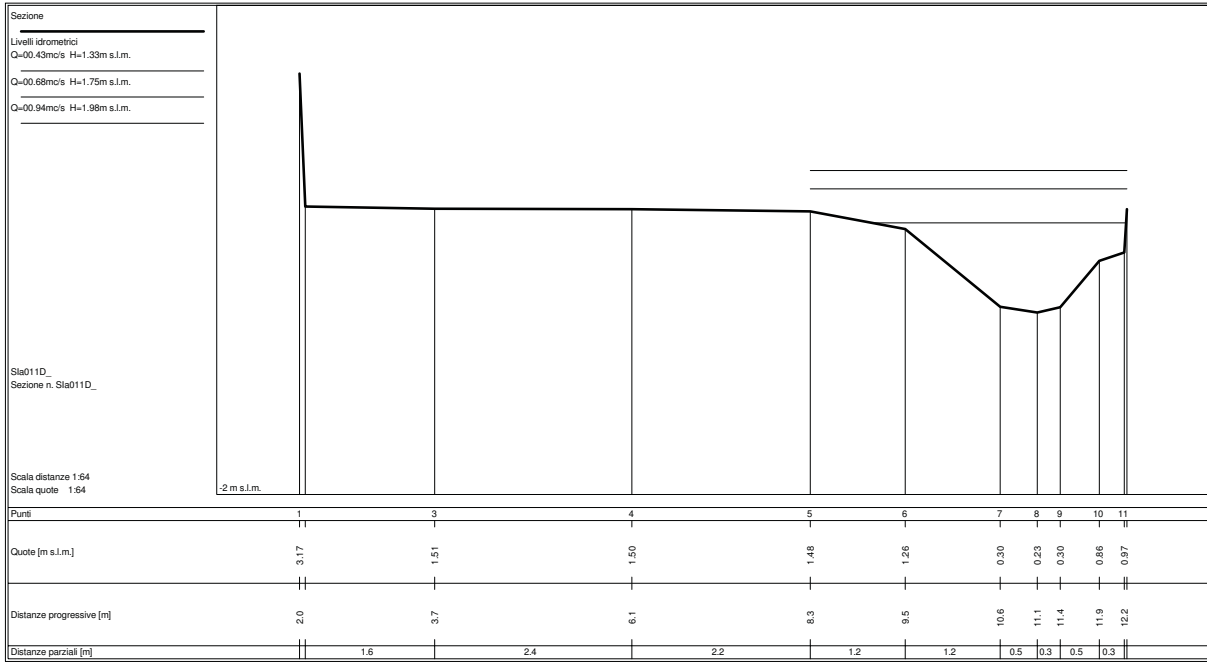

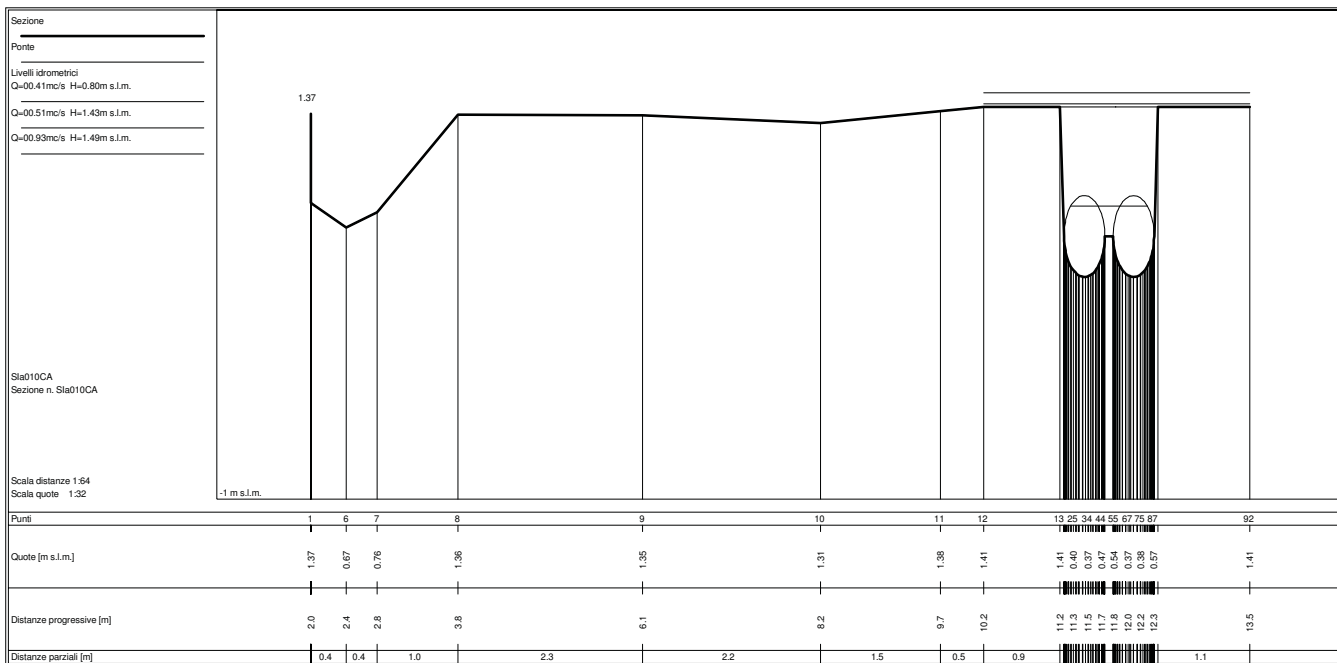
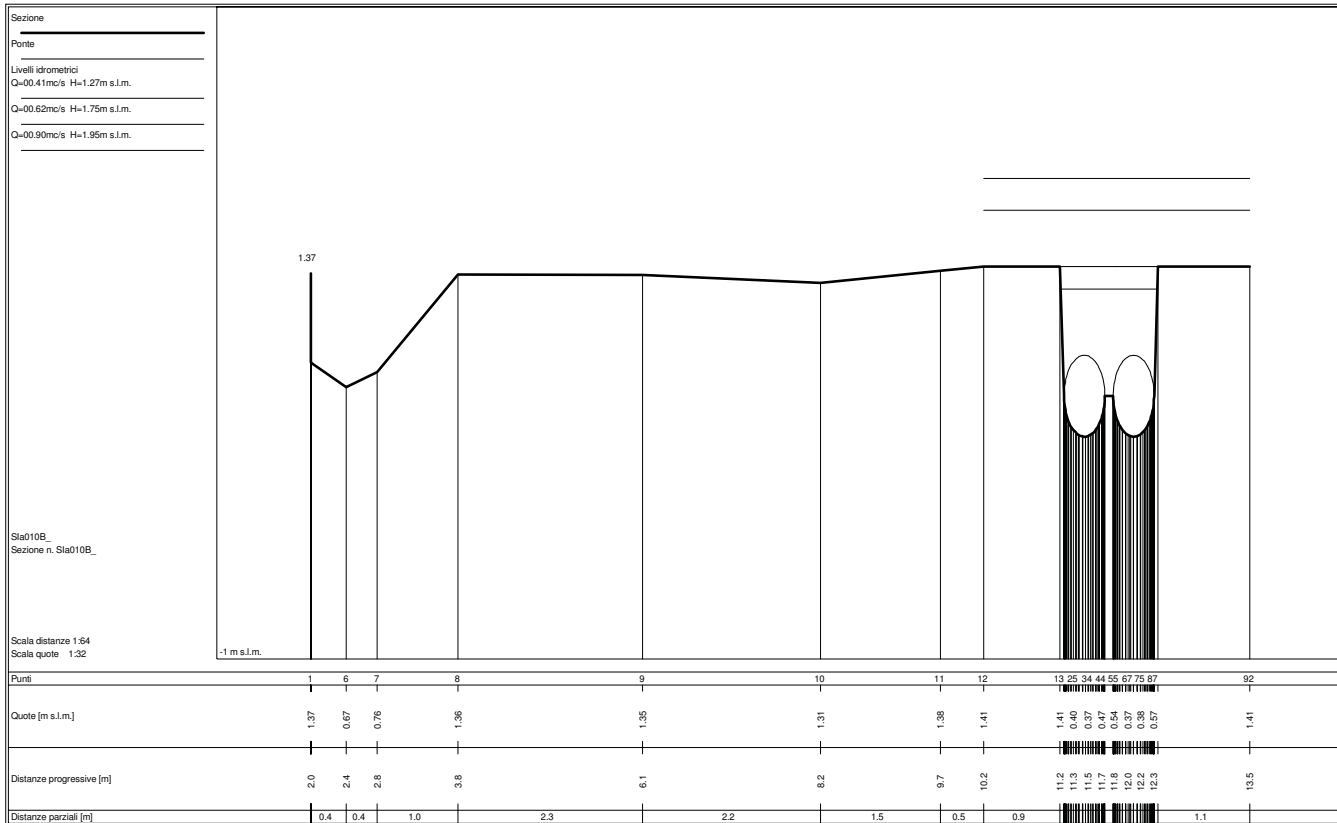

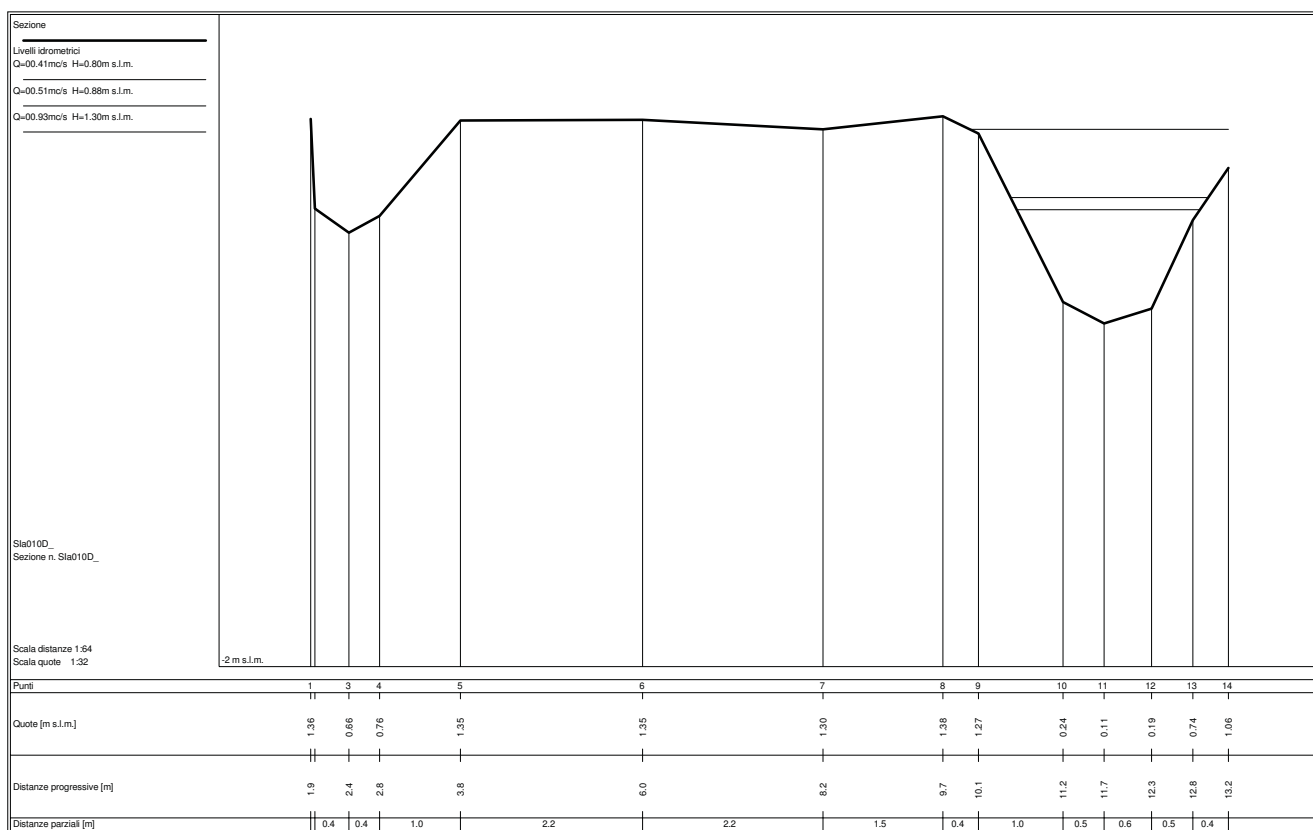
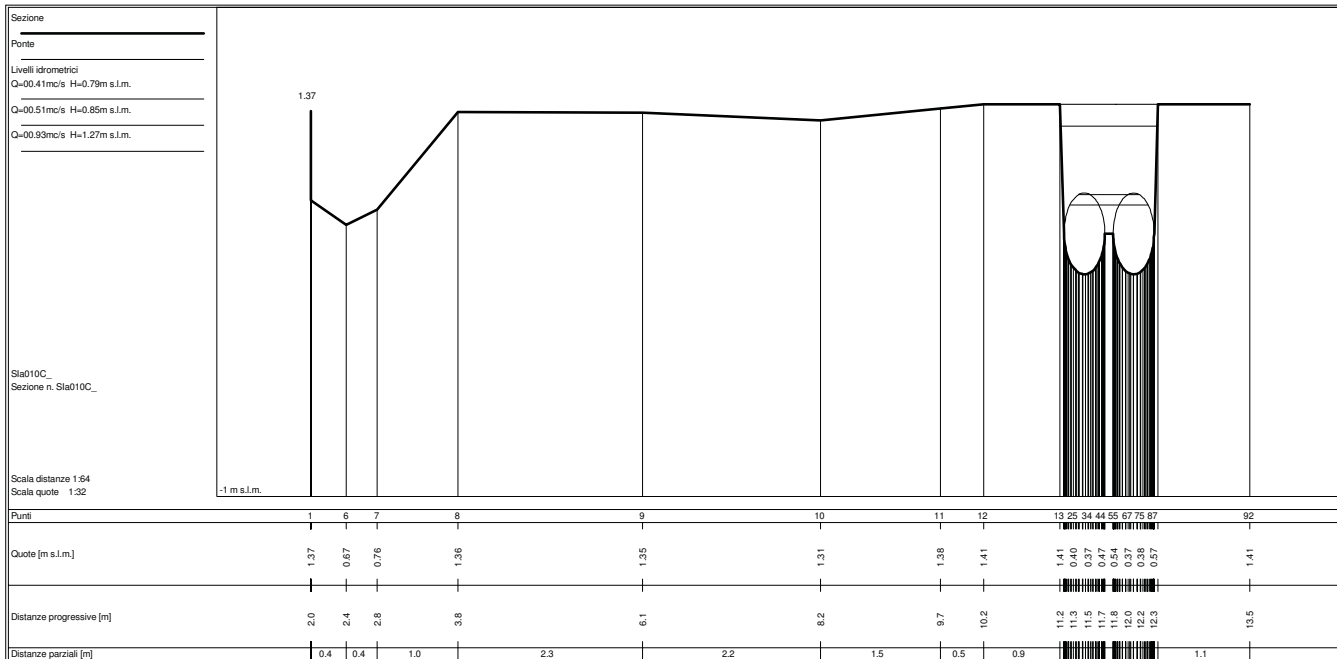

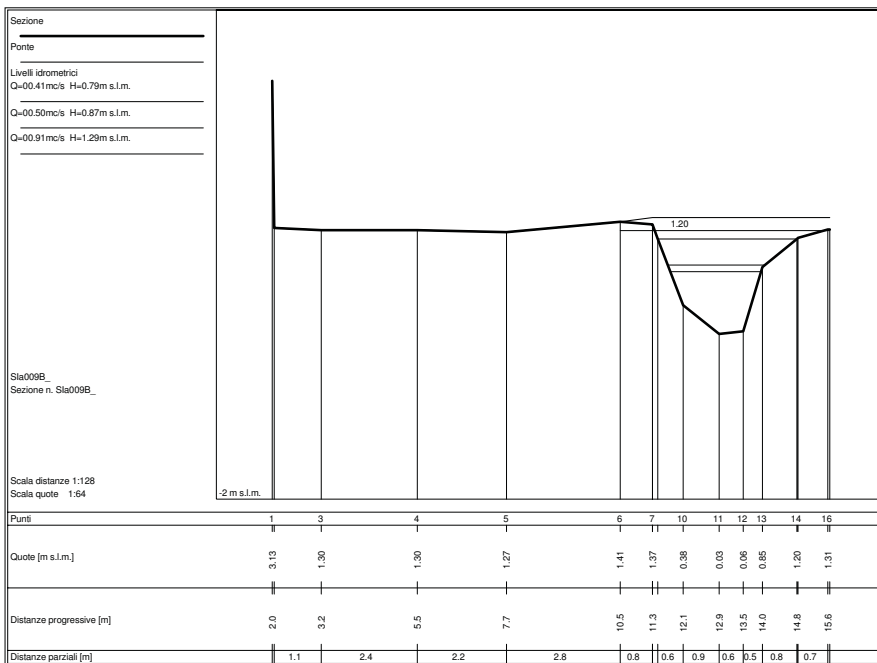
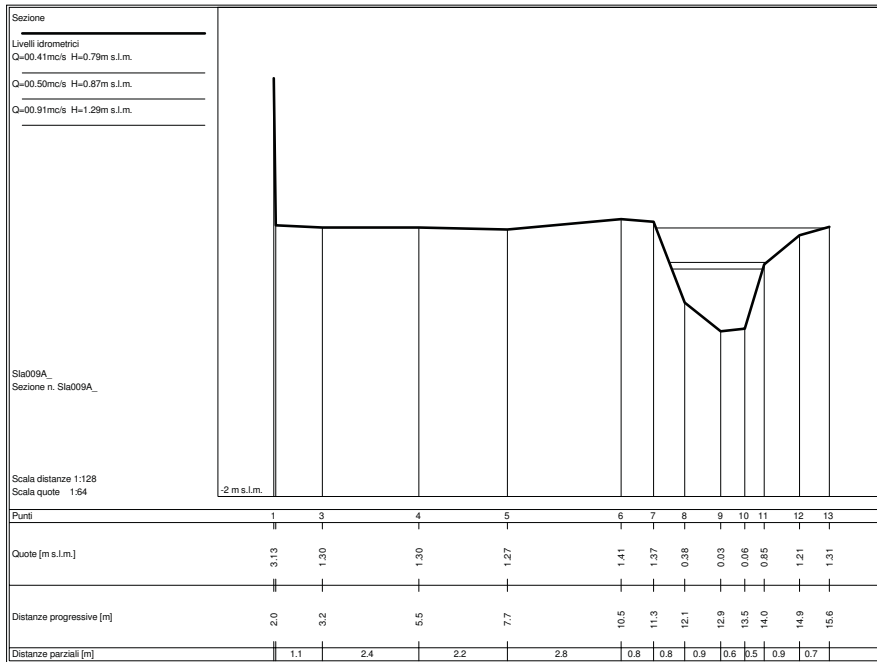



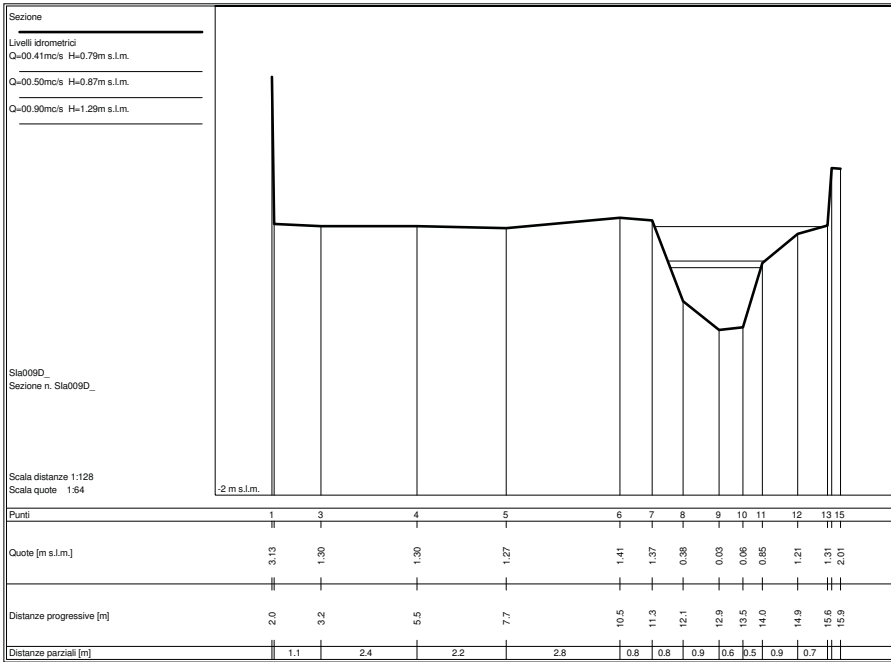
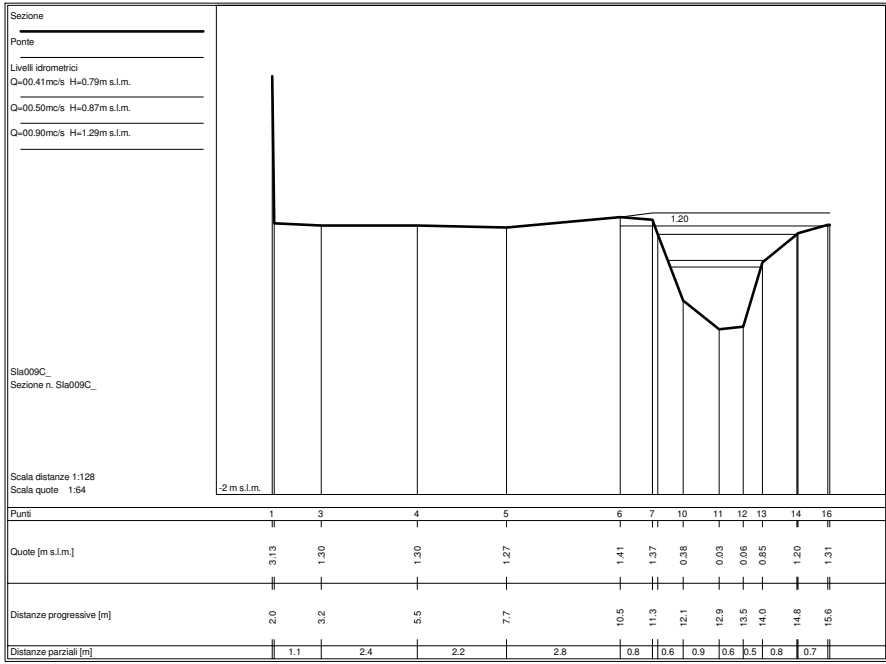

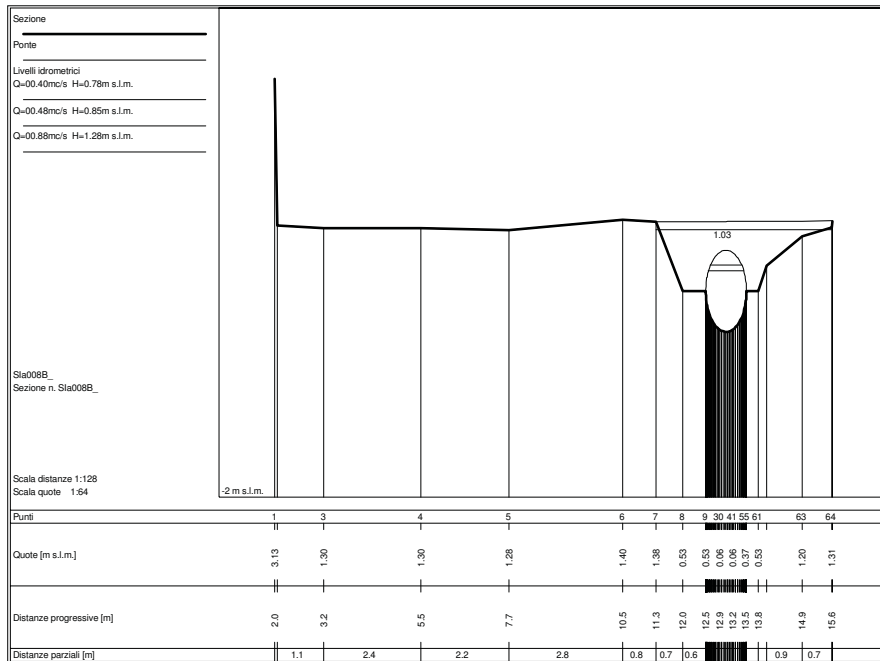
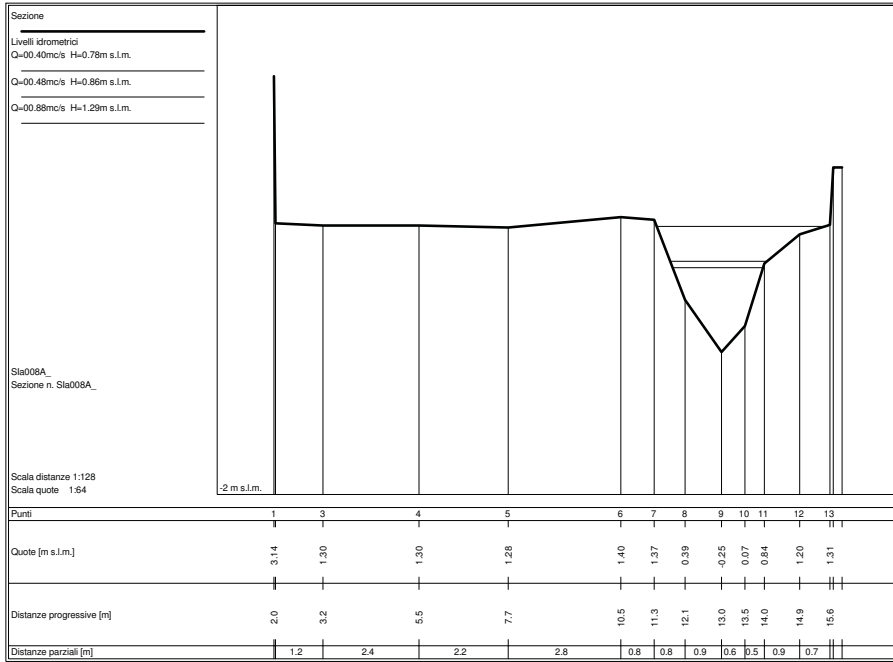

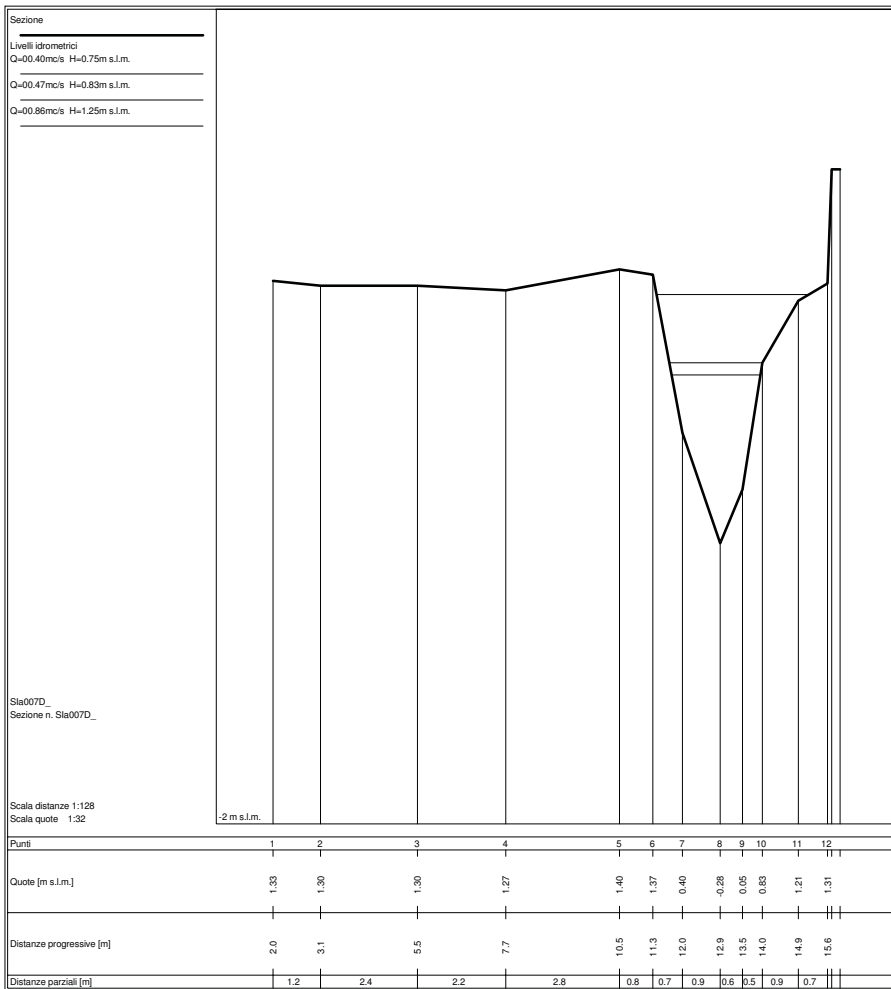
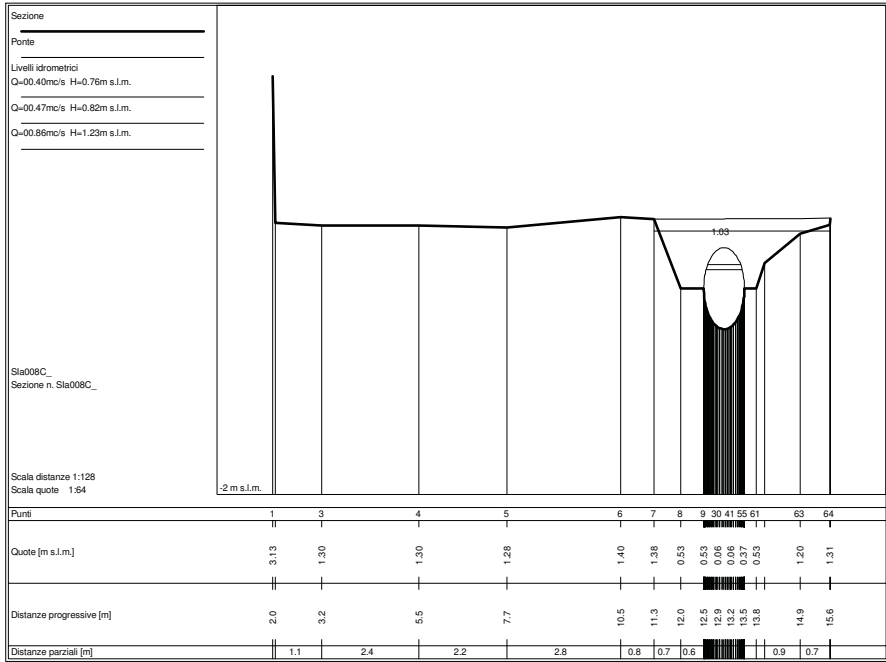

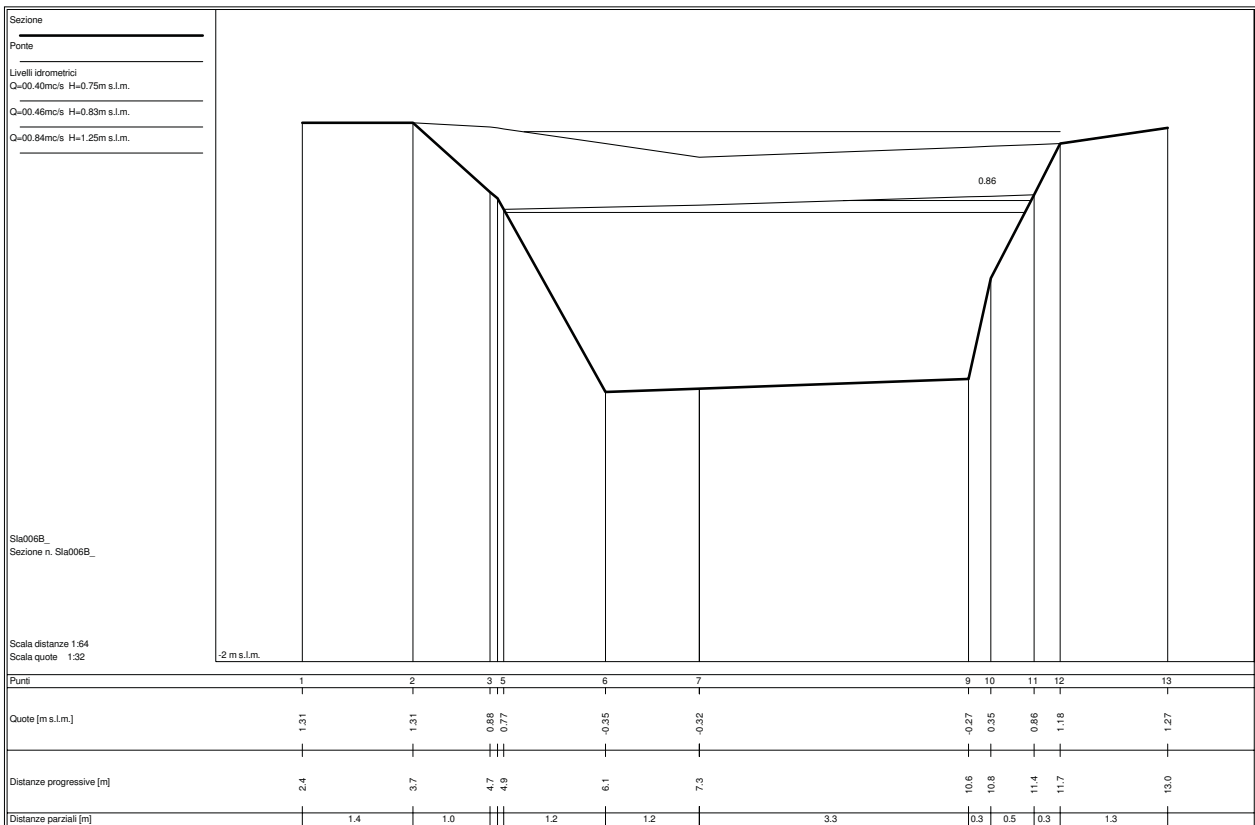
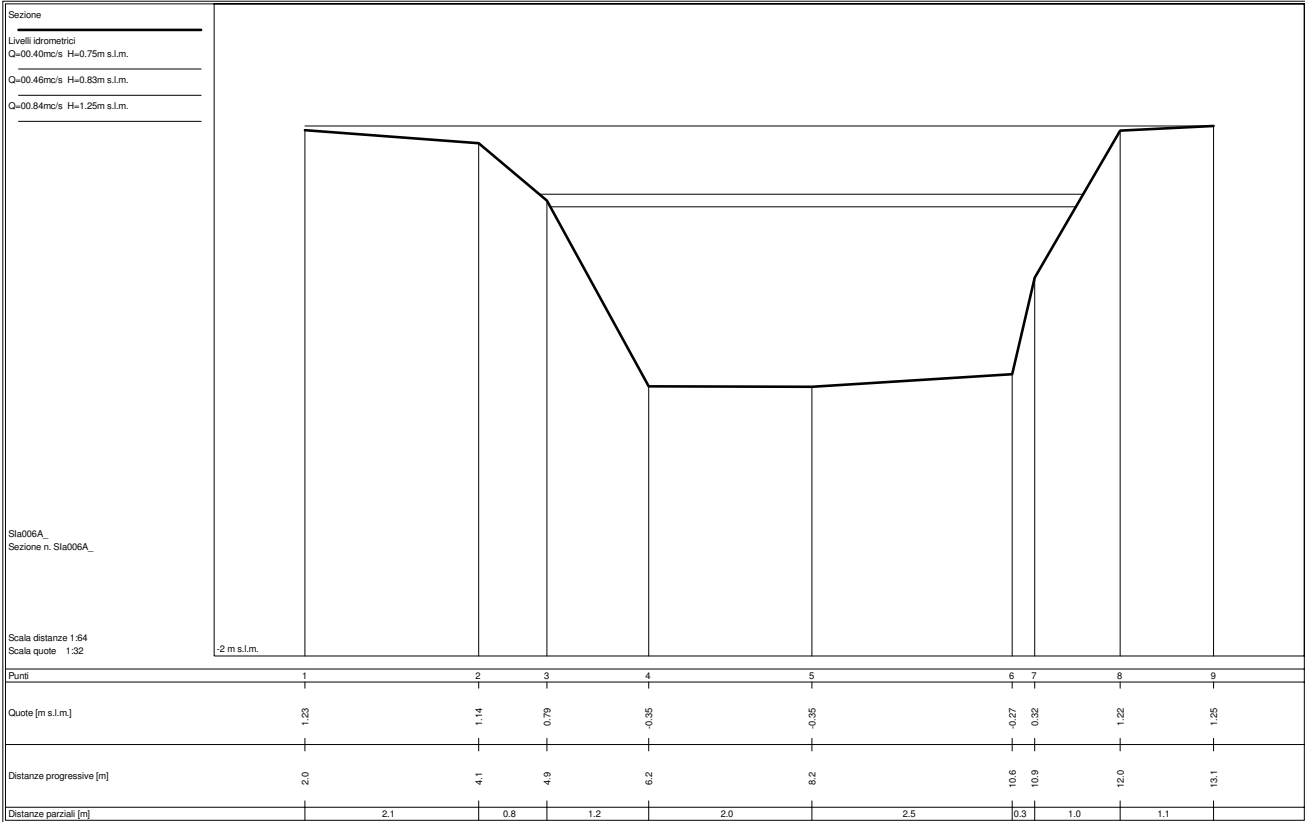

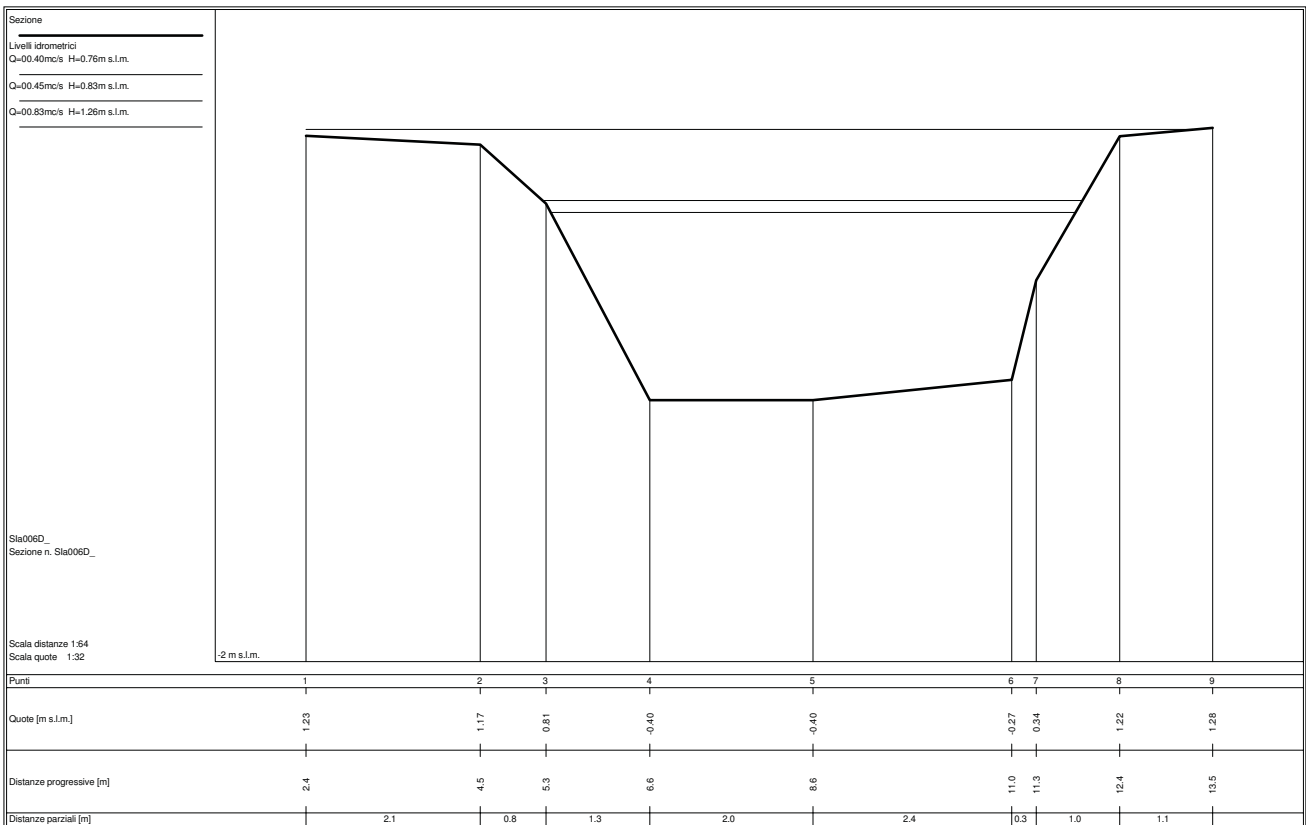
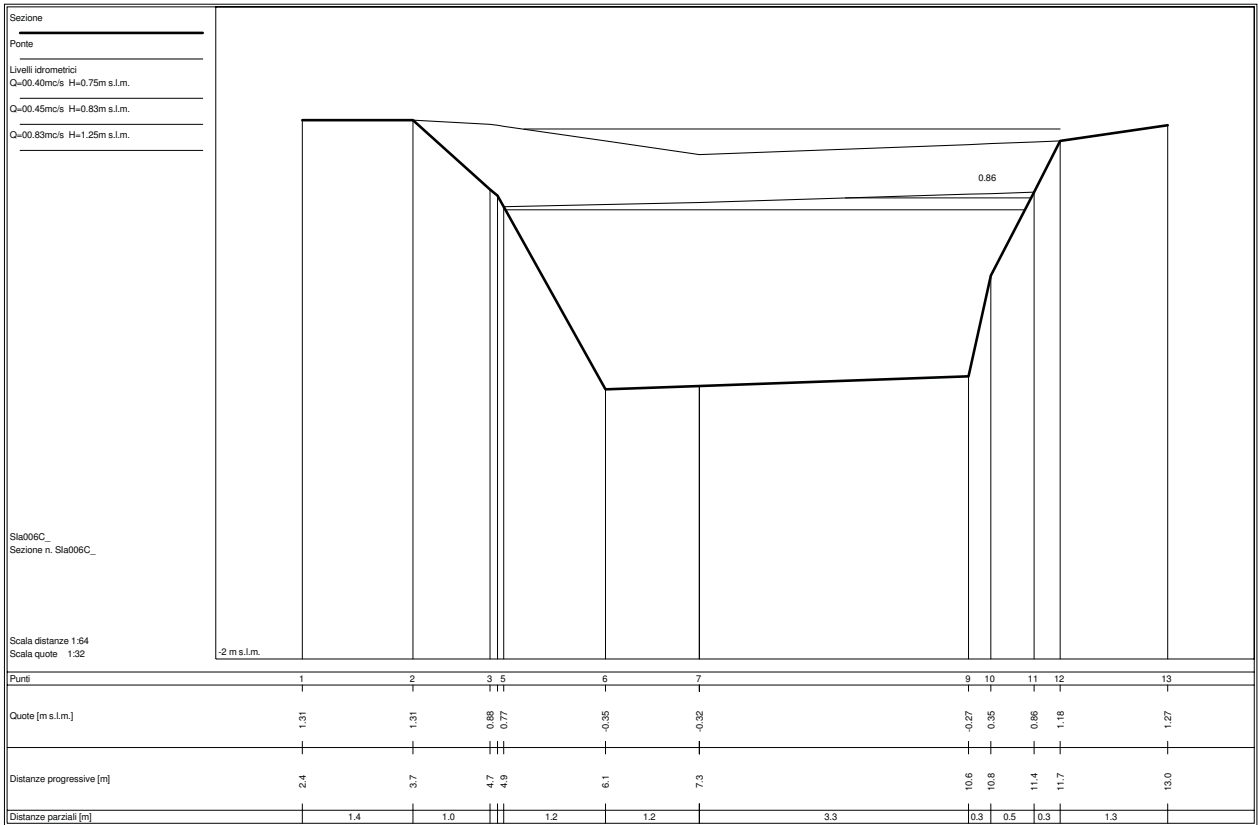

Sezione  
 Livelli idrometrici  
 Q=00.39mc/s H=0.76m s.l.m.  
 Q=00.45mc/s H=0.83m s.l.m.  
 Q=00.83mc/s H=1.25m s.l.m.

Sta005  
 Sezione n. Sta005

Scala distanze 1:64  
 Scala quote 1:32

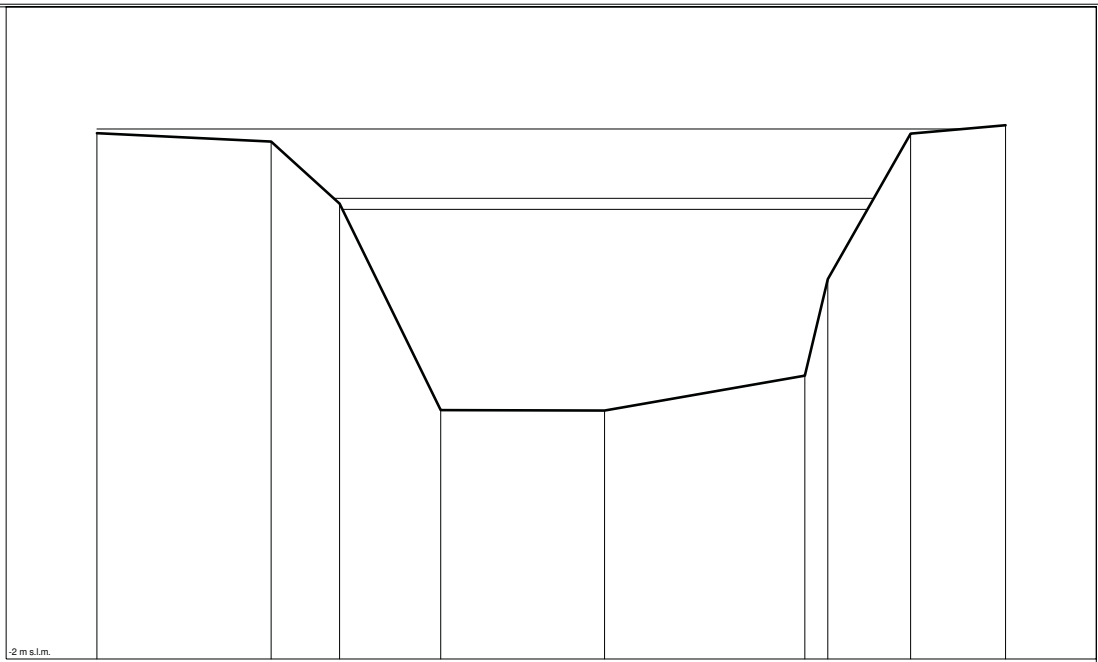

|                          |      |      |      |       |       |       |      |      |      |
|--------------------------|------|------|------|-------|-------|-------|------|------|------|
| Punti                    | 1    | 2    | 3    | 4     | 5     | 6     | 7    | 8    | 9    |
| Quote [m s.l.m.]         | 1.23 | 1.18 | 0.80 | -0.47 | -0.48 | -0.26 | 0.33 | 1.22 | 1.28 |
| Distanze progressive [m] | 2.4  | 4.5  | 5.4  | 6.6   | 8.6   | 11.1  | 11.3 | 12.4 | 13.5 |
| Distanze parziali [m]    |      | 2.1  | 0.8  | 1.2   | 2.0   | 2.5   | 0.3  | 1.0  | 1.2  |

Sezione  
 Livelli idrometrici  
 Q=00.39mc/s H=0.77m s.l.m.  
 Q=00.46mc/s H=0.83m s.l.m.  
 Q=00.85mc/s H=1.25m s.l.m.

Sta004A  
 Sezione n. Sta004A

Scala distanze 1:64  
 Scala quote 1:32

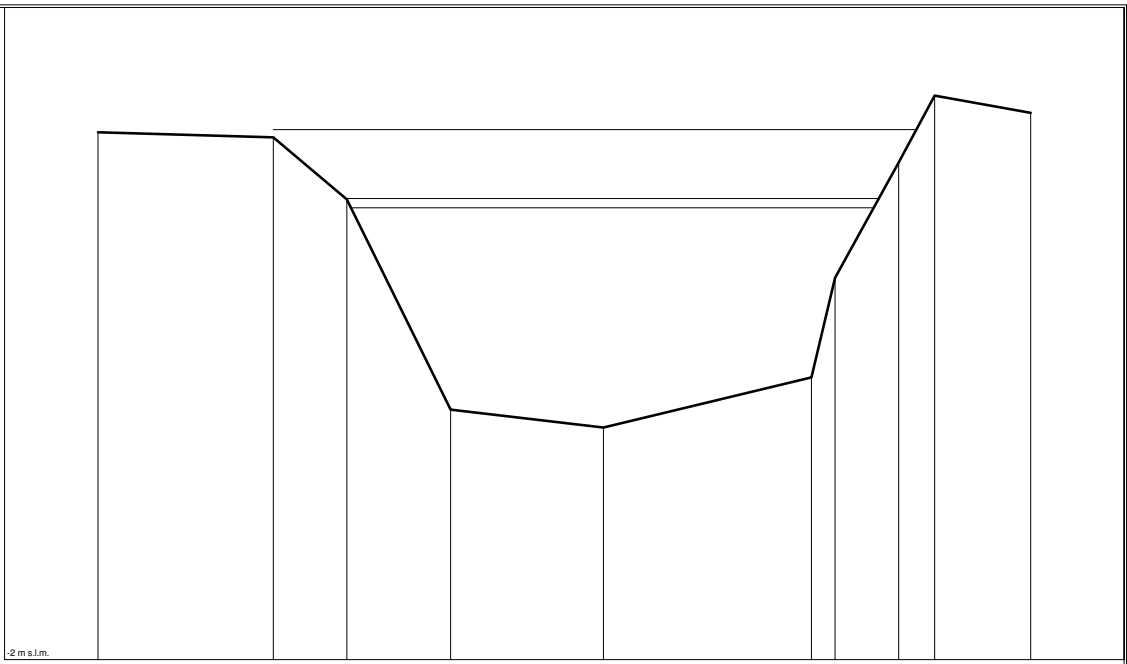

|                          |      |      |      |       |       |       |      |      |      |      |
|--------------------------|------|------|------|-------|-------|-------|------|------|------|------|
| Punti                    | 1    | 2    | 3    | 4     | 5     | 6     | 7    | 8    | 9    | 10   |
| Quote [m s.l.m.]         | 1.24 | 1.20 | 0.82 | -0.47 | -0.55 | -0.27 | 0.34 | 1.05 | 1.46 | 1.35 |
| Distanze progressive [m] | 2.4  | 4.5  | 5.4  | 6.7   | 8.6   | 11.1  | 11.4 | 12.2 | 12.6 | 13.8 |
| Distanze parziali [m]    |      | 2.2  | 0.9  | 1.3   | 1.9   | 2.6   | 0.3  | 0.8  | 0.4  | 1.2  |

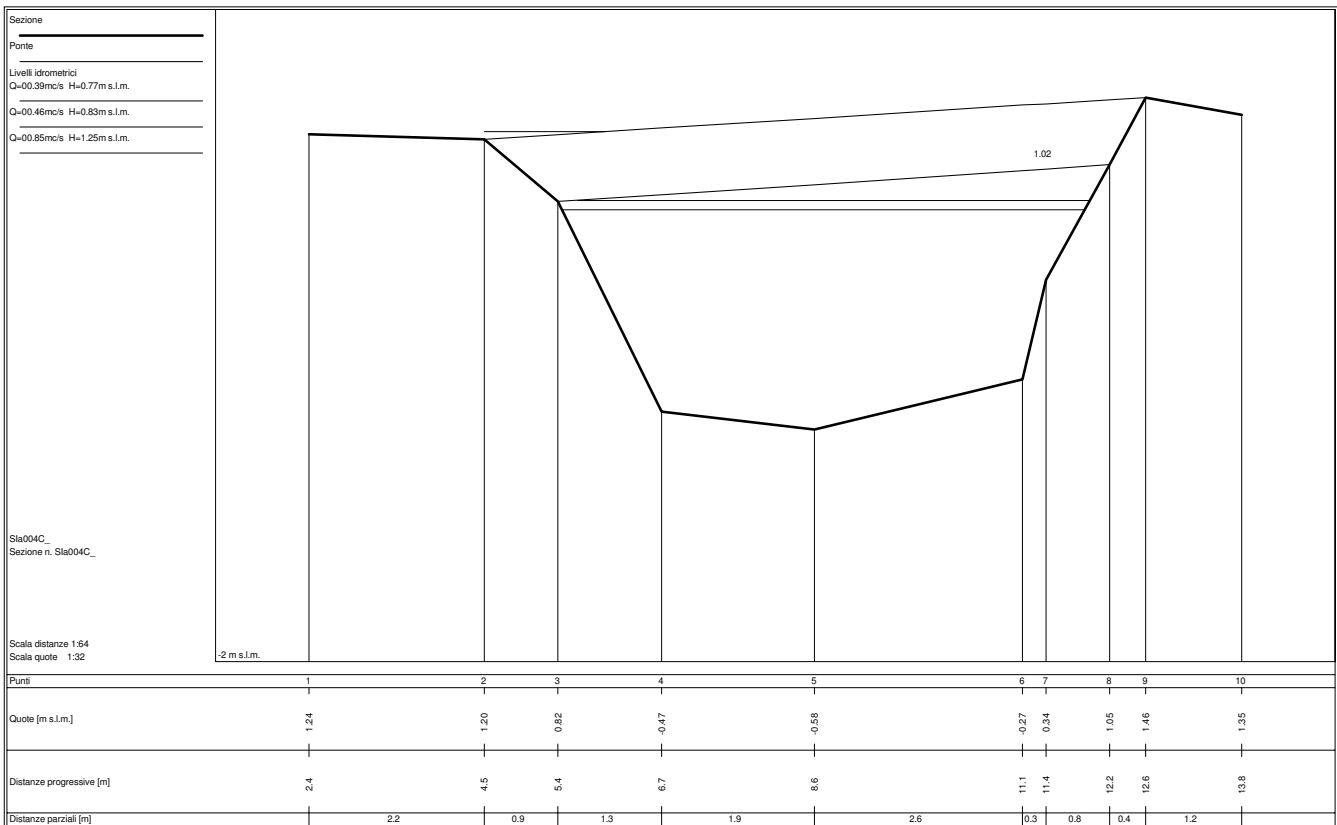
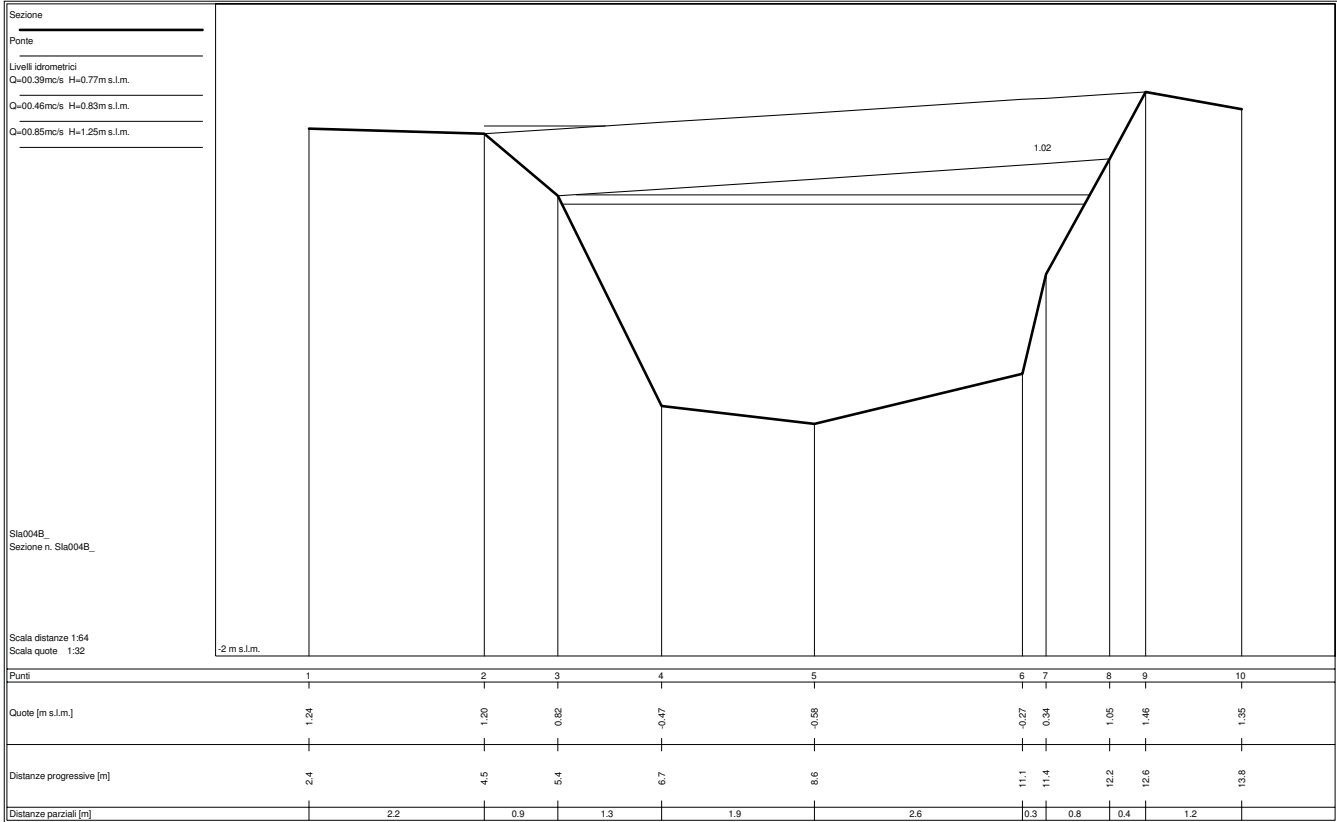

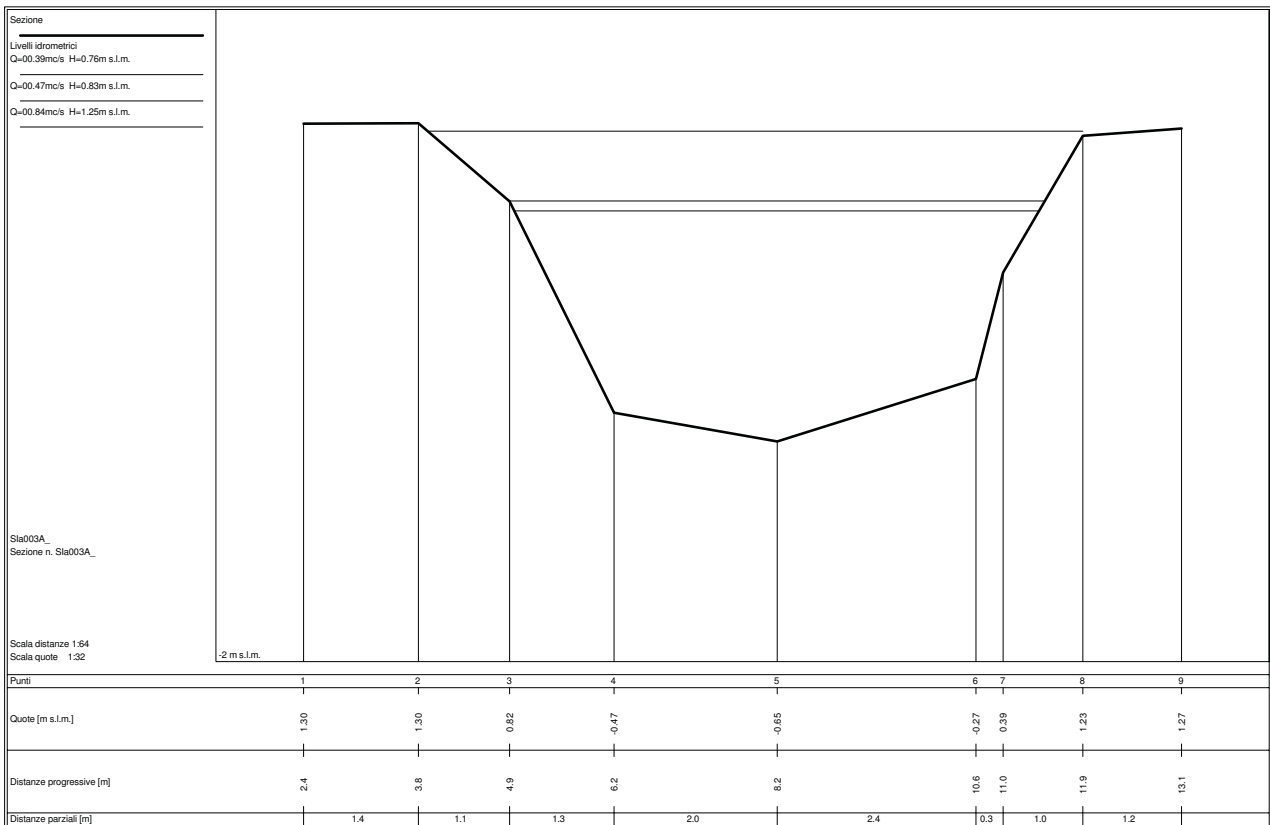
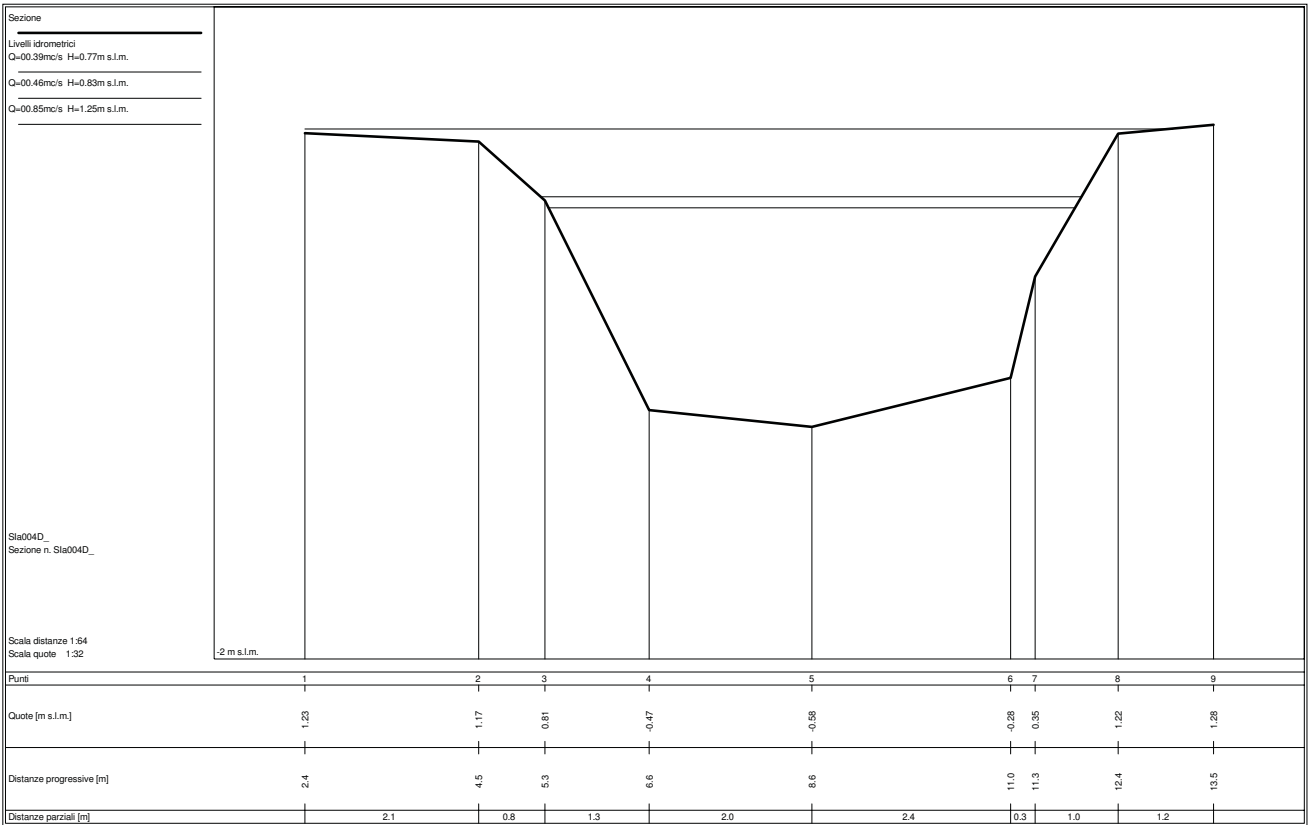



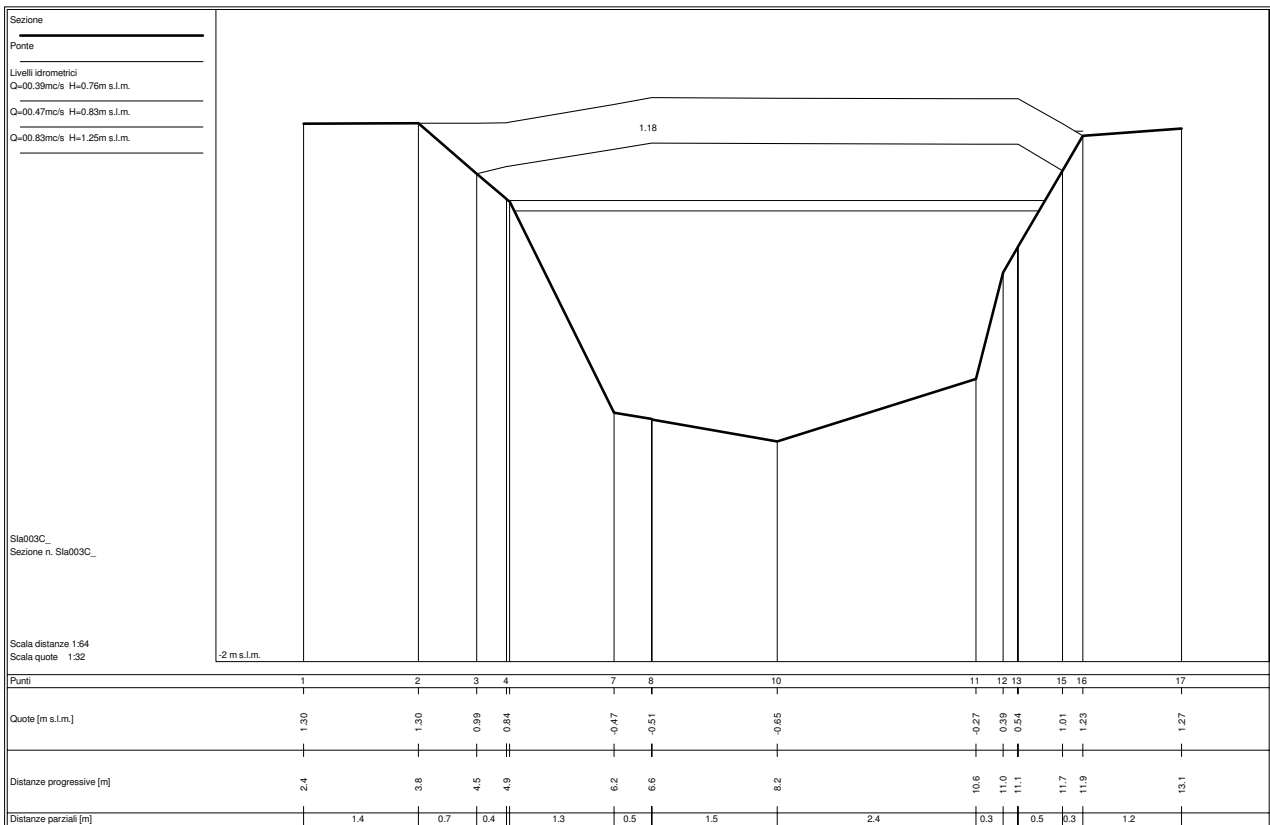
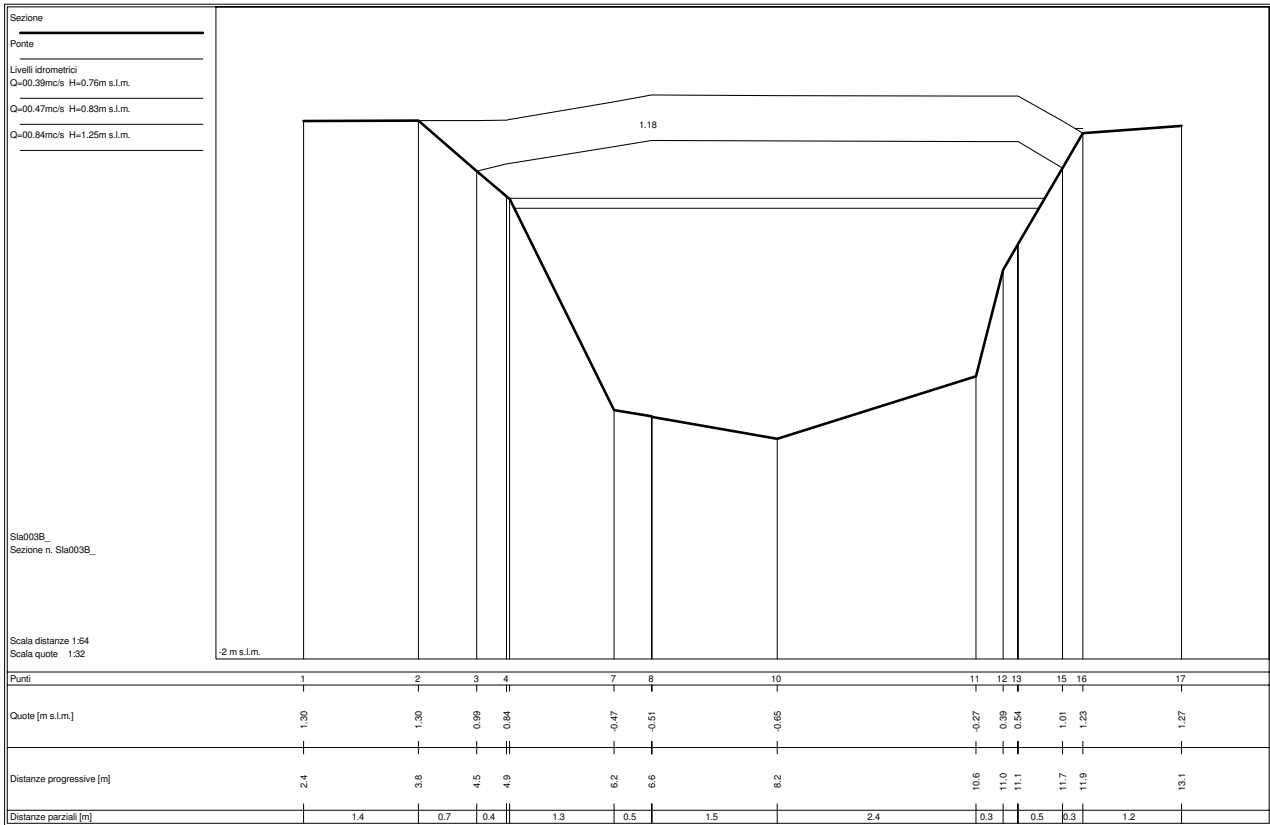

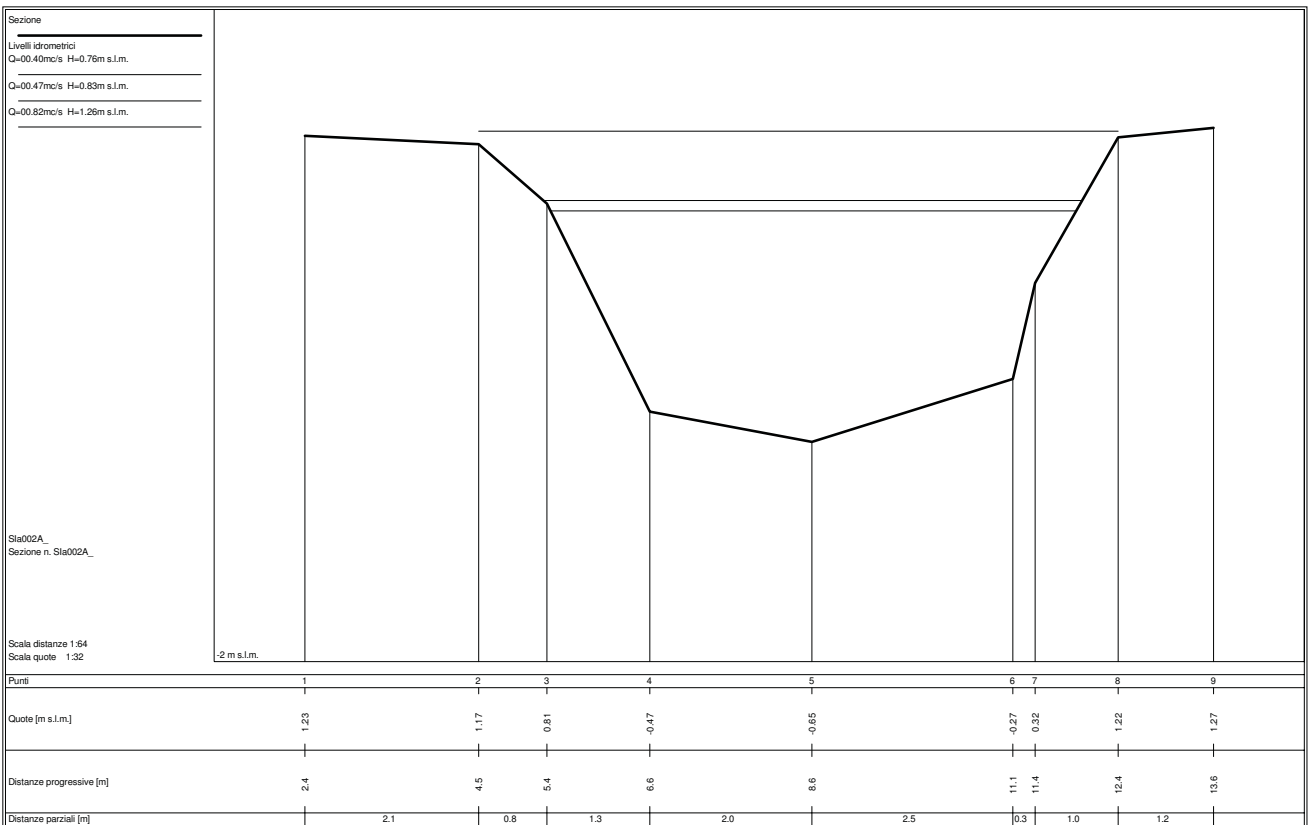
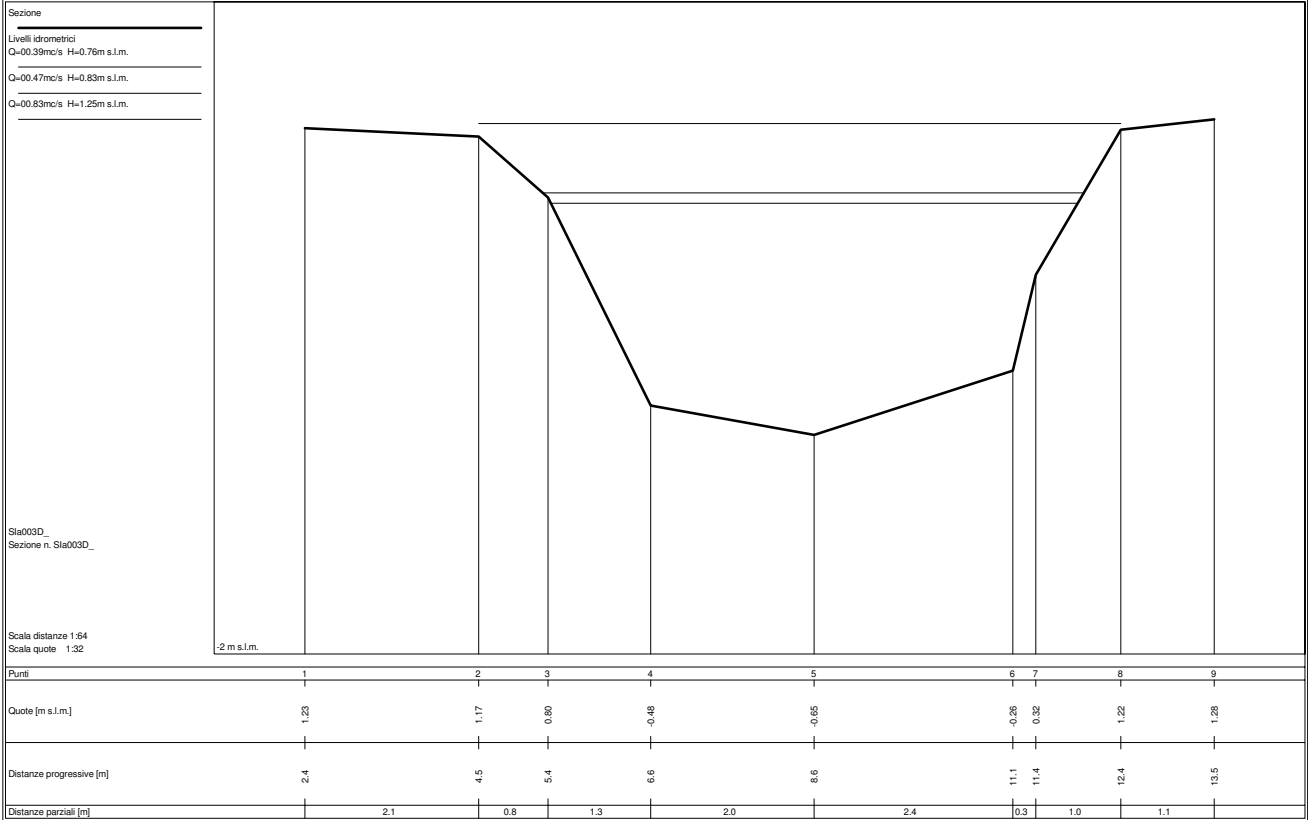

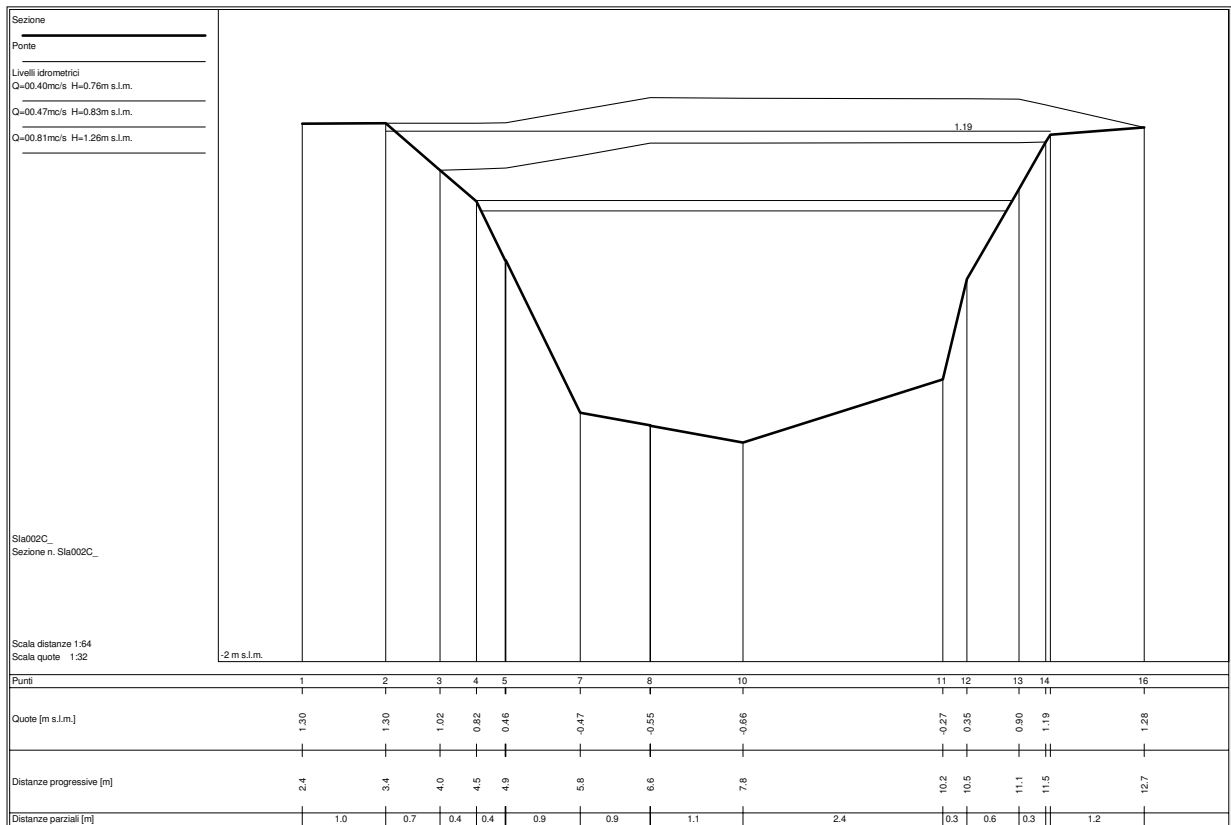
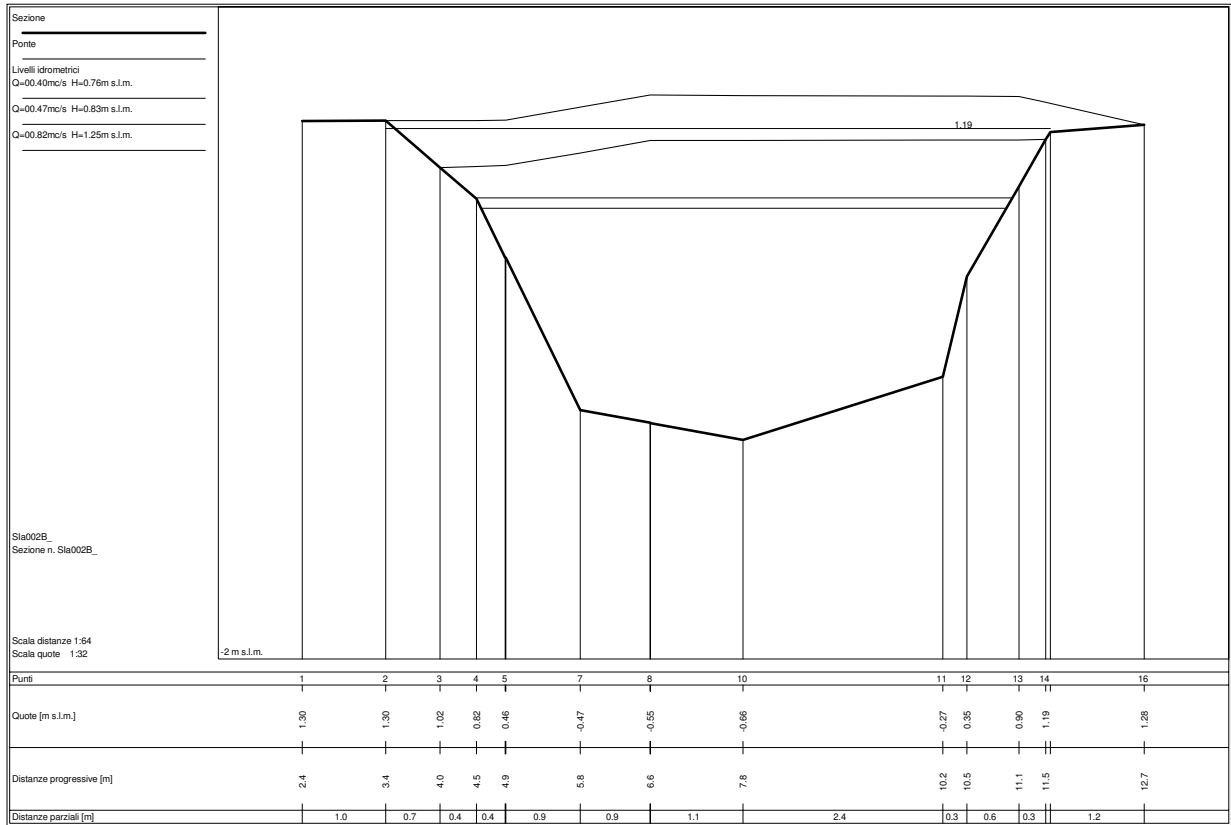

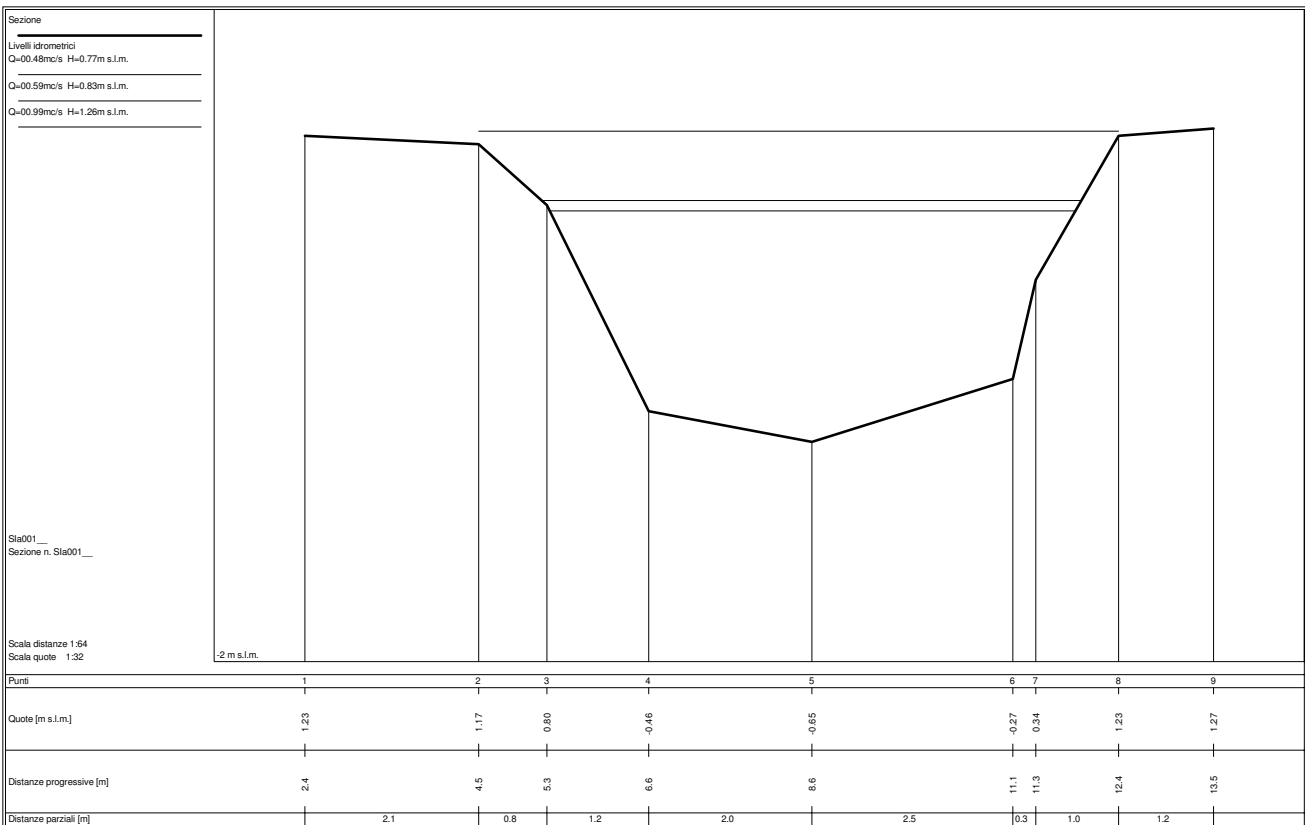
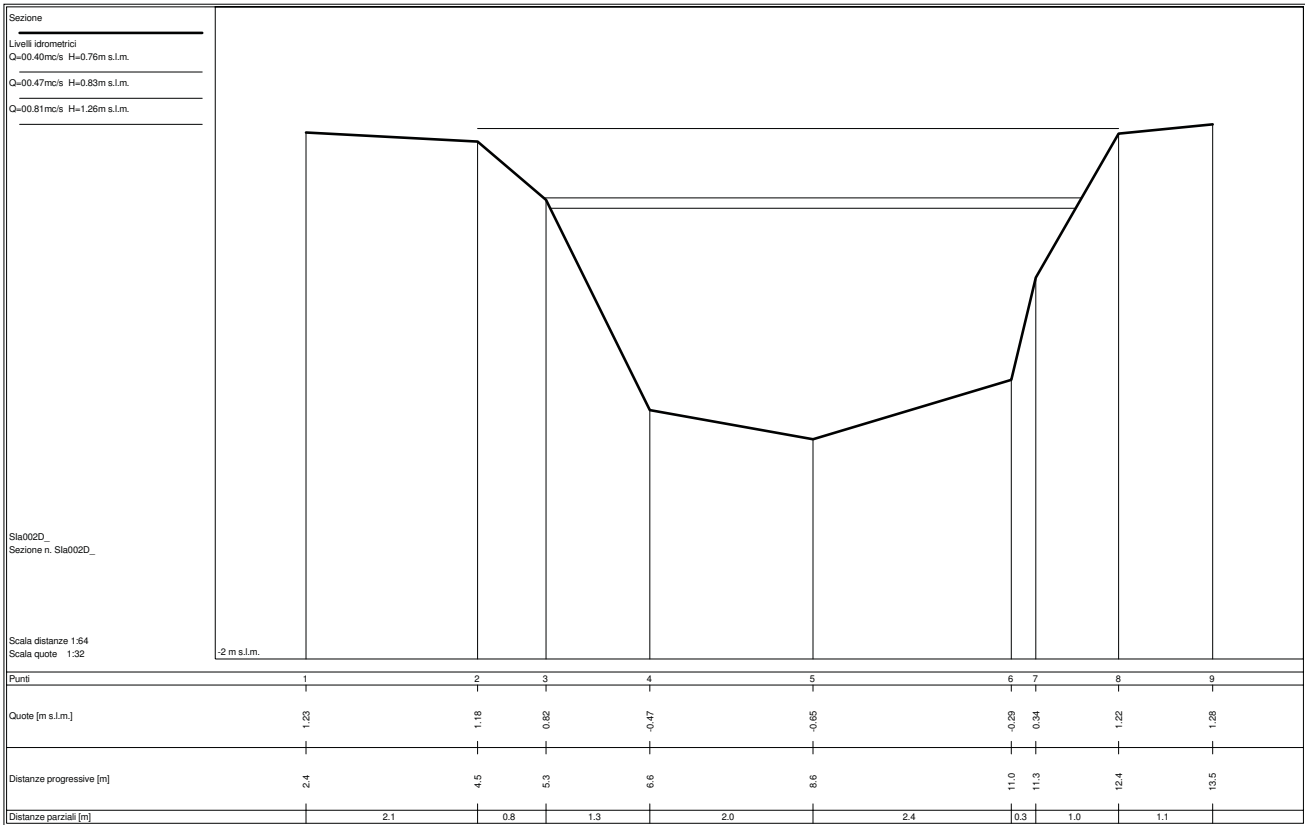

## **FOSSO SILCIA – RAMO B**

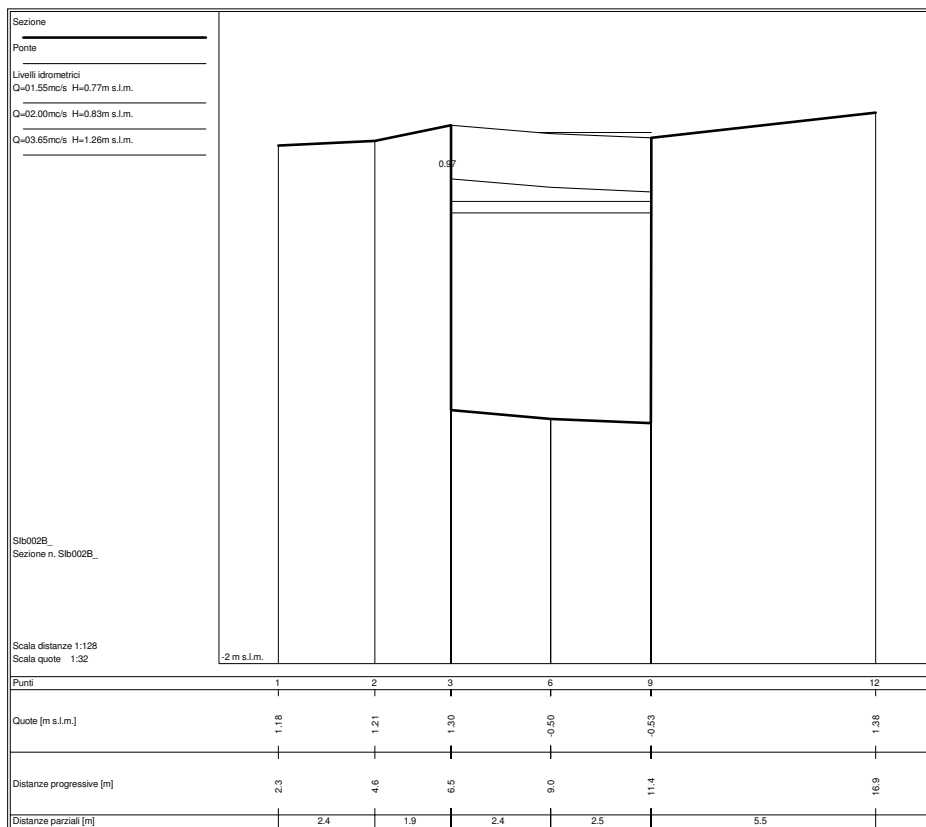
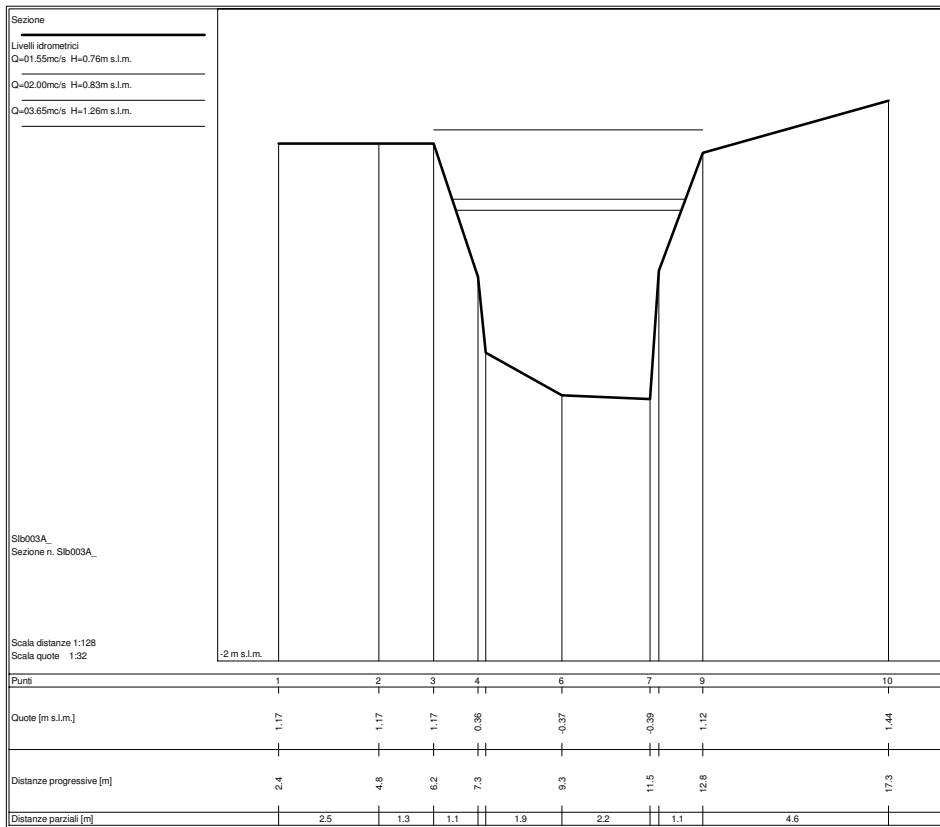

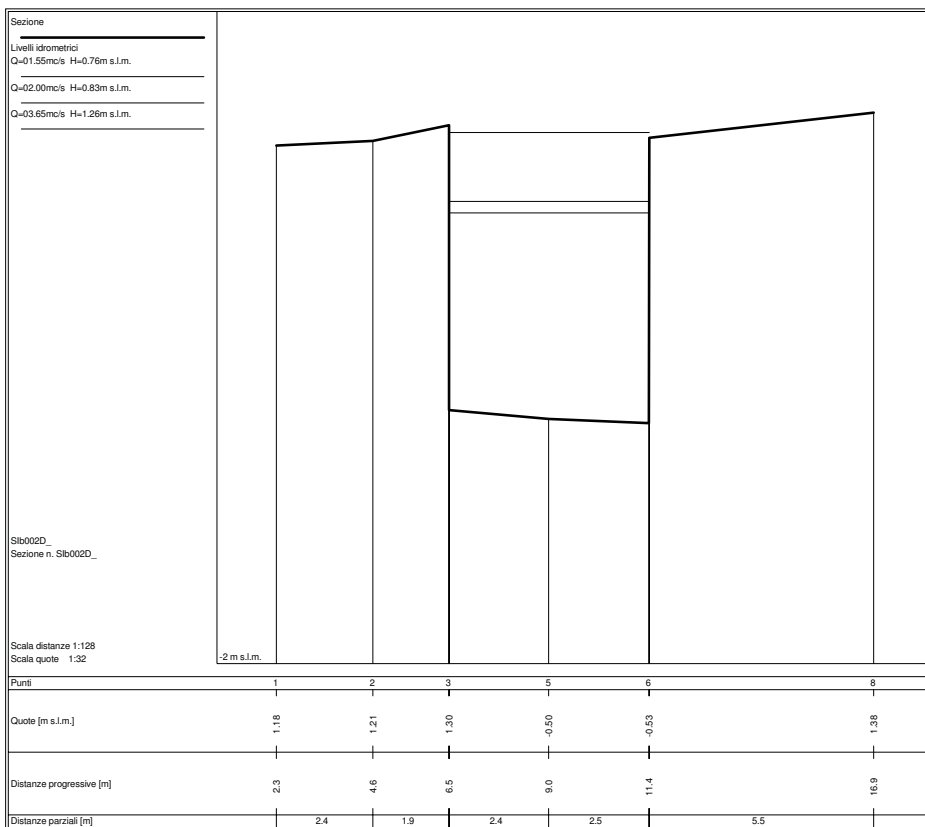
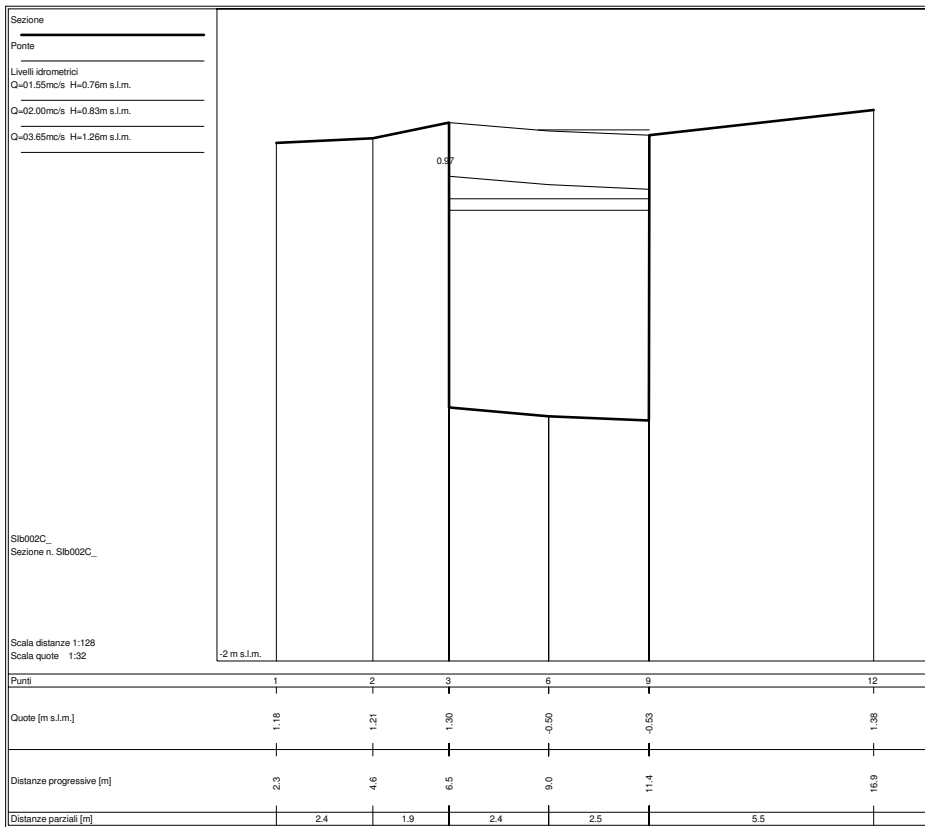

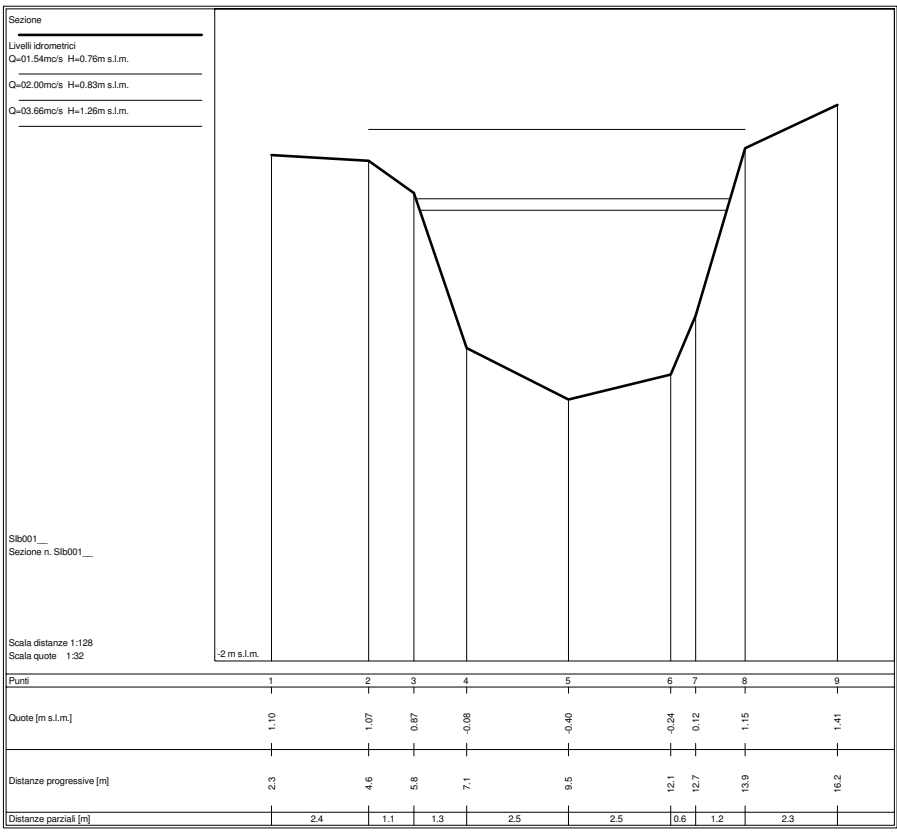



## **FOSSO SILCIA – RAMO C**

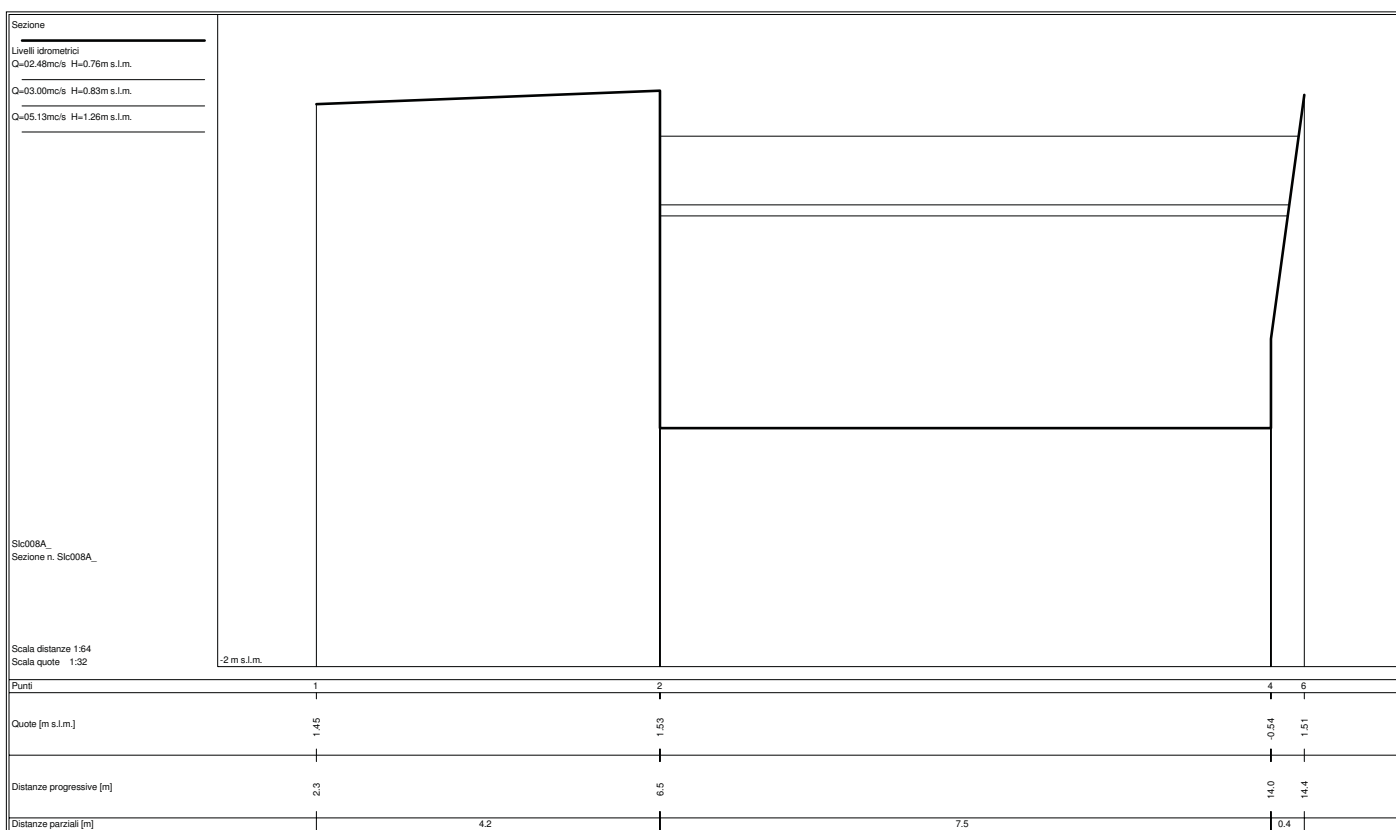
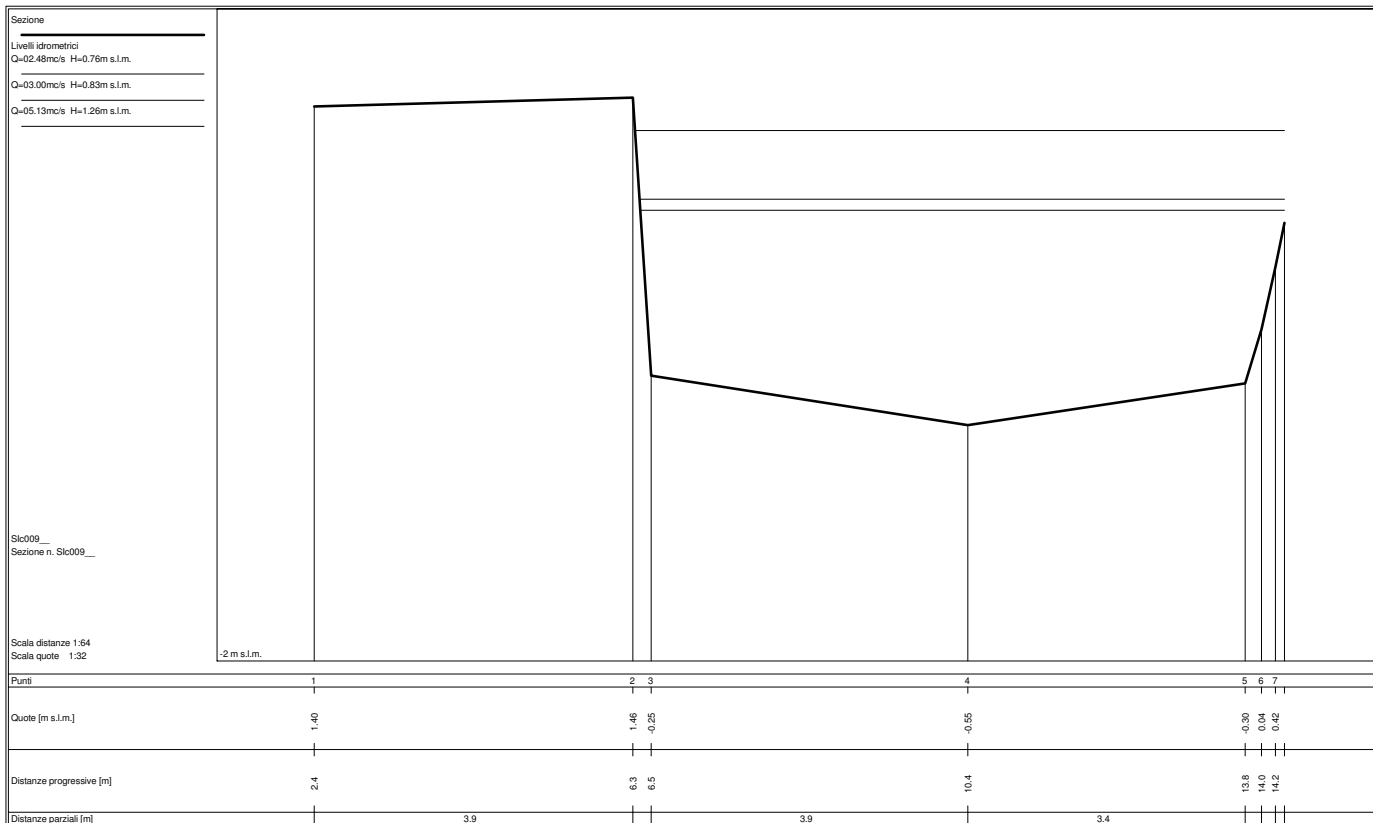

Sezione  
 Ponte  
 Livelli idrometrici  
 Q=02.48mc/s H=0.74m s.l.m.  
 Q=03.00mc/s H=0.81m s.l.m.  
 Q=05.12mc/s H=1.18m s.l.m.

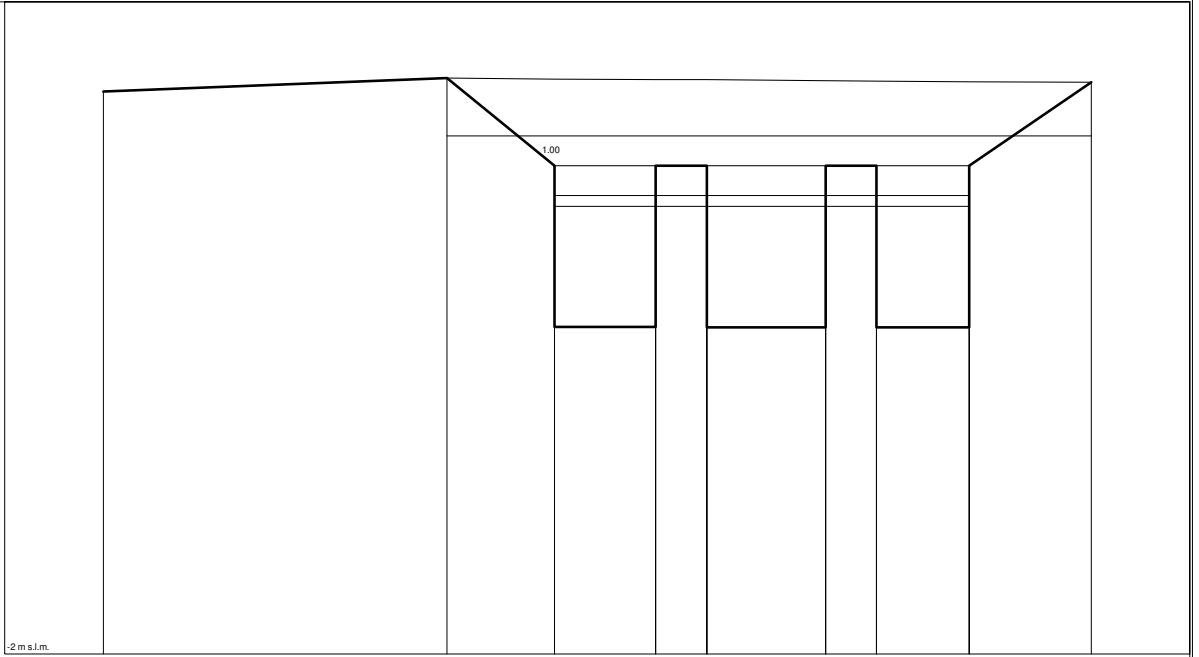

Slc008B\_  
 Sezione n. Slc008B\_

Scala distanze 1:64  
 Scala quote 1:32

|                          |      |      |      |      |      |      |      |      |      |
|--------------------------|------|------|------|------|------|------|------|------|------|
| Punti                    | 1    | 2    | 3    | 5    | 7    | 9    | 11   | 13   | 15   |
| Quote [m s.l.m.]         | 1.45 | 1.53 | 0.99 | 0.01 | 1.00 | 0.00 | 1.00 | 0.00 | 1.51 |
| Distanze progressive [m] | 2.3  | 6.5  | 7.8  | 9.1  | 9.7  | 11.2 | 11.8 | 12.9 | 14.4 |
| Distanze parziali [m]    |      | 4.2  | 1.3  | 1.2  | 0.6  | 1.5  | 0.6  | 1.1  | 1.5  |

Sezione  
 Ponte  
 Livelli idrometrici  
 Q=02.48mc/s H=0.74m s.l.m.  
 Q=03.00mc/s H=0.80m s.l.m.  
 Q=05.12mc/s H=1.14m s.l.m.

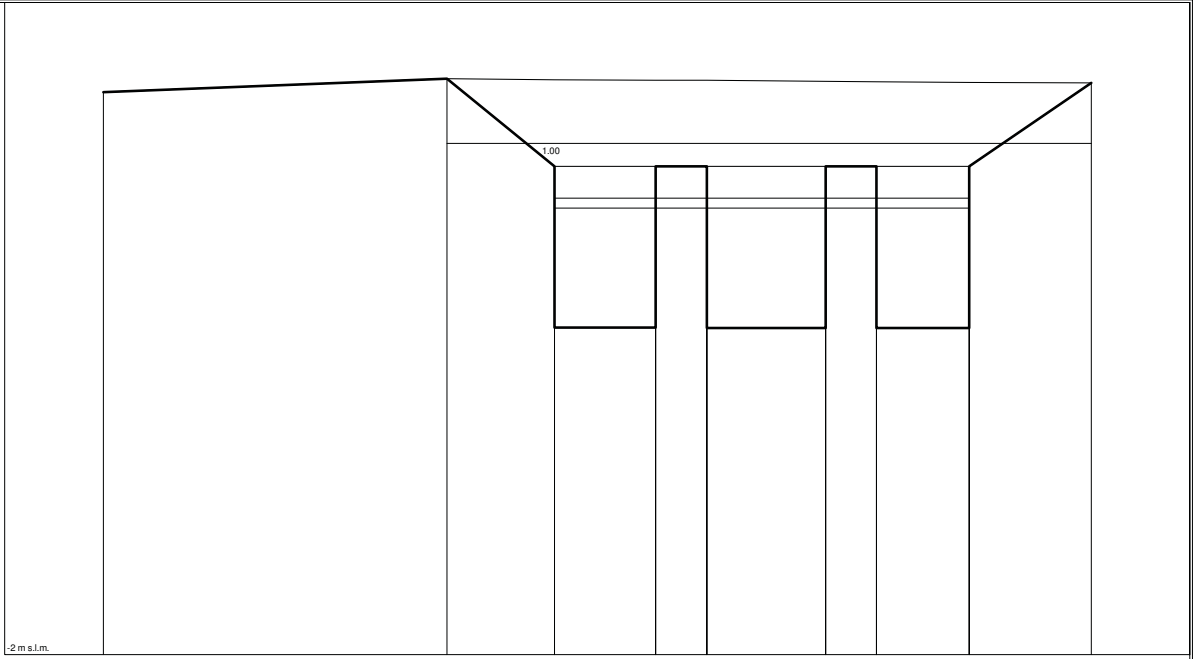

Slc008C\_  
 Sezione n. Slc008C\_

Scala distanze 1:64  
 Scala quote 1:32

|                          |      |      |      |      |      |      |      |      |      |
|--------------------------|------|------|------|------|------|------|------|------|------|
| Punti                    | 1    | 2    | 3    | 5    | 7    | 9    | 11   | 13   | 15   |
| Quote [m s.l.m.]         | 1.45 | 1.53 | 0.99 | 0.01 | 1.00 | 0.00 | 1.00 | 0.00 | 1.51 |
| Distanze progressive [m] | 2.3  | 6.5  | 7.8  | 9.1  | 9.7  | 11.2 | 11.8 | 12.9 | 14.4 |
| Distanze parziali [m]    |      | 4.2  | 1.3  | 1.2  | 0.6  | 1.5  | 0.6  | 1.1  | 1.5  |

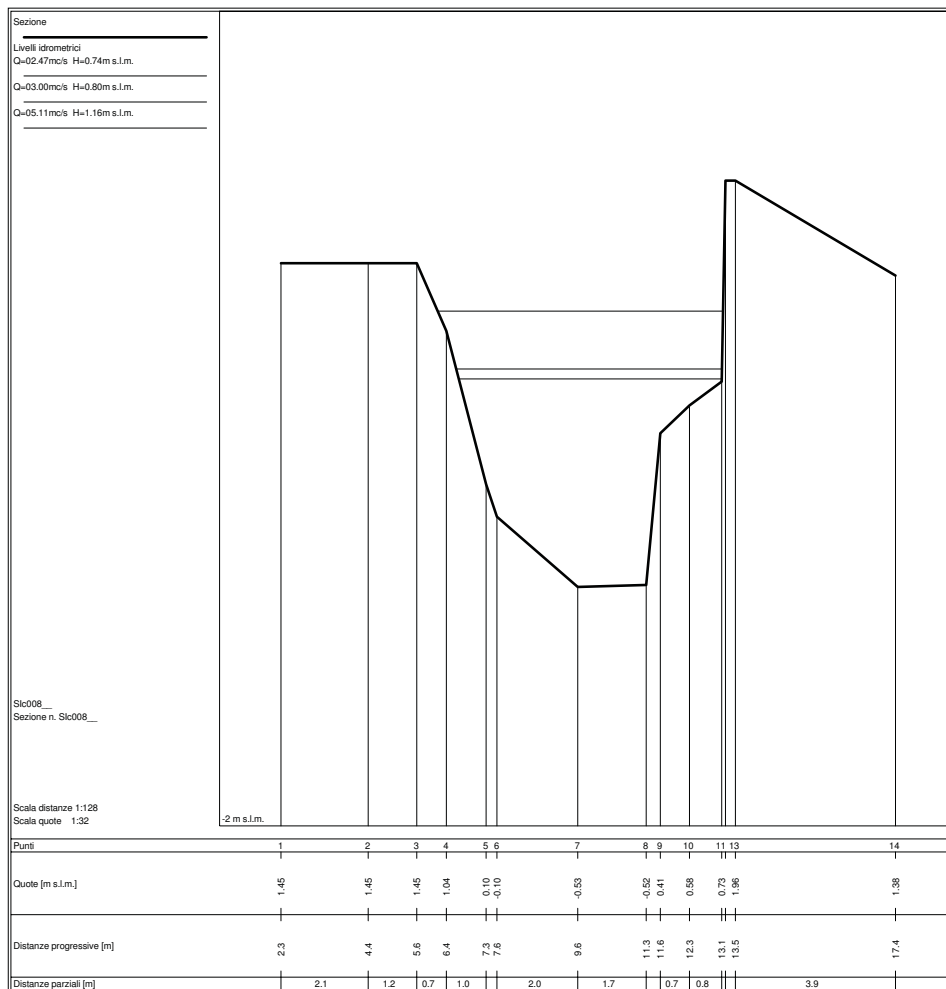
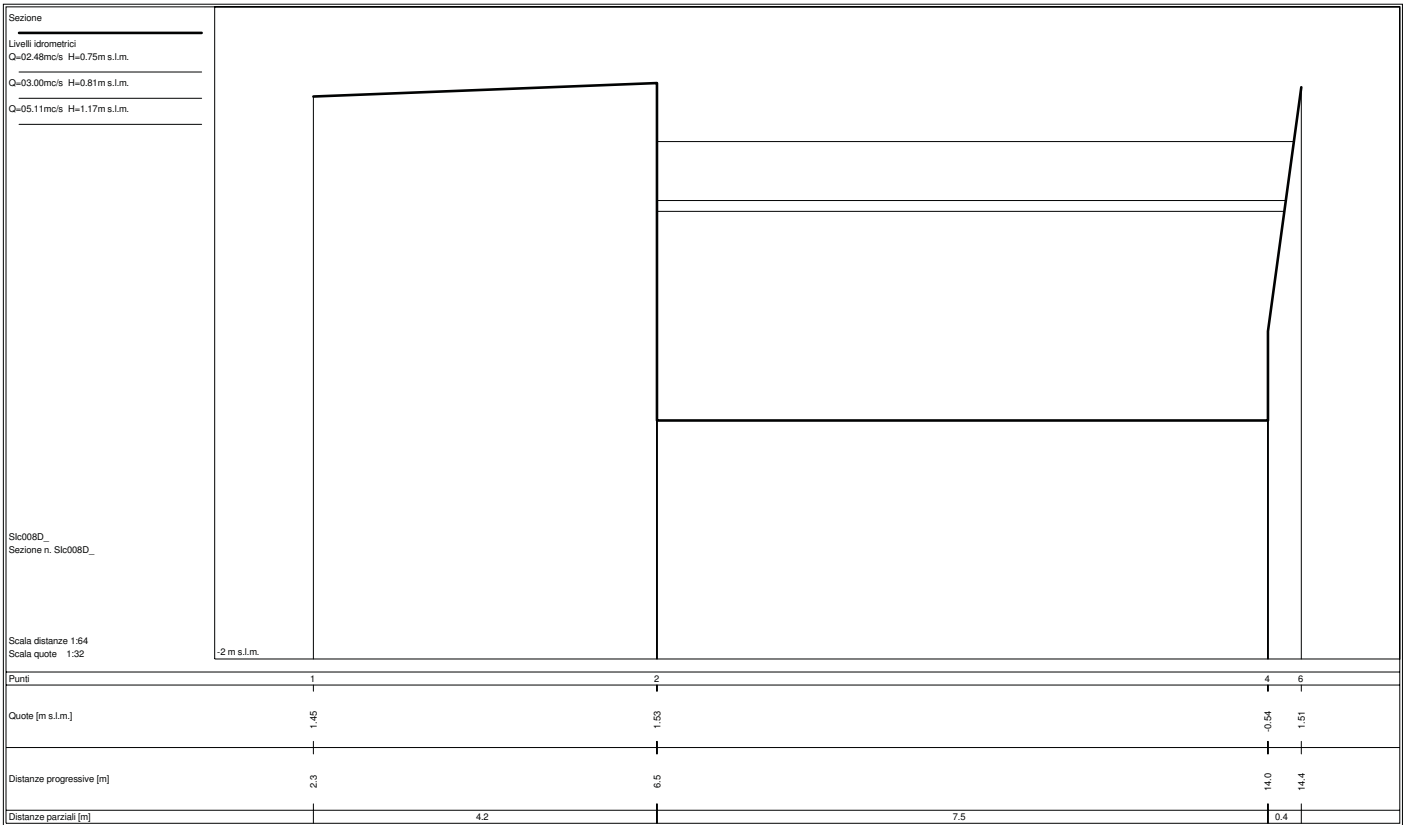

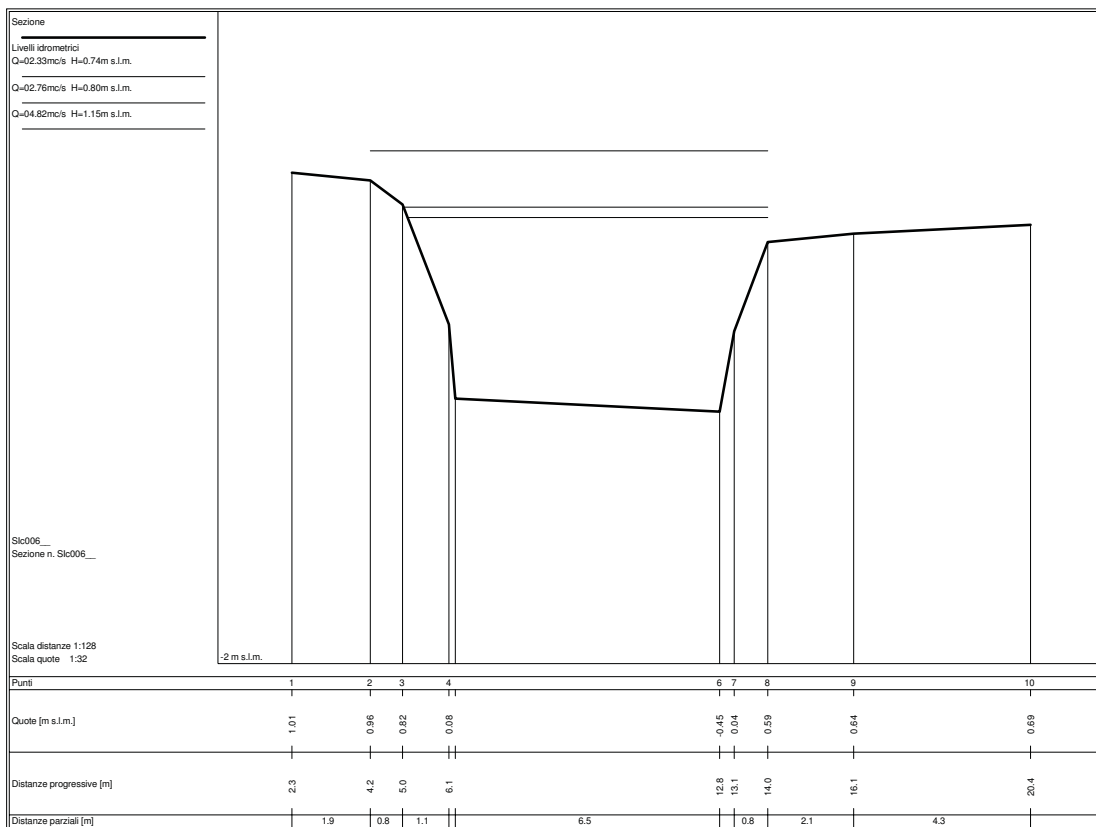
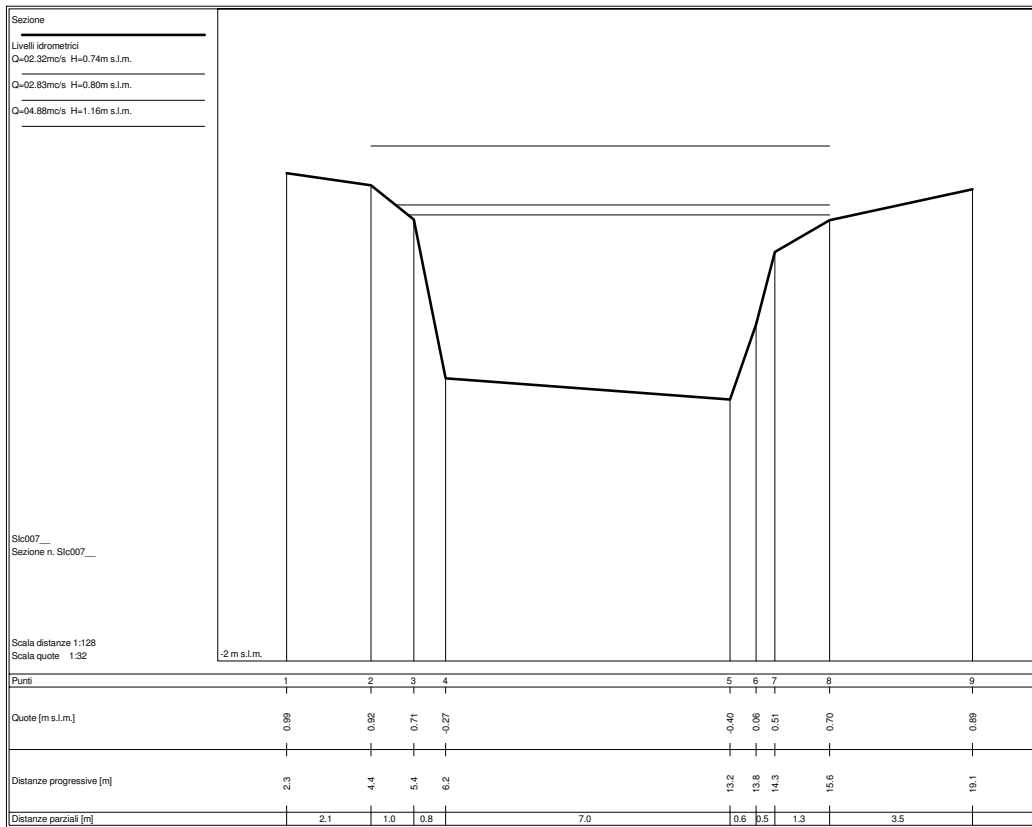

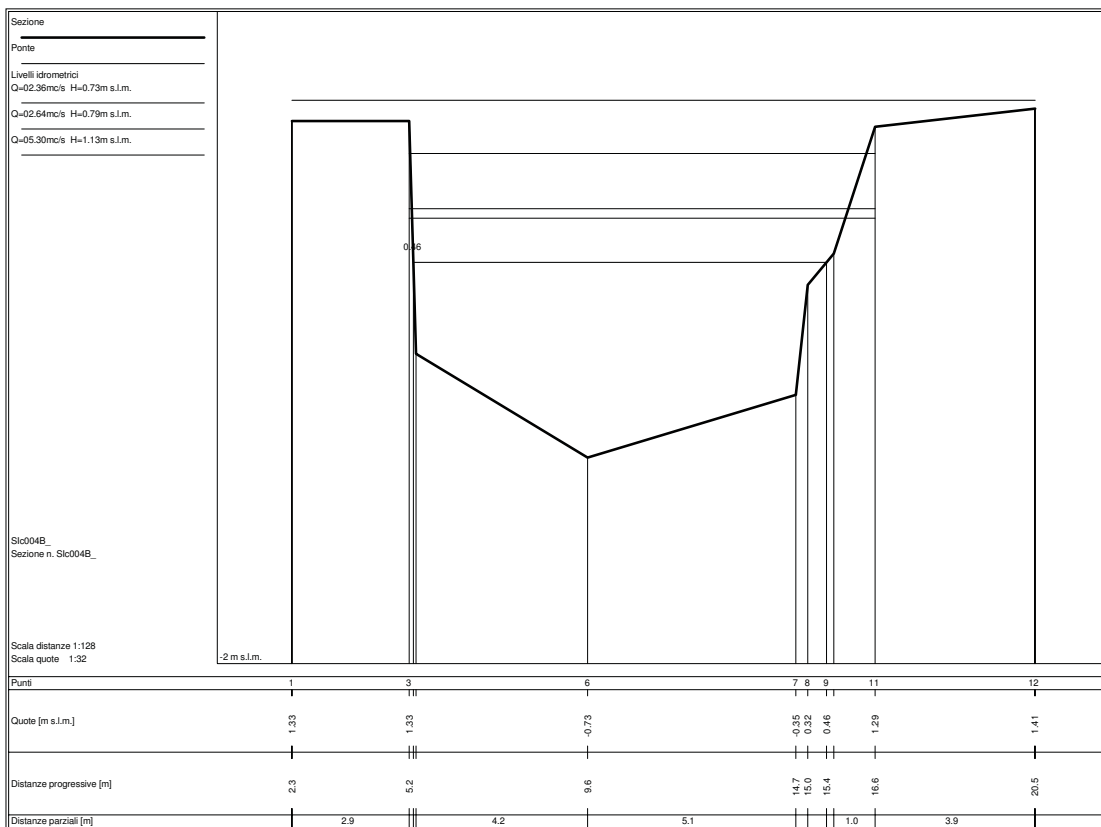
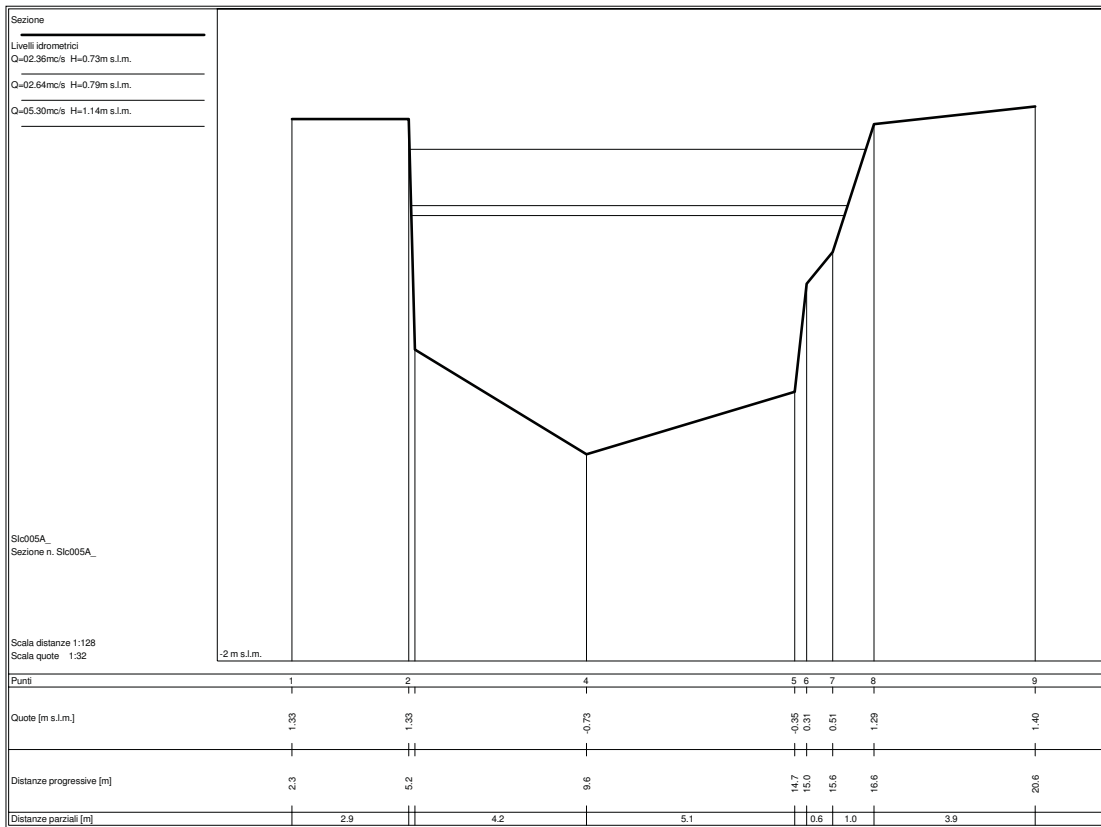

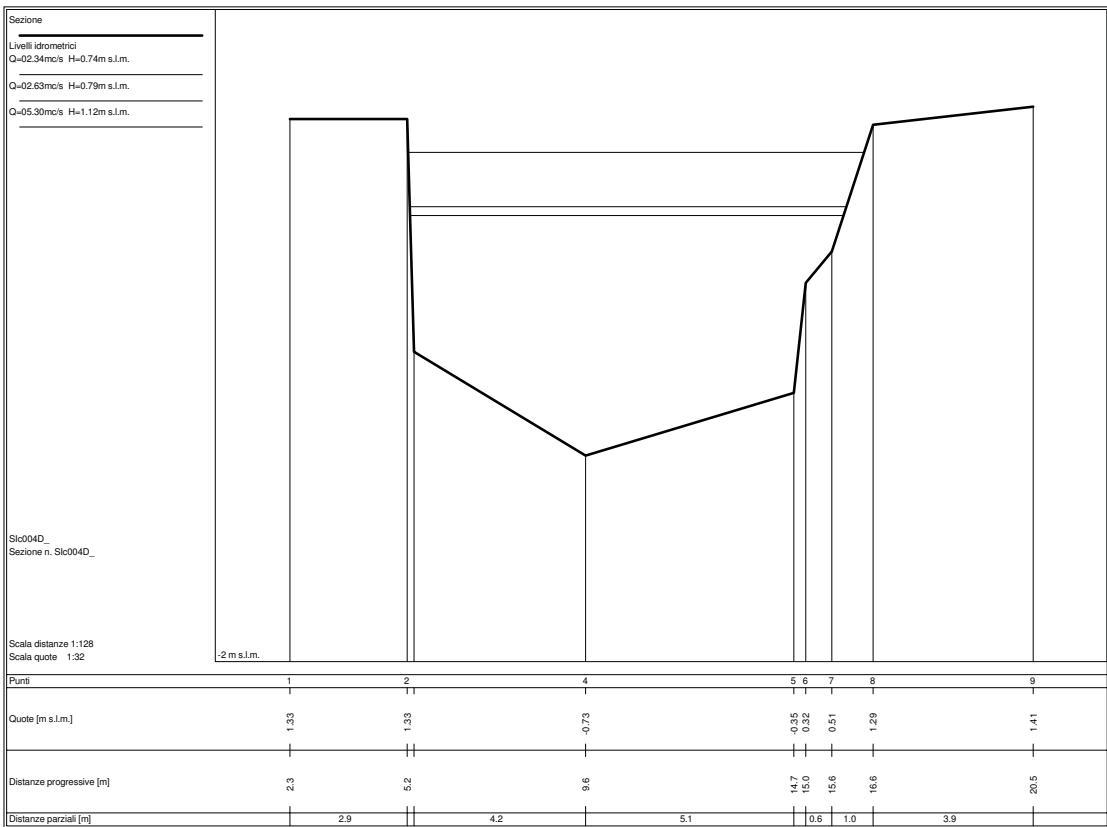
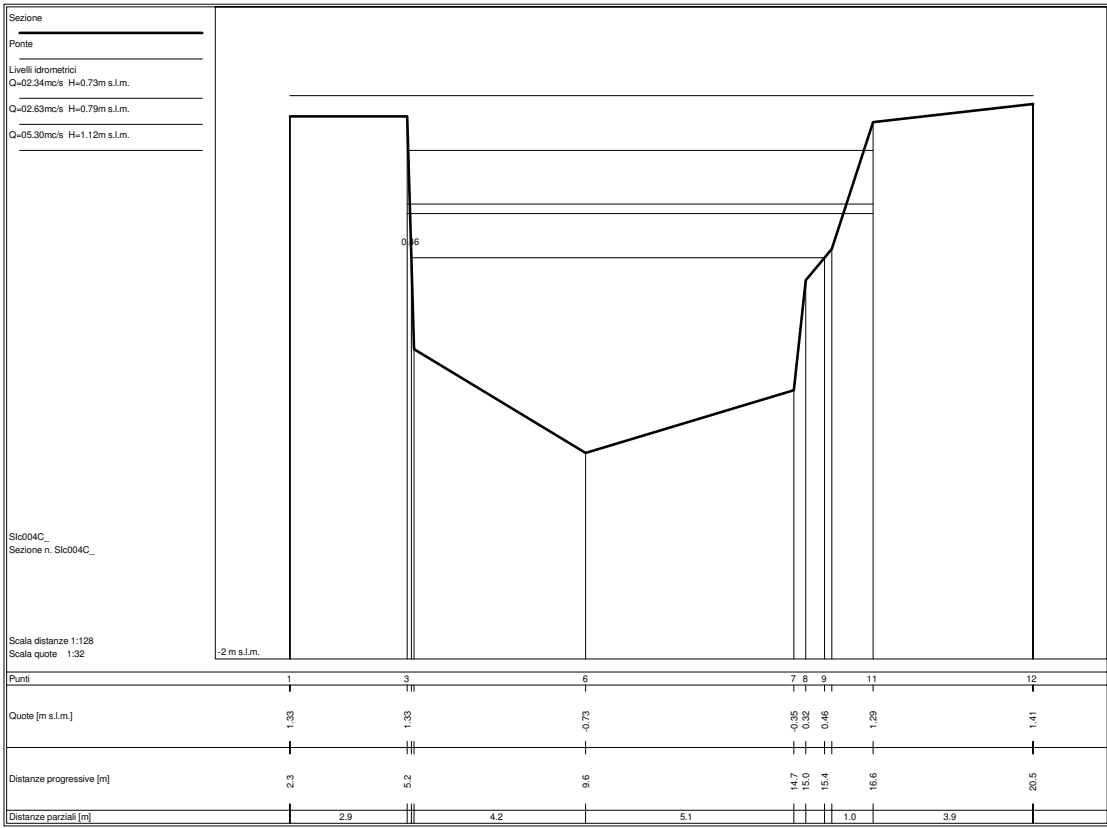

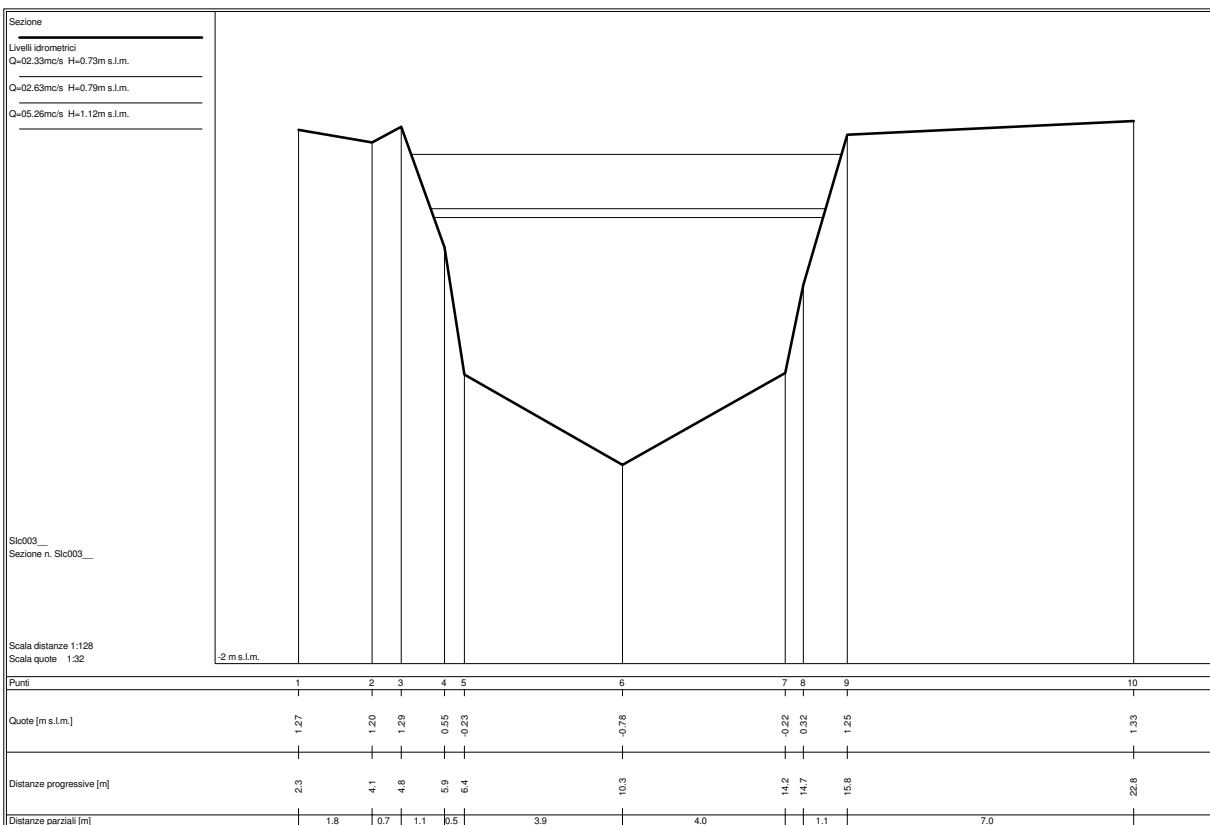
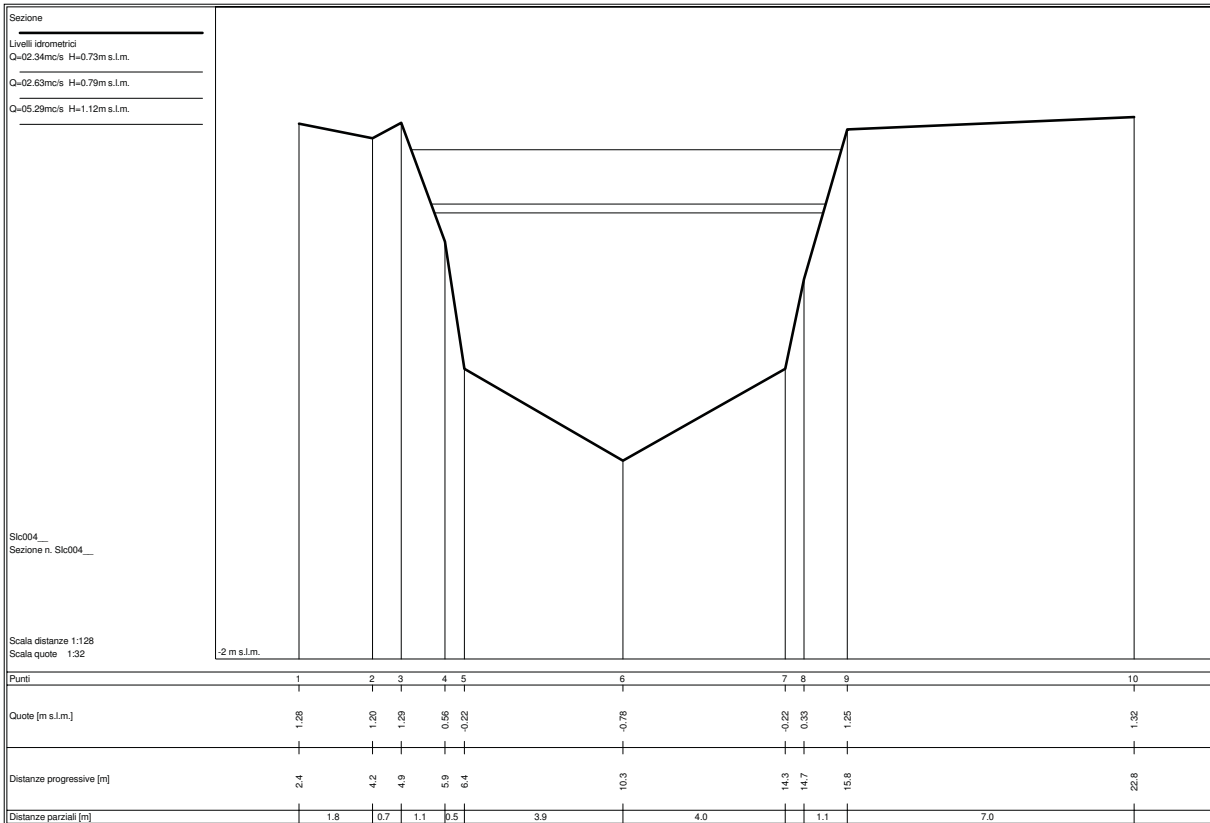



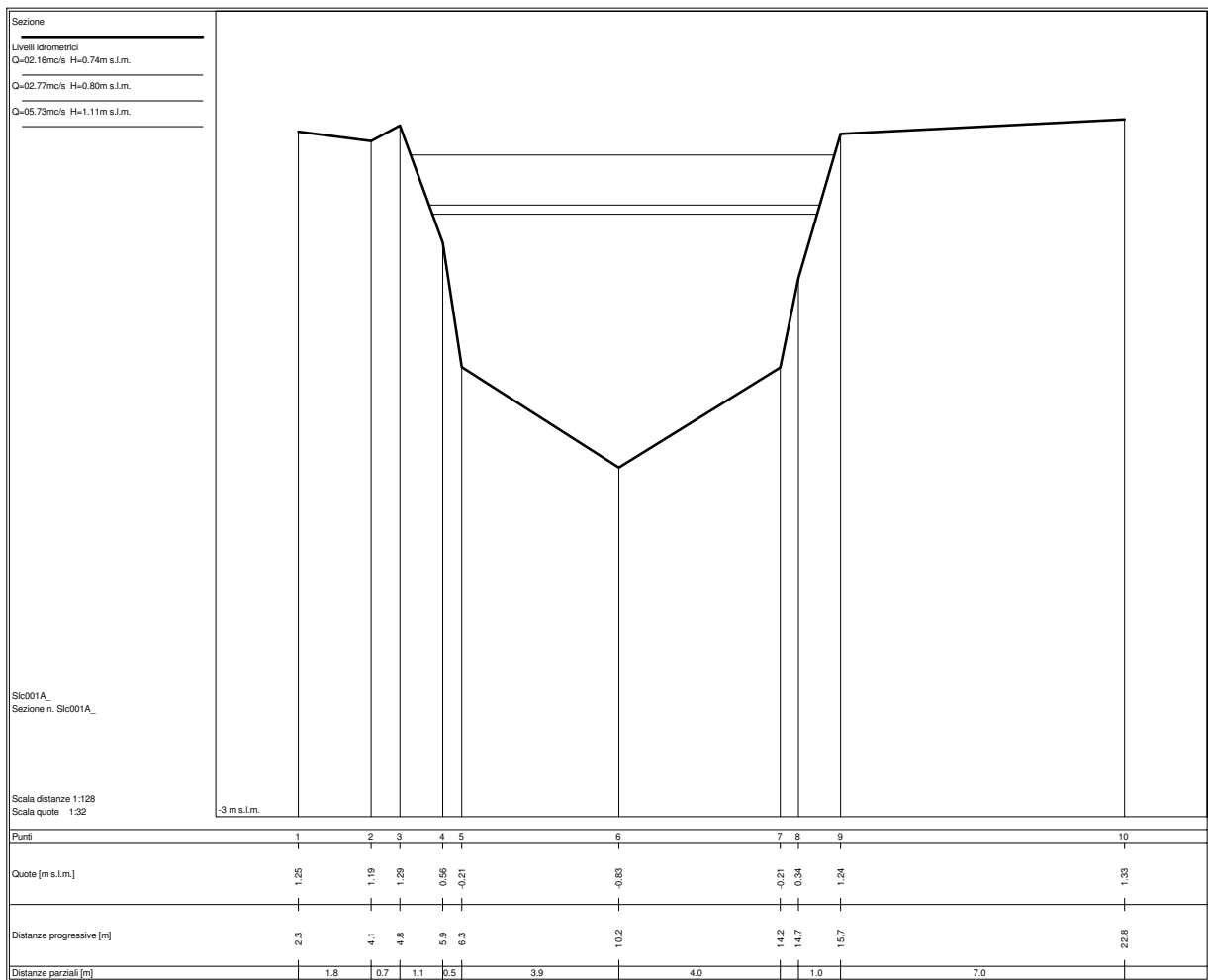
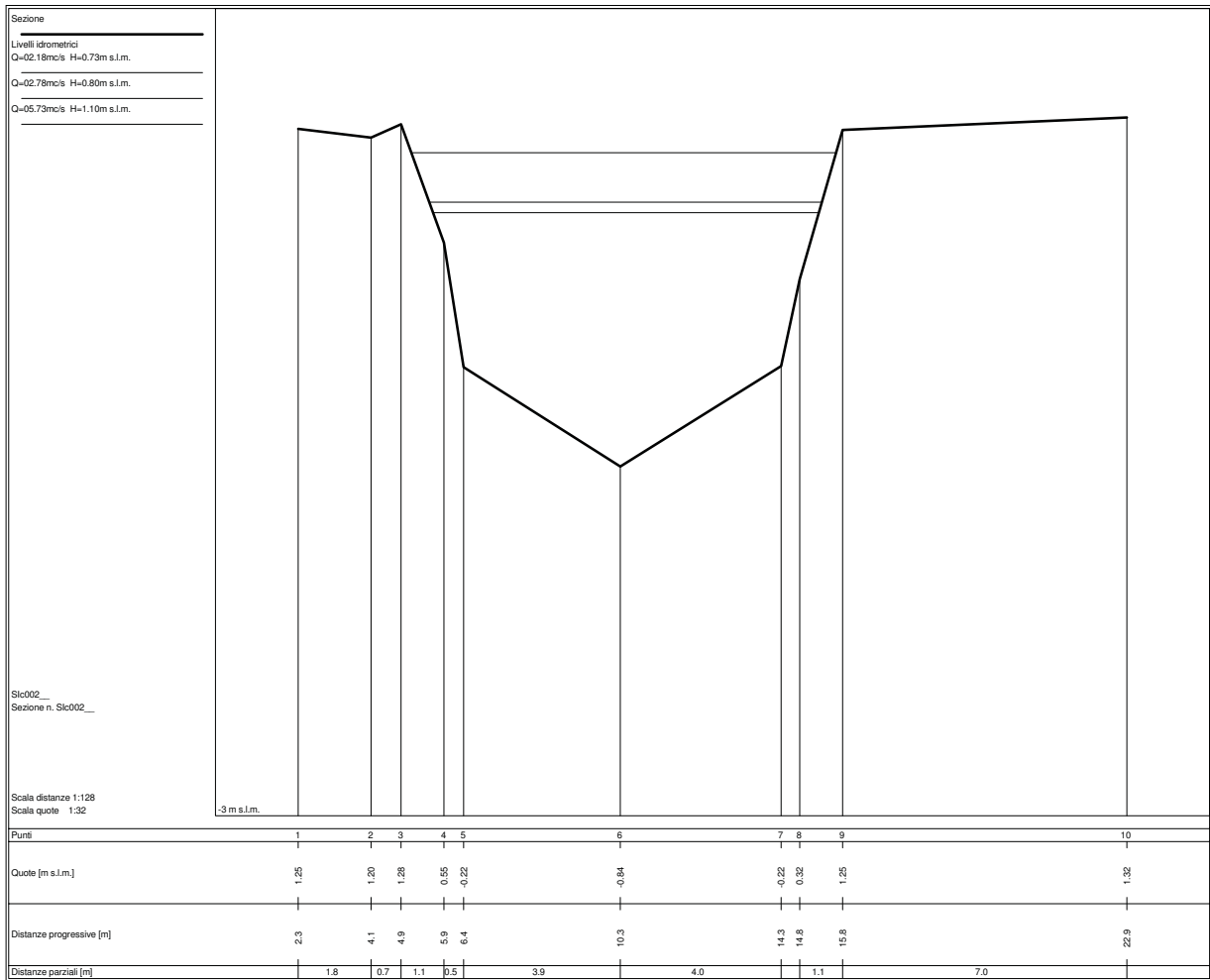

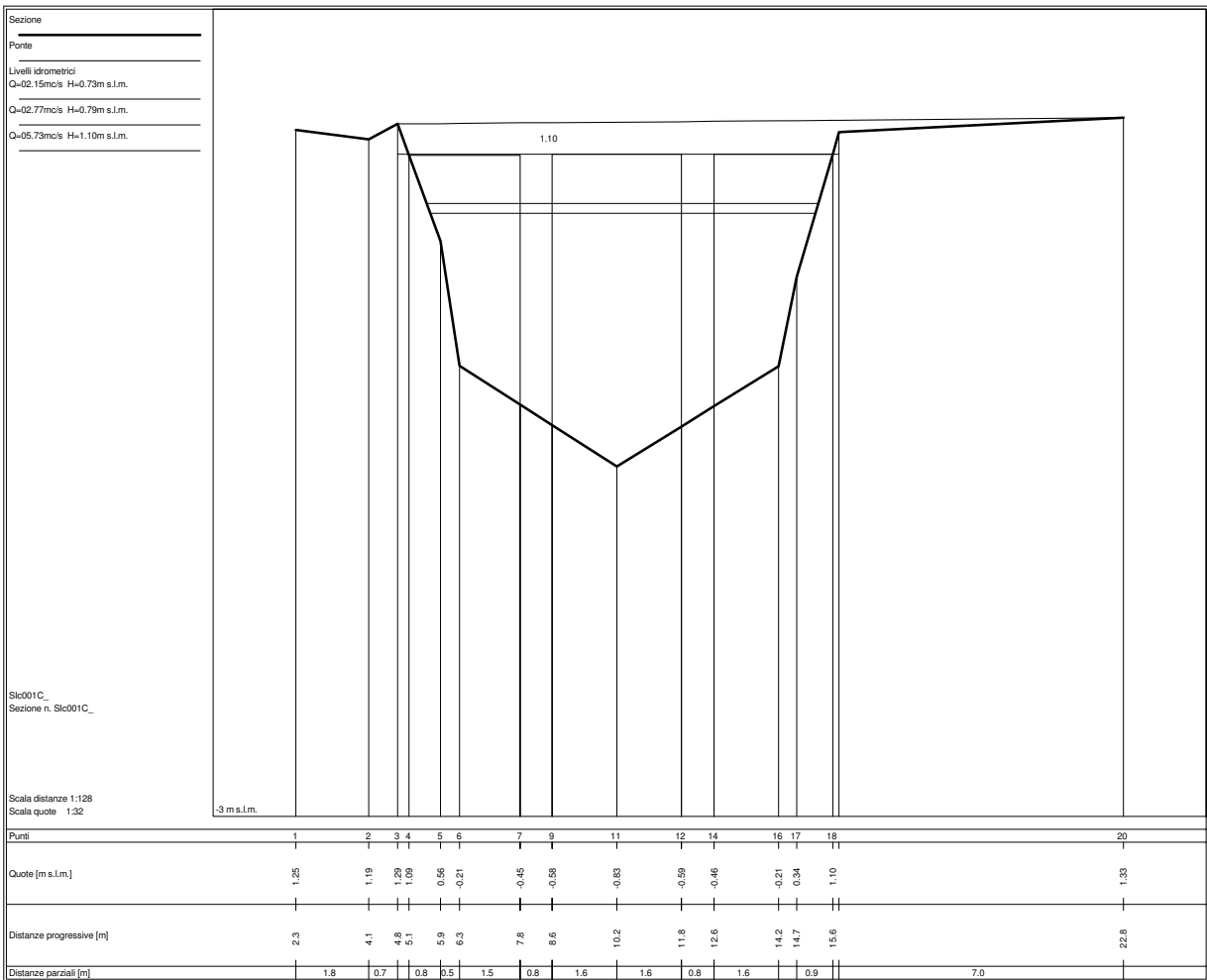
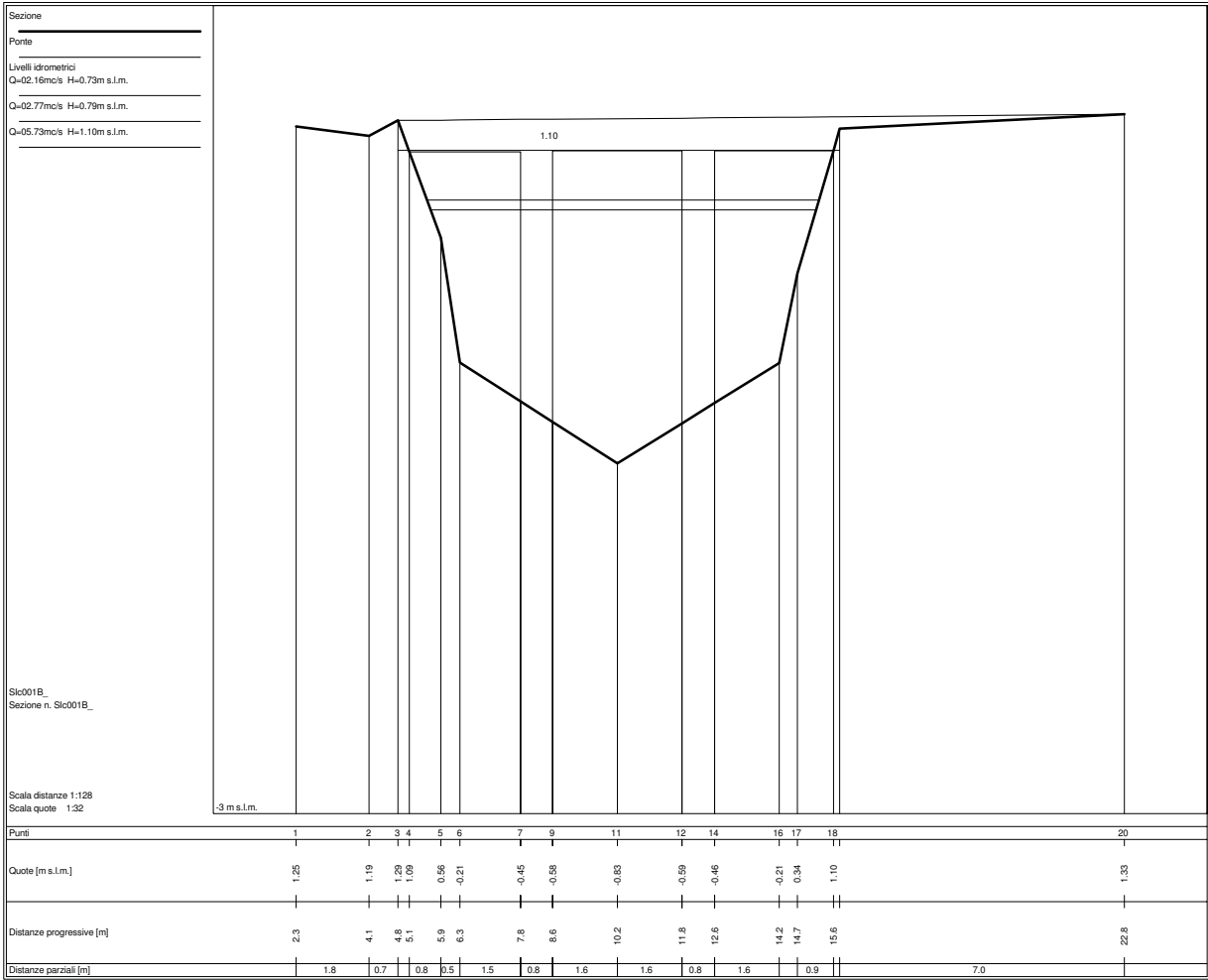

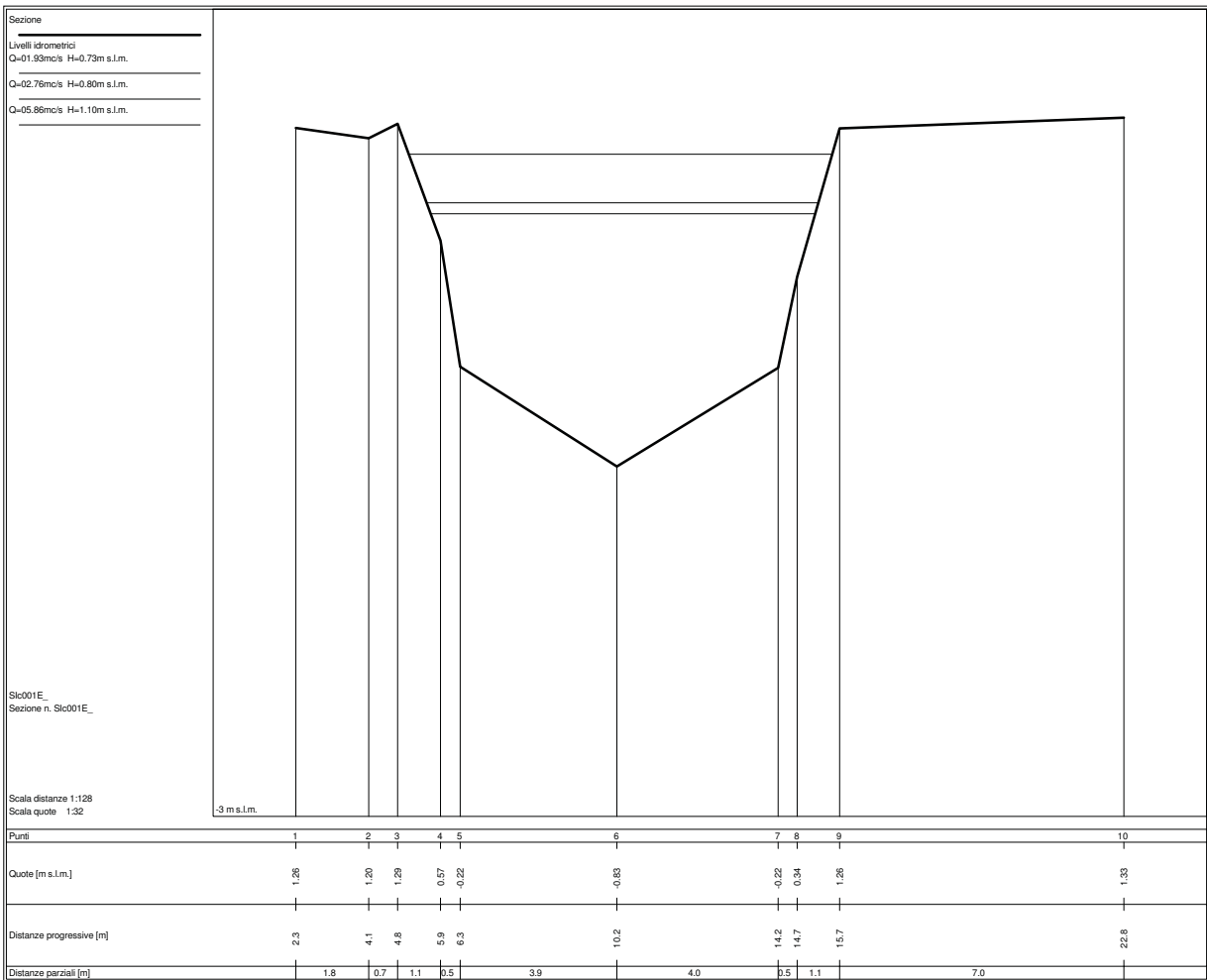
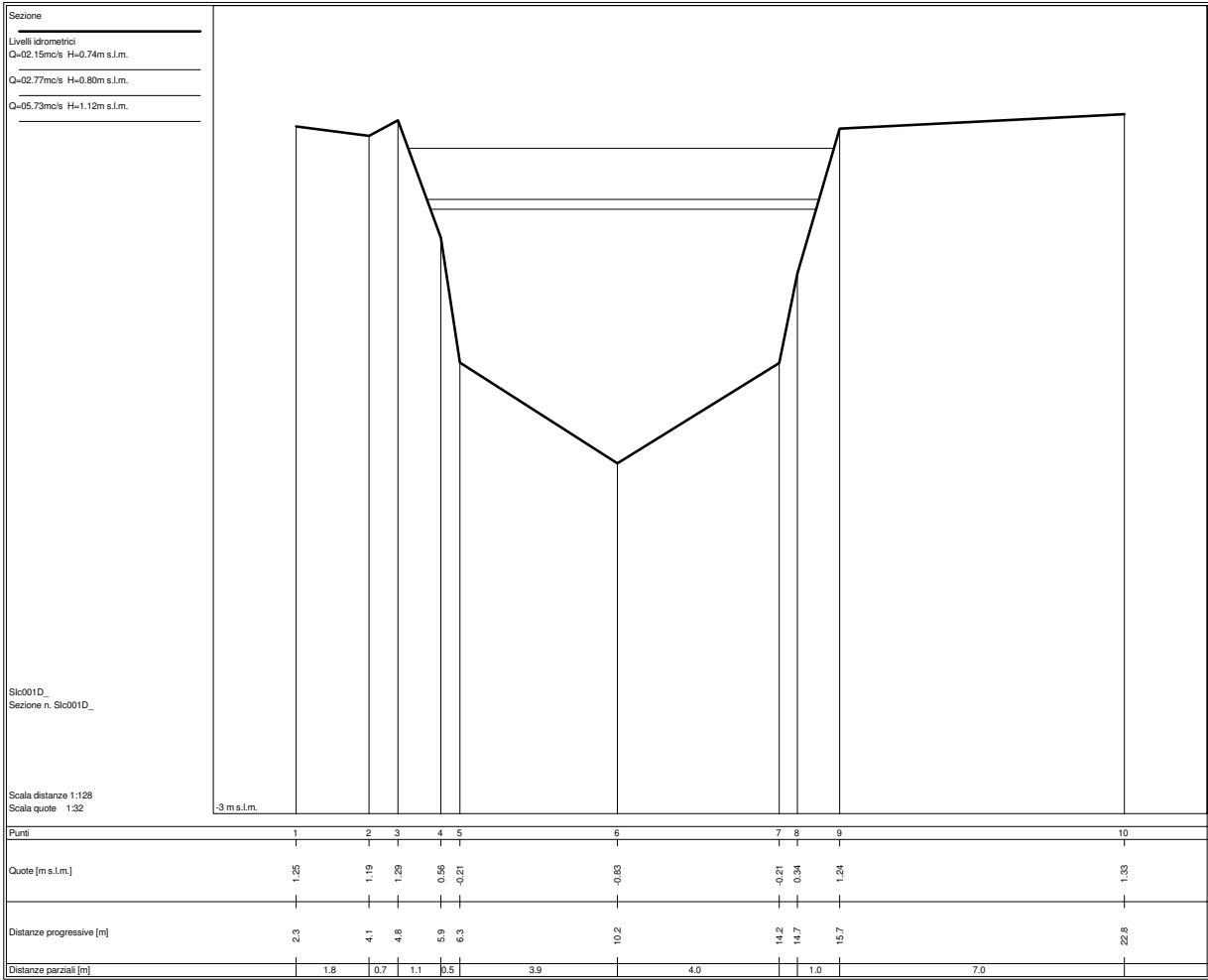

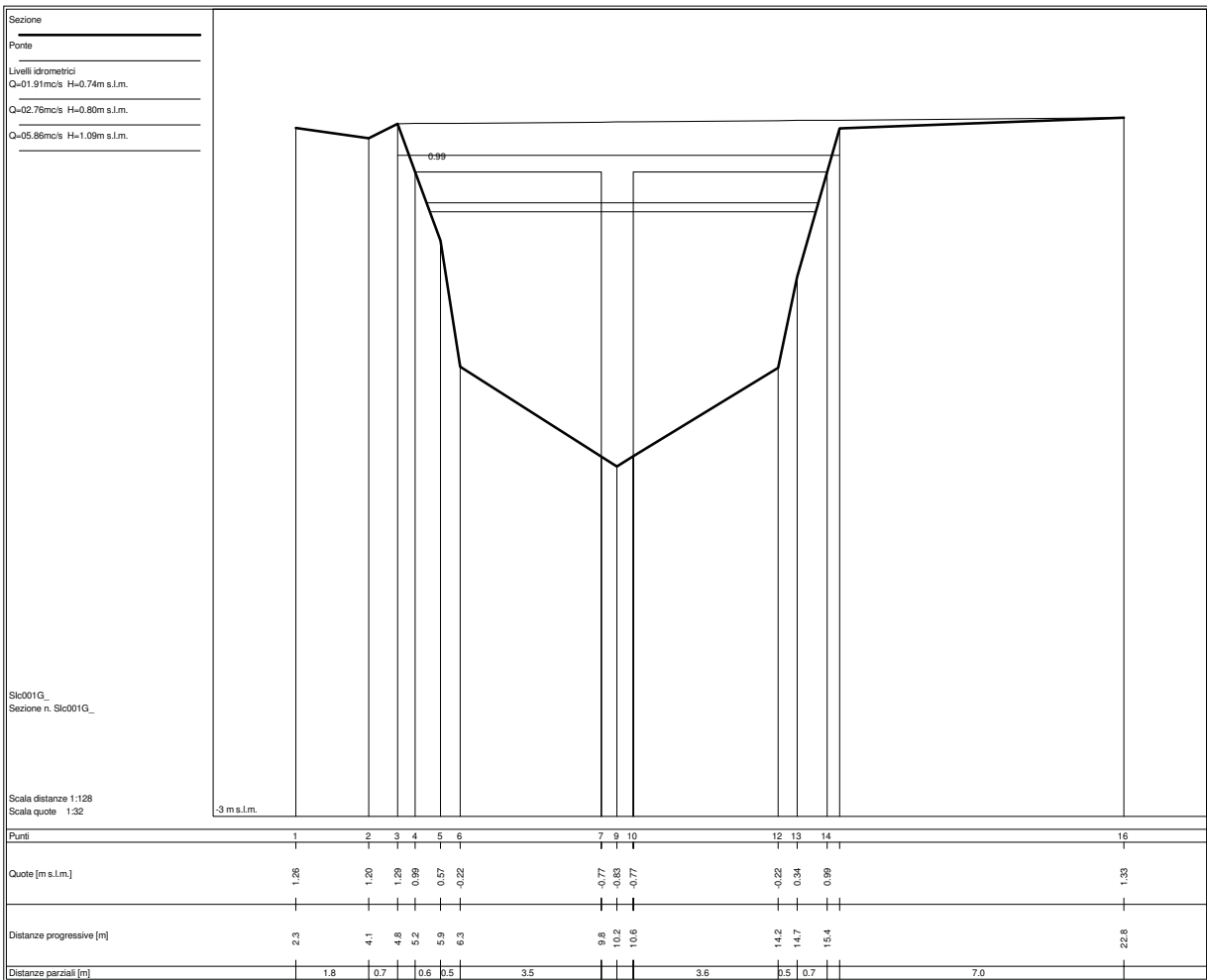
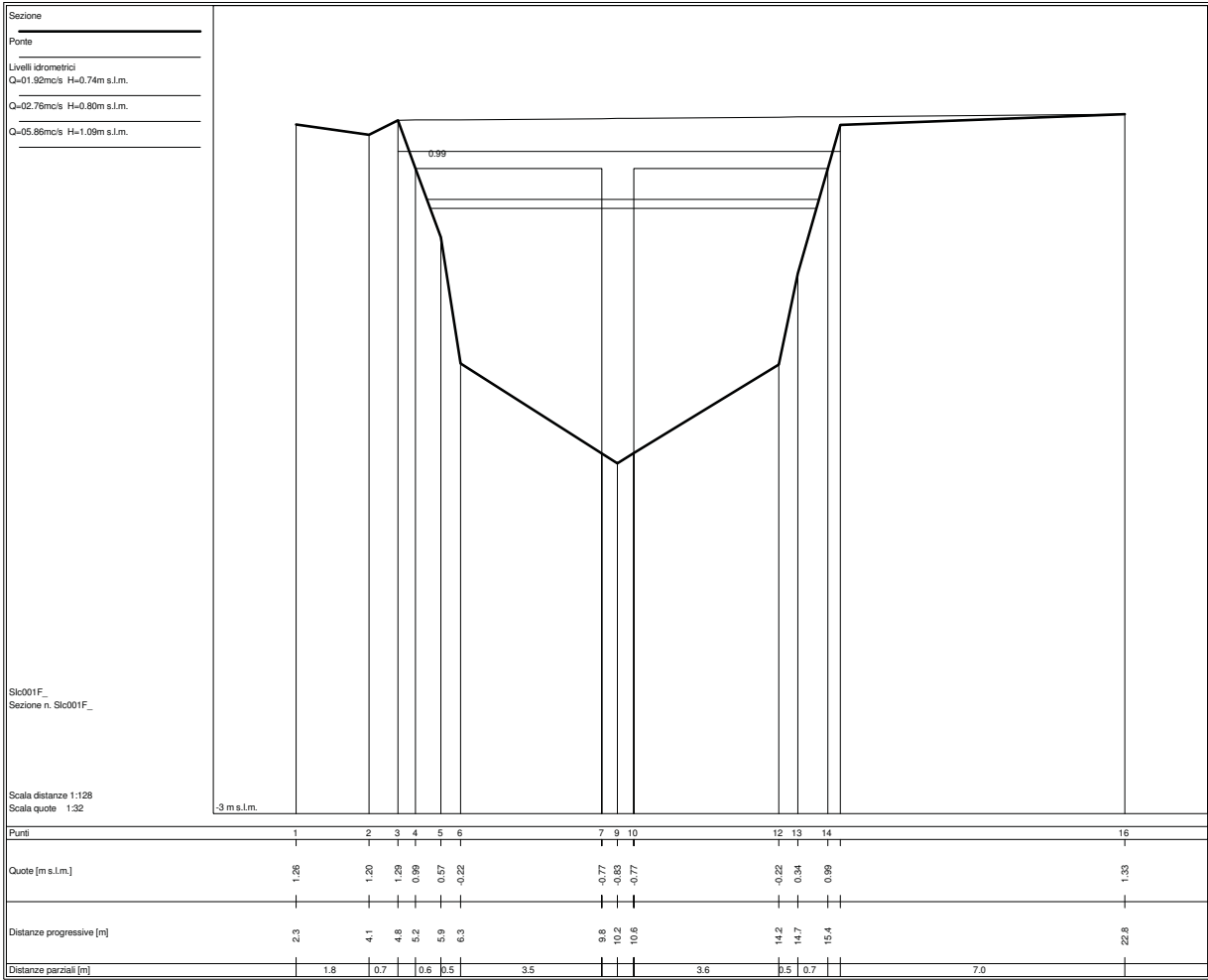

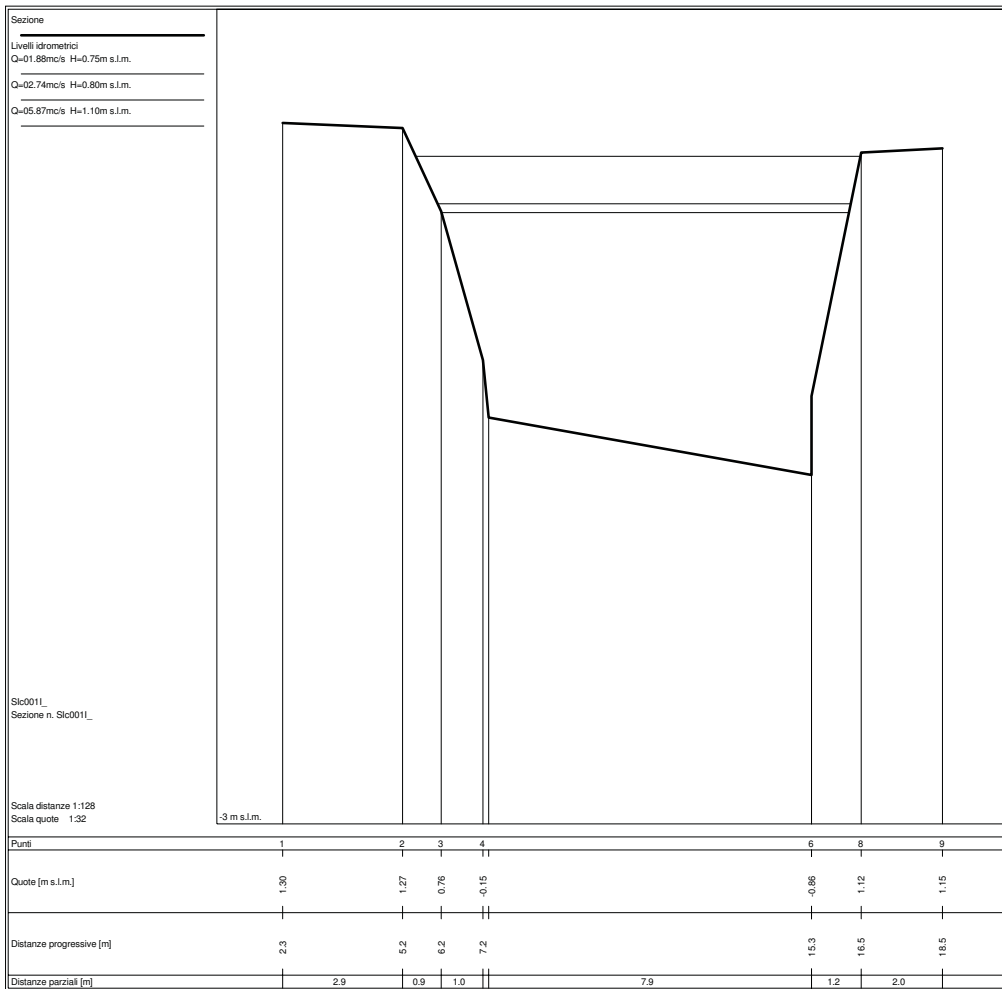
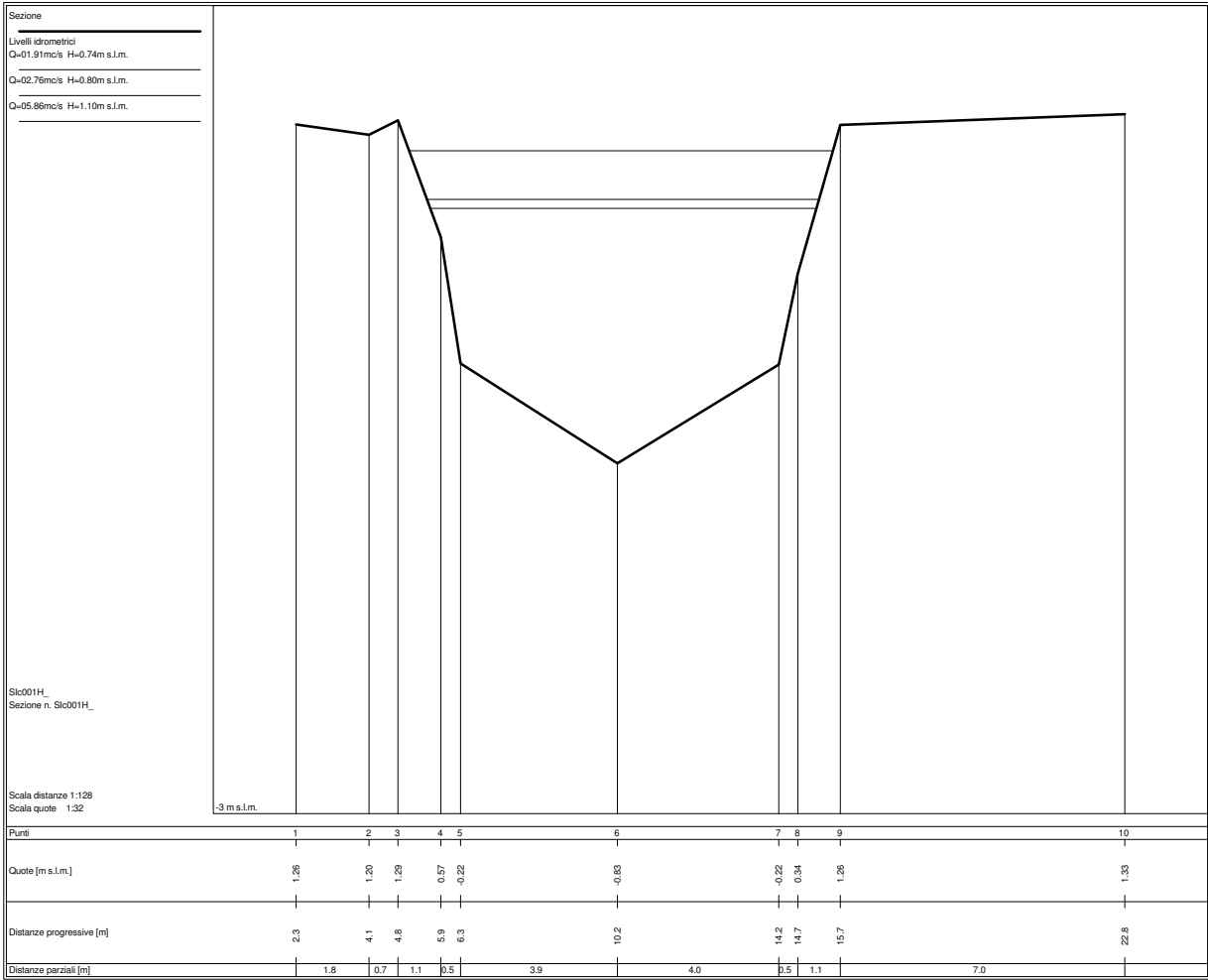

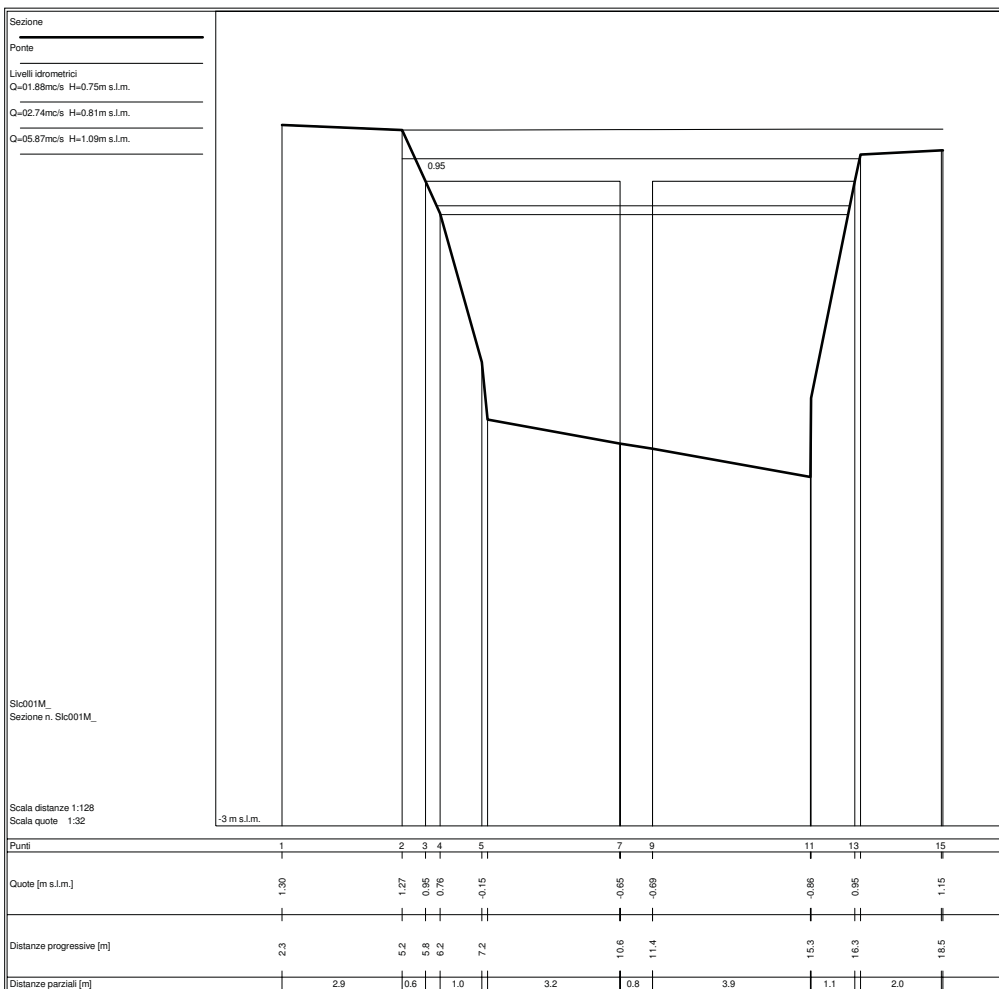
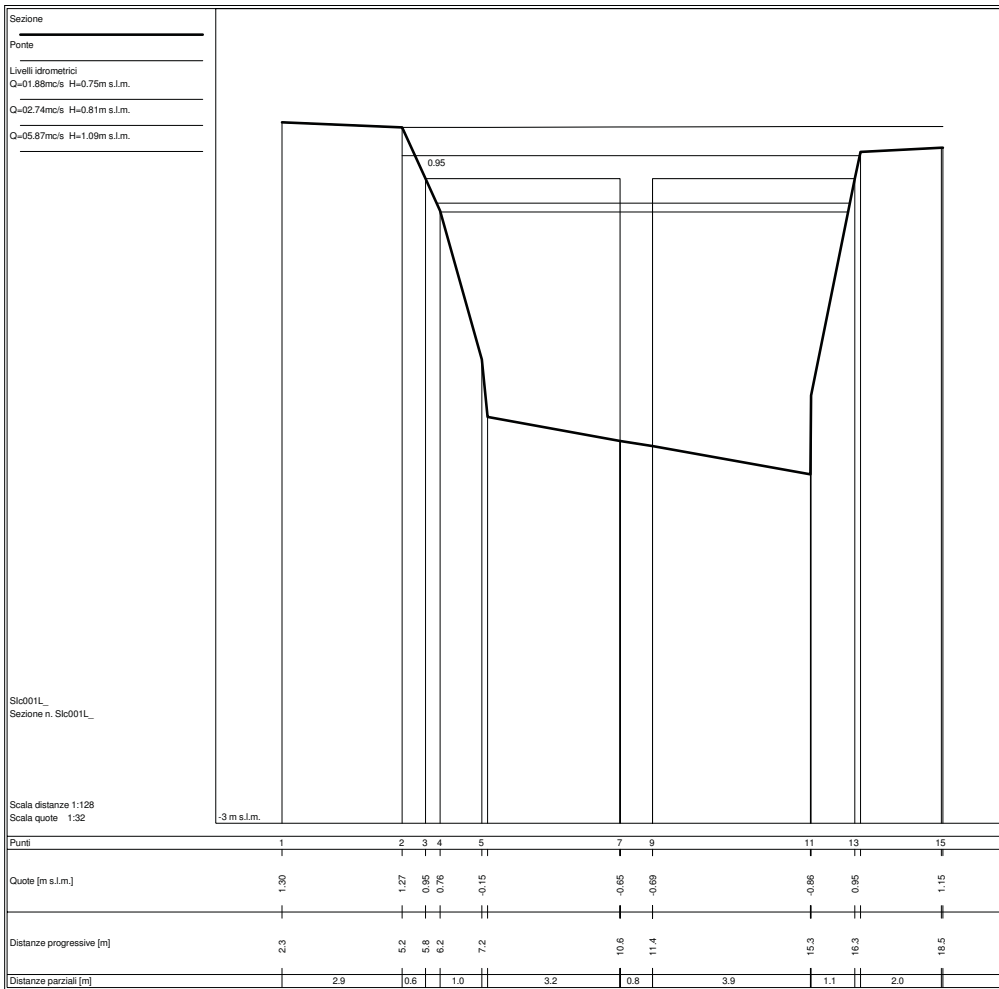

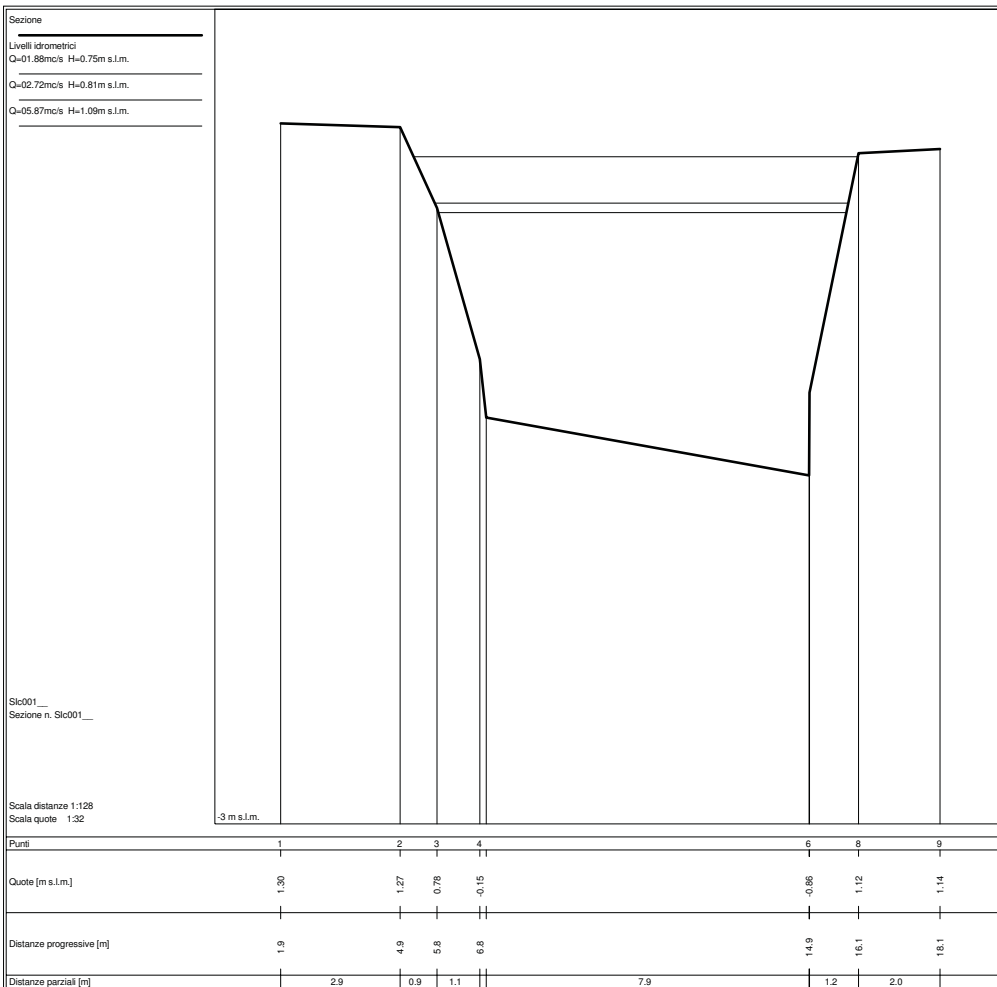
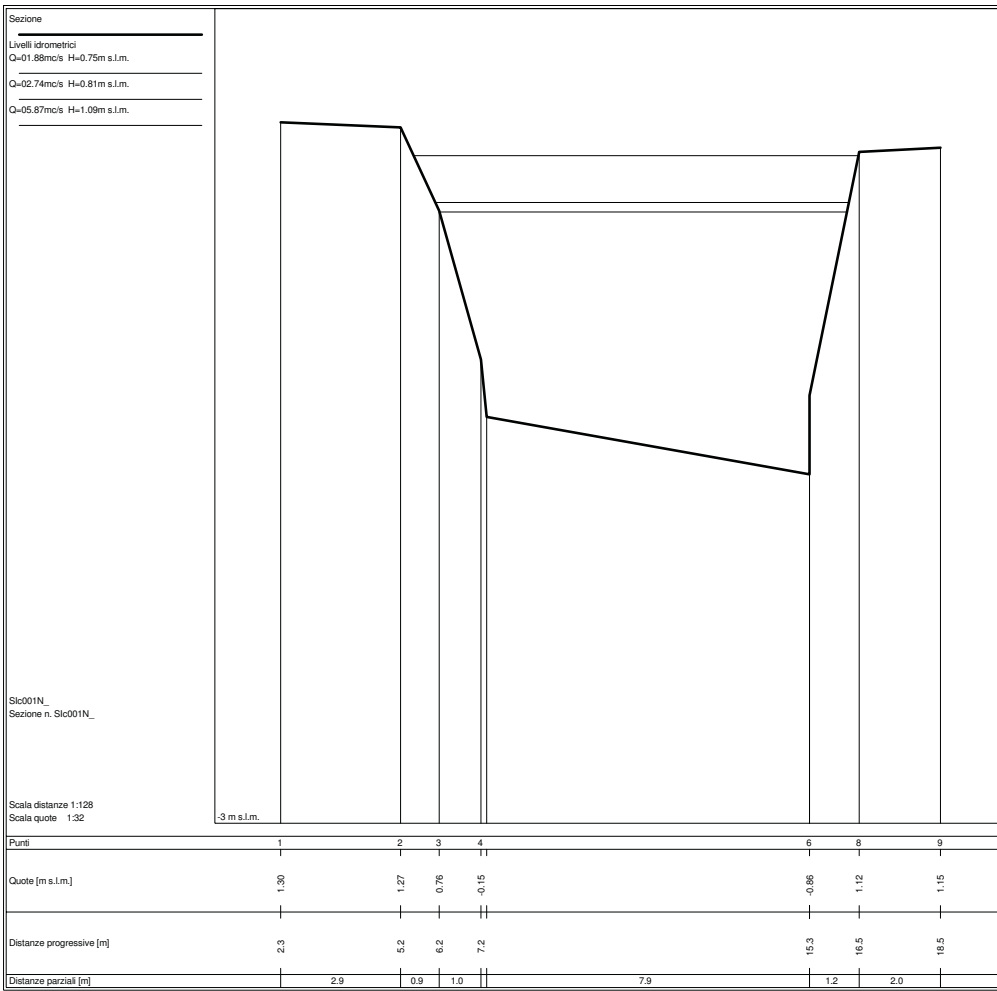

## **FOSSO LODOLINA**



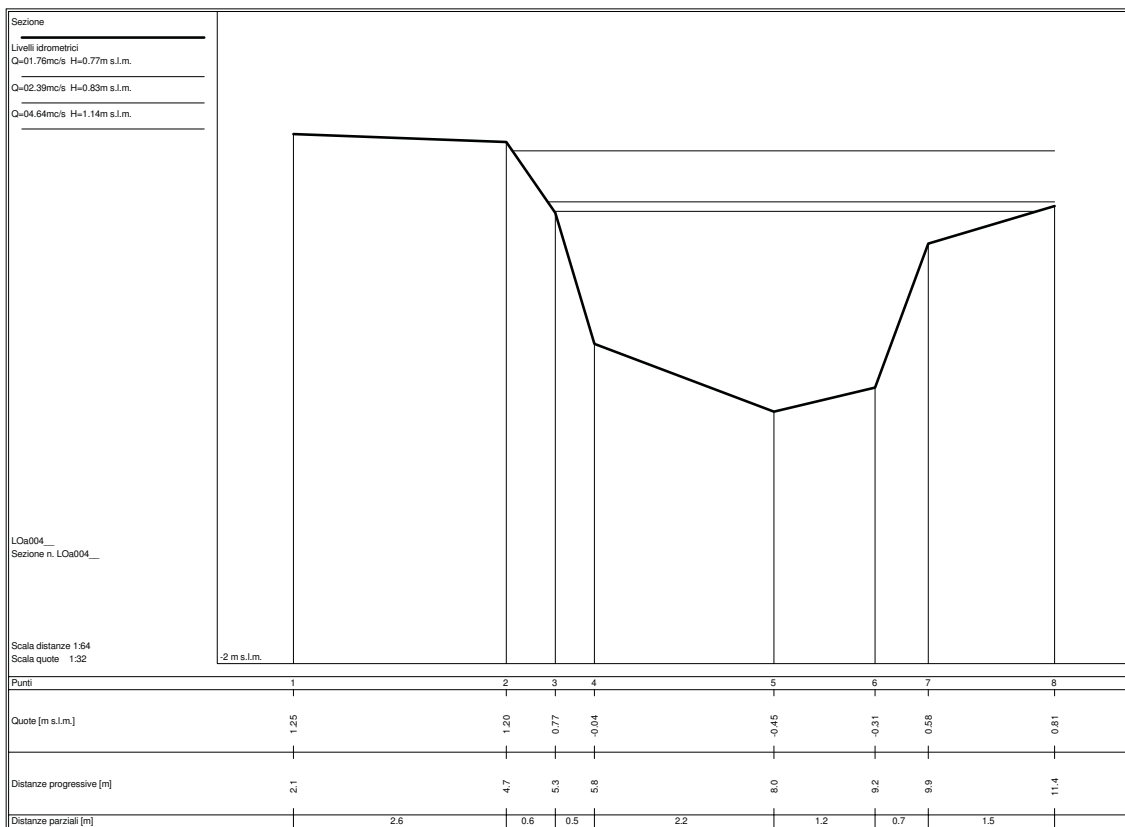
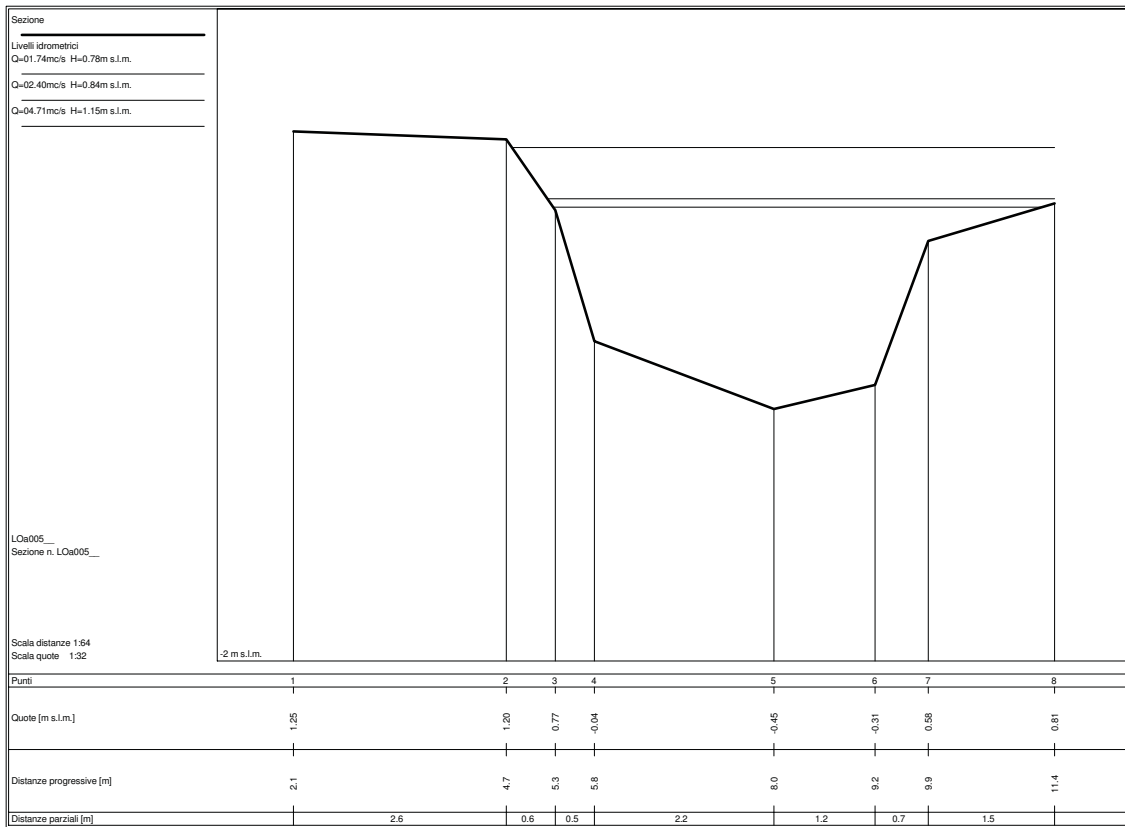

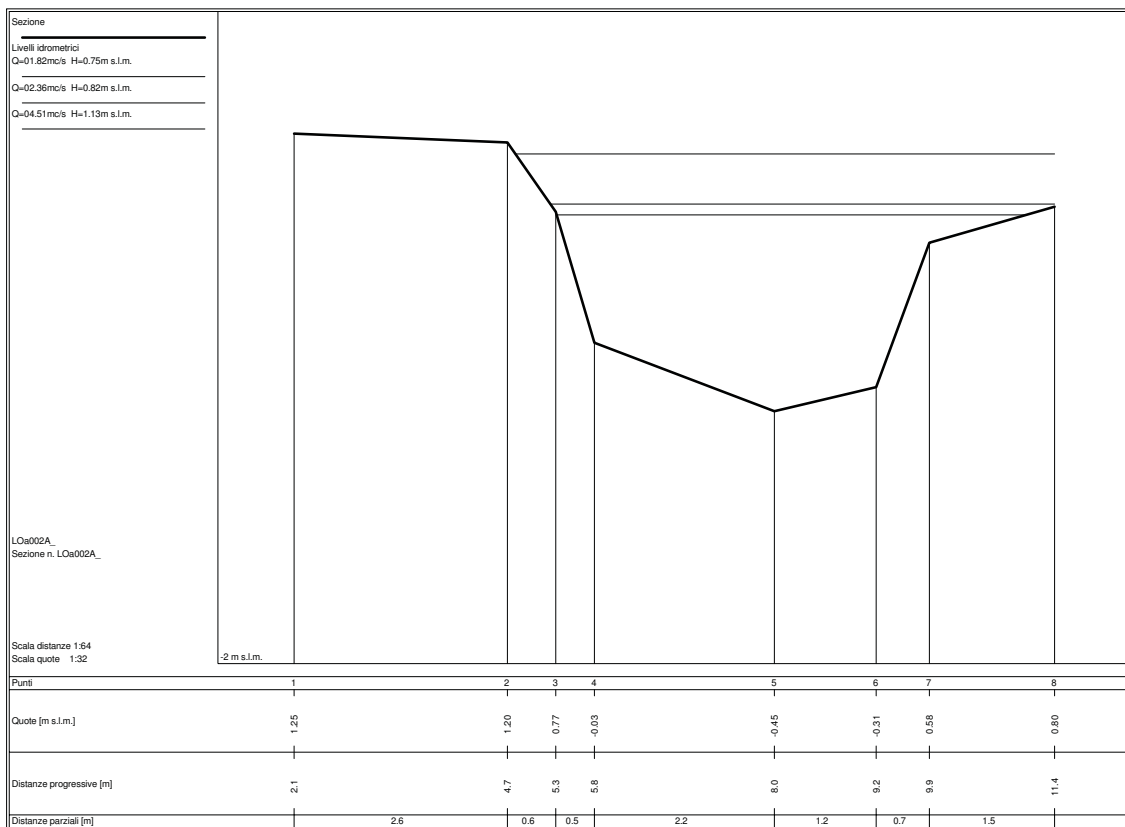
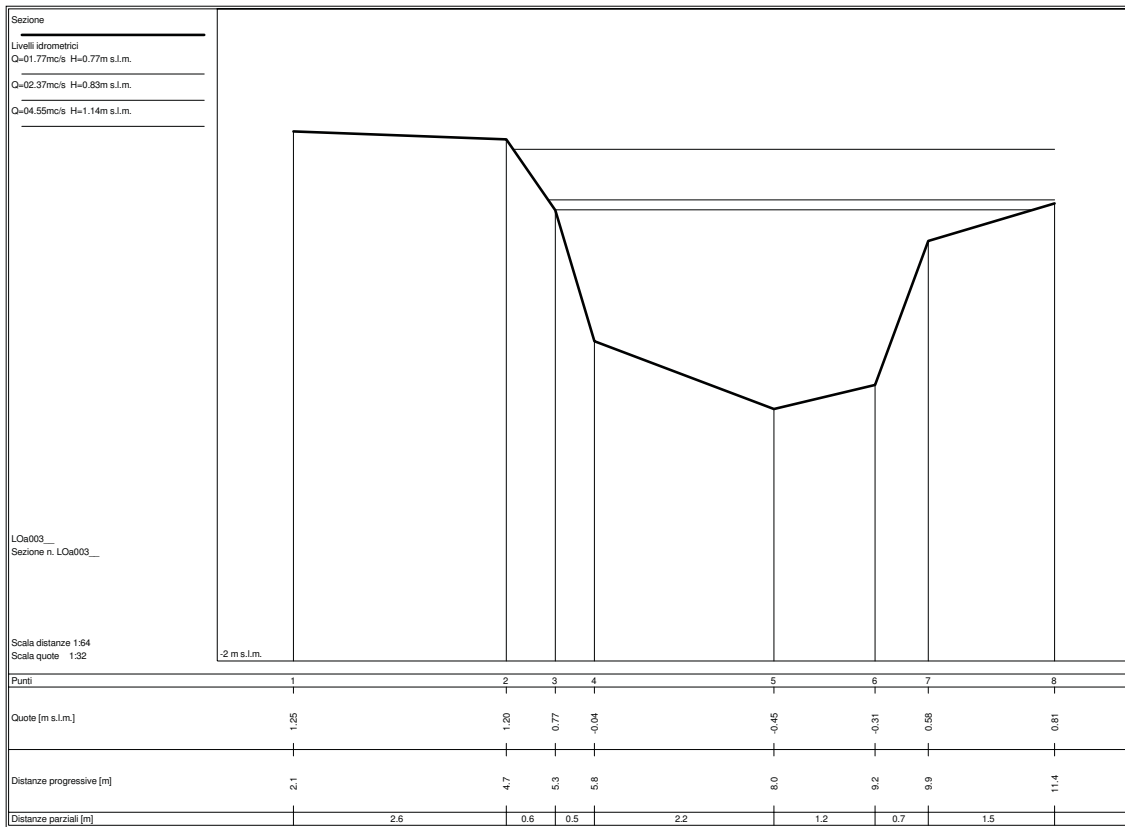

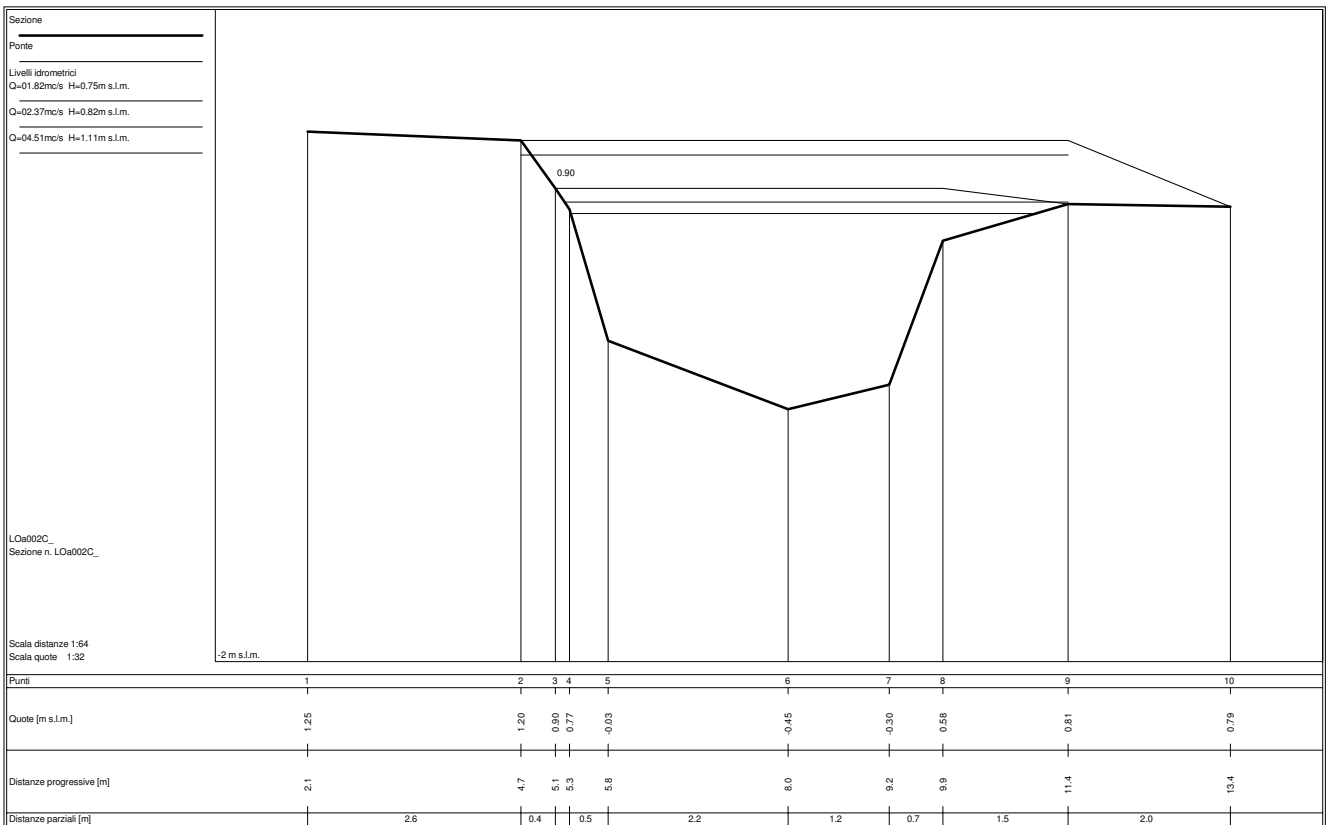
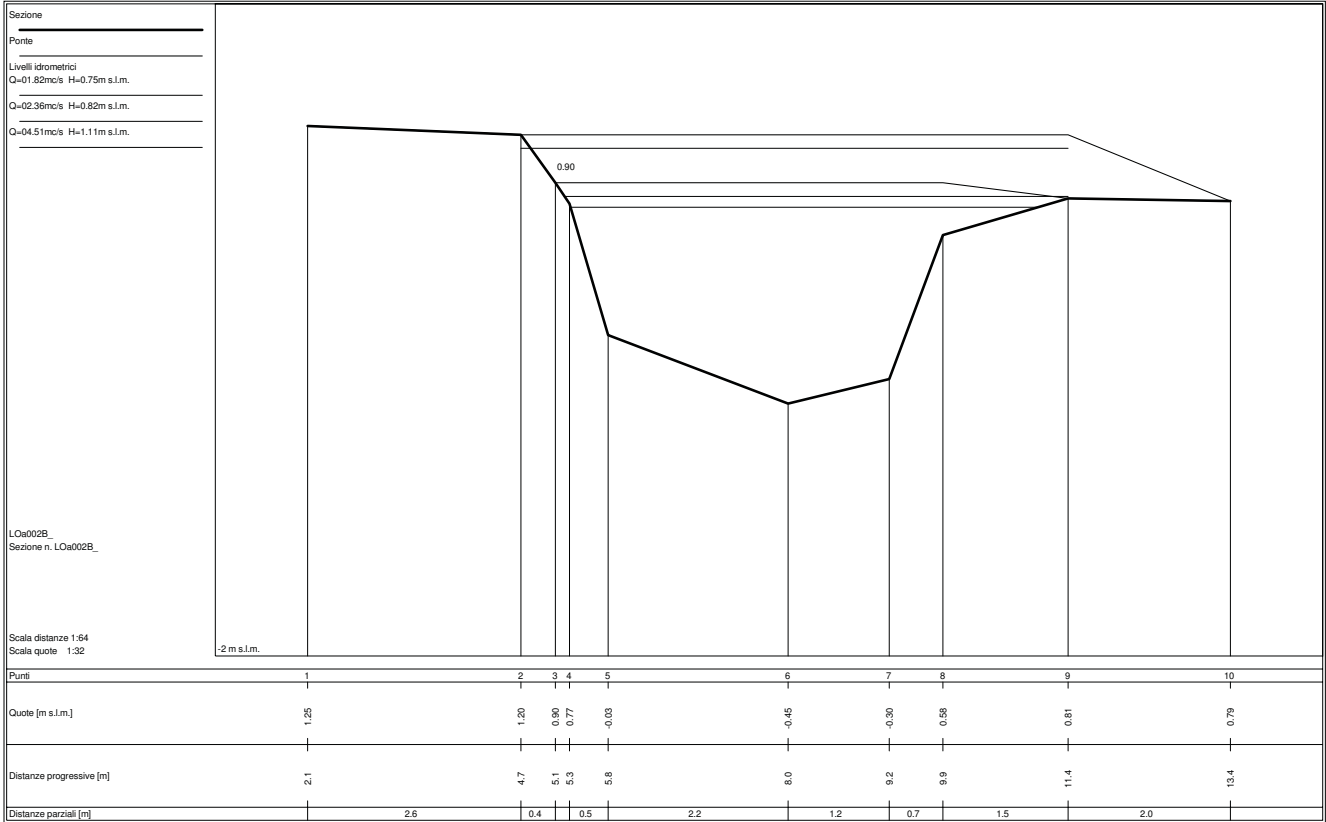

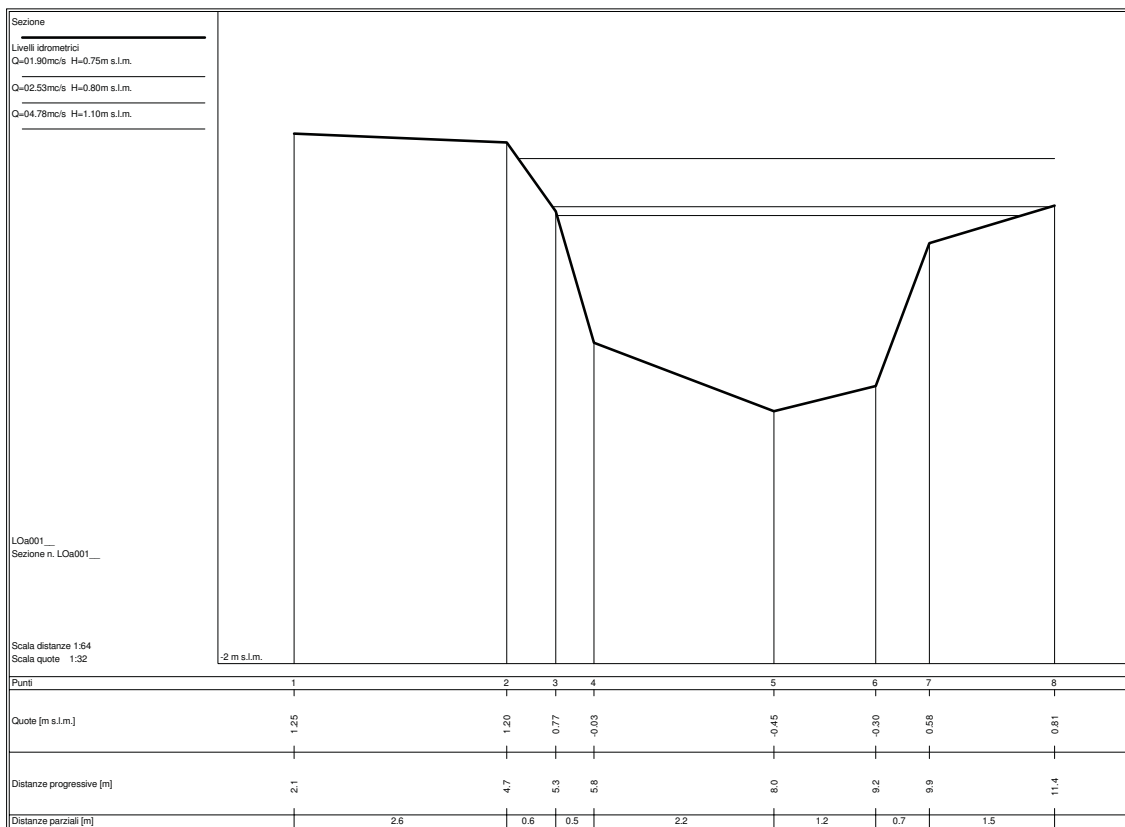
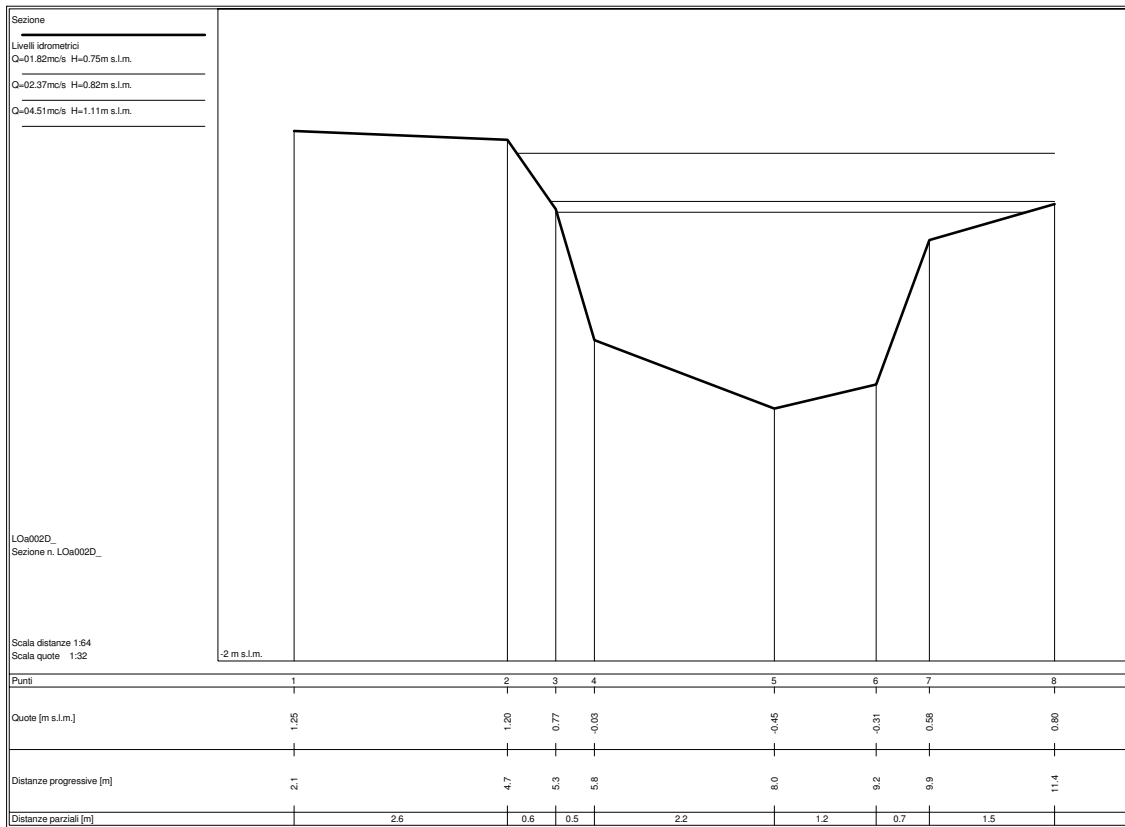

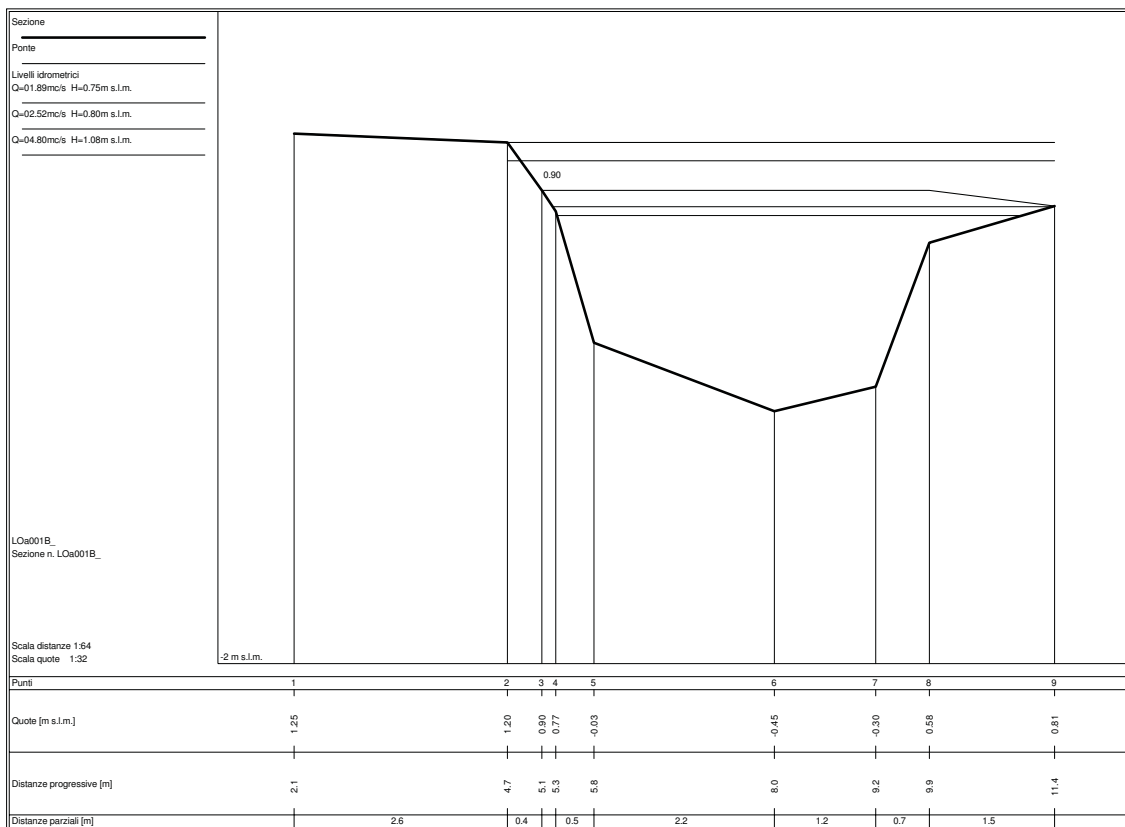
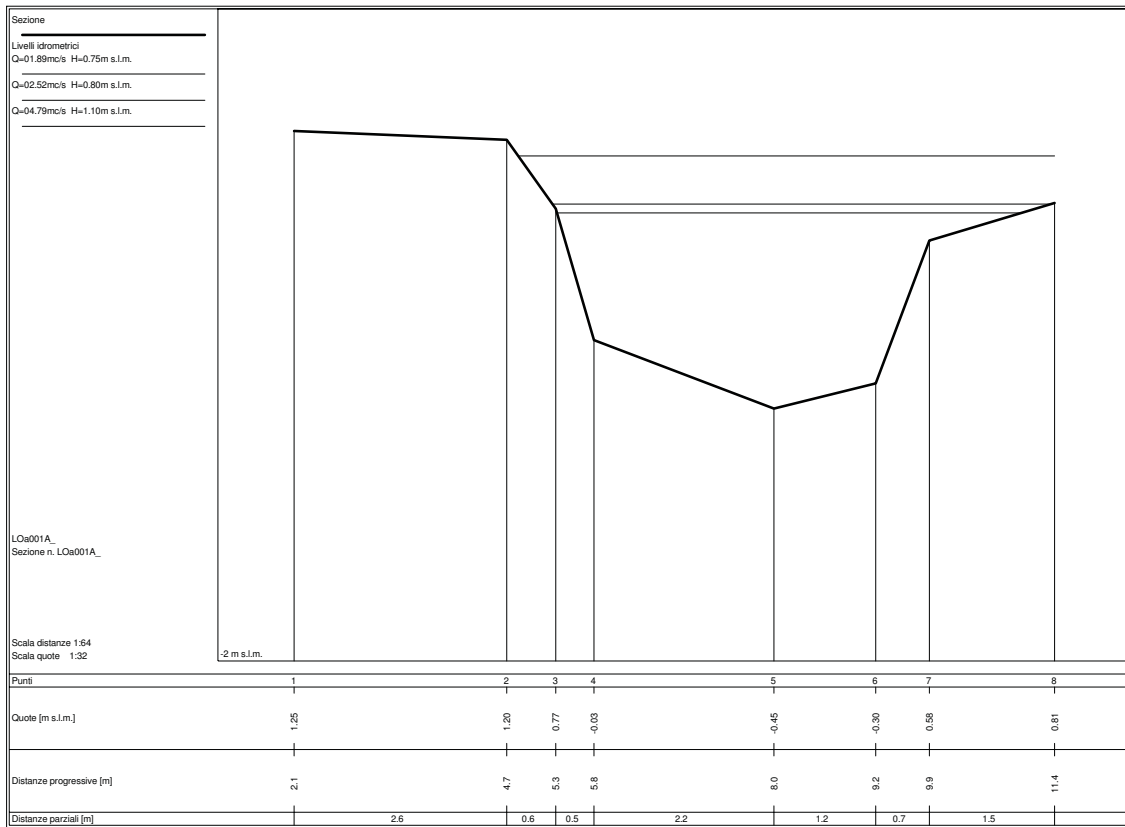

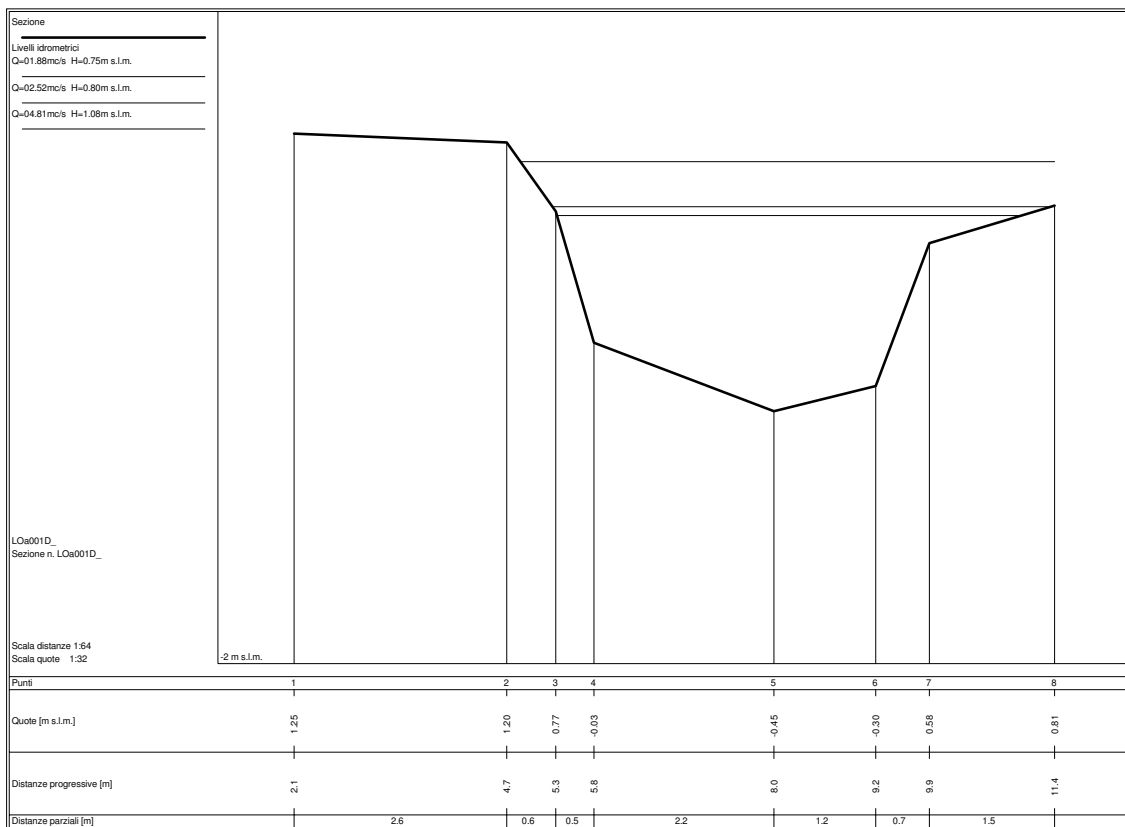
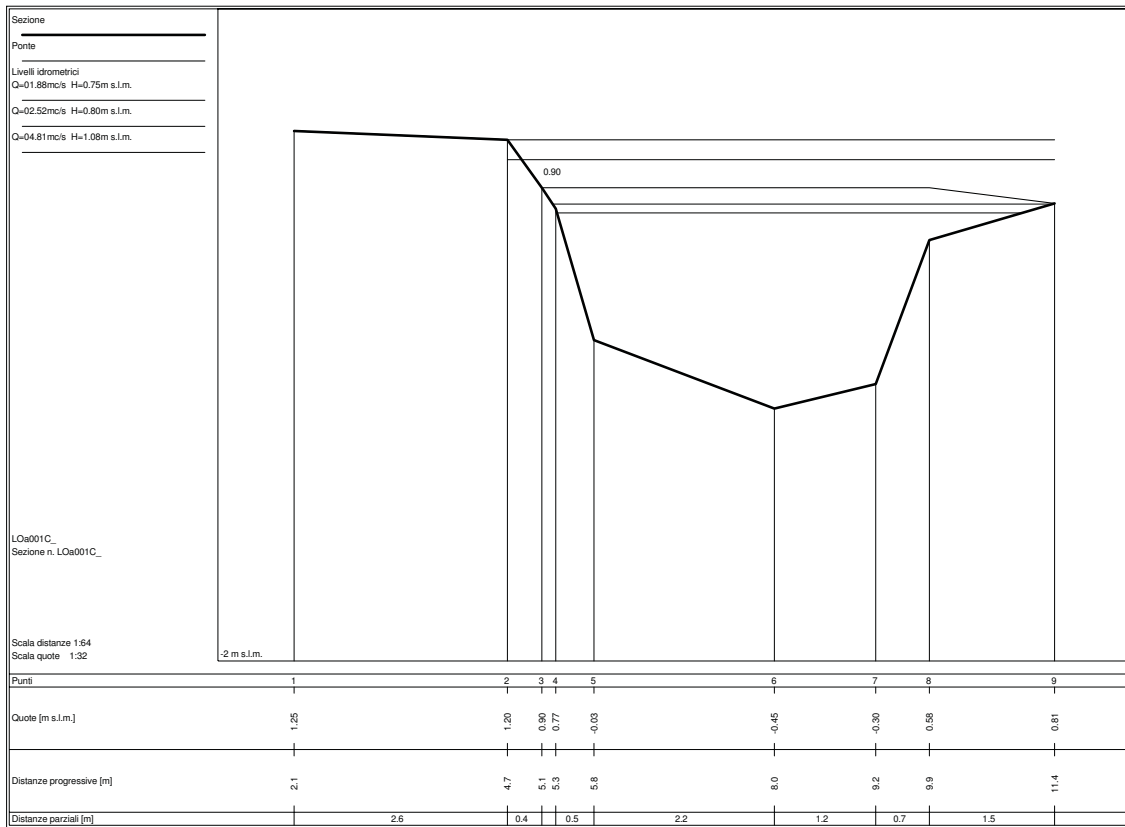

## **FOSSO DI MEZZO – RAMO A**

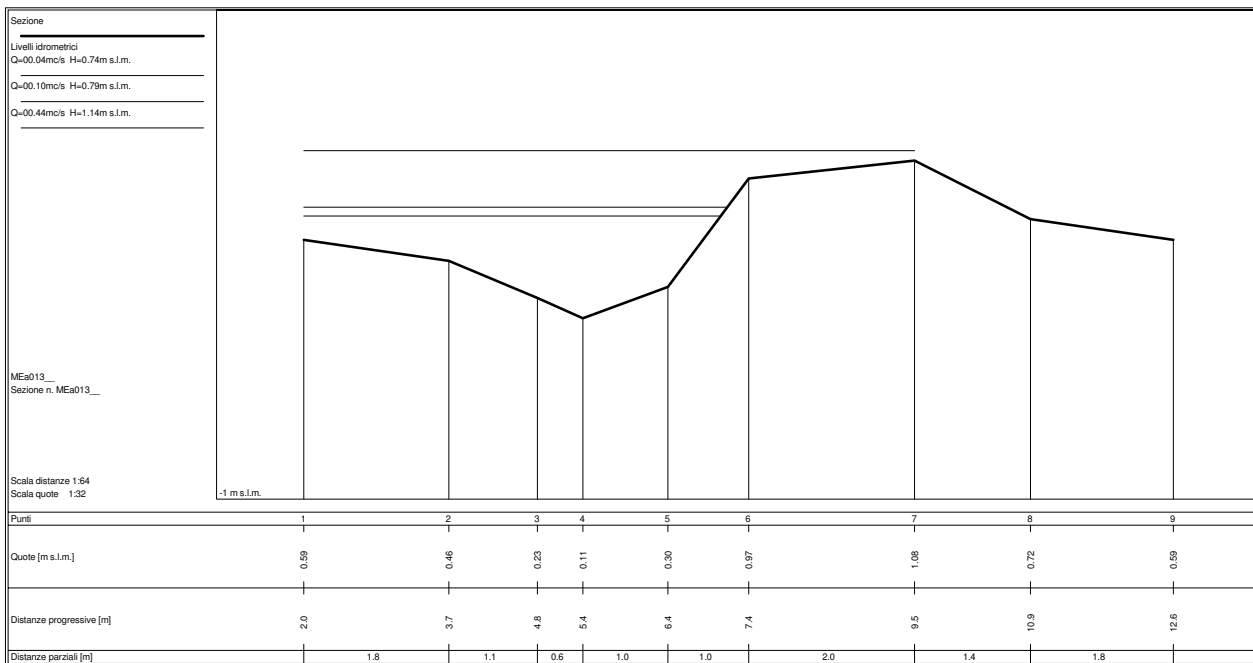
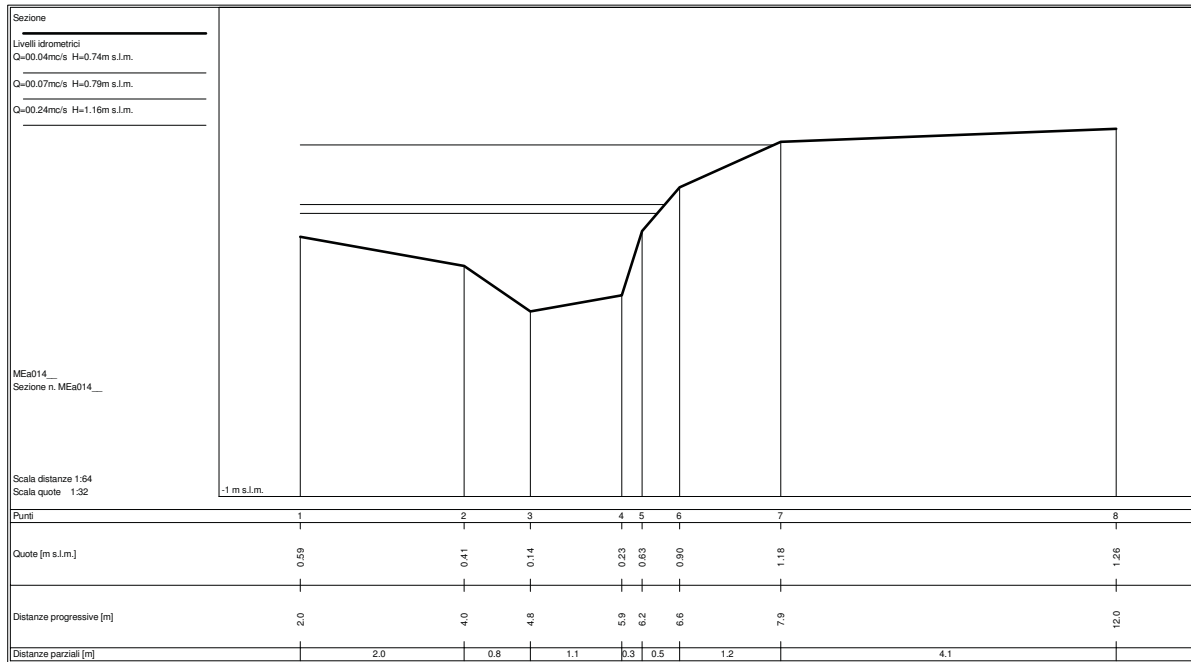



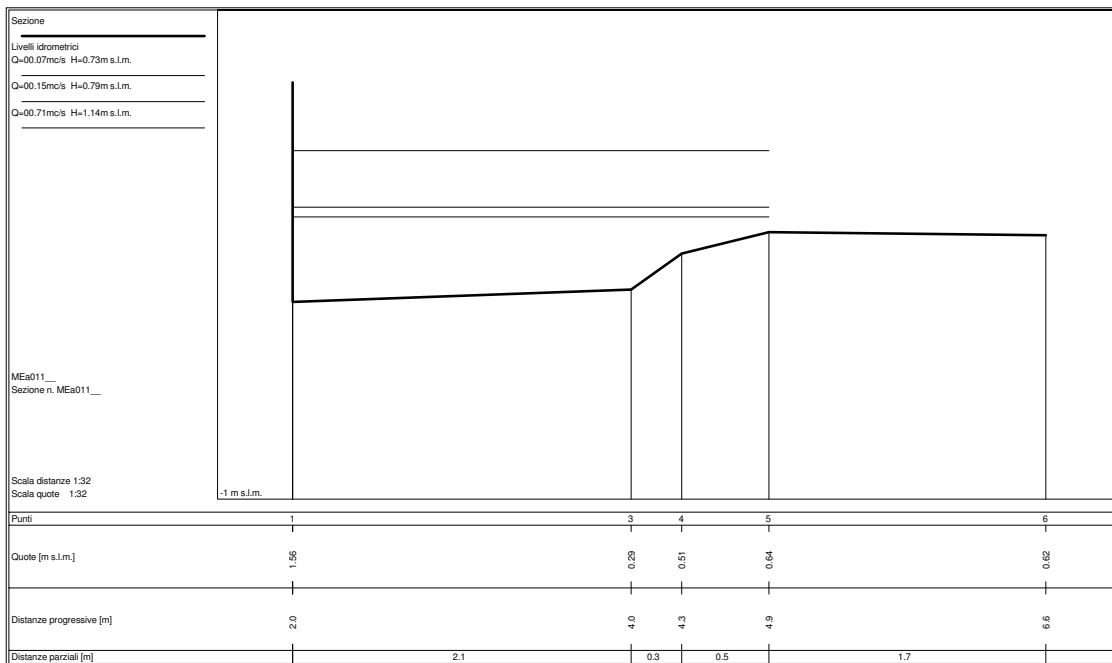
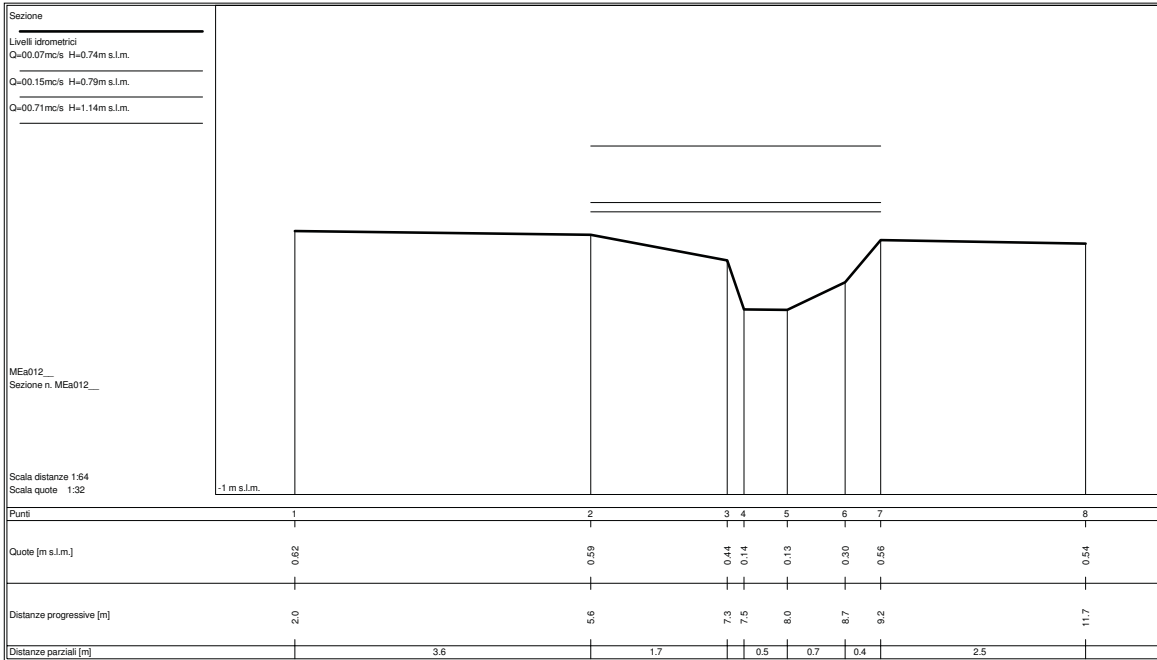

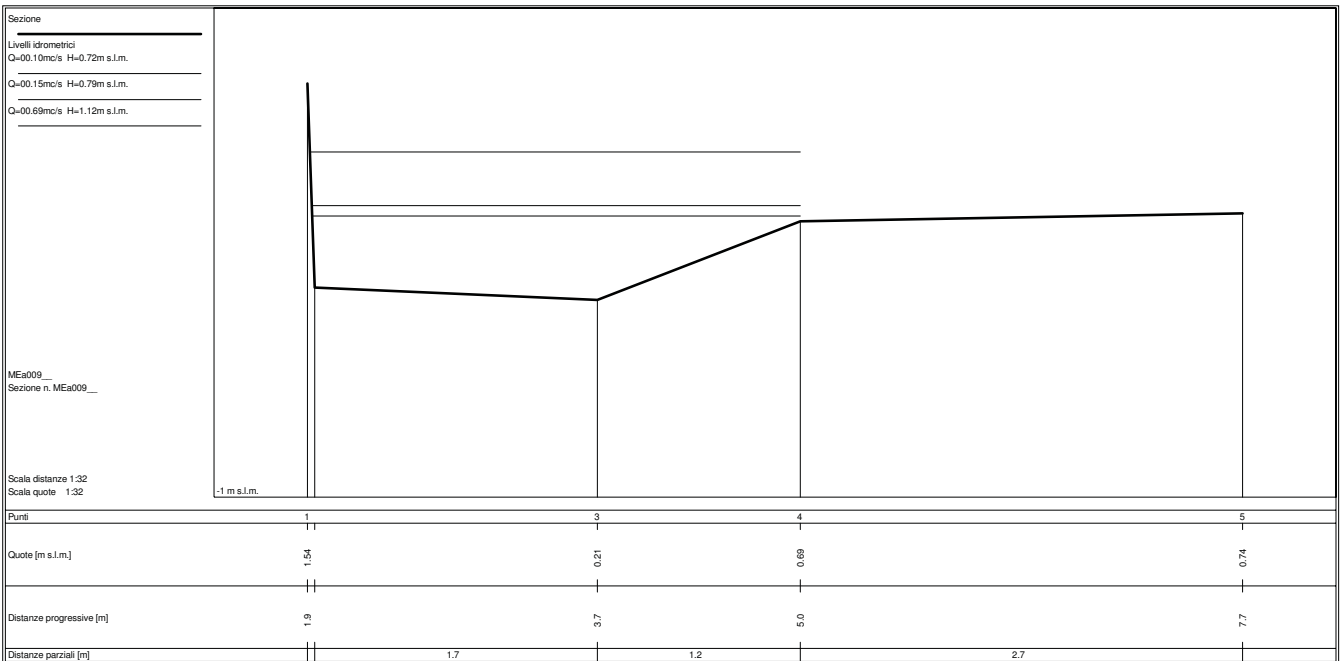
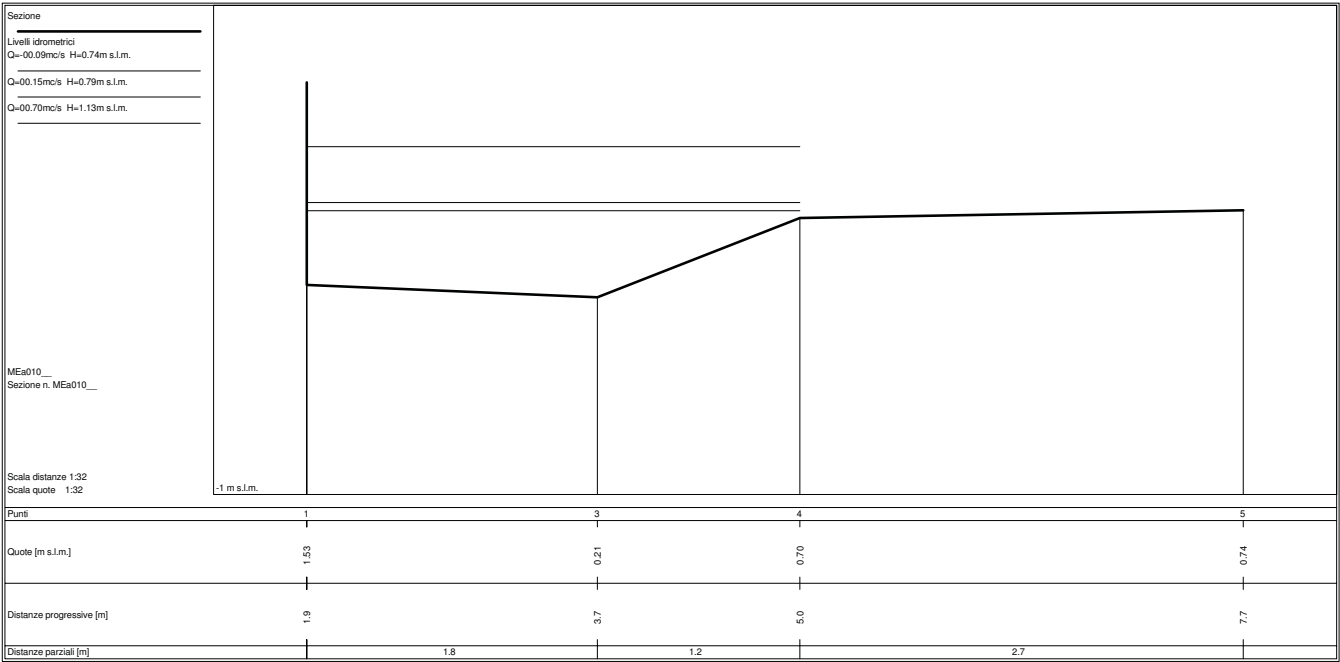

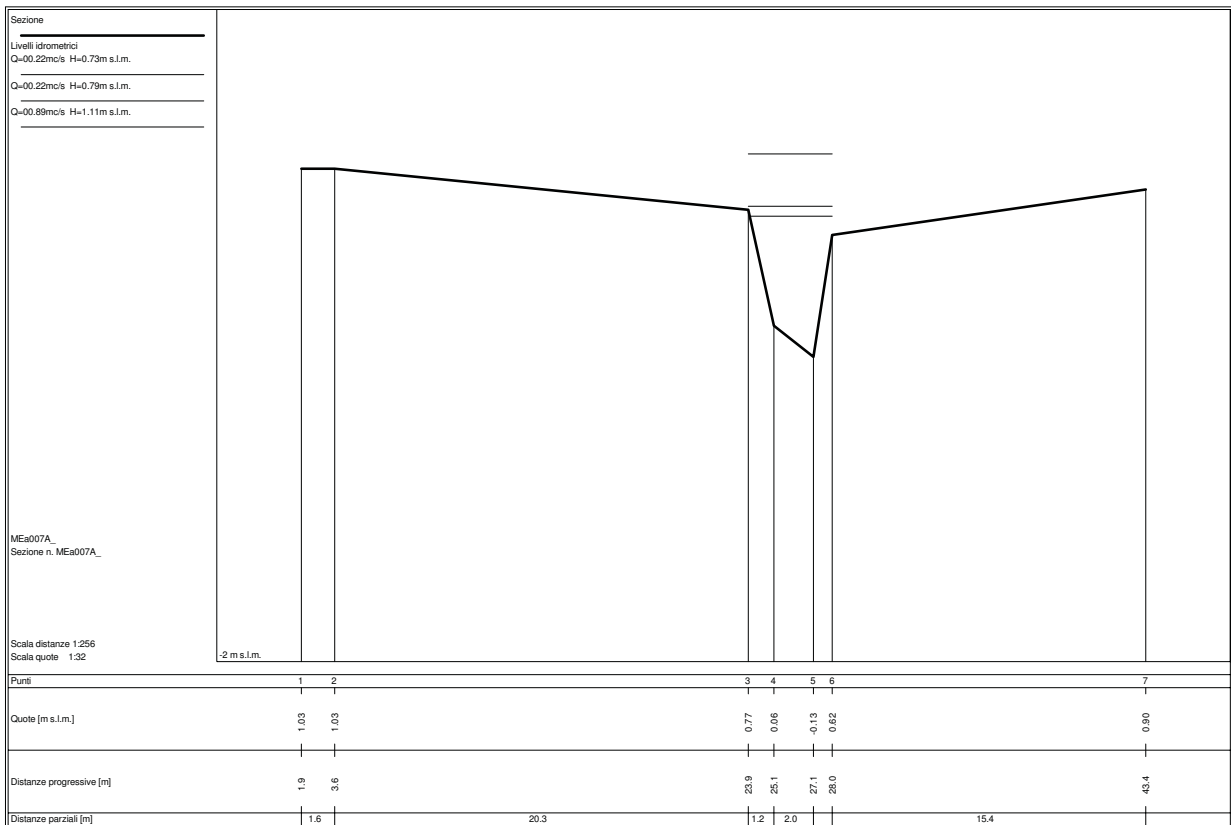
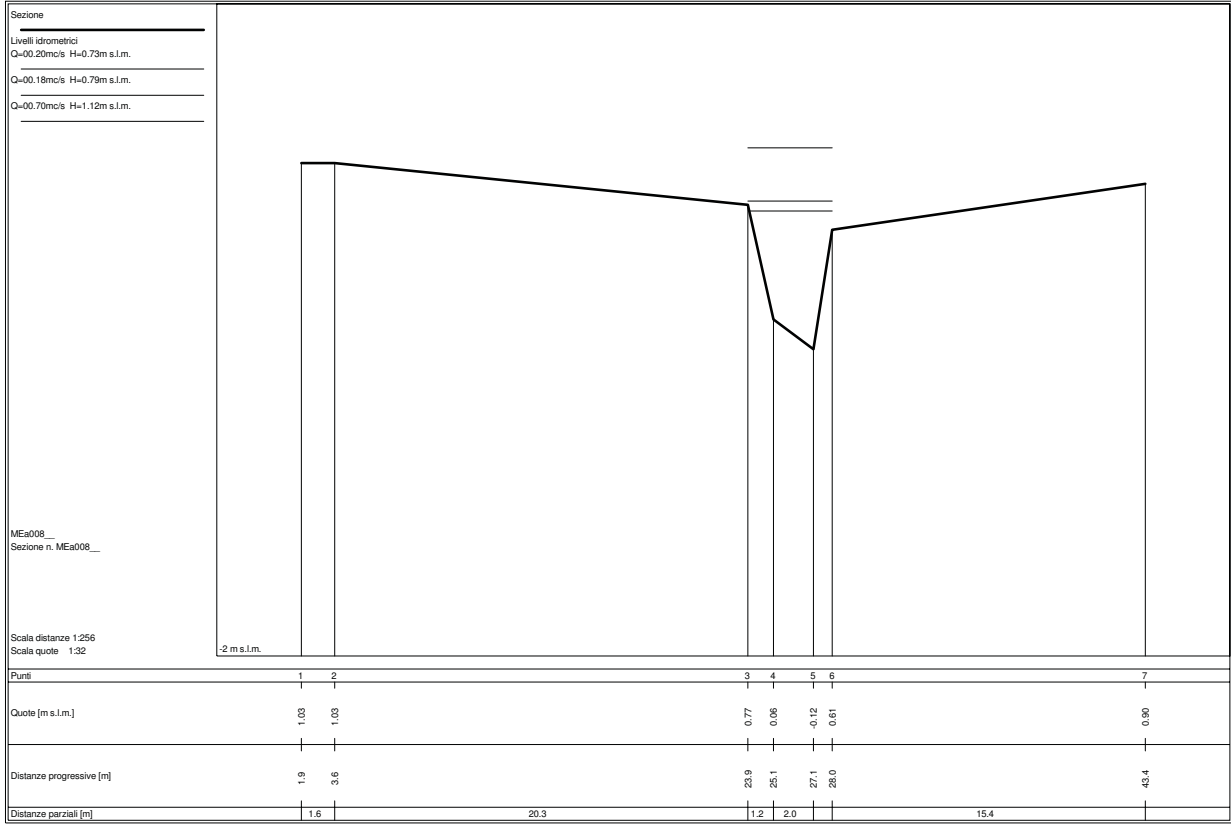

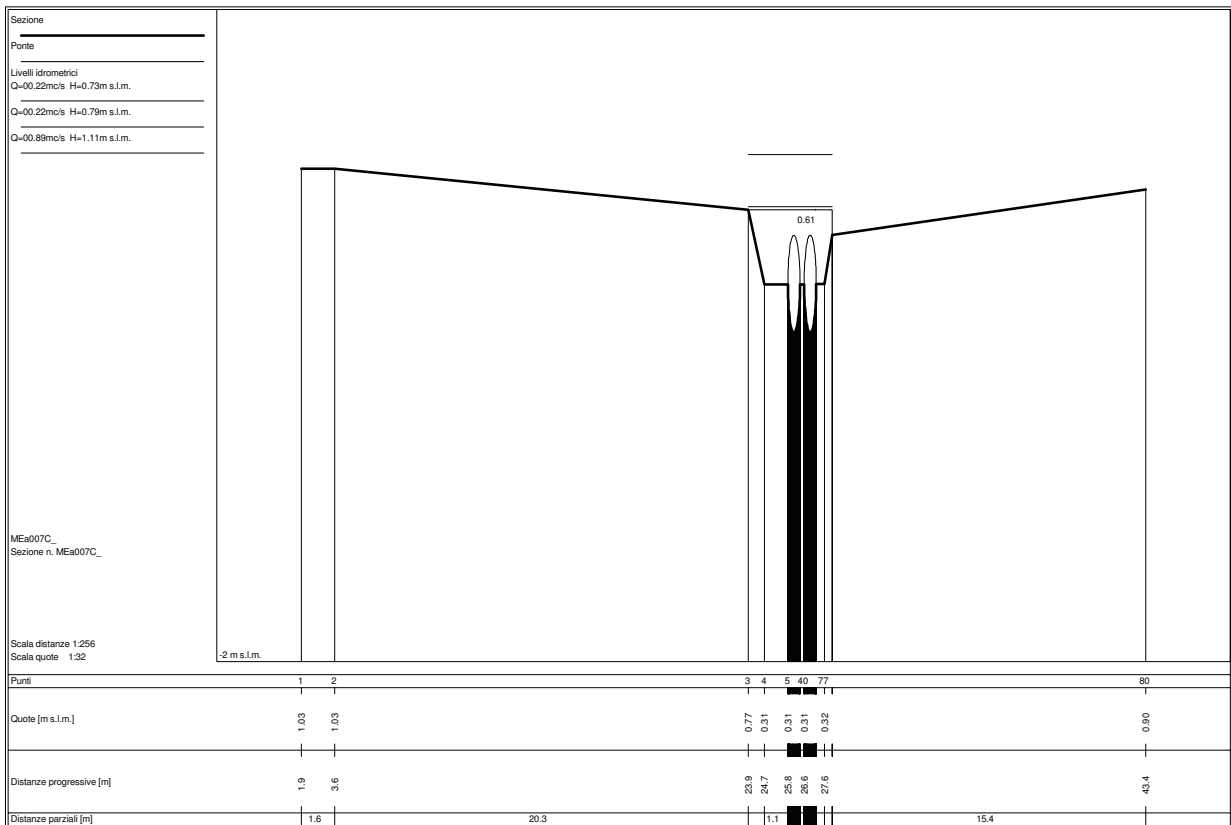
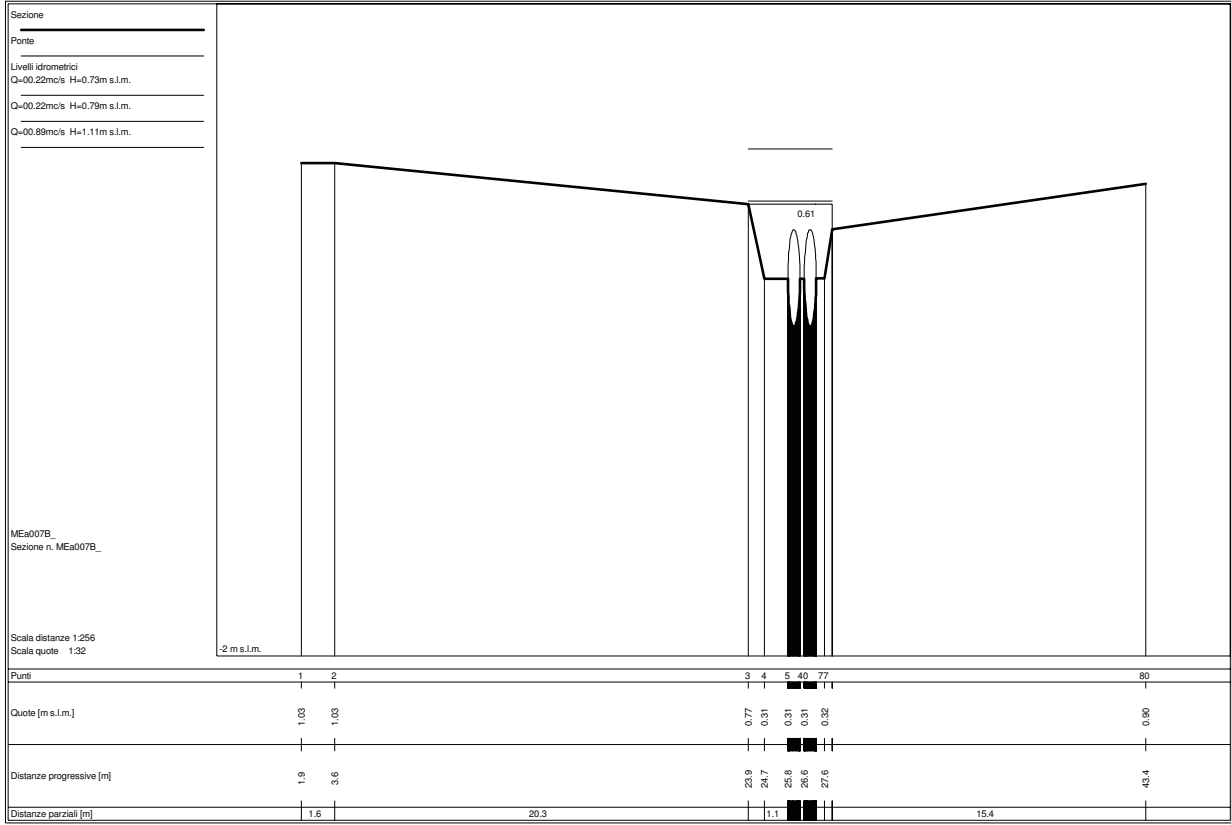

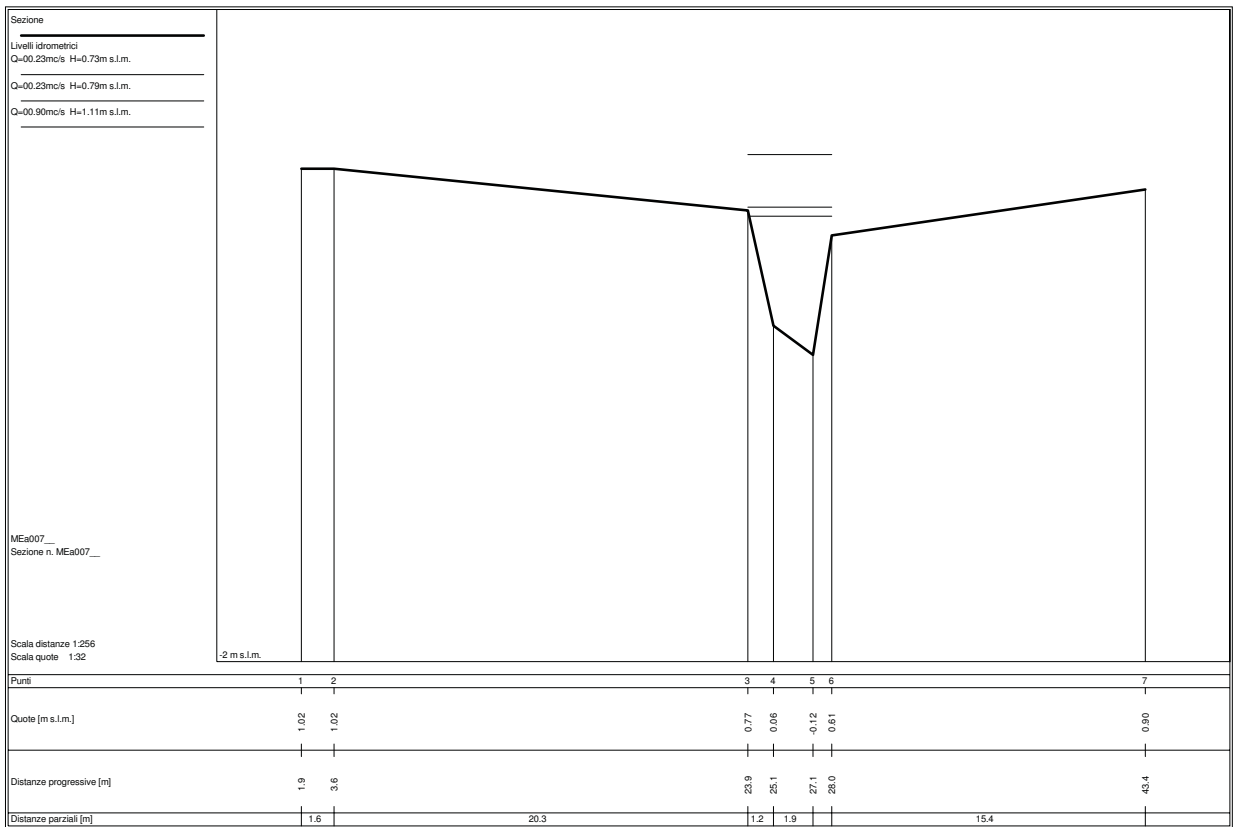
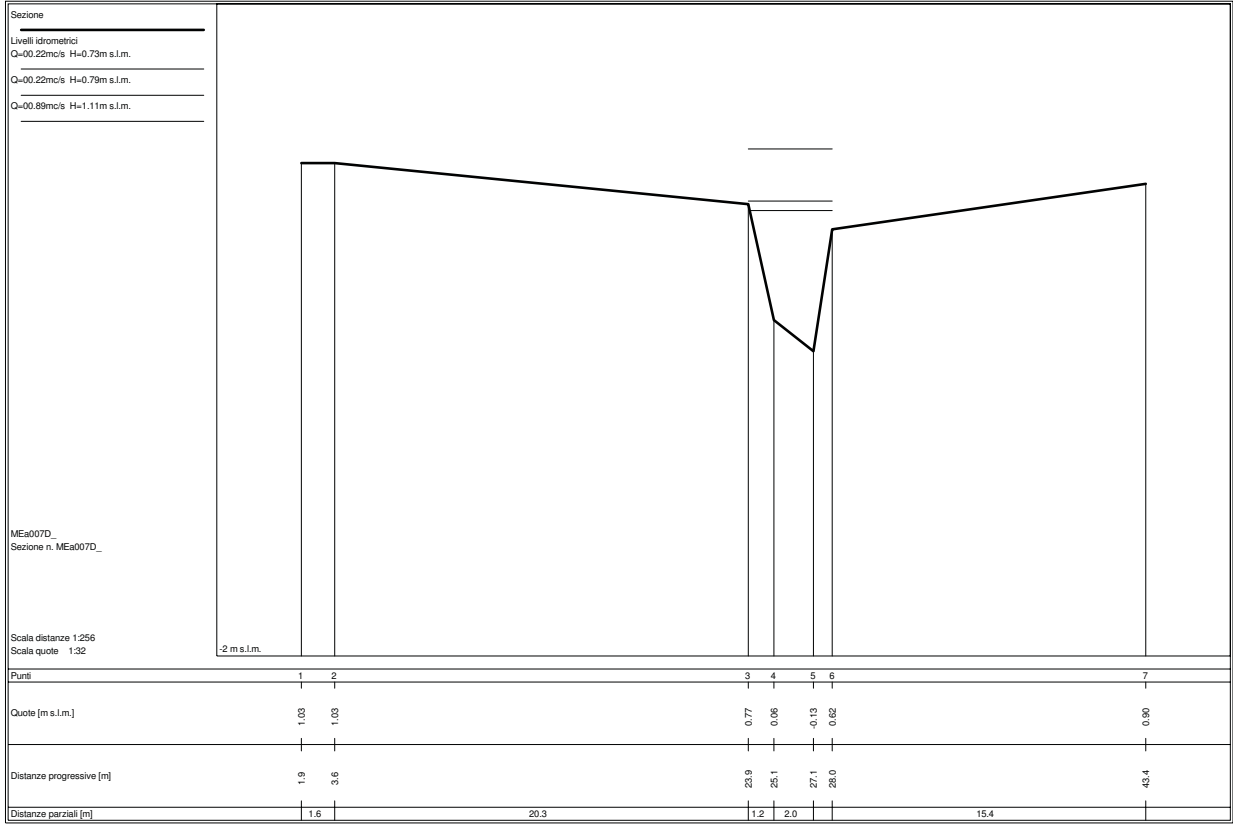

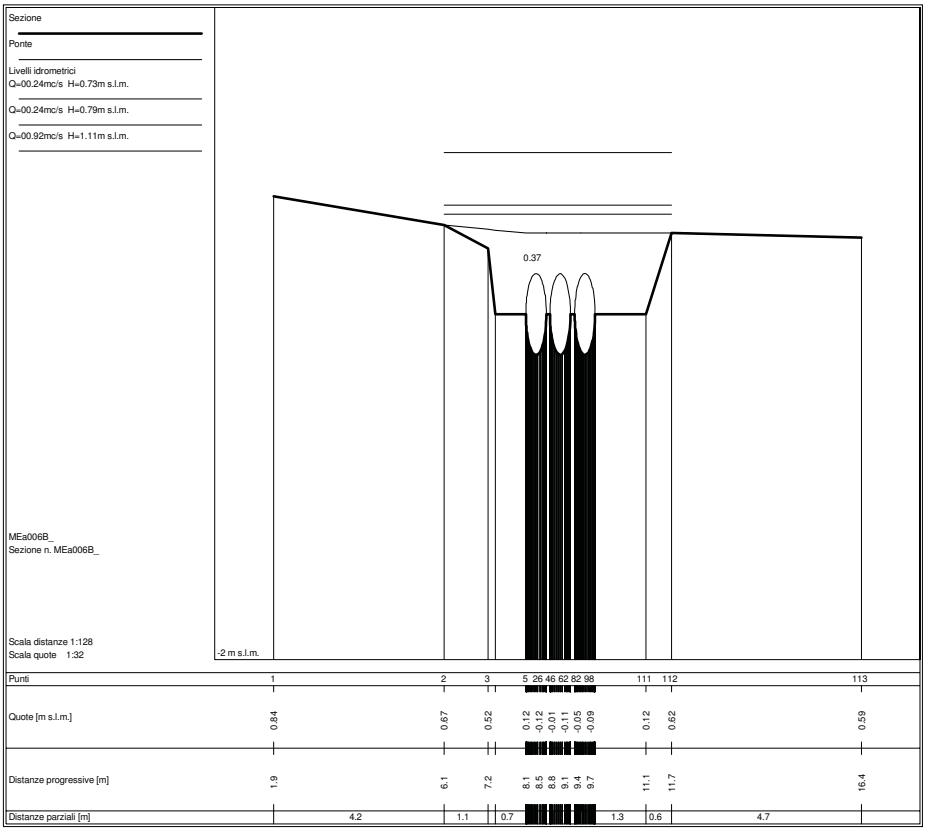
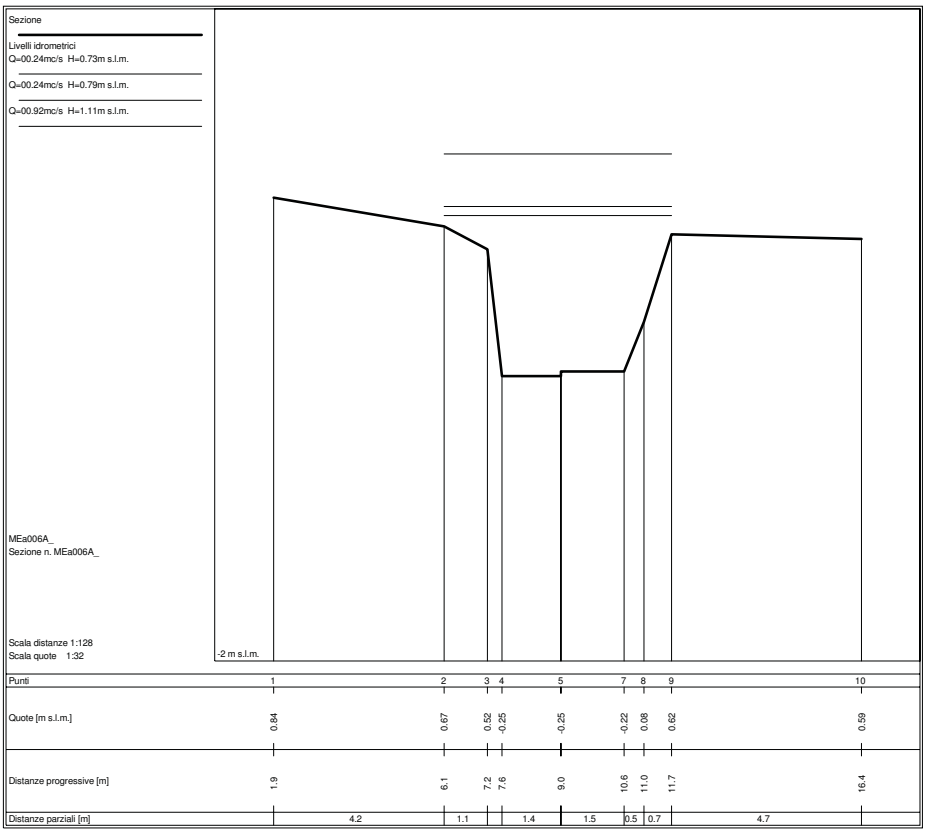

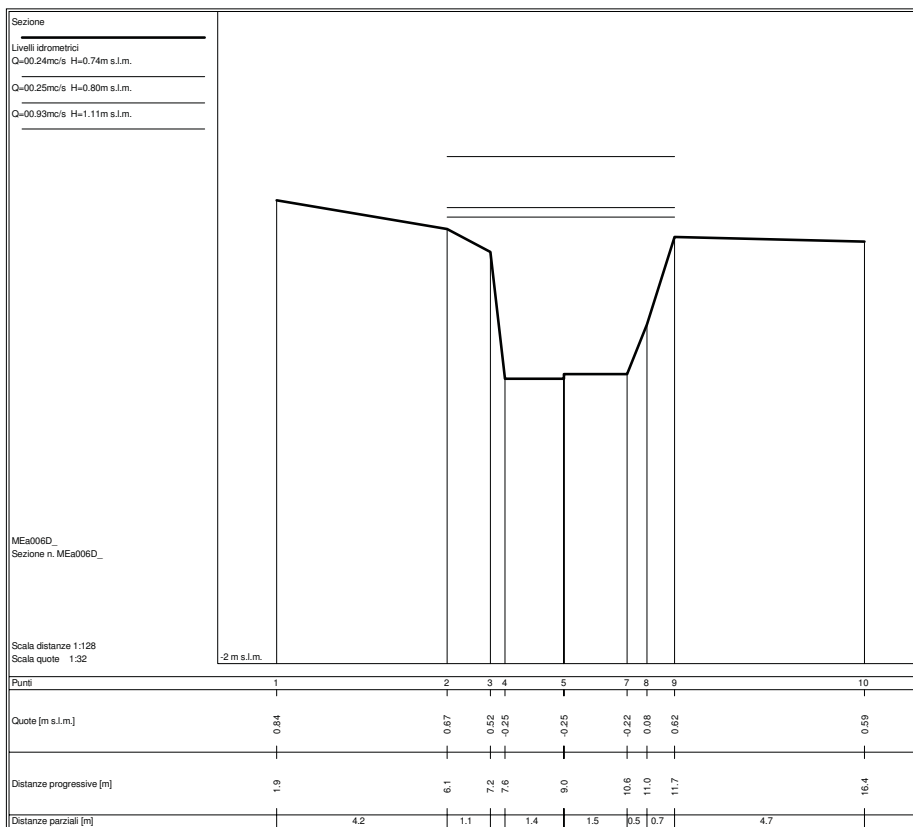
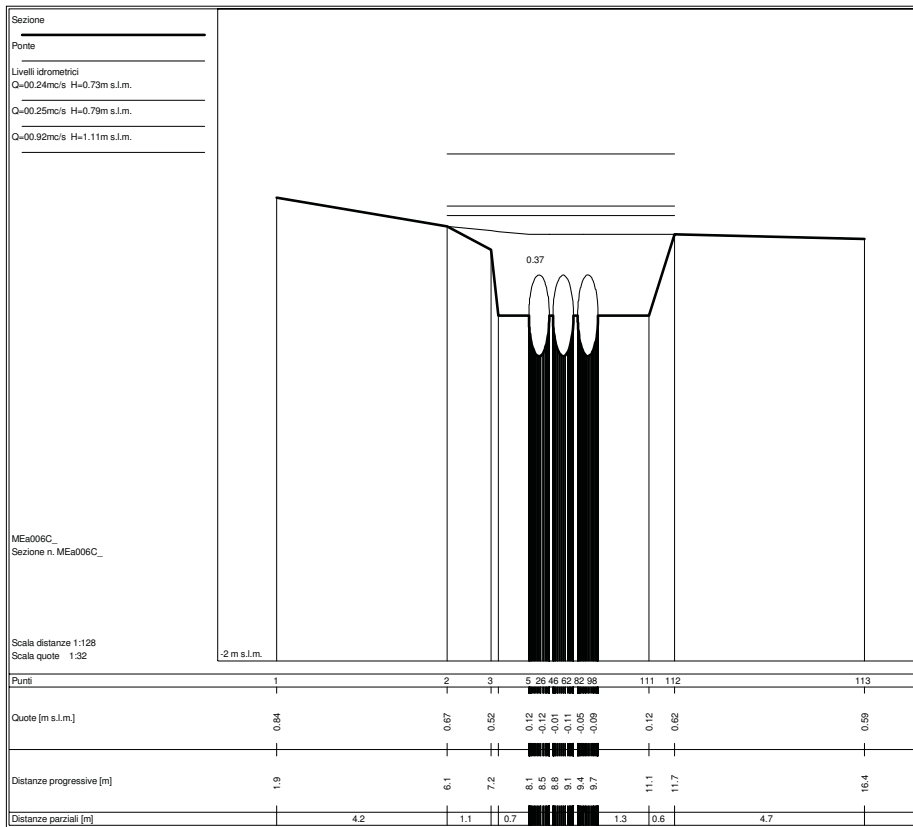

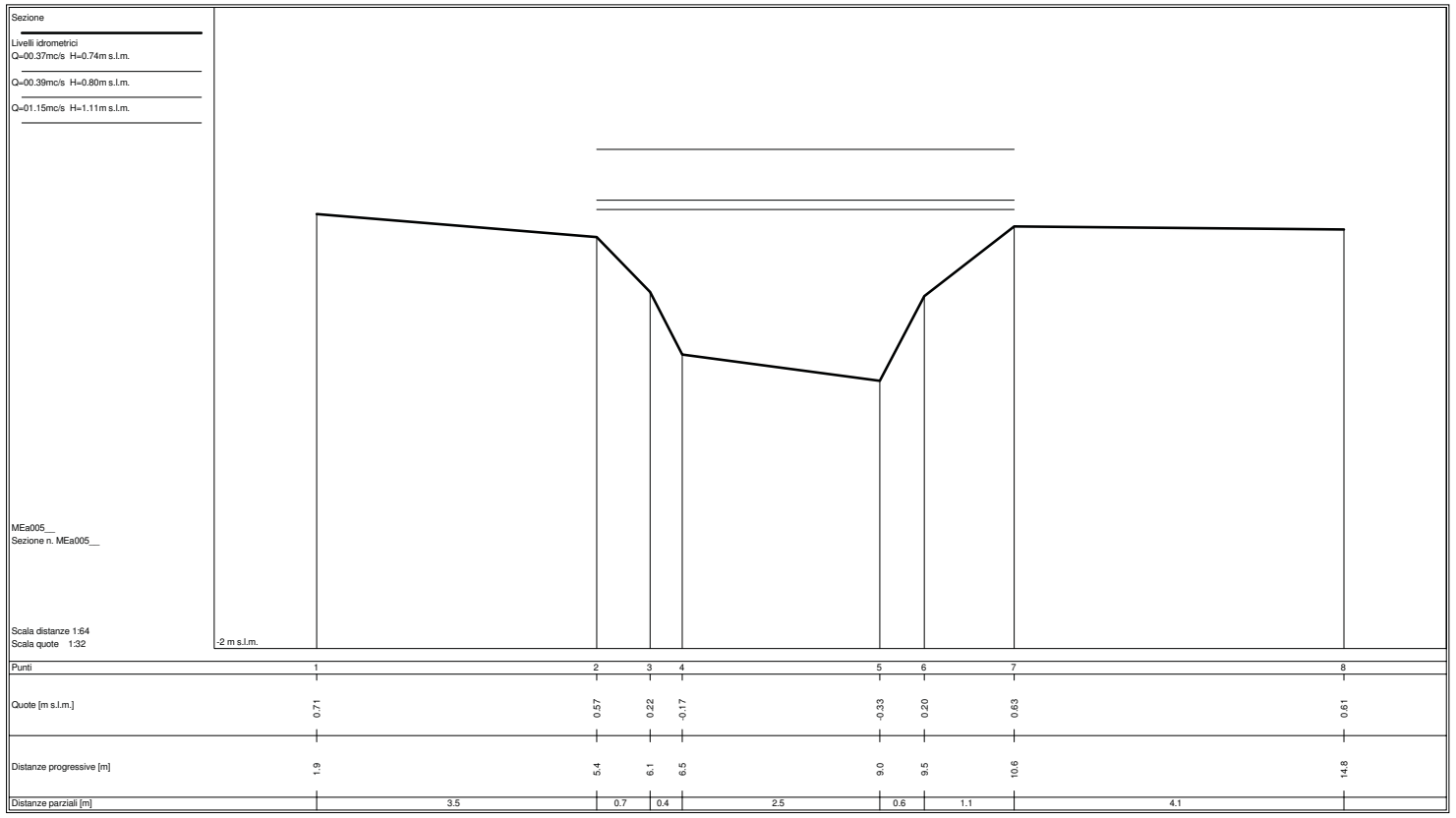
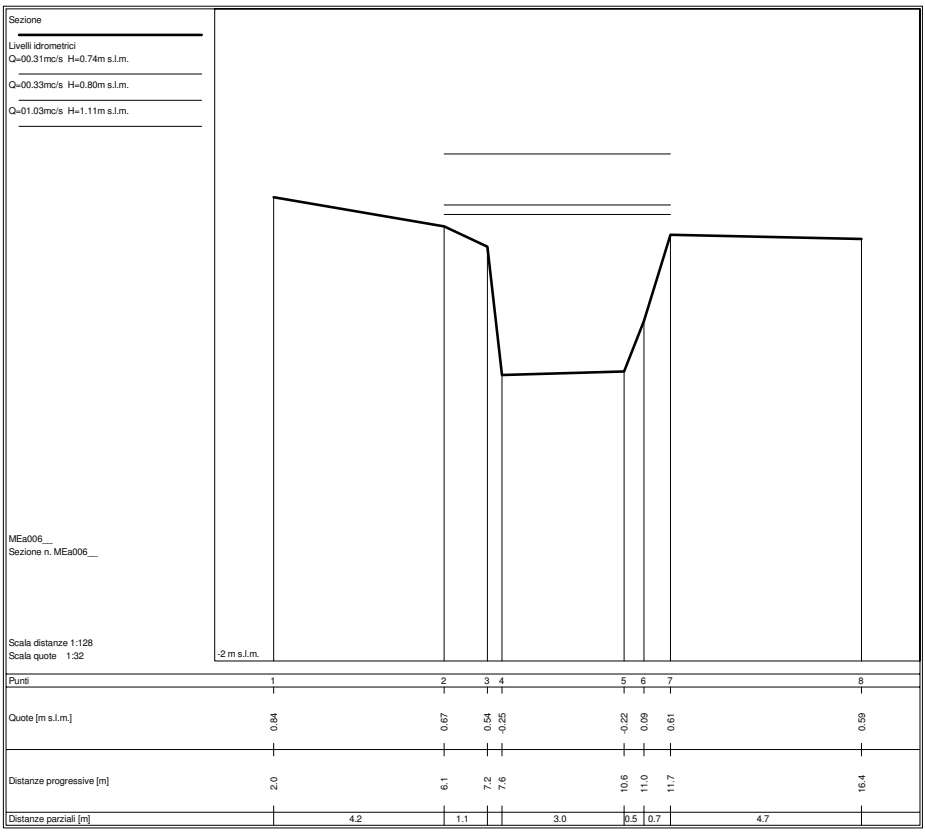



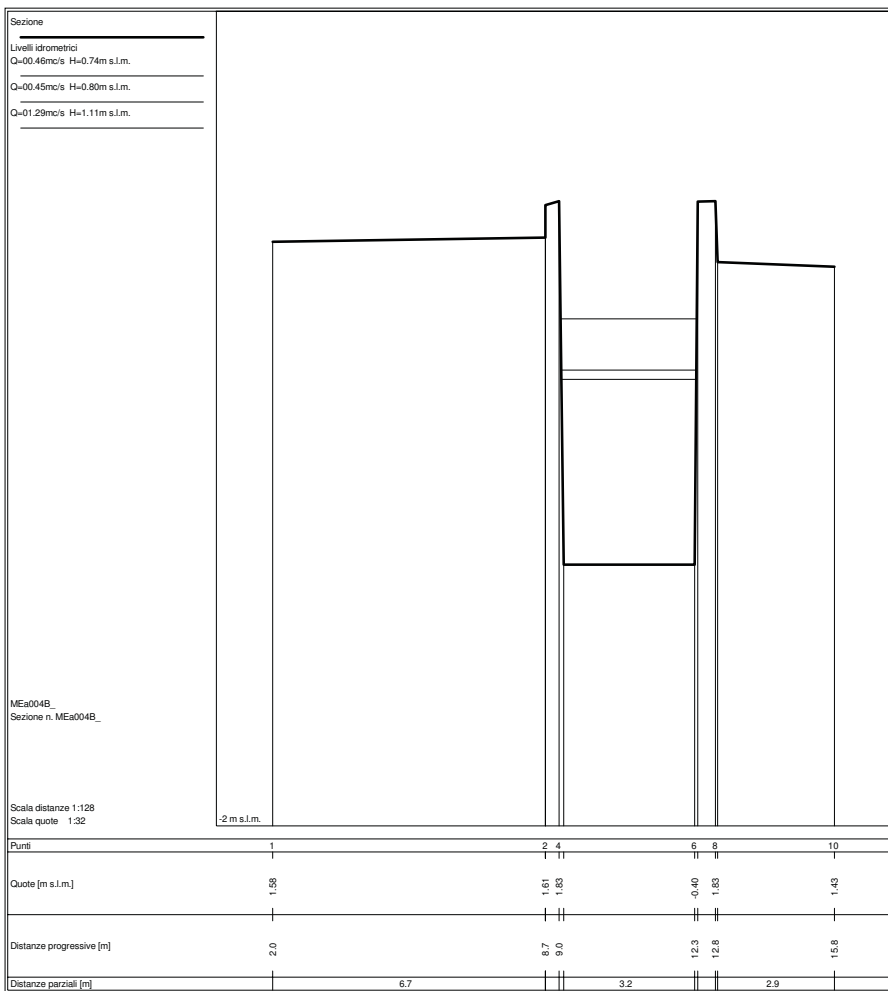
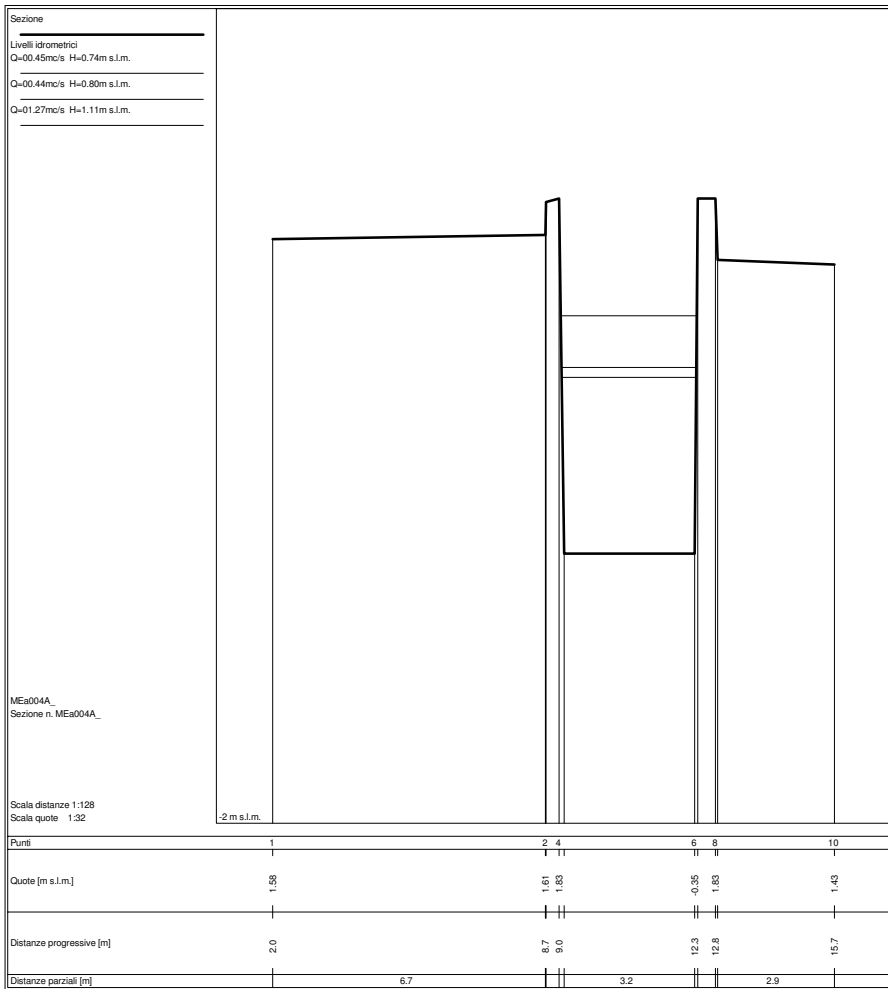

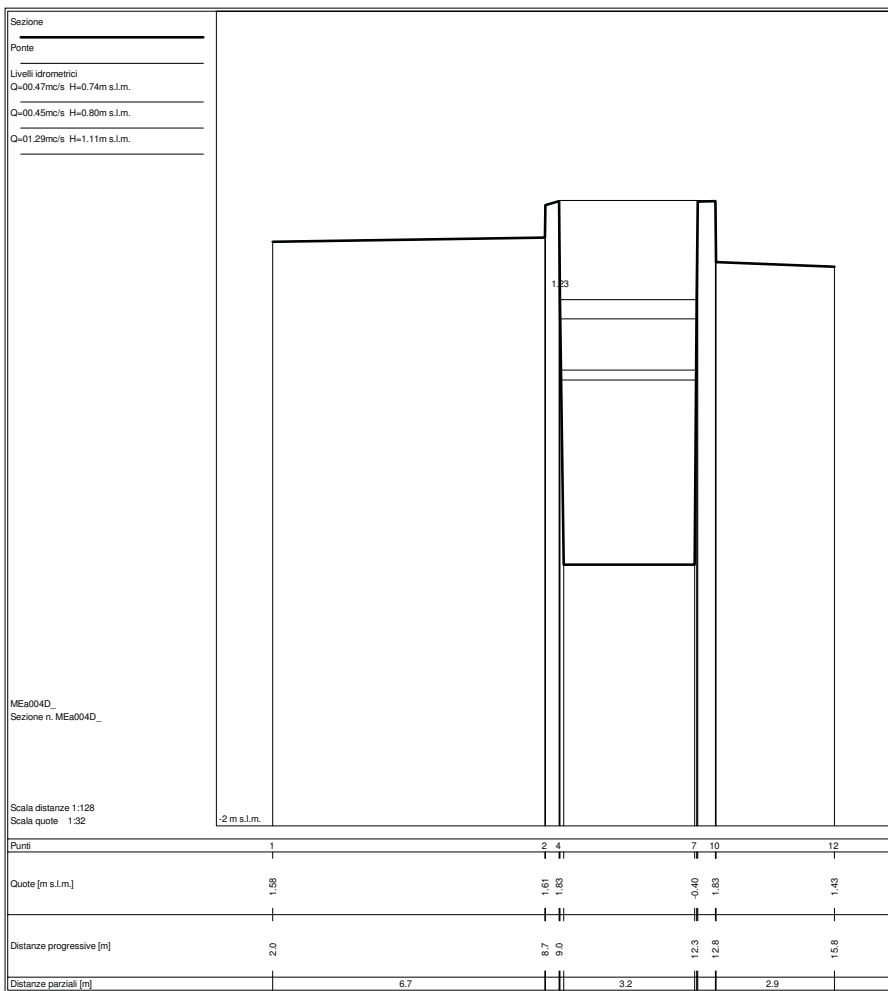
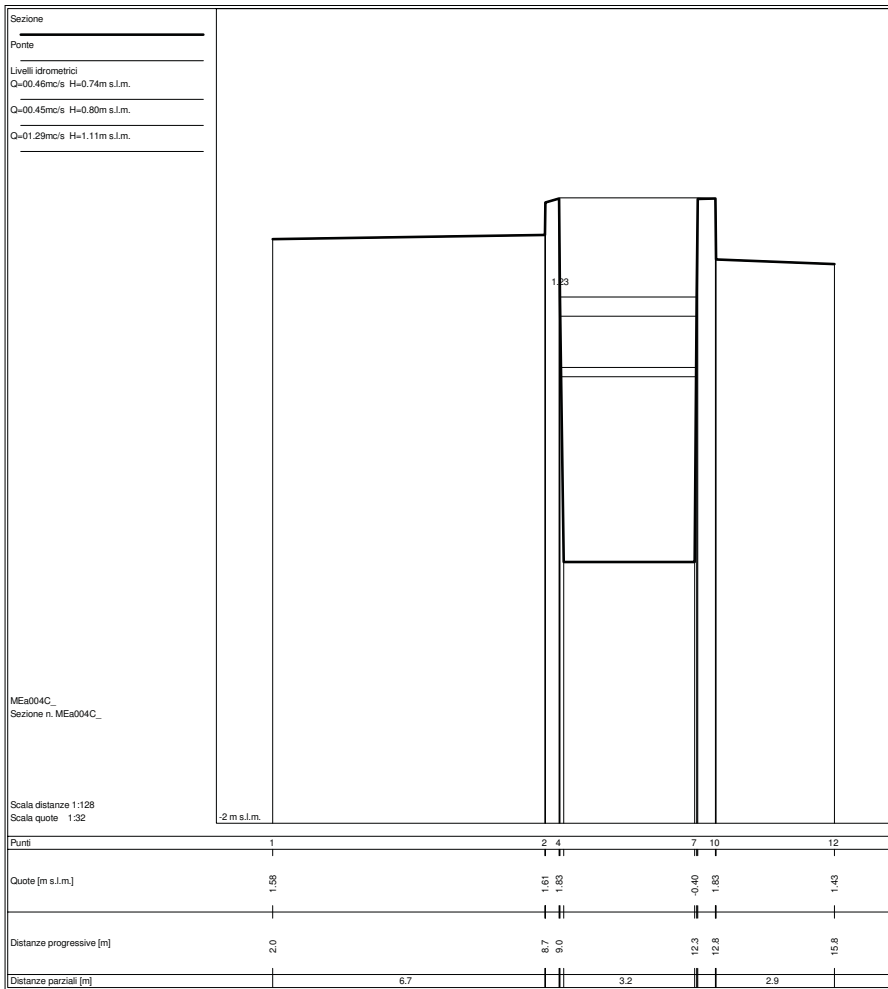

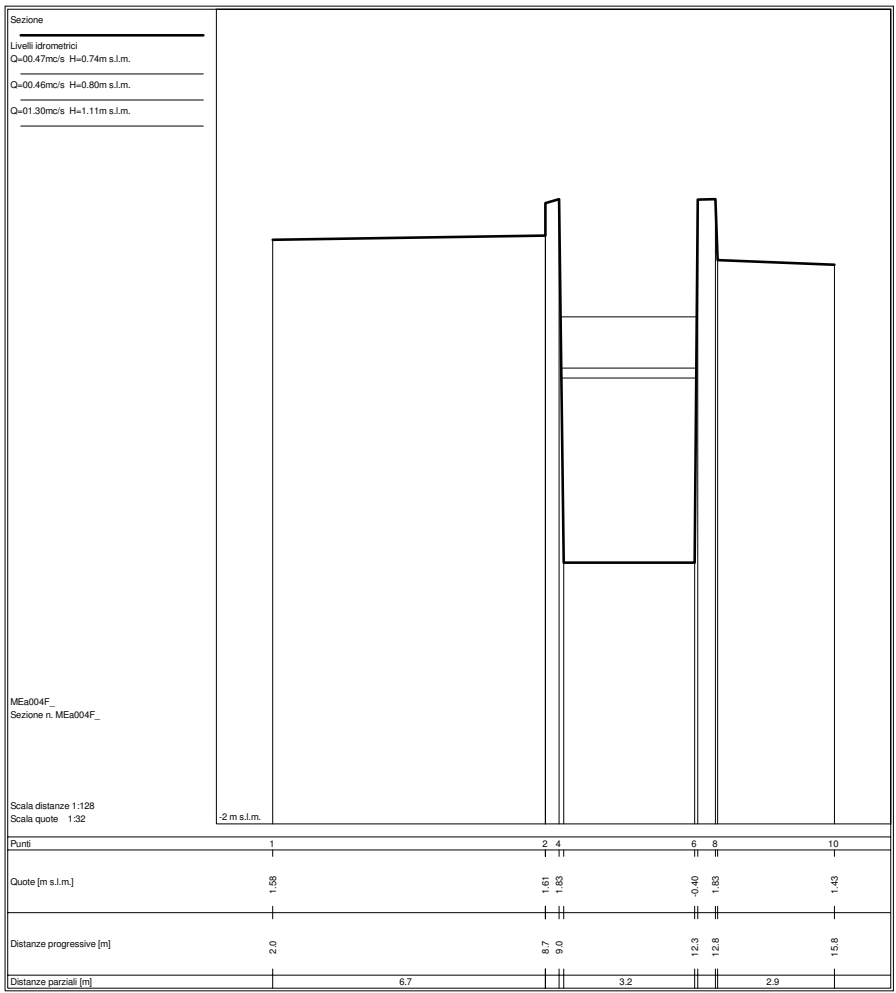
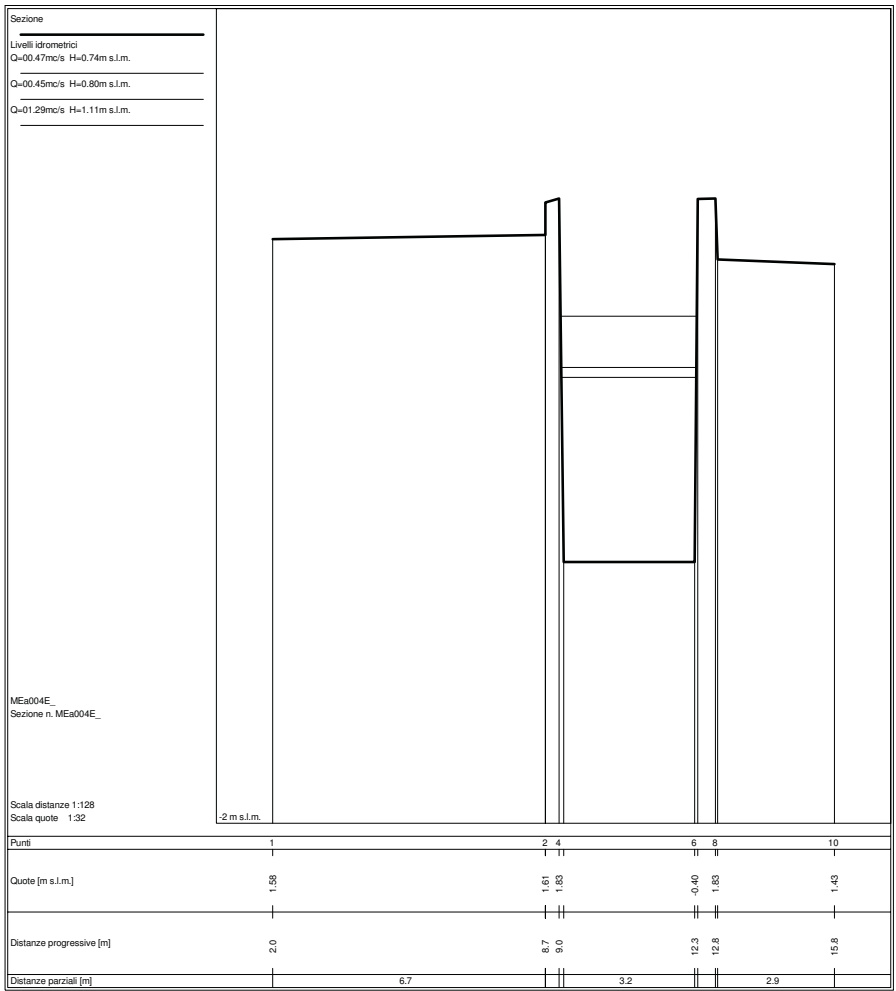

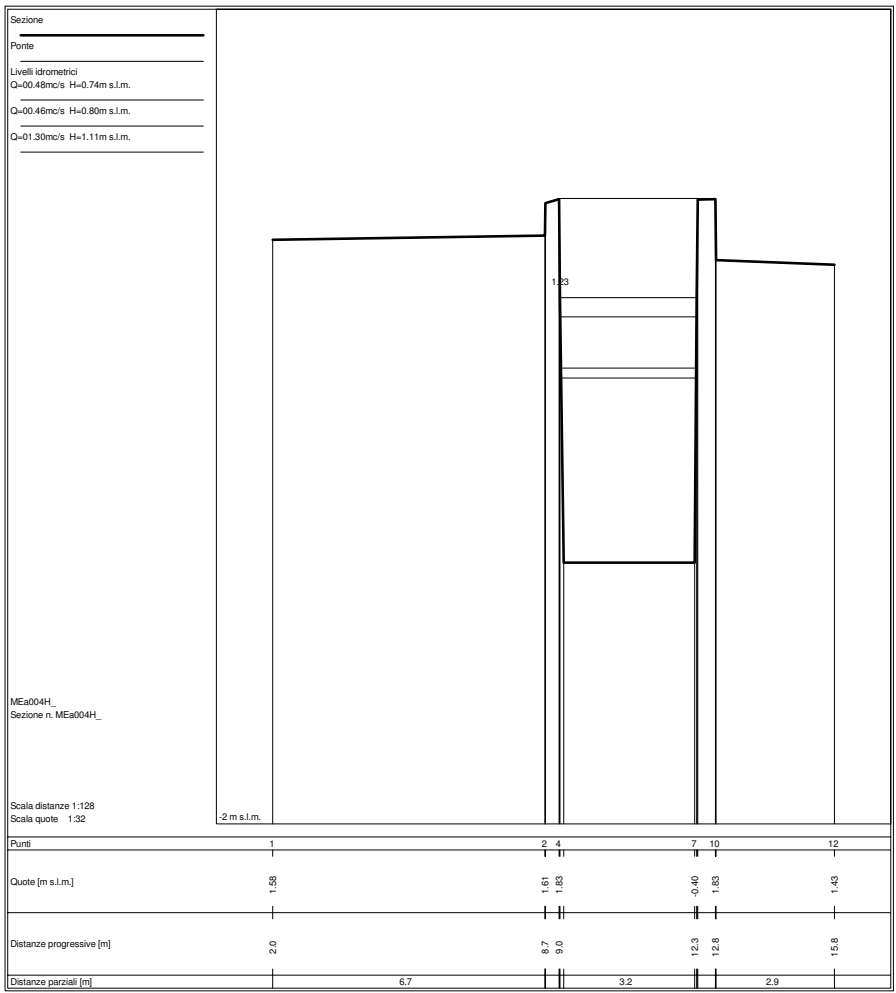
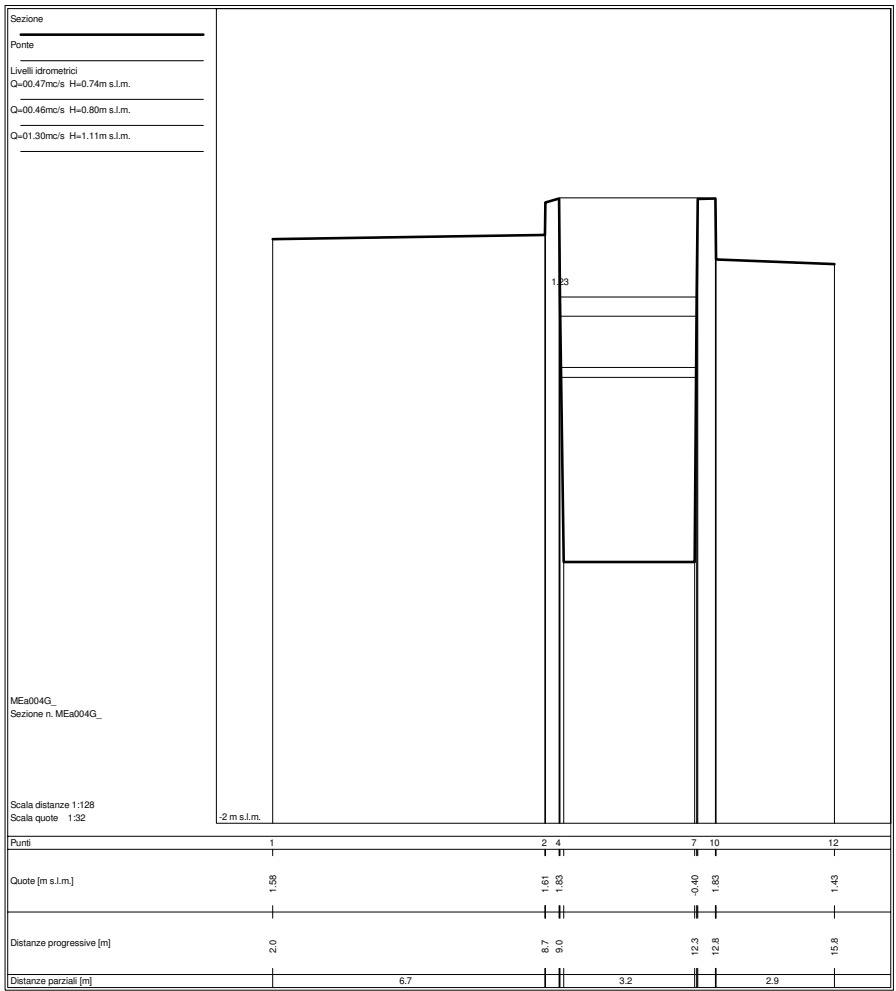

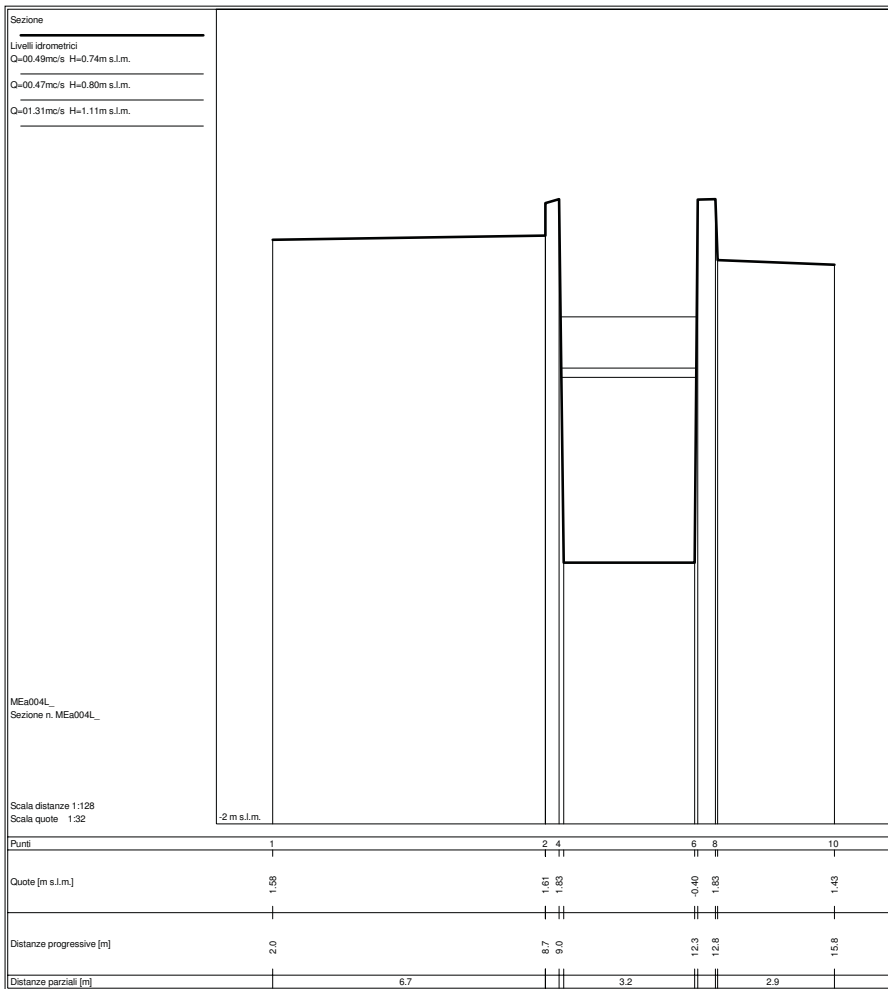
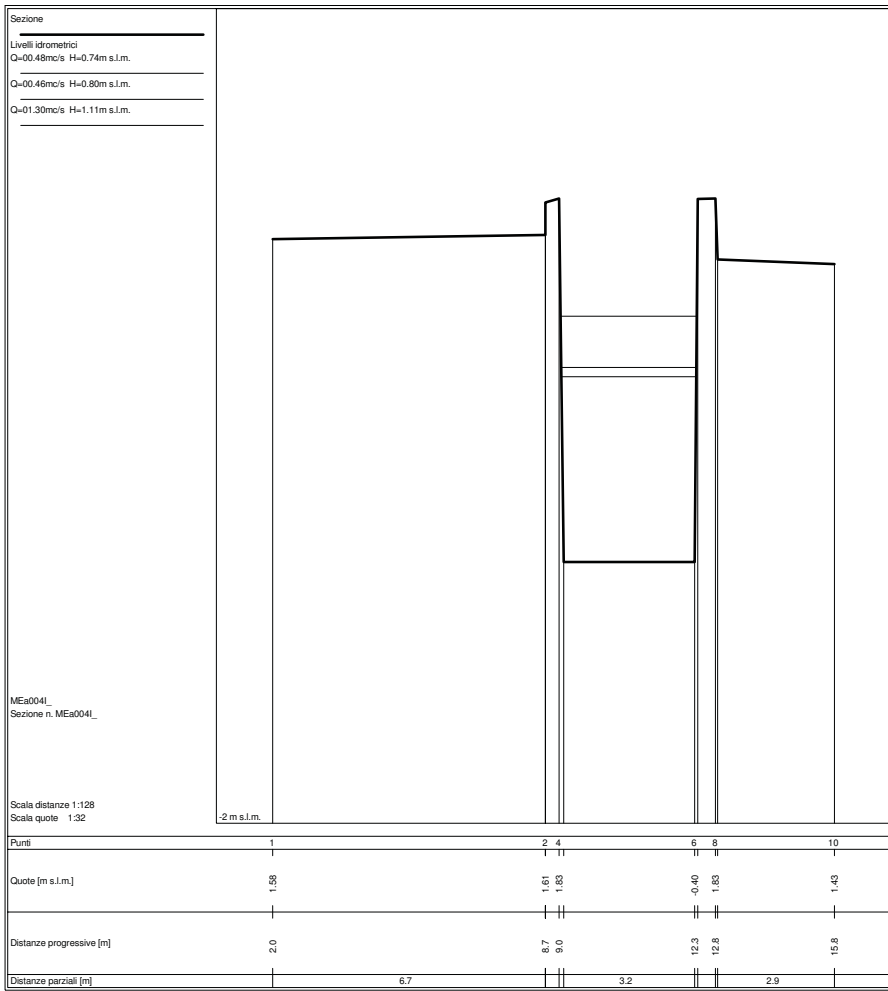

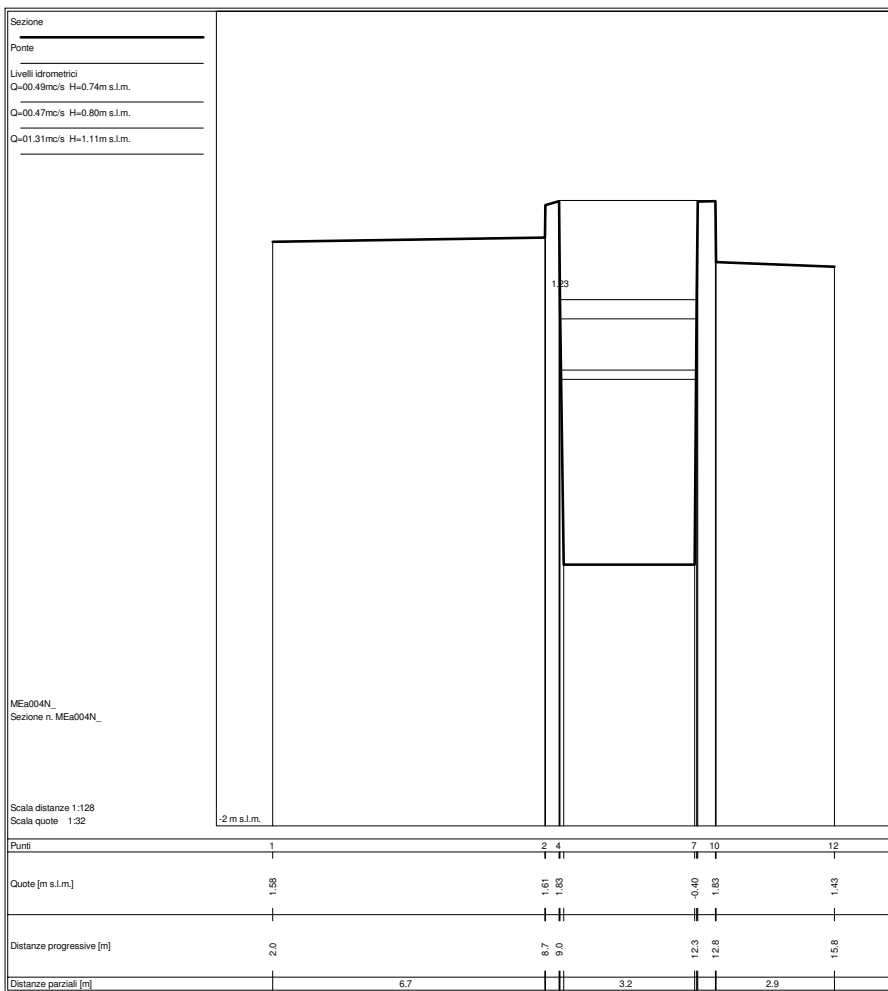
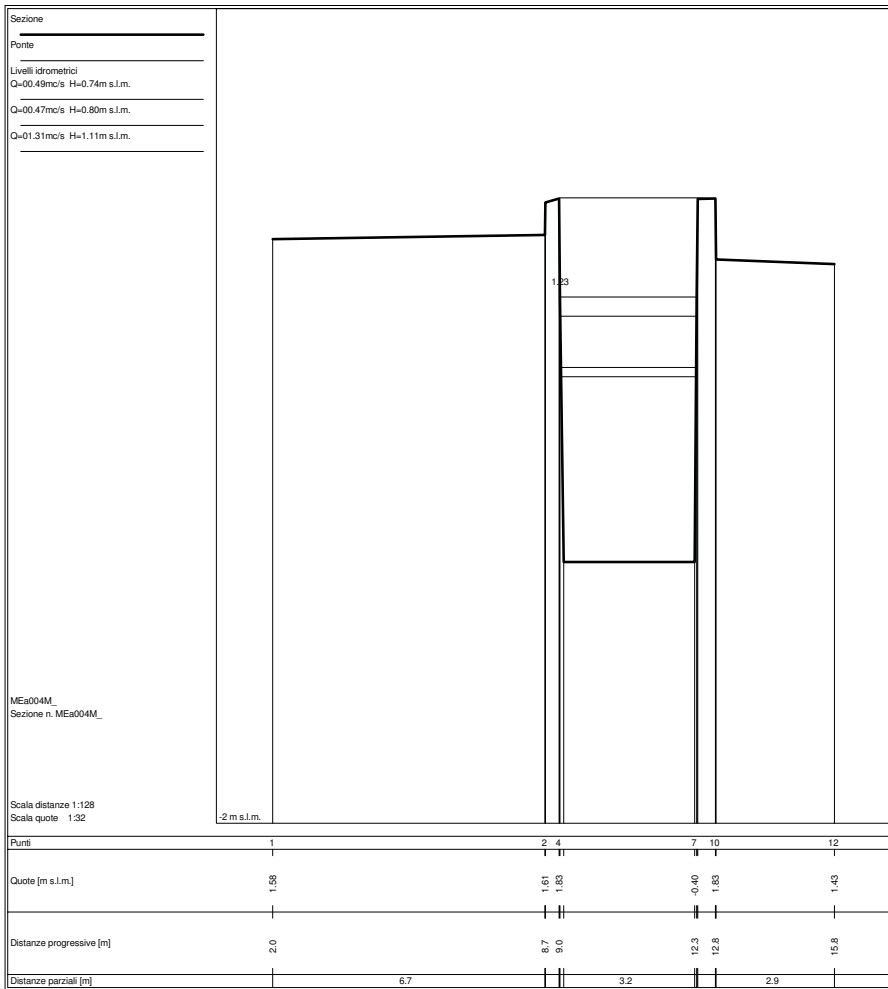

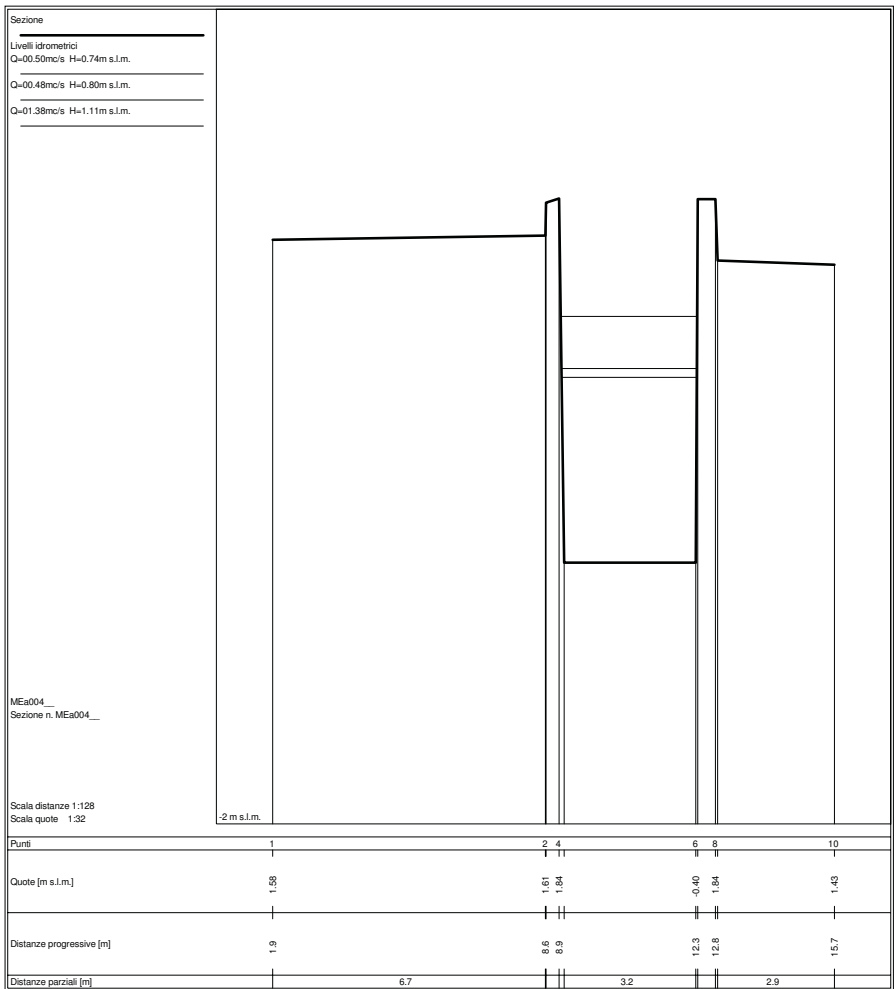
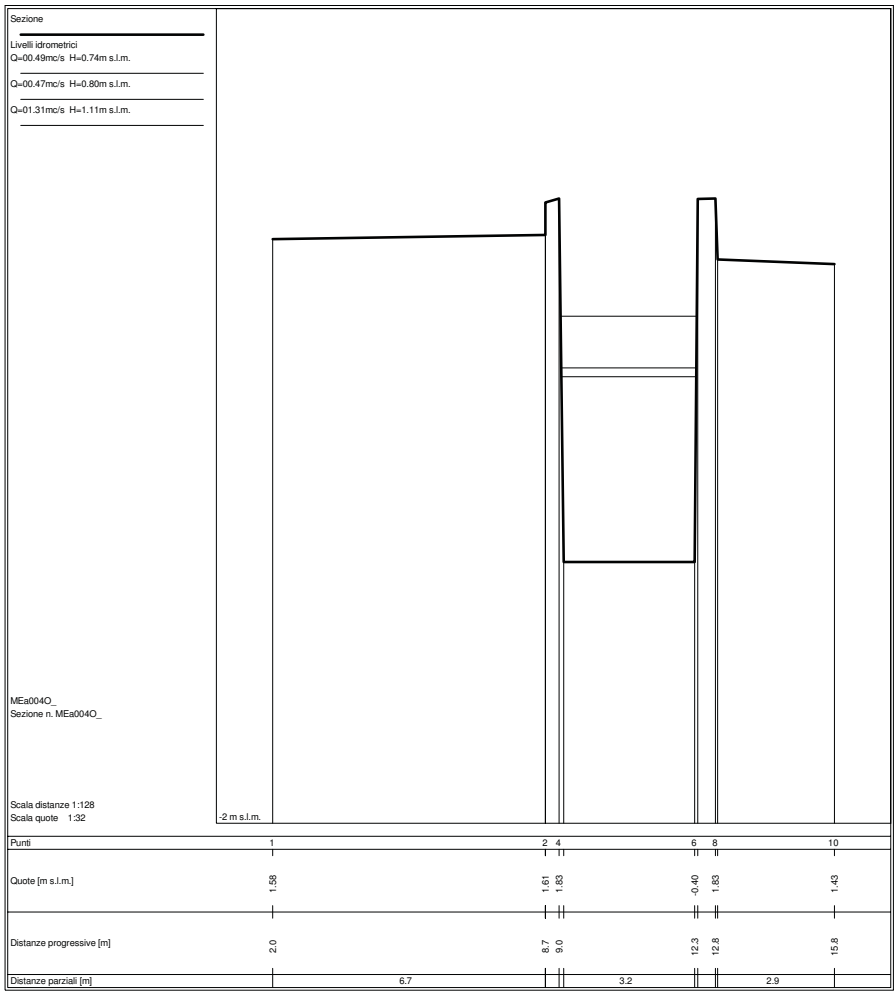

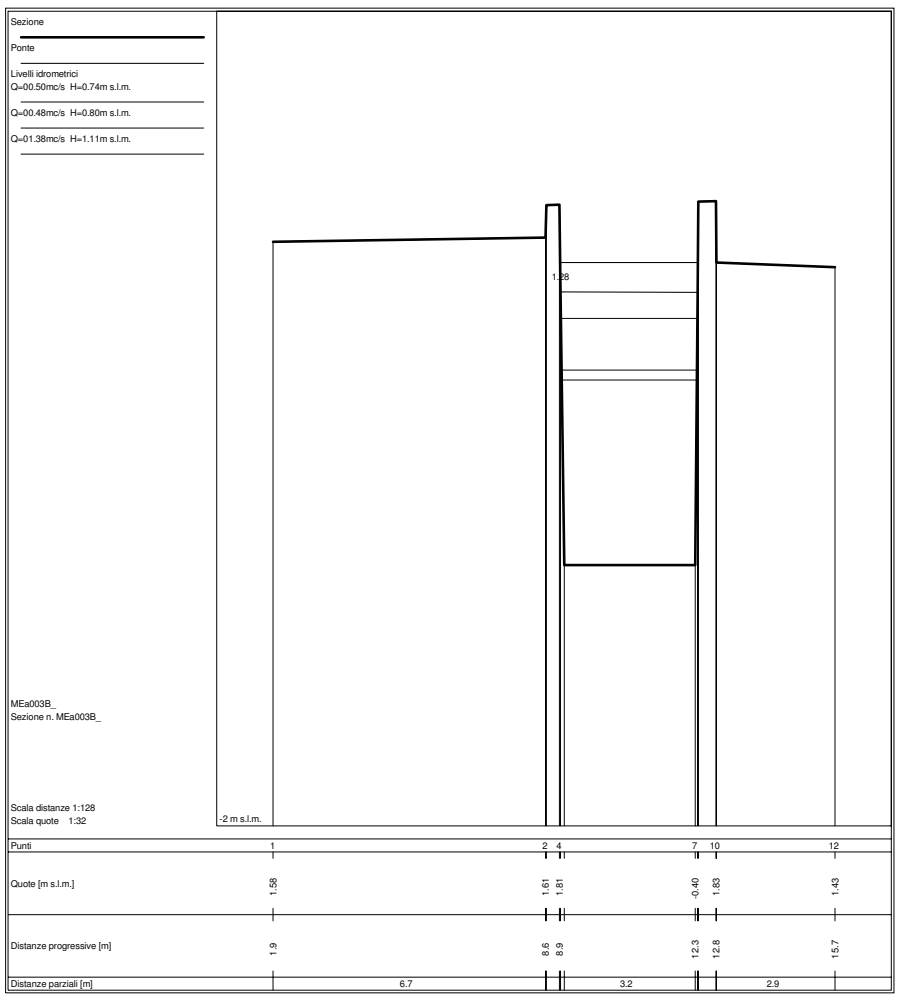
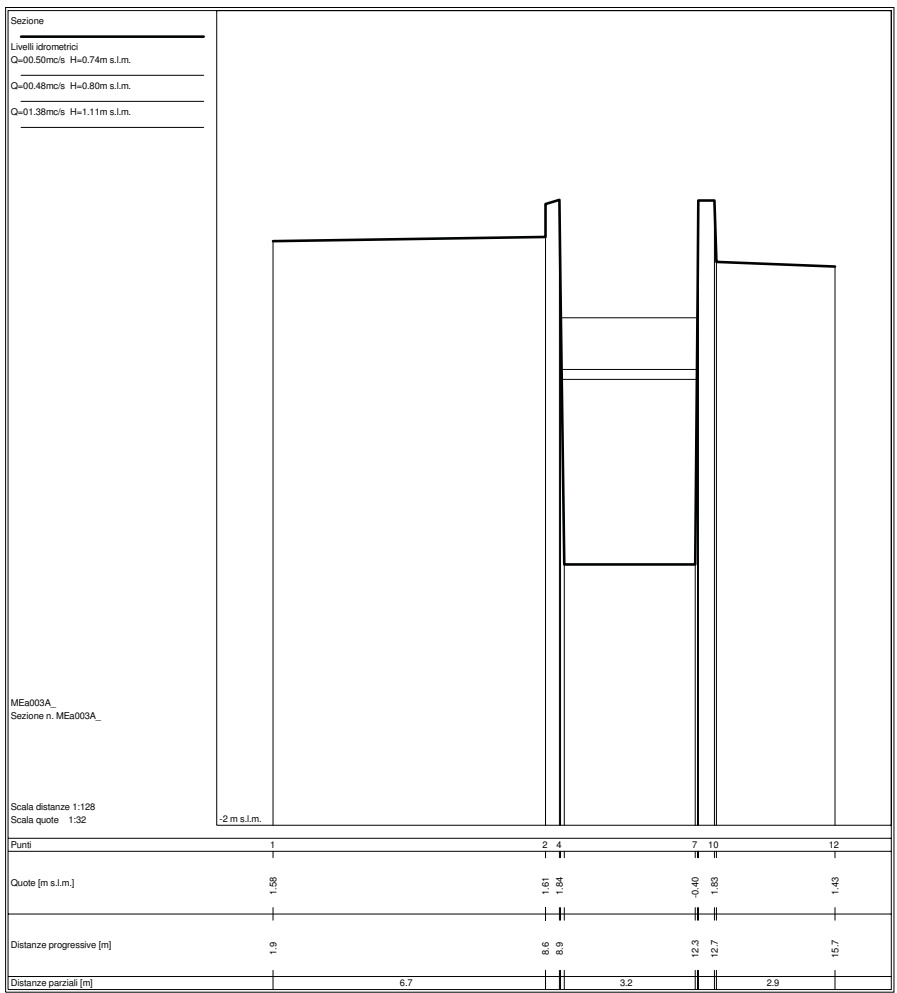



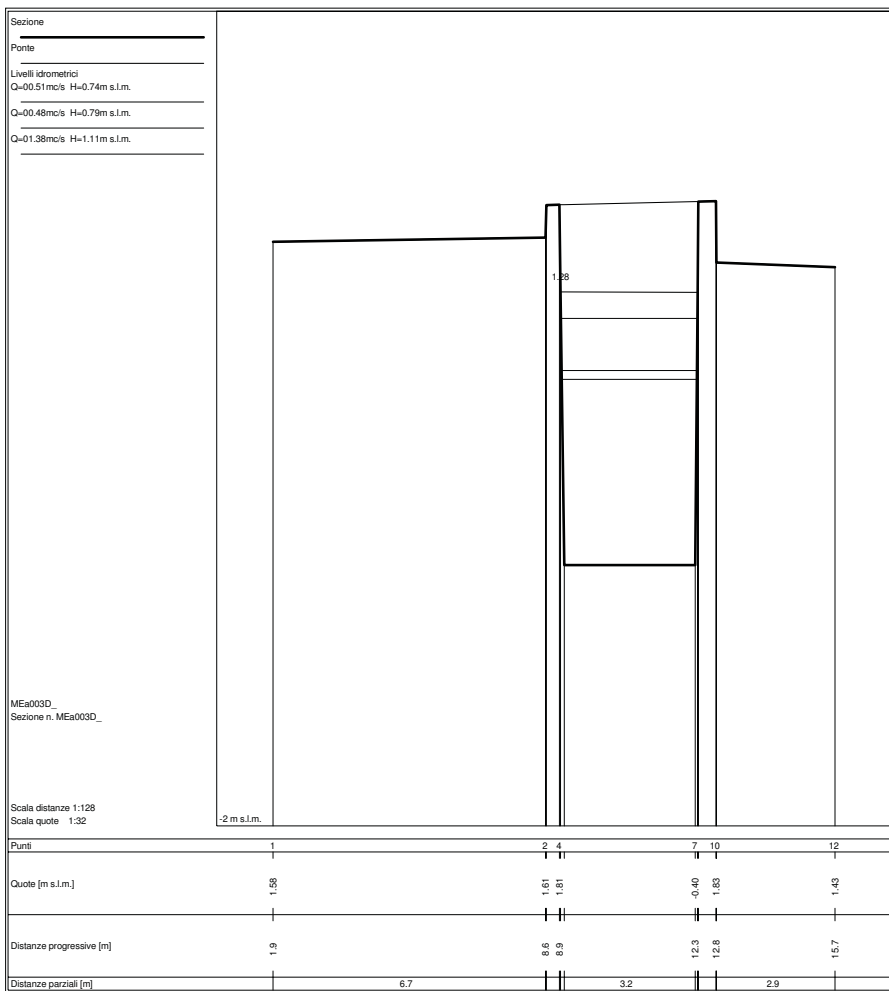
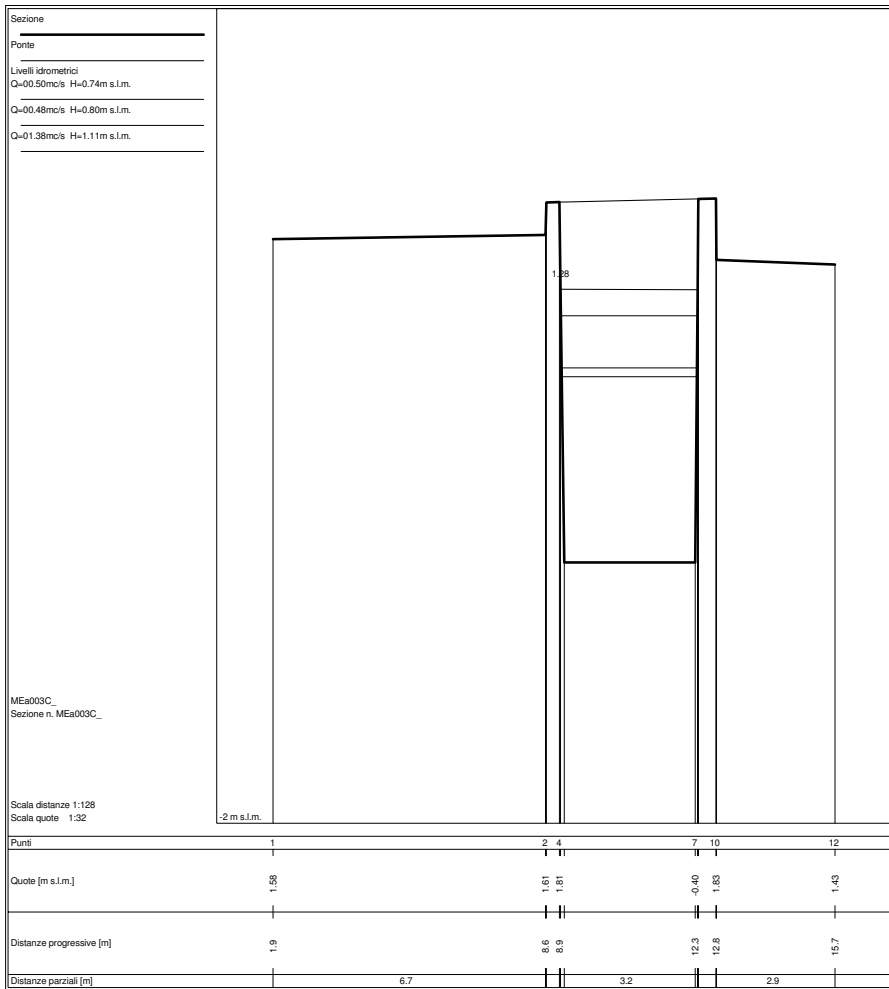

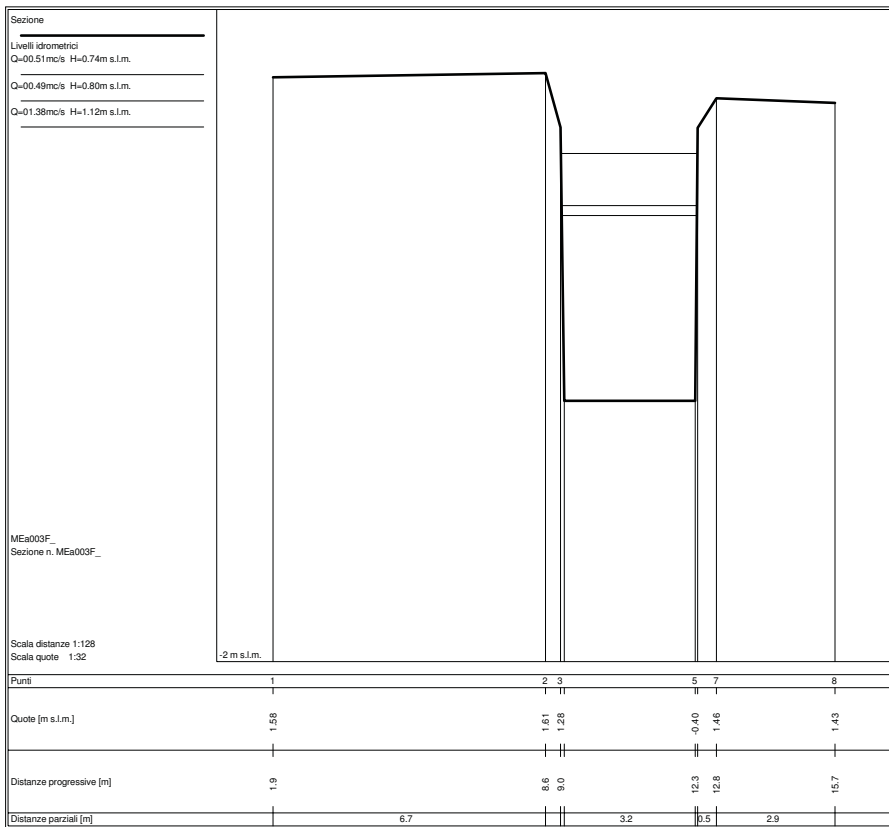
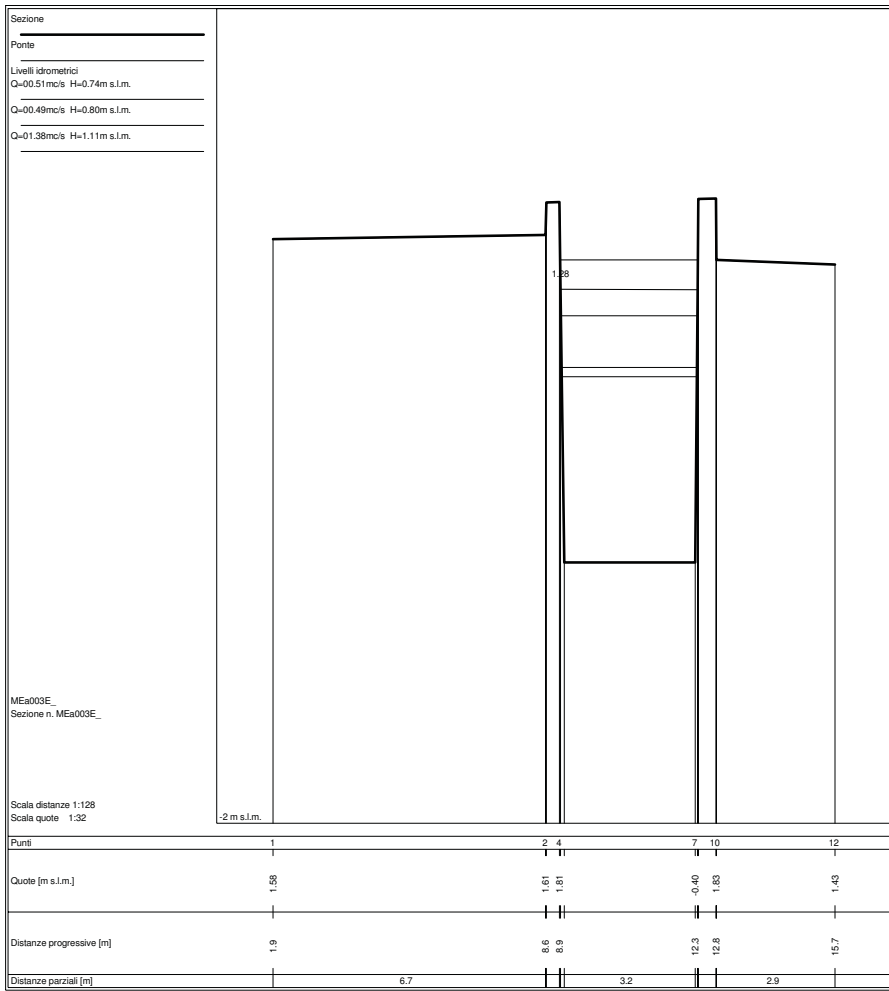

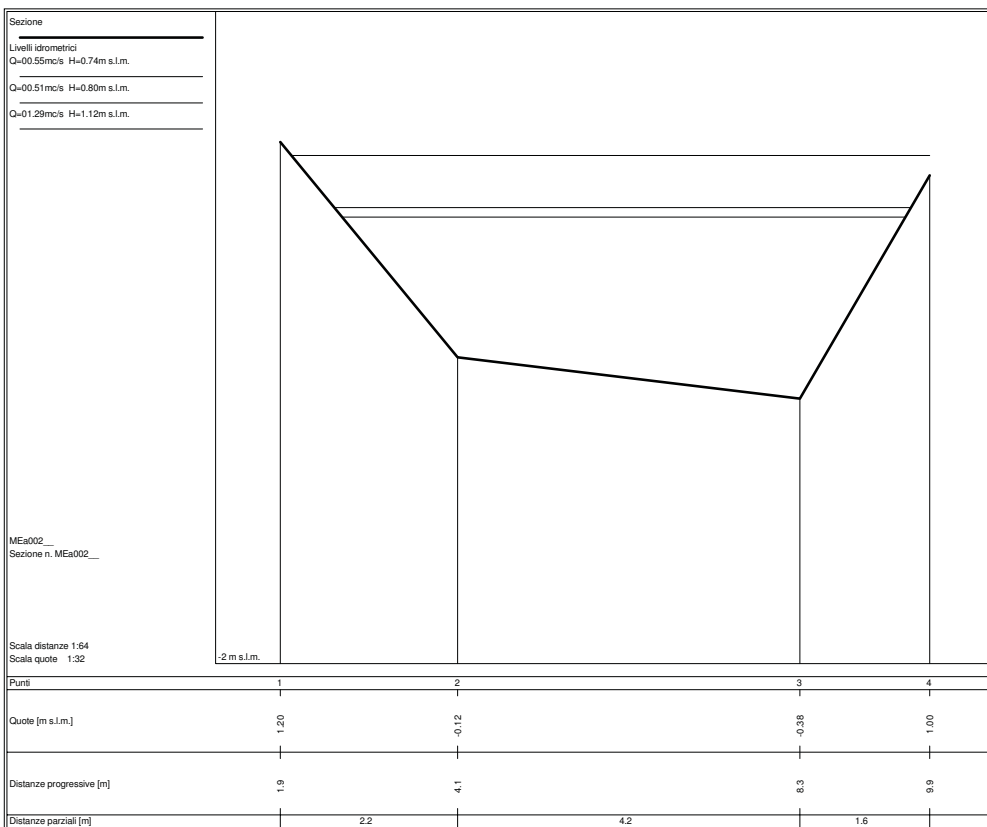
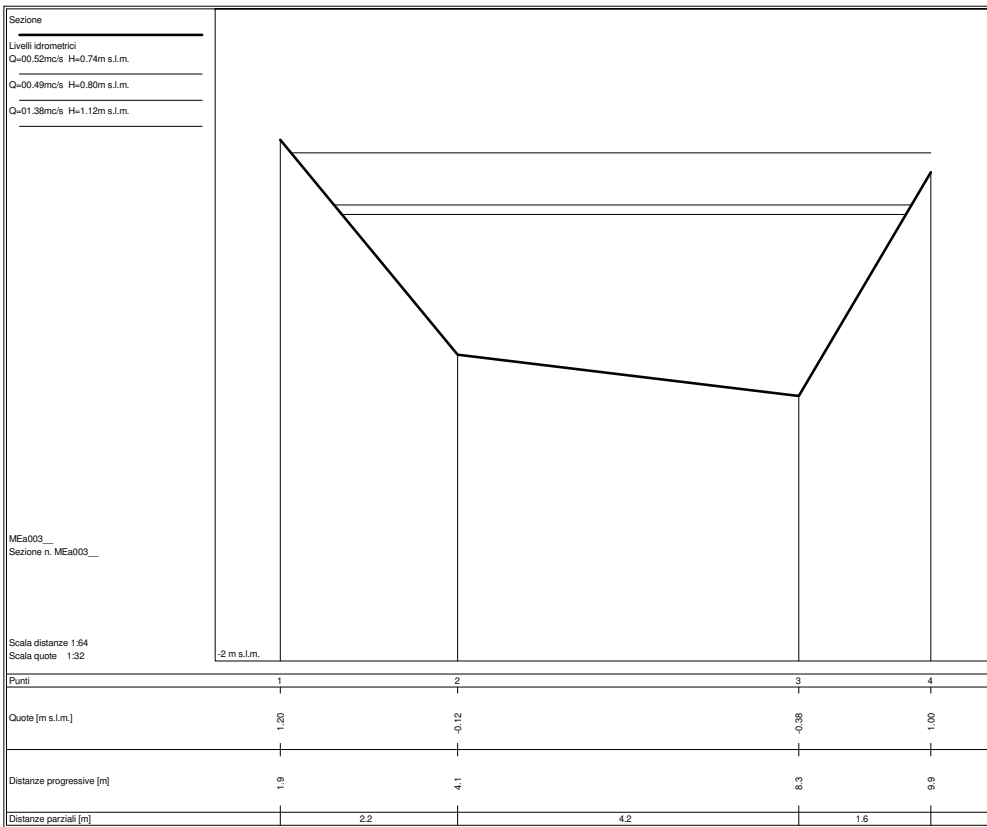

Sezione  
 Livelli idrometrici  
 Q=00.56m/s H=0.74m s.l.m.  
 Q=00.52m/s H=0.80m s.l.m.  
 Q=01.30m/s H=1.11m s.l.m.

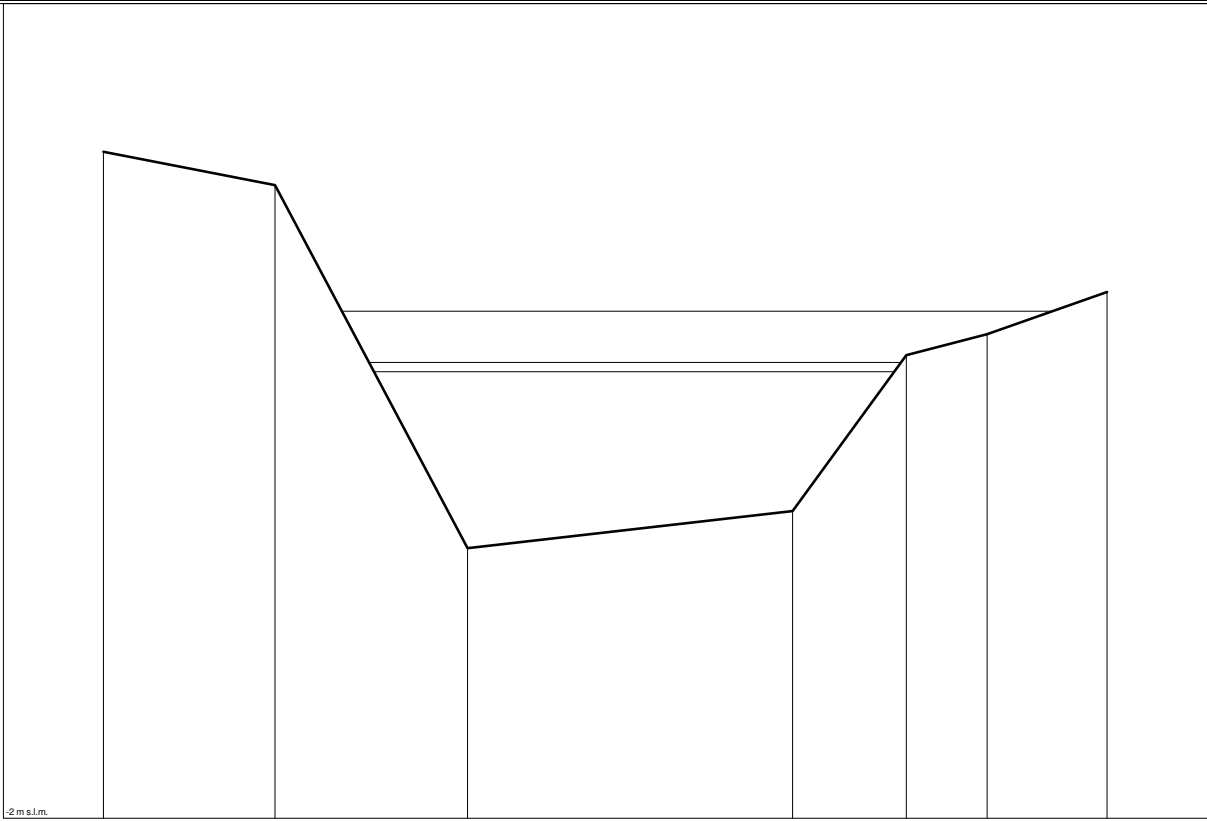

MEa001\_  
 Sezione n. MEa001\_

Scala distanze 1:64  
 Scala quote 1:32

2 m s.l.m.

| Punti                    | 1    | 2    | 3     | 4     | 5    | 6    | 7    |
|--------------------------|------|------|-------|-------|------|------|------|
| Quote [m s.l.m.]         | 2.09 | 1.89 | -0.34 | -0.12 | 0.84 | 0.97 | 1.23 |
| Distanze progressive [m] | 1.9  | 4.0  | 6.3   | 10.3  | 11.7 | 12.7 | 14.2 |
| Distanze parziali [m]    |      | 2.1  | 2.4   | 4.0   | 1.4  | 1.0  | 1.5  |

## **FOSSO DI MEZZO – RAMO B**

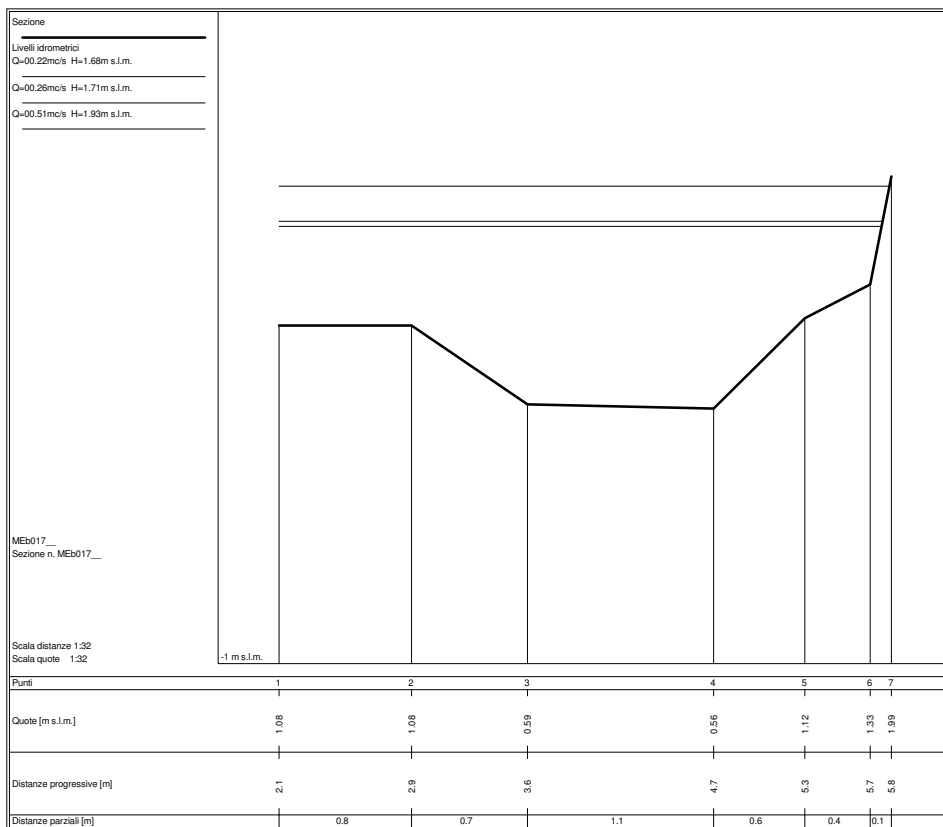
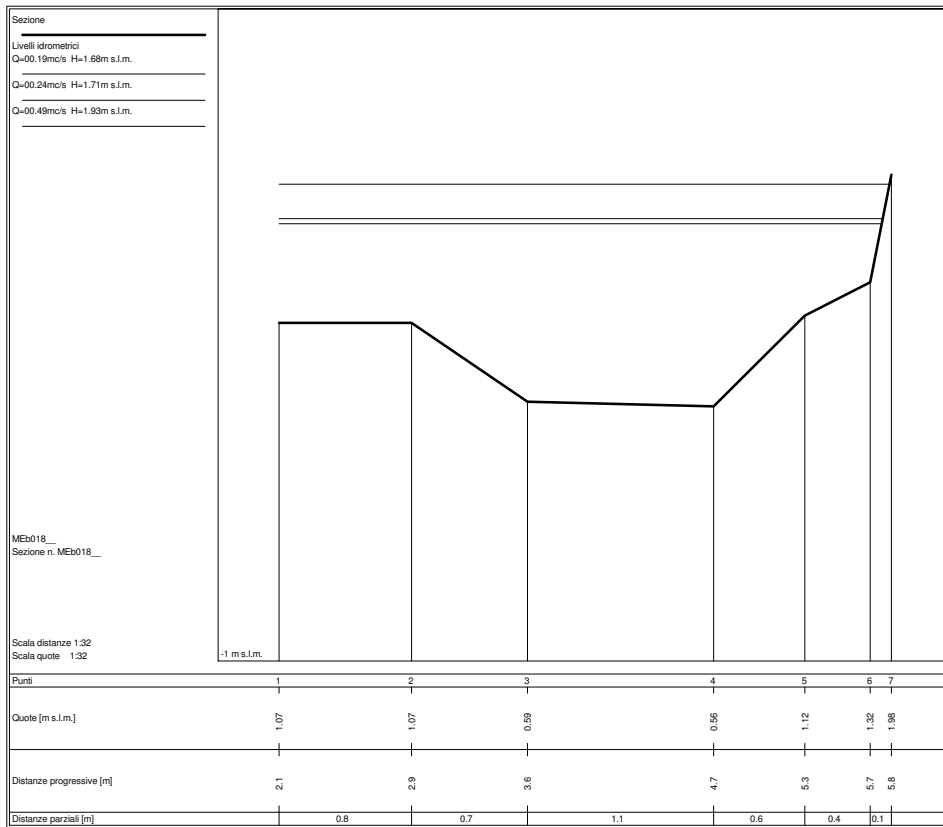

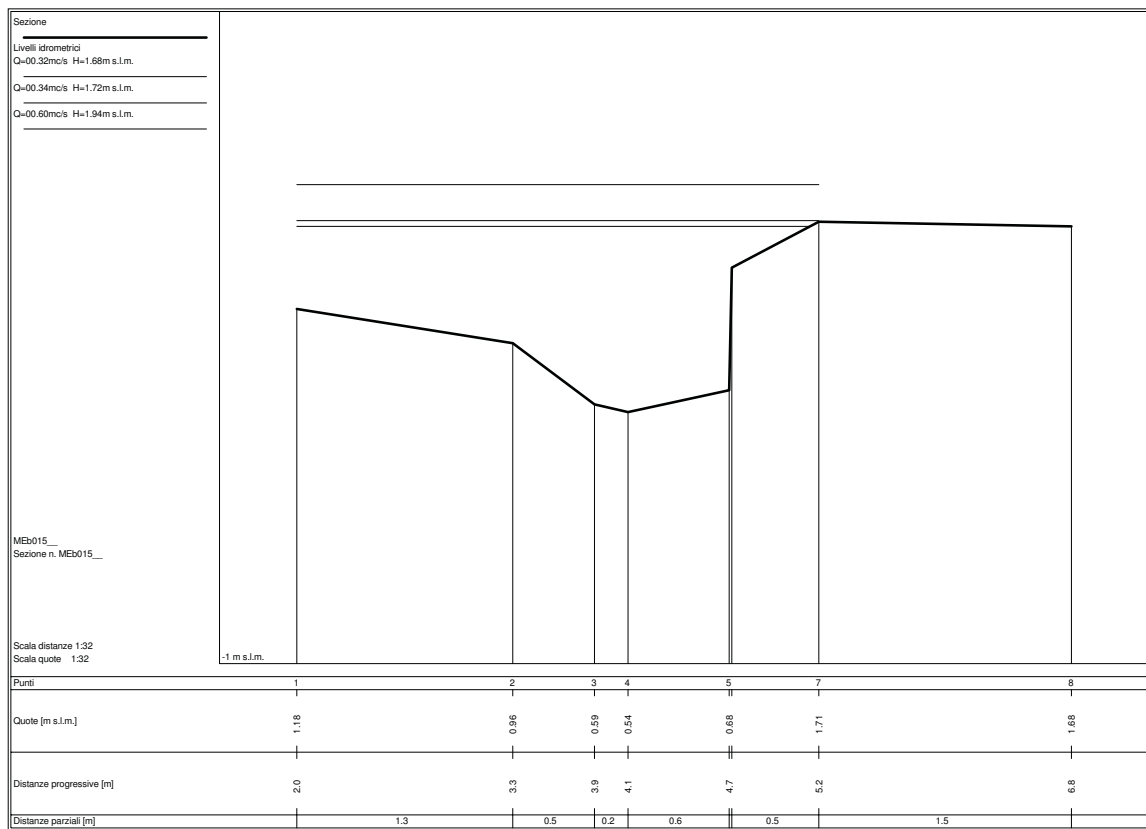
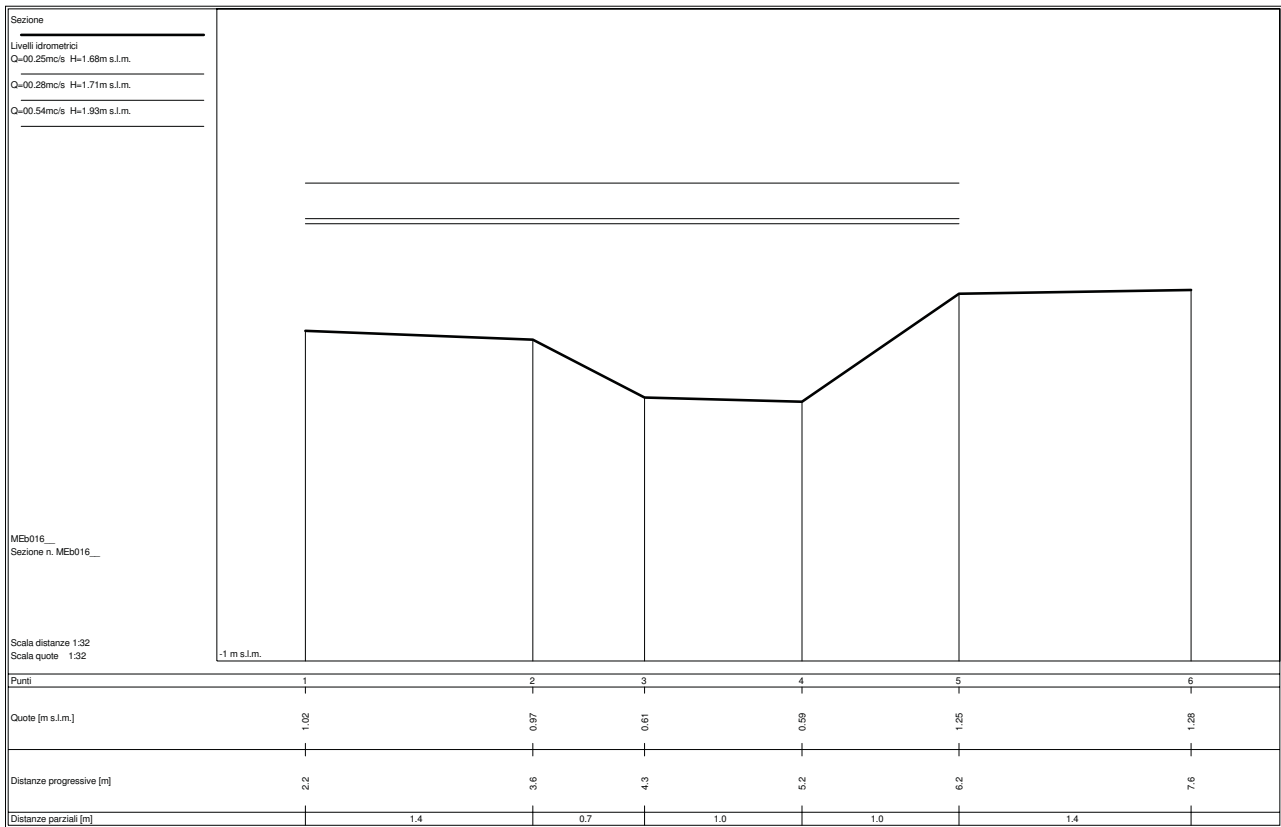

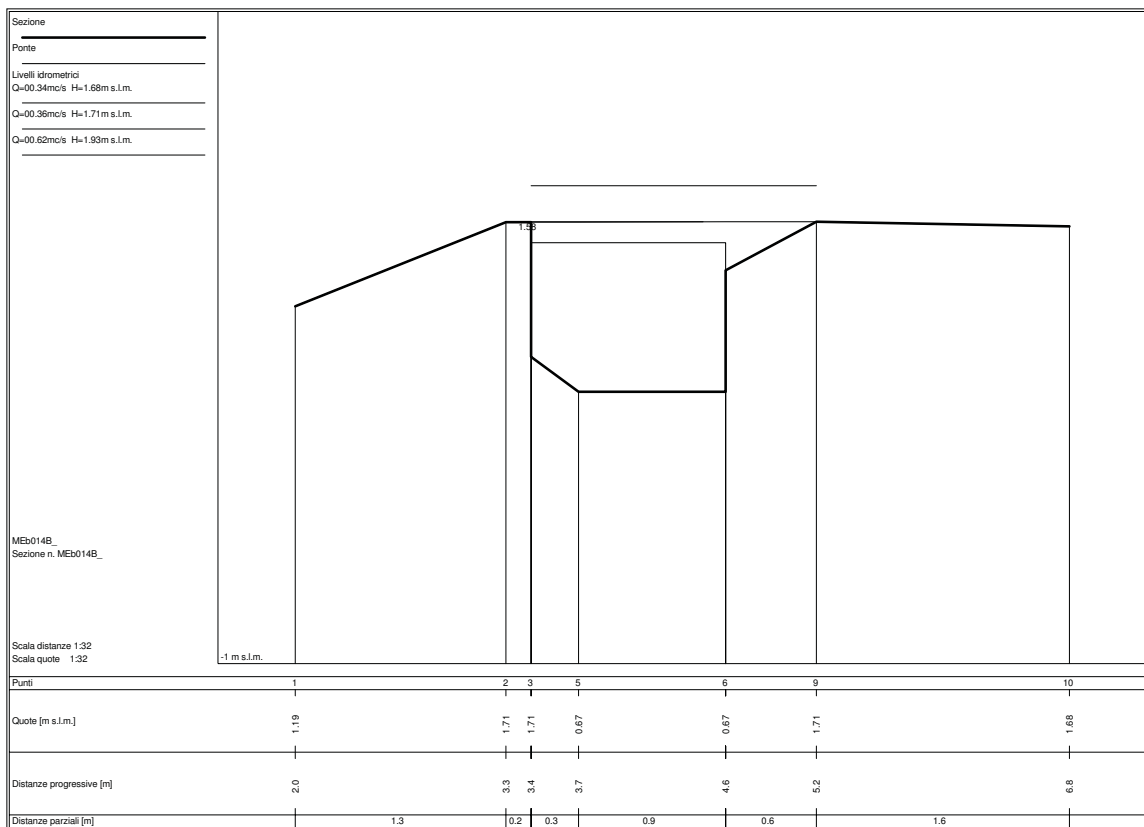
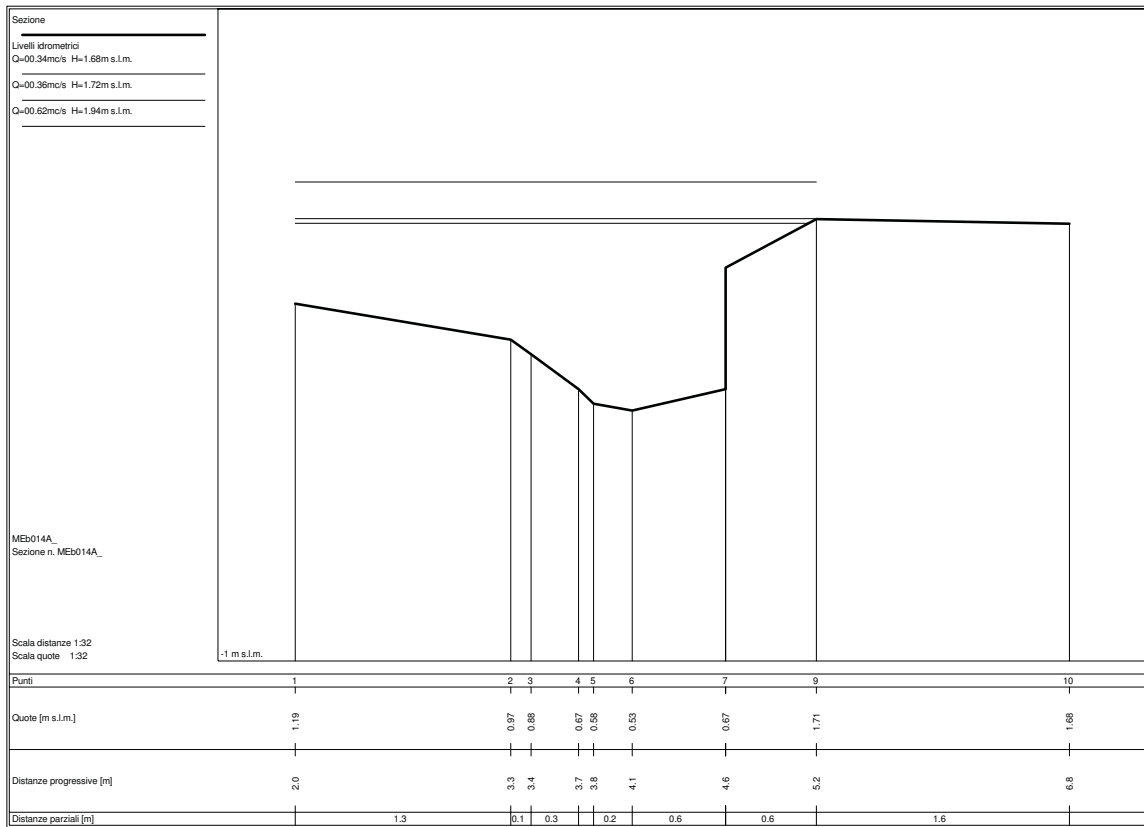



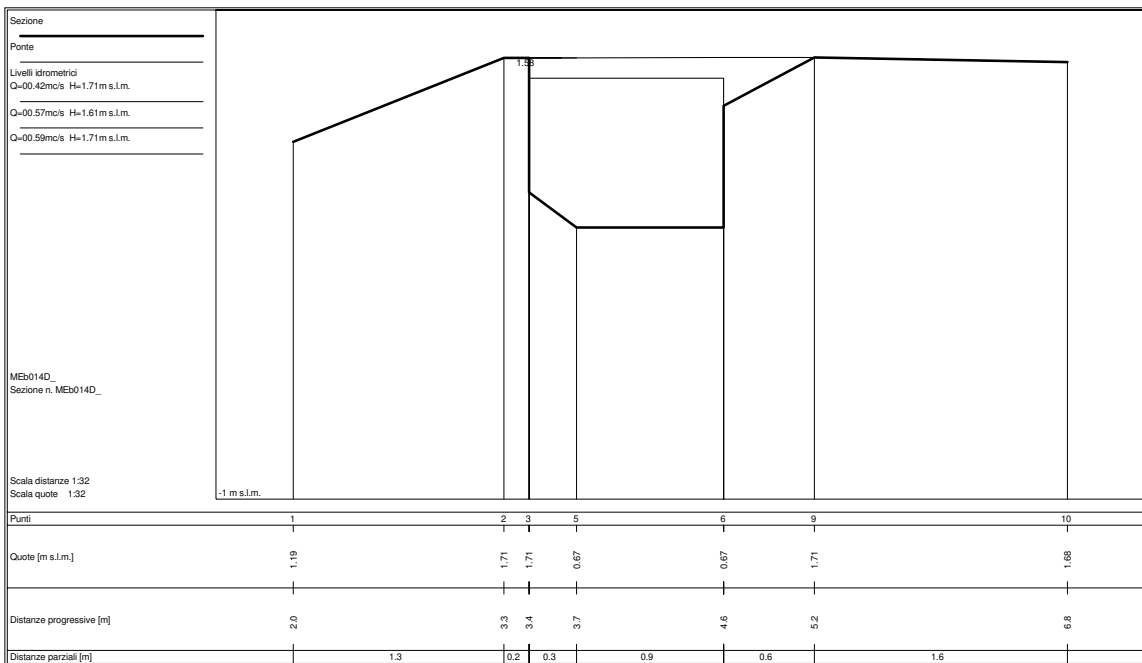
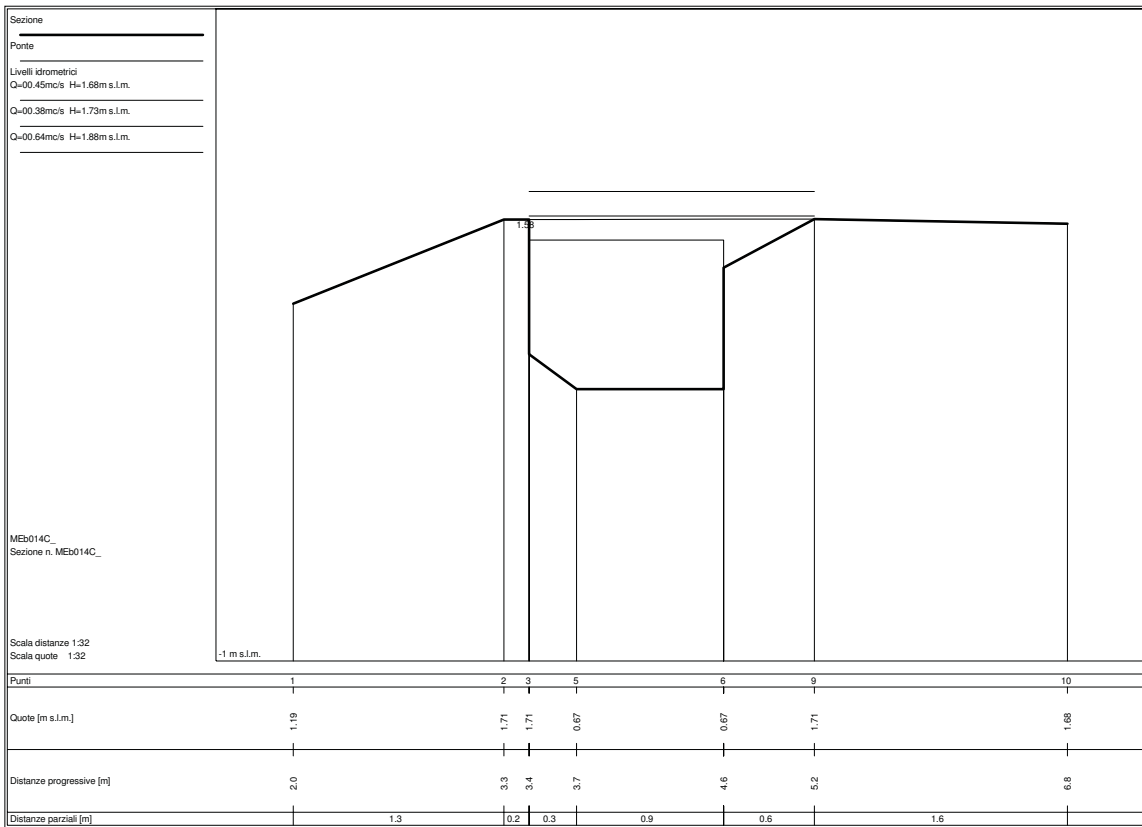

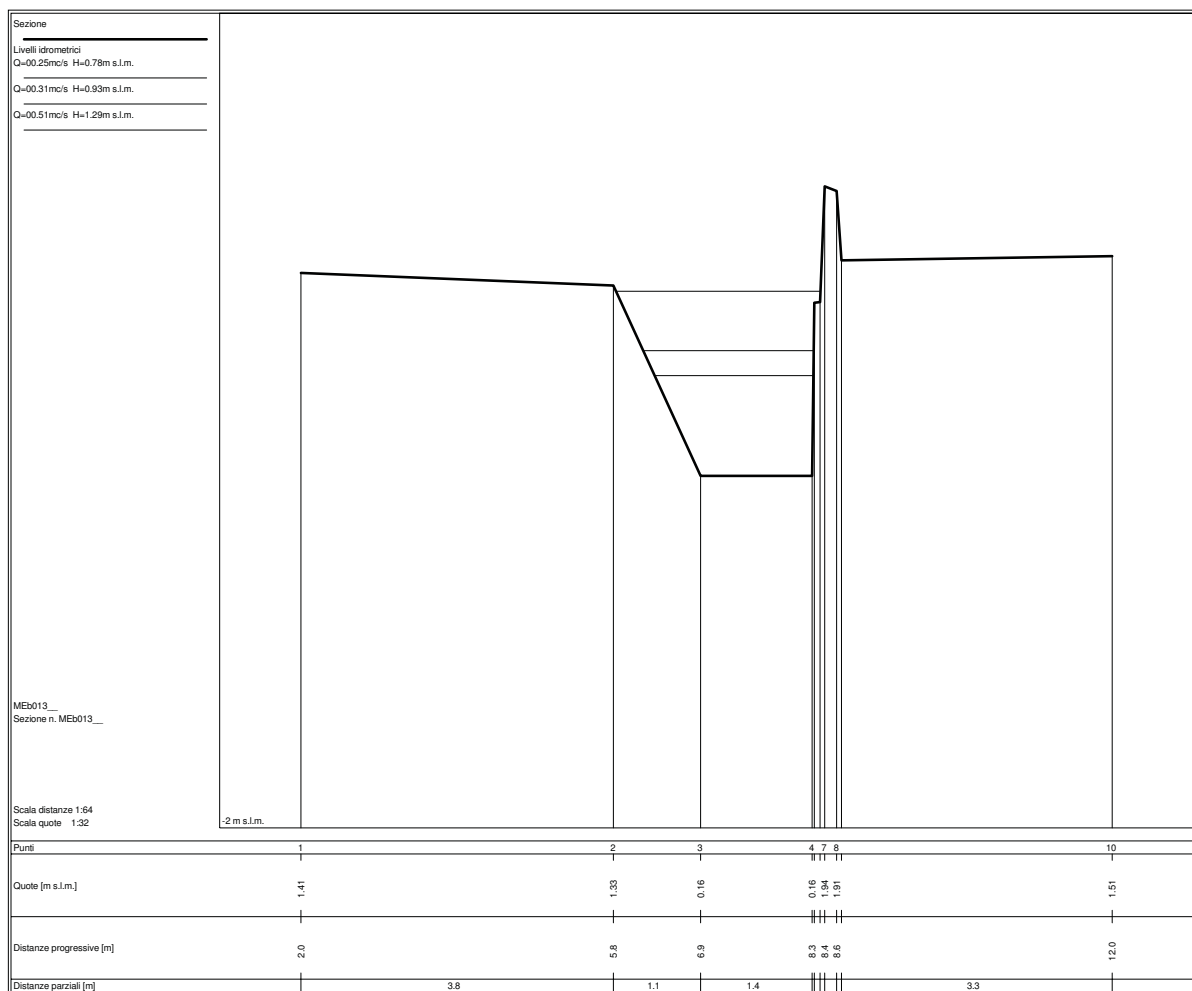
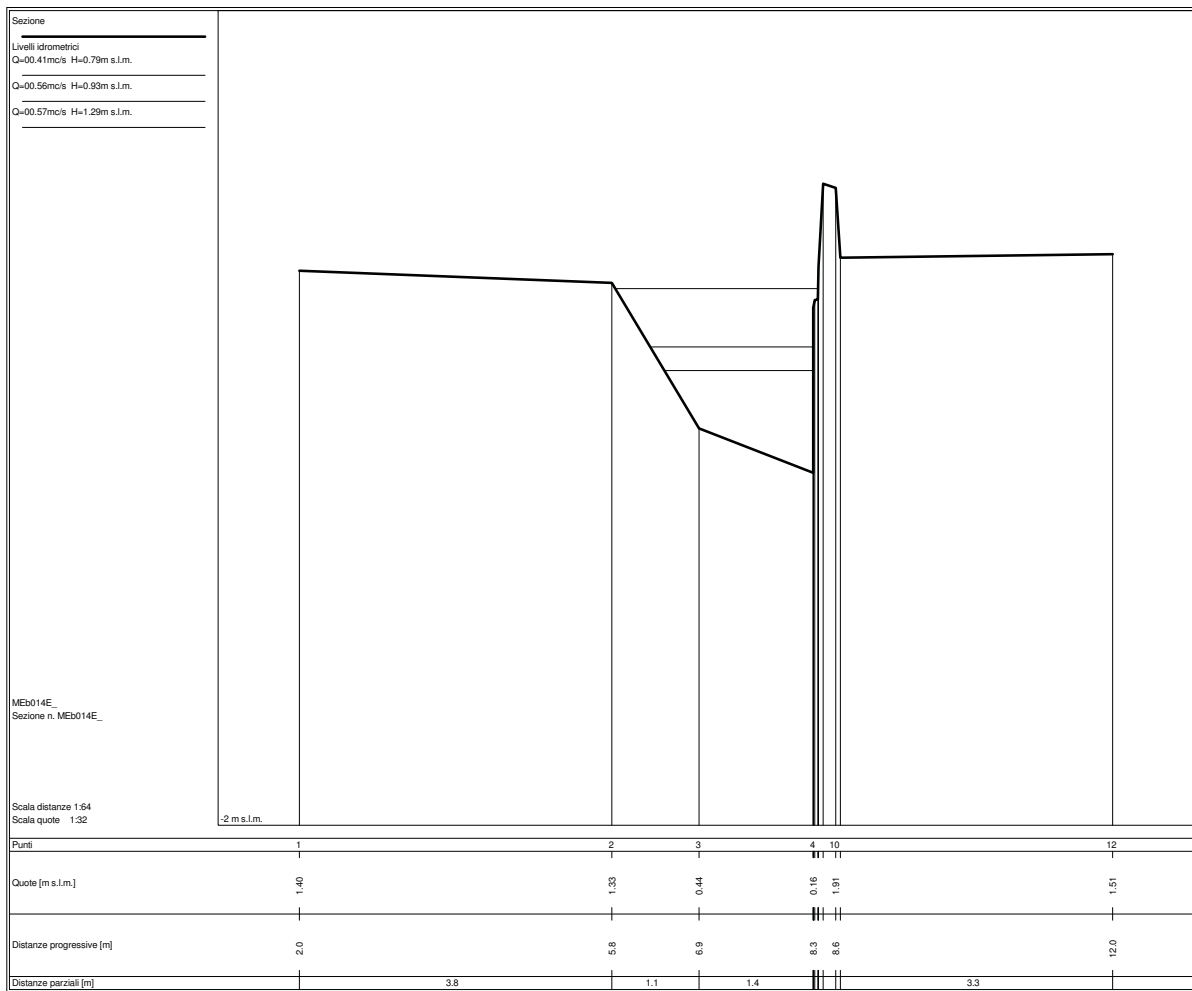

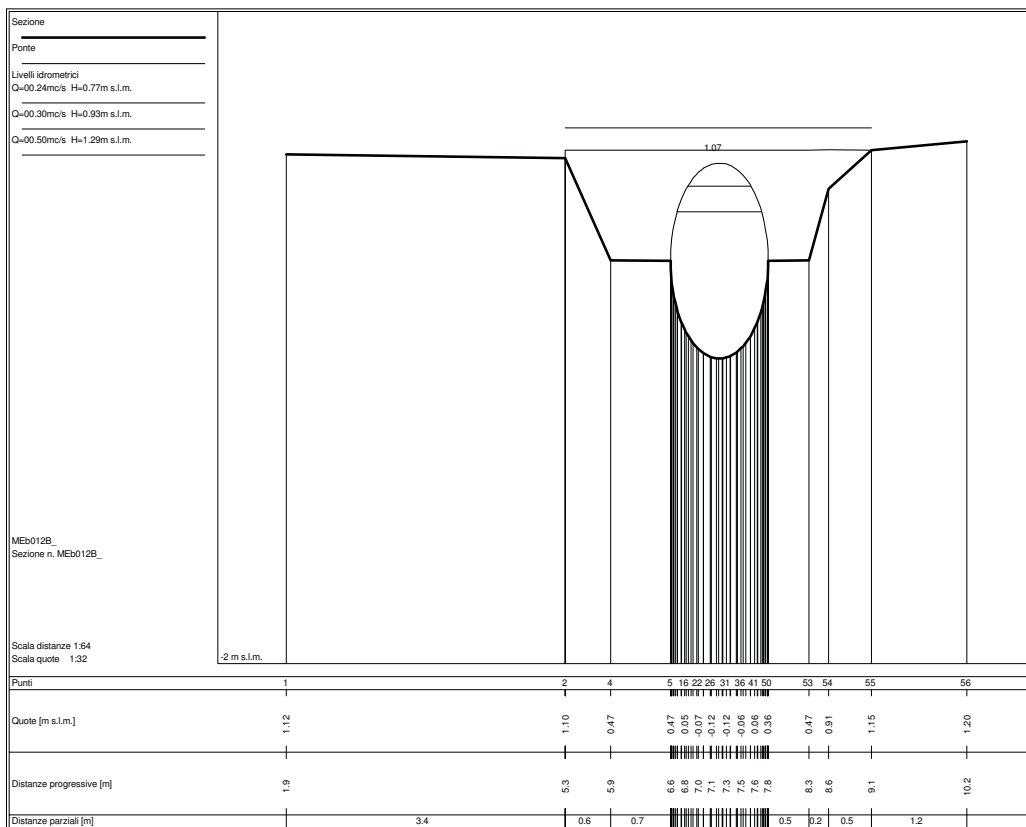
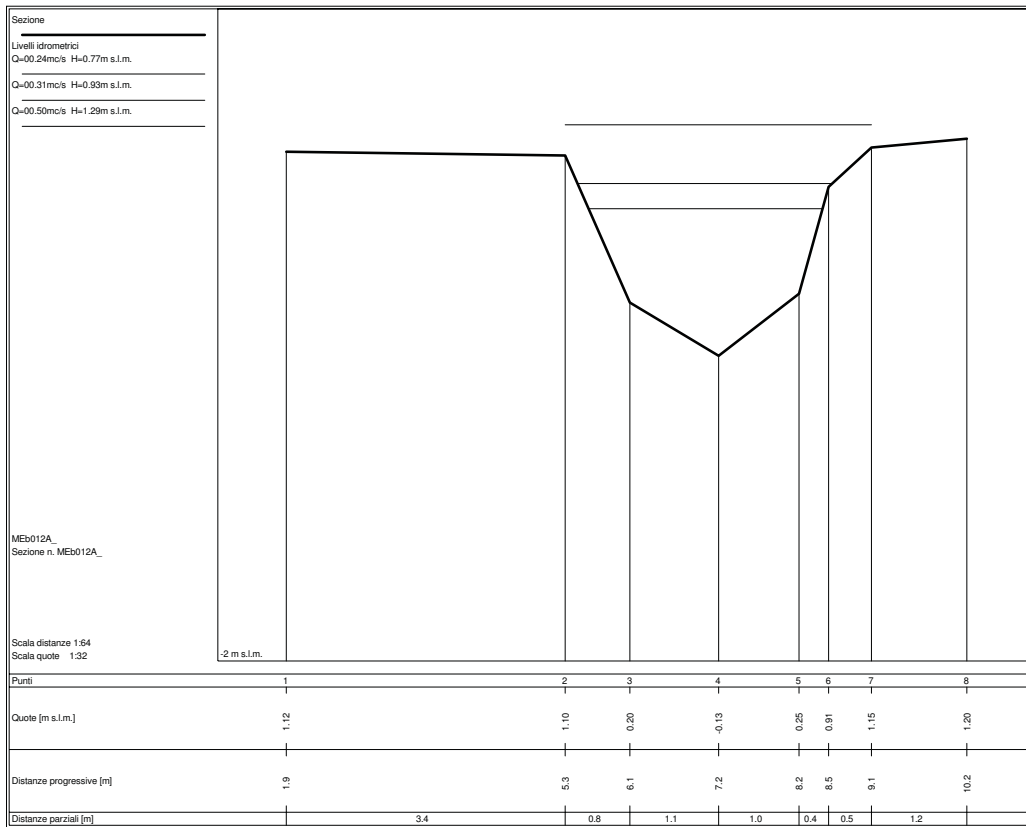

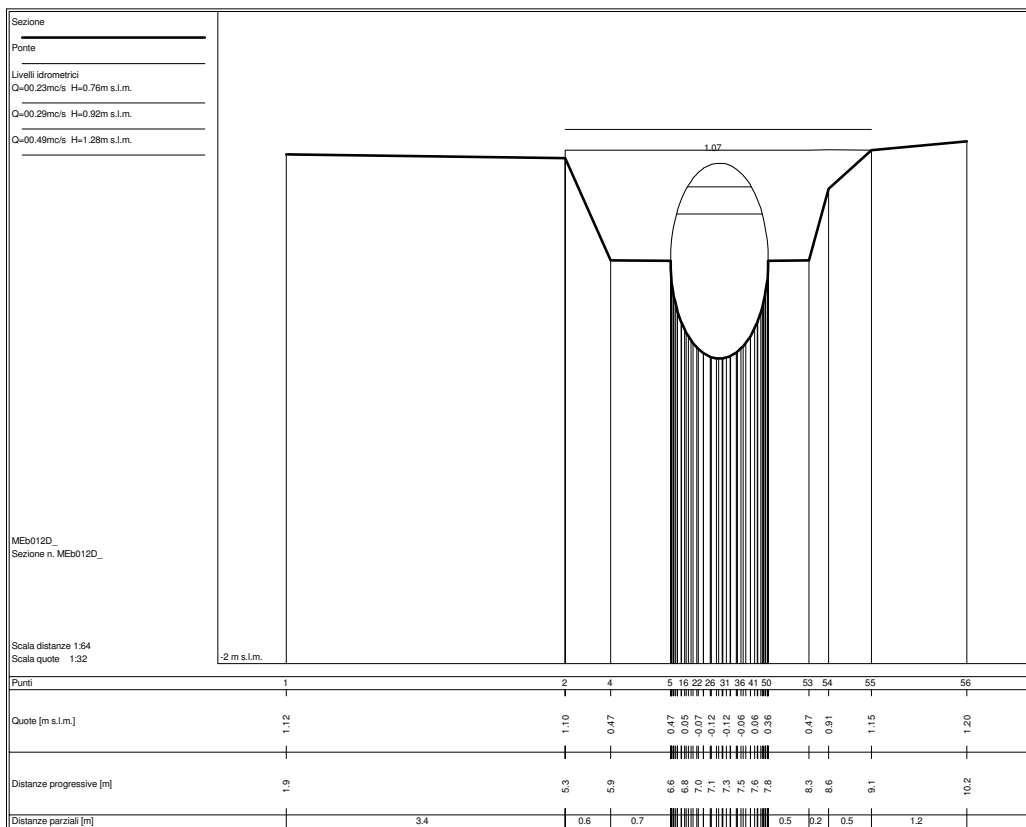
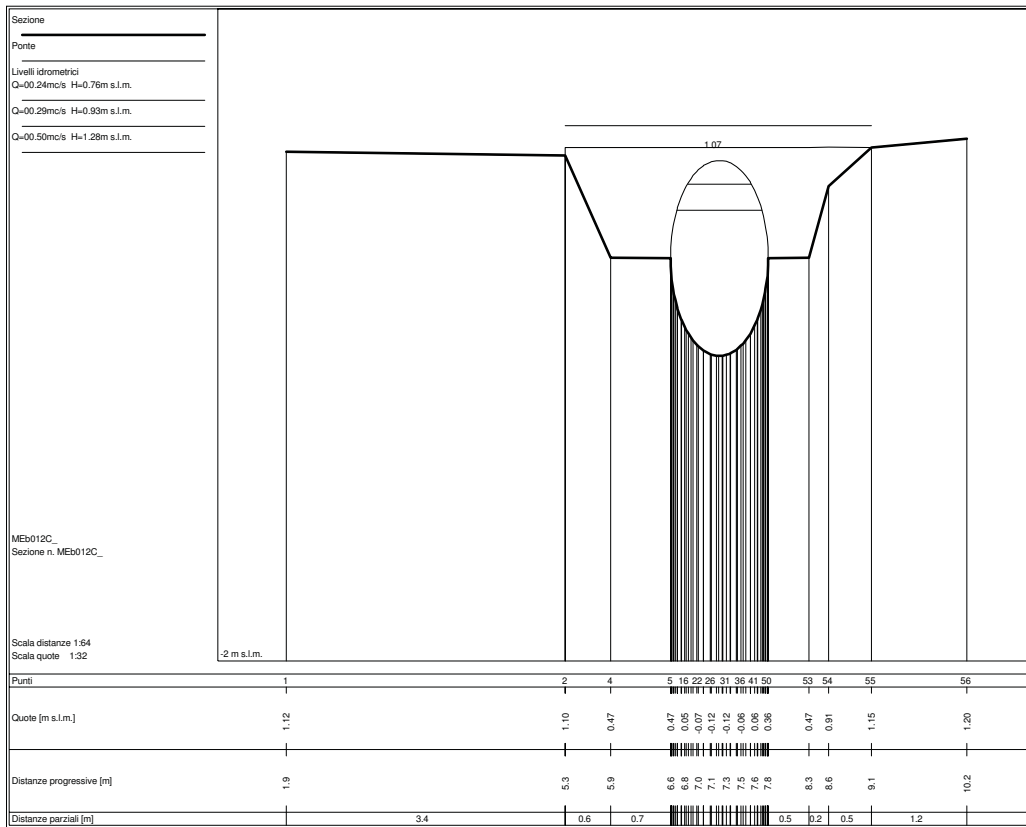

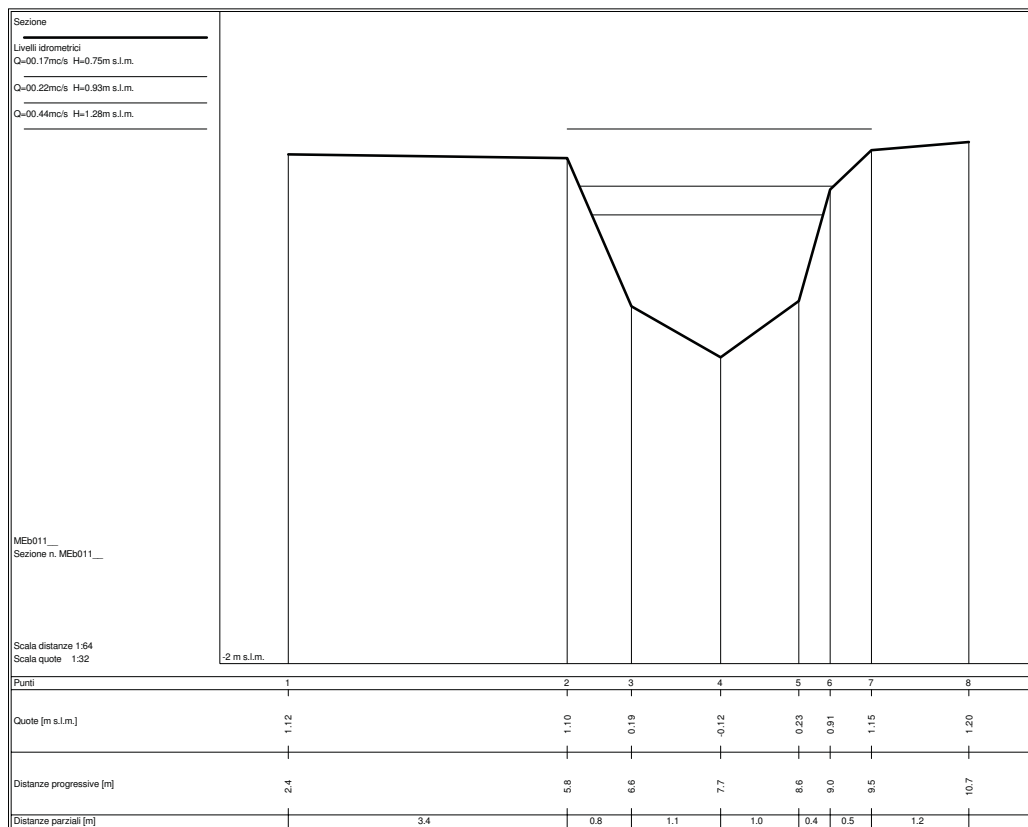
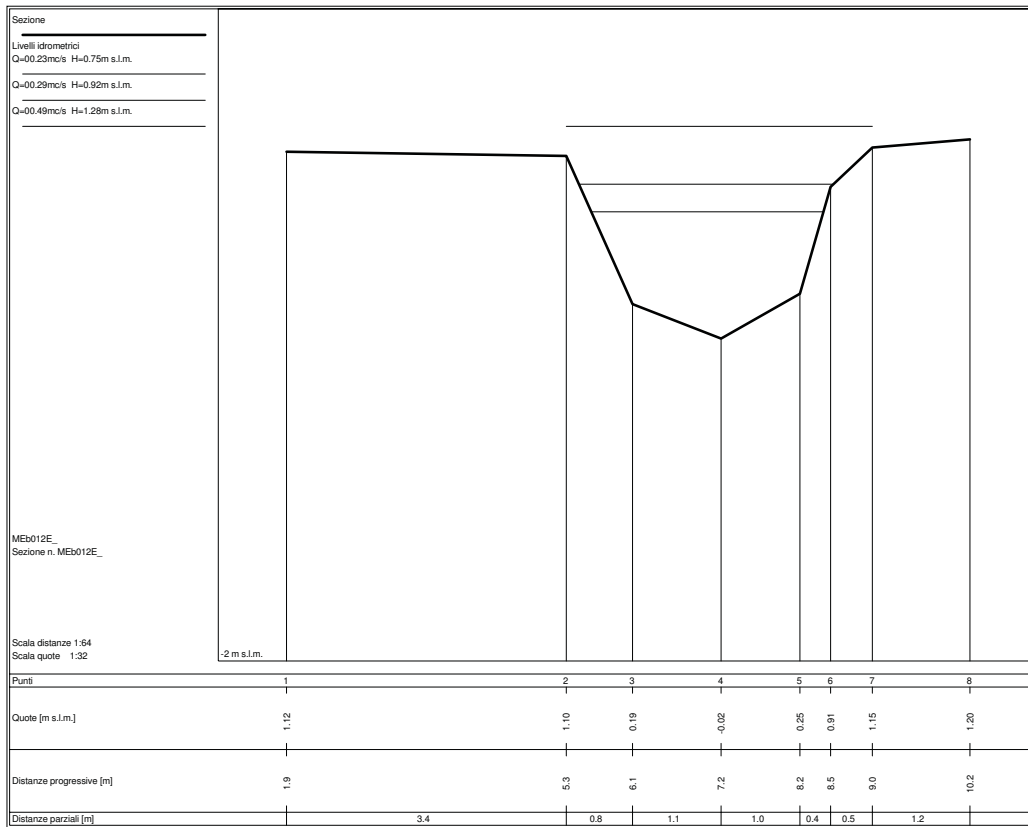

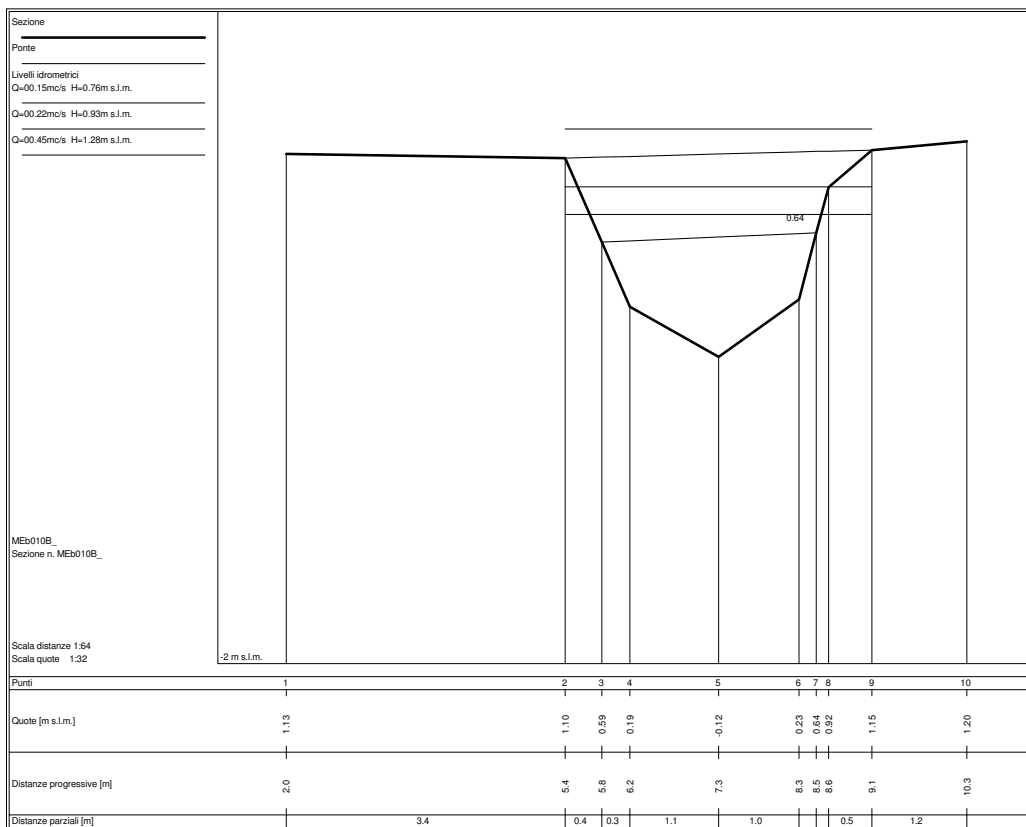
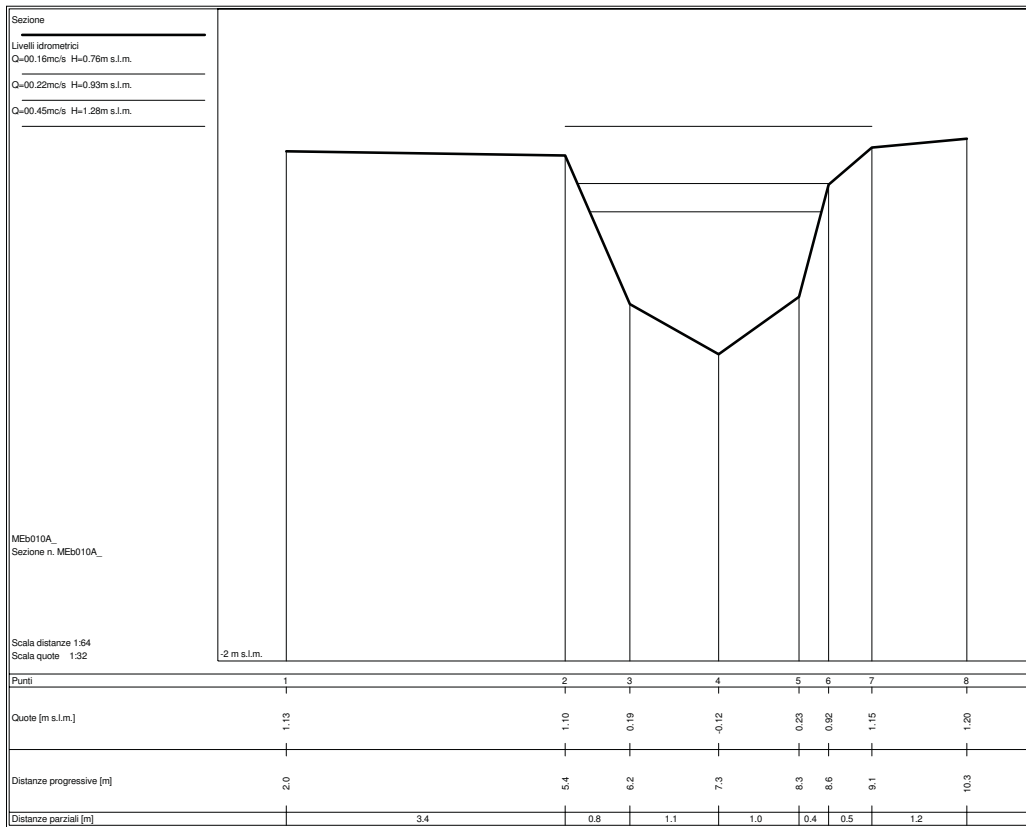

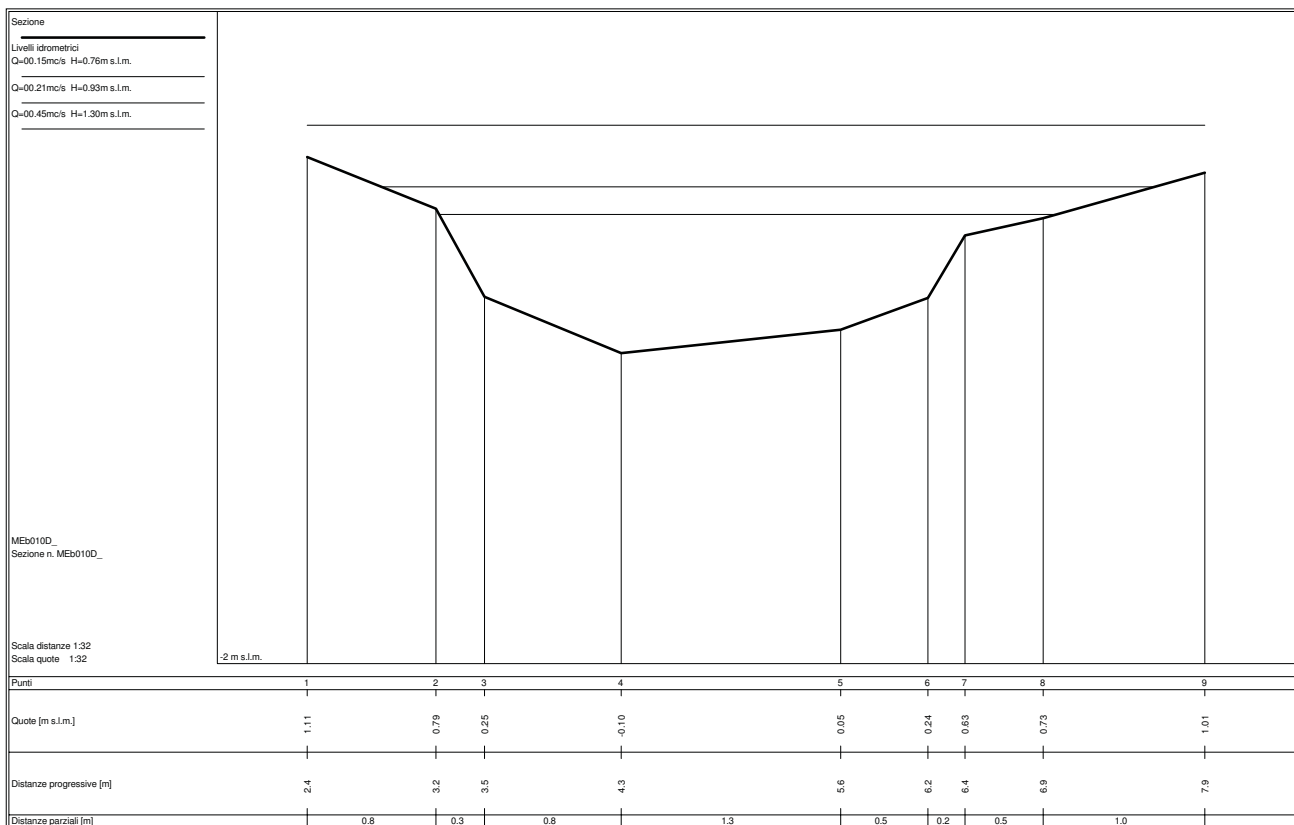
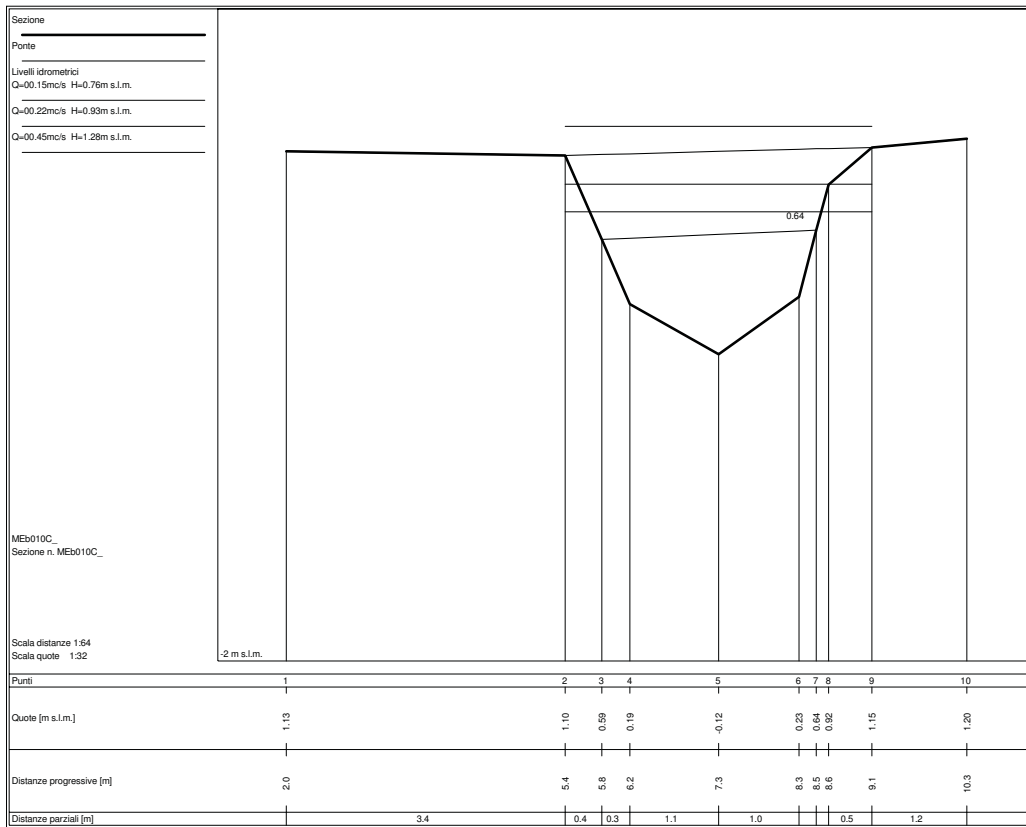

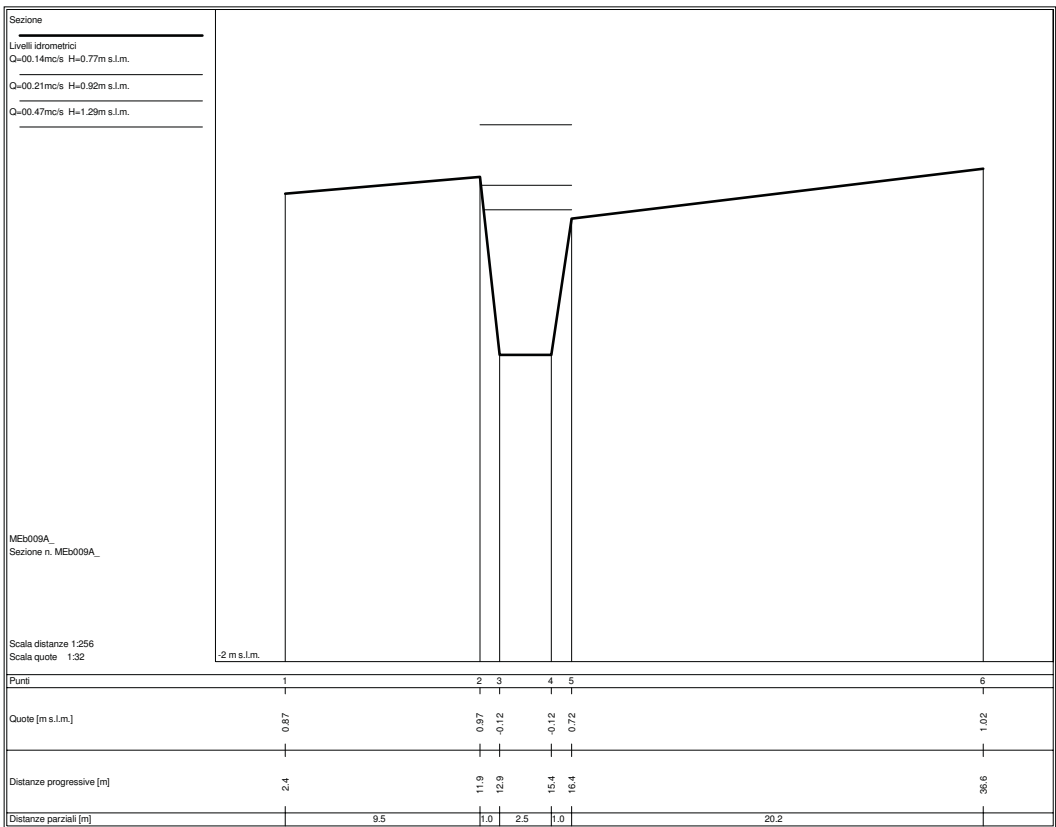
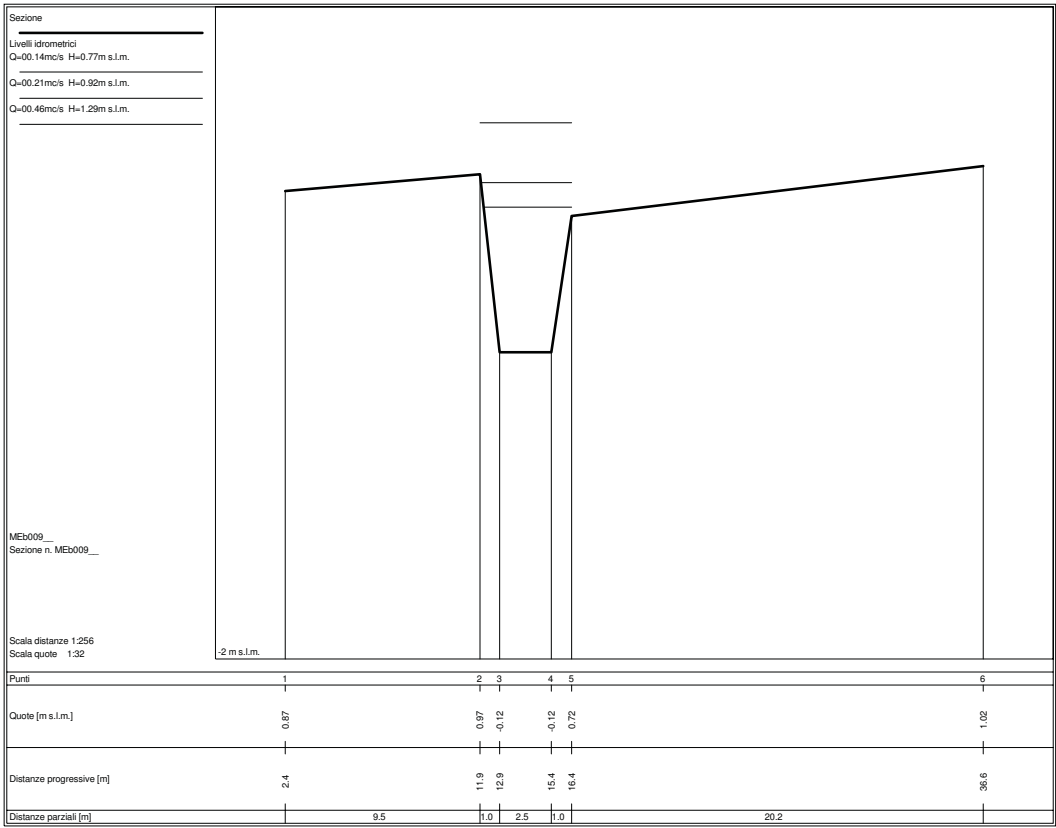



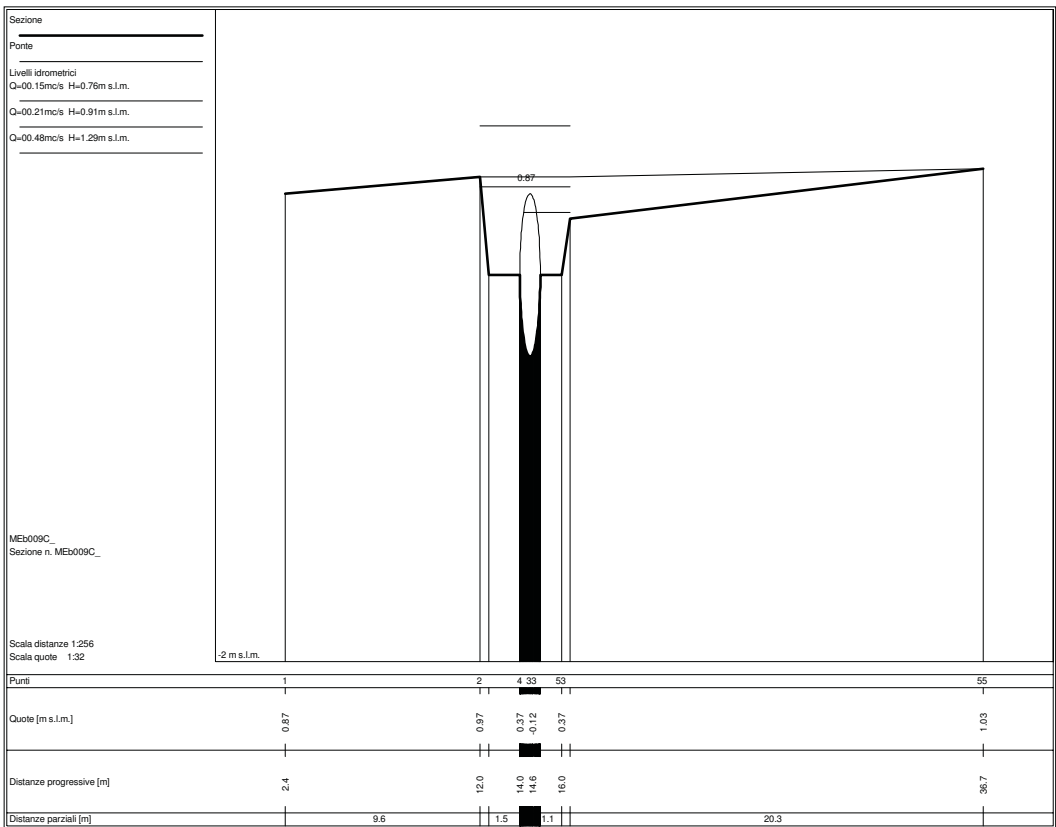
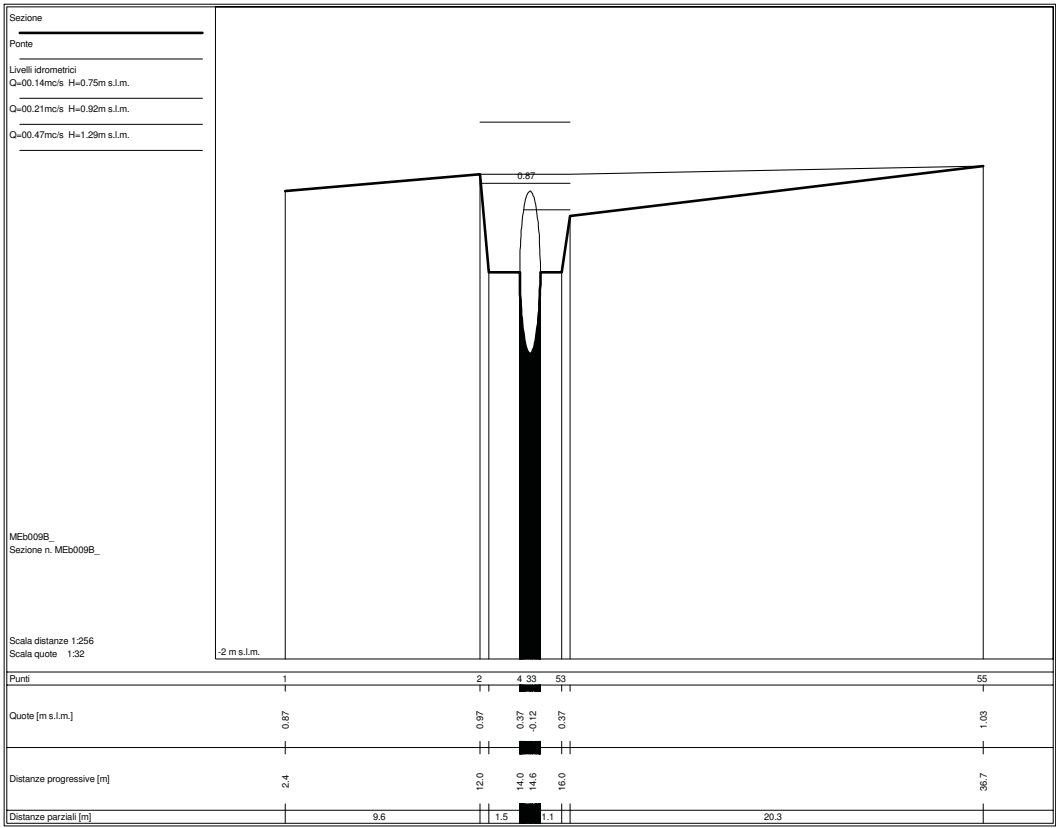

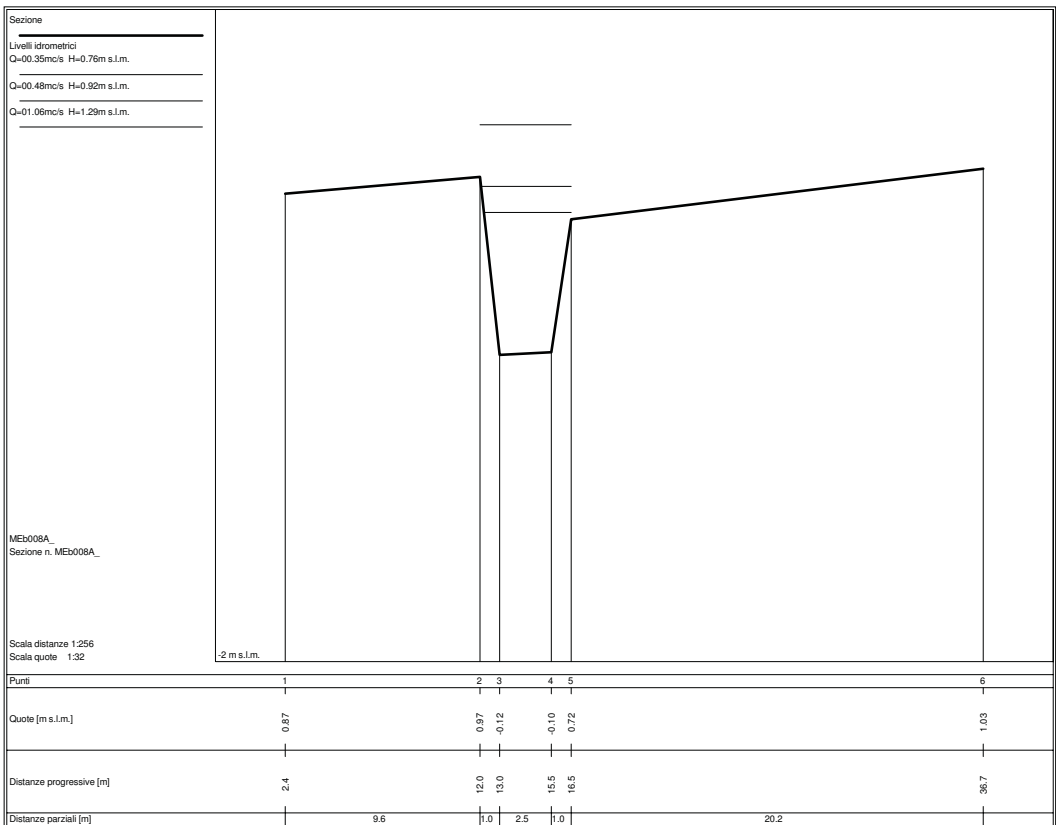
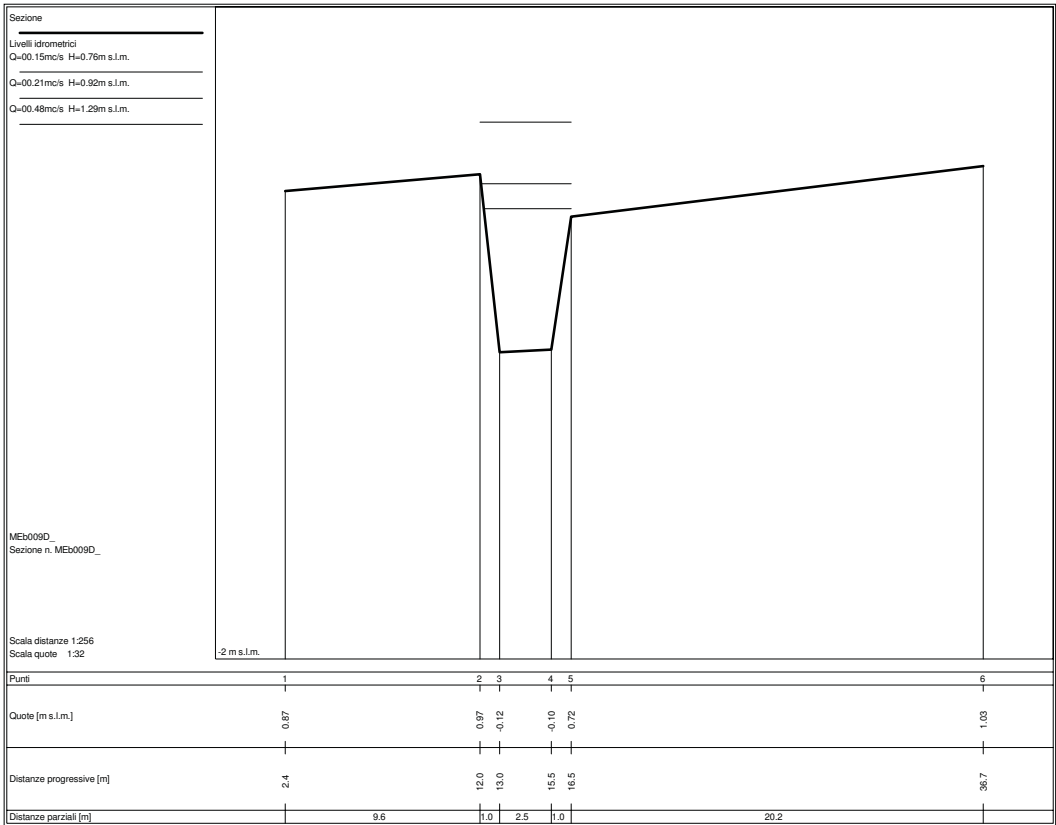

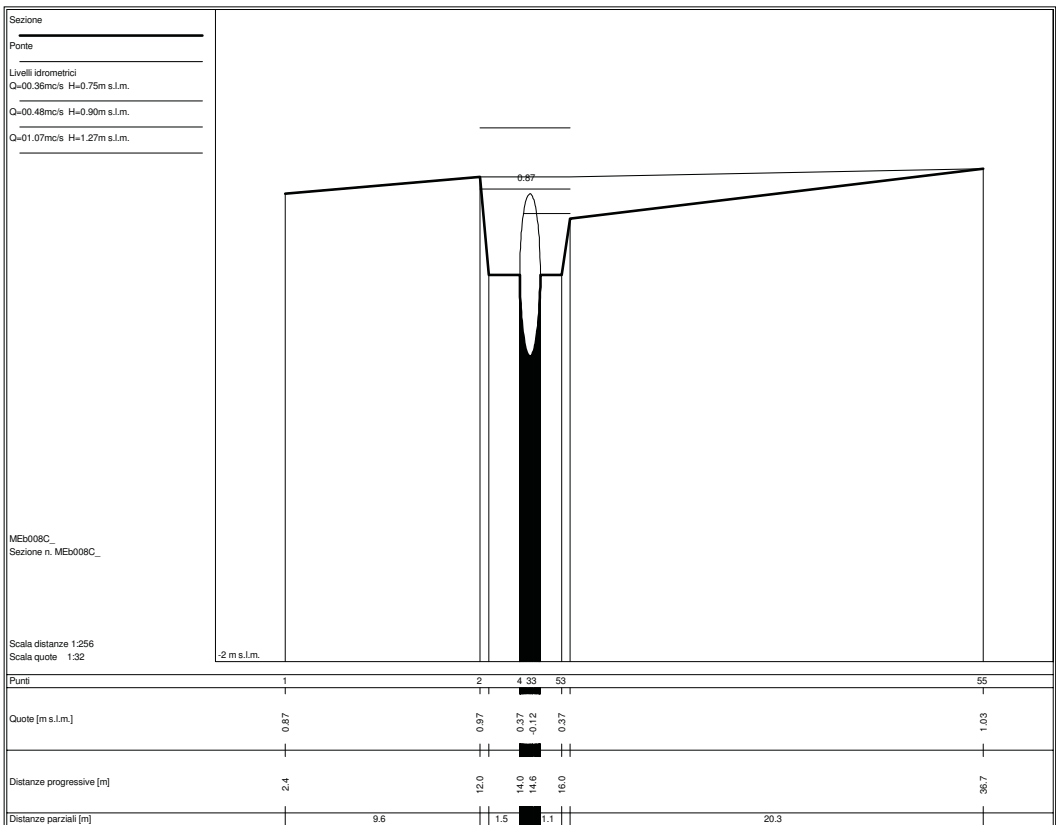
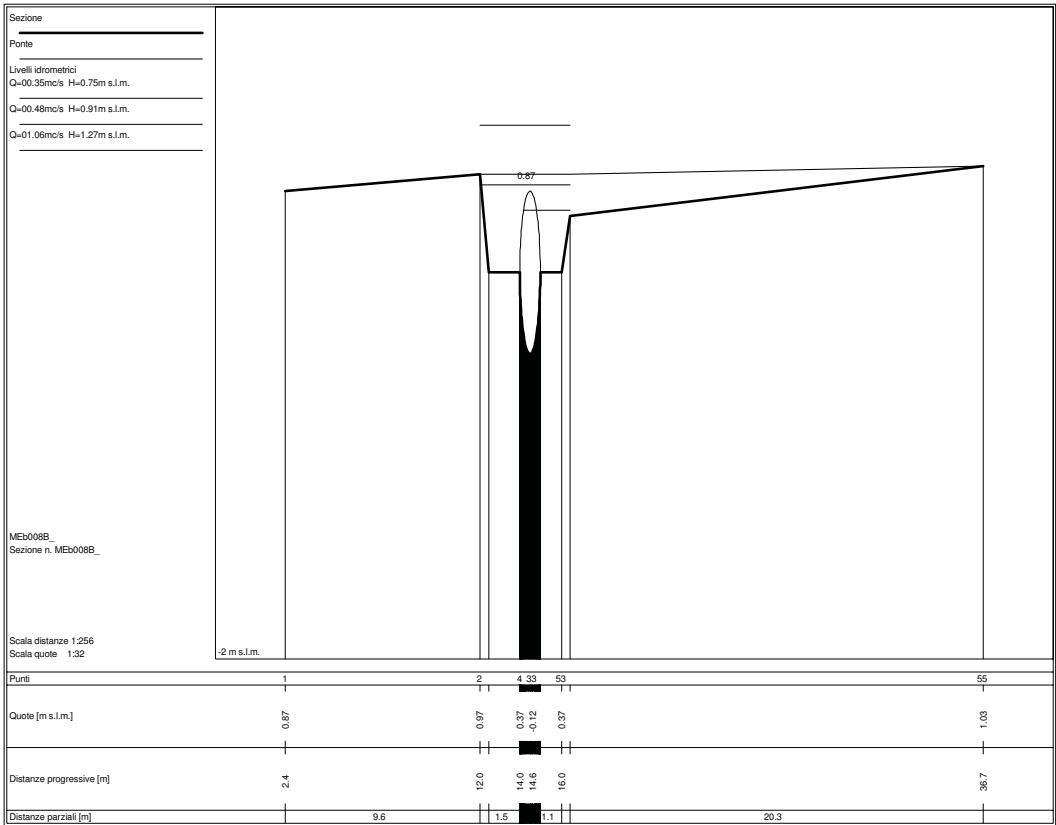

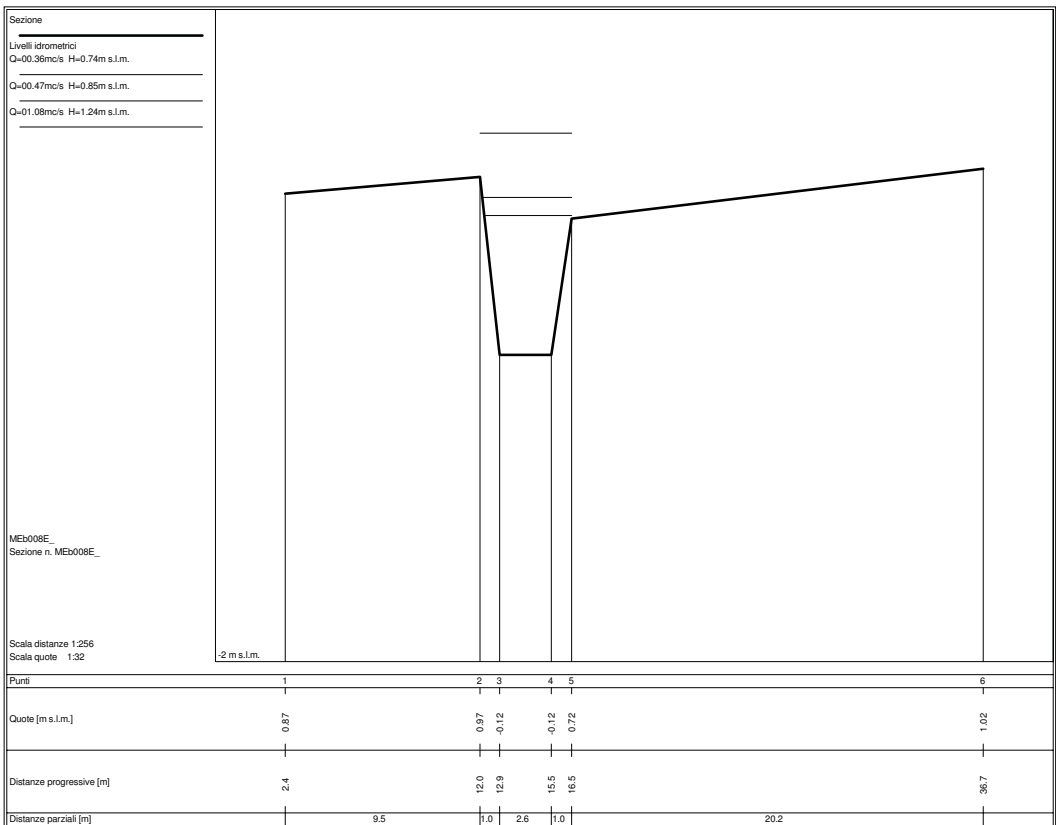
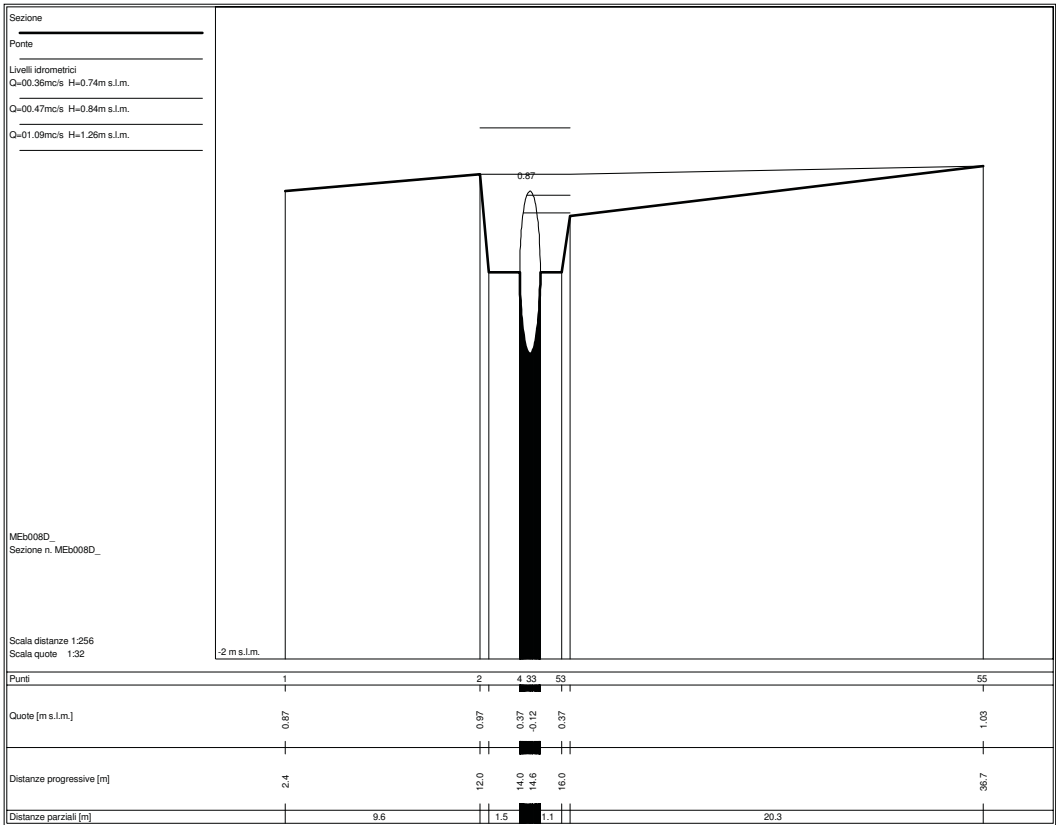

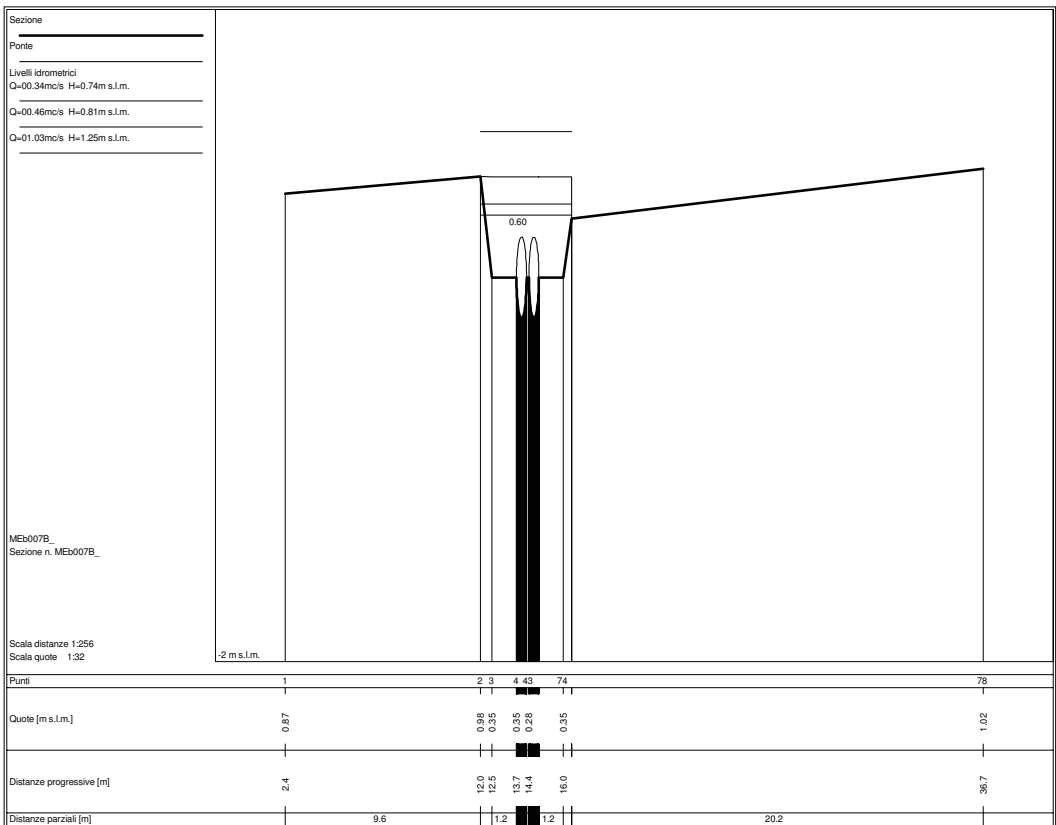
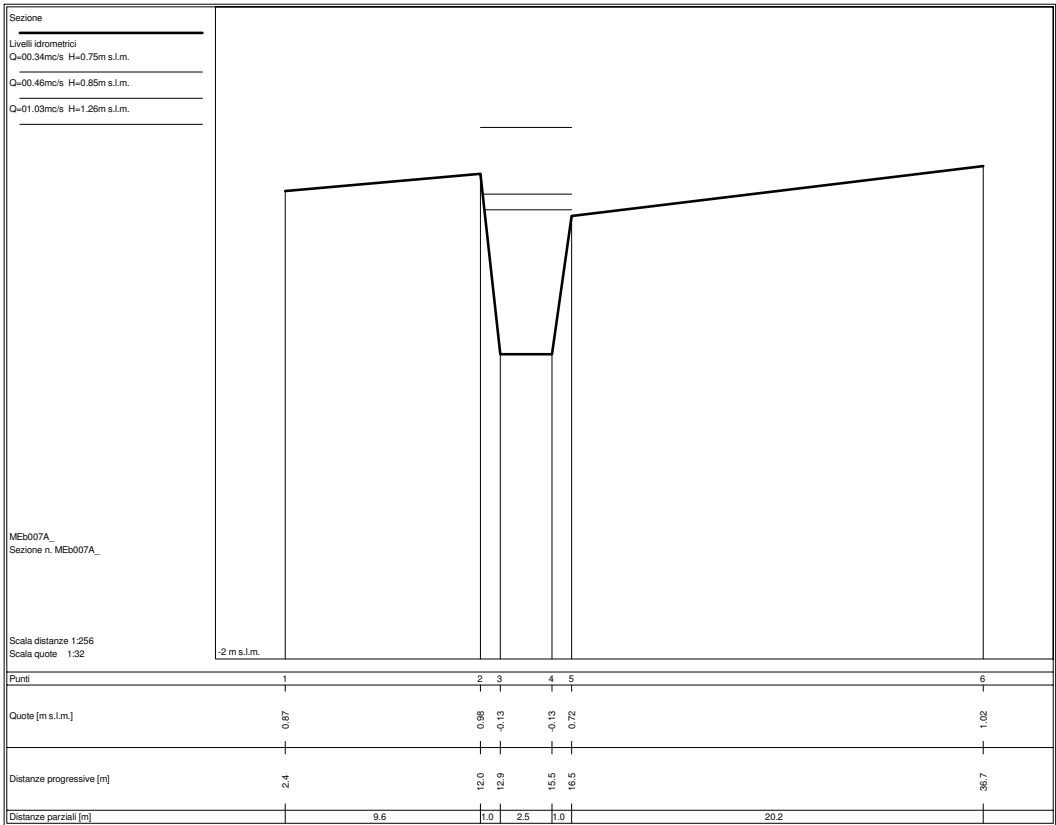

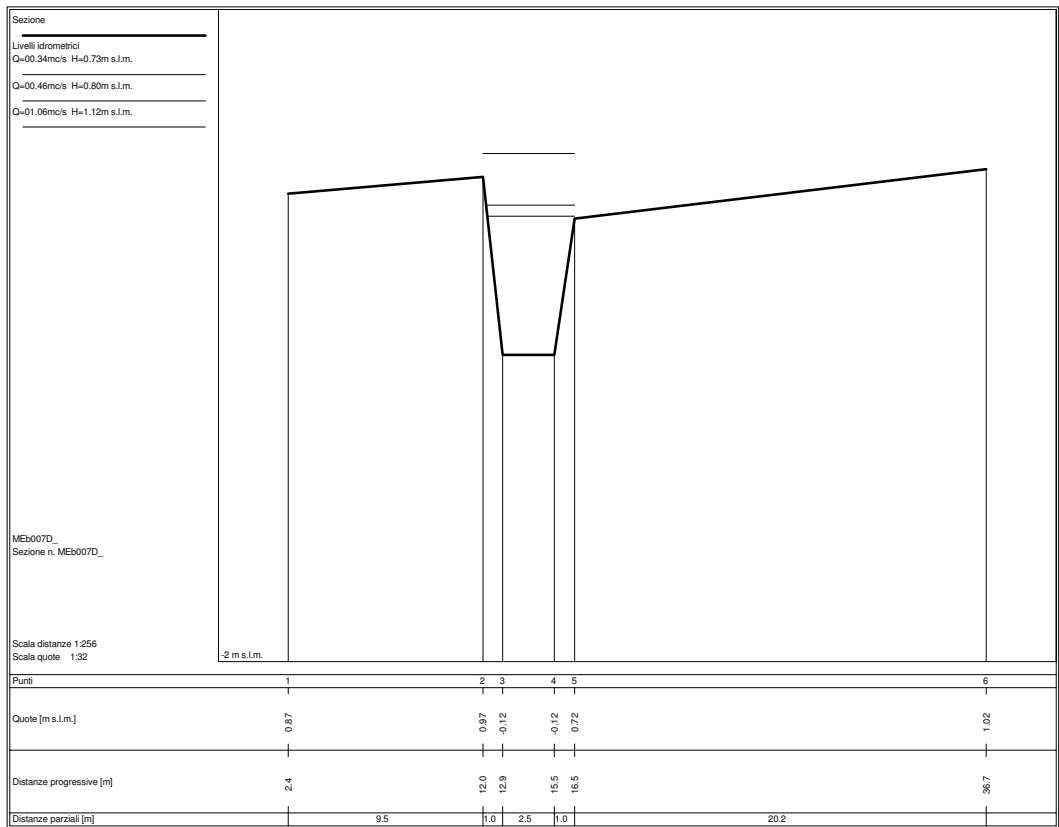
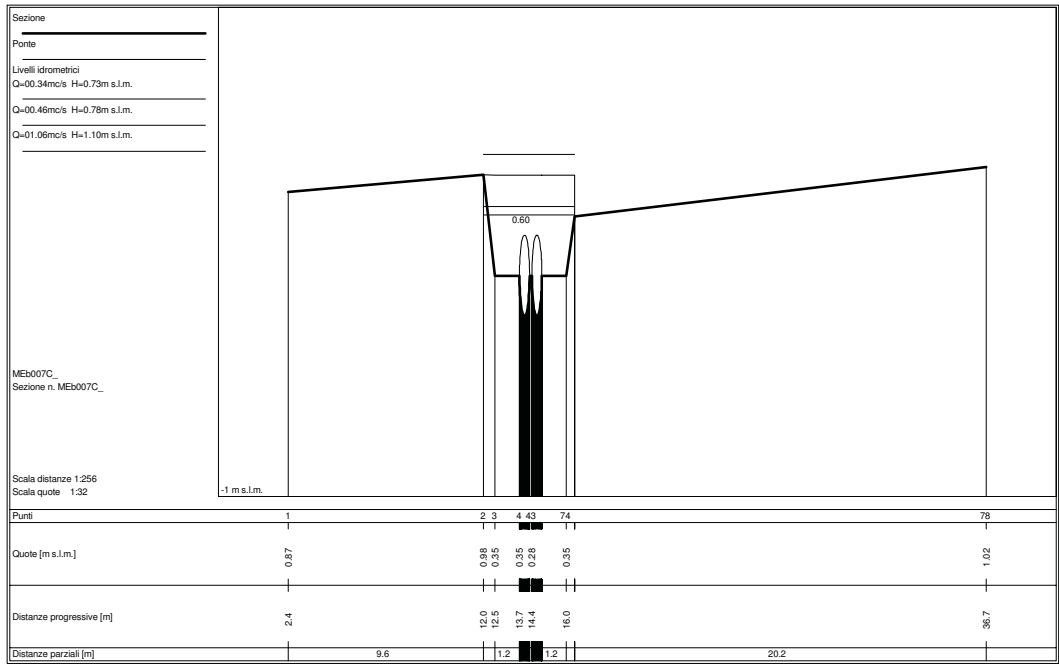

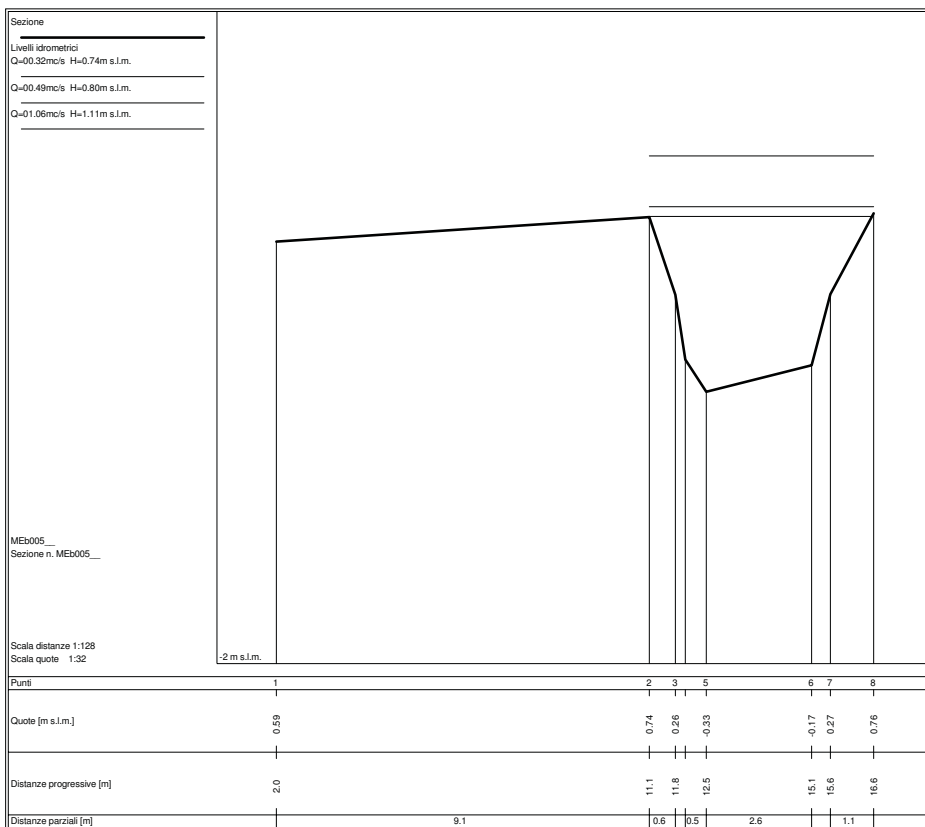
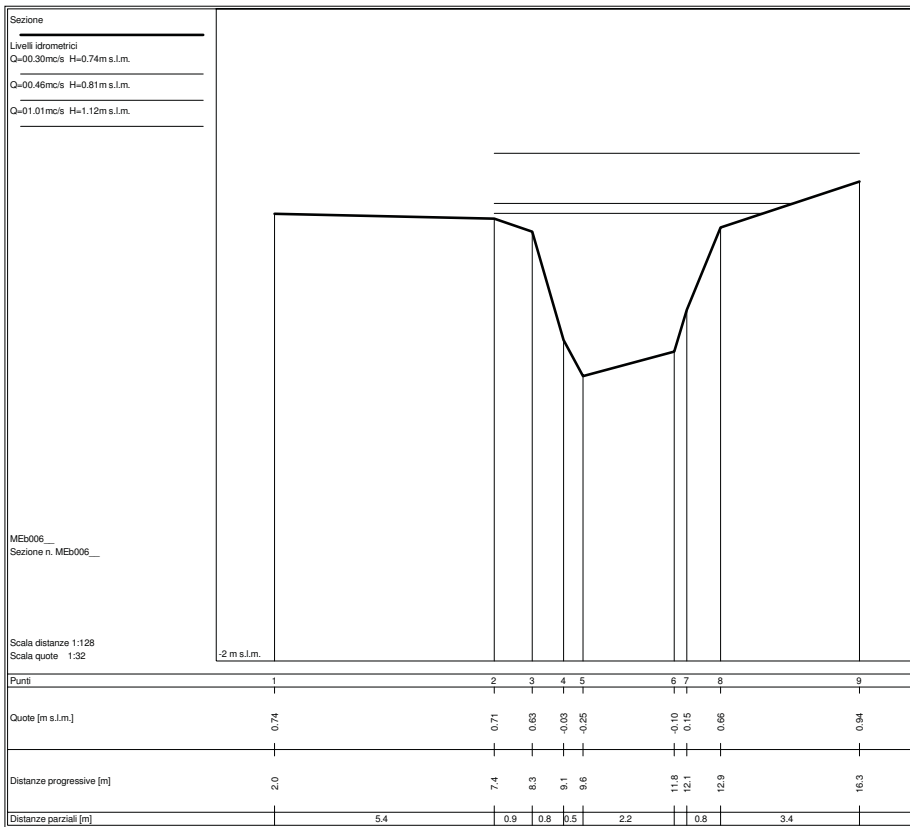

Sezione  
 Livelli idrometrici  
 Q=00.43mc/s H=0.74m s.l.m.  
 Q=00.82mc/s H=0.80m s.l.m.  
 Q=01.52mc/s H=1.12m s.l.m.

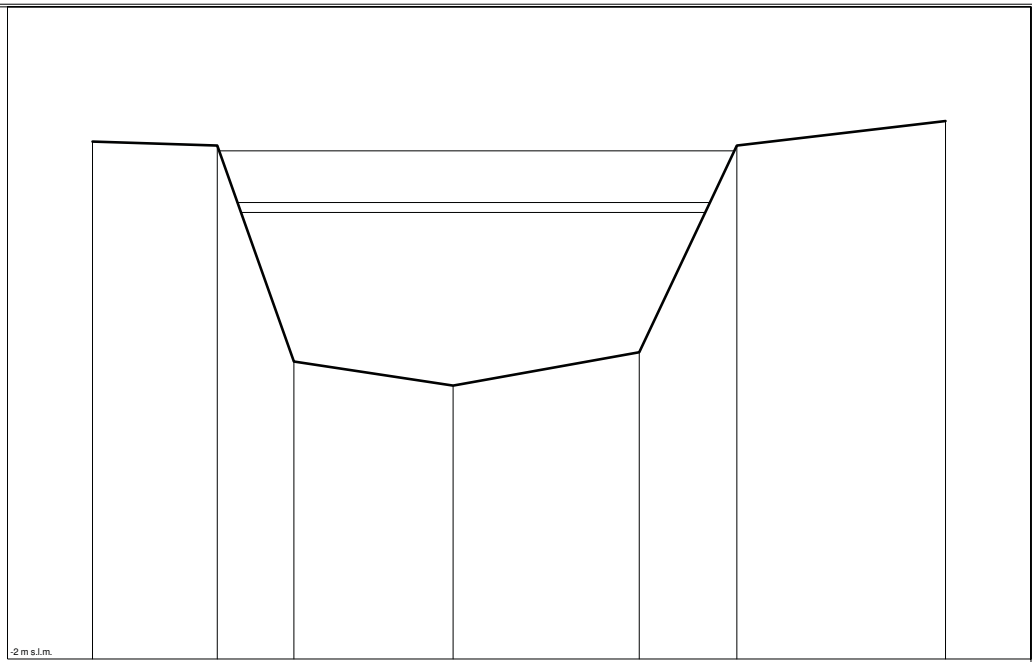

MEb004A  
 Sezione n. MEb004A\_

Scala distanze 1:64  
 Scala quote 1:32

|                          |      |      |       |       |       |      |      |
|--------------------------|------|------|-------|-------|-------|------|------|
| Punti                    | 1    | 2    | 3     | 4     | 5     | 6    | 7    |
| Quote [m s.l.m.]         | 1.17 | 1.15 | -0.18 | -0.32 | -0.12 | 1.15 | 1.30 |
| Distanze progressive [m] | 2.0  | 3.5  | 4.5   | 6.4   | 8.7   | 9.9  | 12.5 |
| Distanze parziali [m]    |      | 1.5  | 0.9   | 2.0   | 2.3   | 1.2  | 2.6  |

Sezione  
 Ponte  
 Livelli idrometrici  
 Q=00.43mc/s H=0.74m s.l.m.  
 Q=00.82mc/s H=0.80m s.l.m.  
 Q=01.52mc/s H=1.11m s.l.m.

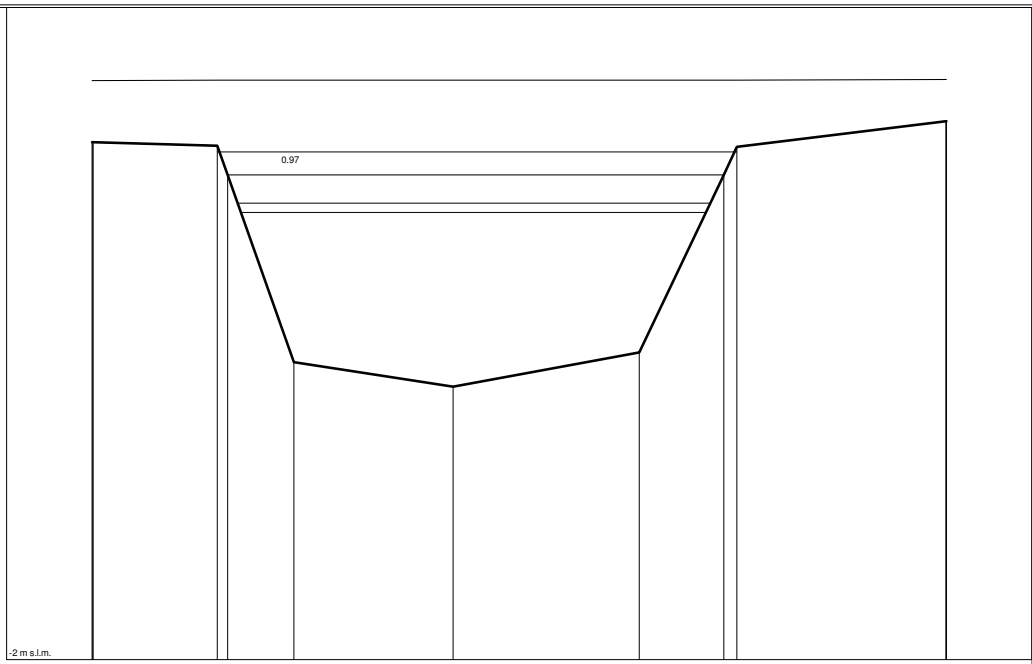

MEb003B  
 Sezione n. MEb003B\_

Scala distanze 1:64  
 Scala quote 1:32

|                          |      |      |       |       |       |      |      |      |
|--------------------------|------|------|-------|-------|-------|------|------|------|
| Punti                    | 1    | 3    | 5     | 6     | 7     | 8    | 9    | 10   |
| Quote [m s.l.m.]         | 1.17 | 1.15 | -0.18 | -0.32 | -0.12 | 0.97 | 1.15 | 1.30 |
| Distanze progressive [m] | 2.0  | 3.5  | 4.5   | 6.4   | 8.7   | 9.8  | 9.9  | 12.5 |
| Distanze parziali [m]    |      | 1.5  | 0.8   | 2.0   | 2.3   | 1.0  | 2.6  |      |





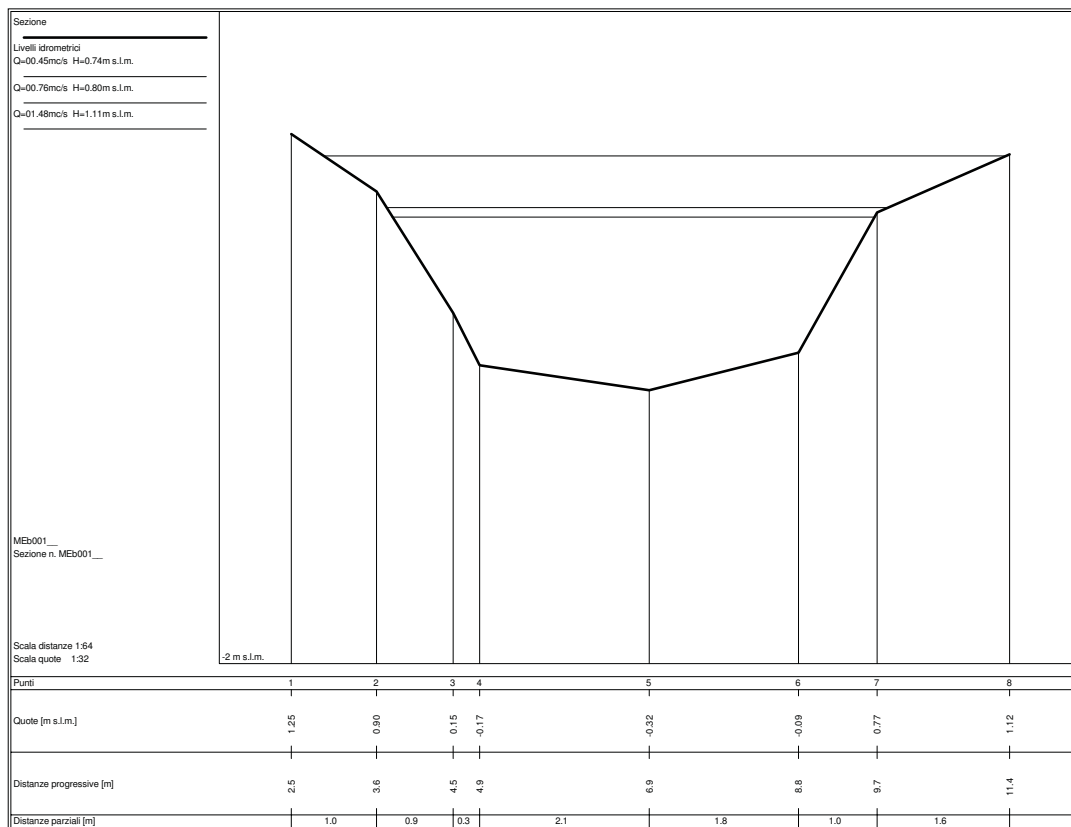
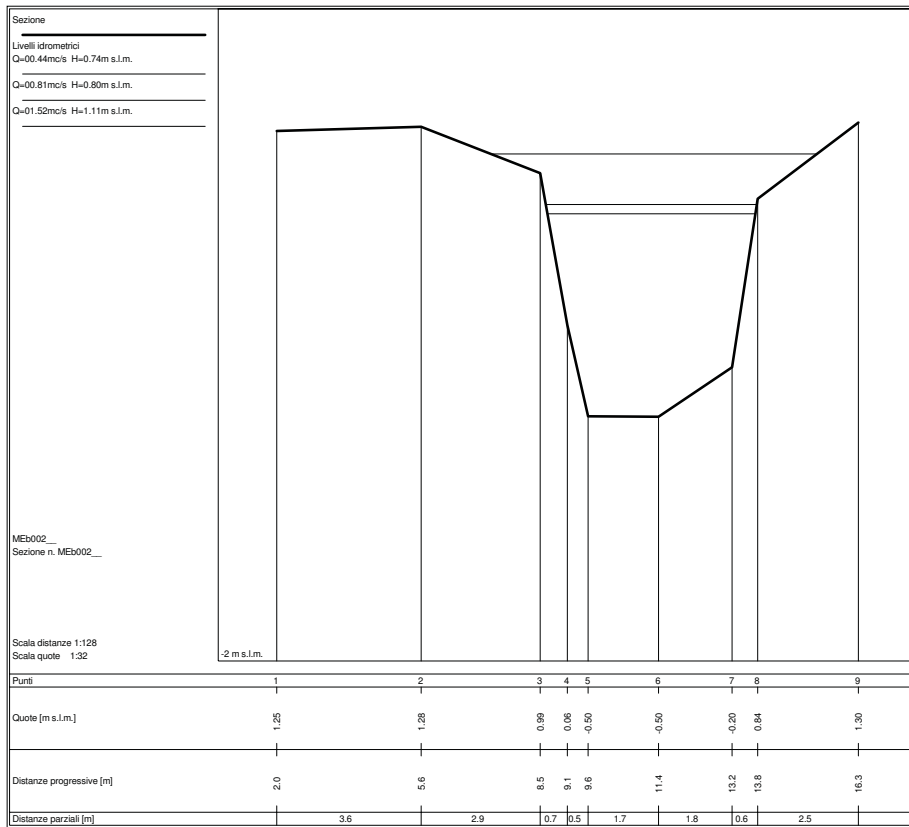

## **FOSSO DI MEZZO – RAMO C**

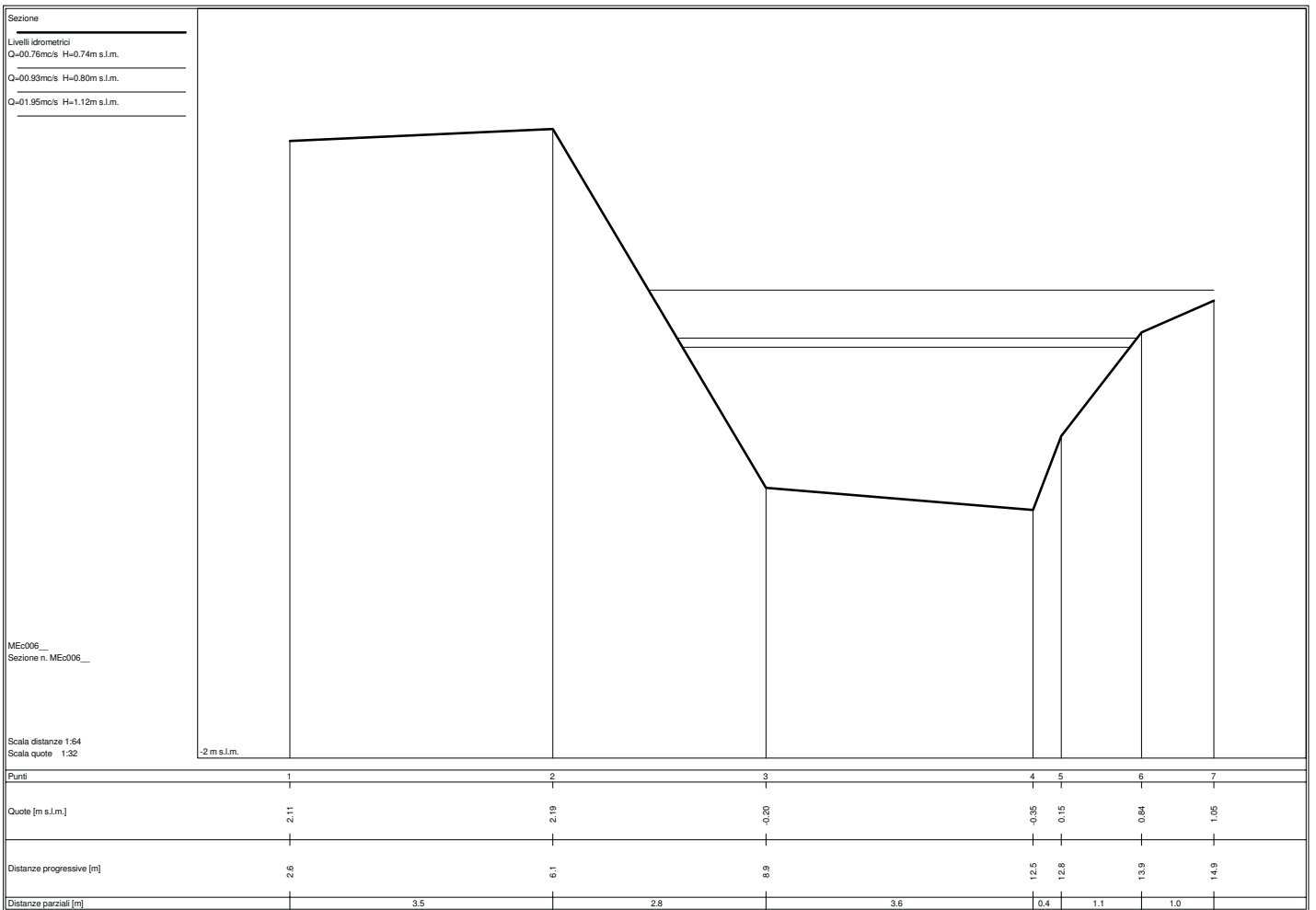
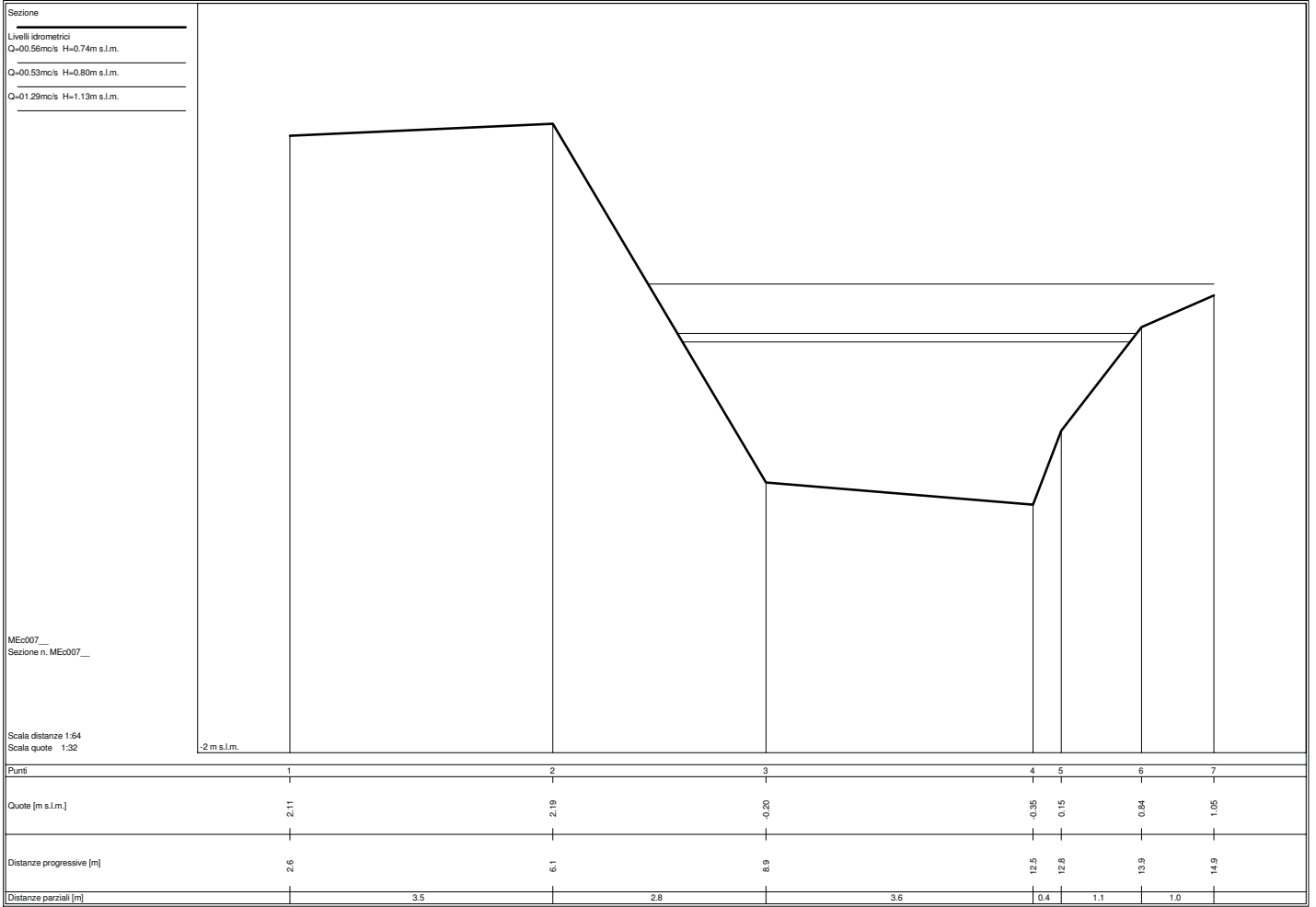

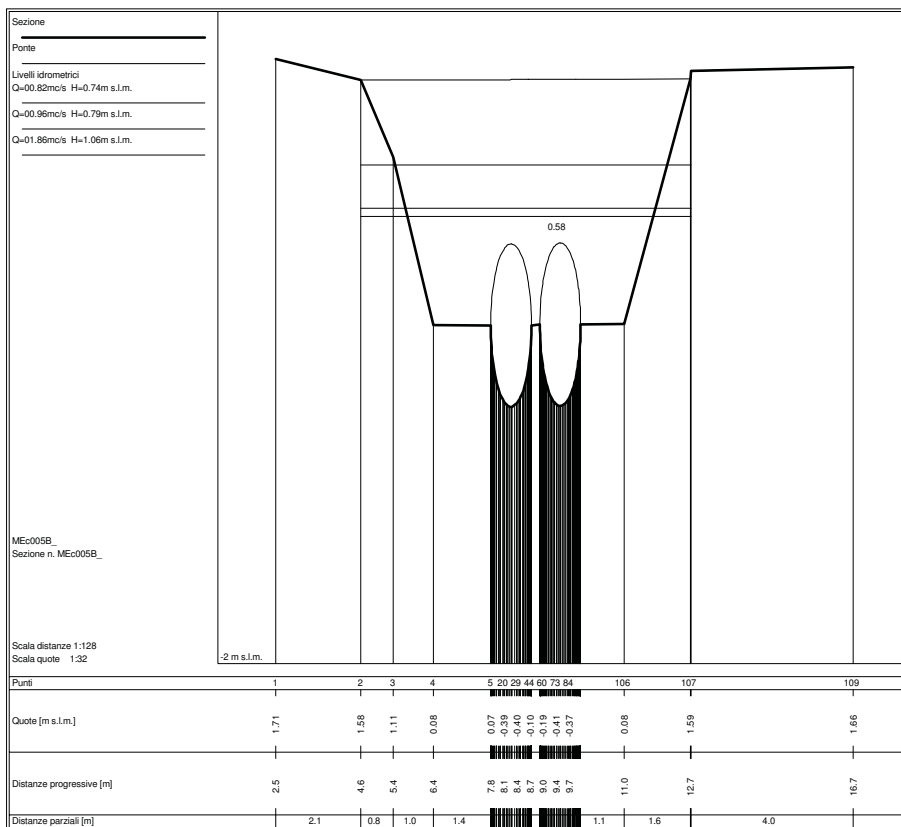
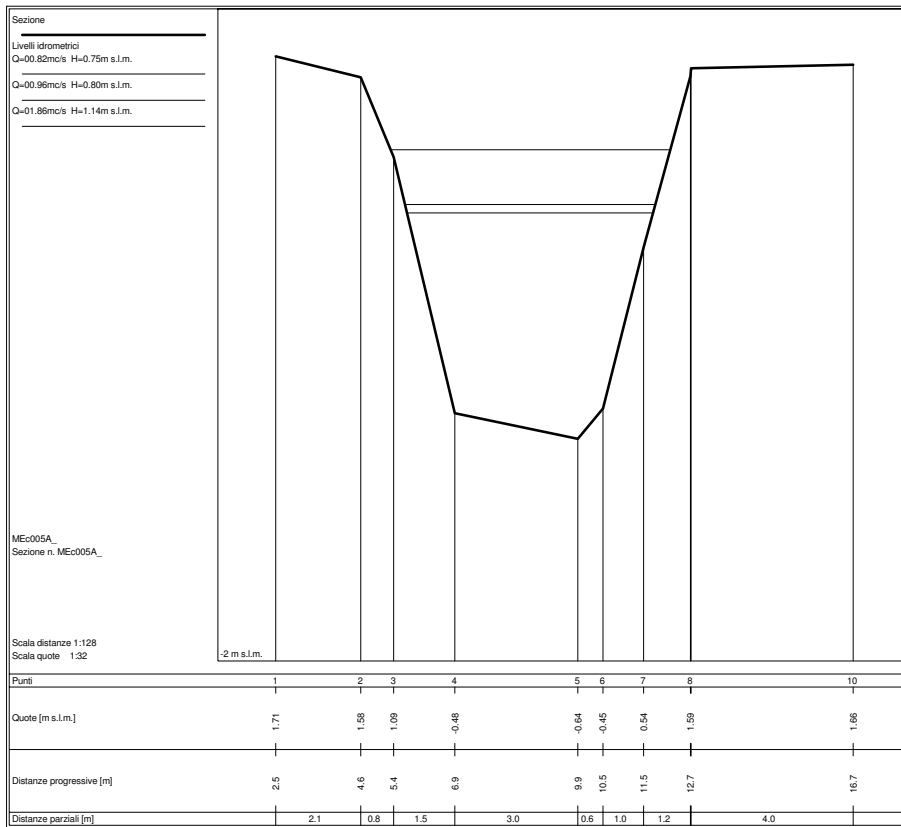

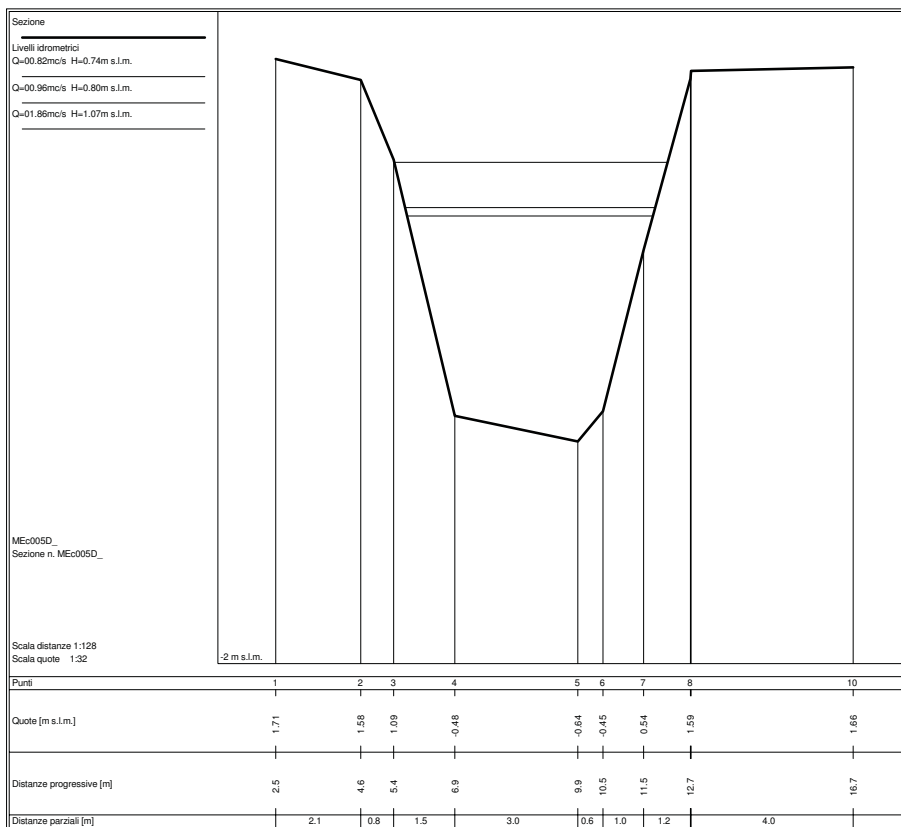
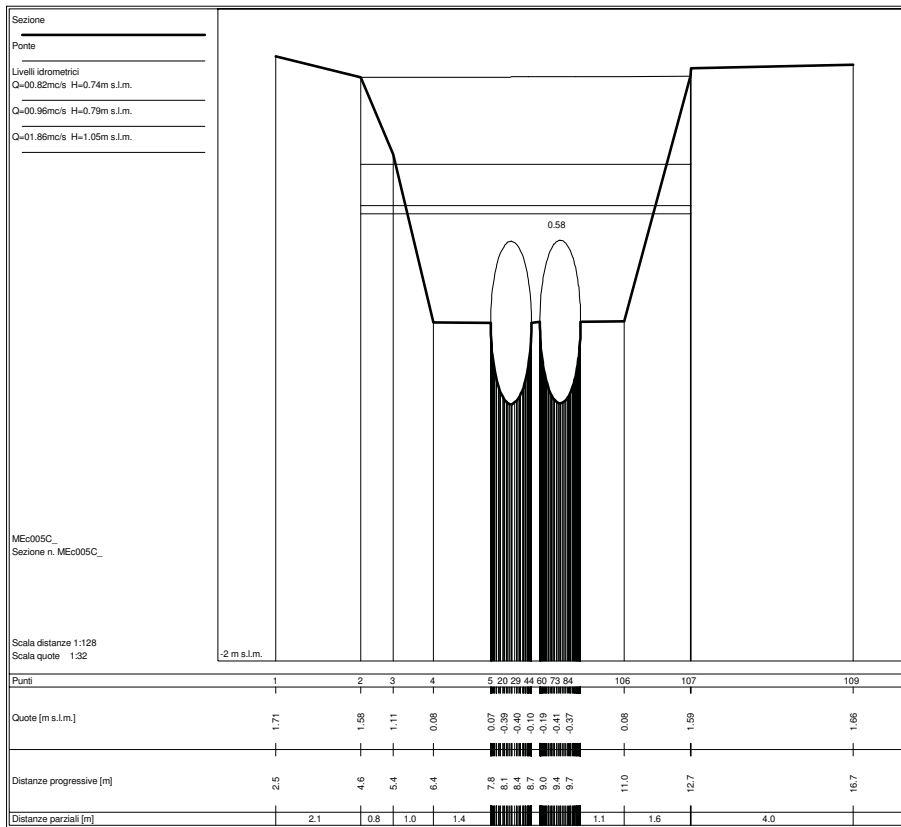

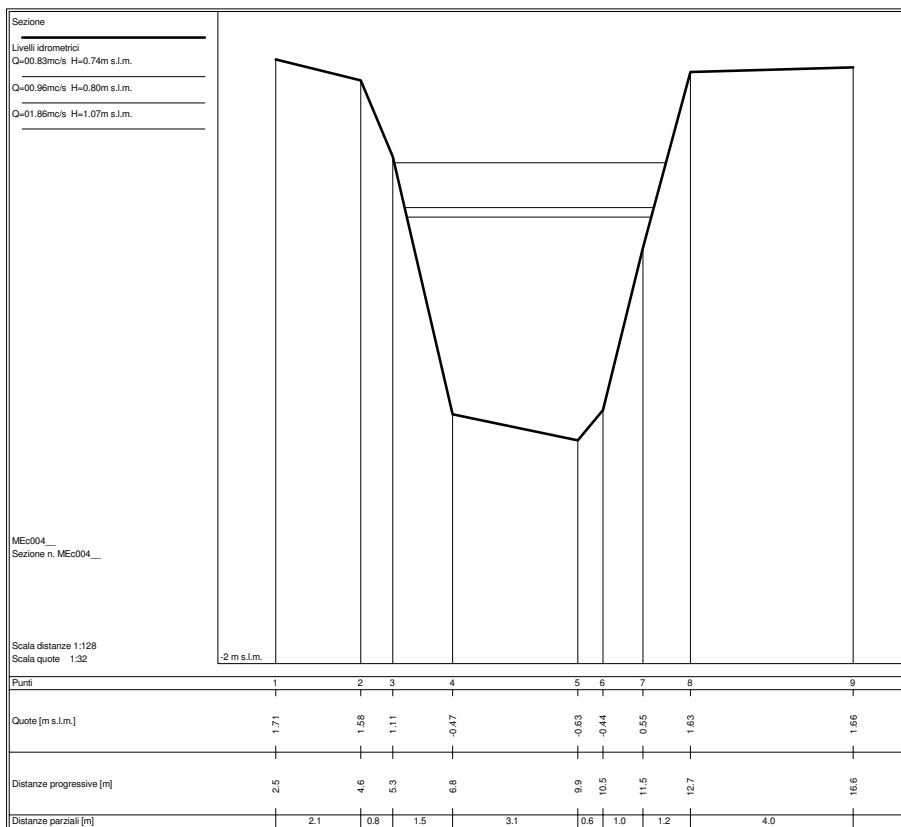
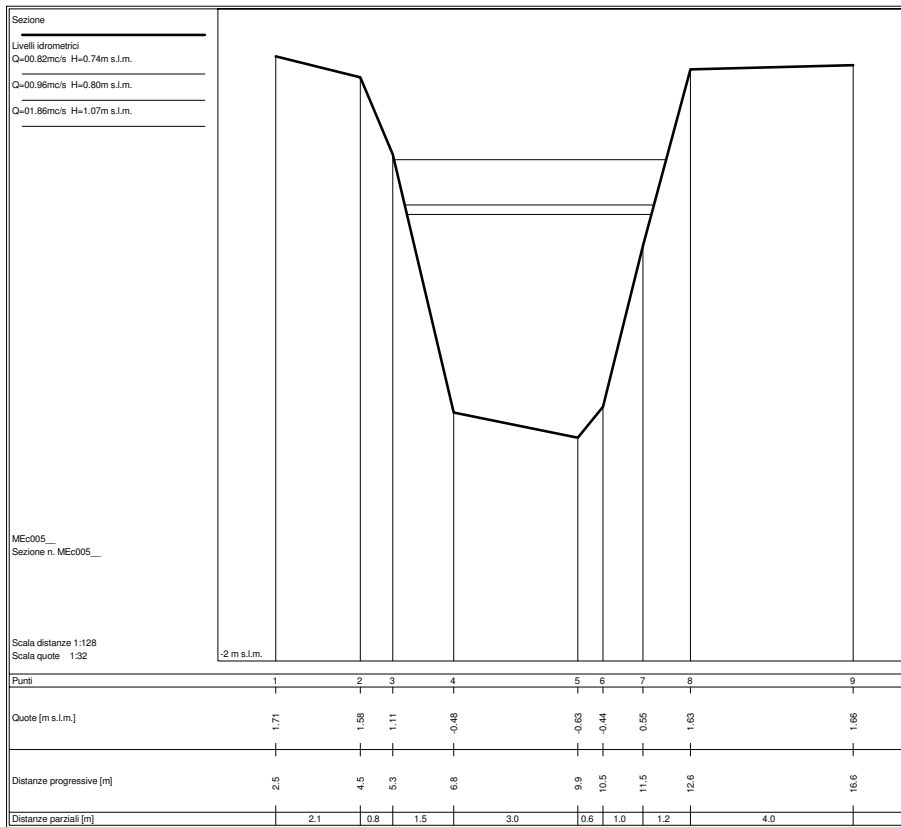

Sezione  
 Livelli idrometrici  
 Q=00.99mc/s H=0.74m s.l.m.  
 Q=00.97mc/s H=0.80m s.l.m.  
 Q=01.91mc/s H=1.08m s.l.m.

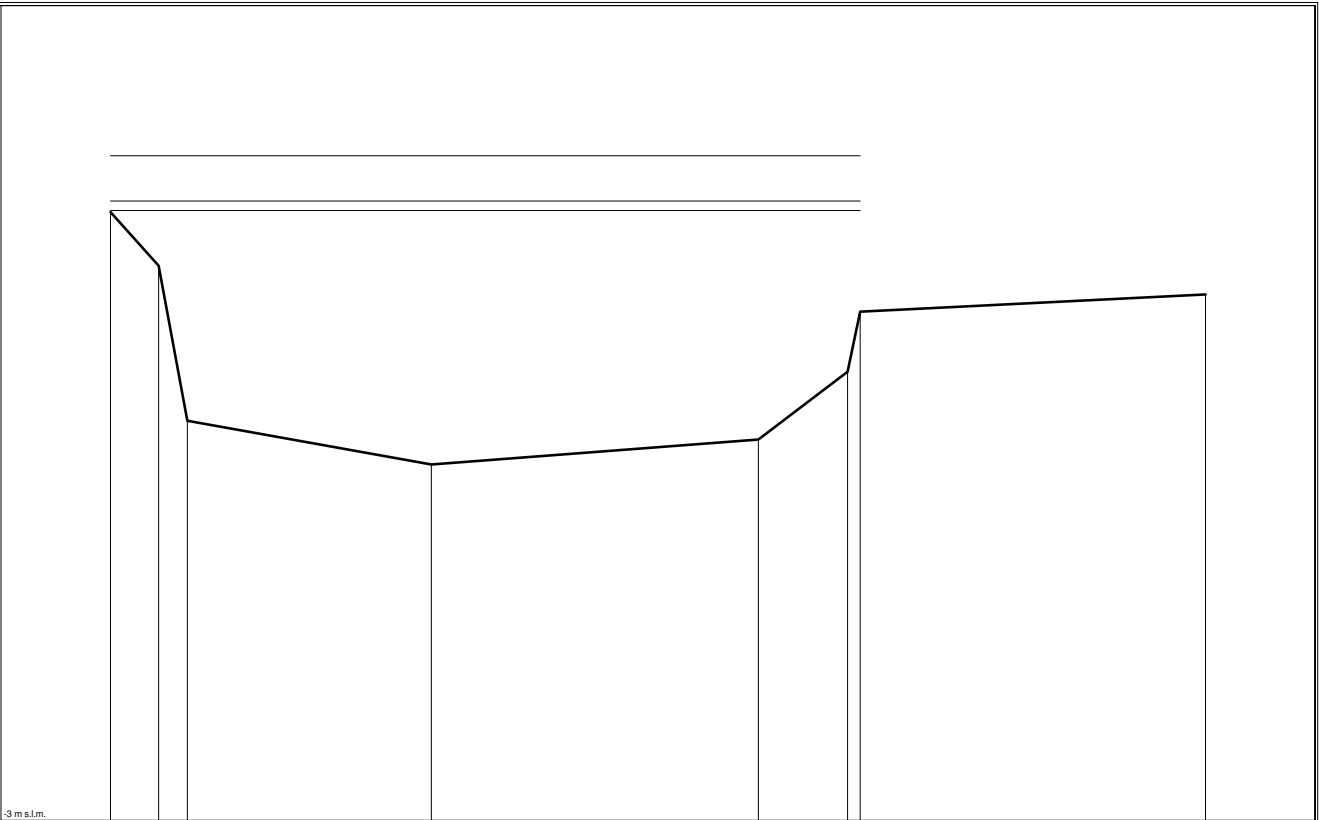

MEc003  
 Sezione n. MEc003

Scala distanze 1:64  
 Scala quote 1:32

3 m s.l.m.

|                          |      |      |       |       |       |       |      |      |
|--------------------------|------|------|-------|-------|-------|-------|------|------|
| Punti                    | 1    | 2    | 3     | 4     | 5     | 6     | 7    | 8    |
| Quote [m s.l.m.]         | 0.73 | 0.40 | -0.95 | -0.82 | -0.67 | -0.25 | 0.12 | 0.23 |
| Distanze progressive [m] | 2.5  | 3.0  | 3.4   | 6.4   | 10.4  | 11.5  | 11.7 | 15.9 |
| Distanze parziali [m]    | 0.6  | 0.4  | 3.0   | 4.0   | 1.1   | 4.2   |      |      |

Sezione  
 Livelli idrometrici  
 Q=01.03mc/s H=0.74m s.l.m.  
 Q=01.05mc/s H=0.80m s.l.m.  
 Q=02.17mc/s H=1.08m s.l.m.

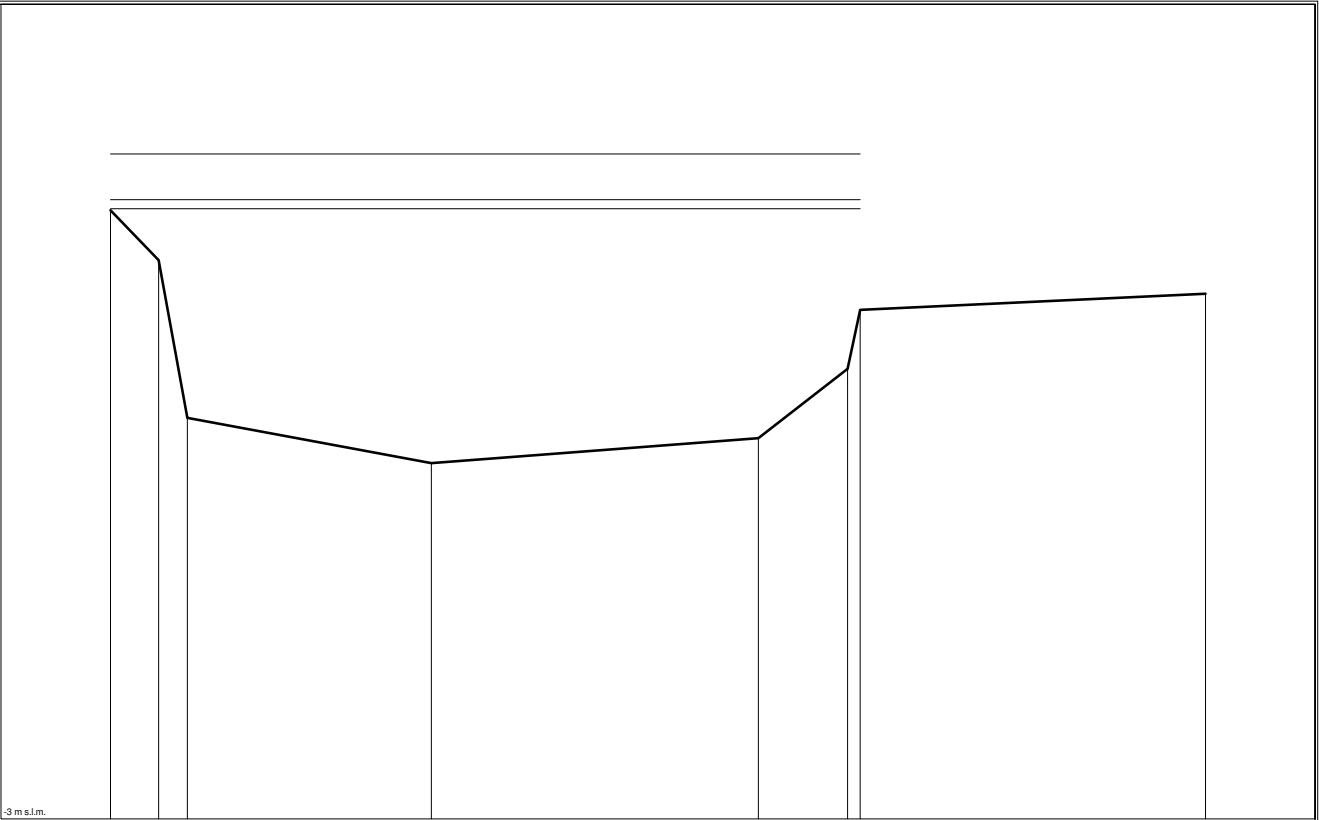

MEc002  
 Sezione n. MEc002

Scala distanze 1:64  
 Scala quote 1:32

3 m s.l.m.

|                          |      |      |       |       |       |       |      |      |
|--------------------------|------|------|-------|-------|-------|-------|------|------|
| Punti                    | 1    | 2    | 3     | 4     | 5     | 6     | 7    | 8    |
| Quote [m s.l.m.]         | 0.73 | 0.43 | -0.94 | -0.82 | -0.66 | -0.24 | 0.12 | 0.22 |
| Distanze progressive [m] | 2.5  | 3.1  | 3.4   | 6.4   | 10.4  | 11.5  | 11.7 | 15.9 |
| Distanze parziali [m]    | 0.6  | 0.3  | 3.0   | 4.0   | 1.1   | 4.2   |      |      |



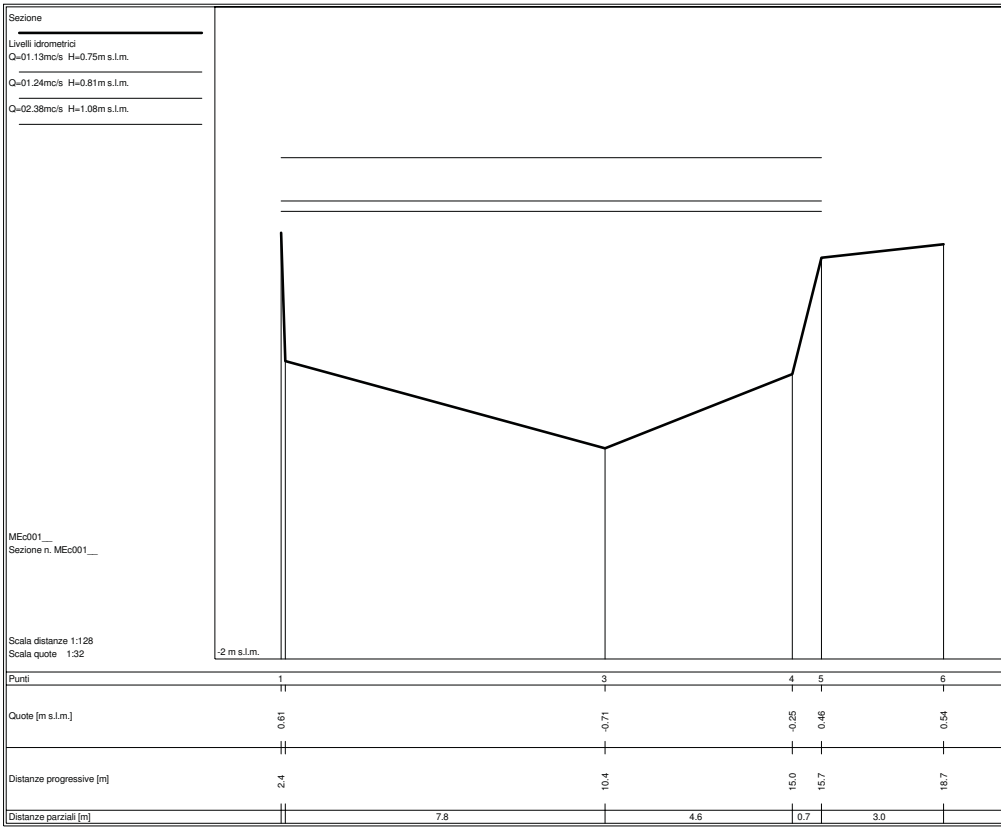

## **FOSSO CONNETTORE 1**

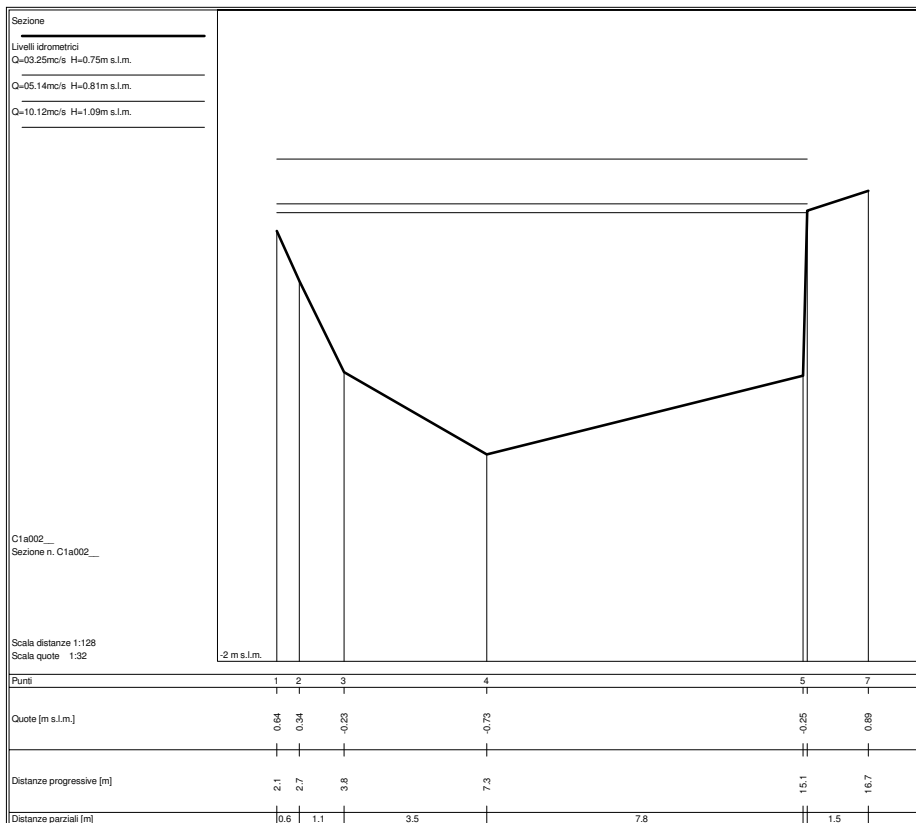
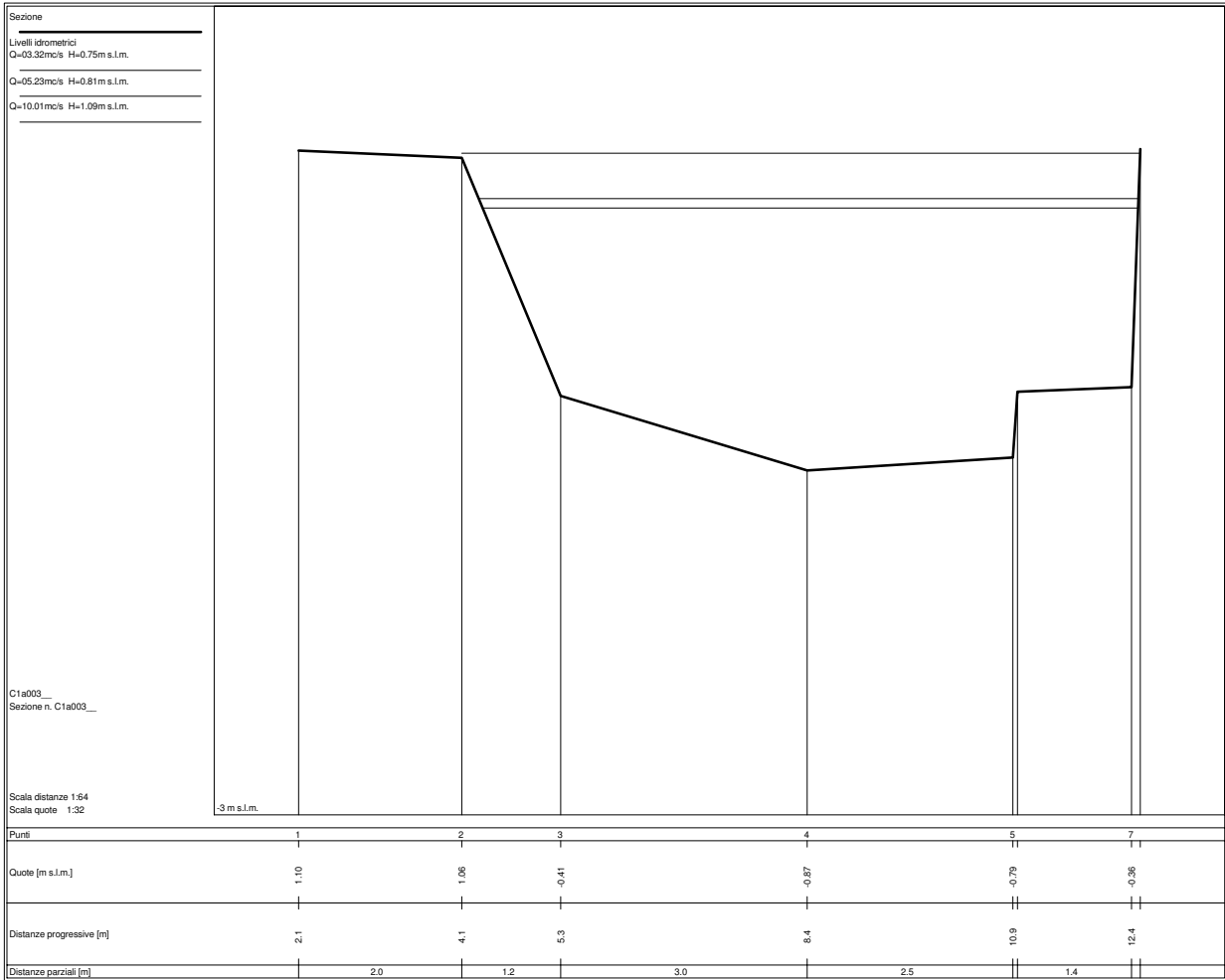

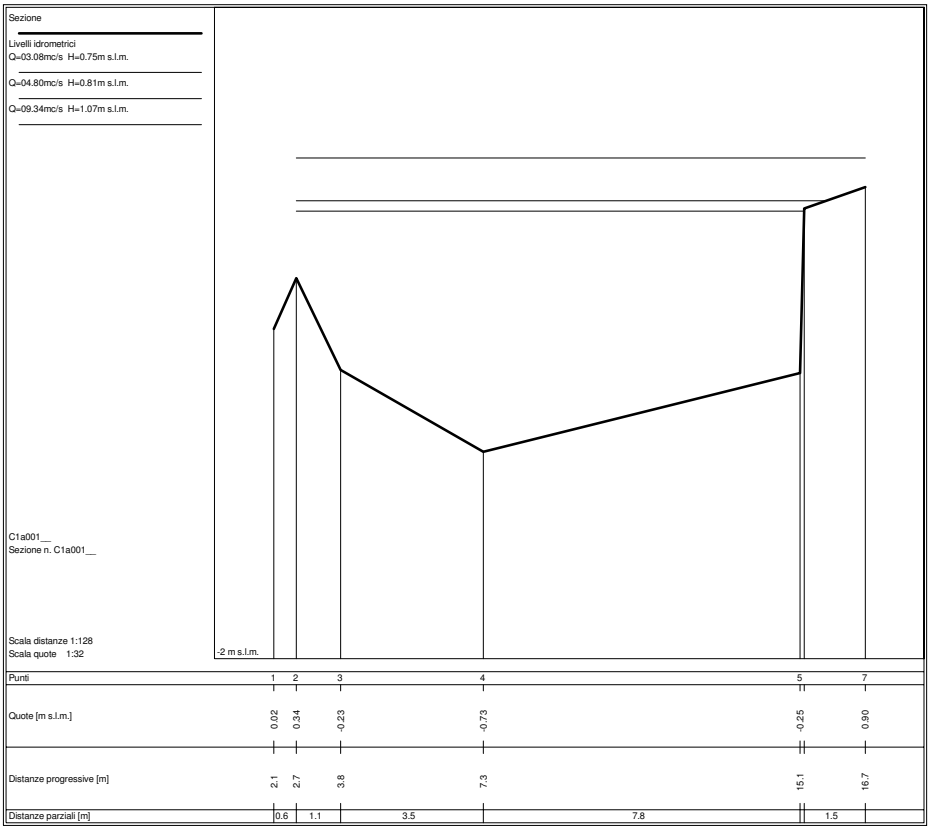

## **FOSSO CONNETTORE 2**

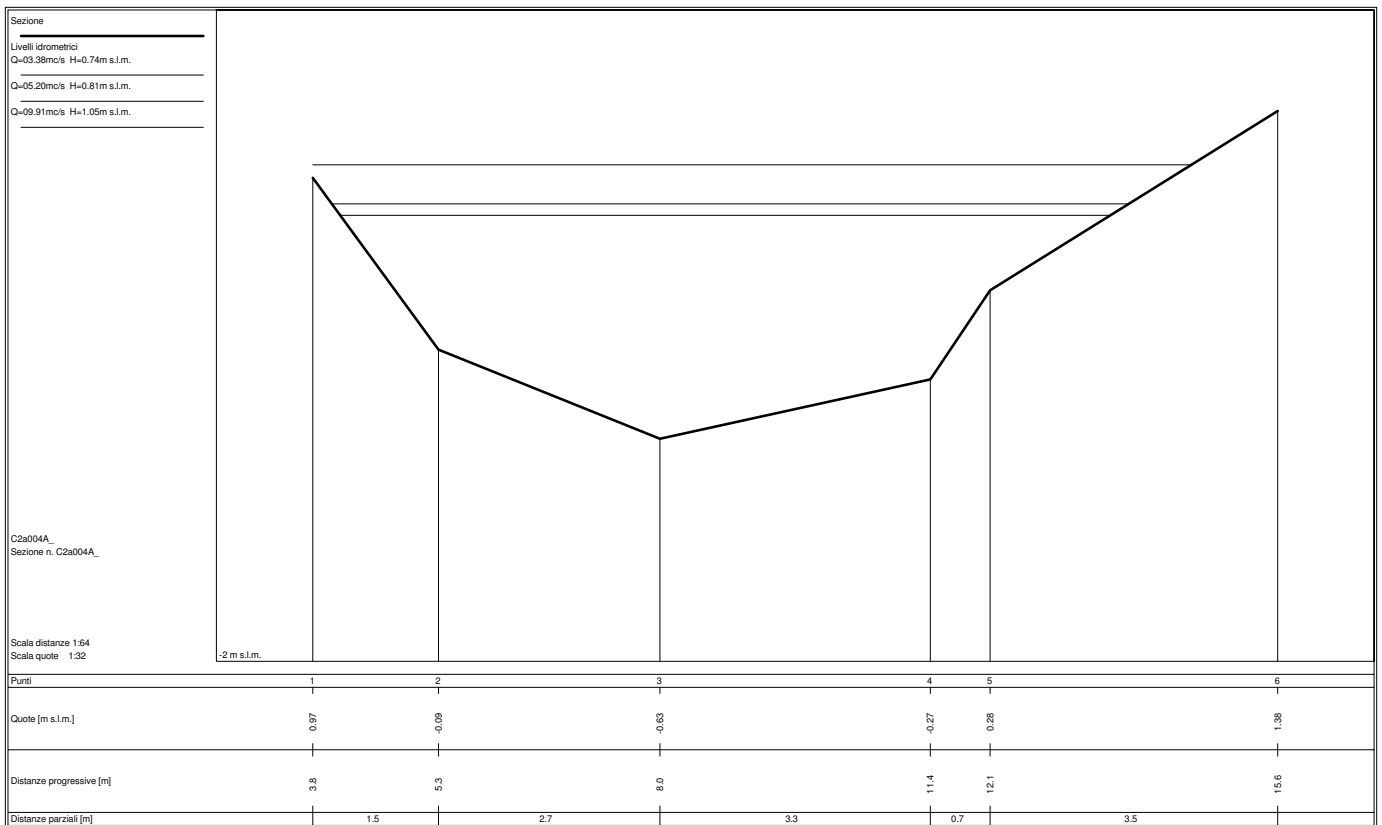
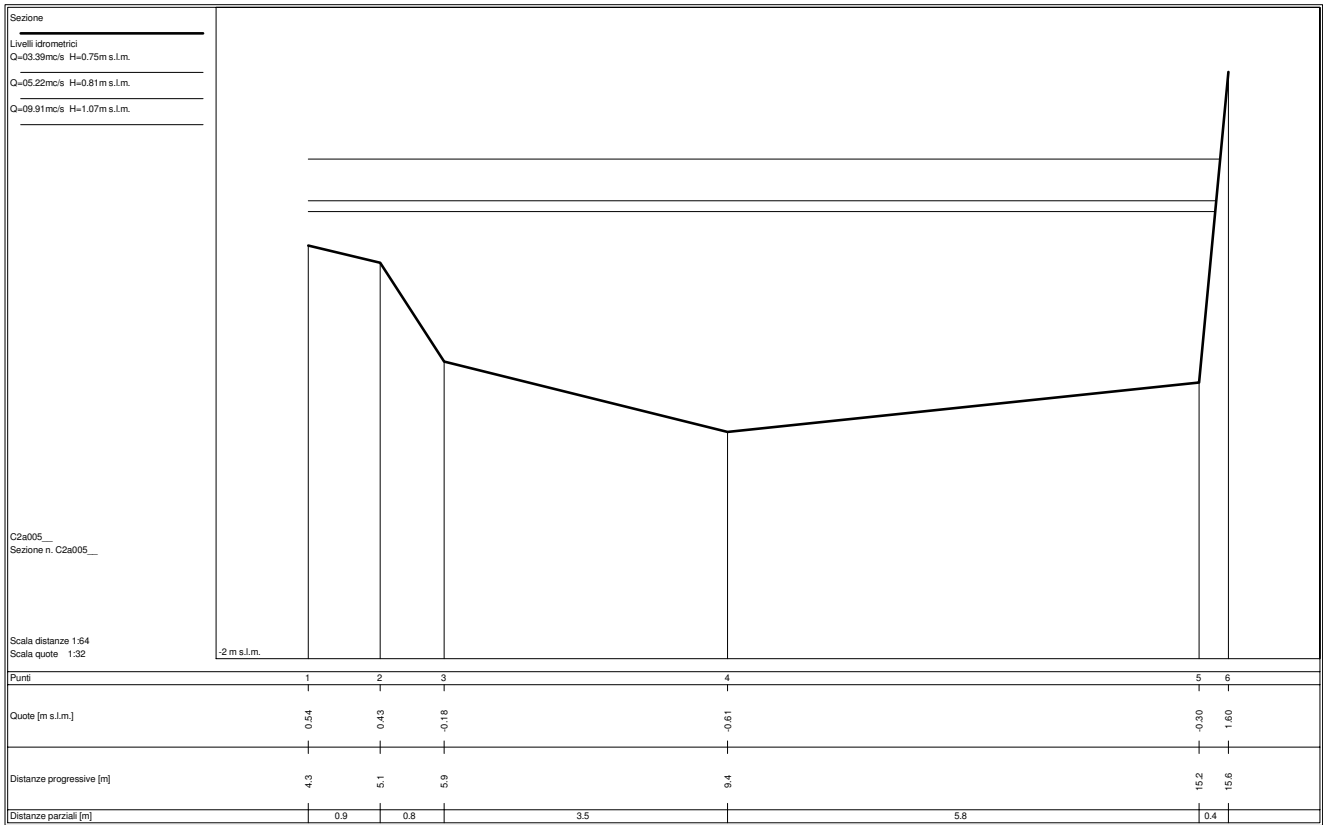

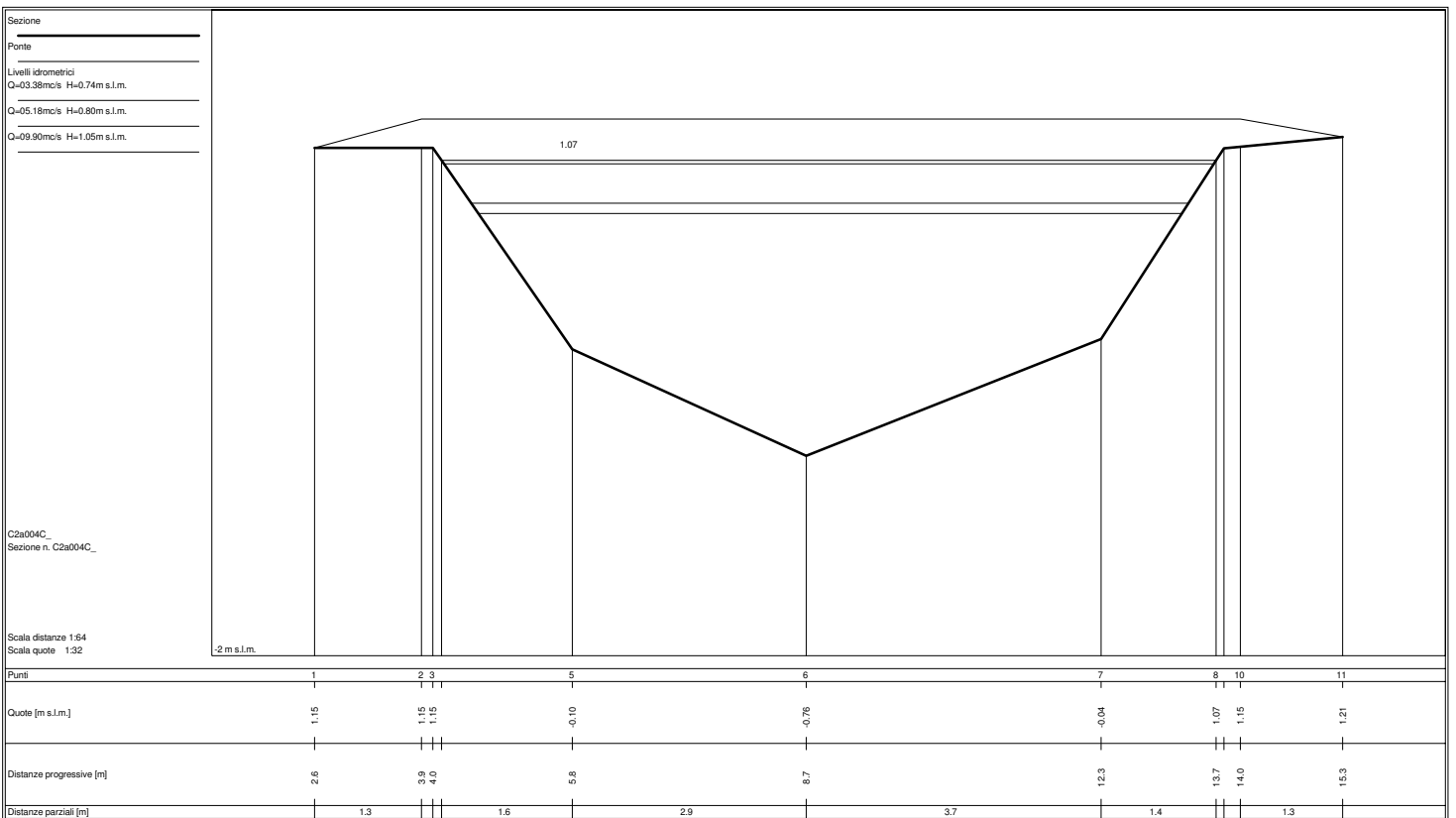
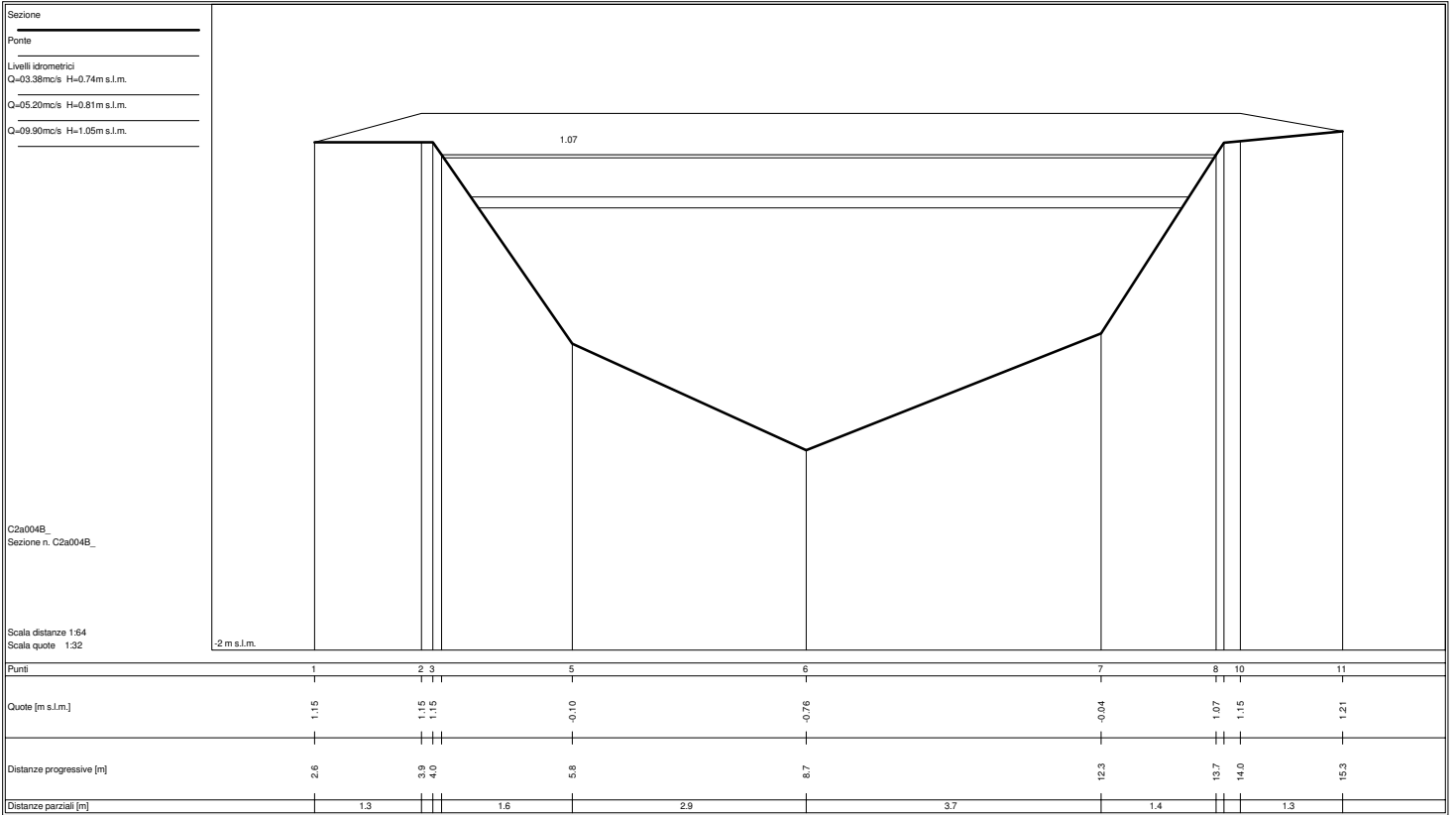

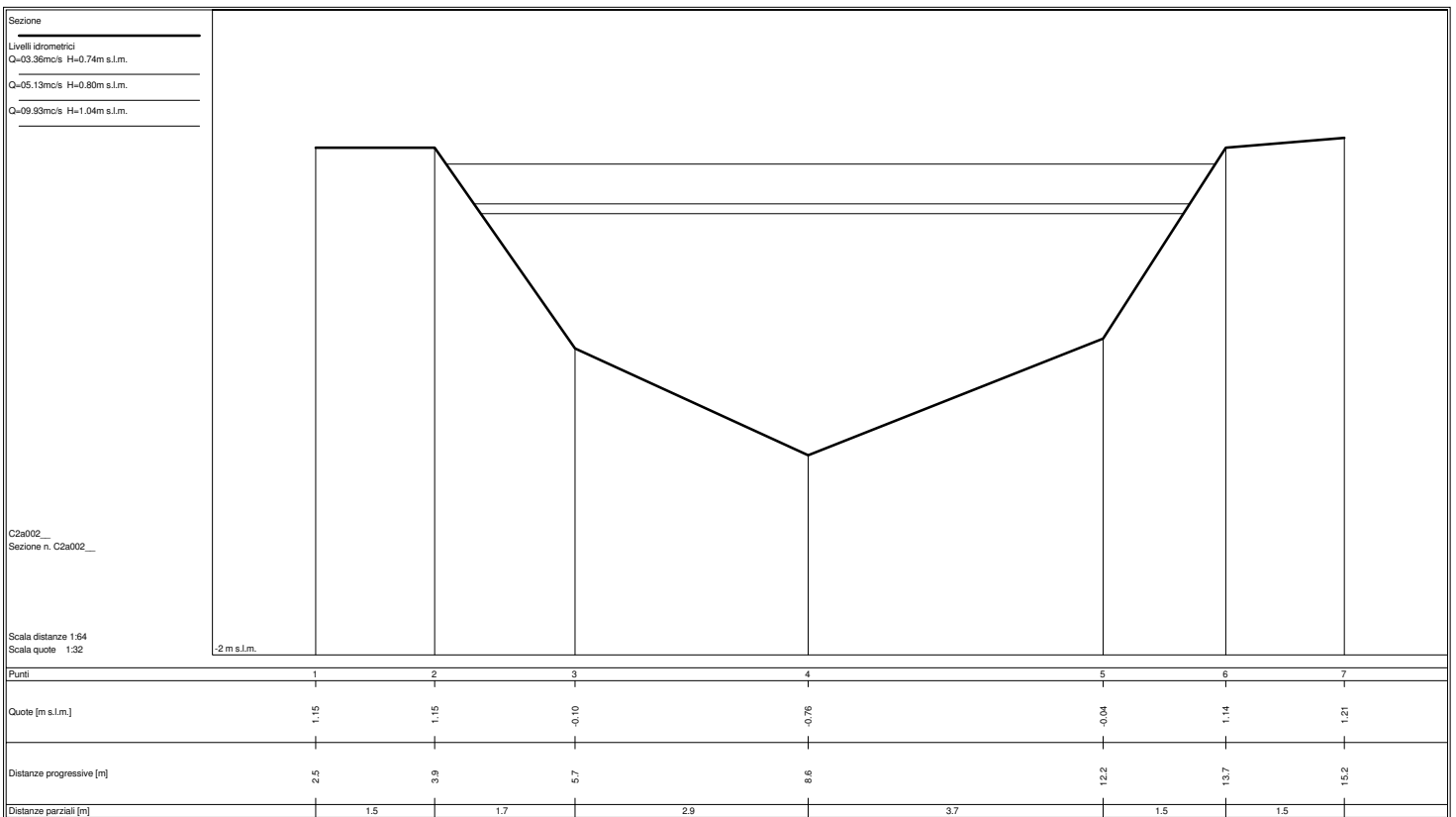
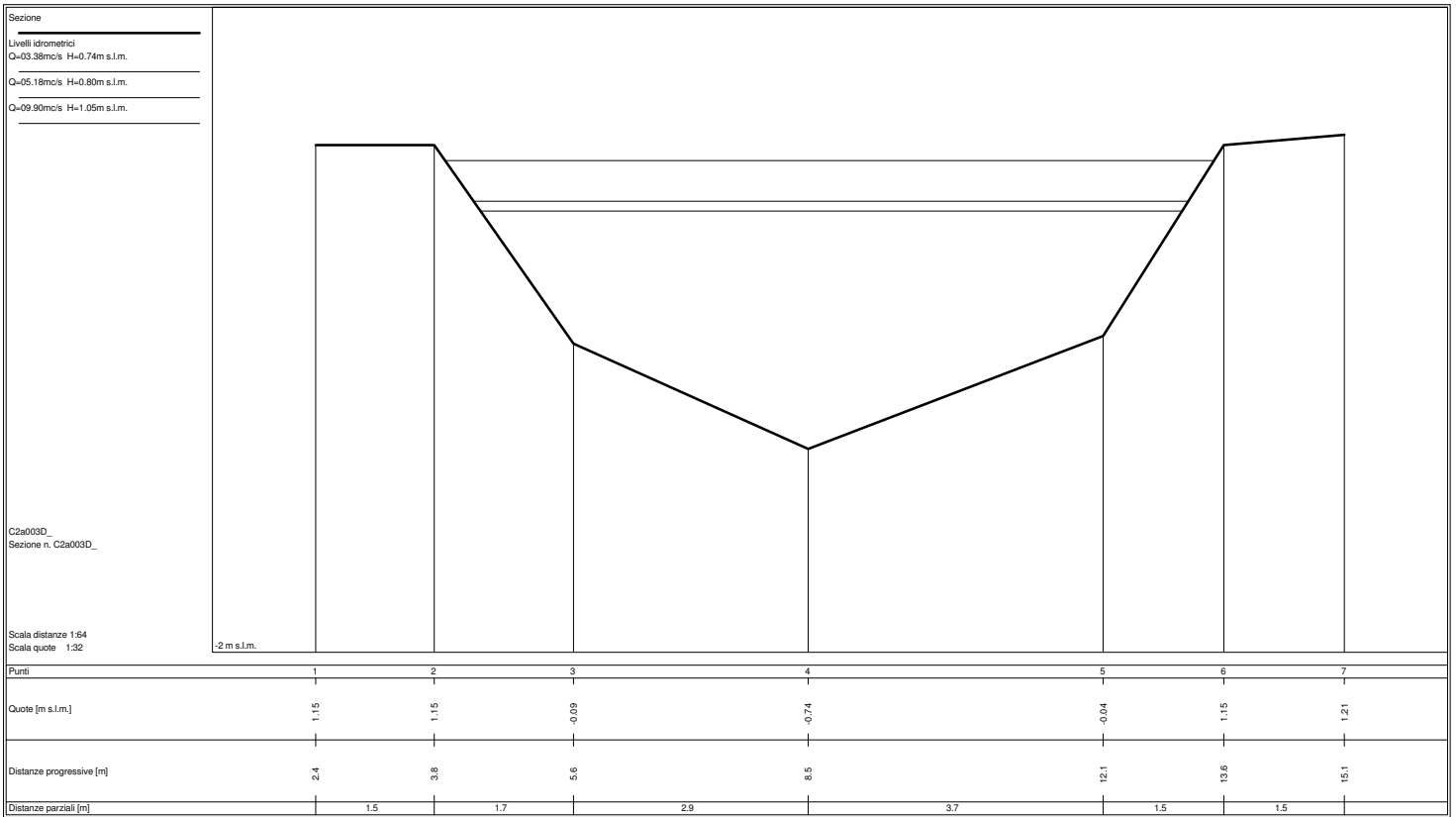



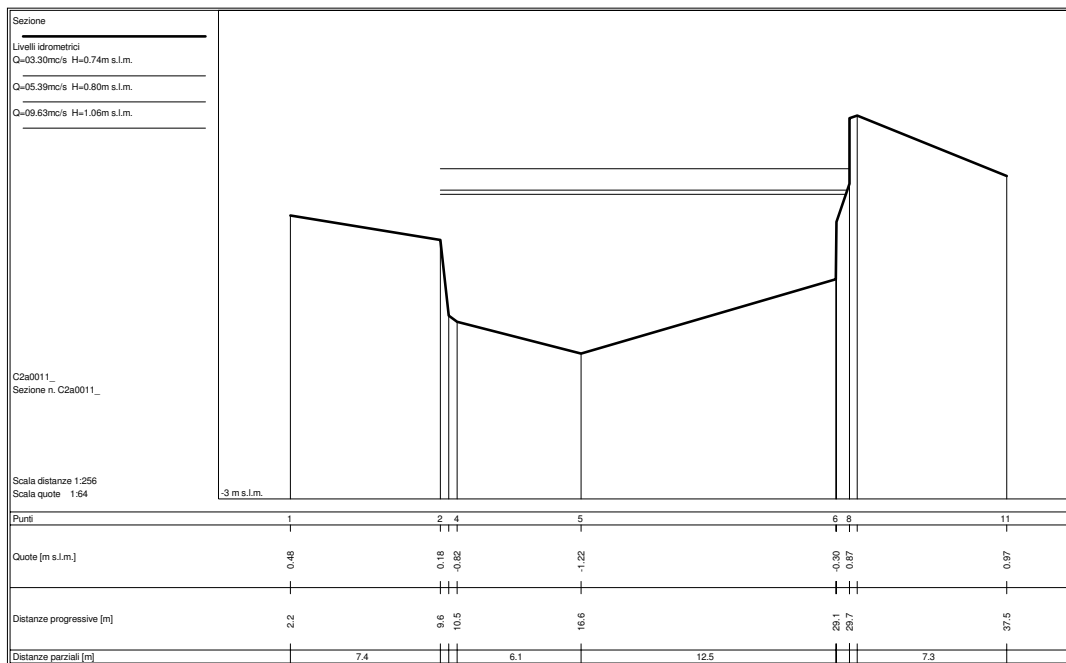
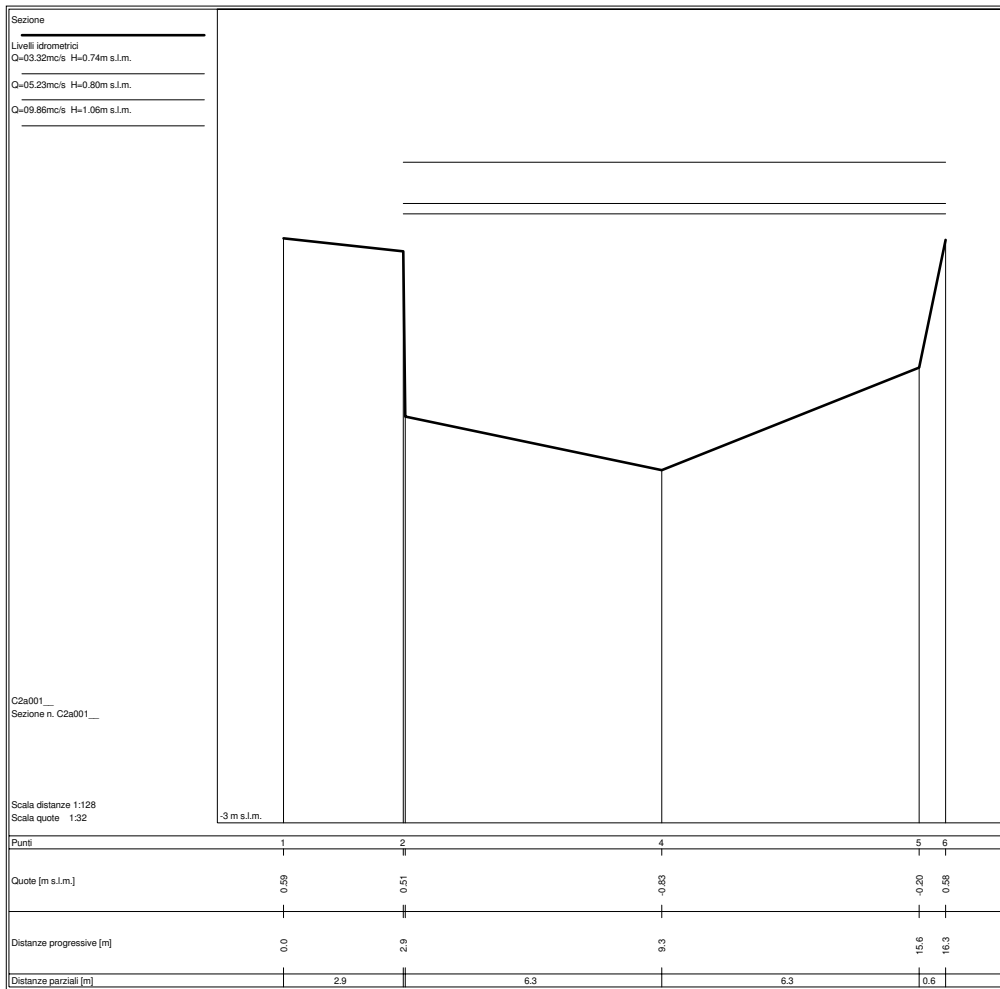

## **FOSSO BRUGIANO – RAMO A**

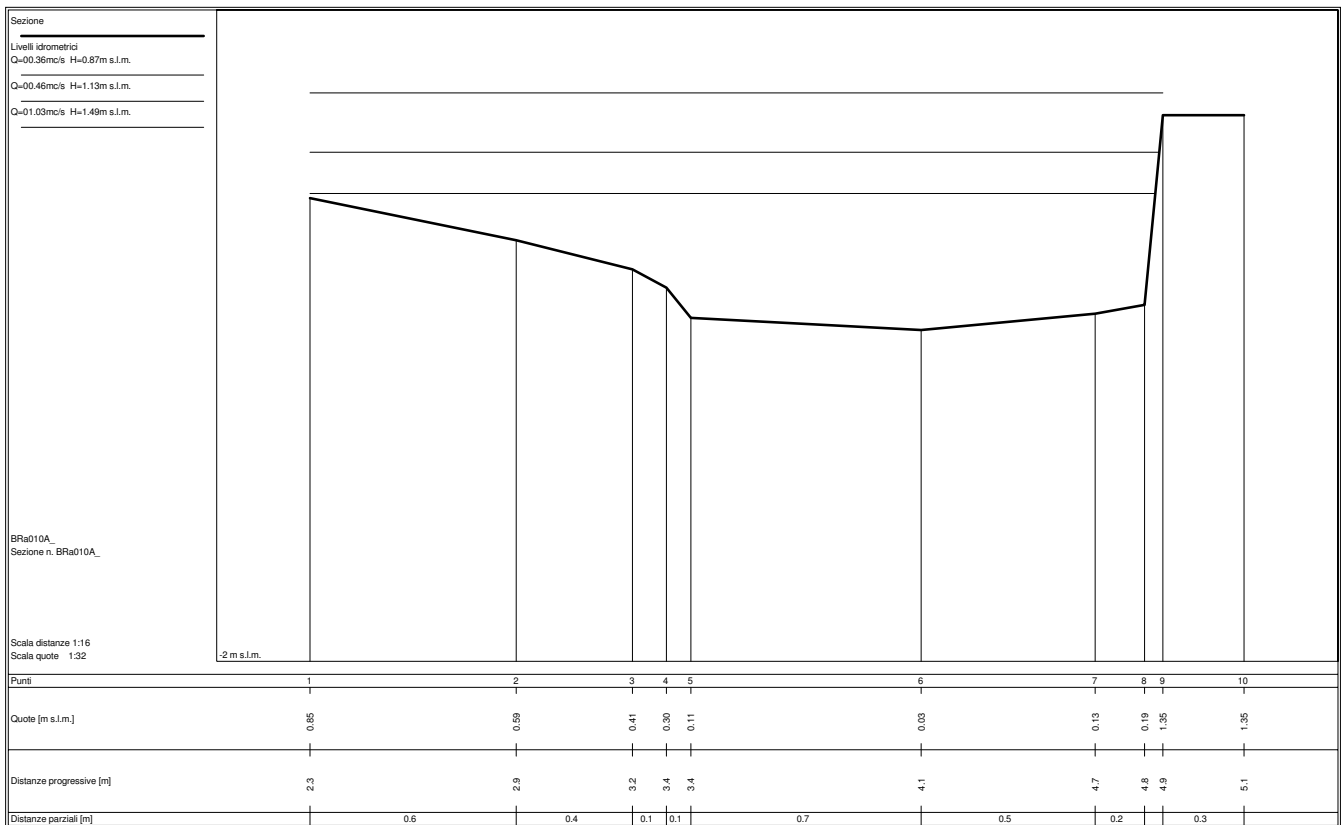
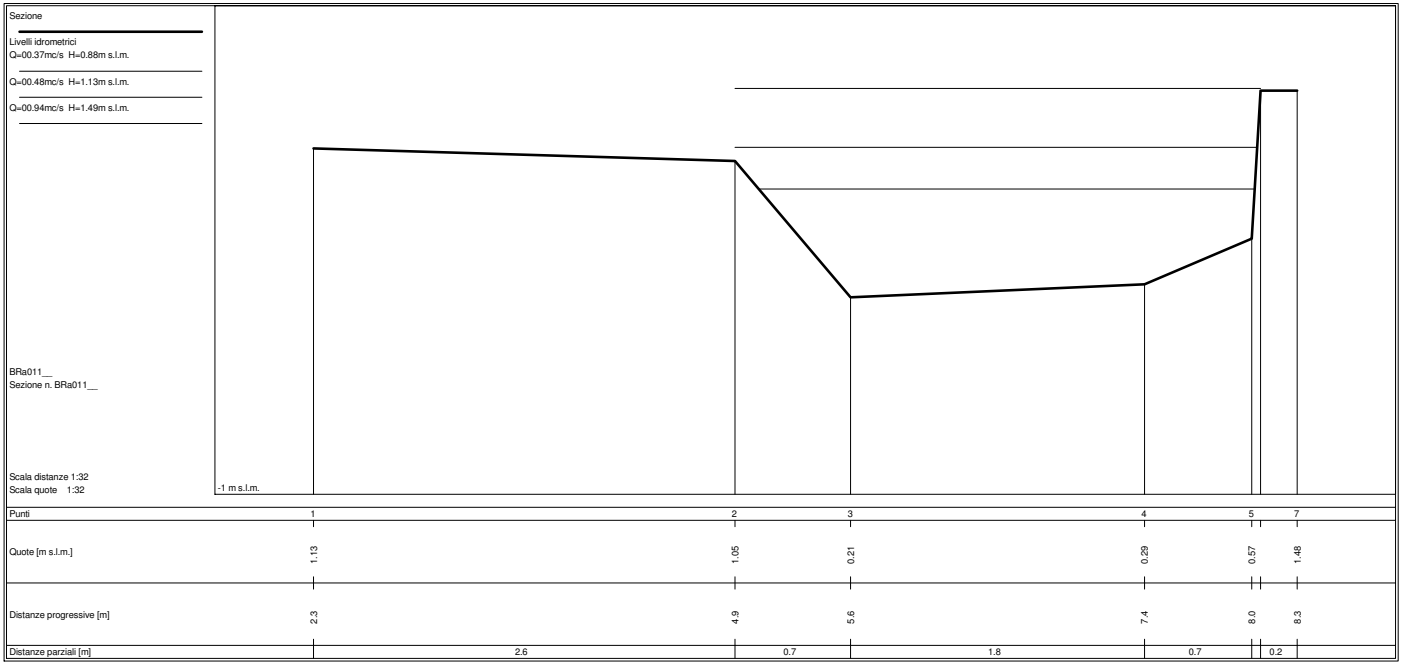

Sezione  
 Ponte  
 Livelli idrometrici  
 Q=00.36m<sup>3</sup>/s H=0.87m s.l.m.  
 Q=00.46m<sup>3</sup>/s H=1.12m s.l.m.  
 Q=01.03m<sup>3</sup>/s H=1.49m s.l.m.

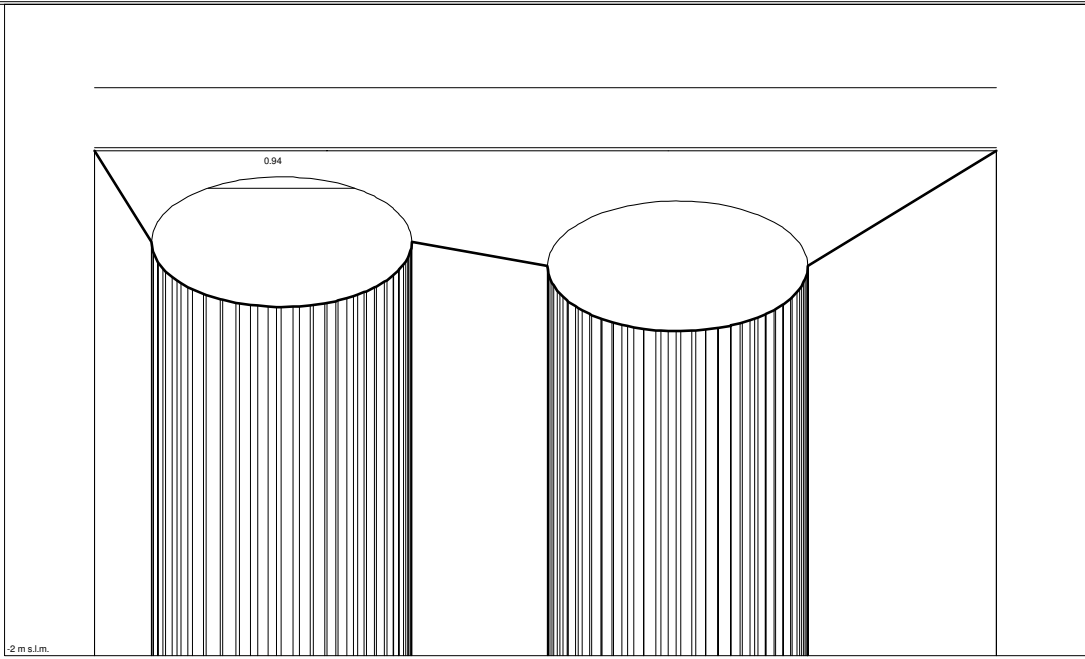

BRa010B\_  
 Sezione n. BRa010B\_

Scala distanze 1:16  
 Scala quote 1:32

|                          |      |      |      |      |      |      |      |      |      |      |      |      |      |      |      |      |      |      |      |      |      |      |      |      |      |      |      |       |       |      |      |      |      |      |      |      |     |
|--------------------------|------|------|------|------|------|------|------|------|------|------|------|------|------|------|------|------|------|------|------|------|------|------|------|------|------|------|------|-------|-------|------|------|------|------|------|------|------|-----|
| Punti                    | 1    | 3    | 9    | 12   | 15   | 17   | 18   | 20   | 22   | 24   | 26   | 28   | 30   | 32   | 35   | 38   | 42   | 46   | 54   | 55   | 62   | 66   | 69   | 72   | 75   | 78   | 81   | 83    | 85    | 87   | 91   | 95   | 98   | 104  | 117  |      |     |
| Quote [m s.l.m.]         | 1.10 | 0.54 | 0.38 | 0.30 | 0.25 | 0.22 | 0.19 | 0.17 | 0.15 | 0.14 | 0.14 | 0.15 | 0.15 | 0.17 | 0.19 | 0.23 | 0.30 | 0.37 | 0.54 | 0.39 | 0.22 | 0.15 | 0.10 | 0.07 | 0.03 | 0.01 | 0.00 | -0.01 | -0.01 | 0.00 | 0.00 | 0.03 | 0.06 | 0.10 | 0.19 | 1.10 |     |
| Distanze progressive [m] | 2.3  | 2.4  | 2.5  | 2.6  | 2.6  | 2.7  | 2.7  | 2.8  | 2.8  | 2.8  | 2.8  | 2.9  | 2.9  | 3.0  | 3.0  | 3.1  | 3.2  | 3.2  | 3.2  | 3.7  | 3.7  | 3.7  | 3.8  | 3.8  | 3.9  | 4.0  | 4.0  | 4.1   | 4.1   | 4.1  | 4.1  | 4.2  | 4.3  | 4.3  | 4.4  | 5.0  |     |
| Distanze parziali [m]    | 0.2  |      |      |      |      |      |      |      |      |      |      |      |      |      |      |      |      |      |      | 0.4  |      |      |      |      |      |      |      |       |       |      |      |      |      |      |      |      | 0.6 |

Sezione  
 Ponte  
 Livelli idrometrici  
 Q=00.36m<sup>3</sup>/s H=0.87m s.l.m.  
 Q=00.46m<sup>3</sup>/s H=1.12m s.l.m.  
 Q=01.04m<sup>3</sup>/s H=1.48m s.l.m.

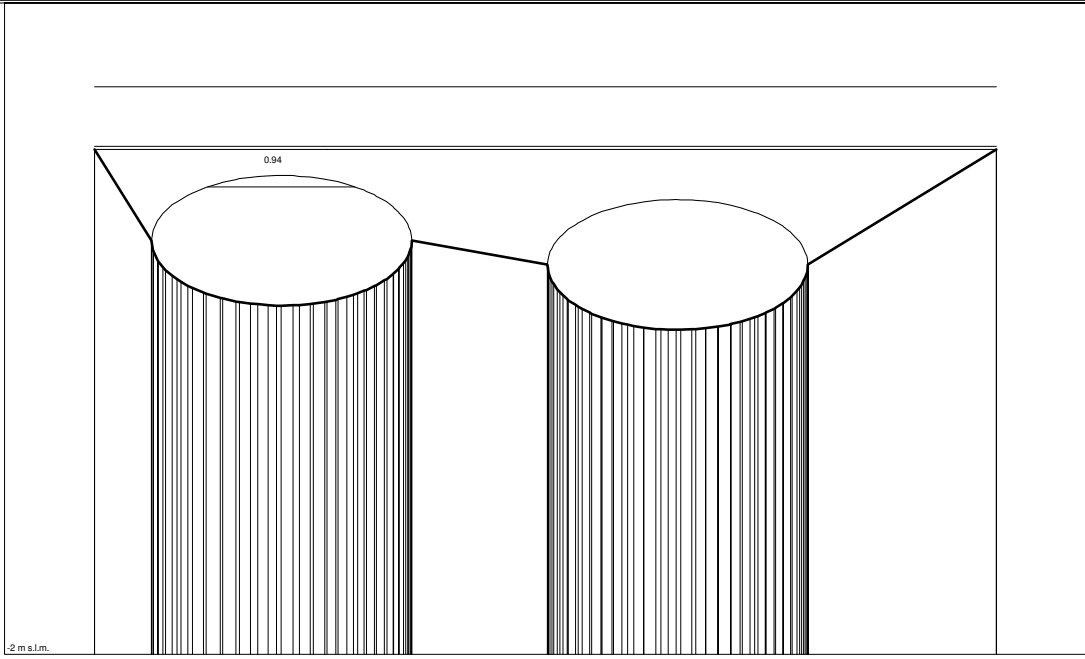

BRa010C\_  
 Sezione n. BRa010C\_

Scala distanze 1:16  
 Scala quote 1:32

|                          |      |      |      |      |      |      |      |      |      |      |      |      |      |      |      |      |      |      |      |      |      |      |      |      |      |      |      |       |       |      |      |      |      |      |      |      |     |
|--------------------------|------|------|------|------|------|------|------|------|------|------|------|------|------|------|------|------|------|------|------|------|------|------|------|------|------|------|------|-------|-------|------|------|------|------|------|------|------|-----|
| Punti                    | 1    | 3    | 9    | 12   | 15   | 17   | 18   | 20   | 22   | 24   | 26   | 28   | 30   | 32   | 35   | 38   | 42   | 46   | 54   | 55   | 62   | 66   | 69   | 72   | 75   | 78   | 81   | 83    | 85    | 87   | 91   | 95   | 98   | 104  | 117  |      |     |
| Quote [m s.l.m.]         | 1.10 | 0.54 | 0.38 | 0.30 | 0.25 | 0.22 | 0.19 | 0.17 | 0.15 | 0.14 | 0.14 | 0.15 | 0.15 | 0.17 | 0.19 | 0.23 | 0.30 | 0.37 | 0.54 | 0.39 | 0.22 | 0.15 | 0.10 | 0.07 | 0.03 | 0.01 | 0.00 | -0.01 | -0.01 | 0.00 | 0.00 | 0.03 | 0.06 | 0.10 | 0.19 | 1.10 |     |
| Distanze progressive [m] | 2.3  | 2.4  | 2.5  | 2.6  | 2.6  | 2.7  | 2.7  | 2.8  | 2.8  | 2.8  | 2.8  | 2.9  | 2.9  | 3.0  | 3.0  | 3.1  | 3.2  | 3.2  | 3.2  | 3.7  | 3.7  | 3.7  | 3.8  | 3.8  | 3.9  | 4.0  | 4.0  | 4.1   | 4.1   | 4.1  | 4.1  | 4.2  | 4.3  | 4.3  | 4.4  | 5.0  |     |
| Distanze parziali [m]    | 0.2  |      |      |      |      |      |      |      |      |      |      |      |      |      |      |      |      |      |      | 0.4  |      |      |      |      |      |      |      |       |       |      |      |      |      |      |      |      | 0.6 |

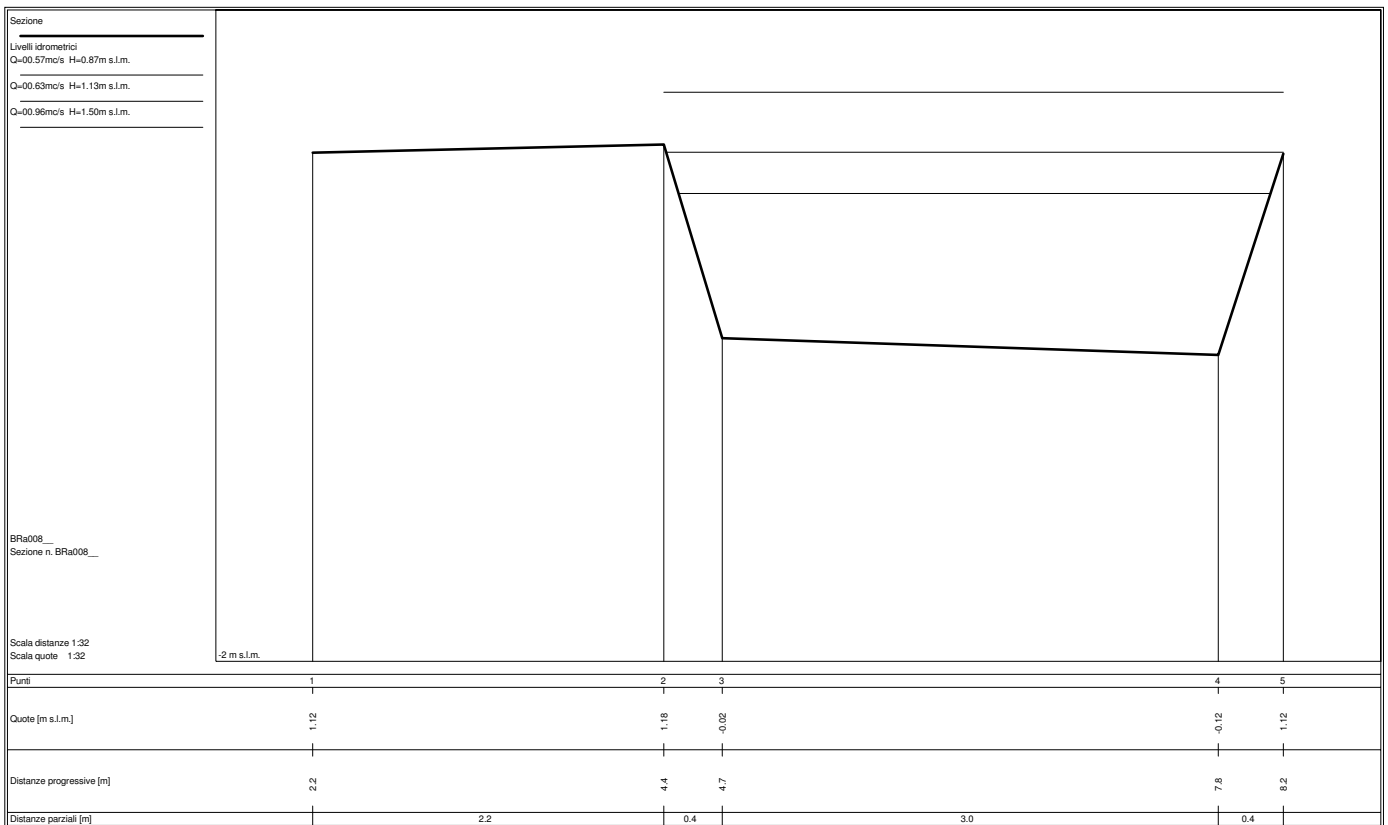
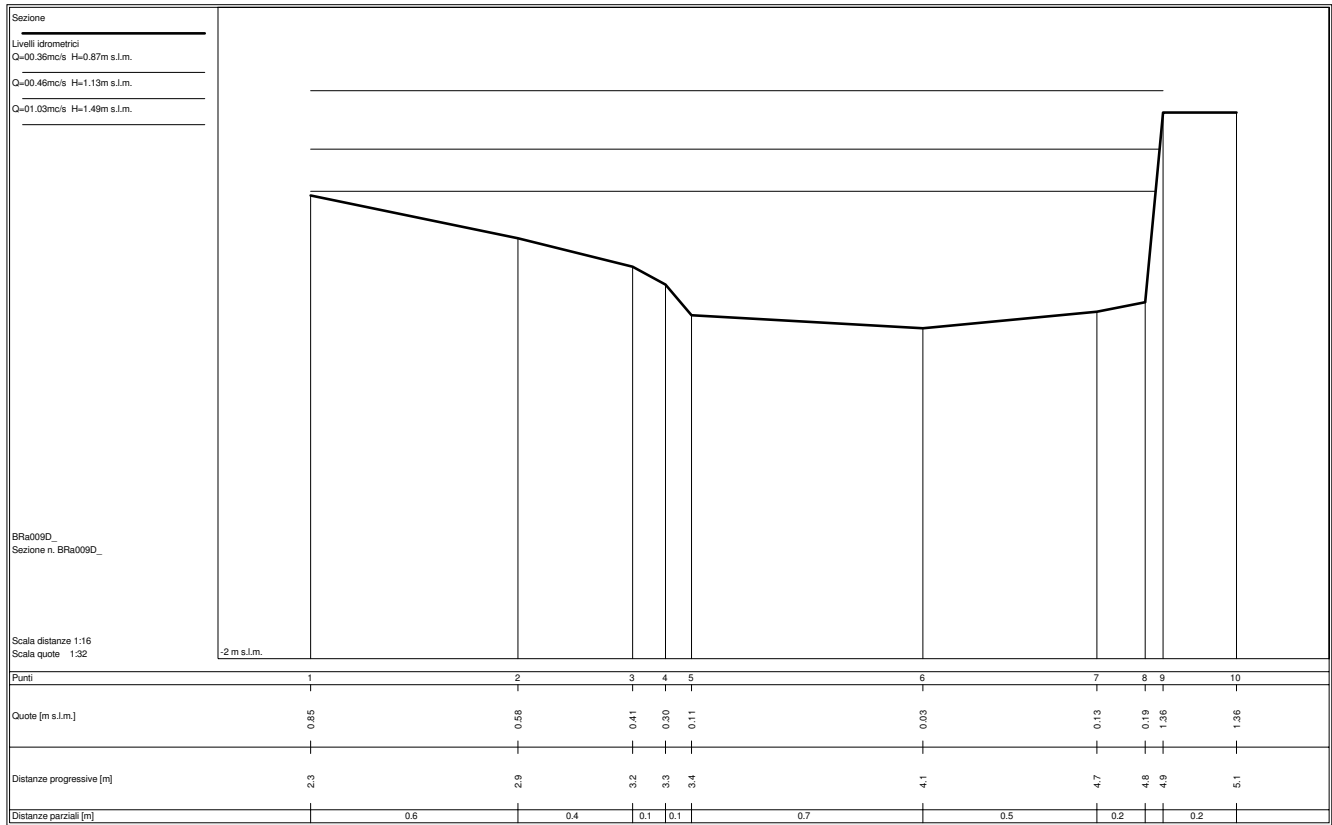

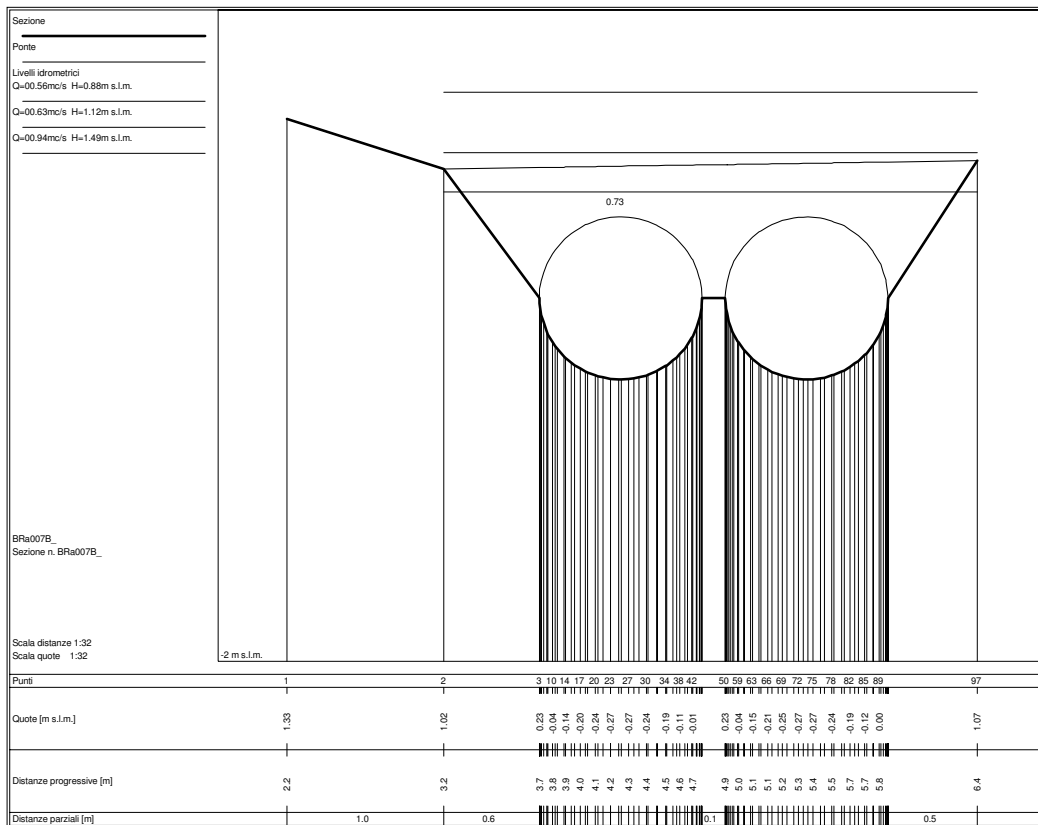
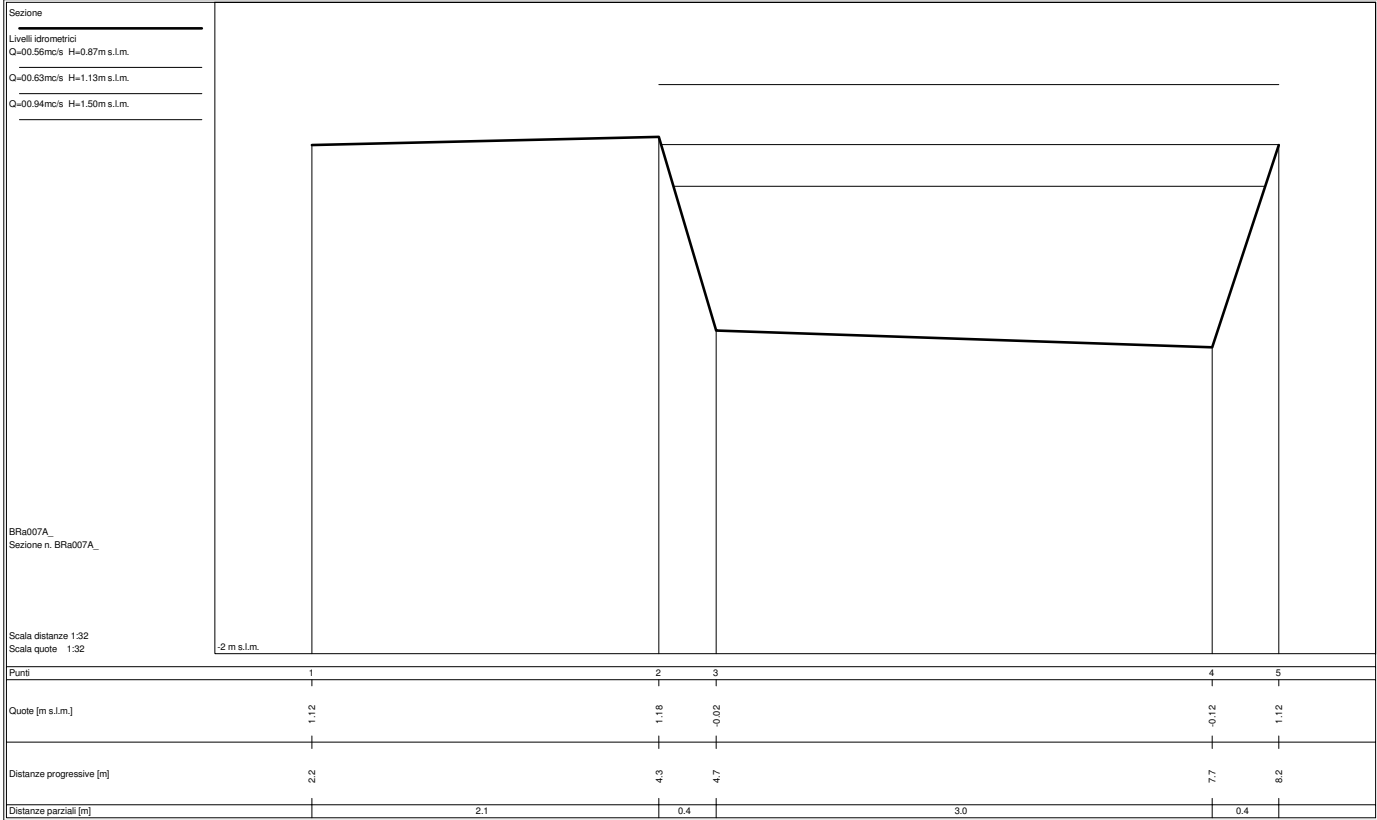

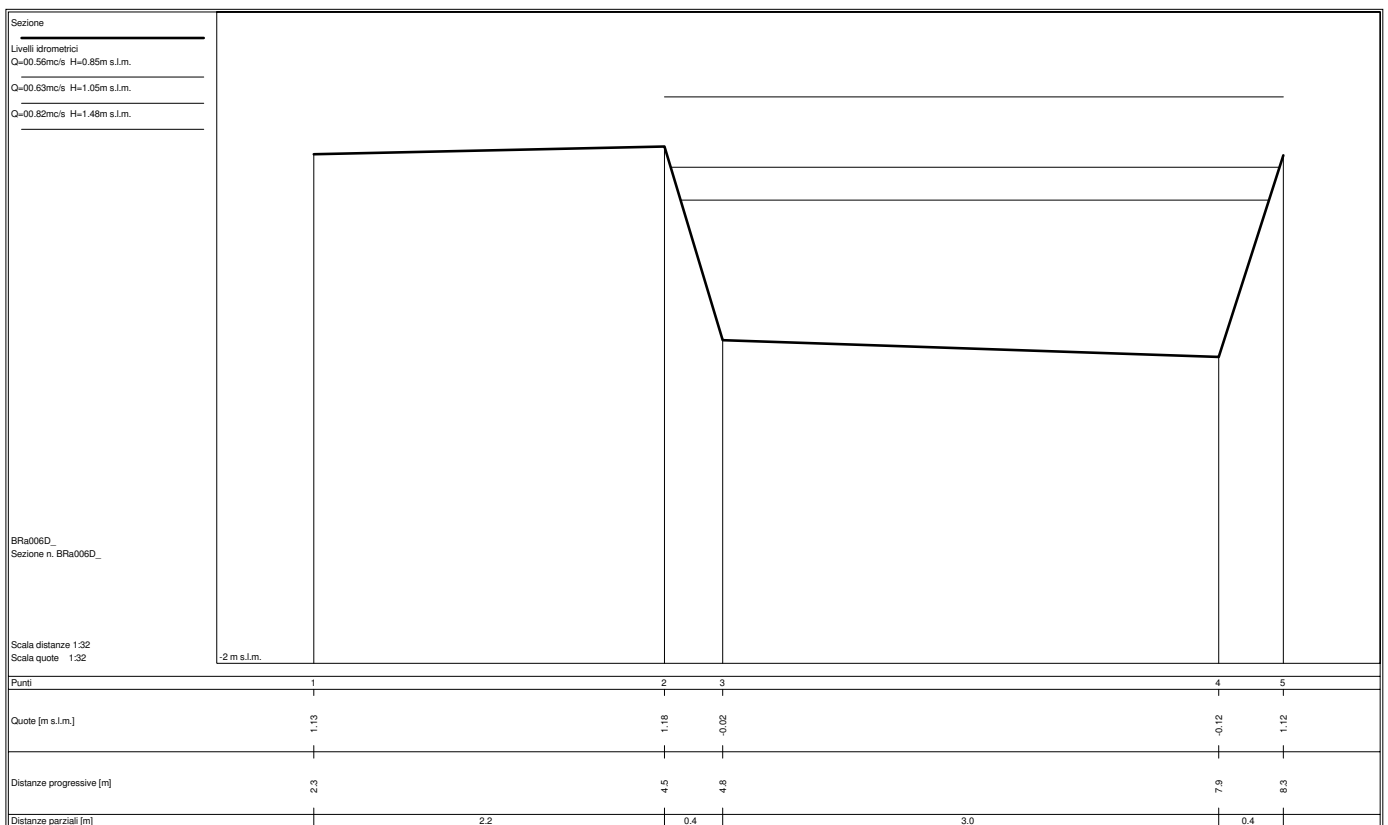
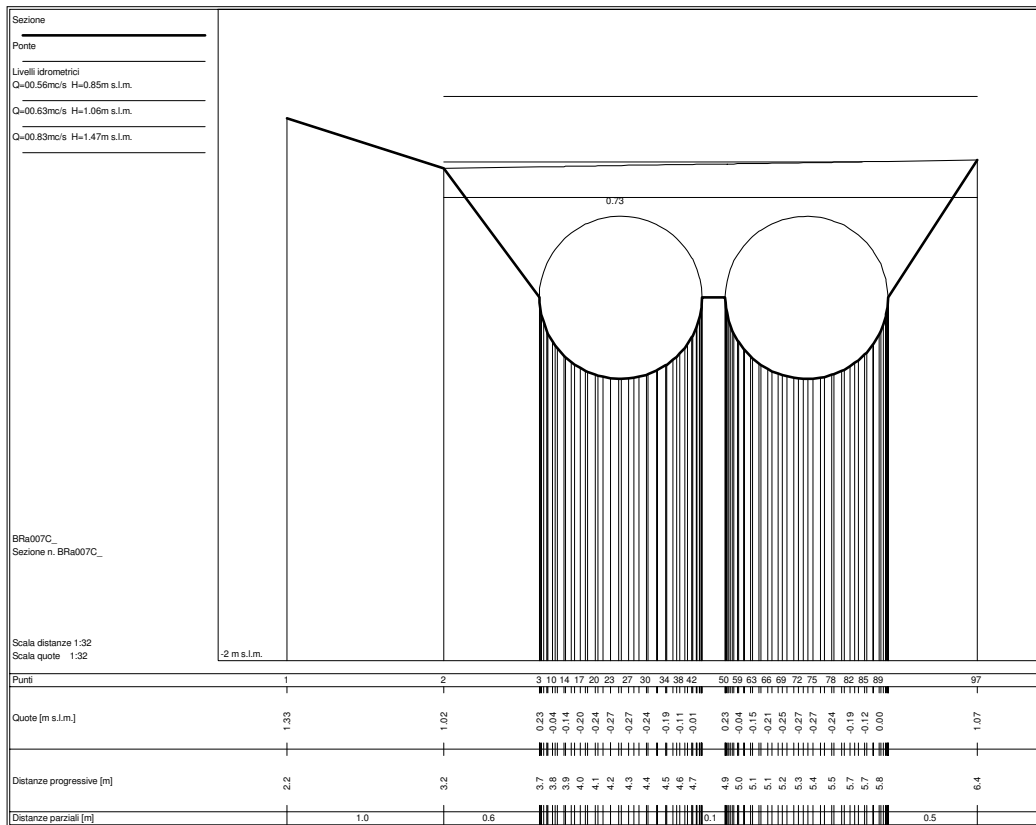

Sezione  
 Livelli idrometrici  
 Q=00.56mc/s H=0.85m s.l.m.  
 Q=00.62mc/s H=1.05m s.l.m.  
 Q=00.80mc/s H=1.48m s.l.m.

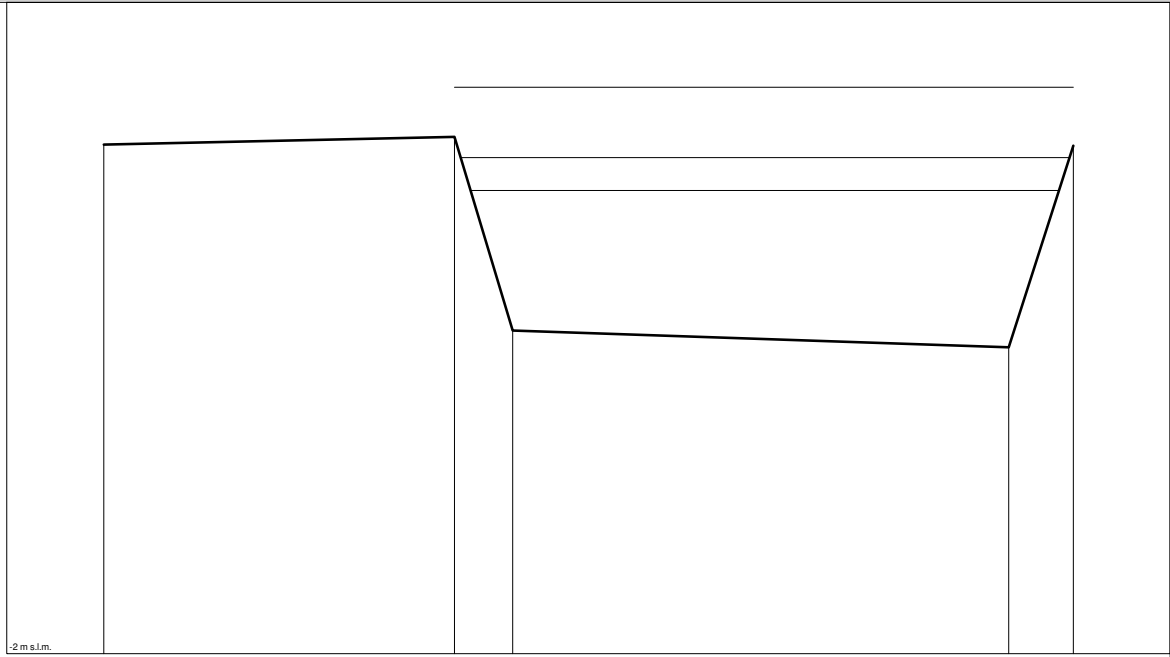

BRa006  
 Sezione n. BRa006

Scala distanze 1:32  
 Scala quote 1:32

|                          |      |      |       |       |      |
|--------------------------|------|------|-------|-------|------|
| Punti                    | 1    | 2    | 3     | 4     | 5    |
| Quote [m s.l.m.]         | 1.13 | 1.18 | -0.02 | -0.12 | 1.12 |
| Distanze progressive [m] | 2.3  | 4.5  | 4.8   | 7.9   | 8.3  |
| Distanze parziali [m]    |      | 2.2  | 0.4   | 3.0   | 0.4  |

Sezione  
 Livelli idrometrici  
 Q=00.56mc/s H=0.85m s.l.m.  
 Q=00.61mc/s H=1.05m s.l.m.  
 Q=00.83mc/s H=1.48m s.l.m.

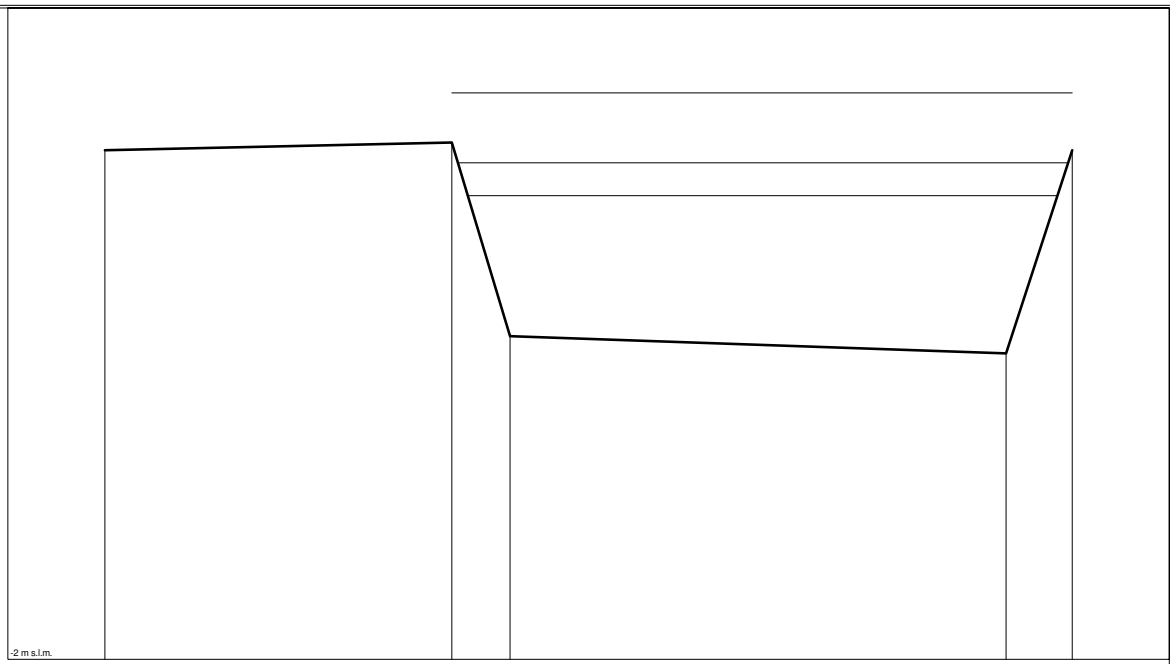

BRa005  
 Sezione n. BRa005

Scala distanze 1:32  
 Scala quote 1:32

|                          |      |      |       |       |      |
|--------------------------|------|------|-------|-------|------|
| Punti                    | 1    | 2    | 3     | 4     | 5    |
| Quote [m s.l.m.]         | 1.13 | 1.18 | -0.02 | -0.12 | 1.13 |
| Distanze progressive [m] | 2.3  | 4.4  | 4.8   | 7.8   | 8.2  |
| Distanze parziali [m]    |      | 2.1  | 0.4   | 3.0   | 0.4  |



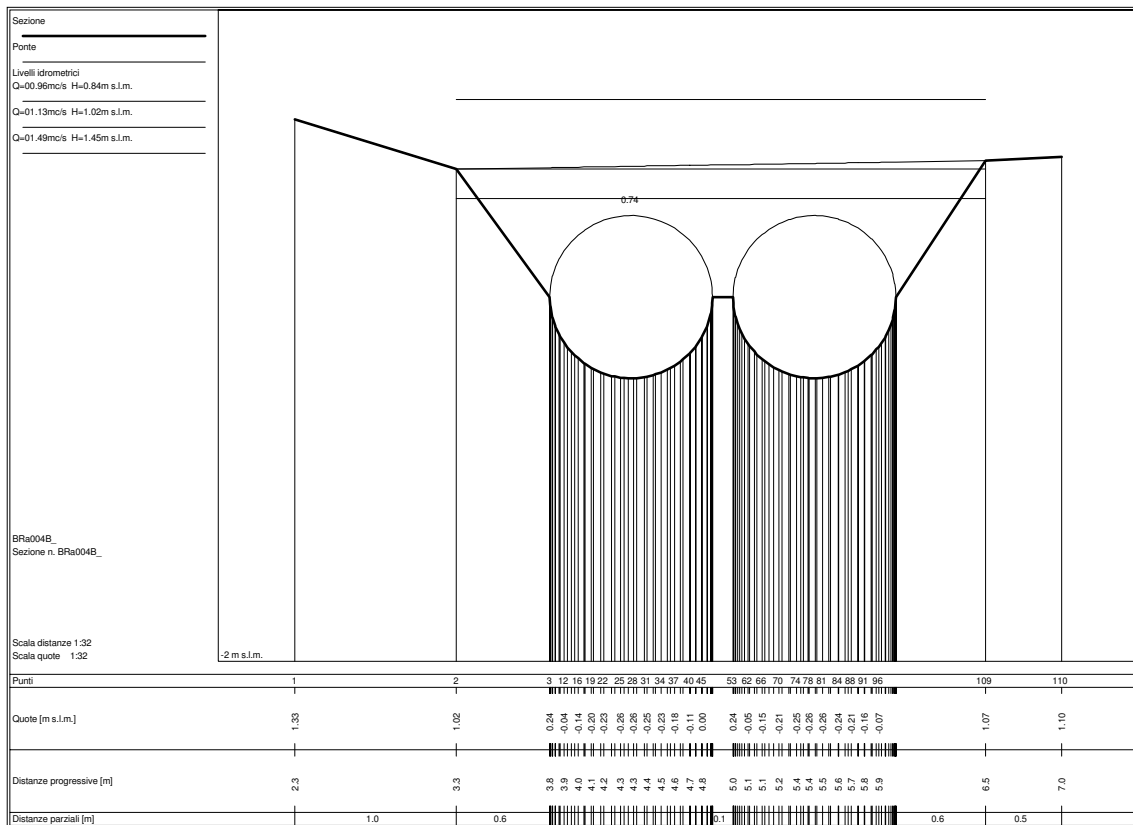
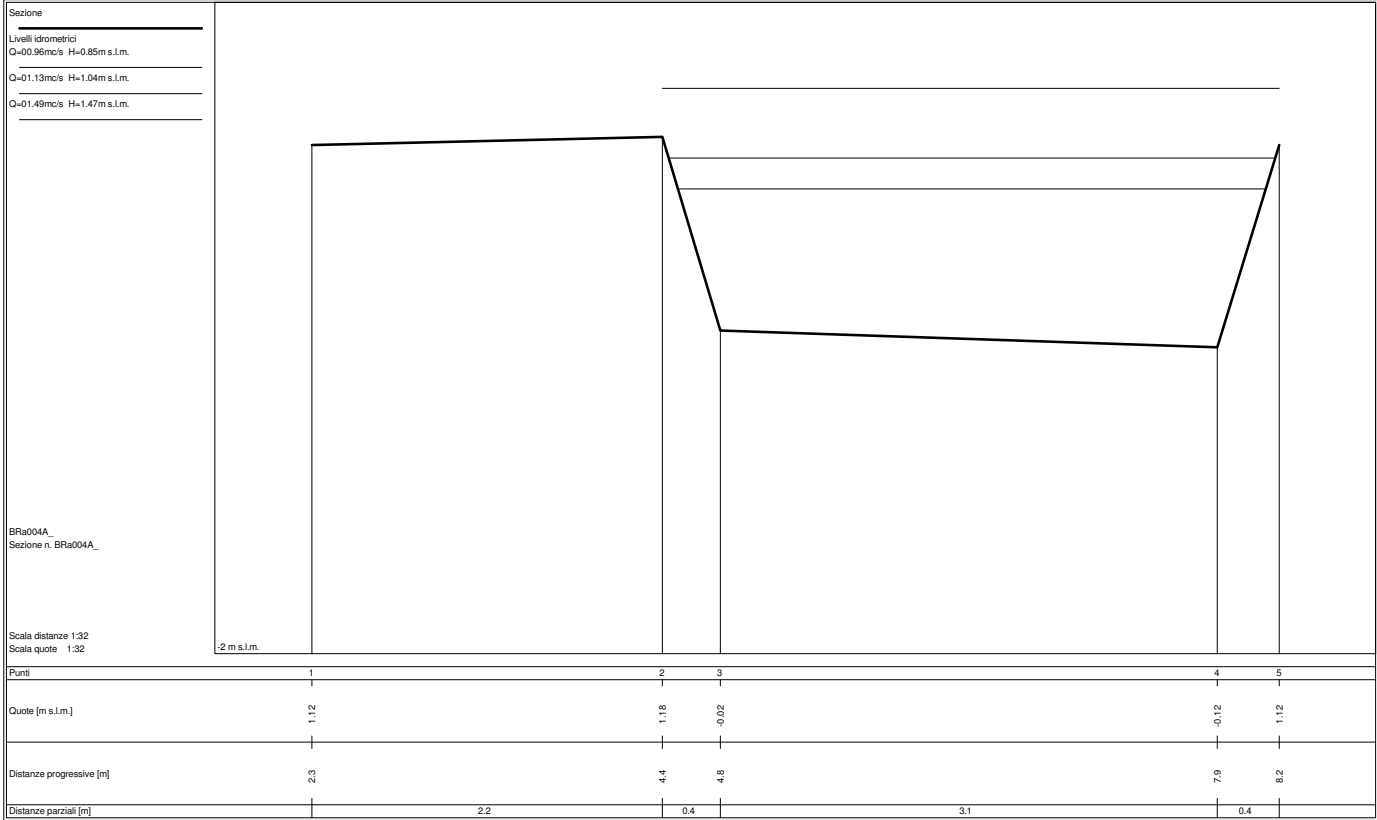

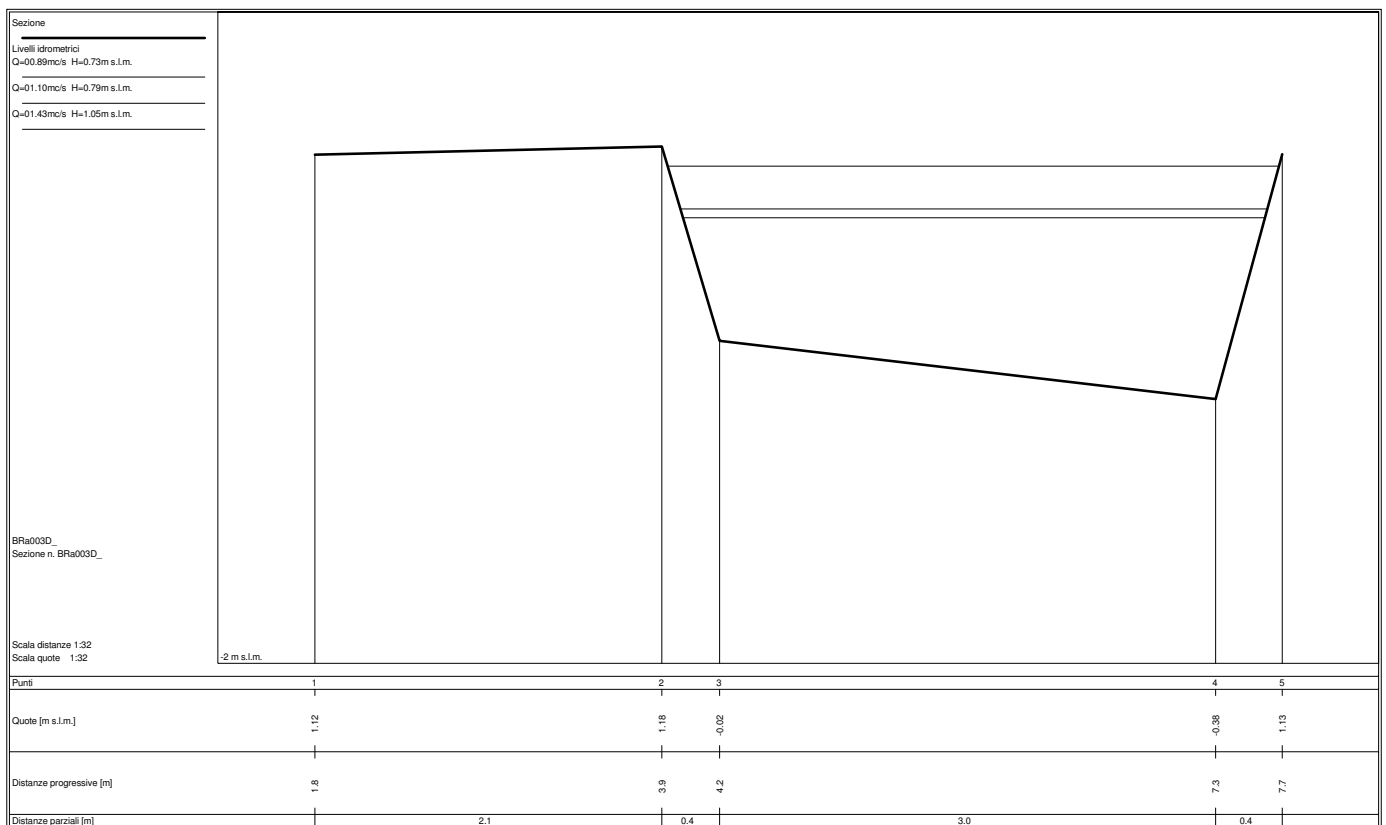
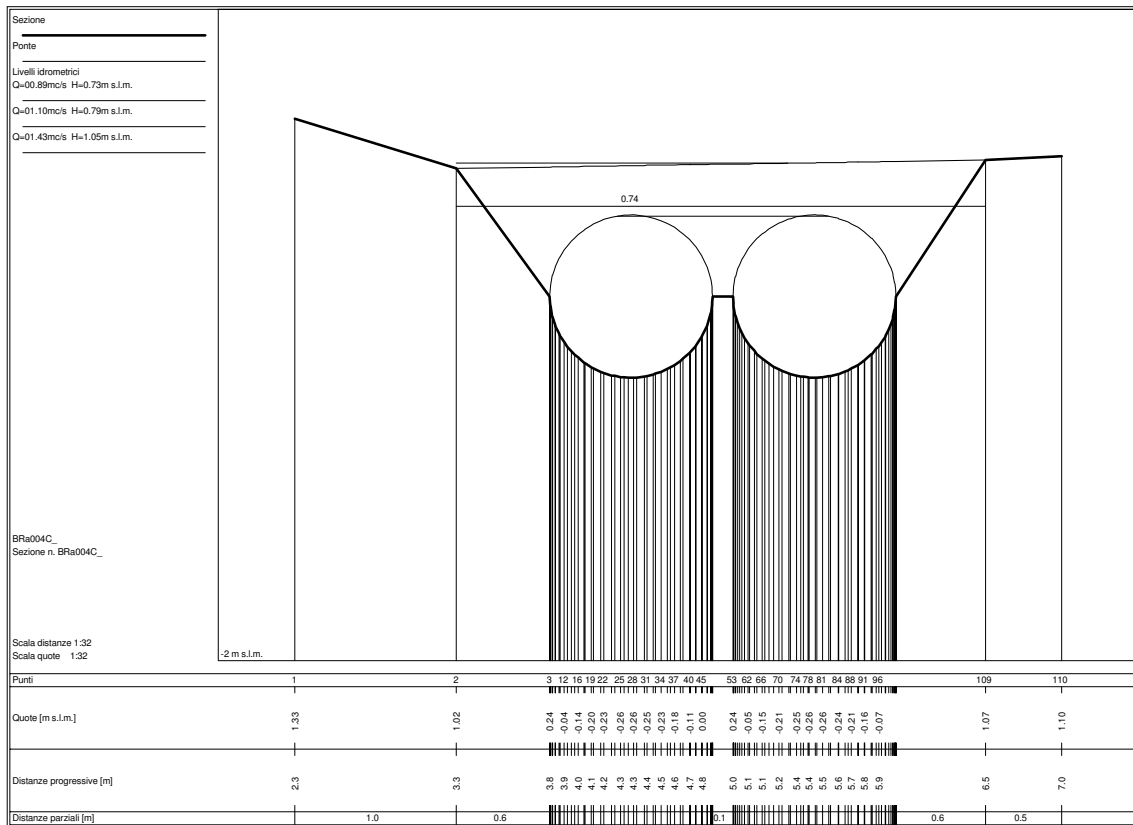

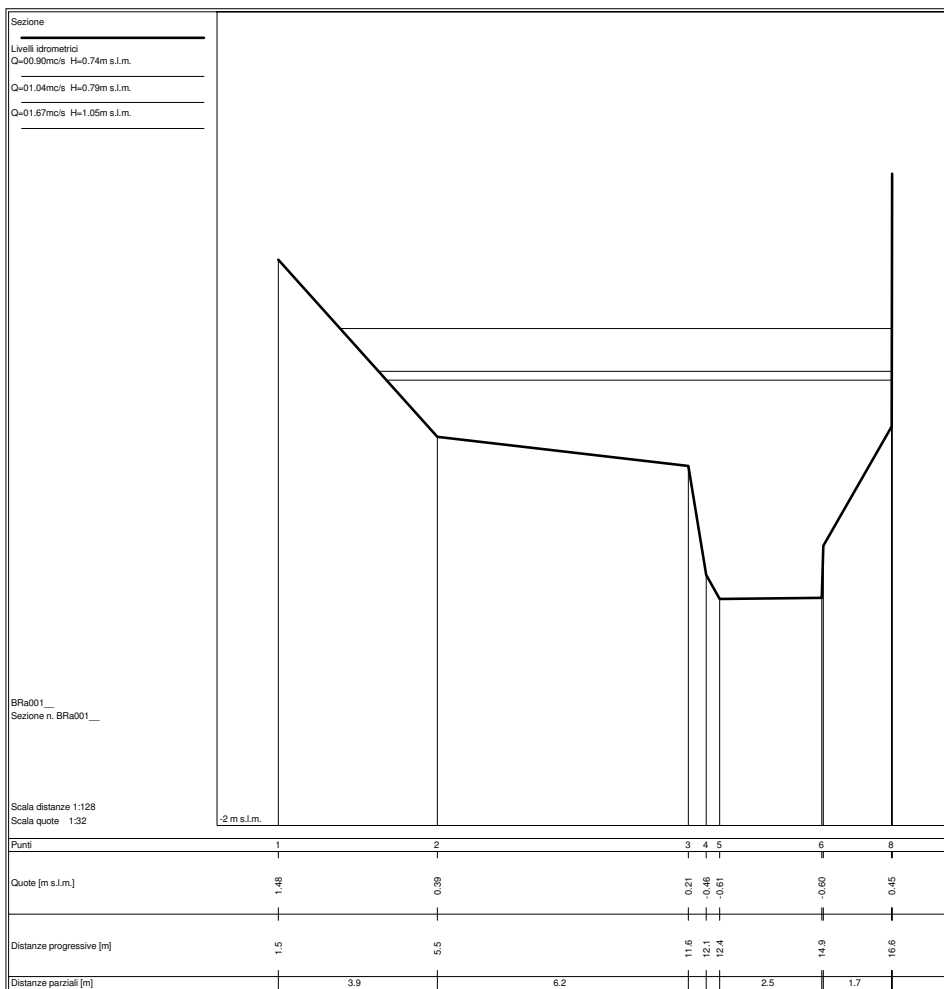
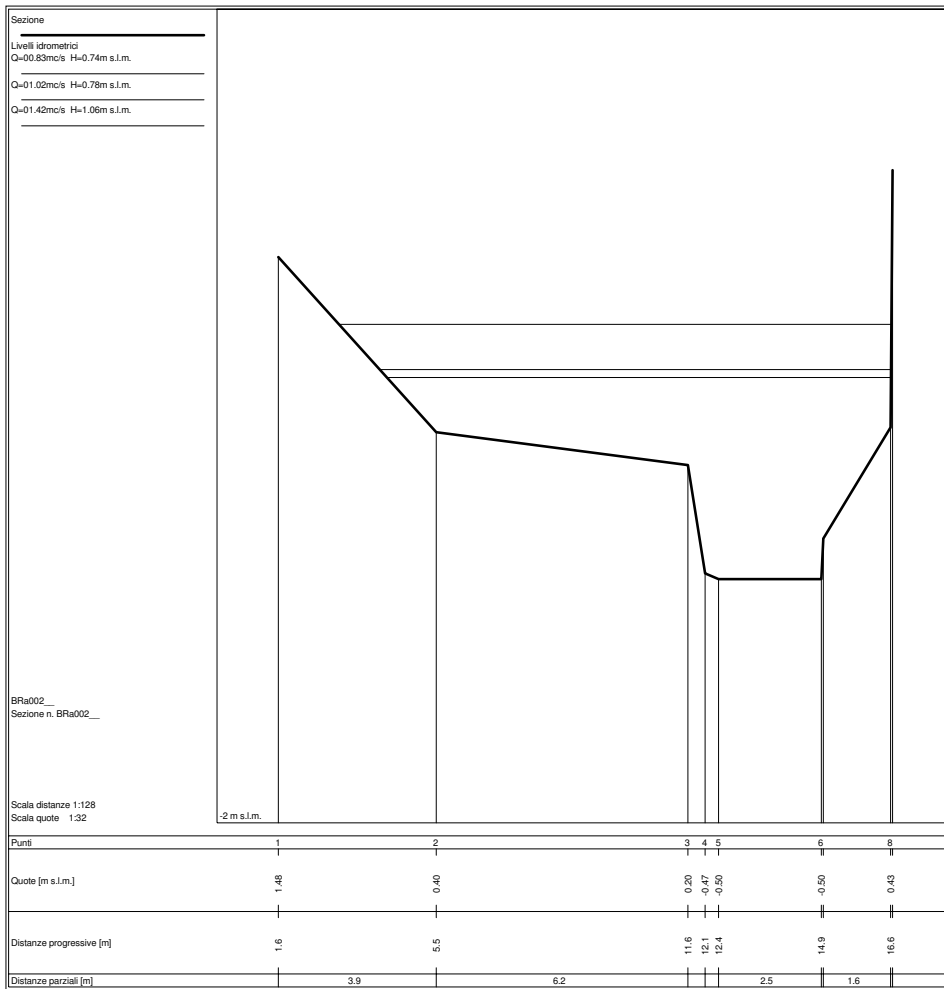

Sezione  
 Livelli idrometrici  
 Q=00.82mc/s H=0.74m s.l.m.  
 Q=01.16mc/s H=0.80m s.l.m.  
 Q=01.87mc/s H=1.06m s.l.m.

BRb005  
 Sezione n. BRb005

Scala distanze 1:256  
 Scala quote 1:32

-3 m s.l.m.

|                          |      |      |       |       |       |
|--------------------------|------|------|-------|-------|-------|
| Punti                    | 1    | 2    | 4     | 5     | 6     |
| Quote [m s.l.m.]         | 0.59 | 0.13 | -0.84 | -1.42 | -0.43 |
| Distanze progressive [m] | 2.2  | 13.2 | 14.5  | 22.6  | 37.4  |
| Distanze parziali [m]    |      | 10.9 |       | 8.1   | 14.9  |

## **FOSSO BRUGIANO – RAMO B**

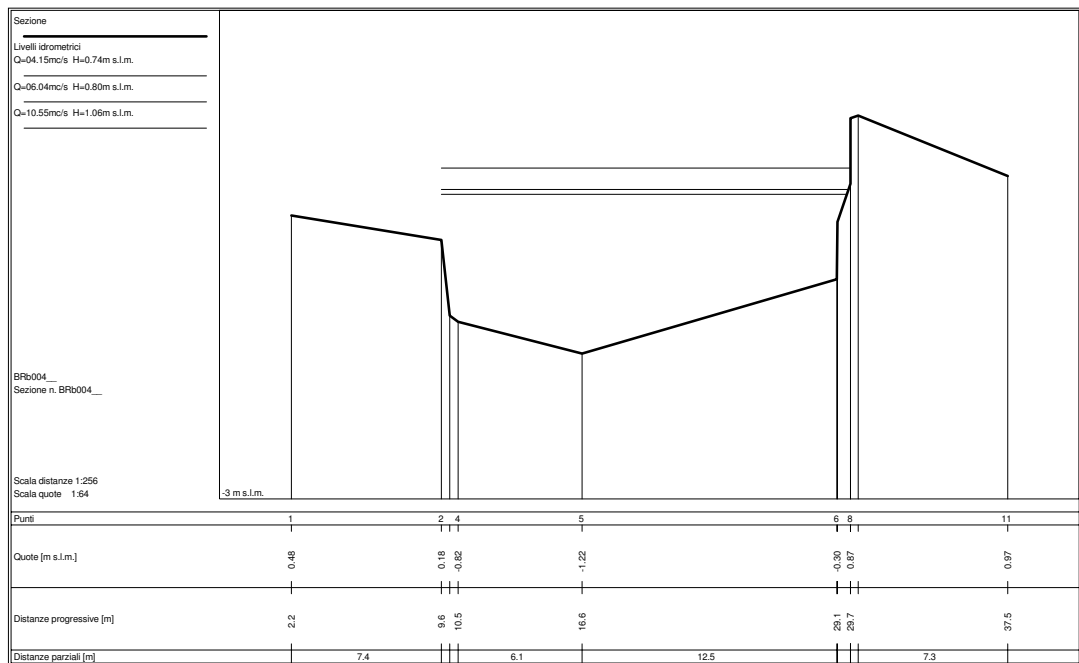
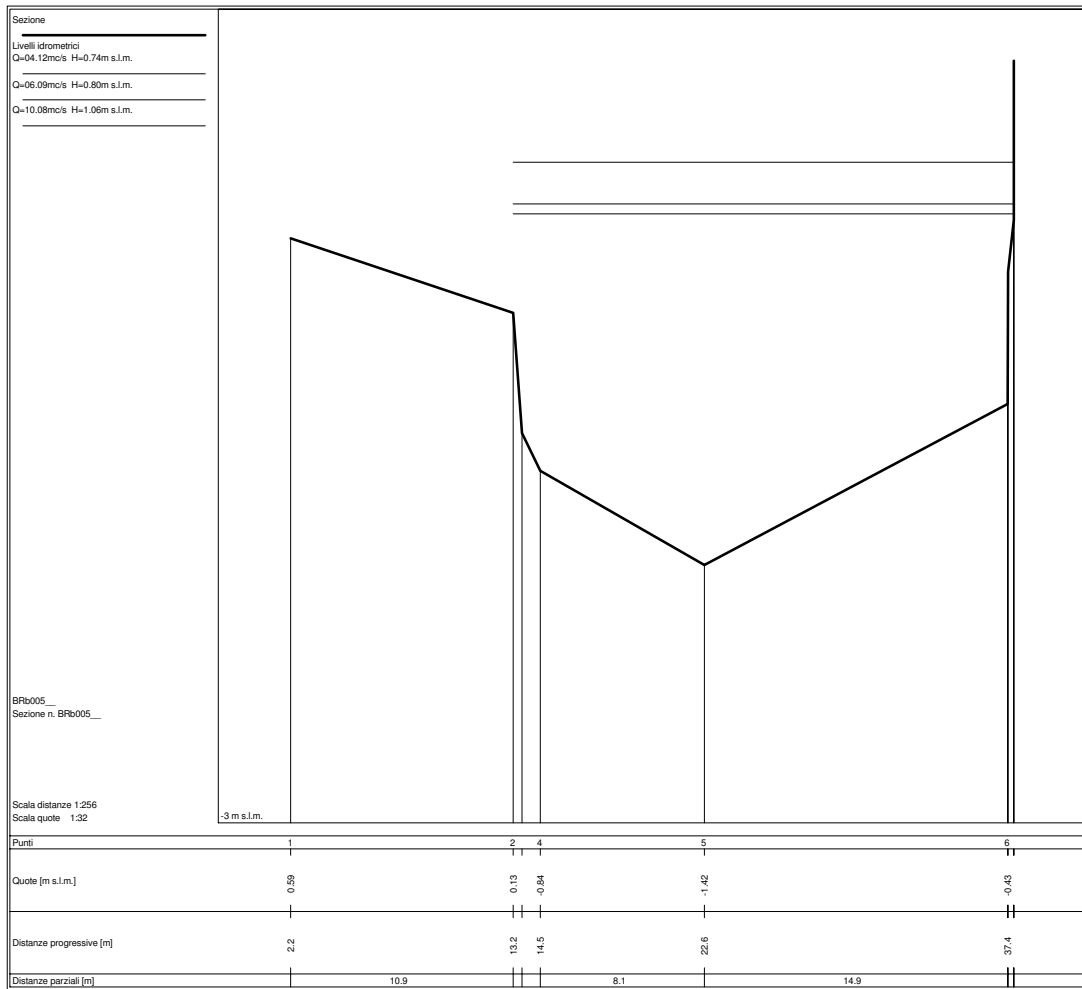

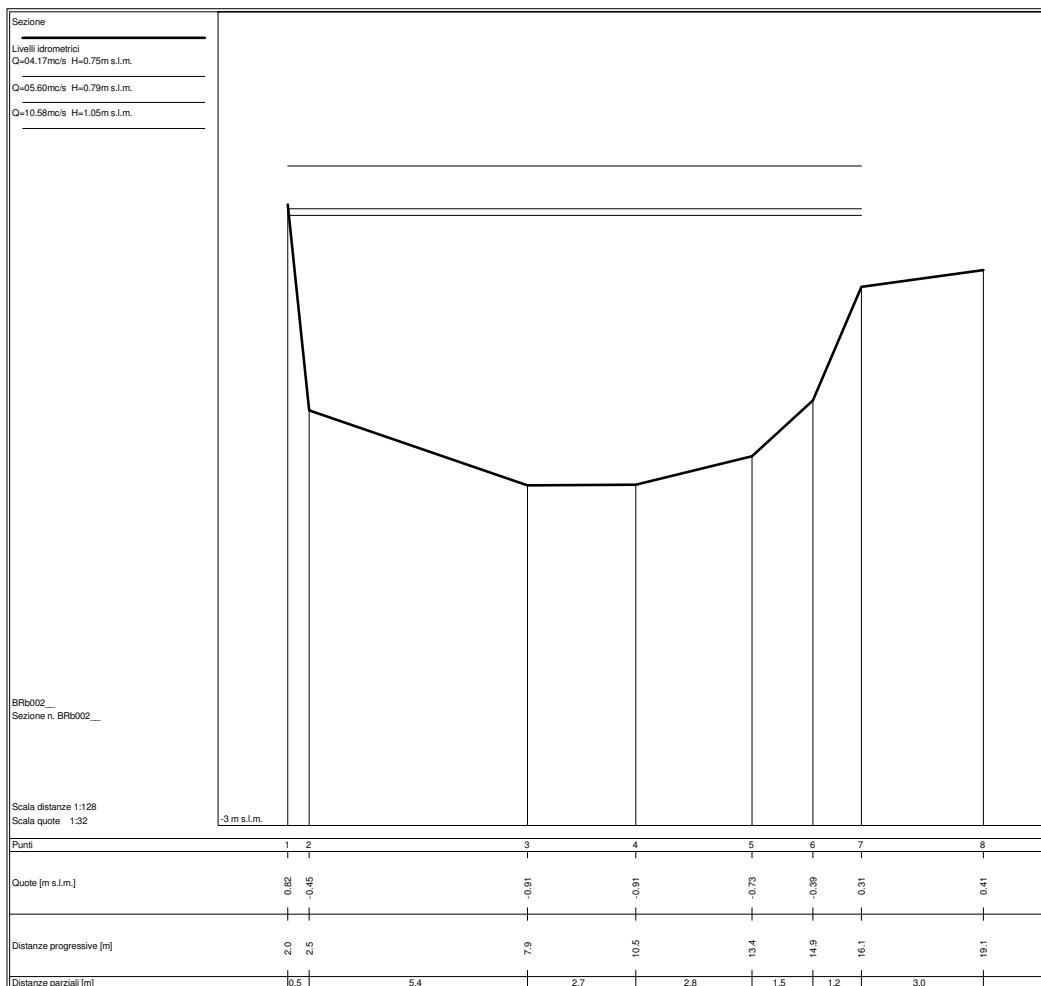
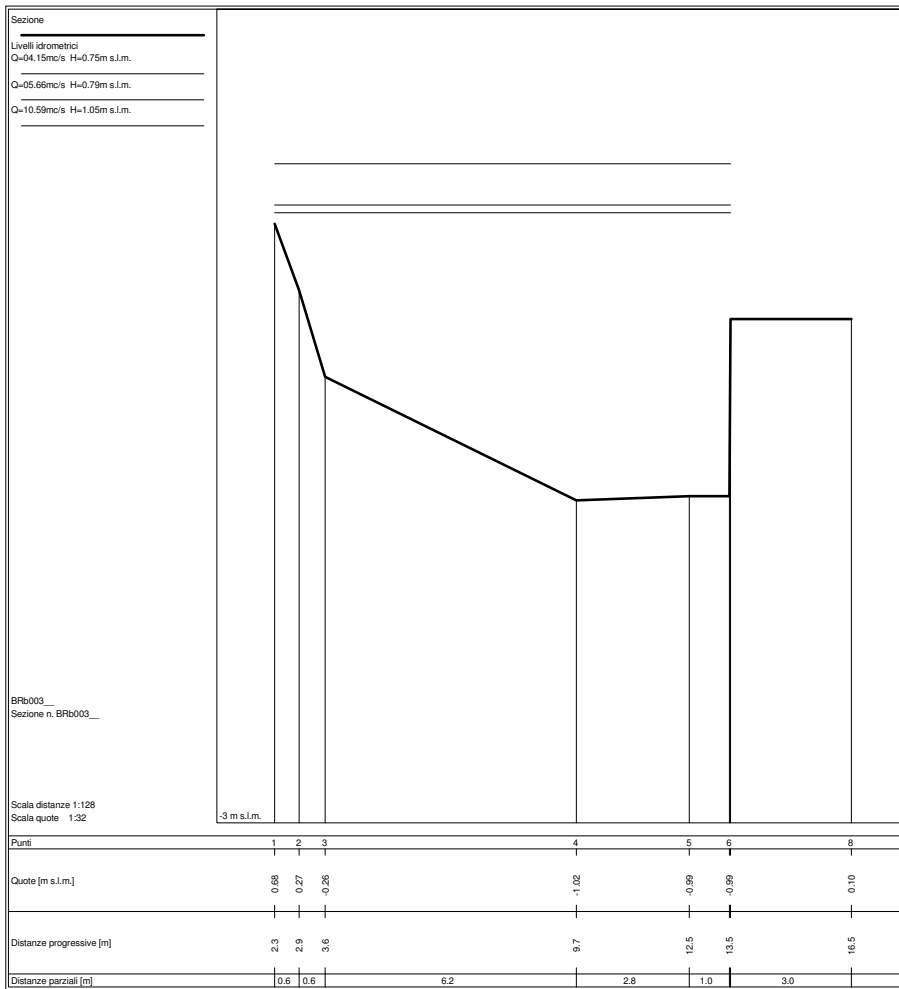

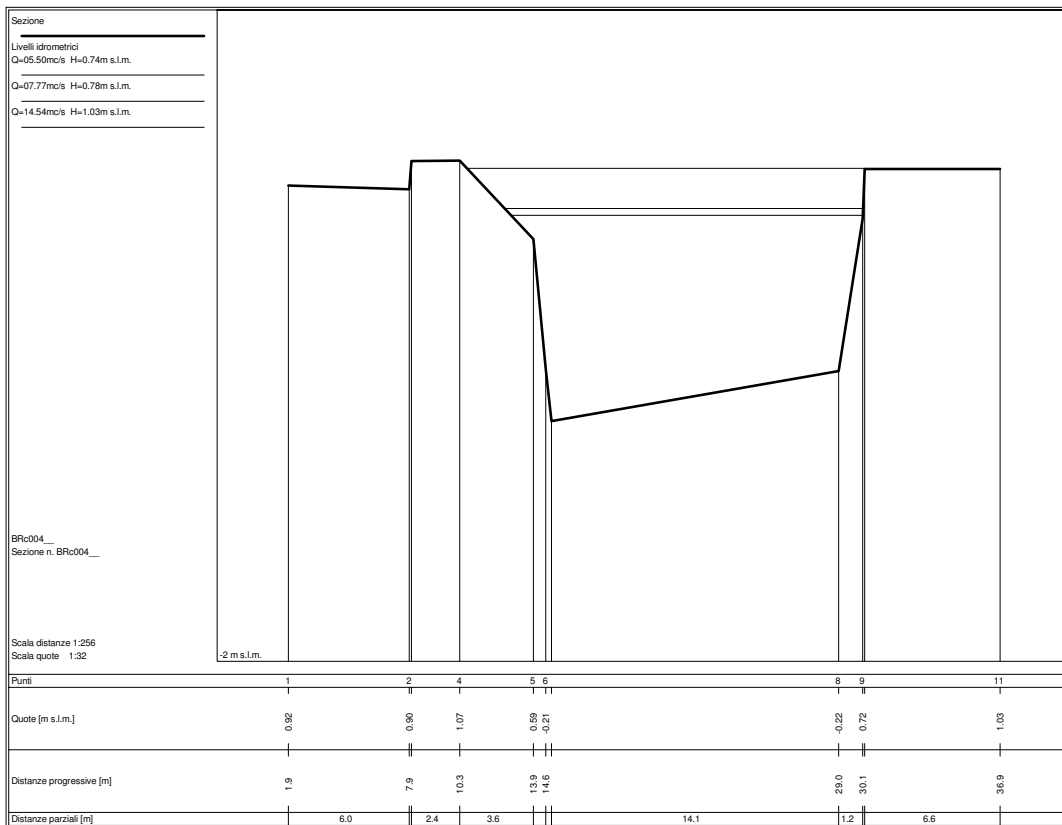
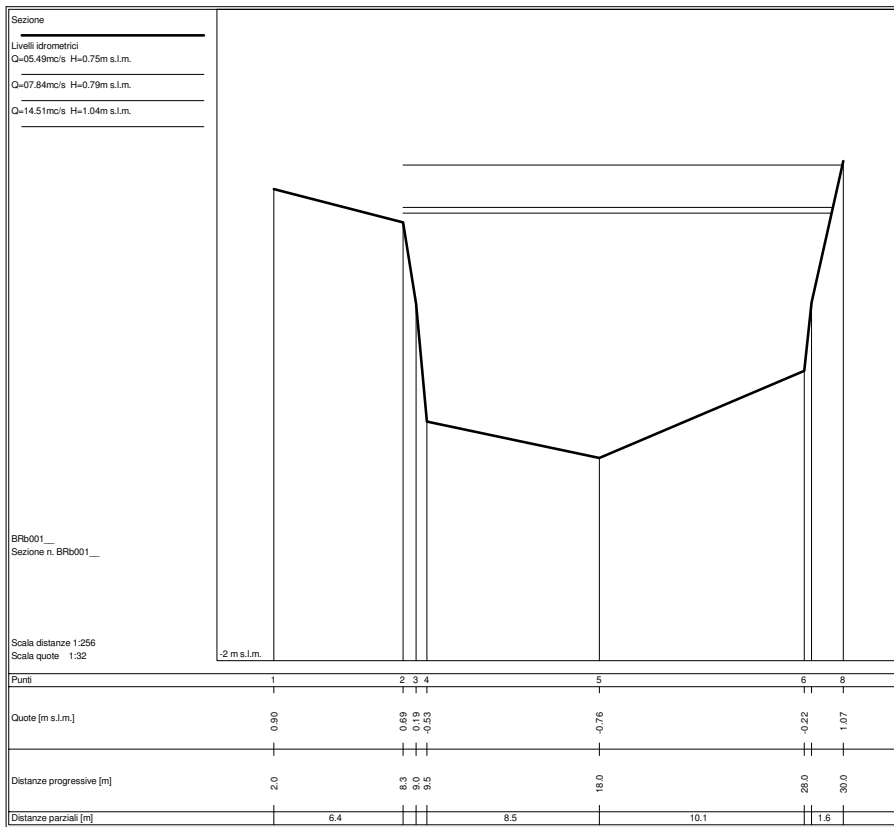



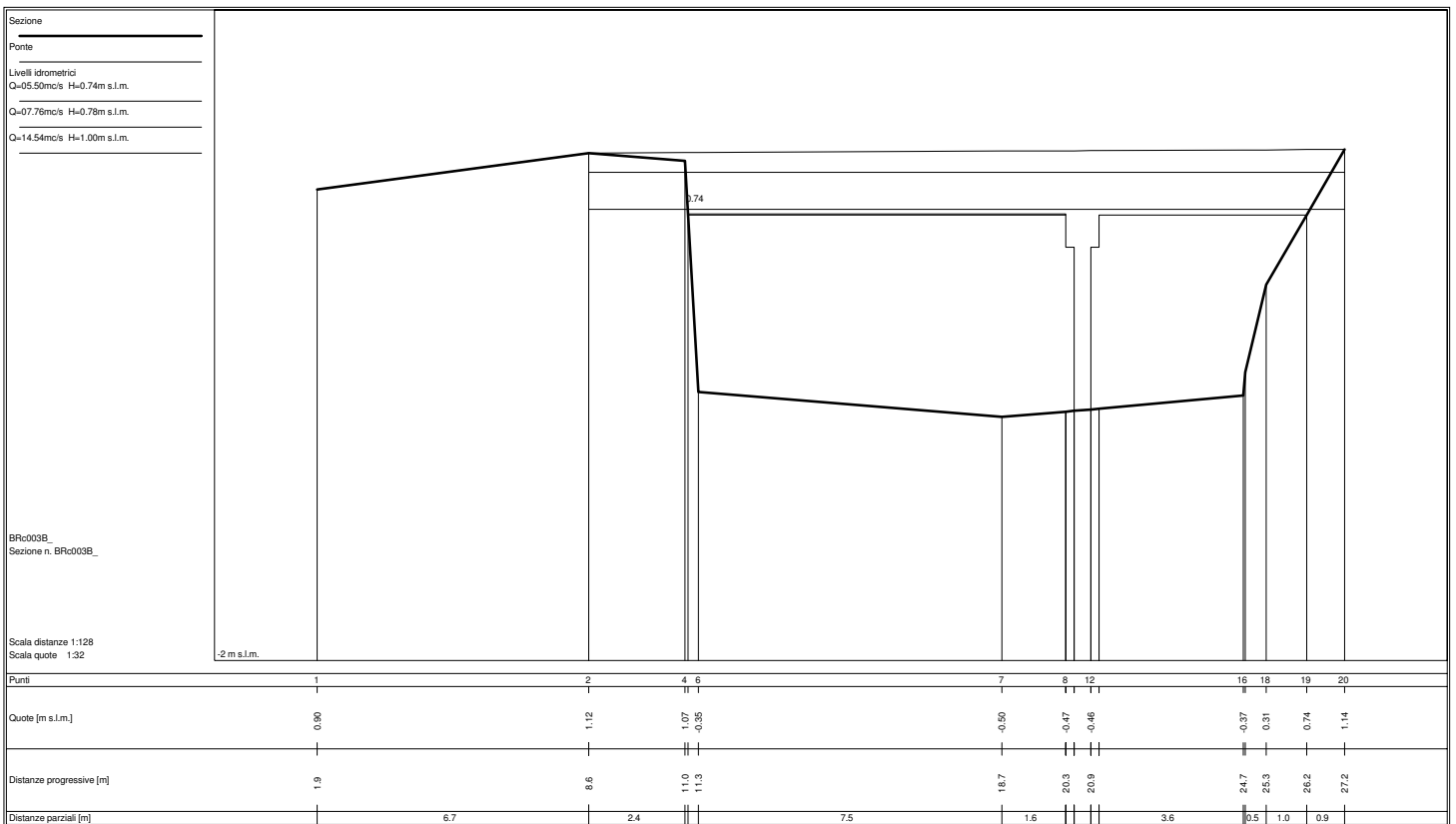
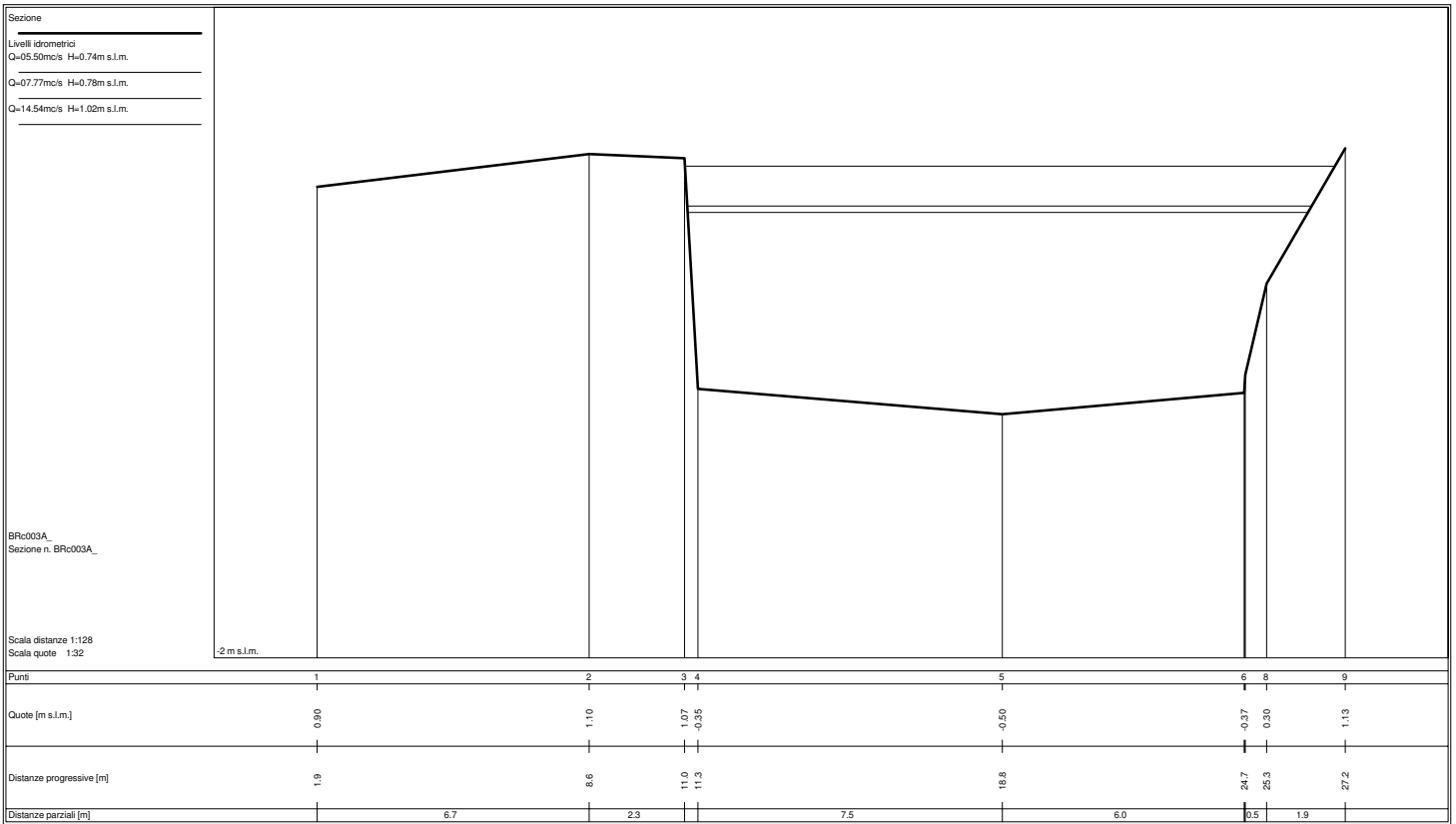

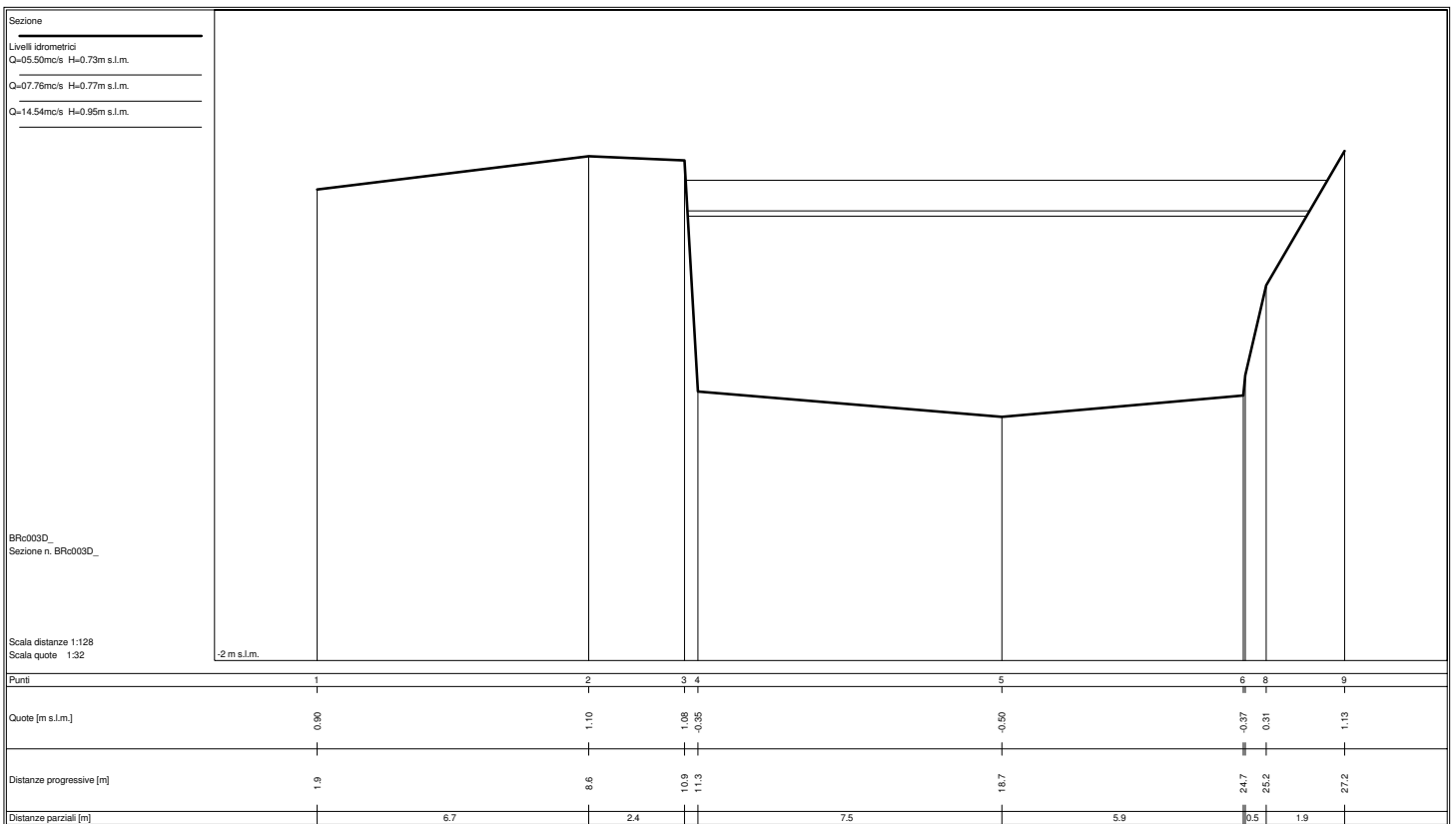
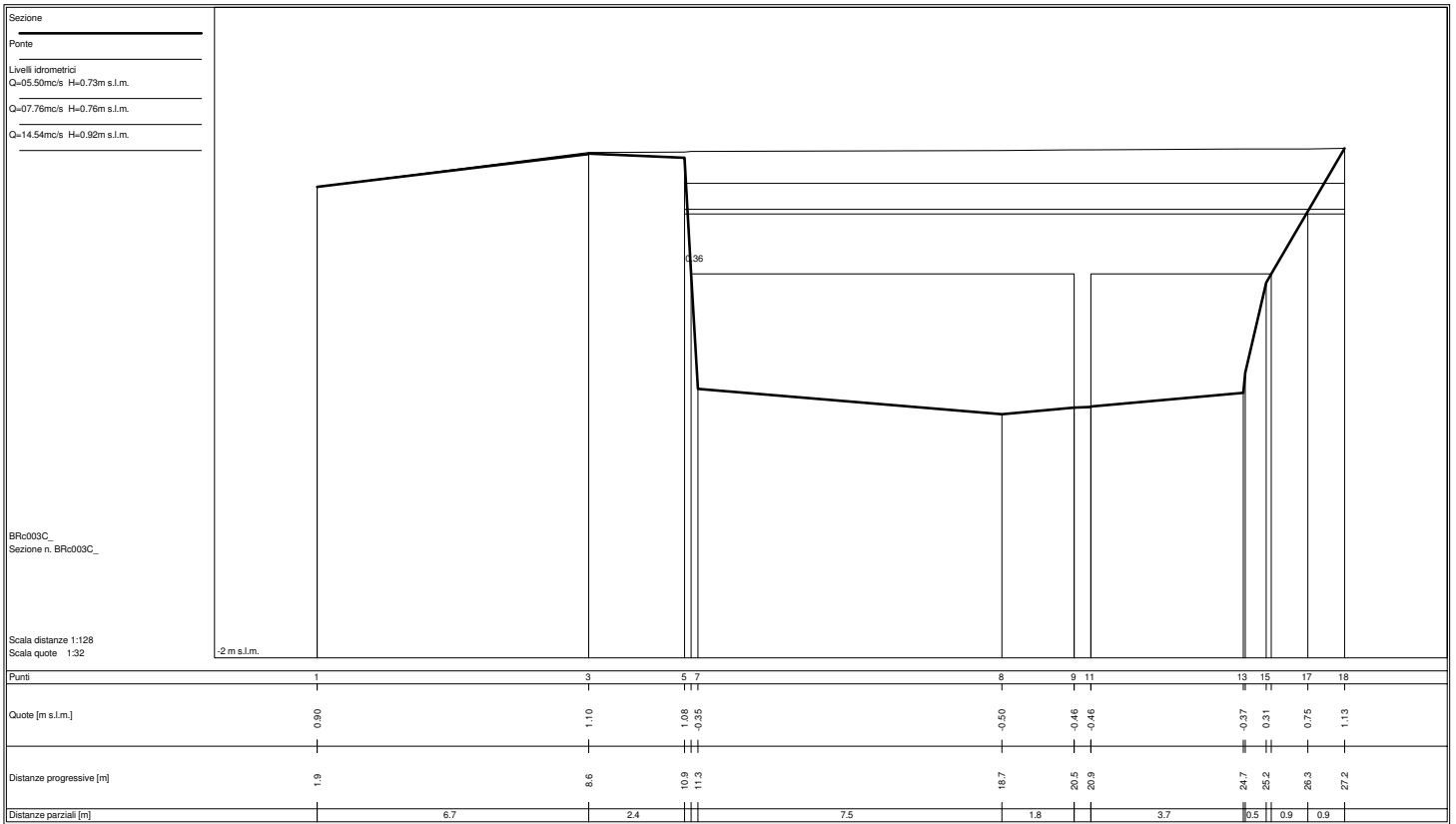

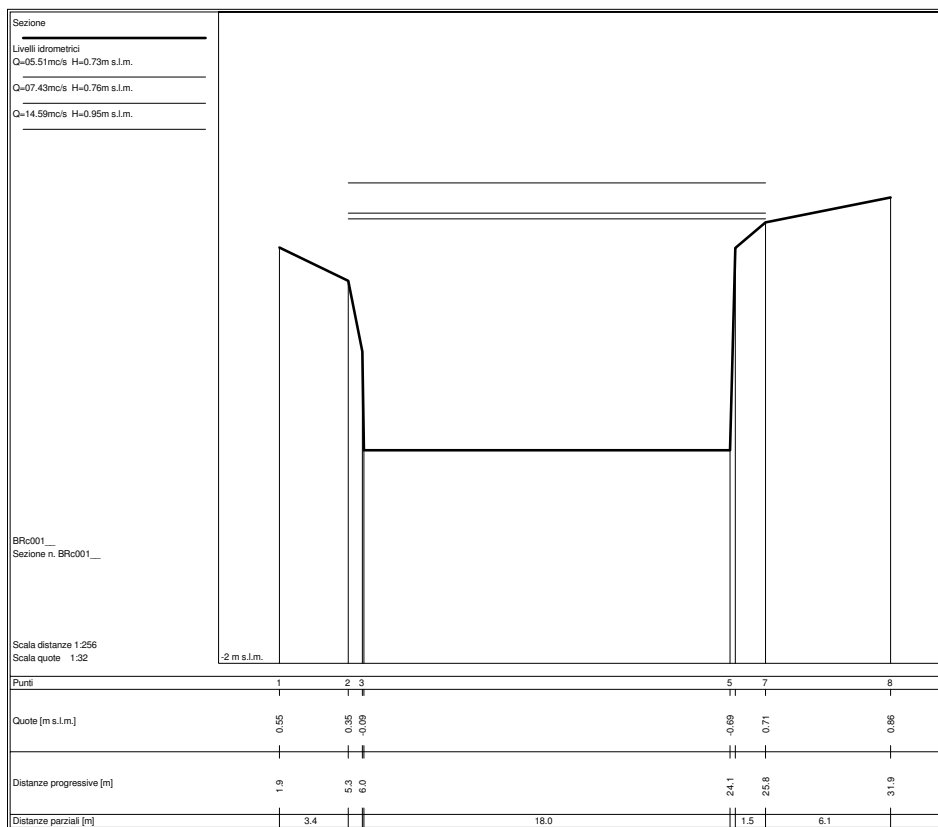
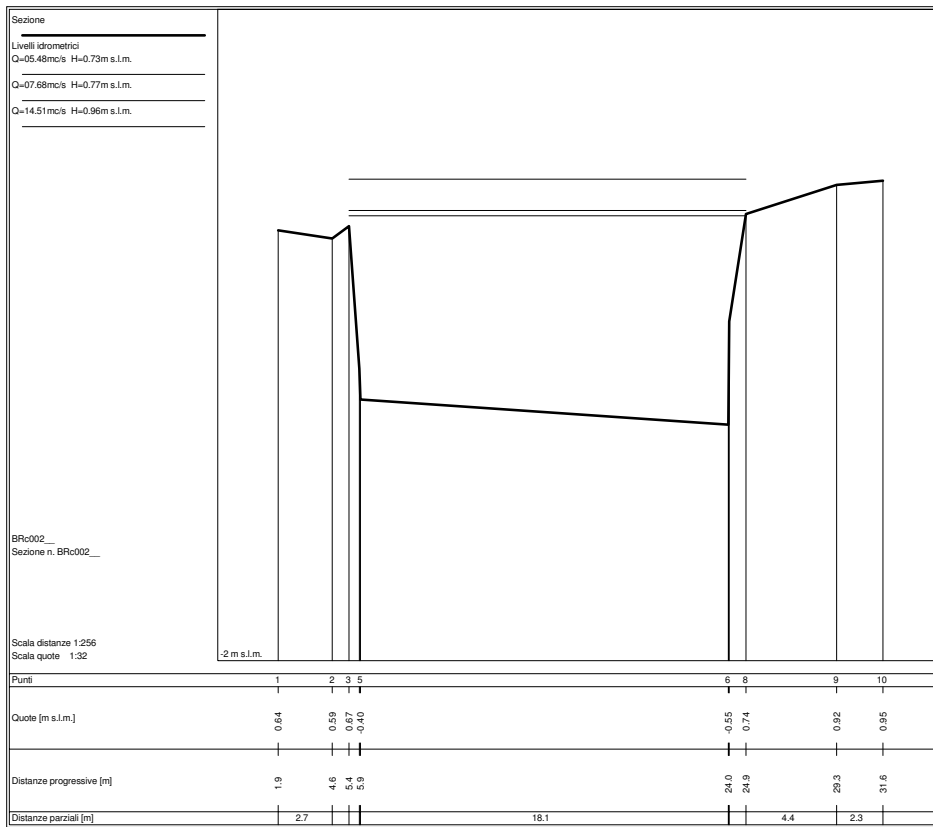

## **FOSSO BRUGIANO – RAMO C**

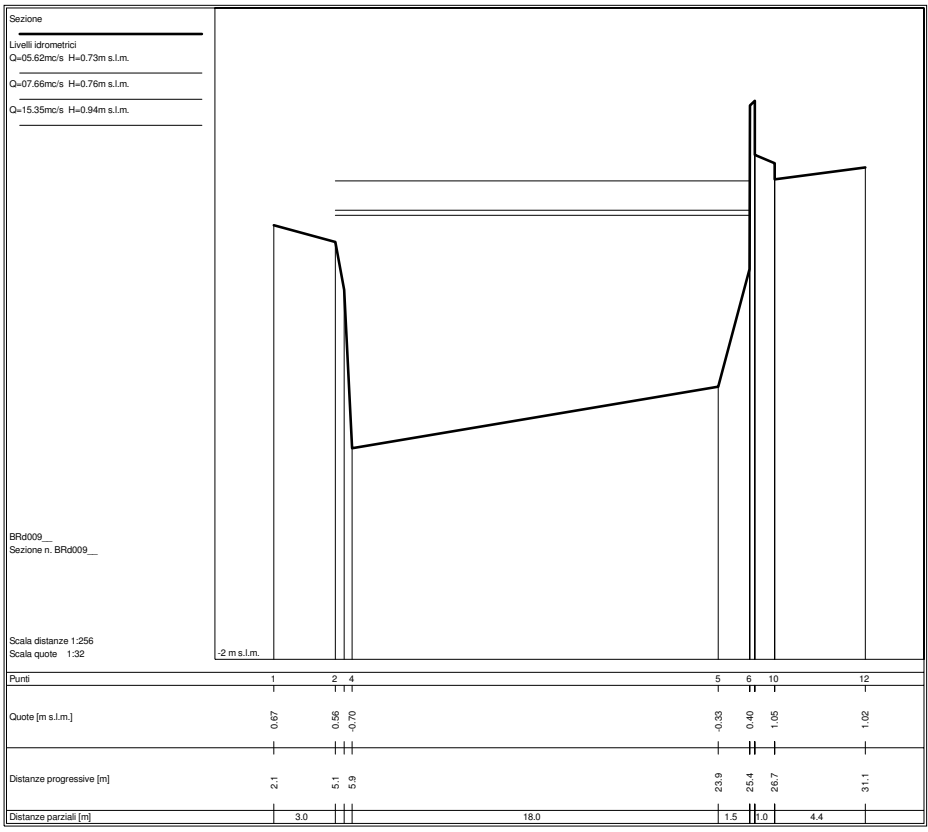
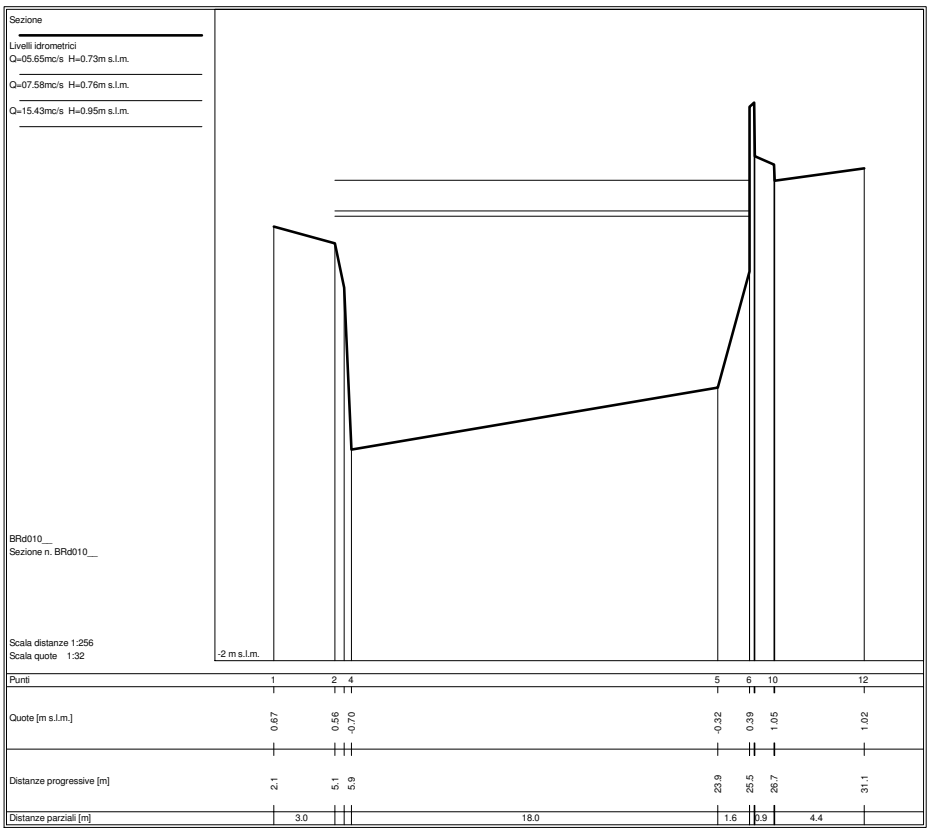

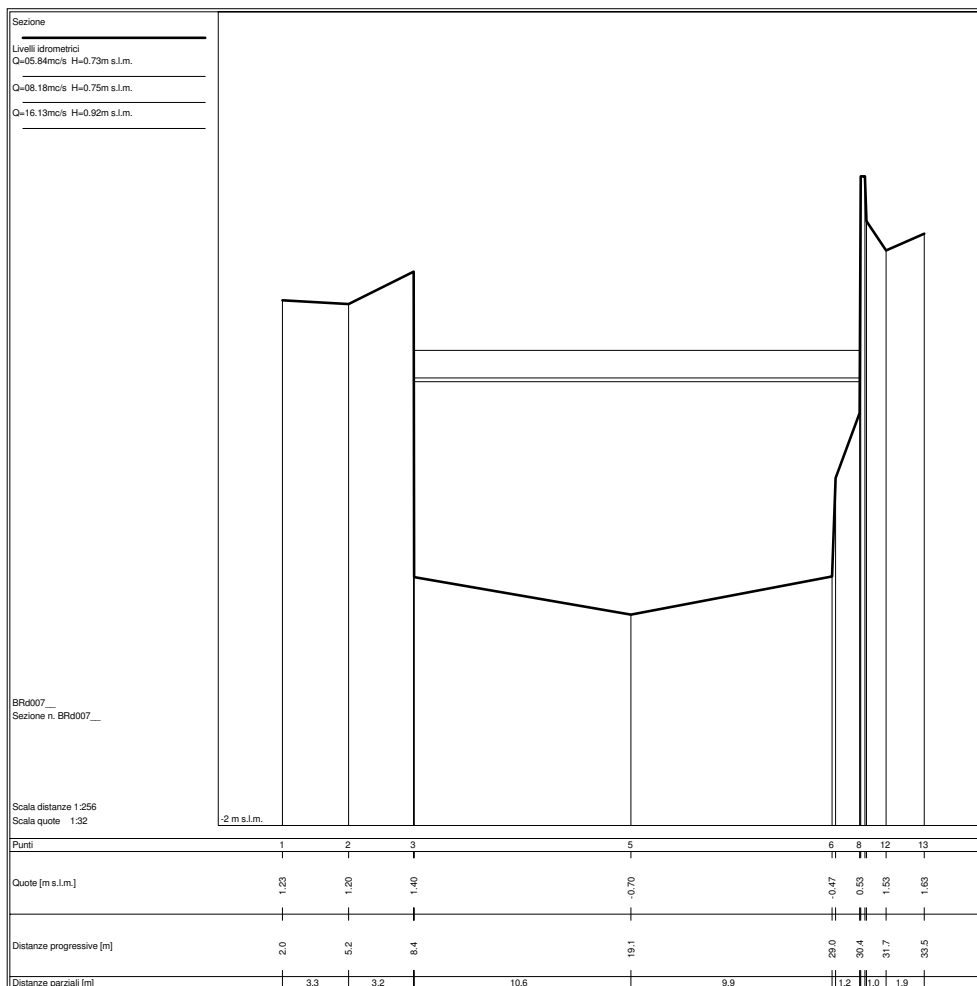
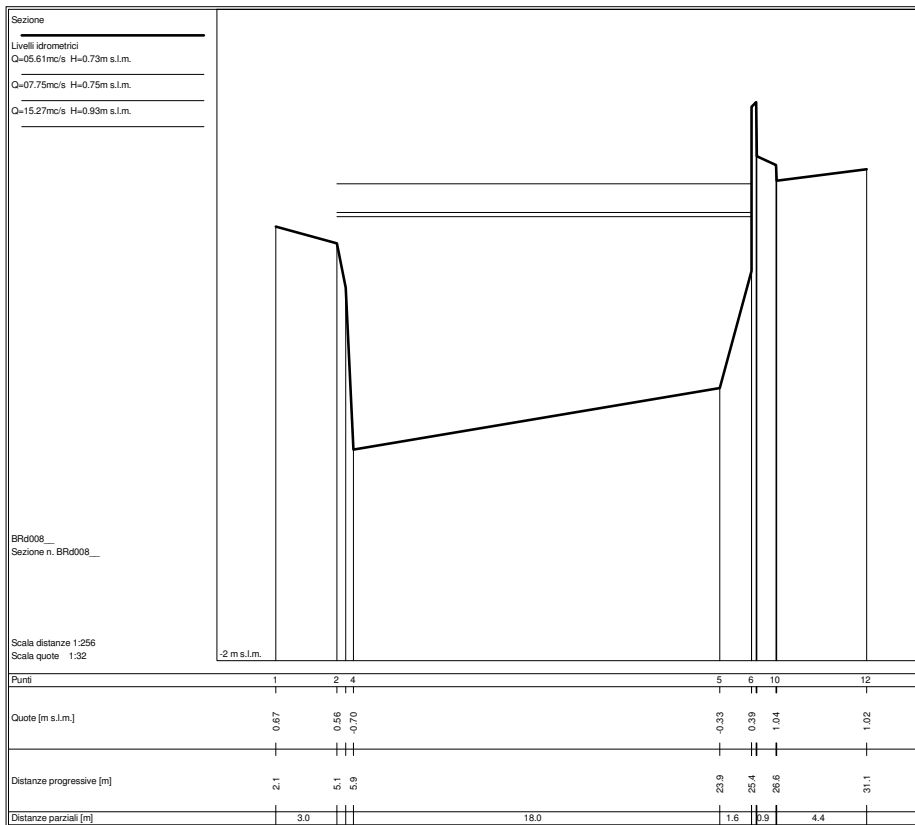

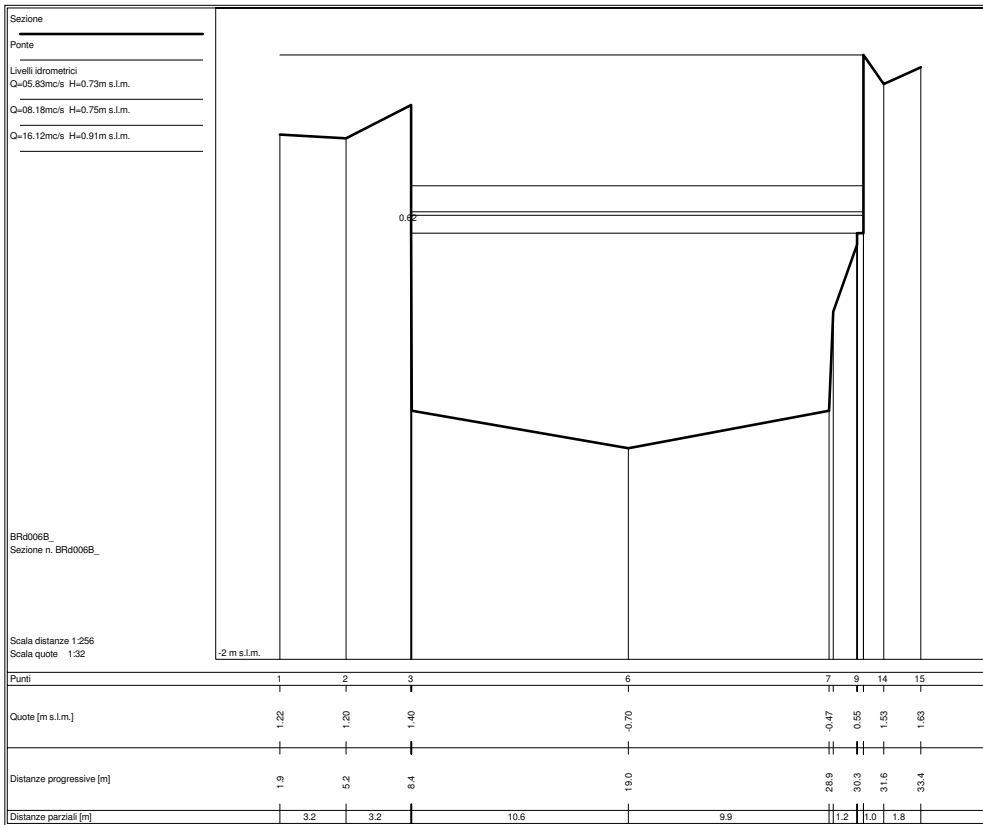
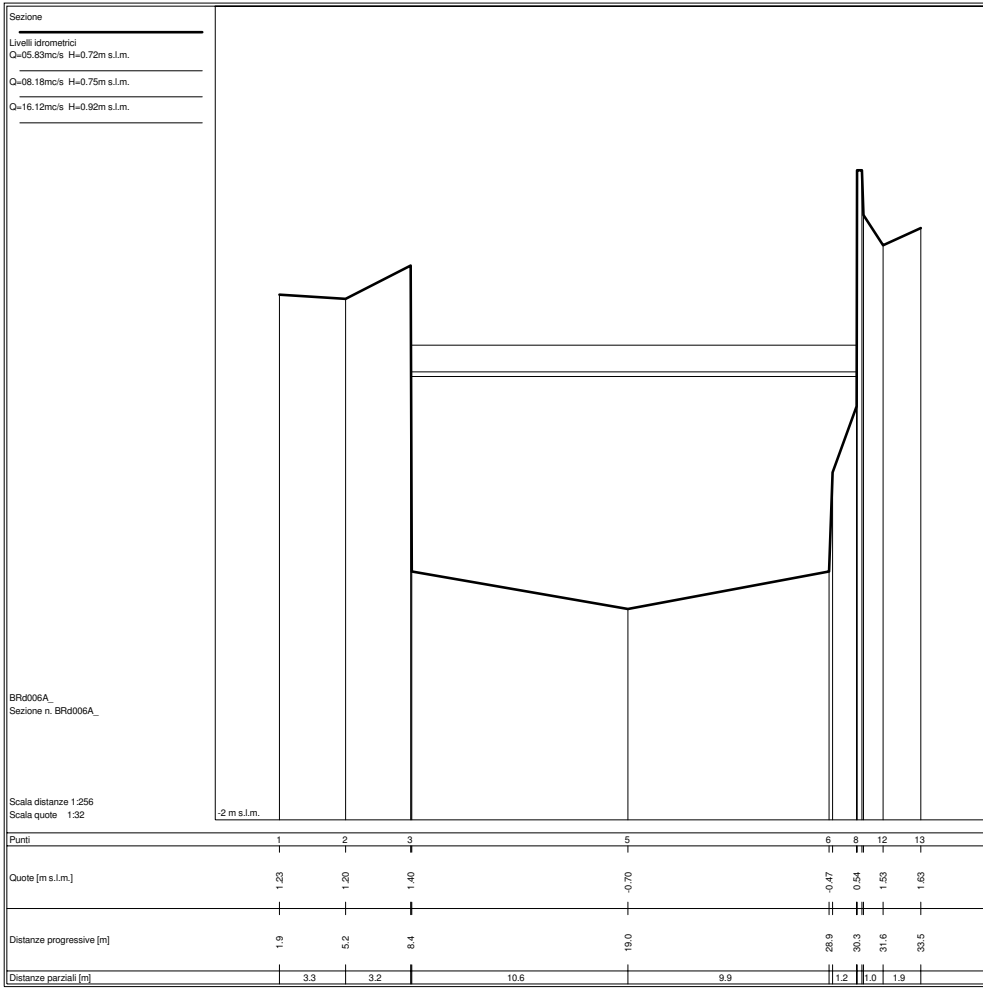

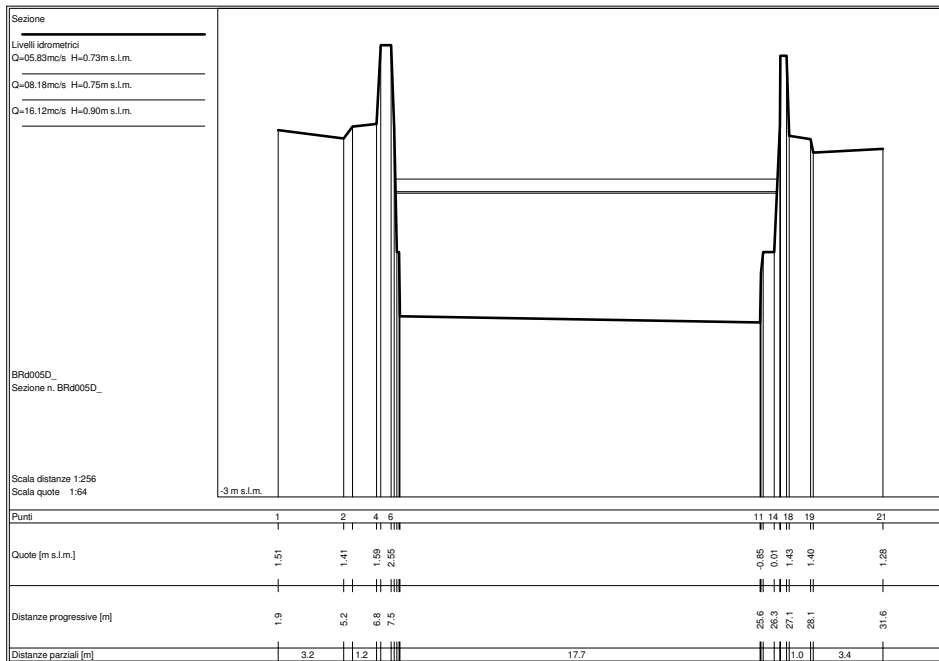
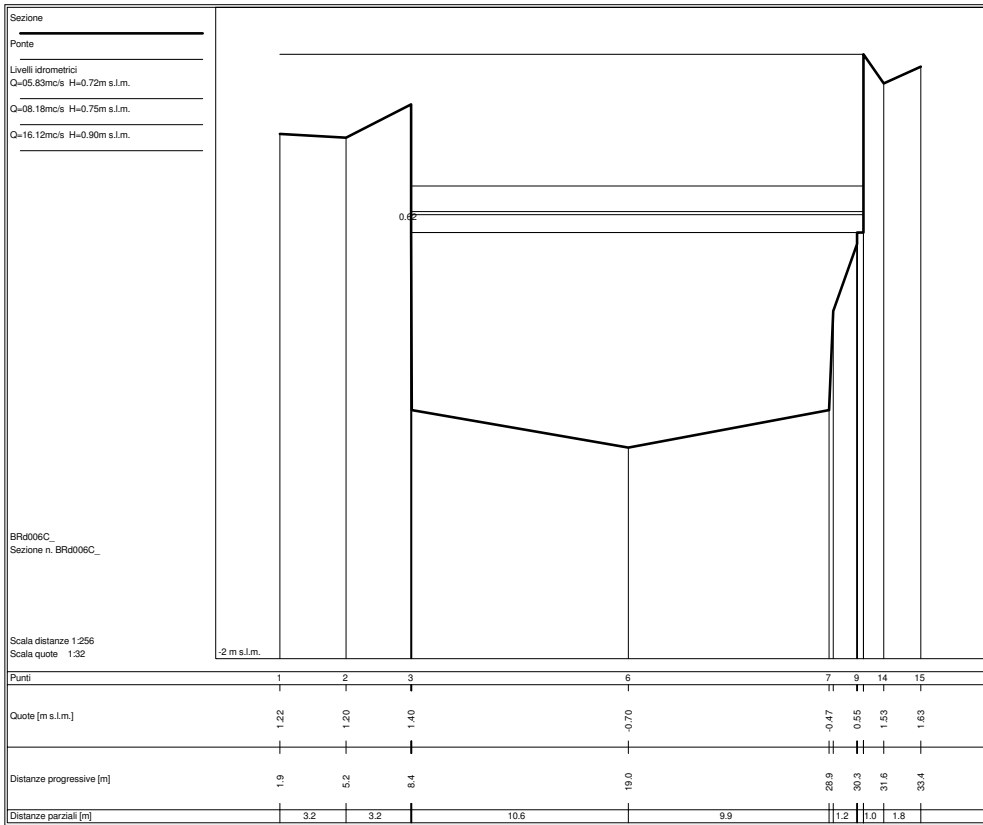



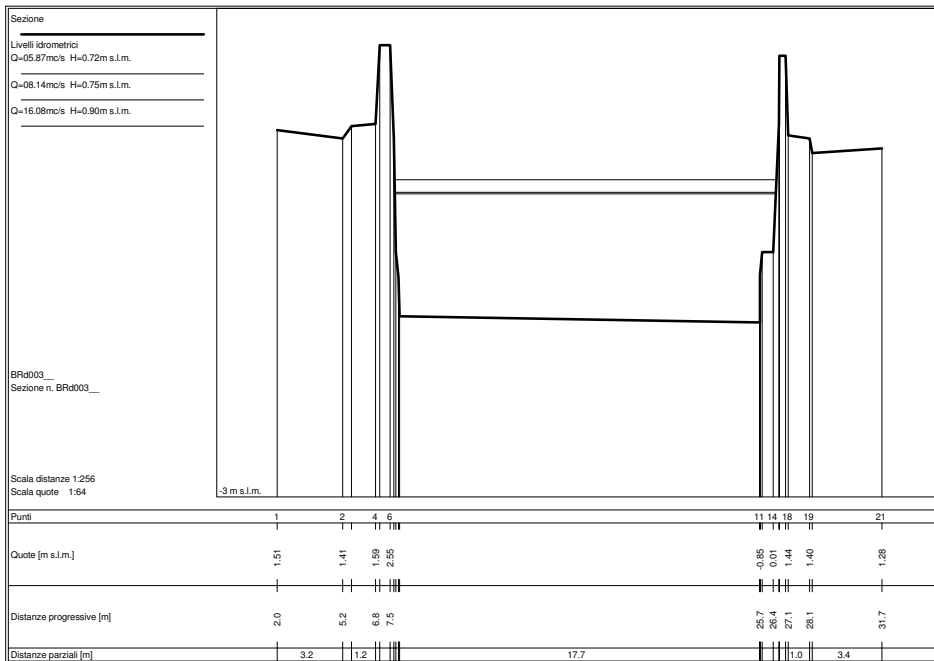
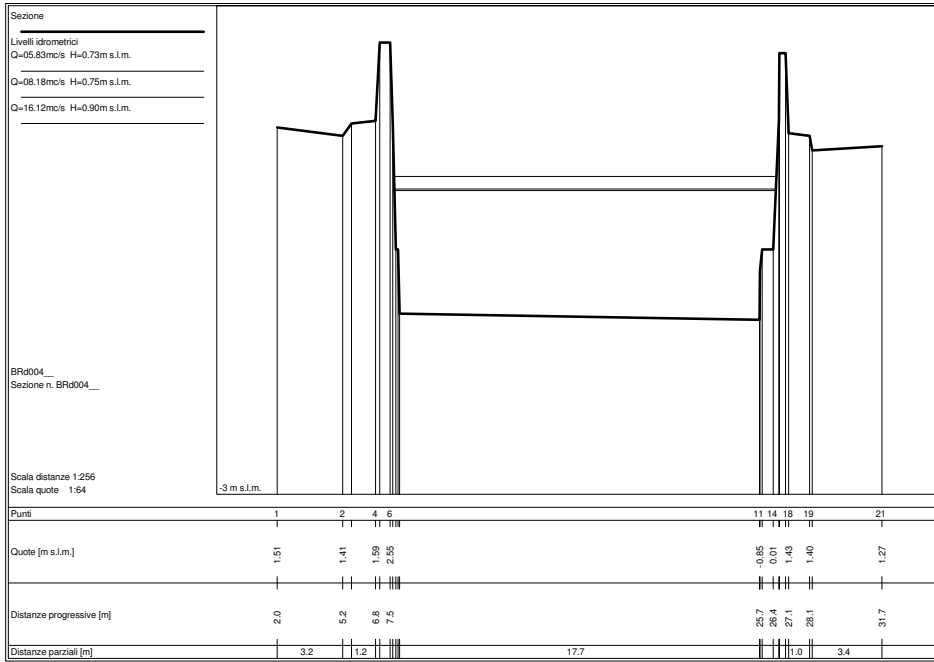

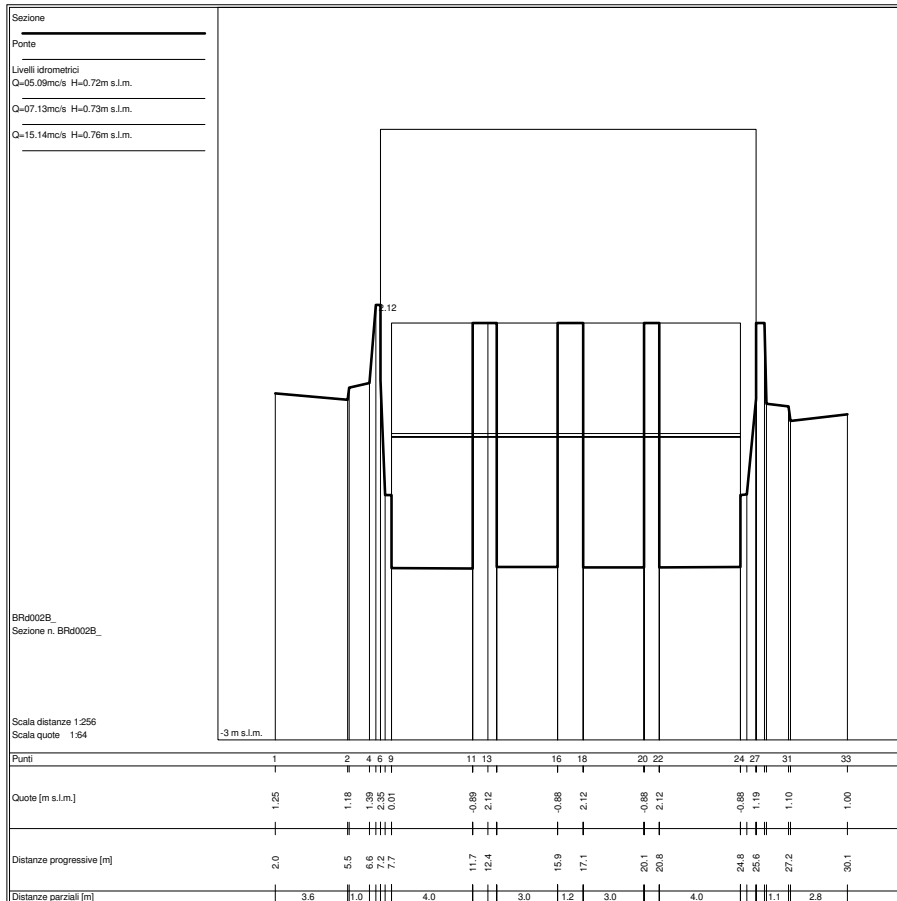
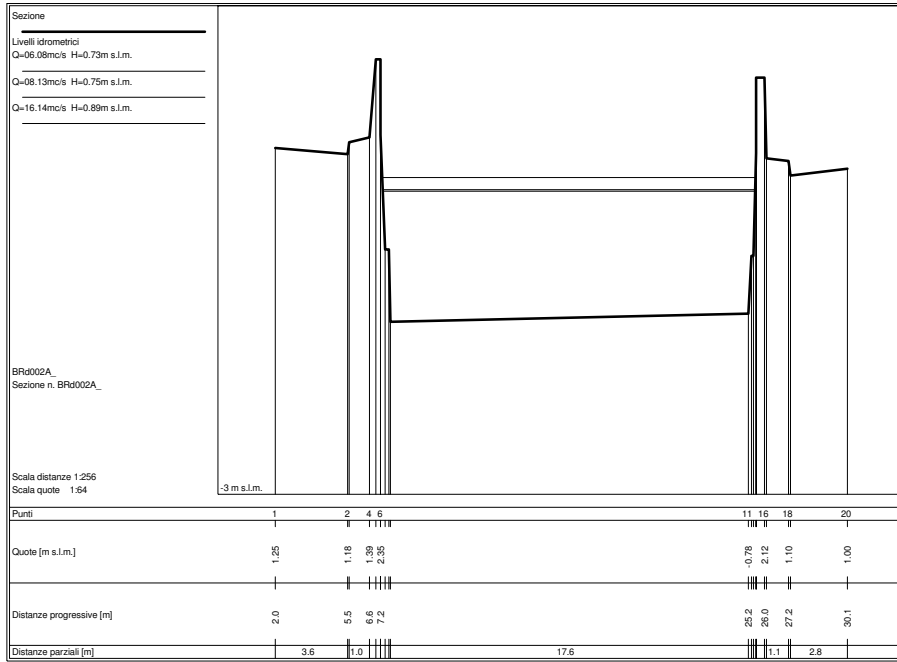

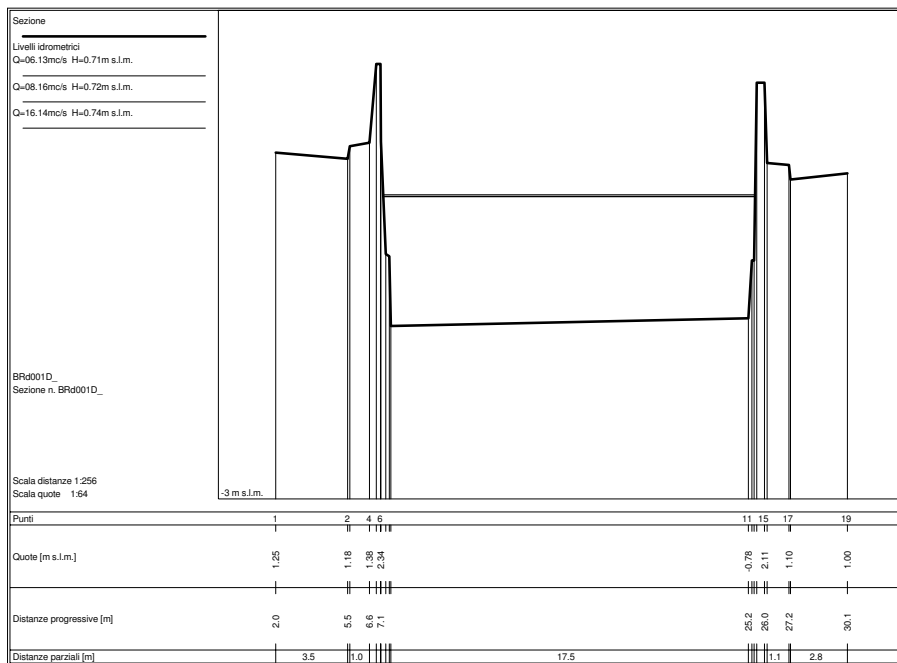
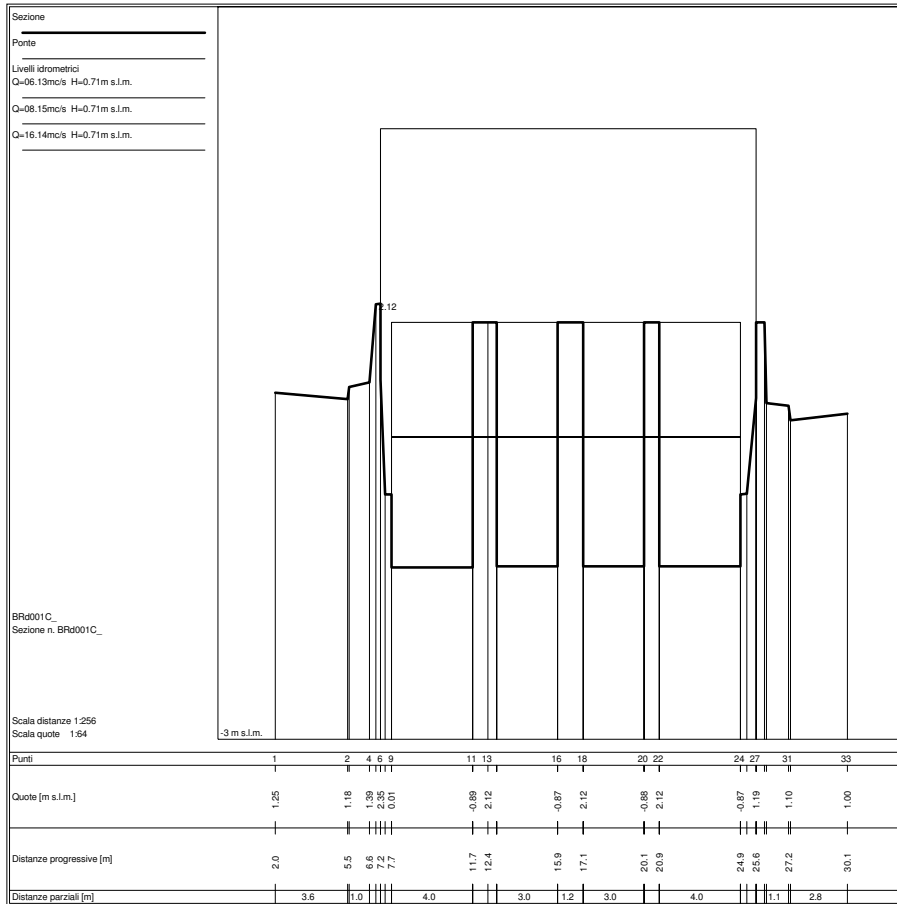

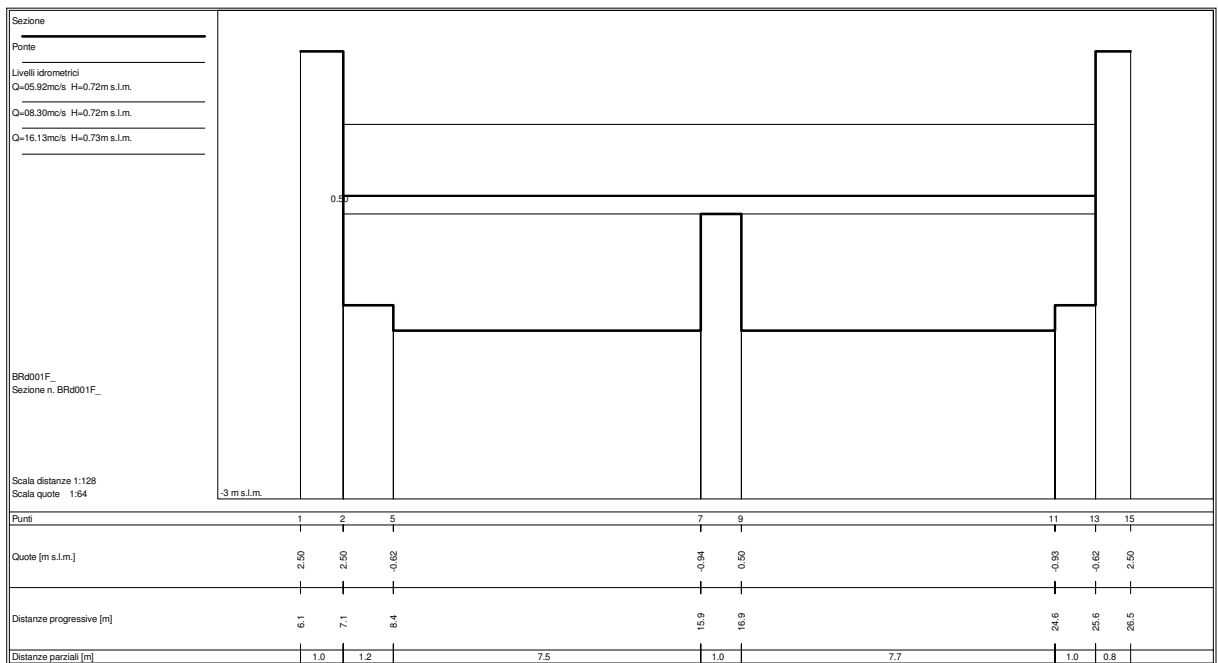
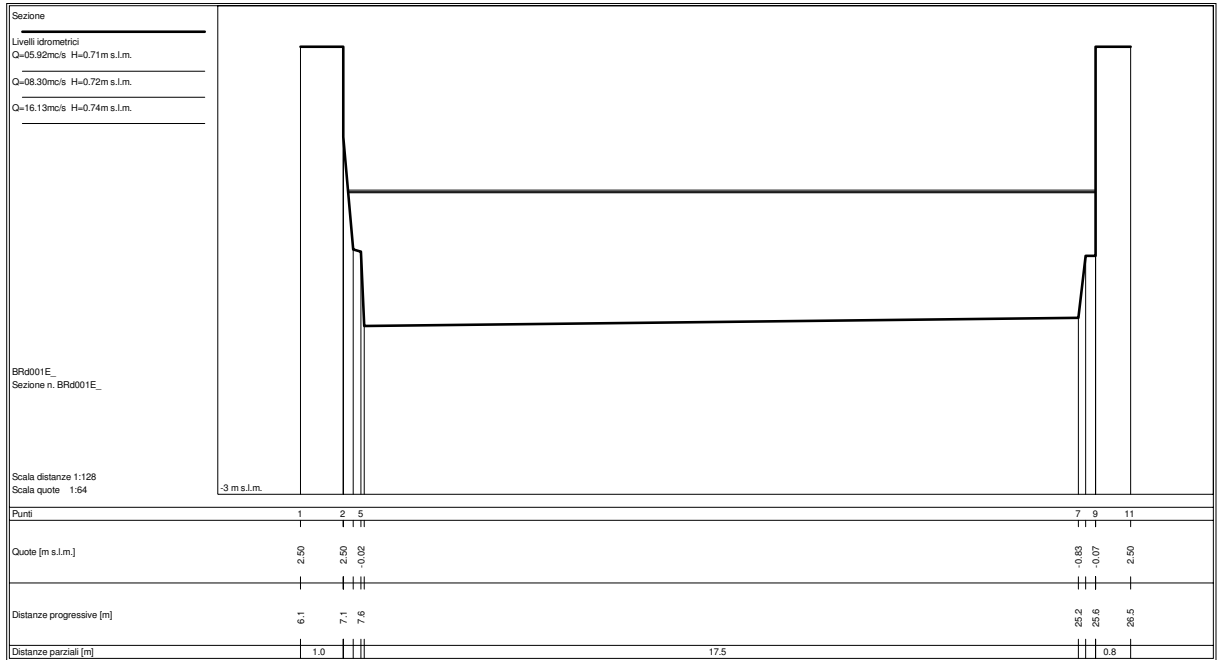

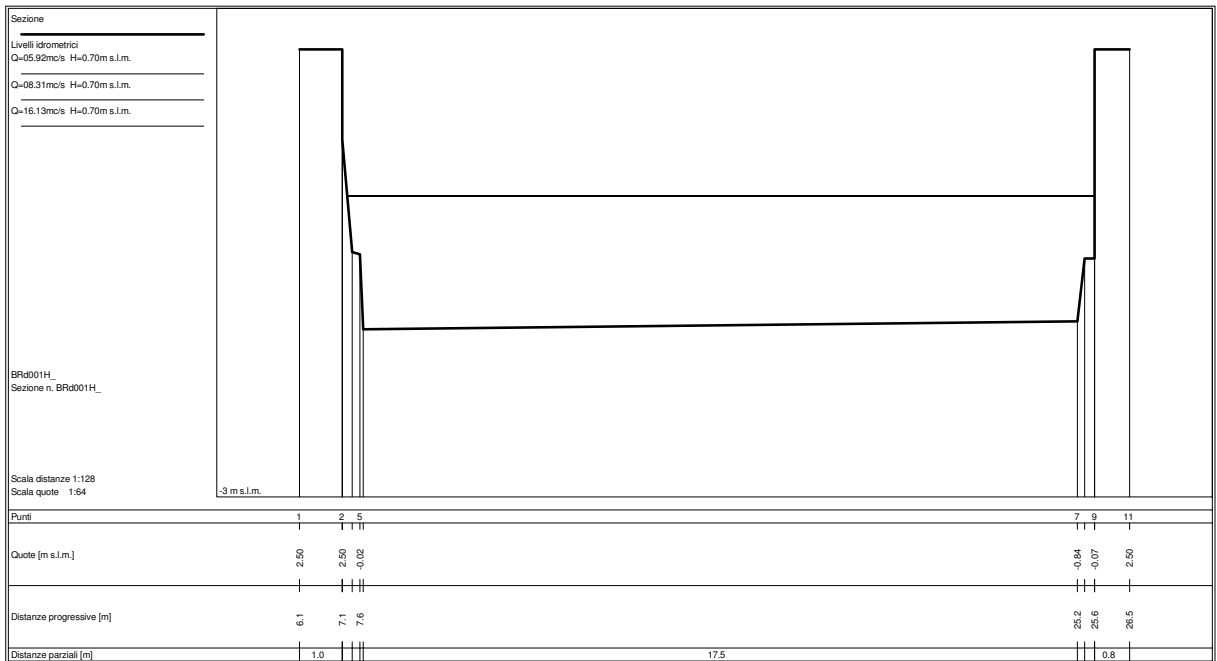
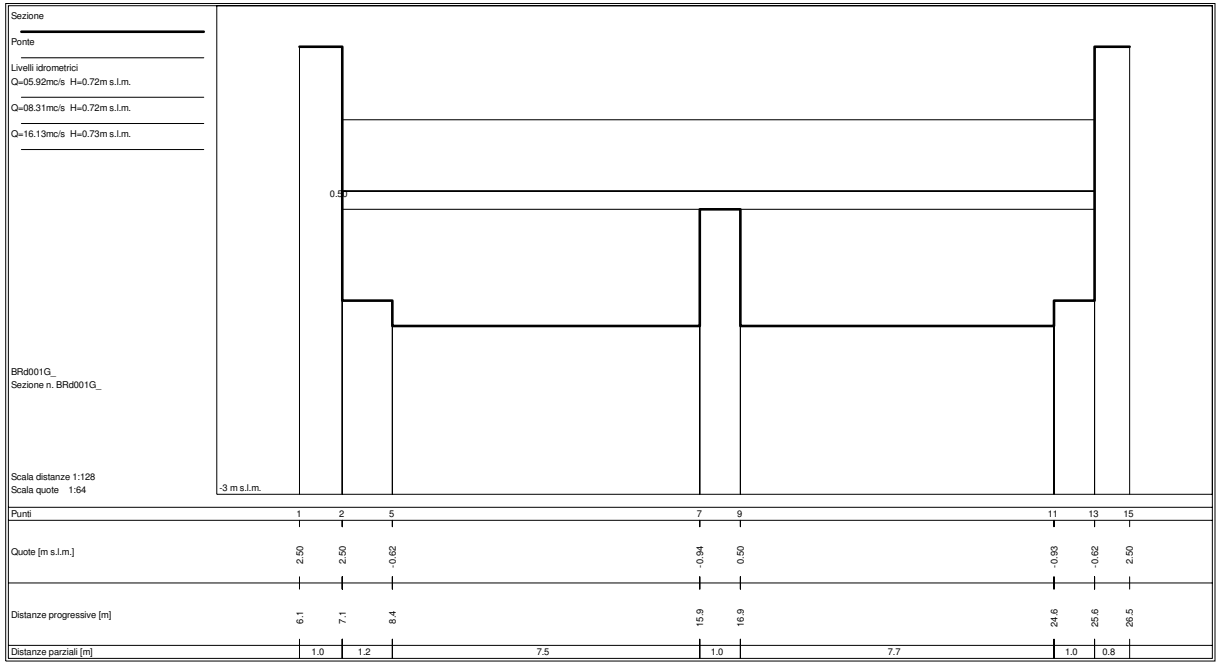

## **FOSSO TORNABUONI**

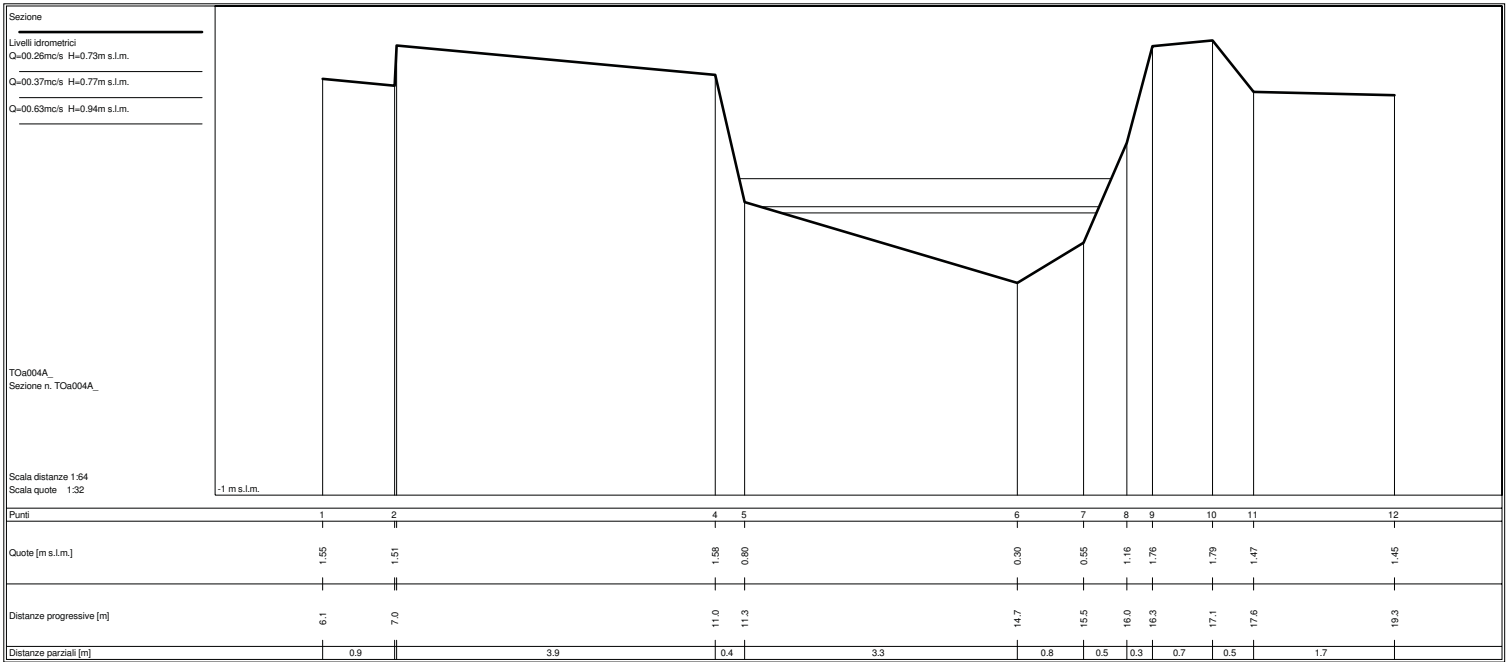
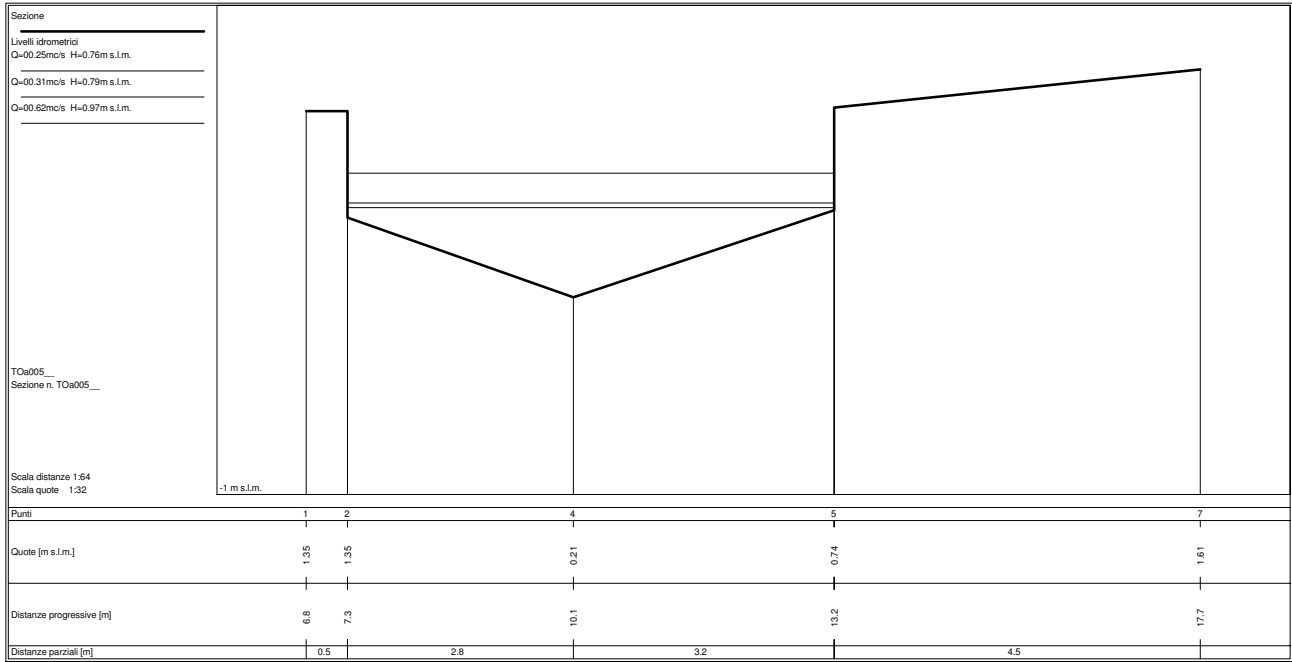

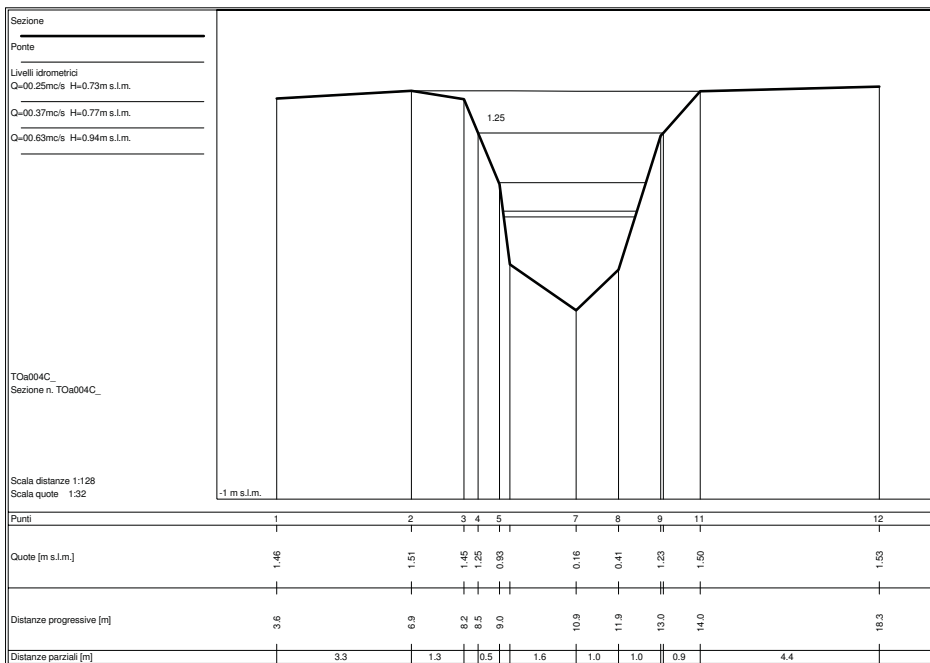
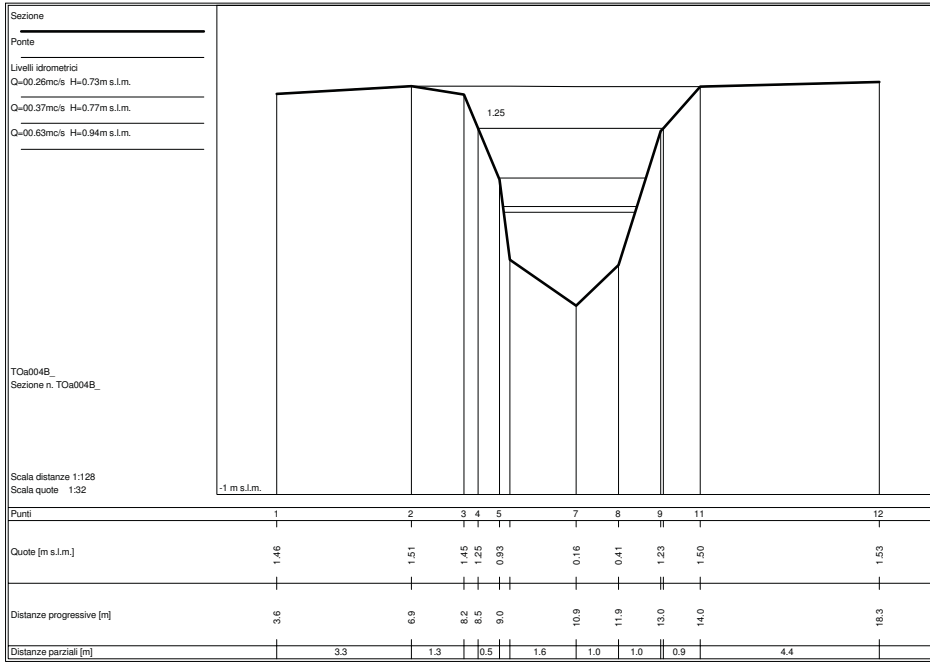



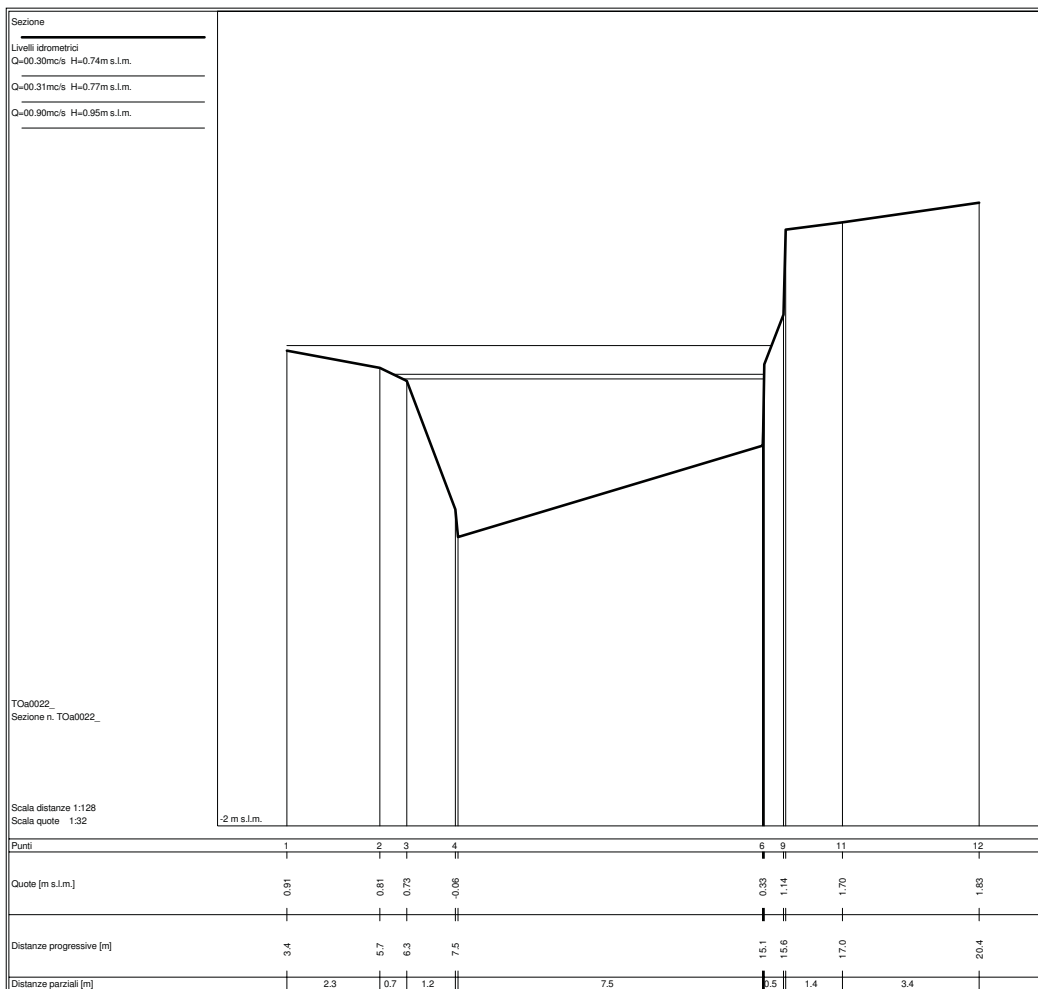
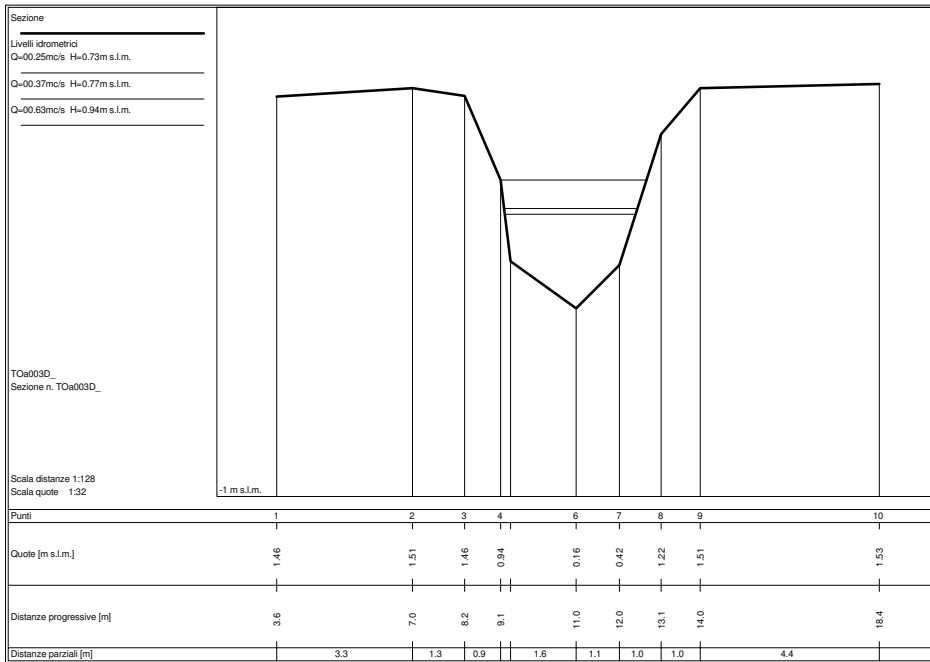

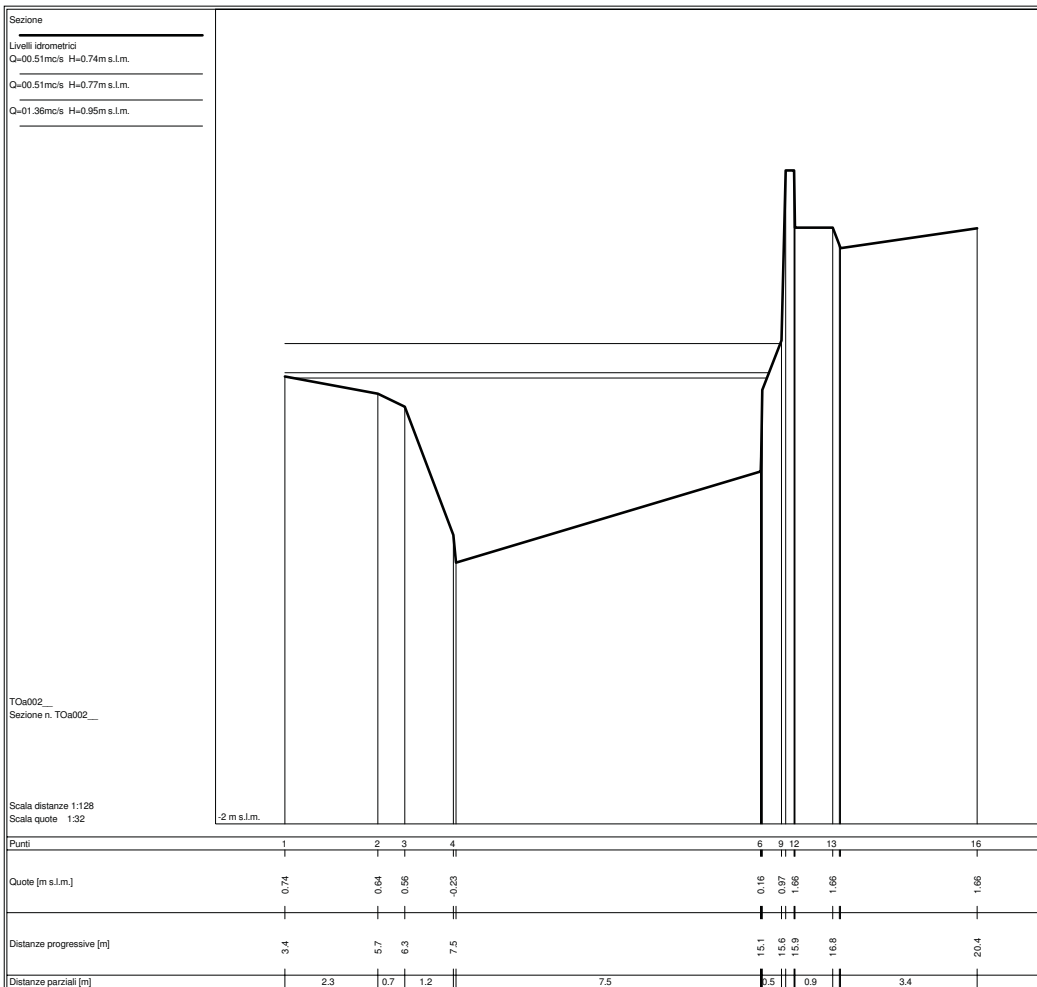
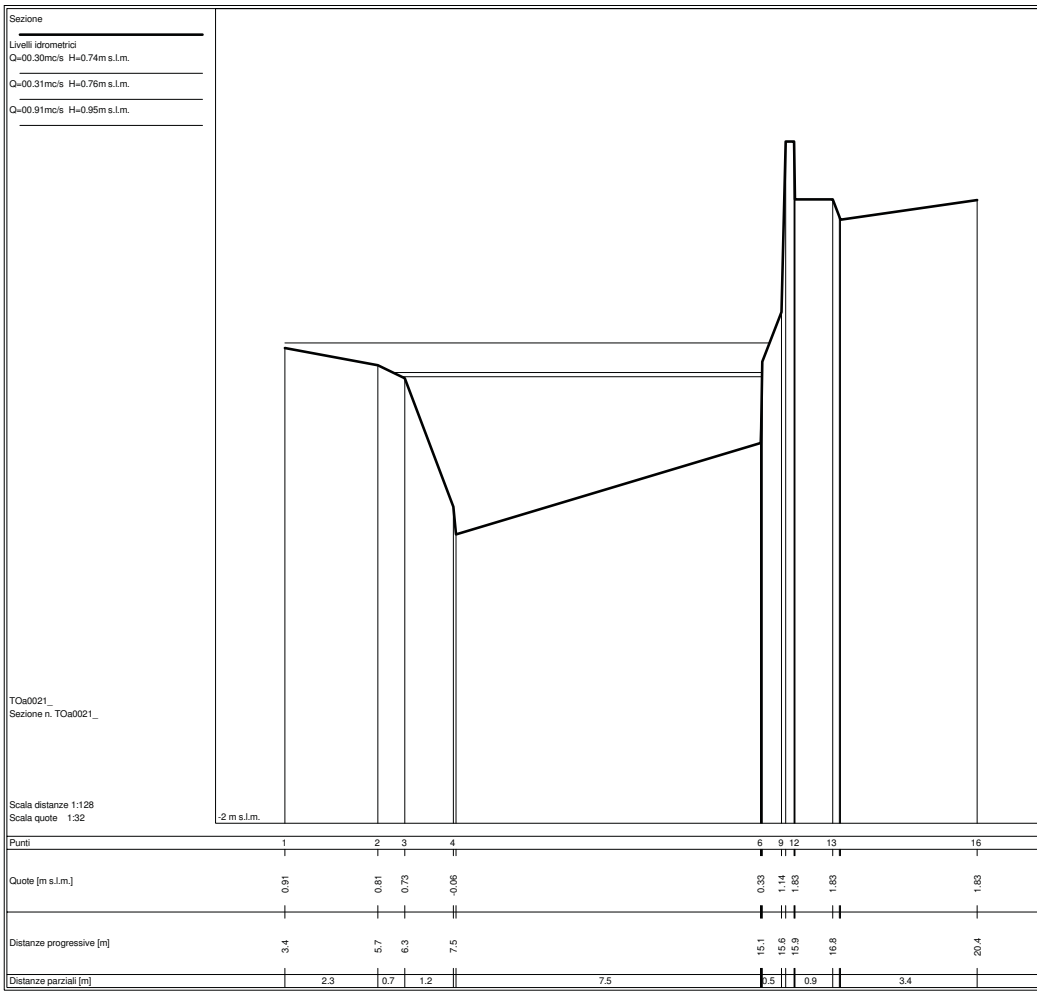

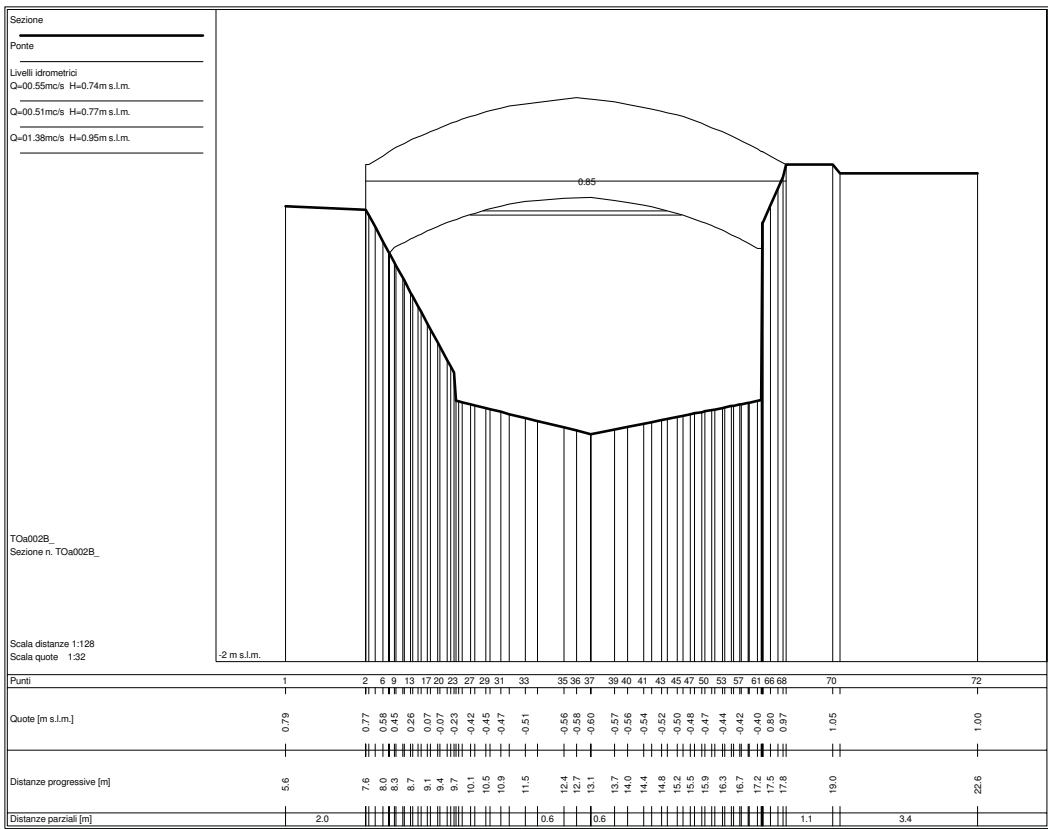
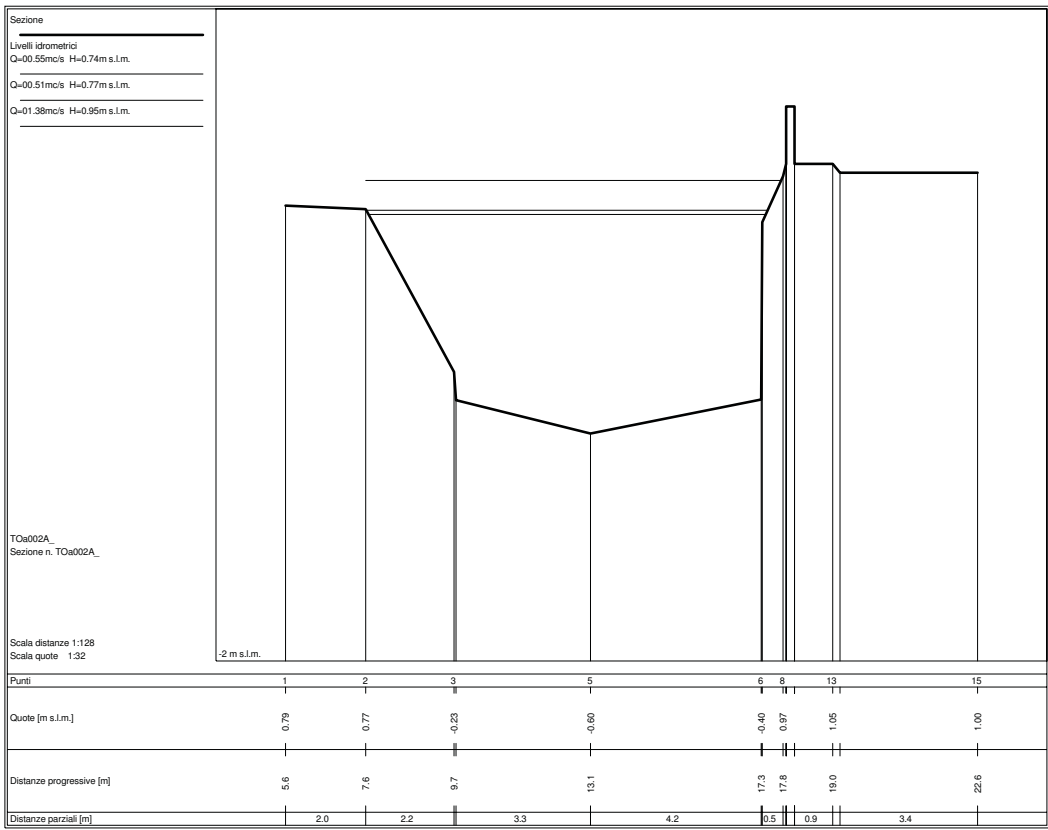

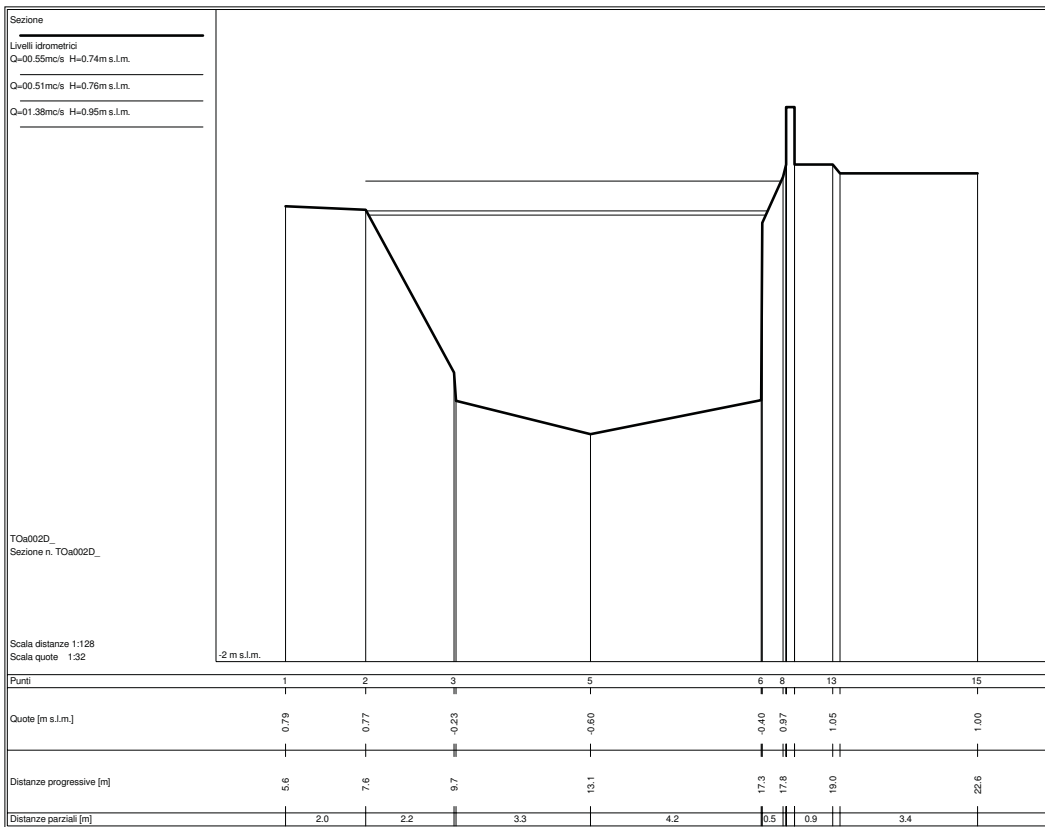
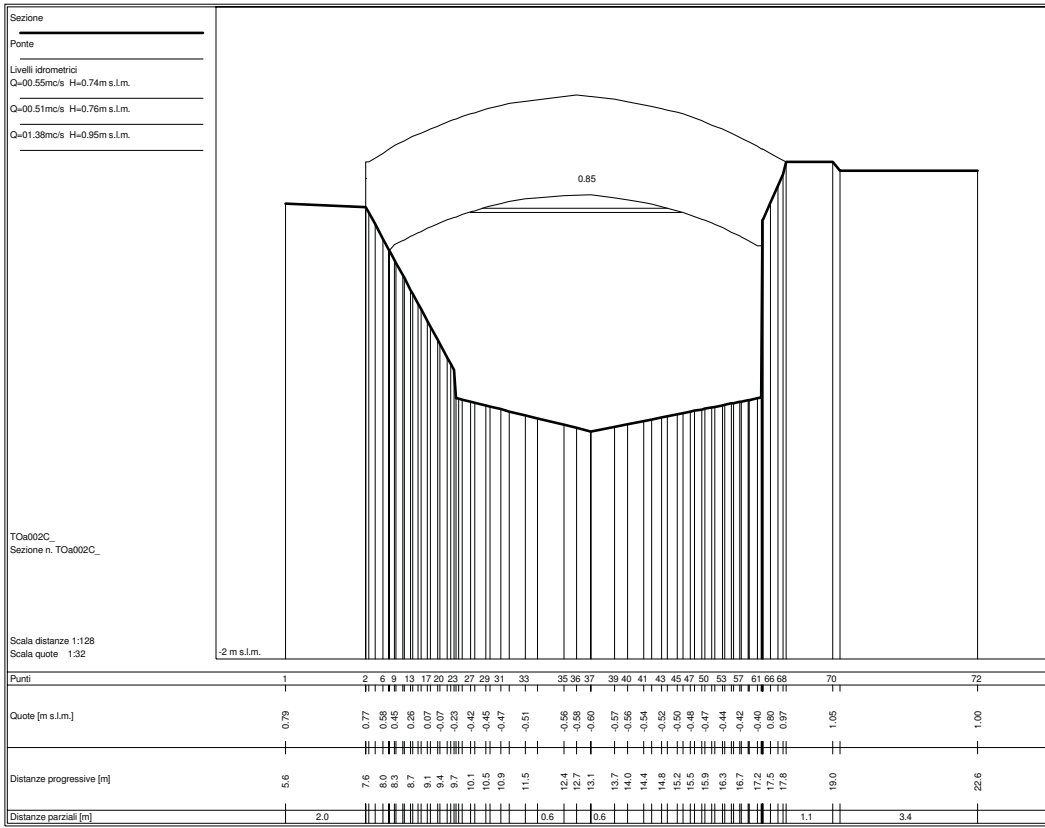

Sezione  
 Livelli idrometrici  
 Q=00.57mc/s H=0.73m s.l.m.  
 Q=00.51mc/s H=0.76m s.l.m.  
 Q=01.39mc/s H=0.95m s.l.m.

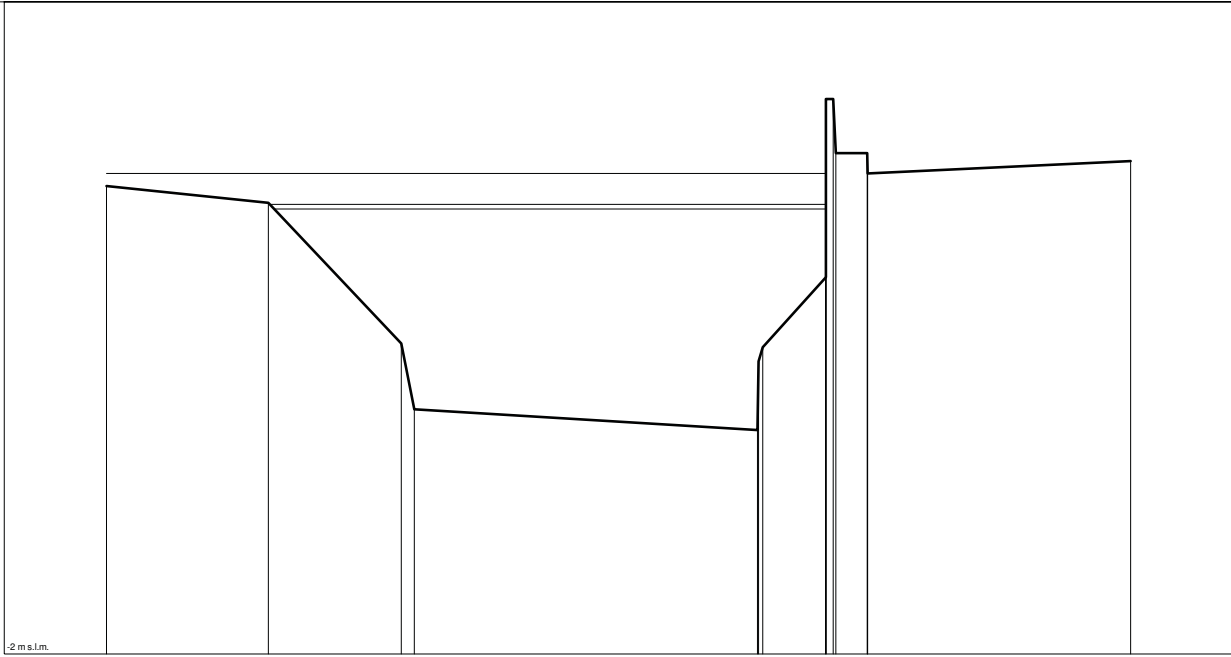

TOa001  
 Sezione n. TOa001\_

Scala distanze 1:128  
 Scala quote 1:32

| Punti                    | 1    | 2    | 3              | 4 | 5     | 8    | 12   | 14   |
|--------------------------|------|------|----------------|---|-------|------|------|------|
| Quote [m s.l.m.]         | 0.87 | 0.77 | -0.10<br>-0.50 |   | -0.63 | 0.31 | 1.07 | 1.02 |
| Distanze progressive [m] | 2.9  | 6.8  | 10.1<br>10.4   |   | 18.9  | 20.5 | 21.5 | 28.0 |
| Distanze parziali [m]    |      | 4.0  | 3.3            |   | 8.4   | 1.6  | 0.8  | 6.4  |